

Oracle® Application Server

Installation Guide

10g Release 3 (10.1.3.1.0) for Linux x86

B31013-01

October 2006

Oracle Application Server Installation Guide 10g Release 3 (10.1.3.1.0) for Linux x86

B31013-01

Copyright © 2006, Oracle. All rights reserved.

Primary Author: Megan Ginter

Contributing Authors: Deborah Steiner, Rodney Ward, Beth Roeser, Kevin Hwang

The Programs (which include both the software and documentation) contain proprietary information; they are provided under a license agreement containing restrictions on use and disclosure and are also protected by copyright, patent, and other intellectual and industrial property laws. Reverse engineering, disassembly, or decompilation of the Programs, except to the extent required to obtain interoperability with other independently created software or as specified by law, is prohibited.

The information contained in this document is subject to change without notice. If you find any problems in the documentation, please report them to us in writing. This document is not warranted to be error-free. Except as may be expressly permitted in your license agreement for these Programs, no part of these Programs may be reproduced or transmitted in any form or by any means, electronic or mechanical, for any purpose.

If the Programs are delivered to the United States Government or anyone licensing or using the Programs on behalf of the United States Government, the following notice is applicable:

U.S. GOVERNMENT RIGHTS Programs, software, databases, and related documentation and technical data delivered to U.S. Government customers are "commercial computer software" or "commercial technical data" pursuant to the applicable Federal Acquisition Regulation and agency-specific supplemental regulations. As such, use, duplication, disclosure, modification, and adaptation of the Programs, including documentation and technical data, shall be subject to the licensing restrictions set forth in the applicable Oracle license agreement, and, to the extent applicable, the additional rights set forth in FAR 52.227-19, Commercial Computer Software—Restricted Rights (June 1987). Oracle USA, Inc., 500 Oracle Parkway, Redwood City, CA 94065

The Programs are not intended for use in any nuclear, aviation, mass transit, medical, or other inherently dangerous applications. It shall be the licensee's responsibility to take all appropriate fail-safe, backup, redundancy and other measures to ensure the safe use of such applications if the Programs are used for such purposes, and we disclaim liability for any damages caused by such use of the Programs.

Oracle, JD Edwards, and PeopleSoft are registered trademarks of Oracle Corporation and/or its affiliates. Other names may be trademarks of their respective owners.

The Programs may provide links to Web sites and access to content, products, and services from third parties. Oracle is not responsible for the availability of, or any content provided on, third-party Web sites. You bear all risks associated with the use of such content. If you choose to purchase any products or services from a third party, the relationship is directly between you and the third party. Oracle is not responsible for: (a) the quality of third-party products or services; or (b) fulfilling any of the terms of the agreement with the third party, including delivery of products or services and warranty obligations related to purchased products or services. Oracle is not responsible for any loss or damage of any sort that you may incur from dealing with any third party.

Contents

Preface	ix
Intended Audience	ix
Documentation Accessibility	ix
Related Documents	x
Conventions	x
1 Product and Installation Overview	
1.1 Product Overview	1-1
1.2 Basic and Advanced Installation	1-1
1.3 Recommended Topologies	1-2
1.3.1 Installing a Standalone OC4J Instance	1-5
1.3.2 Installing an Integrated Web Server and OC4J Middle Tier	1-5
1.3.3 Installing a SOA Administration Instance	1-6
1.3.4 Installing a J2EE Server with the SOA Suite	1-6
1.3.5 Installing J2EE Server, Web Server, and the SOA Suite	1-7
1.3.6 Installing J2EE Server and the SOA Suite with a Remote Oracle HTTP Server	1-8
1.3.7 Installing J2EE Server and Separate SOA Applications with a Remote Oracle HTTP Server	1-11
1.3.8 Installing Multiple SOA Middle Tiers with a Remote Oracle HTTP Server	1-14
2 Requirements	
2.1 Using Oracle <i>MetaLink</i> to Obtain the Latest Oracle Application Server Hardware and Software Requirements	2-2
2.2 System Requirements	2-2
2.2.1 Installing from the Console or X Windows	2-4
2.3 Software Requirements	2-4
2.3.1 Software Requirements for Red Hat Enterprise Linux AS/ES 3.0 Systems	2-5
2.3.2 Software Requirements for Red Hat Enterprise Linux AS/ES 4.0 Systems	2-7
2.3.3 Software Requirements for SUSE Linux Enterprise Server 9 Systems	2-10
2.4 Set Shell Limits for the oracle User	2-13
2.5 Ports	2-14
2.5.1 Checking If a Port Is in Use	2-14
2.5.2 Using Default Port Numbers	2-14
2.5.3 Using Custom Port Numbers (the "Static Ports" Feature)	2-15
2.5.3.1 Format of the staticports.ini File	2-15

2.5.3.2	Error Conditions that Will Cause the Installer to Use Default Ports Instead of Specified Ports.....	2-16
2.5.3.3	Ports for Oracle HTTP Server	2-17
2.5.3.3.1	staticports.ini Example	2-17
2.6	Operating System Groups	2-18
2.6.1	Create a Group for the Inventory Directory	2-18
2.7	Operating System User	2-18
2.8	Requirements for the Database	2-19
2.9	Installing Database Schemas	2-20
2.10	Environment Variables	2-20
2.10.1	Environment Variable Tips	2-21
2.10.2	PATH, CLASSPATH, and LD_LIBRARY_PATH	2-21
2.10.3	DISPLAY	2-21
2.10.4	TNS_ADMIN.....	2-22
2.10.5	TMP and TMPDIR.....	2-22
2.10.6	ANT_HOME.....	2-23
2.10.7	ORA_NLS	2-23
2.10.8	LD_BIND_NOW	2-23
2.11	Network Topics.....	2-23
2.11.1	Installing on a DHCP Host.....	2-23
2.11.2	Installing on Multihomed (Multi-IP) Computers	2-24
2.11.3	Copying CD-ROMs or DVD-ROM to Hard Drive, and Installing from the Hard Drive	2-24
2.11.4	Installing from a Remote CD-ROM or DVD-ROM Drive.....	2-25
2.11.5	Installing on Remote Computers.....	2-26
2.11.6	Installing on NFS-Mounted Storage	2-27
2.11.7	Running Multiple Instances from One Installation	2-27
2.11.8	Support for NIS and NIS+	2-27
2.12	Prerequisite Checks Performed by the Installer	2-28

3 Things You Should Know Before Starting the Installation

3.1	Oracle Home Directory	3-1
3.1.1	Naming Your Oracle Home	3-1
3.1.2	Installing in an Existing Oracle Home.....	3-2
3.1.3	Installing in a Non-Empty Oracle Home	3-2
3.2	First-Time Installation of Any Oracle Product	3-2
3.3	Installing Additional Languages	3-2
3.4	Oracle Application Server Instances and Instance Names	3-3
3.5	The oc4jadmin User and Restrictions on its Password.....	3-4
3.6	Where Does the Installer Write Files?	3-5
3.7	Why Do I Need to be Able to Log In as Root at Certain Times During Installation?	3-5
3.8	Running root.sh During Installation.....	3-5
3.9	Rules for Adding Instances to OracleAS Clusters.....	3-6
3.10	Obtaining Software from Oracle E-Delivery.....	3-6
3.10.1	Finding and Downloading the Oracle Application Server 10g Release 3 (10.1.3.1.0) E-Pack	3-6
3.10.2	Finding Required and Optional Downloads	3-6

3.10.3	Disk Space Requirements	3-6
3.10.4	Software Requirements for Unzipping Files	3-6
3.10.5	Extracting Software from the Zip Files.....	3-7
3.11	Setting the Mount Point for the CD-ROM or DVD-ROM.....	3-7
3.12	Starting the Oracle Universal Installer.....	3-8

4 Basic Installation

4.1	What Components Are Installed?	4-1
4.2	Basic Installation Steps	4-1
4.2.1	Before You Begin.....	4-2
4.2.2	Installation Steps.....	4-2
4.3	What Should I Do Next?	4-5

5 Advanced Installation

5.1	What Components Are Installed?	5-1
5.1.1	J2EE Server, Web Server and SOA Suite	5-1
5.1.2	J2EE Server and Web Server	5-2
5.1.3	J2EE Server.....	5-2
5.1.4	Web Server.....	5-2
5.2	Advanced Installation Steps.....	5-2
5.2.1	Before You Begin.....	5-3
5.2.2	Installing J2EE Server, Web Server and SOA Suite	5-3
5.2.3	Installing J2EE Server and Web Server.....	5-4
5.2.4	Installing J2EE Server	5-5
5.2.5	Installing Web Server	5-6
5.3	Installation Screens	5-7
5.3.1	Oracle Application Server SOA Suite 10.1.3.1.0 Installation Screen	5-8
5.3.2	Select Installation Type Screen	5-9
5.3.3	Specify Database Connect Information Screen.....	5-10
5.3.4	Specify Database Schema Passwords Screen.....	5-11
5.3.5	Specify Port Configuration Options Screen	5-12
5.3.6	Administration Settings Screen	5-12
5.3.7	Specify Instance Name Screen	5-14
5.3.8	Cluster Topology Configuration Screen - J2EE Server, Web Server, and SOA Suite Installation	5-15
5.3.9	Cluster Topology Configuration Screen - J2EE Server and Web Server Installation	5-16
5.3.10	Cluster Topology Configuration Screen - J2EE Server Installation.....	5-18
5.3.11	Cluster Topology Configuration Screen - Web Server Installation.....	5-19
5.3.12	Summary Screen	5-21
5.3.13	Install Screen.....	5-21
5.3.14	Configuration Assistants Screen.....	5-22
5.3.15	End of Installation Screen.....	5-24
5.4	Troubleshooting Information.....	5-24
5.5	What Should I Do Next?	5-25

6 Installing in High Availability Environments

6.1	Overview of High Availability Configurations.....	6-1
6.1.1	Active-Active Topologies: OracleAS Clusters.....	6-1
6.1.2	Active-Passive Topologies: OracleAS Cold Failover Clusters.....	6-2
6.1.3	OracleAS Disaster Recovery.....	6-3
6.1.4	Summary of Differences.....	6-3
6.2	Requirements for High Availability Configurations.....	6-4
6.2.1	Check Minimum Number of Nodes.....	6-4
6.2.2	Check That Groups Are Defined Identically on All Nodes.....	6-4
6.2.3	Check the Properties of the oracle User.....	6-4
6.2.4	Check for Previous Oracle Installations on All Nodes.....	6-5
6.3	Creating the Active-Active Topology.....	6-5
6.3.1	Active-Active Topologies: Introduction.....	6-6
6.3.2	OracleAS Clusters in Active-Active Topologies.....	6-7
6.3.3	Properties of Oracle Application Server Instances in Active-Active Topologies.....	6-8
6.3.4	Installation Steps for Active-Active Topologies.....	6-8
6.3.5	Supporting Procedures for Creating the Active-Active Topology.....	6-12
6.3.5.1	Setting up Clusters with the Discovery Server Method.....	6-13
6.3.5.2	Setting up Multicast Replication.....	6-13
6.3.5.3	Setting up Peer-to-Peer Replication.....	6-14
6.3.5.4	Setting up Replication to a Database.....	6-16
6.3.5.5	Setting the Replication Policy.....	6-16
6.3.5.6	Specifying the Number of Nodes to Replicate To.....	6-18
6.4	Creating the Active-Passive Topology.....	6-18
6.4.1	Active-Passive Topologies: Introduction.....	6-18
6.4.2	Overview of Installation Steps for OracleAS Cold Failover Cluster.....	6-20
6.4.3	Preinstallation Steps for OracleAS Cold Failover Cluster.....	6-21
6.4.3.1	Map the Virtual Hostname and Virtual IP Address.....	6-21
6.4.3.2	Set Up a File System That Can Be Mounted from Both Nodes.....	6-23
6.4.4	OracleAS Cold Failover Cluster: Details of Installation Steps.....	6-24
6.5	Creating an OracleAS Disaster Recovery Configuration.....	6-25
6.5.1	OracleAS Disaster Recovery: Introduction.....	6-26
6.5.2	Setting up the OracleAS Disaster Recovery Environment.....	6-27
6.5.2.1	Ensure Nodes Are Identical at the Operating System Level.....	6-27
6.5.2.2	Set Up staticports.ini File.....	6-28
6.5.2.3	Set Up Identical Hostnames on Both Production and Standby Sites.....	6-28
6.5.2.4	If You Want to Use OracleAS Cold Failover Cluster on the Production Site (OracleAS 10.1.2.n.n only).....	6-32
6.5.3	Installing Oracle Application Server in an OracleAS Disaster Recovery Environment.....	6-33
6.5.3.1	Installing the OracleAS Infrastructure (OracleAS Release 10.1.2.n.n Only)....	6-34
6.5.3.2	Installing Middle Tiers (OracleAS Release 10.1.3.1.0 and 10.1.2.n.n).....	6-34
6.5.4	Installing the OracleAS 10g (10.1.3.1.0) Standalone Install of OracleAS Guard into Oracle Homes.....	6-35
6.5.5	Patching OracleAS Guard Release 10.1.2.n.n with Release 10.1.3.1.0.....	6-36
6.5.6	What to Read Next.....	6-36

7 Postinstallation Tasks

7.1	State of Oracle Application Server Instances After Installation.....	7-1
7.2	Passwords for Oracle Application Server Components.....	7-1
7.3	NFS Installations	7-2
7.4	Configuring OracleAS Clusters	7-2
7.5	Backup and Recovery	7-2
7.6	SSL.....	7-2
7.7	Operating System Locale and NLS_LANG Environment Variable	7-2
7.7.1	Check the Operating System Locale	7-2
7.7.2	Check the NLS_LANG Setting	7-2
7.8	Proxy Settings	7-3
7.9	What to Do Next	7-3

A Silent and Non-Interactive Installation

A.1	Silent Installation.....	A-1
A.2	Non-Interactive Installation	A-1
A.3	Preinstallation.....	A-2
A.4	Create the Response File	A-2
A.4.1	Creating Response Files from Templates.....	A-3
A.4.2	Creating Response Files by Using the Record Mode in the Installer	A-3
A.4.3	Example Response Files.....	A-4
A.4.3.1	Example Response File for Basic Installation: J2EE Server and SOA Suite	A-4
A.4.3.2	Example Response File for Advanced Installation: J2EE Server, Web Server and SOA Suite.....	A-5
A.4.3.3	Example Response File for Advanced Installation: J2EE Server and Web Server.....	A-7
A.4.3.4	Example Response File for Advanced Installation: J2EE Server	A-8
A.4.3.5	Example Response File for Advanced Installation: Web Server	A-10
A.5	Start the Installation.....	A-11
A.6	Postinstallation	A-12
A.7	Security Tips for Silent and Non-Interactive Installations.....	A-12
A.8	Deinstallation.....	A-12

B Default Port Numbers

B.1	Method of Assigning Default Port Numbers.....	B-1
B.2	Default Port Numbers	B-1
B.3	Ports to Open in Firewalls	B-2

C Deinstallation and Reinstallation

C.1	Deinstallation Procedure: Overview.....	C-1
C.2	Deinstalling Procedure.....	C-2
C.3	Cleaning Up Oracle Application Server Processes	C-2
C.4	Reinstallation	C-2

D Configuration Assistants

D.1	Troubleshooting Configuration Assistants	D-1
D.1.1	General Tips.....	D-1
D.1.2	Configuration Assistant Result Codes.....	D-2
D.2	Description of Oracle Application Server Configuration Assistants	D-2

E Troubleshooting

E.1	Log Files	E-1
E.2	General Troubleshooting Tips	E-1
E.3	Installation Problems and Solutions	E-2
E.3.1	Location of Log Files	E-2
E.3.2	Linking Failed, ORA Errors	E-2
E.3.3	Prerequisite Checks Fail at the Start of Installation	E-3
E.3.4	Installer Disappears After Running the Preinstallation Checks	E-3
E.3.5	Unable to Clean Up a Failed Installation	E-3
E.3.6	User Interface Does Not Display in the Desired Language, or Does Not Display Properly	E-3
E.3.7	Configuration Assistant Failures - General	E-4
E.4	Need More Help?	E-4

Index

Preface

The *Oracle Application Server Installation Guide* covers requirements, new features in the Oracle Universal Installer, Oracle Application Server concepts that affect installation, installation procedures, and troubleshooting tips. In addition, this guide also provides some sample topologies for installing and running Oracle Application Server.

Intended Audience

This guide is intended for users who are comfortable running some system administration operations, such as creating users and groups, adding users to groups, and installing operating system patches on the computer where Oracle Application Server is going to be installed. Users who are installing Oracle Application Server need root access to run some scripts.

Documentation Accessibility

Our goal is to make Oracle products, services, and supporting documentation accessible, with good usability, to the disabled community. To that end, our documentation includes features that make information available to users of assistive technology. This documentation is available in HTML format, and contains markup to facilitate access by the disabled community. Accessibility standards will continue to evolve over time, and Oracle is actively engaged with other market-leading technology vendors to address technical obstacles so that our documentation can be accessible to all of our customers. For more information, visit the Oracle Accessibility Program Web site at

<http://www.oracle.com/accessibility/>

Accessibility of Code Examples in Documentation

Screen readers may not always correctly read the code examples in this document. The conventions for writing code require that closing braces should appear on an otherwise empty line; however, some screen readers may not always read a line of text that consists solely of a bracket or brace.

Accessibility of Links to External Web Sites in Documentation

This documentation may contain links to Web sites of other companies or organizations that Oracle does not own or control. Oracle neither evaluates nor makes any representations regarding the accessibility of these Web sites.

TTY Access to Oracle Support Services

Oracle provides dedicated Text Telephone (TTY) access to Oracle Support Services within the United States of America 24 hours a day, seven days a week. For TTY support, call 800.446.2398.

Related Documents

For additional information, see the following manuals:

- *Oracle Application Server Administrator's Guide*
- *Oracle Application Server Concepts*
- *Oracle Application Server High Availability Guide*

Conventions

The following text conventions are used in this document:

Convention	Meaning
boldface	Boldface type indicates graphical user interface elements associated with an action, or terms defined in text or the glossary.
<i>italic</i>	Italic type indicates book titles, emphasis, or placeholder variables for which you supply particular values.
monospace	Monospace type indicates commands within a paragraph, URLs, code in examples, text that appears on the screen, or text that you enter.

Product and Installation Overview

This chapter describes what is contained in Oracle Application Server and recommended topologies. It contains the following sections:

- [Section 1.1, "Product Overview"](#)
- [Section 1.2, "Basic and Advanced Installation"](#)
- [Section 1.3, "Recommended Topologies"](#)

1.1 Product Overview

Oracle Application Server 10g Release 3 (10.1.3.1.0) provides the Oracle SOA Suite, which is a complete set of service infrastructure components for creating, deploying, and managing Service Oriented Architectures. Oracle SOA Suite enables services to be created, managed, and orchestrated into composite applications and business processes.

Oracle SOA Suite consists of:

- Oracle BPEL Process Manager
- Oracle Enterprise Service Bus (ESB)
- Oracle Web Services Manager (OWSM)
- Oracle Business Rules
- Oracle Application Server (includes Oracle HTTP Server, Oracle Containers for J2EE (OC4J or J2EE Server), Oracle Enterprise Manager 10g Application Server Control, Oracle Process Manager and Notification Server and OC4J Java Single Sign-On)

You can integrate Oracle Application Server 10g Release 3 (10.1.3.1.0) with an existing Oracle Application Server environment that includes 10g Release 2 (10.1.2) or 10g (10.1.4.0.1) OracleAS Infrastructure.

See Also: *Oracle Application Server Upgrade Guide* for more information about which specific versions are compatible with 10g Release 3 (10.1.3.1.0).

1.2 Basic and Advanced Installation

[Table 1-1](#) summarizes the groups of services available with each installation type.

Table 1–1 Oracle Application Server 10g Release 3 (10.1.3.1.0) Install Types

Install Mode	Available Installation Types
Basic	<ul style="list-style-type: none"> ■ J2EE Server and SOA Suite
Advanced	<ul style="list-style-type: none"> ■ J2EE Server, Web Server, and SOA Suite ■ J2EE Server and Web Server ■ J2EE Server ■ Web Server

The basic (one-click) installation prompts you with questions on the initial installation screen, and then it proceeds to install the product without any further user interaction. The default values for all the components are used.

The advanced installation provides you with a great degree of customization and flexibility, which enables installation of additional languages, port configuration options, and cluster configuration.

[Table 1–2](#) summarizes the differences in the customization options between basic and advanced installation.

Table 1–2 Basic and Advanced Installation Features

Action or Option	Basic	Advanced
Specify an Oracle Home	Yes	Yes
Specify an Oracle Application Server instance name and <code>oc4jadmin</code> password	Yes	Yes
Install an Oracle Olite Database (Windows only)	Yes	No
Specify an Oracle Database	No (Windows) Yes (Other operating systems)	Yes
Specify a Real Applications Cluster Database	No	Yes
Select additional languages	No	Yes
Specify administration settings	No	Yes
Specify automatic or manual port configuration	No	Yes
Configure Application Server Control	Automatically configured	Select whether or not it is configured
Specify default OC4J instance name	No	Yes
Configure instance to be part of a cluster	No	Yes
OC4J Java Single Sign-On is deployed	Yes	Yes
OC4J Java Single Sign-On is configured and started	Yes	No
Configuration assistants	Yes	Yes

1.3 Recommended Topologies

[Table 1–3](#) provides a road map of where to find information about the supported 10g Release 3 (10.1.3.1.0) topologies.

Table 1–3 Basic and Advanced Installation Features

Topology	See This Documentation for Details
10.1.3.1.0 Middle-Tier Topologies	
A middle tier containing a single OC4J instance in one Oracle home.	Section 1.3.1, "Installing a Standalone OC4J Instance"
A middle tier containing an integrated OC4J instance with Oracle HTTP Server in one Oracle home. Application Server Control is not deployed on this middle tier.	Section 1.3.2, "Installing an Integrated Web Server and OC4J Middle Tier"
A middle tier containing an integrated OC4J instance with Oracle HTTP Server in one Oracle home. Application Server Control is deployed on this middle tier. This topology is suitable for administration the SOA suite.	Section 1.3.3, "Installing a SOA Administration Instance"
A middle tier containing a single OC4J instance with the SOA applications deployed in one Oracle home.	Section 1.3.4, "Installing a J2EE Server with the SOA Suite"
A middle tier containing a two OC4J instances and Oracle HTTP Server with the SOA applications deployed in one Oracle home. One OC4J instance contains the SOA applications and the other OC4J instance contains Application Server Control and Java SSO.	Section 1.3.5, "Installing J2EE Server, Web Server, and the SOA Suite"
Two middle tiers, one containing Oracle HTTP Server and one containing two OC4J instances. One OC4J instance contains the SOA applications and the other OC4J instance contains Application Server Control and Java SSO.	Section 1.3.6, "Installing J2EE Server and the SOA Suite with a Remote Oracle HTTP Server"
Two middle tiers, one containing Oracle HTTP Server and one containing four OC4J instances. One OC4J instance contains ESB, one contains BPEL, one contains OWSM, and one contains Application Server Control and Java SSO.	Section 1.3.7, "Installing J2EE Server and Separate SOA Applications with a Remote Oracle HTTP Server"
Three middle tiers, one containing Oracle HTTP Server, one containing one OC4J instances with the SOA applications, and another containing two OC4J instances with the SOA applications, Application Server Control and Java SSO deployed.	Section 1.3.8, "Installing Multiple SOA Middle Tiers with a Remote Oracle HTTP Server"
An enterprise data center for SOA applications that uses one of the following methods for user authentication: <ul style="list-style-type: none"> ■ Java Single Sign-On and Oracle Internet Directory ■ Oracle Single Sign-On ■ Oracle Access Manager 	<i>"mySOACompany," in the Oracle Application Server Enterprise Deployment Guide</i>
Each of these topologies contains a web tier, an application tier, and a data tier. The three tiers are separated by firewalls.	
High-Availability Topologies	
An OracleAS Clusters configuration in which two or more middle-tier instances serve the same content. A load balancer distributes requests equally among the active instances.	Section 6.3, "Creating the Active-Active Topology"
An Oracle Application Server Cold Failover Clusters configuration in which two or more middle-tier instances serve the same content, but only instance is active at any one time.	Section 6.4, "Creating the Active-Passive Topology"
An OracleAS Disaster Recovery configuration in which a standby site mirrors a production site. During normal operation, the production site handles all the requests. If the production site goes down, the standby site takes over and handles all the requests.	Section 6.5, "Creating an OracleAS Disaster Recovery Configuration"

Table 1–3 (Cont.) Basic and Advanced Installation Features

Topology	See This Documentation for Details
High availability solutions for Oracle SOA Suite components, including BPEL, ESB, BAM, and OWSM.	"High Availability for Oracle SOA Suite" in the <i>Oracle Application Server High Availability Guide</i>
10.1.3.1.0 Middle Tiers with Existing 9.0.4 or 10.1.2 Environments	
10.1.2 Oracle HTTP Server: Two middle tiers, one containing 10g Release 2 (10.1.2) Oracle HTTP Server and OracleAS Web Cache components and the second containing a 10g Release 3 (10.1.3.1.0) OC4J instance. Oracle HTTP Server and OracleAS Web Cache are installed as a part of a J2EE and Web Cache middle-tier installation.	"Configuring Oracle Application Server 10.1.2 with Oracle Application Server 10.1.3" in the <i>Oracle Application Server Administrator's Guide</i>
10.1.4 or 10.1.2 OracleAS Infrastructure: A 10g Release 3 (10.1.3.1.0) middle-tier instance using a 10g (10.1.4) or 10g Release 2 (10.1.2) Oracle Identity Management. This topology also supports associating a 10g Release 3 (10.1.3.1.0) middle-tier instance with a new 10g (10.1.4) or 10g Release 2 (10.1.2) Oracle Identity Management for the following scenarios: <ul style="list-style-type: none"> ■ Moving to a new host ■ Creating a failover environment 	"Configuring Instances to Use a 10.1.4 or 10.1.2 Oracle Identity Management" in the <i>Oracle Application Server Administrator's Guide</i> "Moving 10.1.4 or 10.1.2 Identity Management to a New Host" in the <i>Oracle Application Server Administrator's Guide</i>
10.1.2 OracleAS Web Cache Instance: A single 10g Release 2 (10.1.2) OracleAS Web Cache acting as a reverse proxy for a 10g Release 3 (10.1.3.1.0) middle-tier. The middle tier contains an integrated OC4J instance with Oracle HTTP Server.	"Configuring 10.1.2 OracleAS Web Cache as a Reverse Proxy" in the <i>Oracle Application Server Administrator's Guide</i>
10.1.2 OracleAS Web Cache Cluster: Two or more 10g Release 2 (10.1.2) OracleAS Web Cache servers configured as a cluster to reverse proxy a 10g Release 3 (10.1.3.1.0) middle-tier. The middle tier contains an integrated OC4J instance with Oracle HTTP Server.	"Configuring 10.1.2 OracleAS Web Cache as a Reverse Proxy" in the <i>Oracle Application Server Administrator's Guide</i>

The remainder of this section addresses the recommended topologies for installing Oracle HTTP Server and OC4J instances. It contains the following topics:

- [Section 1.3.1, "Installing a Standalone OC4J Instance"](#)
- [Section 1.3.2, "Installing an Integrated Web Server and OC4J Middle Tier"](#)
- [Section 1.3.3, "Installing a SOA Administration Instance"](#)
- [Section 1.3.4, "Installing a J2EE Server with the SOA Suite"](#)
- [Section 1.3.5, "Installing J2EE Server, Web Server, and the SOA Suite"](#)
- [Section 1.3.6, "Installing J2EE Server and the SOA Suite with a Remote Oracle HTTP Server"](#)
- [Section 1.3.7, "Installing J2EE Server and Separate SOA Applications with a Remote Oracle HTTP Server"](#)
- [Section 1.3.8, "Installing Multiple SOA Middle Tiers with a Remote Oracle HTTP Server"](#)

1.3.1 Installing a Standalone OC4J Instance

Figure 1–1 shows a topology in which you install a standalone OC4J instance. This topology is suitable for J2EE developers.

Figure 1–1 Standalone OC4J Instance

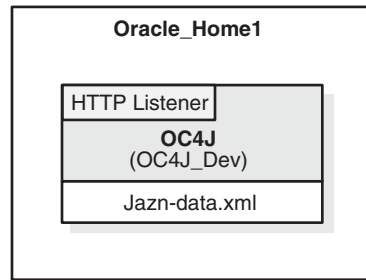

Requirements

The requirements are the same as those listed in [Chapter 2, "Requirements"](#).

Installation Sequence

Perform an advanced installation of J2EE Server, as described in [Section 5.2.4, "Installing J2EE Server"](#). During the installation procedure, follow the prompts, ensuring you perform the following:

- On the Administration Settings screen, do not select **Configure this as an Administration OC4J instance**.
- On the Cluster Topology Configuration screen, do not select **Access this OC4J instance from a separate Oracle HTTP Server**.

1.3.2 Installing an Integrated Web Server and OC4J Middle Tier

The J2EE Server and Web Server installation type in advanced installation mode combines an Oracle HTTP Server and OC4J middle-tier instance in the same Oracle home, as depicted in [Figure 1–2](#). This topology is suitable for J2EE developers and cannot manage the SOA suite.

Figure 1–2 Integrated Web Server and OC4J Middle Tier

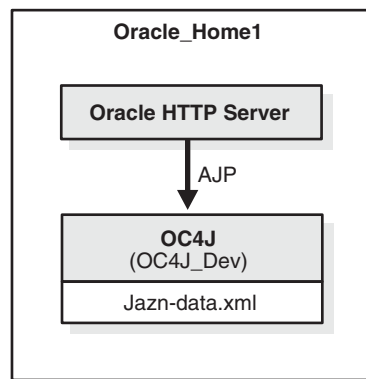

Requirements

The requirements are the same as those listed in [Chapter 2, "Requirements"](#).

Installation Sequence

Perform an advanced installation of J2EE Server and Web Server, as described in [Section 5.2.3, "Installing J2EE Server and Web Server"](#). During the installation procedure, follow the prompts, ensuring you perform the following:

- On the Administration Settings screen, do not select **Configure this as an Administration OC4J instance**.

1.3.3 Installing a SOA Administration Instance

This topology is similar to the example in the previous section, [Section 1.3.2](#). As in the previous section, this topology combines an Oracle HTTP Server and OC4J middle-tier instance in the same Oracle home, but it also includes Application Server Control and Java Single Sign-On, as depicted in [Figure 1-3](#). This topology is suitable for managing the SOA Suite.

Figure 1-3 SOA Administration Instance

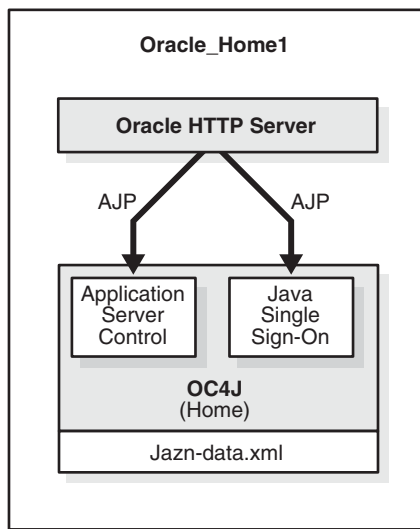

Requirements

The requirements are the same as those listed in [Chapter 2, "Requirements"](#).

Installation Sequence

Perform an advanced installation of J2EE Server and Web Server, as described in [Section 5.2.3, "Installing J2EE Server and Web Server"](#). During the installation procedure, follow the prompts, ensuring you perform the following:

- On the Administration Settings screen, select **Configure this as an Administration OC4J instance**.

1.3.4 Installing a J2EE Server with the SOA Suite

The Basic Installation Mode combines the SOA Suite and OC4J middle-tier instance in the same Oracle home with a remote Oracle Database, as depicted in [Figure 1-4](#). This topology is suitable for SOA developers.

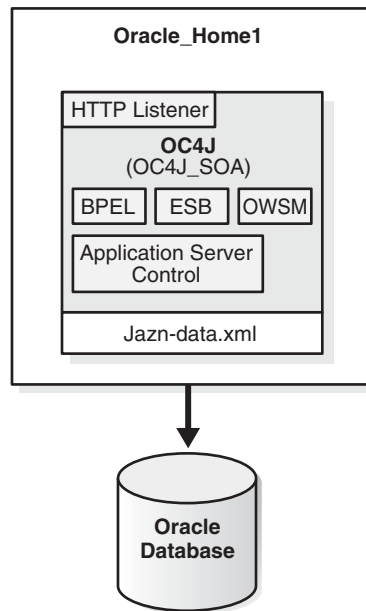
Figure 1–4 J2EE Server with the SOA Suite**Requirements**

The requirements are the same as those listed in [Chapter 2, "Requirements"](#).

Installation Sequence

Perform a basic installation, as described in [Section 4.2, "Basic Installation Steps"](#).

1.3.5 Installing J2EE Server, Web Server, and the SOA Suite

The J2EE Server, Web Server, and SOA Suite installation type in advanced installation mode combines the SOA Suite, Oracle HTTP Server, and OC4J middle-tier instance in the same Oracle home, as depicted in [Figure 1–5](#). This topology is suitable for SOA developers.

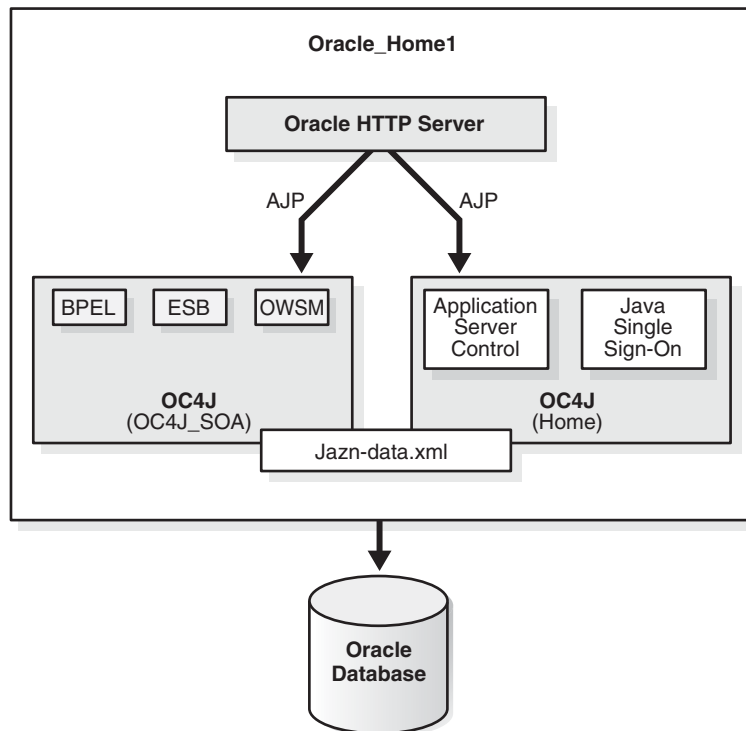
Figure 1–5 J2EE Server, Web Server, and the SOA Suite**Requirements**

The requirements are the same as those listed in [Chapter 2, "Requirements"](#).

Installation Sequence

Perform an advanced installation of J2EE Server, Web Server and SOA Suite, as described in [Section 5.2.2, "Installing J2EE Server, Web Server and SOA Suite"](#). During the installation procedure, follow the prompts, ensuring you perform the following:

- On the Administration Settings screen, select **Configure this as an Administration OC4J instance**.
- On the Cluster Topology Configuration screen, do not select **Access this OC4J Instance from a separate Oracle HTTP Server**.

1.3.6 Installing J2EE Server and the SOA Suite with a Remote Oracle HTTP Server

[Figure 1–6](#) shows a topology in which you install Oracle HTTP Server on one computer and OC4J and the SOA Suite on another computer. Then, you cluster the instances using dynamic node discovery. This topology enables Oracle HTTP Server to route requests to OC4J, and OC4J to dynamically notify Oracle HTTP Server of new application bindings when an application is deployed. It also allows for flexibility and growth.

Figure 1–6 Cluster with J2EE Server and the SOA Suite and a Remote Oracle HTTP Server

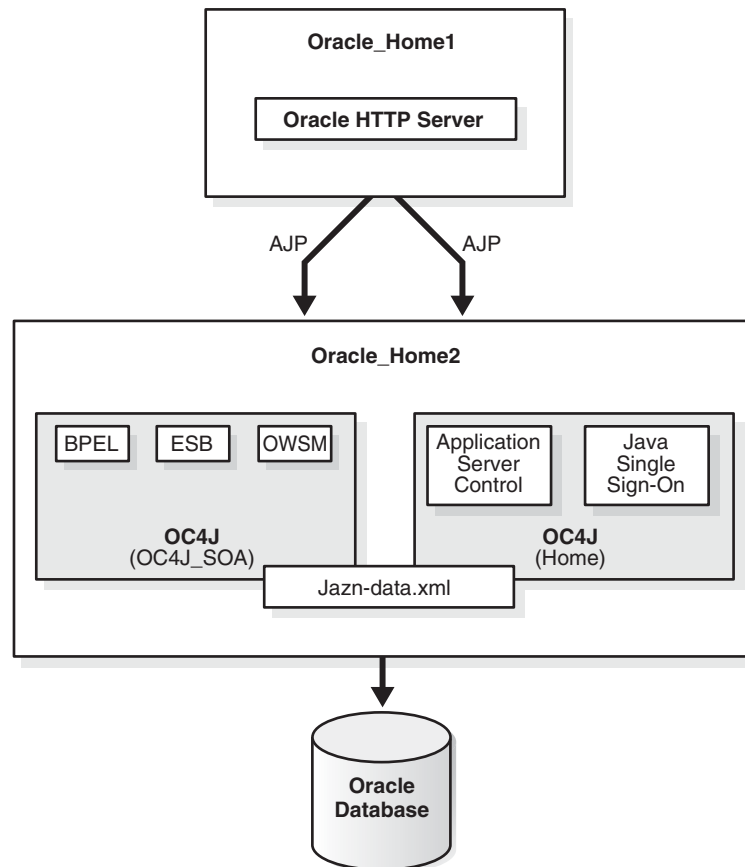

Requirements

The requirements are the same as those listed in [Chapter 2, "Requirements"](#).

Installation Sequence

To install this topology:

1. For the first middle tier, install a Web Server instance.

Perform an advanced installation of Web Server, as described in [Section 5.2.5, "Installing Web Server"](#). During the installation procedure, follow the prompts, ensuring you perform the following:

- On the Cluster Topology Configuration screen, select **Configure this Oracle HTTP Server instance to be a part of an Oracle Application Server cluster** and specify a cluster discovery address for the cluster. The multicast address you enter must be within the valid address range, which is 224 . 0 . 1 . 0 to 239 . 255 . 255 . 255.

Make a note of the address and port that you enter on this page; you will need them later.

- Make a note of the hostname and port for the Oracle HTTP Server instance; you will need them later.
2. For the second middle tier, install a J2EE Server, Web Server and SOA Suite instance.

Perform an advanced installation of J2EE Server, Web Server and SOA Suite, as described in [Section 5.2.2, "Installing J2EE Server, Web Server and SOA Suite"](#). During the installation procedure, follow the prompts, ensuring you perform the following:

- On the Administration Settings screen, select **Configure this as an Administration OC4J instance**.
- On the Cluster Topology Configuration screen, select **Access this OC4J Instance from a separate Oracle HTTP Server**. Specify the hostname and port for the middle tier you installed in Step 1 of this procedure.

On this same screen, select **Configure this instance to be part of an Oracle Application Server cluster topology** and specify the same cluster discovery address as you specified in Step 1 of this procedure.

3. Configure Java Single Sign-On. Perform the following steps on the second Oracle Application Server instance you just installed (Oracle_Home2 in [Figure 1-6](#)):
 - a. Access the Oracle Enterprise Manager 10g Application Server Control Console.
 - b. Scroll to the Administration section and click **Java SSO Configuration**.
The Java SSO Configuration page appears.
 - c. Click **Participating Applications**.
The applications are listed.
 - d. Click the check box for the following applications to be Java SSO enabled:
 - orabpel (for Oracle BPEL Process Manager)
 - esb-dt (for Oracle Enterprise Service Bus)
 - ccore (for Oracle Web Services Manager)
 - ascontrol (for Application Server Control Console)
 - e. Click **Apply**.
A confirmation message appears that the SSO configuration was completed and will take effect after the instances are restarted.
 - f. Click **Restart**.
A confirmation message appears.
 - g. Click **Yes**.
The instance is restarted.
 - h. To configure JSSO for OWSM, perform the following steps:
 - Navigate to `ORACLE_HOME/owsm/bin`.
 - Edit the `ORACLE_HOME/owsm/bin/install.properties` file to set the `install.sso.support` property to `true`.
 - Run the following command:

```
prompt> wsmadmin.sh deploy password console
```



In the preceding commands, *password* is the OC4J administrator password.

- i. Reconfigure the owsm console application with the OID security provider as described in "Steps to Use the Oracle Identity Management Security Provider" and "Settings for Authentication Method with Oracle Identity Management" in the *Oracle Containers for J2EE Security Guide*, Chapter 8.

1.3.7 Installing J2EE Server and Separate SOA Applications with a Remote Oracle HTTP Server

This topology is similar to the example in the previous section, [Section 1.3.6](#). As in the previous section, this topology has an Oracle HTTP Server in one home and OC4J and the SOA applications in a separate Oracle home. Unlike the previous example, the SOA applications are separated, each with its own OC4J instance, as depicted in [Figure 1-7](#).

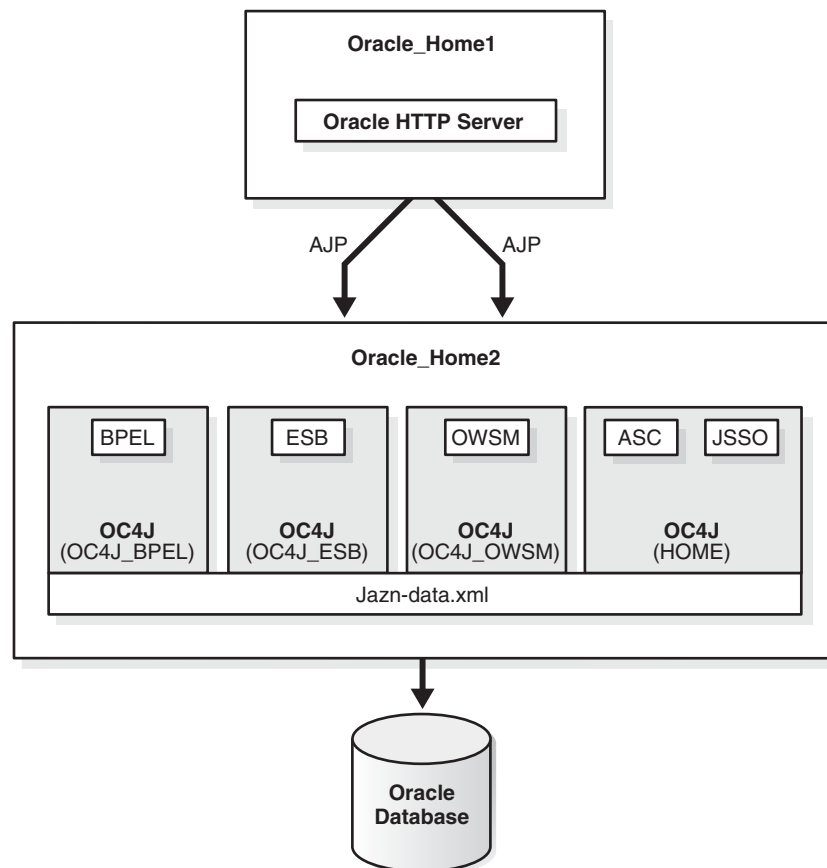
Figure 1-7 Cluster with J2EE Server and Separate SOA Applications and a Remote Oracle HTTP Server



Requirements

The requirements are the same as those listed in [Chapter 2, "Requirements"](#).

Installation Sequence

To install this topology:

1. For the first middle tier, install a Web Server instance.

Perform an advanced installation of Web Server, as described in [Section 5.2.5, "Installing Web Server"](#). During the installation procedure, follow the prompts, ensuring you perform the following:

- On the Cluster Topology Configuration screen, select **Configure this Oracle HTTP Server instance to be a part of an Oracle Application Server cluster** and specify a cluster discovery address for the cluster. The multicast address you enter must be within the valid address range, which is 224.0.1.0 to 239.255.255.255.

Make a note of the address and port that you enter on this page; you will need them later.

- Make a note of the hostname and port for the Oracle HTTP Server instance; you will need them later.
2. For the second middle tier, install a J2EE Server instance.

Perform an advanced installation of J2EE Server, as described in [Section 5.2.4, "Installing J2EE Server"](#). During the installation procedure, follow the prompts, ensuring you perform the following:

- On the Administration Settings screen, select **Configure this as an Administration OC4J instance**.
- On the Cluster Topology Configuration screen, select **Access this OC4J Instance from a separate Oracle HTTP Server**.

On this same screen, select **Configure this instance to be part of an Oracle Application Server cluster topology** and specify the same cluster discovery address as you specified in Step 1 of this procedure.

3. You must create the OC4J instances for each of the SOA applications in Oracle_Home2, as shown in [Figure 1-7](#). Use the steps below to create the following OC4J instances for the SOA applications:

- OC4J_BPEL
- OC4J_ESB
- OC4J_WSM

- a. Log in to the Application Server Control Console with the password set during installation.

The **Cluster Topology** page appears.

- b. Click the link in the **Members** list for the application server instance in Oracle_Home2.

The Application Server page for the instance appears, listing the Admin OC4J instance in the System Components list.

- c. Click **Create OC4J Instance**.

The Create OC4J Instance page appears.

- d. Enter OC4J_BPEL in the OC4J Instance Name field. Leave the defaults for the group and check the box to start the instance.

- e. Click **Create**.

The Processing: screen appears with a message, then the **Application Server** page appears with the new instance and a confirmation message that the instance was created and added to the group.

- f. Click the **OC4J_BPEL** instance.
The OC4J page appears.
 - g. Click **Administration**.
The Administration Tasks table appears.
 - h. Click the **Go to Task** icon for Server Properties in the Properties list.
The Server Properties page appears.
 - i. Specify an unused AJP port for the default-web-site and click **Apply**. You can

```
netstat -an
```

The AJP port range is 12501-12600.
The Processing screen appears with a status message, then a confirmation message appears.
 - j. Repeat steps a through i for the OC4J_ESB and OC4J_WSM instances, assigning a different unique port from the range to each.
 - k. Run the following commands in Oracle_Home2:

```
prompt> ORACLE_HOME/opmn/bin/opmnctl stopall
prompt> ORACLE_HOME/opmn/bin/opmnctl startall
```
4. Deploy the SOA applications in Oracle_Home2:
 - a. Install BPEL using the Oracle BPEL Process Manager (10.1.3.1.0) CD. Follow the instructions in *Oracle BPEL Process Manager Installation Guide*.
During the installation procedure, follow the prompts, ensuring you perform the following:
 - Specify OC4J_BPEL as the **OC4J Instance Name**.
 - In the **HTTP Host:Port** field, specify the hostname and port for the middle tier you installed in Step 1 of this procedure.
 - b. Install ESB using the Oracle Enterprise Bus (10.1.3.1.0) CD. Follow the instructions in *Oracle Enterprise Service Bus Installation Guide*.
During the installation procedure, follow the prompts, ensuring you perform the following:
 - Select OC4J_ESB as the OC4J instance name.
 - Specify the hostname and port for the middle tier you installed in Step 1 of this procedure as the outgoing HTTP proxy.
 - c. Install OWSM using the Oracle Web Services Manager (10.1.3.1.0) CD. Follow the instructions in *Oracle Web Services Manager Installation Guide*.
During the installation procedure, follow the prompts, ensuring you perform the following:
 - Specify OC4J_WSM as the **OC4J Instance** name.
 - In the **HTTP Host:Port** field, specify the hostname and port for the middle tier you installed in Step 1 of this procedure.
 5. Configure Java Single Sign-On. Perform the following steps on the second Oracle Application Server instance you just installed (Oracle_Home2 in [Figure 1-7](#)):

- a. Access the Oracle Enterprise Manager 10g Application Server Control Console.
- b. Scroll to the Administration section and click **Java SSO Configuration**.
The Java SSO Configuration page appears.
- c. Click **Participating Applications**.
The applications are listed.
- d. Click the check box for the following applications to be Java SSO enabled:
 - orabpel (for Oracle BPEL Process Manager)
 - esb-dt (for Oracle Enterprise Service Bus)
 - ccore (for Oracle Web Services Manager)
 - ascontrol (for Application Server Control Console)
- e. Click **Apply**.
A confirmation message appears that the SSO configuration was completed and will take effect after the instances are restarted.
- f. Click **Restart**.
A confirmation message appears.
- g. Click **Yes**.
The instance is restarted.
- h. To configure JSSO for OWSM, perform the following steps:
 - Navigate to `ORACLE_HOME/owsm/bin`.
 - Edit the `ORACLE_HOME/owsm/bin/install.properties` file to set the `install.sso.support` property to `true`.
 - Run the following command:

```
prompt> wsmadmin.sh deploy password console
```

In the preceding commands, *password* is the OC4J administrator password.
- i. Reconfigure the owsm console application with the OID security provider as described in "Steps to Use the Oracle Identity Management Security Provider" and "Settings for Authentication Method with Oracle Identity Management" in the *Oracle Containers for J2EE Security Guide*, Chapter 8.

1.3.8 Installing Multiple SOA Middle Tiers with a Remote Oracle HTTP Server

This topology builds upon the example in [Section 1.3.6](#). It adds an additional OC4J instance with the SOA Suite, as shown in [Figure 1-8](#). When you install this cluster topology, you install Oracle HTTP Server on one computer, install OC4J and SOA Suite instances on two separate computers, and specify cluster settings. You designate one of the OC4J instances as the Administration OC4J instance for running the Application Server Control Console. You manage both OC4J instances from this instance of Application Server Control Console.

Figure 1–8 Cluster with Multiple SOA Middle Tiers and a Remote Oracle HTTP Server

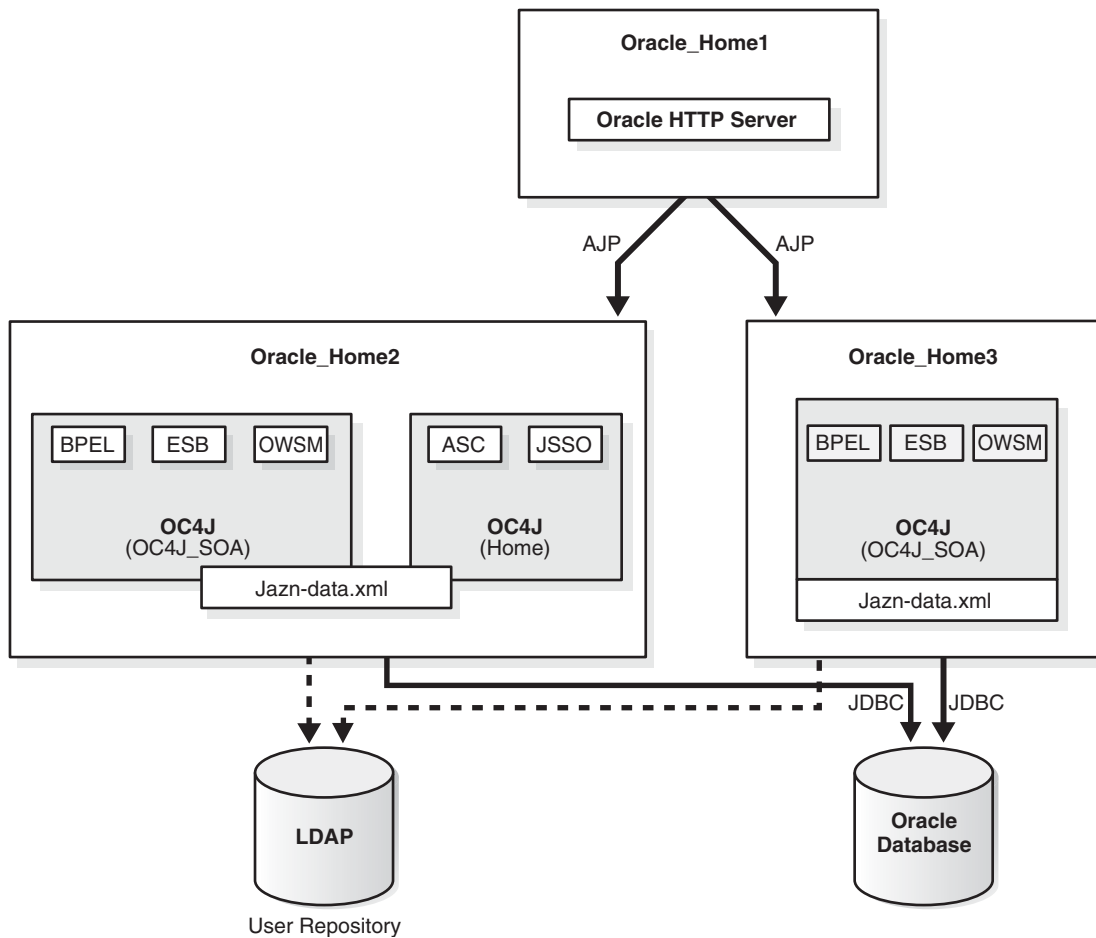

Requirements

The requirements are the same as those listed in [Chapter 2, "Requirements"](#).

Installation Sequence

To install this topology:

1. For the first middle tier, install a Web Server instance.

Perform an advanced installation of Web Server, as described in [Section 5.2.5, "Installing Web Server"](#). During the installation procedure, follow the prompts, ensuring you perform the following:

- On the Cluster Topology Configuration screen, select **Configure this Oracle HTTP Server instance to be a part of an Oracle Application Server cluster** and specify a cluster discovery address for the cluster. The multicast address you enter must be within the valid address range, which is 224.0.1.0 to 239.255.255.255.

Make a note of the address and port that you enter on this page; you will need them later.

- Make a note of the hostname and port for the Oracle HTTP Server instance; you will need them later.
2. For the second middle tier, install a J2EE Server, Web Server and SOA Suite instance.

Perform an advanced installation of J2EE Server, Web Server and SOA Suite, as described in [Section 5.2.2, "Installing J2EE Server, Web Server and SOA Suite"](#). During the installation procedure, follow the prompts, ensuring you perform the following:

- On the Administration Settings screen, select **Configure this as an Administration OC4J instance**.
- On the Cluster Topology Configuration screen, select **Access this OC4J Instance from a separate Oracle HTTP Server**. Specify the hostname and port for the middle tier you installed in Step 1 of this procedure.

On this same screen, select **Configure this instance to be part of an Oracle Application Server cluster topology** and specify the same cluster discovery address as you specified in Step 1 of this procedure.

3. For the third middle tier, install a J2EE Server, Web Server and SOA Suite instance.

Perform an advanced installation of J2EE Server, Web Server and SOA Suite, as described in [Section 5.2.2, "Installing J2EE Server, Web Server and SOA Suite"](#). During the installation procedure, follow the prompts, ensuring you perform the following:

- On the Administration Settings screen, do not select **Configure this as an Administration OC4J instance**.
- On the Cluster Topology Configuration screen, select **Access this OC4J Instance from a separate Oracle HTTP Server**. Specify the hostname and port for the middle tier you installed in Step 1 of this procedure.

On this same screen, select **Configure this instance to be part of an Oracle Application Server cluster topology** and specify the same cluster discovery address as you specified in Step 1 of this procedure.

4. Configure Java Single Sign-On. Perform the following steps on the second Oracle Application Server instance you just installed (Oracle_Home2 in [Figure 1-8](#)):

- a. Access the Oracle Enterprise Manager 10g Application Server Control Console.
- b. Scroll to the Administration section and click **Java SSO Configuration**.
The Java SSO Configuration page appears.
- c. Click **Participating Applications**.
The applications are listed.
- d. Click the check box for the following applications to be Java SSO enabled:
 - orabpel (for Oracle BPEL Process Manager)
 - esb-dt (for Oracle Enterprise Service Bus)
 - ccore (for Oracle Web Services Manager)
 - ascontrol (for Application Server Control Console)
- e. Click **Apply**.
A confirmation message appears that the SSO configuration was completed and will take effect after the instances are restarted.
- f. Click **Restart**.
A confirmation message appears.

g. Click **Yes**.

The instance is restarted.

h. To configure JSSO for OWSM, perform the following steps:

- Navigate to `ORACLE_HOME/owsm/bin`.
- Edit the `ORACLE_HOME/owsm/bin/install.properties` file to set the `install.sso.support` property to `true`.
- Run the following command:

```
prompt> wsmadmin.sh deploy password console
```

In the preceding commands, *password* is the OC4J administrator password.

i. Reconfigure the owsm console application with the OID security provider as described in "Steps to Use the Oracle Identity Management Security Provider" and "Settings for Authentication Method with Oracle Identity Management" in the *Oracle Containers for J2EE Security Guide*, Chapter 8.

Requirements

Before installing Oracle Application Server, ensure that your computer meets the requirements described in this chapter.

Table 2–1 Sections in This Chapter

Section	Highlights
Section 2.1, "Using OracleMetaLink to Obtain the Latest Oracle Application Server Hardware and Software Requirements"	Describes how to find the most current requirements for Oracle Application Server 10g Release 3 (10.1.3.1.0).
Section 2.2, "System Requirements"	Lists requirements such as supported processor speed, memory, disk space, and swap space.
Section 2.3, "Software Requirements"	Lists requirements such as supported operating systems, operating system patches, software packages, and Linux x86-64 certification informations.
Section 2.4, "Set Shell Limits for the oracle User"	Lists the shell limits for the <code>oracle</code> user.
Section 2.5, "Ports"	Describes how to configure components to use ports other than the default ports.
Section 2.6, "Operating System Groups"	Describes why the operating system user who installs Oracle Application Server should belong to certain operating system groups.
Section 2.7, "Operating System User"	Describes why you should create an operating system user to install Oracle Application Server.
Section 2.8, "Requirements for the Database"	Describes the requirements for the database used by SOA applications.
Section 2.9, "Installing Database Schemas"	Describes how to install the <code>ORABPEL</code> , <code>ORAESB</code> , and <code>ORAWSM</code> database schemas into your Oracle database.
Section 2.10, "Environment Variables"	Describes how to set or unset environment variables required for installation.
Section 2.11, "Network Topics"	Describes network issues such as installing Oracle Application Server on a remote computer, using a remote CD-ROM/DVD-ROM drive, or installing from a hard disk.
Section 2.12, "Prerequisite Checks Performed by the Installer"	Lists the items checked by the installer, such as length of the Oracle home name and whether or not the Oracle home directory already contains another Oracle product.

2.1 Using OracleMetaLink to Obtain the Latest Oracle Application Server Hardware and Software Requirements

The Oracle Application Server 10g Release 3 (10.1.3.1.0) hardware and software requirements included in this guide were accurate at the time this manual was released to manufacturing. For the most up-to-date information about hardware and software requirements, refer to *OracleMetaLink*:

<http://metalink.oracle.com/>

After logging into *OracleMetaLink*, click **Certify**. From the resulting Web page, you can view the latest certifications by product, platform, and product availability.

2.2 System Requirements

Table 2–2 lists the system requirements for running Oracle Application Server. The installer checks many of these requirements at the start of the installation process and warns you if any of them is not met. To save time, you can manually check only the ones that are not checked by the installer. Refer to Table 2–2 to see which requirements are not checked by the installer.

You can also run the system checks performed by the installer without doing an installation, by running the `runInstaller` command as shown. The `runInstaller` command is on the Oracle Application Server CD-ROM (Disk 1) or DVD-ROM (in the `application_server` directory).

CD-ROM:

```
prompt> mount_point/runInstaller -executeSysPrereqs
```

DVD-ROM:

```
prompt> mount_point/application_server/runInstaller -executeSysPrereqs
```

The results are displayed on the screen as well as written to a log file. For more information on the types of checks performed, see Section 2.12, "Prerequisite Checks Performed by the Installer".

Table 2–2 System Requirements

Item	Requirement
Network	<p>You can install Oracle Application Server on a computer that is connected to a network, or on a "standalone" computer (not connected to the network).</p> <p>If you are installing Oracle Application Server on a standalone computer, you can connect the computer to a network after installation. You have to perform some configuration tasks when you connect it to the network; see the <i>Oracle Application Server Administrator's Guide</i> for details.</p> <p>Checked by Installer: No</p>
IP	<p>The computer's IP address can be static or allocated using DHCP. If you later change the IP configuration, see the <i>Oracle Application Server 10g Administrator's Guide</i> for information on reconfiguring Oracle Application Server. See Section 2.11.1, "Installing on a DHCP Host" for additional requirements.</p> <p>Checked by Installer: No</p>
Hostname	<p>Ensure that your hostnames are not longer than 255 characters.</p> <p>Checked by Installer: No</p>

Table 2–2 (Cont.) System Requirements

Item	Requirement
Processor type	<p>Pentium (32-bit)</p> <p>To determine the processor type, run the following command:</p> <pre>prompt> cat /proc/cpuinfo grep name model name : Intel(R) Pentium(R) 4 CPU 3.00GHz</pre> <p>Checked by Installer: No</p>
Processor Speed	<p>300 MHz or faster</p> <p>To determine the processor speed, run the following command:</p> <pre>prompt> cat /proc/cpuinfo grep MHz cpu MHz : 2992.553</pre> <p>Checked by Installer: Yes</p>
Memory	<p>512 MB</p> <p>The memory requirement provided represents enough physical memory to install and run Oracle Application Server. However, for most production sites, you should configure at least 1 GB of physical memory. For sites with substantial traffic, increasing the amount of memory further may improve your performance. For Java applications, you should either increase the maximum heap allocated to the OC4J processes, or configure additional OC4J processes to utilize this memory. See the <i>Oracle Application Server Performance Guide</i> for details.</p> <p>To determine the optimal amount of memory for your installation, the best practice is to load test your site. Resource requirements can vary substantially for different applications and different usage patterns. In addition, some operating system utilities for monitoring memory can overstate memory usage (partially due to the representation of shared memory). The preferred method for determining memory requirements is to monitor the improvement in performance resulting from the addition of physical memory in your load test. Refer to your platform vendor documentation for information on how to configure memory and processor resources for testing purposes.</p> <p>Notes:</p> <ul style="list-style-type: none"> ■ The installer checks the amount of memory on your computer and will warn you if your computer does not meet the minimum memory requirements. <p>To determine the amount of memory, enter the following command:</p> <pre>prompt> grep MemTotal /proc/meminfo</pre> <p>Checked by Installer: Yes</p>
Disk space	<ul style="list-style-type: none"> ■ Basic Installation: J2EE Server and Oracle SOA Suite: 1 GB ■ Advanced Installation: J2EE Server, Web Server, and Oracle SOA Suite: 1.05 GB ■ Advanced Installation: J2EE Server and Web Server: 650 MB ■ Advanced Installation: J2EE Server: 625 MB ■ Advanced Installation: Web Server: 500 MB <p>The installer may display inaccurate disk space requirement figures. Refer to the figures listed above for disk space requirements.</p> <p>To determine the amount of free disk space, use the <code>df</code> command:</p> <pre>prompt> df -k dir</pre> <p>Replace <i>dir</i> with the Oracle home directory or with the parent directory if the Oracle home directory does not exist yet. For example, if you plan to install Oracle Application Server in <code>/opt/oracle/j2ee</code>, you can replace <i>dir</i> with <code>/opt/oracle</code> or <code>/opt/oracle/j2ee</code>.</p> <p>Checked by Installer: Yes</p>

Table 2–2 (Cont.) System Requirements

Item	Requirement
Space in /tmp or directory	<p>400 MB</p> <p>To determine the amount of free disk space in the /tmp directory, use the <code>df</code> command:</p> <pre>prompt> df -k /tmp</pre> <p>If the /tmp directory does not have enough free space, you can specify a different directory by setting the <code>TMP</code> or <code>TMPDIR</code> environment variable. See Section 2.10.5, "TMP and TMPDIR" for details.</p> <p>Checked by Installer: Yes</p>
Swap space	<p>512 MB of available swap space</p> <p>To determine the amount of available swap space, enter the following command:</p> <pre>prompt> grep SwapTotal /proc/meminfo</pre> <p>If necessary, see your operating system documentation for information on how to configure additional swap space.</p> <p>Checked by Installer: Yes</p>
Monitor	<p>256 color display</p> <p>To determine your monitor's display capabilities, run the following command:</p> <pre>prompt> /usr/X11R6/bin/xdpinfo</pre> <p>Look for the "depths" line. You need a depth of at least 8 (bits per pixel).</p> <p>Checked by Installer: Yes</p>
Supported browsers	<p>Oracle Enterprise Manager 10g is supported on the following browsers:</p> <ul style="list-style-type: none"> ■ Microsoft Internet Explorer 6.0 SP2 (supported on Microsoft Windows only) ■ Netscape 7.2 ■ Mozilla 1.7. You can download Mozilla from http://www.mozilla.org. ■ Firefox 1.0.4. You can download Firefox from http://www.mozilla.org. ■ Safari 1.2, 2.0 (on Apple Macintosh computers) <p>For the most current list of supported browsers, check the Oracle <i>MetaLink</i> site (http://metalink.oracle.com).</p> <p>Checked by Installer: No. However, if you access Oracle Enterprise Manager 10g using a non-supported browser, you will get a warning message.</p>

2.2.1 Installing from the Console or X Windows

If you are performing the installation from the console or X Windows, then add the following line to the `/etc/pam.d/xdm` file:

```
session required pam_limits.so
```

2.3 Software Requirements

Depending on your distribution of Linux, see one of the following sections for information on checking the software requirements:

- [Section 2.3.1, "Software Requirements for Red Hat Enterprise Linux AS/ES 3.0 Systems"](#)

- [Section 2.3.2, "Software Requirements for Red Hat Enterprise Linux AS/ES 4.0 Systems"](#)
- [Section 2.3.3, "Software Requirements for SUSE Linux Enterprise Server 9 Systems"](#)

Oracle does not support customized kernels or modules not supported by the Linux vendor.

You can install Oracle Application Server 10g Release 3 (10.1.3.1.0) on a Linux system that is not on a network and you can install Oracle Application Server 10g Release 3 (10.1.3.1.0) on a Linux system that is configured to use DHCP. If you want to install Oracle Application Server on a computer that is not on a network you must configure the computer to use either a static IP address or a loopback IP address. Configure the computer to resolve the hostname of the computer to either a static IP address or a loopback IP address.

2.3.1 Software Requirements for Red Hat Enterprise Linux AS/ES 3.0 Systems

[Table 2–3](#) lists the software requirements for Red Hat Enterprise Linux AS/ES 3.0 systems and the procedure that follows the table describes how to ensure your system meets these requirements and any additional requirements for installing Oracle Application Server.

Note: Red Hat Enterprise Linux AS/ES 3.0, 4.0 and SUSE Linux Enterprise Server 9 are certified and supported. For the most current list of supported Linux Operating Systems, check *OracleMetaLink* (<http://metalink.oracle.com>).

Table 2–3 *Software Requirements for Red Hat Enterprise Linux AS/ES 3.0 Systems*

Item	Requirement
Operating System	Red Hat Enterprise Linux AS/ES 3.0 For more information on Red Hat, see: http://www.redhat.com
Red Hat Update	Update 3

Table 2-3 (Cont.) Software Requirements for Red Hat Enterprise Linux AS/ES 3.0

Item	Requirement
Software packages (check that these versions or higher versions are installed)	<pre>glibc-2.3.2-95.27 glibc-common-2.3.2-95.27 binutils-2.14.90.0.4-35 compat-glibc-7.x-2.2.4.32.6 compat-libstdc++-7.3-2.96.128 compat-libstdc++-devel-7.3-2.96.128 gcc-3.2.3-42 gcc-c++-3.2.3-42 libstdc++-3.2.3-42 libstdc++-devel-3.2.3-42 openmotif21-2.1.30-8 pdksh-5.2.14-21 setarch-1.3-1 make-3.79.1-17 gnome-libs-1.4.1.2.90-34.1 sysstat-4.0.7-4.EL3.3 compat-db-4.0.14-5</pre>
	<p>Note: For Red Hat Enterprise Linux AS/ES 3.0, the equivalent version of <code>openmotif 2.1.30-8</code> is <code>openmotif21-2.1.30-8</code>. The <code>openmotif21-2.1.30-8</code> package can be installed from disk number 3 of the Red Hat Enterprise Linux AS/ES 3.0 distribution by entering:</p> <pre>\$ rpm -ivh openmotif21-2.1.30-8</pre>
64-bit Certification	<p>Red Hat Enterprise Linux AS/ES 3.0, Update 3 or higher, is certified on AMD64 and Intel EM64T. The following packages (or higher versions) are required:</p> <pre>glibc-2.3.2-95.27.x86_64.rpm glibc-3.2.3-95.27.i686.rpm (32-bit) glibc-devel-3.2.3-95.27.x86_64.rpm glibc-devel-3.2.3-95.27.i386.rpm (32-bit) gcc-3.2.3-20.x86_64.rpm libgcc-3.2.3-20.x86_64.rpm libgcc-3.2.3-20.i386.rpm (32-bit) setarch-1.3-1.x86_64.rpm pdksh-5.2.14-21.x86_64.rpm openmotif21-2.1.30-8.i386.rpm compat-glibc-7.x-2.2.4.32.5.i386.rpm (32-bit) compat-gcc-7.3-2.96.122.i386.rpm sysstat-4.0.7-4.x86_64.rpm gnome-libs-1.4.1.2.90-34.1.i386.rpm (32-bit) compat-db-4.0.14-5.1.i386.rpm (32-bit)</pre> <p>Note the following:</p> <ul style="list-style-type: none"> ■ To install 32-bit packages on a 64-bit system, you may need to use the <code>--force</code> option and the <code>--nodeps</code> option of the <code>rpm</code> utility. ■ Always use 32-bit shell emulation, use the following command before running the installer and any other Oracle Application Server commands or scripts: <pre># linux32 bash</pre>

To ensure that the system meets all the requirements, follow these steps:

1. Log in as the `root` user.

- To determine which distribution and version of Linux is installed, enter the following command:

```
# cat /etc/issue
Red Hat Enterprise Linux AS release 3 (Taroon)
```

Note: Red Hat Enterprise Linux AS/ES 3.0, 4.0 and SUSE Linux Enterprise Server 9 are certified and supported. For the most current list of supported Linux Operating Systems, check Oracle *MetaLink* (<http://metalink.oracle.com>).

- To check that Update 3 is installed:

```
# cat /etc/redhat-release
Red Hat Enterprise Linux AS release 3 (Taroon Update 3)
```

- To determine whether any other package is installed, enter a command similar to the following:

```
# rpm -q package_name
```

If a package is missing, download it and install it using the following command:

```
# rpm -i package_name
```

When installing a package, make sure you are using the correct architecture and optimization rpm file. To check the architecture of an rpm file, run the following command:

```
# rpm -q package_name --queryformat "%{arch}\n"
```

In the following example, the glibc rpm file is suitable for an Intel architecture

```
# rpm -q glibc --queryformat "%{arch}\n"
i686
```

- If the hugemem kernel is used, set the architecture using following command:

```
prompt> setarch i386
```

2.3.2 Software Requirements for Red Hat Enterprise Linux AS/ES 4.0 Systems

Table 2–4 lists the software requirements for Red Hat Enterprise Linux AS/ES 4.0 systems and the procedure that follows the table describes how to ensure your system meets these requirements and any additional requirements for installing Oracle Application Server.

Note: Red Hat Enterprise Linux AS/ES 3.0, 4.0 and SUSE Linux Enterprise Server 9 are certified and supported. For the most current list of supported Linux Operating Systems, check Oracle *MetaLink* (<http://metalink.oracle.com>).

Table 2-4 Software Requirements for Red Hat Enterprise Linux AS/ES 4.0 Systems

Item	Requirement
Operating System	Red Hat Enterprise Linux AS/ES 4.0 For more information on Red Hat, see: http://www.redhat.com
Red Hat Update	Update 1
Software packages (check that these versions or higher versions are installed)	glibc-2.3.4-2.9 glibc-common-2.3.4-2.9 binutils-2.15.92.0.2-13 compat-libstdc++-296-2.96-132.7.2 gcc-3.4.3-22.1 gcc-c++-3.4.3-22.1 libstdc++-3.4.3-22.1 libstdc++-devel-3.4.3-22.1 openmotif21-2.1.30-11.RHEL4.4 pdksh-5.2.14-30 setarch-1.6-1 make-3.80-5 gnome-libs-1.4.1.2.90-44.1 sysstat-5.0.5-1 compat-db-4.1.25-9 compat-libstdc++-devel-7.3-2.96.128 compat-glibc-7.x-2.2.4.32.6 compat-libstdc++-7.3-2.96.128 control-center-2.8.0-12 xscreensaver-4.18-5.rhel4.2

Table 2–4 (Cont.) Software Requirements for Red Hat Enterprise Linux AS/ES 4.0

Item	Requirement
64-bit Certification	<p>Red Hat Enterprise Linux AS/ES 4.0, Update 1 or higher, is certified on AMD64 and Intel EM64T. The following packages (or higher versions) are required:</p> <pre> binutils-2.15.92.0.2-13.x86_64.rpm compat-db-4.1.25-9.i386.rpm (32-bit) compat-db-4.1.25-9.x86_64.rpm control-center-2.8.0-12.x86_64.rpm gcc-3.4.3-22.1.x86_64.rpm gcc-c++-3.4.3-22.1.x86_64.rpm glibc-2.3.4-2.9.i386.rpm (32-bit) glibc-2.3.4-2.9.x86_64.rpm glibc-common-2.3.4-2.9.x86_64.rpm gnome-libs-1.4.1.2.90-44.1.x86_64.rpm libstdc++-3.4.3-22.1.i386.rpm (32-bit) libstdc++-3.4.3-22.1.x86_64.rpm libstdc++-devel-3.4.3-22.1.i386.rpm (32-bit) libstdc++-devel-3.4.3-22.1.x86_64.rpm make-3.80-5.x86_64.rpm pdksh-5.2.14-30.x86_64.rpm sysstat-5.0.5-1.x86_64.rpm xscreensaver-4.18-5.rhel4.2.x86_64.rpm setarch-1.6-1.x86_64 openmotif21-2.1.30-11.RHEL4.4.i386.rpm (32-bit) </pre> <p>Note the following:</p> <ul style="list-style-type: none"> ■ To install 32-bit packages on a 64-bit system, you may need to use the <code>--force</code> option and the <code>--nodeps</code> option of the <code>rpm</code> utility. ■ Always use 32-bit shell emulation, use the following command before running the installer and any other Oracle Application Server commands or scripts: <pre># linux32 bash</pre>

To ensure that the system meets all the requirements, follow these steps:

1. Log in as the `root` user.
2. To determine which distribution and version of Linux is installed, enter the following command:

```
# cat /etc/issue
Red Hat Enterprise Linux AS release 4 (Nahant Update 1)
```

Note: Red Hat Enterprise Linux AS/ES 3.0, 4.0 and SUSE Linux Enterprise Server 9 are certified and supported. For the most current list of supported Linux Operating Systems, check *OracleMetaLink* (<http://metalink.oracle.com>).

3. To check that Update 1 is installed:

```
# cat /etc/redhat-release
Red Hat Enterprise Linux AS release 4 (Nahant Update 1)
```

- To determine whether any other package is installed, enter a command similar to the following:

```
# rpm -q package_name
```

If a package is missing, download it and install it using the following command:

```
# rpm -i package_name
```

When installing a package, make sure you are using the correct architecture and optimization rpm file. To check the architecture of an rpm file, run the following command:

```
# rpm -q package_name --queryformat "%{arch}\n"
```

In the following example, the glibc rpm file is suitable for an Intel architecture

```
# rpm -q glibc --queryformat "%{arch}\n"
i686
```

- If the hugemem kernel is used, set the architecture using following command:

```
prompt> setarch i386
```

2.3.3 Software Requirements for SUSE Linux Enterprise Server 9 Systems

Table 2–5 lists the software requirements for SUSE Linux Enterprise Server 9 systems and the procedure that follows the table describes how to ensure your system meets these requirements and any additional requirements for installing Oracle Application Server.

Note: Oracle Application Server 10g Release 3 (10.1.3.1.0) is certified with the following Operating System specific software. For the most current list of supported Operating System specific software, for example JDK version, Operating System version, check *OracleMetaLink* (<http://metalink.oracle.com>).

Table 2–5 Software Requirements for SUSE Linux Enterprise Server 9 Systems

Item	Requirement
Operating System	SUSE Linux Enterprise Server 9 For more information on SUSE Linux Enterprise Server, see: http://www.suse.com

Table 2–5 (Cont.) Software Requirements for SUSE Linux Enterprise Server 9 Systems

Item	Requirement
Software packages (check that these versions or higher versions are installed)	glibc-2.3.3-98.28 gcc-3.3.3-43.24 gcc-c++-3.3.3-43.24 libstdc++-3.3.3-43.24 libstdc++-devel-3.3.3-43.24 openmotif21-libs-2.1.30MLI4-119.1 pdksh-5.2.14-780.1 make-3.80-184.1 gnome-libs-1.4.1.7-671.1 gnome-libs-devel-1.4.1.7-671.1 sysstat-5.0.1-35.1 binutils-2.15.90.0.1.1-32.5
64-bit Certification	SUSE Linux Enterprise Server is certified on AMD64 and Intel EM64T. The following packages (or higher versions) are required: glibc-2.3.3-98.28.x86_64.rpm glibc-32bit-9-200407011233.x86_64.rpm glibc-devel-32bit-9-200407011229.x86_64.rpm gcc-3.3.3-43.24.x86_64.rpm gcc-3.2.3-20.x86_64.rpm gcc-c++-3.3.3-43.24.x86_64.rpm libgcc-3.2.3-20.i386.rpm (32-bit) libstdc++-3.3.3-43.24.x86_64.rpm libstdc++-devel-3.3.3-43.24.x86_64.rpm libstdc++-devel-32bit-9-200407011229.x86_64.rpm gnome-libs-1.4.1.7-671.1.x86_64.rpm gnome-libs-devel-1.4.1.7-671.1.x86_64.rpm gnome-libs-32bit-9-200407011229.x86_64.rpm binutils-2.15.90.0.1.1-32.5.x86_64.rpm binutils-32bit-9-200407011229.x86_64.rpm compat-32bit-9-200407011229.x86_64.rpm compat-sles8-1.3-93.3.x86_64.rpm compat-2004.7.1-1.2.x86_64.rpm pdksh-5.2.14-780.1.x86_64.rpm make-3.80-184.1.x86_64.rpm sysstat-5.0.1-35.1.x86_64.rpm perl-32bit-9-200407011229.x86_64.rpm libaio-devel-32bit-9-200407011229.x86_64.rpm XFree86-devel-32bit-9-200407011229.x86_64.rpm linux32-1.0-341.1.x86_64.rpm db-32bit-9-200407011229.x86_64.rpm db1-32bit-9-200407011229.x86_64.rpm compat-32bit-9-200407011229.x86_64.rpm Always use 32-bit shell emulation, use the following command before running the installer and any other Oracle Application Server commands or scripts: # linux32 bash

To ensure that the system meets all the requirements, follow these steps:

1. Log in as the root user.
2. To determine which distribution and version of Linux is installed, enter the following command:

```
prompt> cat /etc/issue
Welcome to SuSE Linux 9.0 (i686) - Kernel \r (\l).
```

Note: Red Hat Enterprise Linux AS/ES 3.0, 4.0 and SUSE Linux Enterprise Server 9 are certified and supported. For the most current list of supported Linux Operating Systems, check *OracleMetaLink* (<http://metalink.oracle.com>).

3. To determine whether any other package is installed, enter a command similar to the following:

```
prompt> rpm -q package_name
```

If a package is missing, download it and install it using the following command:

```
prompt> rpm -i package_name
```

When installing a package, make sure you are using the correct architecture and optimization rpm file. To check the architecture of an rpm file, run the following command:

```
prompt> rpm -q package_name --queryformat "%{arch}\n"
```

In the following example, the glibc rpm file is suitable for an Intel architecture

```
prompt> rpm -q glibc --queryformat "%{arch}\n"
i686
```

4. Create the following symbolic link for the Perl executable if it does not already exist:
5. Create the following symbolic link for the fuser executable if it does not already exist:

```
prompt> ln -sf /usr/bin/perl /usr/local/bin/perl
```

```
prompt> ln -sf /bin/fuser /sbin/fuser
```

6. If the `oracrun` package was installed on a SUSE Linux Enterprise Server system, complete the following steps as the `oracle` user to reset the environment:

- a. Enter the following commands:

```
prompt> cd /etc/profile.d
prompt> mv oracle.csh oracle.csh.bak
prompt> mv oracle.sh oracle.sh.bak
prompt> mv alljava.sh alljava.sh.bak
prompt> mv alljava.csh alljava.csh.bak
```

- b. Use any text editor to comment out the following line from the `$HOME/.profile` file:

```
. ~/.oracle
```

- c. Log out of the `oracle` user account.
- d. Log into the `oracle` user account for the changes to take effect.

7. If any Java packages are installed on the system, unset the Java environment variables, for example `JAVA_HOME`.

Note: Oracle recommends that you do not install any of the Java packages supplied with the SUSE Linux Enterprise Server distribution.

8. If you use Network Information Service (NIS):
 - a. Make sure that the following line exists in the `/etc/yp.conf` file:

```
hostname.domainname broadcast
```
 - b. Make sure that the following line exists in the `/etc/nsswitch.conf` file:

```
hosts: files nis dns
```
9. Make sure that the `localhost` entry in the `/etc/hosts` file is an IPv4 entry. If the IP entry for `localhost` is IPv6 format, installation cannot succeed. The following example shows an IPv6 entry:

```
prompt> special IPv6 addresses
::1          localhost ipv6-localhost ipv6-loopback
::1          ipv6-localhost ipv6-loopback
```

To correct this example `/etc/hosts` file, comment the `localhost` entry as follows:

```
prompt> special IPv6 addresses
prompt> ::1          localhost ipv6-localhost ipv6-loopback
::1          ipv6-localhost ipv6-loopback
```

To comment the entries, you can use the perl script included in the `utils/4015045/` directory of CD-ROM Disk 1 and in the `application_server/utils/4015045/` directory on the DVD-ROM. Run the script as the root user. This script is also available as patch 4015045. This patch is available from:

<http://metalink.oracle.com>

2.4 Set Shell Limits for the oracle User

The following table contains the recommended shell limits for the `oracle` user, depending on the user's default shell.

Bourne or Bash Shell Limit	Korn Shell Limit	C or tcsh Shell Limit	Hard Limit
<code>nofile</code>	<code>nofile</code>	<code>descriptors</code>	65536
<code>noproc</code>	<code>processes</code>	<code>maxproc</code>	16384

To increase the shell limits:

1. Add the following lines to `/etc/security/limits.conf` file:

```
*          soft  nproc      2047
*          hard  nproc      16384
*          soft  nofile     2048
*          hard  nofile     65536
```
2. Add the following line to the `/etc/pam.d/login` file, if it does not already exist:

```
session    required    /lib/security/pam_limits.so
```

3. Depending on the `oracle` user's default shell, make the following changes to the default shell start-up file:

- For the Bourne, Bash, or Korn shell, add the following lines to the `/etc/profile` file:

```
if [ $USER = "oracle" ]; then
    if [ $SHELL = "/bin/ksh" ]; then
        ulimit -p 16384
        ulimit -n 65536
    else
        ulimit -u 16384 -n 65536
    fi
fi
```

- For the C or tcsh shell, add the following lines to the `/etc/csh.login` file:

```
if ( $USER == "oracle" ) then
    limit maxproc 16384
    limit descriptors 65536
endif
```

2.5 Ports

Many Oracle Application Server components, such as Oracle HTTP Server, use ports. You can have the installer assign default port numbers, or use port numbers that you specify.

- [Section 2.5.1, "Checking If a Port Is in Use"](#)
- [Section 2.5.2, "Using Default Port Numbers"](#)
- [Section 2.5.3, "Using Custom Port Numbers \(the "Static Ports" Feature\)"](#)

Why the Default Port for Oracle HTTP Server Is Port 7777 and Not Port 80

By default, the installer configures Oracle HTTP Server to use port 7777, not port 80. Port 7777 is the default port because on UNIX, components that use port numbers lower than 1024 require additional steps to be done as the root user before the components can run. Because the installer does not have root access, it has to use a port greater than 1024.

If you want Oracle HTTP Server to use a different port, such as port 80, use the "static ports" feature, which enables you to specify port numbers for components. Although you can change the port number after installation, it is easier to set the port number during installation.

2.5.1 Checking If a Port Is in Use

To check if a port is being used, you can run the `netstat` command as follows:

```
prompt> netstat -an | grep portnum
```

2.5.2 Using Default Port Numbers

If you want to use the default port numbers for components, you do not have to do anything. See [Appendix B, "Default Port Numbers"](#) for a list of the default port

numbers and ranges. Make sure that at least one port is available in the port range for each component. If the installer is unable to find a free port in the range, the installation will fail.

2.5.3 Using Custom Port Numbers (the "Static Ports" Feature)

To instruct the installer to assign custom port numbers for components:

1. Create a file containing the component names and port numbers. [Section 2.5.3.1, "Format of the staticports.ini File"](#) describes the file format. This file is typically called the `staticports.ini` file, but you can name it anything you want.
2. In the installer, on the Specify Port Configuration Options screen, select **Manual** and enter the *full path* to the `staticports.ini` file.

If you do not specify the full path to the file, the installer will not be able to find the file. The installer will then assign default ports for all the components, and it will do this without displaying any warning.

2.5.3.1 Format of the staticports.ini File

The `staticports.ini` file has the following format. Replace *port_num* with the port number that you want to use for the component.

```
Oracle HTTP Server port = port_num
Oracle HTTP Server SSL port = port_num
Oracle Notification Server Request port = port_num
Oracle Notification Server Local port = port_num
Oracle Notification Server Remote port = port_num
ASG port = port_num
```

The easiest way to create the file is to use the `staticports.ini` file on the CD-ROM (Disk 1) or DVD-ROM as a template:

1. Copy the `staticports.ini` file from the CD-ROM or DVD-ROM to your hard disk.

Table 2–6 Location of the staticports.ini File on CD-ROM and DVD-ROM

Media	Location of staticports.ini File
CD-ROM	Disk 1: <code>mount_point/stage/Response/staticports.ini</code>
DVD-ROM	<code>mount_point/application_server/stage/Response/staticports.ini</code>

2. Edit the local copy (the file on the hard disk) to include the desired port numbers.

You do not need to specify port numbers for all components in the `staticports.ini` file. If a component is not listed in the file, the installer uses the default port number for that component.

The following example sets the Oracle HTTP Server ports and some Oracle Process Manager and Notification Server ports. For components not specified, the installer will assign the default port numbers.

```
Oracle HTTP Server port = 2000
Oracle HTTP Server SSL port = 2001
Oracle Notification Server Request port = 2002
Oracle Notification Server Local port = 2003
```

When installation is complete, you can run the following commands to see the assigned ports:

```
prompt> ORACLE_HOME/opmn/bin/opmnctl startall
prompt> ORACLE_HOME/opmn/bin/opmnctl status -l
```

Notes on Choosing Port Numbers:

- Port numbers cannot be greater than 65535.
 - If you use a port number less than 1024 for a component, you must run the component as the root user.
 - If you use a port number less than 1024 for a component, the installer will not be able to start up the component at the end of installation. You may need to configure the component first before you can start it up. See the appropriate component documentation for details.
 - If you plan to set port numbers for Oracle HTTP Server, be sure you read [Section 2.5.3.3, "Ports for Oracle HTTP Server"](#).
-
-

The installer verifies that the ports specified in the file are available by checking memory. This means that it can only detect ports that are being used by running processes. It does not look in configuration files to determine which ports an application is using.

If the installer detects that a specified port is not available, it displays an alert. The installer will not assign a port that is not available. To fix this:

1. Edit the `staticports.ini` file to specify a different port, or shut down the application that is using the port.
2. Click **Retry**. The installer re-reads the `staticports.ini` file and verifies the entries in the file again.

2.5.3.2 Error Conditions that Will Cause the Installer to Use Default Ports Instead of Specified Ports

Check your `staticports.ini` file carefully because a mistake can cause the installer to use default ports without displaying any warning. Here are some things that you should check:

- If you specify the same port for more than one component, the installer will use the specified port for the first component, but for the other components, it will use the components' default ports. The installer does not warn you if you have specified the same port for multiple components.
- If you specify different ports for one component on multiple lines, the installer assigns the default port for the component. The installer does not warn you if you have specified different ports for one component.
- If you specify the same port for one component on multiple lines, the installer assigns the default port for the component. The installer does not warn you if you have specified the same port on multiple lines.
- If you have syntax errors in the `staticports.ini` file (for example, if you omitted the `=` character for a line), the installer ignores the line. For the components specified on such lines, the installer assigns the default ports. The installer does not display a warning for lines with syntax errors.

- If you misspell a component name, the installer assigns the default port for the component. Names of components in the file are case sensitive. The installer does not display a warning for lines with unrecognized names.
- If you specify a non-numeric value for the port number, the installer ignores the line and assigns the default port number for the component. It does this without displaying any warning.
- If you specify a relative path to the `staticports.ini` file (for example, `./staticports.ini` or just `staticports.ini`), the installer will not find the file. The installer continues without displaying a warning and it will assign default ports to all components. You must specify a full path to the `staticports.ini` file.

2.5.3.3 Ports for Oracle HTTP Server

Be sure you understand the following when setting ports for this component.

In the `httpd.conf` file for Oracle HTTP Server, the `Port` and the `Listen` directives specify the ports used by Oracle HTTP Server (Figure 2-1). You must set both directives to use the same port number.

To set these ports, use the "Oracle HTTP Server port" and "Oracle HTTP Server Listen port" lines in the `staticports.ini` file. For example:

```
Oracle HTTP Server port = 8080
Oracle HTTP Server Listen port = 8080
```

To set the SSL version of these ports, use the following lines. As in the non-SSL version, the port numbers must be the same.

```
Oracle HTTP Server SSL port = 443
Oracle HTTP Server Listen (SSL) port = 443
```

Figure 2-1 Configuring Oracle HTTP Server

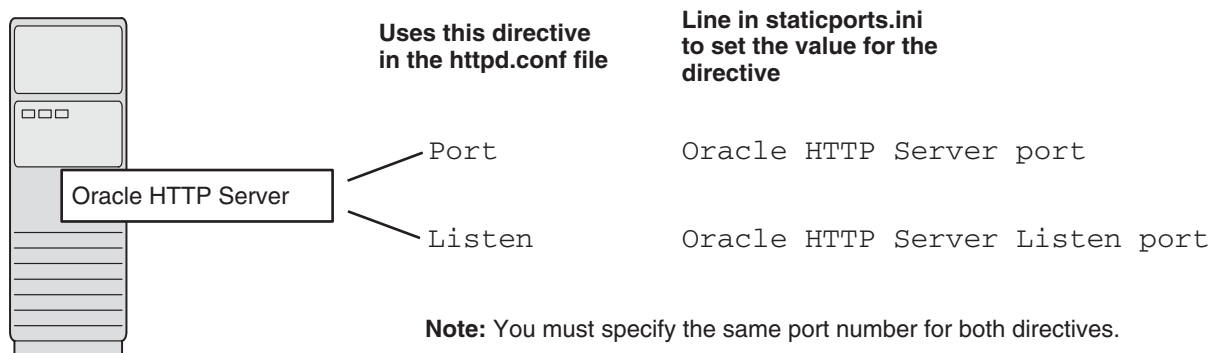

2.5.3.3.1 staticports.ini Example In this scenario, configure Oracle HTTP Server to use ports 80 and 443. Create a `staticports.ini` file that includes the following lines:

```
Oracle HTTP Server port = 80
Oracle HTTP Server Listen port = 80
Oracle HTTP Server SSL port = 443
Oracle HTTP Server Listen (SSL) port = 443
```

Note: Because you are using ports less than 1024, you have to configure Oracle HTTP Server to run as the root user. You can perform the configuration during installation or after installation.

- You can choose to perform the configuration after installation, but note that the installer will not be able to start up the components (because they are not yet configured).

For details, see the *Oracle HTTP Server Administrator's Guide*.

2.6 Operating System Groups

If you plan to install Oracle Application Server on a computer that does not have Oracle products, you need to create an operating system group to own the "inventory" directory. See [Section 2.6.1, "Create a Group for the Inventory Directory"](#).

To create a local operating system group:

Enter the following command to create the `oinstall` group:

```
# /usr/sbin/groupadd oinstall
```

For more information about operating system users and groups, see your operating system documentation or contact your system administrator.

2.6.1 Create a Group for the Inventory Directory

If you plan to install Oracle Application Server on a computer that does not have Oracle products, create a group to own the inventory directory. The installer writes its files in the inventory directory to keep track of the Oracle products installed on the computer.

This guide uses the name `oinstall` for this operating system group.

By having a separate group for the inventory directory, you allow different users to install Oracle products on the computer. Users need write permission for the inventory directory. They can achieve this by belonging to the `oinstall` group.

For the first time installation of any Oracle product on a computer, the installer displays a screen where you enter a group name for the inventory directory, and a screen where you enter the location of the inventory directory.

The default name of the inventory directory is `oraInventory`.

If you are unsure if there is already an inventory directory on the computer, look in the `/etc/oraInst.loc` file. This file lists the location of the inventory directory and the group who owns it. If the file does not exist, the computer does not have Oracle products installed on it.

2.7 Operating System User

Create an operating system user to install and upgrade Oracle products. This guide refers to this user as the `oracle` user. The `oracle` user running the installer must have write permission for these directories:

- the Oracle home directory, which contains files for the product you are installing
- the inventory directory, which is used by the installer for all Oracle products

If the computer contains other Oracle products, you might already have a user for this purpose. Look in the `/etc/oraInst.loc` file. This file lists the location of the inventory directory and the group who owns it. If the file does not exist, the computer does not have Oracle products installed on it.

If you do not already have a user for installing Oracle products, create a user with the following properties:

Table 2–7 Properties of the Operating System User Who Runs the Installer

Item	Description
Login name	You can use any name for the user. This guide refers to the user as the <code>oracle</code> user.
Group identifier	The primary group of the <code>oracle</code> user must have write permission for the <code>oraInventory</code> directory. See Section 2.6.1, "Create a Group for the Inventory Directory" for more information about this group. You can use any name for the group. This guide uses the name <code>oinstall</code> .
Home directory	The home directory for the <code>oracle</code> user can be consistent with the home directories of other users.
Login shell	The default login shell can be the C, Bourne, or Korn shell.

Note: Use the `oracle` user only for installing and running Oracle products. Do not use `root` as the `oracle` user.

To create a local operating system user:

1. To create the `oracle` user, enter a command similar to the following:

```
# /usr/sbin/useradd -g oinstall -G dba[,oper] oracle
```

In this command:

- The `-g` option specifies the primary group, which must be the Oracle Inventory group, for example `oinstall`
- The `-G` option specifies the secondary groups, which must include the OSDBA group and if required, the OSOPER group, for example `dba` or `dba,oper`

2. Set the password of the `oracle` user:

```
# passwd oracle
```

To check which groups an operating system user belongs to, run the `groups` command with the name of the user. For example:

```
prompt> groups oracle
```

For more information about operating system users and groups, see your operating system documentation or contact your system administrator.

2.8 Requirements for the Database

If you are performing a basic installation or an advanced installation of the J2EE Server, Web Server and SOA Suite install type, the database for SOA suite must be one of the following versions:

Table 2–8 Supported Database Versions

Database Series	Supported Versions
Oracle9i Release 2 (9.2.x)	9.2.0.7 or later
Oracle Database 10g Release 1 (10.1.x)	10.1.0.5 or later
Oracle Database Express Edition 10g Release 2 (10.2.x)	10.2.0.1
Oracle Database 10g Release 2 (10.2.x)	10.2.0.2 or later

To check the release of your database, query the `PRODUCT_COMPONENT_VERSION` view:

```
prompt> sqlplus "sys/password as sysdba"
SQL> select version from product_component_version where product like 'Oracle%9i%'
      or product like 'Oracle%Database%';
```

password specifies the password for the SYS user.

You must install the `ORABPEL`, `ORAESB`, and `ORAWSM` into your Oracle database before you begin the installation. See [Section 2.9, "Installing Database Schemas"](#) for more information on loading these schemas.

Note: You can use an Oracle Database that contains Oracle Application Server 10g Release 2 (10.1.2.0.2) Metadata Repository with the 10g Release 3 (10.1.3.1.0) installation. If OracleAS Metadata Repository is installed on your Oracle Database, you still must install the `ORABPEL`, `ORAESB`, and `ORAWSM` schemas.

2.9 Installing Database Schemas

If you are performing a basic installation or an advanced installation of the J2EE Server, Web Server and SOA Suite install type, you must install the `ORABPEL`, `ORAESB`, and `ORAWSM` schemas into your Oracle database before you begin the installation. To do so:

1. On Oracle Application Server Disk 1, go to the `install/soa_schemas/irca` directory.
2. Run the `irca.sh` script.

2.10 Environment Variables

The operating system user who will be installing Oracle Application Server needs to set (or unset) the following environment variables.

[Table 2–9](#) summarizes whether you set or unset an environment variable.

Table 2–9 Environment Variable Summary

Environment variable	Set or Unset
<code>PATH</code> , <code>CLASSPATH</code> , and <code>LD_LIBRARY_PATH</code>	Must not contain references to directories in any Oracle home directories
<code>DISPLAY</code>	Set it to the monitor where you want to the installer window to appear.
<code>TMP</code> and <code>TMPDIR</code>	Optional. If unset, defaults to <code>/tmp</code> .

Table 2–9 (Cont.) Environment Variable Summary

Environment variable	Set or Unset
ANT_HOME	Must not be set.
TNS_ADMIN	Must not be set.
ORA_NLS	Must not be set.
LD_BIND_NOW	Must not be set.

2.10.1 Environment Variable Tips

Here are some tips when working with environment variables:

- If you set environment variables in the `.profile` file, they might not be read. To ensure environment variables are set to the correct values, check their values in the shell where you will be running the installer.
- To check the value of environment variables, use the `env` command. This displays all the currently defined environment variables and their values.

```
% env
```

- If you use the `su` command to switch users (for example, switching from the root user to the `oracle` user), check the environment variables when you are the new user because the environment variables might not be passed to the new user. This can happen even if you run `su` with the `-` parameter (`su - user`).

```
# /* root user */
# su - oracle
% env
```

2.10.2 PATH, CLASSPATH, and LD_LIBRARY_PATH

Edit your `PATH`, `CLASSPATH`, and `LD_LIBRARY_PATH` environment variables so that they do not reference any Oracle home directories.

2.10.3 DISPLAY

Set the `DISPLAY` environment variable to point to the X server that will display the installer. The format of the `DISPLAY` environment variable is:

```
hostname:display_number.screen_number
```

Example (C shell):

```
% setenv DISPLAY test.mydomain.com:0.0
```

Example (Bourne or Korn shell):

```
$ DISPLAY=test.mydomain.com:0.0; export DISPLAY
```

You can test the display by running the `xclock` program:

```
$ xclock &
```

Oracle Application Server requires a running X server during installation only. The frame buffer X server installed with your operating system requires that you remain logged in and have the frame buffer running during installation. If you do not wish to

do this, then you must use a virtual frame buffer, such as X Virtual Frame Buffer (XVFB) or Virtual Network Computing (VNC).

Visit Oracle Technology Network (<http://www.oracle.com/technology>) for information about obtaining and installing XVFB or other virtual frame buffer solutions. Search OTN for "frame buffer".

2.10.4 TNS_ADMIN

This section describes two requirements:

- The TNS_ADMIN environment variable must not be set. If set, it can cause errors during installation.
- The /etc directory must not contain a tnsnames.ora file.

These requirements are necessary to prevent conflicts between the Net configuration files for different Oracle products.

If you need to set TNS_ADMIN or if you have the tnsnames.ora file in /etc, do the following steps before installing Oracle Application Server.

1. If you have the tnsnames.ora file in /etc, move the file from this directory to a different directory. Alternatively, you can rename the file.
2. Make sure the TNS_ADMIN environment variable is not set.

Example (C shell):

```
% unsetenv TNS_ADMIN
```

Example (Bourne or Korn shell):

```
$ unset TNS_ADMIN
```

After installation, you can merge the contents of the newly created tnsnames.ora file with your existing tnsnames.ora file.

2.10.5 TMP and TMPDIR

The installer uses a temporary directory for swap space. The installer checks for the TMP and TMPDIR environment variables to locate the temporary directory. If this environment variable does not exist, the installer uses the /tmp directory.

If you want the installer to use a temporary directory other than /tmp, set the TMP and TMPDIR environment variables to the full path of an alternate directory. The oracle user must have right permission for this directory and the directory must meet the requirements listed in [Table 2-2](#).

Example (C shell):

```
% setenv TMP /tmp2  
% setenv TMPDIR /tmp2
```

Example (Bourne or Korn shell):

```
$ TMP=/tmp2; export TMP  
$ TMPDIR=/tmp2; export TMPDIR
```

If you do not set this environment variable, and the default directory does not have enough space, then the installer displays an error message that says the environment variable is not set. You can either set the environment variable to point to a different

directory or free up enough space in the default directory. In either case, you have to restart the installation.

2.10.6 ANT_HOME

To make sure that the Oracle Application Server installation completes successfully, unset this environment variable.

Example:

```
% unset ANT_HOME
```

Additionally, you must either remove the `/etc/ant.conf` file or comment out the line in the `/etc/ant.conf` file that incorrectly sets the `ANT_HOME` environmental variable.

2.10.7 ORA_NLS

To make sure that the Oracle Application Server installation completes successfully, unset this environment variable.

Example:

```
$ unset ORA_NLS
```

2.10.8 LD_BIND_NOW

To make sure that the Oracle Application Server installation completes successfully, unset this environment variable.

Example:

```
$ unset LD_BIND_NOW
```

2.11 Network Topics

Typically, the computer on which you want to install Oracle Application Server is connected to the network, has local storage to contain the Oracle Application Server installation, has a display monitor, and has a CD-ROM or DVD-ROM drive.

This section describes how to install Oracle Application Server on computers that do not meet the typical scenario. It covers the following cases:

- [Section 2.11.1, "Installing on a DHCP Host"](#)
- [Section 2.11.2, "Installing on Multihomed \(Multi-IP\) Computers"](#)
- [Section 2.11.3, "Copying CD-ROMs or DVD-ROM to Hard Drive, and Installing from the Hard Drive"](#)
- [Section 2.11.4, "Installing from a Remote CD-ROM or DVD-ROM Drive"](#)
- [Section 2.11.5, "Installing on Remote Computers"](#)

2.11.1 Installing on a DHCP Host

If you are installing Oracle Application Server in a DHCP network you must use a loopback configuration. To access the Oracle Application Server, you need to use a local browser. Perform the following steps to install Oracle Application Server in a DHCP network:

1. Find the IP address allocated from the DHCP server by running the following command:

```
$ /sbin/ifconfig -a
```

The IP address is associated with the interface configured to use DHCP.

2. Configure the host to resolve hostname to loopback IP address:
 - a. Configure the host to resolve hostname to loopback IP address, by modifying the `/etc/hosts` file to contain the following entries:

```
127.0.0.1 hostname.domainname hostname
127.0.0.1 localhost.localdomain localhost
```

- b. Check that the hostname resolves to the loopback IP address by entering the following command:

```
$ /bin/ping hostname.domainname
```

3. Complete the Oracle Application Server installation as described in this guide using the hostname used in step 2.

2.11.2 Installing on Multihomed (Multi-IP) Computers

You can install Oracle Application Server on a multihomed computer. A multihomed computer is associated with multiple IP addresses. This is typically achieved by having multiple network cards on the computer. Each IP address is associated with a hostname; additionally, you can set up aliases for the hostname. By default, Oracle Universal Installer uses the `ORACLE_HOSTNAME` environment variable setting to find the hostname. If `ORACLE_HOSTNAME` is not set and you are installing on a computer that has multiple network cards, Oracle Universal Installer determines the hostname by using the first name in the `/etc/hosts` file.

Clients must be able to access the computer using this hostname (or using aliases for this hostname). To check, ping the hostname from the client computers using the short name (hostname only) and the full name (hostname and domain name). Both must work.

2.11.3 Copying CD-ROMs or DVD-ROM to Hard Drive, and Installing from the Hard Drive

Instead of installing from the Oracle Application Server CD-ROMs or DVD-ROM, you can copy the contents of the CD-ROMs or DVD-ROM to a hard drive and install from there. This might be easier if you plan to install many instances of Oracle Application Server on your network, or if the computers where you want to install Oracle Application Server do not have CD-ROM or DVD-ROM drives.

(You can install from remote CD-ROM or DVD-ROM drives; see [Section 2.11.4, "Installing from a Remote CD-ROM or DVD-ROM Drive"](#).)

When you install from the hard drive, the installer does not prompt you to swap CD-ROMs. It can find all the files if they are in the proper locations (see [Figure 2-2](#)).

Space Requirement

Ensure that the hard drive contains enough space to hold the contents of the CD-ROMs or the `application_server` directory on the DVD-ROM. Each CD-ROM contains approximately 650 MB. This means that if you are copying three CD-ROMs, you need approximately 1.9 GB of disk space.

On the DVD-ROM, the `application_server` directory is approximately 1.6 GB.

This space is in addition to the space required for installing Oracle Application Server (listed in [Table 2-2](#)).

To Copy the CD-ROMs:

1. Create a directory structure on your hard drive as shown in [Figure 2-2](#).

You need to create a parent directory (called `OracleAS_10g` in the example, but you can name it anything you like), and, under the parent directory, create subdirectories called `Disk1`, `Disk2`, and so on. The names of the subdirectories must be `DiskN`, where *N* is the CD-ROM number.

Figure 2-2 Directory Structure for Copying CD-ROMs to Disk

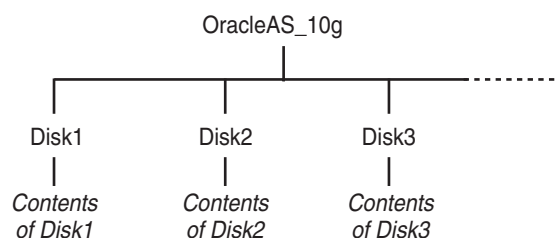

2. Copy the contents of each CD-ROM into the corresponding directory.

```

prompt> cp -pr /cdrom_mount_point/10.1.3disk1/* /path/to/hard/drive/Disk1/
prompt> cp -pr /cdrom_mount_point/10.1.3disk2/* /path/to/hard/drive/Disk2/
... Repeat for each CD-ROM.

```

To run the installer from the copied files, invoke the `runInstaller` executable from the `Disk1` directory. Run it from the computer that will be running Oracle Application Server.

```
prompt> /path/to/hard/drive/Disk1/runInstaller
```

To Copy the application_server Directory from the DVD-ROM

1. (optional) Create a directory to contain the `application_server` directory.
2. Copy the `application_server` directory from the DVD-ROM to your hard disk.

```
prompt> cp -pr /dvd_mount_point/application_server /path/to/hard/drive
```

To run the installer from the copied files, invoke the `runInstaller` executable from the computer that will be running Oracle Application Server:

```
prompt> /path/to/hard/drive/application_server/runInstaller
```

2.11.4 Installing from a Remote CD-ROM or DVD-ROM Drive

You can run the installer on a remote computer ("remote_computer"), but have the installer screens display on your local computer ("local_computer"). The installer will install Oracle Application Server on the remote computer.

1. Allow `remote_computer` to display on `local_computer`. You need to run this command on the local computer's console.

```
local_computer> xhost +remote_computer
```

If you do not run `xhost`, you might get an Xlib error similar to "Failed to connect to server", "Connection refused by server," or "Can't open display" when starting the installer.

2. On `local_computer`, perform a remote login (using `telnet` or `rlogin`) to `remote_computer`. Log in as the `oracle` user, as described in [Section 2.7, "Operating System User"](#). Ensure that the user has set the environment variables correctly, as described in [Section 2.10, "Environment Variables"](#).

```
local_computer> rlogin -l oracle remote_computer.mydomain.com
- OR -
local_computer> telnet remote_computer.mydomain.com
```

3. Set the `DISPLAY` environment variable on `remote_computer` to point to `local_computer`.

Example (C shell):

```
remote_computer> setenv DISPLAY local_computer.mydomain.com:0.0
```

Example (Bourne or Korn shell):

```
remote_computer> DISPLAY=local_computer.mydomain.com:0.0; export DISPLAY
```

4. Run the installer. See [Section 3.12, "Starting the Oracle Universal Installer"](#).

Note: You can use a PC X emulator to run the installer if it supports a `PseudoColor` color model or `PseudoColor` visual. Set the PC X emulator to use a `PseudoColor` visual, and then start the installer. Refer to the X emulator documentation for instructions on how to change the color model or visual settings.

2.11.5 Installing on Remote Computers

You can run the installer on a remote computer ("`remote_computer`"), but have the installer screens display on your local computer ("`local_computer`"). The installer will install Oracle Application Server on the remote computer.

1. Allow `remote_computer` to display on `local_computer`. You need to run this command on the local computer's console.

```
local_computer> xhost +remote_computer
```

If you do not run `xhost`, you might get an Xlib error similar to "Failed to connect to server", "Connection refused by server," or "Can't open display" when starting the installer.

2. On `local_computer`, perform a remote login (using `telnet` or `rlogin`) to `remote_computer`. Log in as the `oracle` user, as described in [Section 2.7, "Operating System User"](#). Ensure that the user has set the environment variables correctly, as described in [Section 2.10, "Environment Variables"](#).

```
local_computer> rlogin -l oracle remote_computer.mydomain.com
- OR -
local_computer> telnet remote_computer.mydomain.com
```

3. Set the `DISPLAY` environment variable on `remote_computer` to point to `local_computer`.

Example (C shell):

```
remote_computer> setenv DISPLAY local_computer.mydomain.com:0.0
```

Example (Bourne or Korn shell):

```
remote_computer> DISPLAY=local_computer.mydomain.com:0.0; export DISPLAY
```

4. Run the installer. See [Section 3.12, "Starting the Oracle Universal Installer"](#).

Note: You can use a PC X emulator to run the installer if it supports a PseudoColor color model or PseudoColor visual. Set the PC X emulator to use a PseudoColor visual, and then start the installer. Refer to the X emulator documentation for instructions on how to change the color model or visual settings.

2.11.6 Installing on NFS-Mounted Storage

To run Oracle Application Server on NFS systems, you have to use a certified NFS-mounted storage system.

Currently Oracle Application Server is certified to run on these NFS systems:

- Network Appliance (NetApp) filers

The NetApp system should be exported to at least the remote install user and remote root user. You can do this using `exportfs` command:

```
prompt> exportfs -i /vol/vol1
```

Before installing, verify that the NFS mount `setuid` permission is set to `suid`. The `nosuid` option will cause the install to fail.

To check the latest certification list for any updates, visit Oracle Technology Network (<http://www.oracle.com/technology>).

2.11.7 Running Multiple Instances from One Installation

Oracle Application Server components are intended to be run only on the computer where they are installed. You cannot run the components on remote computers, even though the computers can access the files through NFS.

Figure 2–3 Run Oracle Application Server Only on the Computer Where It Is Installed

Computer A

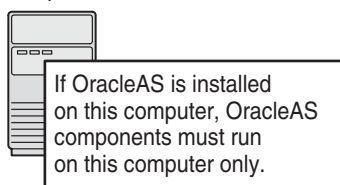

Although other computers can access OracleAS files installed on Computer A, they should not run OracleAS components from that installation. For a computer to run OracleAS components, it must have its own OracleAS installation.

2.11.8 Support for NIS and NIS+

You can install and run Oracle Application Server in NIS and NIS+ environments.

2.12 Prerequisite Checks Performed by the Installer

Table 2–10 lists the checks performed by the installer:

Table 2–10 Prerequisite Checks Performed by the Installer

Item	Description
Processor	See Table 2–2 for recommended values.
Operating system version	See Section 2.3, "Software Requirements" for supported versions.
Operating system patches	See Section 2.3, "Software Requirements" for a list of required patches.
Software packages	See Section 2.3, "Software Requirements" for a list of required packages.
Memory	See Table 2–2 for recommended values.
Swap space	See Table 2–2 for recommended values.
TMP space	See Table 2–2 for recommended values.
Instance name	The installer checks that the computer on which you are installing Oracle Application Server does not already have an instance of the same name.
Oracle home directory name	The installer checks that the Oracle home directory name does not contain any spaces.
Path to Oracle home directory	The installer checks that the path to the Oracle home directory is not longer than 127 characters.
Oracle home directory contents	The installer checks that the Oracle home directory does not contain any files that might interfere with the installation.
Oracle home directory	<p>You should install Oracle Application Server in a new directory. Here are some examples of installations that are not allowed:</p> <ul style="list-style-type: none"> ▪ Oracle Application Server into an 8.0, 8i, 9.0.1, 9.2, or 10g database Oracle home ▪ Oracle Application Server into an Oracle Management Service Oracle home ▪ Oracle Application Server into an Oracle Collaboration Suite Oracle home ▪ Oracle Application Server into an Oracle HTTP Server standalone Oracle home ▪ Oracle Application Server into an Oracle Web Cache standalone Oracle home ▪ Oracle Application Server into an Oracle⁹ⁱ Developer Suite 9.0.2 or Oracle Developer Suite 10g Release 2 (10.1.2) Oracle home ▪ Oracle Application Server into an Oracle Containers for J2EE standalone Oracle home ▪ Oracle Application Server into an Oracle⁹ⁱAS 1.0.2.2 Oracle home ▪ Oracle Application Server into an infrastructure 9.0.2, 9.0.4, 10g Release 2 (10.1.2), or 10g (10.1.4.0.1) Oracle home ▪ Oracle Application Server into an Oracle⁹ⁱAS 9.0.2, 9.0.3, 9.0.4, 10g Release 2 (10.1.2), or 10g Release 3 (10.1.3.0.0) middle tier Oracle home ▪ Oracle Application Server into an Oracle home installed from the Oracle Business Intelligence 10g (10.1.2.0.2) CD-ROM.
Static port conflicts	The installer checks the ports listed in the <code>staticports.ini</code> file, if specified. See Section 2.5, "Ports".
Monitor	The installer checks that the monitor is configured to display at least 256 colors.
Display permission	The installer checks that the user has permissions to display on the monitor specified by the DISPLAY environment variable.
DISPLAY environment variable	The installer checks that the DISPLAY environment variable is set.

Table 2–10 (Cont.) Prerequisite Checks Performed by the Installer

Item	Description
TNS_ADMIN environment variable	The TNS_ADMIN environment variable must not be set. There must not be a <code>tnsnames.ora</code> file in the <code>/etc</code> directory.
Cluster file system	The installer checks that you are not installing Oracle Application Server in a cluster file system (CFS).
glibc version check on Linux	The installer runs this check only if you are installing on Linux. The installer makes sure that the glibc version is glibc-2.3.2-95.27 or higher on Red Hat Enterprise Linux AS/ES 3.0, glibc-2.3.4-2.9 or higher on Red Hat Enterprise Linux AS/ES 4.0, and glibc-2.3.3-98.28 or higher on SUSE Linux Enterprise Server 9.
Packages check on Linux	The installer runs this check only if you are installing on Linux. The installer makes sure that the mandatory packages are installed. For example, it checks the <code>gcc</code> , <code>sysstat</code> and <code>openmotif</code> packages as specified in Table 2–3 for Red Hat Enterprise Linux AS/ES 3.0, Table 2–4 for Red Hat Enterprise Linux AS/ES 4.0, and Table 2–5 for SUSE Linux Enterprise Server 9.

Things You Should Know Before Starting the Installation

Contents:

- Section 3.1, "Oracle Home Directory"
- Section 3.2, "First-Time Installation of Any Oracle Product"
- Section 3.3, "Installing Additional Languages"
- Section 3.4, "Oracle Application Server Instances and Instance Names"
- Section 3.5, "The oc4jadmin User and Restrictions on its Password"
- Section 3.6, "Where Does the Installer Write Files?"
- Section 3.7, "Why Do I Need to be Able to Log In as Root at Certain Times During Installation?"
- Section 3.8, "Running root.sh During Installation"
- Section 3.9, "Rules for Adding Instances to OracleAS Clusters"
- Section 3.10, "Obtaining Software from Oracle E-Delivery"
- Section 3.11, "Setting the Mount Point for the CD-ROM or DVD-ROM"
- Section 3.12, "Starting the Oracle Universal Installer"

3.1 Oracle Home Directory

The directory in which you install Oracle Application Server is called the Oracle home. During installation, you specify the full path to this directory.

For example, you can install Oracle Containers for J2EE in `/opt/oracle/OraHome_oc4j`.

Notes: Spaces are not allowed anywhere in the Oracle home directory path. For example, you cannot install in `/opt/oracle/app server/OC4J` because of the space character in "app server".

3.1.1 Naming Your Oracle Home

Each Oracle home directory is automatically given a name. The Oracle home name is `oracleasx`, where `x` is a number that depends on how many Oracle Application Server installations are on the system.

For example, if you are performing your first installation of Oracle Application Server on this system, then your Oracle home is named `oracleas1`.

If you deinstall Oracle Application Server, you will need to know the Oracle home name.

3.1.2 Installing in an Existing Oracle Home

Generally, you cannot install Oracle Application Server in an existing Oracle home. See ["Oracle home directory"](#) on page 2-28 for a list of combinations that are not allowed.

3.1.3 Installing in a Non-Empty Oracle Home

You cannot install Oracle Application Server in a directory that already contains some files, except for the cases mentioned in [Section 3.1.2, "Installing in an Existing Oracle Home"](#). For example, if you cancel an installation, or if an installation failed, you have to clean up the directory before you can reinstall Oracle Application Server in it. Also, the installer cannot "repair" an installation.

3.2 First-Time Installation of Any Oracle Product

If Oracle Application Server is the first Oracle product to be installed on a computer, the installer displays a screen where you specify an "inventory" directory (also called the "oraInventory" directory). This inventory directory is used by the installer to keep track of all Oracle products installed on the computer.

The inventory directory is separate from the Oracle home directory for Oracle Application Server.

To ensure other users in the `oinstall` group have access to the inventory directory (so that they can install Oracle products), do not use the `oracle` user's home directory as the inventory directory because home directories might not have the proper permissions set up for the `oinstall` group. Instead, you can put the inventory directory in the `/opt/oracle` directory (for example, `/opt/oracle/oraInventory`).

If you have installed an Oracle product previously on the computer, the installer uses the existing inventory directory. Ensure that you have write permissions on that directory. The best way of ensuring this is to run the installer as the same operating system user who installed the existing Oracle products.

Oracle recommends creating an operating system user to perform all tasks related to installation of Oracle products. See [Section 2.7, "Operating System User"](#).

3.3 Installing Additional Languages

By default, the installer installs Oracle Application Server with text in English and in the operating system language. If you need additional languages, you must perform an advanced installation and click the **Product Languages** button in the "Select Installation Type" screen.

When you select additional languages to install, the installer installs text in the selected languages. It also installs fonts required to display the languages.

For some components, languages are installed only if you select them during installation. In this case, if you access the application in a language that is not available, it will fall back on the server locale language.

For other components, available languages are installed regardless of what you select during installation. In this case, however, fonts are installed only for the languages that are explicitly selected. When you access the application, it uses text in your language because the language was installed. However, if you do not have the appropriate fonts to render the text, the text appears as square boxes. This usually applies to the Chinese, Japanese, and Korean languages.

You can install fonts after installation. See [Section E.3.6, "User Interface Does Not Display in the Desired Language, or Does Not Display Properly"](#).

Note that you cannot install additional languages after installation. You must install all languages that you need during installation. If you run Oracle Application Server in an environment that uses a language that you did not install, the user interface can display text in that language and/or in English, or it can display square boxes (caused by missing fonts) instead of text.

3.4 Oracle Application Server Instances and Instance Names

When you install the middle tier, what you get is an Oracle Application Server instance. The installer prompts you to provide a name for the Oracle Application Server instance you are installing. For example, you can name an instance "J2EE". This name can be different from the Oracle home name.

You cannot change this name after installation.

Oracle Application Server appends the hostname and domain name to the given instance name to form a complete instance name. For example, if you are installing an instance on a computer named `c1`, and you name the instance `Oc4j1`, then the full name of the instance is `Oc4j1.c1.mydomain.com`, assuming the domain name is `mydomain.com`.

Valid Characters in Instance Names

Instance names can consist only of the alphanumeric characters (A-Z, a-z, 0-9) and the `_` (underscore) character.

The maximum length for an instance name is 63 characters.

Restrictions on Oracle Application Server Instance Names

Do not use the hostname of the computer when naming Oracle Application Server instances.

If you are planning to place the Oracle Application Server instance in an OracleAS Cluster, the instance name must not contain the following:

- hostname or IP address of any computer in the OracleAS Cluster
- Oracle home of any Oracle Application Server installation in the OracleAS Cluster

How Oracle Application Server Uses Instance Names

Instance names are important because Oracle Application Server uses them to uniquely identify instances. This means that if you install multiple Oracle Application Server instances on the same computer, you must give them different names.

When you administer Oracle Application Server using Oracle Enterprise Manager 10g Application Server Control (or Application Server Control for short), the instance name appears on the screens. You can click the instance name to see details about the instance, such as the components that are installed in that instance, if the components are running or stopped, and the log files for the components. The Application Server

Control is a browser-based administration tool for Oracle Application Server. See the *Oracle Application Server Administrator's Guide* for details about this administration tool.

3.5 The oc4jadmin User and Restrictions on its Password

If you select one of the following installation types, the installer prompts you to specify the password for the oc4jadmin user:

- Basic Installation
- Advanced Installation: J2EE Server, Web Server and SOA Suite
- Advanced Installation: J2EE Server and Web Server
- Advanced Installation: J2EE Server

The oc4jadmin user is the administrative user for Oracle Application Server instances. To manage Oracle Application Server instances using Application Server Control, you log in as oc4jadmin.

On a computer, you can install multiple Oracle Application Server instances, each with its own unique instance name, but the name of the administrative user is oc4jadmin for all instances. The password for the oc4jadmin user can be different for each instance.

Password for the oc4jadmin User

The password for the oc4jadmin user has these restrictions:

- The minimum length is 5 characters.
- The maximum length is 30 characters.
- At least one of the characters must be a number.
- Passwords can contain only alphanumeric characters from your database character set, the underscore (_), the dollar sign (\$), and the number sign (#).
- Passwords must begin with an alphabetic character. Passwords cannot begin with a number, the underscore (_), the dollar sign (\$), or the number sign (#).
- Passwords cannot be Oracle reserved words. The *Oracle Database SQL Reference* lists the reserved words. You can find this guide on Oracle Technology Network (<http://www.oracle.com/technology/documentation>). Or you can just avoid using words that sound like they might be reserved words.

Note: When entering your password, check that the state of the Caps Lock key is what you want it to be. Passwords are case-sensitive.

You must remember the password because you need to enter it to perform the following task:

- When you log on to Application Server Control to manage Oracle Application Server, you log on as the oc4jadmin user.

If you forget the password, you can reset it. See the *Oracle Application Server Administrator's Guide* for details.

Note: If you intend to register your installation with Oracle Internet Directory after you finish installing, the password for the `oc4jadmin` user must conform to Oracle Internet Directory's password policy. Check with your Oracle Internet Directory administrator to verify the password policy.

3.6 Where Does the Installer Write Files?

The installer writes files to the following directories:

Table 3–1 Directories Where the Installer Writes Files

Directory	Description
Oracle home directory	This directory contains Oracle Application Server files. You specify this directory when you install Oracle Application Server.
Inventory directory	When you install the first Oracle product on a computer, you specify this directory, which the installer uses to keep track of which Oracle products are installed on the computer. In subsequent installations, the installer uses the same inventory directory.
/etc directory	This directory contains information on locations of Oracle homes on the computer. If you installed Oracle9iAS Release 2 (9.0.2) on your computer, this directory also contains files that provide information for Oracle Enterprise Manager 10g.
/tmp directory	The installer writes files needed only during installation to a "temporary" directory. By default, the "temporary" directory is <code>/tmp</code> . To specify a different directory, set the <code>TMP</code> and <code>TMPDIR</code> environment variables. See Section 2.10.5, "TMP and TMPDIR" for details.

3.7 Why Do I Need to be Able to Log In as Root at Certain Times During Installation?

At least once during installation, the installer prompts you to log in as the root user and run a script. You need to be root because the script edits files in the `/etc` directory.

3.8 Running root.sh During Installation

The installer prompts you to run the `root.sh` script in a separate window. This script creates files in the local bin directory (`/usr/local/bin`, by default).

If the script finds files of the same name, it prompts you if you want to override the existing files. You should back up these files (you can do this from another window), then overwrite them.

The following lines show the prompts from the `root.sh` script. The default values are enclosed in square brackets.

```
Enter the full pathname of the local bin directory: [/usr/local/bin]:
The file "dbhome" already exists in /usr/local/bin. Overwrite it? (y/n)[n]: y
Copying dbhome to /usr/local/bin ...
```

```
The file "oraenv" already exists in /usr/local/bin. Overwrite it? (y/n)[n]: y
Copying oraenv to /usr/local/bin ...
The file "coraenv" already exists in /usr/local/bin. Overwrite it? (y/n)[n]: y
Copying coraenv to /usr/local/bin ...
```

3.9 Rules for Adding Instances to OracleAS Clusters

Instances that are added to OracleAS Clusters are subject to the following operating system restrictions:

- Instances in an OracleAS Cluster must be of the same installation type and version and reside on a like operating system (Solaris, Linux, and HP-UX are like operating systems).

3.10 Obtaining Software from Oracle E-Delivery

You can obtain Oracle products from Oracle E-Delivery at <http://edelivery.oracle.com/>. Oracle products are distributed as "E-Packs". An E-Pack is an electronic version of the software that is also available to Oracle Customers on CD-ROM or DVD-ROM.

3.10.1 Finding and Downloading the Oracle Application Server 10g Release 3 (10.1.3.1.0) E-Pack

Refer to the CD/Media Pack description or the list of products that you purchased on your Oracle Ordering Document. Then, view the License List to help you decide which Product Pack you need to select in order to search for the appropriate E-Pack(s) to download. Prior to downloading, verify that the product you are looking for is in the License and Options section of the E-Pack README. Oracle recommends that you print the README for reference.

3.10.2 Finding Required and Optional Downloads

Refer to the README link that is on each E-Pack Download page. In addition to listing the licensable products and options contained in the pack, the README lists downloadable files that are required to run each product and which downloadable files are optional. Oracle recommends that you print the README for reference.

3.10.3 Disk Space Requirements

In addition to having the required disk space necessary to install and run your Oracle software, you'll need to have sufficient disk space to download all the required software files and have enough disk space to extract them.

After extracting the software from the Zip files, you can burn them onto CD-ROM and install from them, or install from your computer's hard drive.

3.10.4 Software Requirements for Unzipping Files

All Oracle E-Delivery files have been archived using Info-ZIP's highly portable Zip utility. After downloading one or more of the archives, you will need the UnZip utility to extract the files. You must unzip the archive on the platform for which it was intended. For example, if you download the file for the Solaris Operating System (SPARC) version of Oracle Application Server, you must unzip the file on a Solaris Operating System (SPARC) computer. If you unzip the file on a Windows computer,

and then move the stage area to a Solaris Operating System (SPARC) machine, the stage area files will be corrupted because Windows will not preserve the case sensitivity or the permission bits of UNIX file names.

3.10.5 Extracting Software from the Zip Files

Verify that the file size of your downloaded file matches the file size displayed on E-Delivery. Unzip each Zip file to its own temporary directory. For example, create a directory structure called oraAS10g on your hard drive:

```
c:\oraAS10g
```

Then create a new directory for each Zip file you downloaded:

```
c:\oraAS10g\Disk1
```

```
c:\oraAS10g\Disk2
```

etc.

If you plan burn the files on a CD-ROM, create a separate CD-ROM from the contents of each directory. Do not burn a CD-ROM containing the Zip file itself; you need the unzipped contents of the Zip files to do the installation. When you burn the files to CD-ROM, the contents of each disc must be at the root of the CD image.

To install from CD-ROM or from your hard drive, see [Section 3.12, "Starting the Oracle Universal Installer"](#).

3.11 Setting the Mount Point for the CD-ROM or DVD-ROM

The Oracle Application Server CD-ROMs are in RockRidge format. The DVD-ROM is in DVD-ROM format.

On most Linux systems, the disk mounts automatically when you insert it into the disk drive. To mount the first disk, follow these steps:

1. Insert Oracle Application Server disk 1 into the disk drive.
2. To verify that the disk mounted automatically, run the following command:
 - Red Hat:

```
# ls /mnt/cdrom
```
 - SUSE Linux Enterprise Server:

```
# ls /media/cdrom
```
3. If the command in step 2 fails to display the contents of the disk, run the following command:
 - Red Hat:

```
# mount -t iso9660 /dev/cdrom /mnt/cdrom
```
 - SUSE Linux Enterprise Server:

```
# mount -t iso9660 /dev/cdrom /media/cdrom
```

3.12 Starting the Oracle Universal Installer

1. If your computer does not mount CD-ROMs or DVDs automatically, you need to set the mount point manually. See [Section 3.11, "Setting the Mount Point for the CD-ROM or DVD-ROM"](#) for details.
2. Log in as the `oracle` user.
3. CD-ROM users: Insert Oracle Application Server Disk 1 into the CD-ROM drive.
DVD-ROM users: Insert the Oracle Application Server DVD-ROM into the DVD-ROM drive.
4. Run the Oracle Universal Installer using the command shown after the notes:

Notes:

- Be sure you are not logged in as the root user when you start the Oracle Universal Installer. The installer gives an error message if you try to run it as the root user.
 - Do not start the installation inside the `mount_point` directory. If you do, then you may not be able to eject the installation disk. The `cd` command below changes your current directory to your home directory.
-
-

CD-ROM:

```
prompt> cd
prompt> mount_point/10.1.3.1disk1/runInstaller
```

DVD-ROM:

```
prompt> cd
prompt> mount_point/application_server/runInstaller
```

This launches Oracle Universal Installer, through which you install Oracle Application Server.

Basic Installation

This chapter describes how to perform a basic installation of Oracle Application Server. The following topics are covered:

- [Section 4.1, "What Components Are Installed?"](#)
- [Section 4.2, "Basic Installation Steps"](#)
- [Section 4.3, "What Should I Do Next?"](#)

4.1 What Components Are Installed?

During the Basic Installation, you must install all of the following components. If you do not want to install all of the following components or you want to install Oracle HTTP Server, see [Chapter 5, "Advanced Installation"](#).

The following components are installed during the Basic Installation:

- Oracle Containers for J2EE
This component provides a complete Java 2 Enterprise Edition (J2EE) environment for developing Java applications.
- Oracle SOA Suite
This component provides Oracle SOA Suite, which enables services to be created, managed, and orchestrated into composite applications and business processes. Oracle SOA Suite includes Oracle BPEL Process Manager, Oracle Enterprise Service Bus (ESB), Oracle Web Services Manager (OWSM), and Oracle Business Rules.
- Oracle Enterprise Manager 10g Application Server Control
This component is used for Web-based management of Oracle Application Server.
- Oracle Process Manager and Notification Server
This component provides process control and monitoring for Oracle Application Server instances and their components.
- OC4J Java Single Sign-On
This component allows users to log in to all SSO-based applications with a single username and password.

4.2 Basic Installation Steps

This section describes the procedure for the basic installation of Oracle Application Server. It contains the following topics:

- [Section 4.2.1, "Before You Begin"](#)
- [Section 4.2.2, "Installation Steps"](#)

4.2.1 Before You Begin

Before you begin installing Oracle Application Server, ensure that you have read both [Chapter 2, "Requirements"](#) and [Chapter 3, "Things You Should Know Before Starting the Installation"](#). These chapters contain important information with which you must be familiar before you begin the installation so you can avoid potential problems during the installation.

Note that you must perform the steps in [Section 2.9, "Installing Database Schemas"](#) before beginning the installation.

4.2.2 Installation Steps

To install Oracle Application Server with a basic installation, perform the following steps:

1. Start Oracle Universal Installer.

For more information, refer to [Section 3.12, "Starting the Oracle Universal Installer"](#).

2. Oracle Application Server SOA Suite 10.1.3.1.0 Installation Screen

Figure 4–1 Oracle Application Server SOA Suite 10.1.3.1.0 Installation Screen

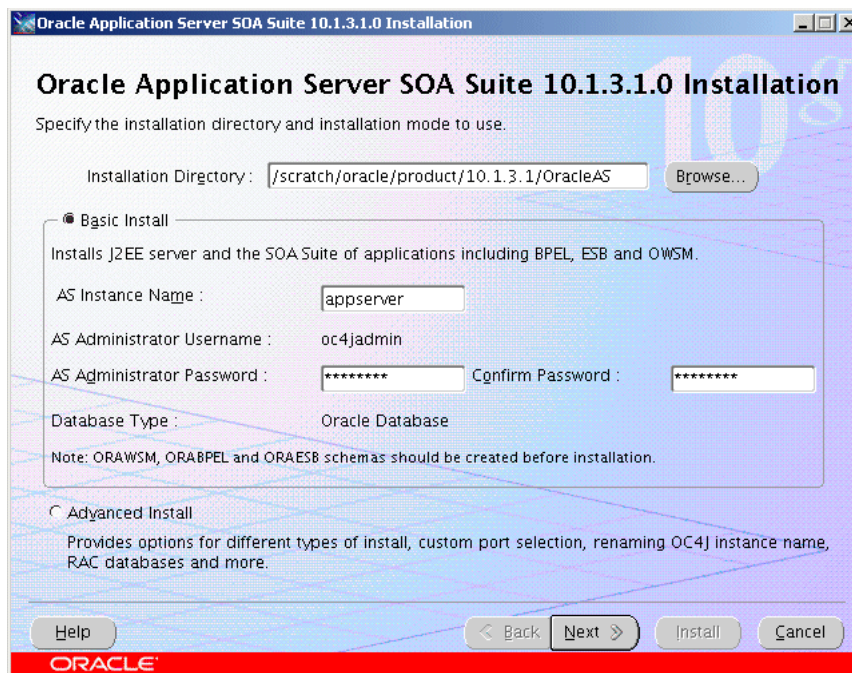

Installation Directory: Enter the directory where you want install Oracle Application Server.

Select **Basic Install**.

AS Instance Name: The instance name identifies this Oracle Application Server instance. If you have more than one Oracle Application Server instance on the same host, the instances must have unique names.

AS Administration Username: The administration username for Oracle Application Server instances is set to `oc4jadmin` and cannot be changed. To manage Oracle Application Server instances using Oracle Enterprise Manager 10g, log in as the `oc4jadmin` user.

AS Administration Password and Confirm Password: Enter the password for the `oc4jadmin` user.

Database Type: You must use an Oracle Database in the basic installation. If you want to use a Real Application Clusters database, you must perform an advanced installation. The Oracle Database must have the `ORABPEL`, `ORAESB`, and `ORAWSM` schemas installed. See [Section 2.9, "Installing Database Schemas"](#) for more information.

Click **Next**.

3. Oracle Application Server SOA Suite 10.1.3.1.0 Installation Screen ([Figure 4-2](#).)

Figure 4-2 Oracle Application Server SOA Suite 10.1.3.1.0 Installation Screen

Database Connect Information: Specify the hostname, port, and service name for the database. Use the format *hostname:port:service name*.

User with DBA Privileges: Specify the login name for the DBA user.

Database User Password: Enter the password for the user specified in the **User with DBA Privileges** field.

ORABPEL Schema Password: Enter the password for the `ORABPEL` schema in the database specified in the **Database Connect Information** field.

ORAESB Schema Password: Enter the password for the `ORAESB` schema in the database specified in the **Database Connect Information** field.

ORAWSM Schema Password: Enter the password for the `ORAWSM` schema in the database specified in the **Database Connect Information** field.

4. Oracle Universal Installer: Install Screen

Figure 4-3 Oracle Universal Installer: Install Screen

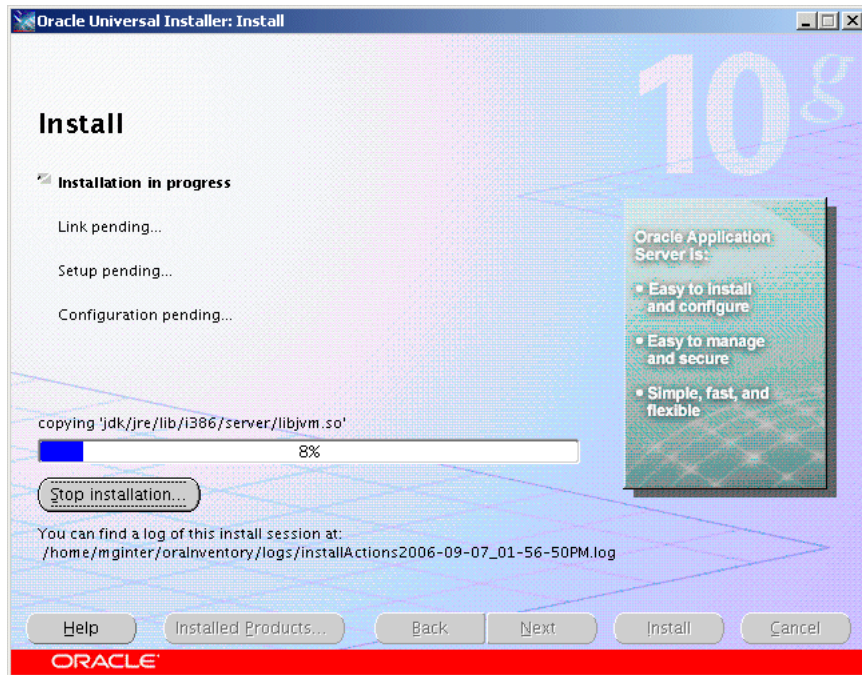

This screen shows the progress of installation.

5. Oracle Universal Installer: Configuration Assistants Screen

Figure 4-4 Oracle Universal Installer: Configuration Assistants Screen

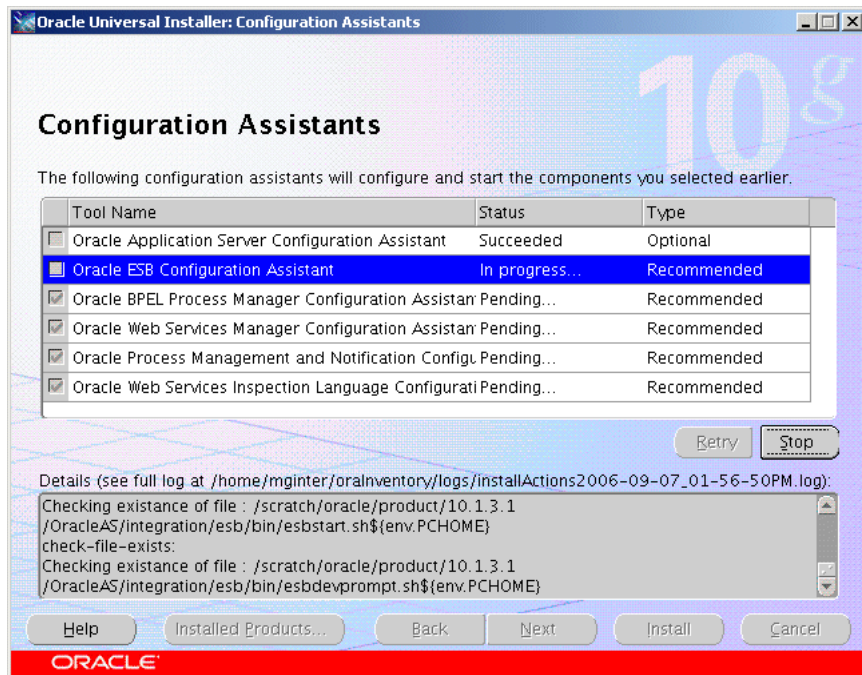

This screen shows the progress of the configuration assistants.

6. Oracle Universal Installer: End of Installation Screen

Figure 4–5 Oracle Universal Installer: End of Installation Screen

This screen tells you whether or not your installation was successful, and provides links to various documentation, such as the product release notes and installation log, as well as links to various Oracle Application Server pages such as the Welcome Page or Application Server Control Console.

4.3 What Should I Do Next?

After the installation is complete, you should:

- Refer to [Chapter 7](#) for instructions and information about postinstallation tasks you should perform.
- Refer to the *Oracle Application Server Administrator's Guide* for information about how to configure, administer, and manage Oracle Application Server after it has been successfully installed.

Advanced Installation

This chapter describes how to perform an advanced installation of Oracle Application Server. The following topics are covered:

- [Section 5.1, "What Components Are Installed?"](#)
- [Section 5.2, "Advanced Installation Steps"](#)
- [Section 5.3, "Installation Screens"](#)
- [Section 5.4, "Troubleshooting Information"](#)
- [Section 5.5, "What Should I Do Next?"](#)

5.1 What Components Are Installed?

During the advanced installation, you have four installation choices:

- [J2EE Server, Web Server and SOA Suite](#)
- [J2EE Server and Web Server](#)
- [J2EE Server](#)
- [Web Server](#)

5.1.1 J2EE Server, Web Server and SOA Suite

The following components are installed in a J2EE Server, Web Server and SOA Suite installation:

- [Oracle Containers for J2EE \(OC4J\)](#)

This component provides a complete Java 2 Enterprise Edition (J2EE) environment for developing Java applications.
- [Oracle SOA Suite](#)

This component provides Oracle SOA Suite, which enables services to be created, managed, and orchestrated into composite applications and business processes. Oracle SOA Suite includes Oracle BPEL Process Manager, Oracle Enterprise Service Bus (ESB), Oracle Web Services Manager (OWSM), and Oracle Business Rules.
- [Oracle HTTP Server with SSL Support](#)

This is the Web server component of Oracle Application Server
- [Oracle Enterprise Manager 10g Application Server Control](#)

This component is used for Web-based management of Oracle Application Server.

- Oracle Process Manager and Notification Server
This component provides process control and monitoring for Oracle Application Server instances and their components.

5.1.2 J2EE Server and Web Server

The following components are installed in a J2EE Server and Web Server installation:

- Oracle Containers for J2EE (OC4J)
This component provides a complete Java 2 Enterprise Edition (J2EE) environment for developing Java applications.
- Oracle HTTP Server with SSL Support
This is the Web server component of Oracle Application Server
- Oracle Enterprise Manager 10g Application Server Control
This component is used for Web-based management of Oracle Application Server.
- Oracle Process Manager and Notification Server
This component provides process control and monitoring for Oracle Application Server instances and their components.

5.1.3 J2EE Server

The following components are installed in a J2EE Server installation:

- Oracle Containers for J2EE (OC4J)
This component provides a complete Java 2 Enterprise Edition (J2EE) environment for developing Java applications.
- Oracle Enterprise Manager 10g Application Server Control
This component is used for Web-based management of Oracle Application Server.
- Oracle Process Manager and Notification Server
This component provides process control and monitoring for Oracle Application Server instances and their components.

5.1.4 Web Server

The following components are installed in a Web Server installation:

- Oracle HTTP Server with SSL Support
This is the Web server component of Oracle Application Server
- Oracle Process Manager and Notification Server
This component provides process control and monitoring for Oracle Application Server instances and their components.

5.2 Advanced Installation Steps

This section describes the procedure for the advanced installation of Oracle Application Server. It contains the following topics:

- [Section 5.2.1, "Before You Begin"](#)

- [Section 5.2.2, "Installing J2EE Server, Web Server and SOA Suite"](#)
- [Section 5.2.3, "Installing J2EE Server and Web Server"](#)
- [Section 5.2.4, "Installing J2EE Server"](#)
- [Section 5.2.5, "Installing Web Server"](#)

5.2.1 Before You Begin

Before you begin installing Oracle Application Server, ensure that you have read both [Chapter 2, "Requirements"](#) and [Chapter 3, "Things You Should Know Before Starting the Installation"](#). These chapters contain important information with which you must be familiar before you begin the installation so you can avoid potential problems during the installation.

5.2.2 Installing J2EE Server, Web Server and SOA Suite

[Table 5–1](#) provides a brief summary of the steps necessary to install J2EE Server, Web Server and SOA Suite with an advanced installation.

Table 5–1 Steps for Installing J2EE Server, Web Server and SOA Suite

Screen	Action
1. --	Start Oracle Universal Installer. For more information, refer to Section 3.12, "Starting the Oracle Universal Installer" .
2. Oracle Application Server SOA Suite 10.1.3.1.0 Installation	Specify the Oracle Home in the Installation Directory field. Select Advanced Install . Click Next . For more information, refer to Section 5.3.1, "Oracle Application Server SOA Suite 10.1.3.1.0 Installation Screen" .
3. Select Installation Type	Select J2EE Server, Web Server and SOA Suite . Click Next . For more information, refer to Section 5.3.2, "Select Installation Type Screen" .
4. Specify Database Connect Information	Specify your Oracle database connection information. Specify the DBA user in the User with DBA Privileges field. Specify the password for the DBA user in the Database User Password field. Specify the hostname and port for the database in the Hostname and Port field. Specify the service name of the database in the Service Name field. Click Next . For more information, refer to Section 5.3.3, "Specify Database Connect Information Screen" .
5. Specify Database Schema Passwords	Specify the passwords for the ORABPEL, ORAESB, and ORAWSM database schemas. Click Next . For more information, refer to Section 5.3.4, "Specify Database Schema Passwords Screen" .
6. Specify Port Configuration Options	Select whether you want to configure ports automatically or manually by specifying the location of a port configuration file. Click Next . For more information, refer to Section 5.3.5, "Specify Port Configuration Options Screen" .

Table 5–1 (Cont.) Steps for Installing J2EE Server, Web Server and SOA Suite

Screen	Action
7. Administration Settings	<p>Specify the Oracle Application Server instance name and <code>oc4jadmin</code> password.</p> <p>Select Configure this as an Administration OC4J instance if you would like to run Application Server Control on this instance.</p> <p>Specify the Oracle Containers for J2EE instance name. The default instance name is <code>oc4j_soa</code>.</p> <p>Click Next.</p> <p>For more information, refer to Section 5.3.6, "Administration Settings Screen".</p>
8. Cluster Topology Configuration	<p>Select Access this OC4J Instance from a separate Oracle HTTP Server if you want the default web site to run in AJP protocol mode and specify the hostname and port of the Oracle HTTP Server.</p> <p>Select Configure this instance to be a part of an Oracle Application Server cluster topology if you would like to configure this instance to be part of an Oracle Application Server cluster topology. Specify the IP address and port for the multicast address.</p> <p>Click Next.</p> <p>For more information, refer to Section 5.3.8, "Cluster Topology Configuration Screen - J2EE Server, Web Server, and SOA Suite Installation".</p>
9. Summary	<p>Verify that the installation parameters shown on the screen are correct.</p> <p>Click Install.</p> <p>For more information, refer to Section 5.3.12, "Summary Screen".</p>
10. Install	<p>None. This screen shows the progress of the installation.</p> <p>For more information, refer to Section 5.3.13, "Install Screen".</p>
11. Configuration Assistants	<p>None, unless you want to stop the installation of a particular configuration assistant.</p> <p>For more information, refer to Section 5.3.14, "Configuration Assistants Screen".</p>
12. End of Installation	<p>None. This screen tells you whether or not your installation was successful, and provides a link to the product release notes.</p> <p>For more information, refer to Section 5.3.15, "End of Installation Screen".</p>

5.2.3 Installing J2EE Server and Web Server

[Table 5–2](#) provides a brief summary of the steps necessary to install J2EE Server and Web Server with an advanced installation.

Table 5–2 Steps for Installing J2EE Server and Web Server

Screen	Action
1. --	<p>Start Oracle Universal Installer.</p> <p>For more information, refer to Section 3.12, "Starting the Oracle Universal Installer".</p>
2. Oracle Application Server SOA Suite 10.1.3.1.0 Installation	<p>Specify the Oracle Home in the Installation Directory field.</p> <p>Select Advanced Install.</p> <p>Click Next.</p> <p>For more information, refer to Section 5.3.1, "Oracle Application Server SOA Suite 10.1.3.1.0 Installation Screen".</p>

Table 5–2 (Cont.) Steps for Installing J2EE Server and Web Server

Screen	Action
3. Select Installation Type	Select J2EE Server and Web Server . Click Next . For more information, refer to Section 5.3.2, "Select Installation Type Screen" .
4. Specify Port Configuration Options	Select whether you want to configure ports automatically or manually by specifying the location of a port configuration file. Click Next . For more information, refer to Section 5.3.5, "Specify Port Configuration Options Screen" .
5. Administration Settings	Specify the Oracle Application Server instance name and <code>oc4jadmin</code> password. Select Configure this as an Administration OC4J instance if you would like to run Application Server Control on this instance. Specify the default Oracle Containers for J2EE instance name. Click Next . For more information, refer to Section 5.3.6, "Administration Settings Screen" .
6. Cluster Topology Configuration	Select if you would like to configure this instance to be part of an Oracle Application Server cluster topology. If you select Configure this instance to be part of an Oracle Application Server cluster topology , specify the IP Address and Port . Click Next . For more information, refer to Section 5.3.9, "Cluster Topology Configuration Screen - J2EE Server and Web Server Installation" .
7. Summary	Verify that the installation parameters shown on the screen are correct. Click Install . For more information, refer to Section 5.3.12, "Summary Screen" .
8. Install	None. This screen shows the progress of the installation. For more information, refer to Section 5.3.13, "Install Screen" .
9. Configuration Assistants	None, unless you want to stop the installation of a particular configuration assistant. For more information, refer to Section 5.3.14, "Configuration Assistants Screen" .
10. End of Installation	None. This screen tells you whether or not your installation was successful, and provides a link to the product release notes. For more information, refer to Section 5.3.15, "End of Installation Screen" .

5.2.4 Installing J2EE Server

[Table 5–3](#) provides a brief summary of the steps necessary to install J2EE Server with an advanced installation.

Table 5–3 Steps for Installing J2EE Server

Screen	Action
1. --	Start Oracle Universal Installer. For more information, refer to Section 3.12, "Starting the Oracle Universal Installer" .

Table 5–3 (Cont.) Steps for Installing J2EE Server

Screen	Action
2. Oracle Application Server SOA Suite 10.1.3.1.0 Installation	Specify the Oracle Home in the Installation Directory field. Select Advanced Install . Click Next . For more information, refer to Section 5.3.1, "Oracle Application Server SOA Suite 10.1.3.1.0 Installation Screen" .
3. Select Installation Type	Select J2EE Server . Click Next . For more information, refer to Section 5.3.2, "Select Installation Type Screen" .
4. Specify Port Configuration Options	Select whether you want to configure ports automatically or manually by specifying the location of a port configuration file. Click Next . For more information, refer to Section 5.3.5, "Specify Port Configuration Options Screen" .
5. Administration Settings	Specify the Oracle Application Server instance name and <code>oc4jadmin</code> password. Select Configure this as an Administration OC4J instance if you would like to run Application Server Control on this instance. Specify the default Oracle Containers for J2EE instance name. Click Next . For more information, refer to Section 5.3.6, "Administration Settings Screen" .
6. Cluster Topology Configuration	Select if you would like to configure this instance to be part of an Oracle Application Server cluster topology. Select Access this OC4J instance from a separate Oracle HTTP Server if you want the OC4J instance to accept requests from an Oracle HTTP Server instance. If you select Configure this OC4J instance to be part of an Oracle Application Server cluster topology , specify the IP Address and Port . Click Next . For more information, refer to Section 5.3.10, "Cluster Topology Configuration Screen - J2EE Server Installation" .
7. Summary	Verify that the installation parameters shown on the screen are correct. Click Install . For more information, refer to Section 5.3.12, "Summary Screen" .
8. Install	None. This screen shows the progress of the installation. For more information, refer to Section 5.3.13, "Install Screen" .
9. End of Installation	None. This screen tells you whether or not your installation was successful, and provides a link to the product release notes. For more information, refer to Section 5.3.15, "End of Installation Screen" .

5.2.5 Installing Web Server

[Table 5–4](#) provides a brief summary of the steps necessary to install Web Server with an advanced installation.

Table 5–4 Steps for Installing Web Server

Screen	Action
1. --	Start Oracle Universal Installer. For more information, refer to Section 3.12, "Starting the Oracle Universal Installer" .
2. Oracle Application Server SOA Suite 10.1.3.1.0 Installation	Specify the Oracle Home in the Installation Directory field. Select Advanced Installation Mode . Click Next . For more information, refer to Section 5.3.1, "Oracle Application Server SOA Suite 10.1.3.1.0 Installation Screen" .
3. Select Installation Type	Select Web Server . Click Next . For more information, refer to Section 5.3.2, "Select Installation Type Screen" .
4. Specify Port Configuration Options	Select whether you want to configure ports automatically or manually by specifying the location of a port configuration file. Click Next . For more information, refer to Section 5.3.5, "Specify Port Configuration Options Screen" .
5. Specify Instance Name	Specify the Oracle Application Server instance name. Click Next . For more information, refer to Section 5.3.7, "Specify Instance Name Screen" .
6. Cluster Topology Configuration	Select Configure this Oracle HTTP Server instance to be a part of an Oracle Application Server cluster if you would like to configure this instance to be part of an Oracle Application Server cluster topology. Click Next . For more information, refer to Section 5.3.11, "Cluster Topology Configuration Screen - Web Server Installation" .
7. Summary	Verify that the installation parameters shown on the screen are correct. Click Install . For more information, refer to Section 5.3.12, "Summary Screen" .
8. Install	None. This screen shows the progress of the installation. For more information, refer to Section 5.3.13, "Install Screen" .
9. Configuration Assistants	None, unless you want to stop the installation of a particular configuration assistant. For more information, refer to Section 5.3.14, "Configuration Assistants Screen" .
10. End of Installation	None. This screen tells you whether or not your installation was successful, and provides a link to the product release notes. For more information, refer to Section 5.3.15, "End of Installation Screen" .

5.3 Installation Screens

This section describes the various Oracle Universal Installer (OUI) installation screens for Oracle Application Server 10g Release 3 (10.1.3.1.0). It contains the following sections:

- [Section 5.3.1, "Oracle Application Server SOA Suite 10.1.3.1.0 Installation Screen"](#)
- [Section 5.3.2, "Select Installation Type Screen"](#)

- Section 5.3.3, "Specify Database Connect Information Screen"
- Section 5.3.4, "Specify Database Schema Passwords Screen"
- Section 5.3.5, "Specify Port Configuration Options Screen"
- Section 5.3.6, "Administration Settings Screen"
- Section 5.3.7, "Specify Instance Name Screen"
- Section 5.3.8, "Cluster Topology Configuration Screen - J2EE Server, Web Server, and SOA Suite Installation"
- Section 5.3.9, "Cluster Topology Configuration Screen - J2EE Server and Web Server Installation"
- Section 5.3.10, "Cluster Topology Configuration Screen - J2EE Server Installation"
- Section 5.3.11, "Cluster Topology Configuration Screen - Web Server Installation"
- Section 5.3.12, "Summary Screen"
- Section 5.3.13, "Install Screen"
- Section 5.3.14, "Configuration Assistants Screen"
- Section 5.3.15, "End of Installation Screen"

5.3.1 Oracle Application Server SOA Suite 10.1.3.1.0 Installation Screen

This is the first screen in the installation process. You need to specify the installation directory (or Oracle home) and whether you want to perform a basic or advanced installation.

Figure 5–1 Oracle Application Server SOA Suite 10.1.3.1.0 Installation Screen

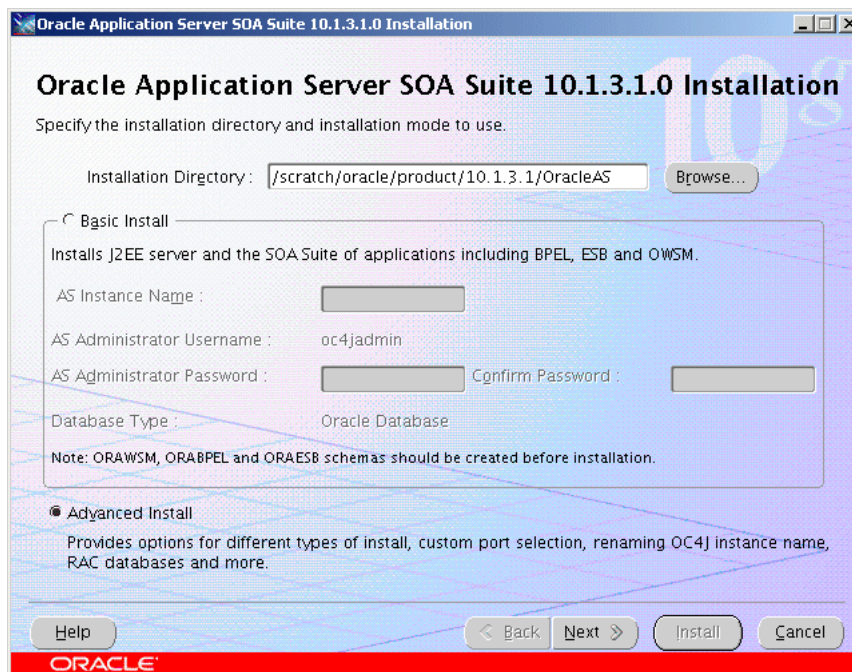

Installation Directory

Specify the full path of the installation directory or Oracle home. This is the directory where you want to install the software. For more information about the Oracle home, refer to [Section 3.1, "Oracle Home Directory"](#).

Select Basic or Advanced Install

In this chapter you are performing an advanced installation of Oracle Application Server, so select **Advanced Install** and click **Next**.

If you want to perform a basic installation, see [Chapter 4, "Basic Installation"](#).

After you click the **Next** button, the following warning appears:

Figure 5–2 Warning Screen

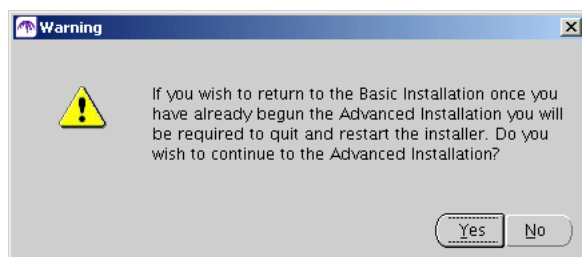

Click **Yes** to continue with the advanced installation.

5.3.2 Select Installation Type Screen

Select the product you want to install, then click **Next**.

Figure 5–3 Oracle Universal Installer: Select Installation Type Screen

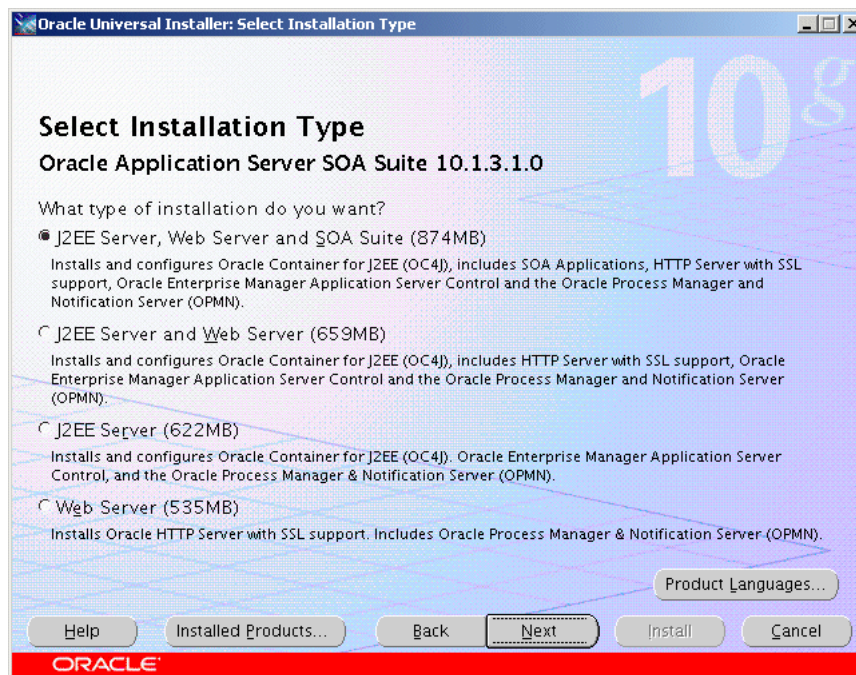

To learn what components are installed with the different installation types, see [Section 5.1, "What Components Are Installed?"](#).

On this screen, you can install additional languages by clicking on **Product Languages**. See [Section 3.3, "Installing Additional Languages"](#) for more information.

5.3.3 Specify Database Connect Information Screen

Specify your database connection information.

Figure 5–4 Oracle Universal Installer: Specify Database Connect Information

Database Type

The type of database is set to **Oracle Database** and cannot be changed.

Note: The installer checks that the database contains ORABPEL, ORAESB, and ORAWSM schemas. See [Section 2.9, "Installing Database Schemas"](#) for more information.

User with DBA Privileges

Specify the DBA user.

Database User Password

Specify the password for the user with DBA privileges.

Hostname and Port

Specify the hostname and port for the database. The format should be:

hostname:port

If the Oracle Database is a 10g or above Real Application Clusters database, specify all the virtual hostnames and ports in the cluster. Use the following format, separating the values with carets (^):

virtual_hostname_on_node1:port1^virtual_hostname_on_node2:port2^virtual_hostname_

`on_node3:port3`

If the Oracle Database is a 9i Real Application Clusters database, specify all the physical hostnames and ports in the cluster. Use the following format, separating the values with carets (^):

`host1:port1^host2:port2^host3:port3`

Service Name

Specify the service name of the database. This is typically the same as the global database name.

If you are unsure what the service name for your database is, you can obtain it from the `SERVICE_NAMES` parameter in the database's initialization parameter file. If the initialization parameter file does not contain the `SERVICE_NAMES` parameter, then the service name is the same as the global database name, which is specified in the `DB_NAME` and `DB_DOMAIN` parameters.

If the database is in a Real Application Clusters database, all the instances of the database must have the same service name.

5.3.4 Specify Database Schema Passwords Screen

Specify the passwords for the ORABPEL, ORAESB, and ORAWSM database schemas.

Note: The ORABPEL, ORAESB, and ORAWSM schemas must exist in the database prior to Oracle Application Server installation. Please refer to [Section 2.9, "Installing Database Schemas"](#) for instructions on how to install these schemas.

Figure 5–5 Oracle Universal Installer: Specify Database Schema Passwords Screen

ORAPEL Password

Specify the password for the ORAPEL schema.

ORAESB Password

Specify the password for the ORAESB schema.

ORAWSM Password

Specify the password for the ORAWSM schema.

5.3.5 Specify Port Configuration Options Screen

Select the method with which you want to configure ports.

Figure 5–6 Oracle Universal Installer: Specify Port Configuration Options Screen

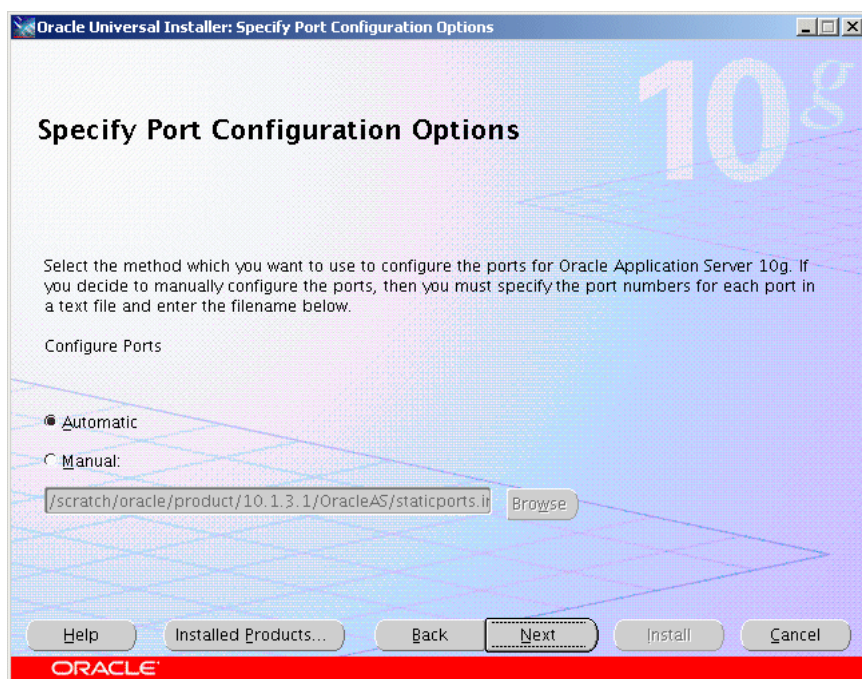

Select **Automatic** if you want to use all default port numbers. Refer to [Appendix B](#) for a list of all the default port numbers and ranges.

Select **Manual** if you want to customize your port numbers. You must supply the full path and file name to an existing port configuration file containing the port numbers you want to use for each component. Typically, this port configuration file is called `staticports.ini`, although any name is valid as long as the format of the file is correct. Refer to [Section 2.5.3, "Using Custom Port Numbers \(the "Static Ports" Feature\)"](#) for more information about the `staticports.ini` file that is shipped with the product.

5.3.6 Administration Settings Screen

Specify the Oracle Application Server instance name, `oc4jadmin` password, and the OC4J instance name.

Figure 5–7 Oracle Universal Installer: Administration Settings Screen

AS Instance Name

The AS Instance Name uniquely identifies this Oracle Application Server instance.

For more information about instance names, see [Section 3.4, "Oracle Application Server Instances and Instance Names"](#).

AS Administrator Username

The administrative username for Oracle Application Server instances is set to `oc4jadmin` and cannot be changed. To manage Oracle Application Server instances using Enterprise Manager, log in as the `oc4jadmin` user.

For more information about the `oc4jadmin` user, see [Section 3.5, "The oc4jadmin User and Restrictions on its Password"](#).

AS Administrator Password and Confirm AS Administrator Password

On a host, you can install multiple Oracle Application Server instances, each with its own unique instance name, but the name of the administrative user is `oc4jadmin` for all instances. You can specify a different password for the `oc4jadmin` user for each instance.

For more information about the `oc4jadmin` password, see [Section 3.5, "The oc4jadmin User and Restrictions on its Password"](#).

Configure this as an Administration OC4J instance

Select this option if you want to run Application Server Control on this system to provide management capabilities.

If you are using a single instance topology, you should select this option to be able to manage the instance.

If you are using a cluster topology, you should select this option if you want this instance to administer the cluster using Application Server Control. In a cluster

topology, only one instance should be configured as an Administration OC4J instance. Note that the Administration OC4J instance for the cluster does not have to be the first installed node.

If you do not select **Configure this as an Administration OC4J instance**, then Application Server Control will be configured to not run on this system. This Application Server instance will need to be managed by Application Server Control running on another OC4J instance within the cluster topology. You can configure the Application Server Control to run on this instance following installation if required. See "Enabling Remote Management by Setting Administrator Credentials" in the *Oracle Application Server Administrator's Guide* for details.

OC4J Instance Name

The **OC4J instance name** identifies the default OC4J instance created by the installer.

OC4J instance names can consist only of the alphanumeric characters (A-Z, a-z, 0-9) and the underscore character (_).

The maximum length for an OC4J instance name is 63 characters.

5.3.7 Specify Instance Name Screen

This screen only appears if you select the **Web Server** option on the Select Installation Type screen shown in [Figure 5-3](#).

Figure 5-8 Oracle Universal Installer: Specify Instance Name Screen

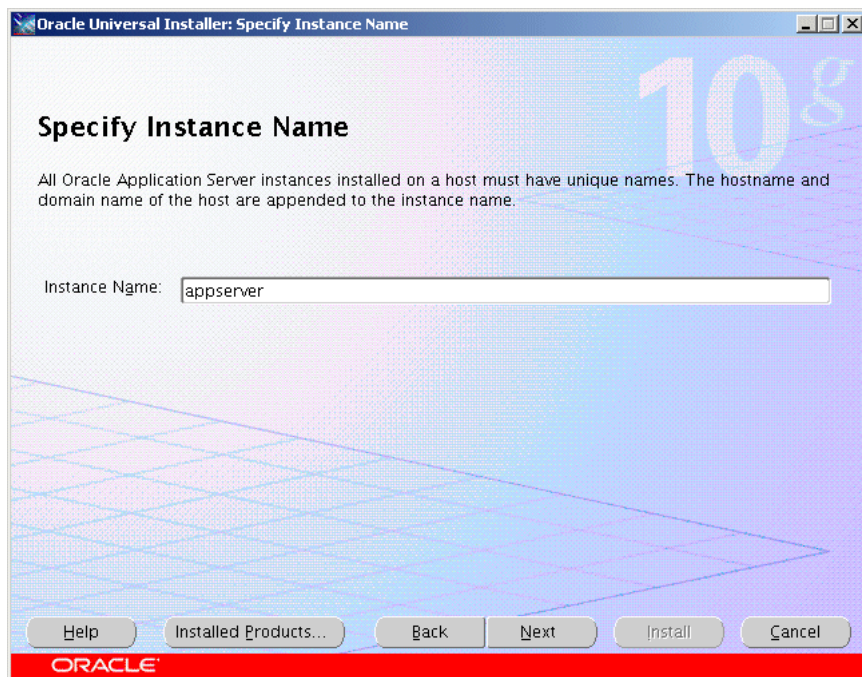

Instance Name

Specify the Oracle Application Server instance name. The instance name uniquely identifies this Oracle Application Server instance.

For more information about instance names, see [Section 3.4, "Oracle Application Server Instances and Instance Names"](#).

5.3.8 Cluster Topology Configuration Screen - J2EE Server, Web Server, and SOA Suite Installation

Select whether you would like to configure this instance to be part of an Oracle Application Server cluster topology.

Figure 5–9 Oracle Universal Installer: Cluster Topology Configuration (J2EE Server, Web Server, and SOA Suite Installation)

Access this OC4J Instance from a separate Oracle HTTP Server

Select this option if you want the OC4J instance to accept requests from an Oracle HTTP Server instance. If you select this option, then the OC4J instance will be configured so that its default web site is running in AJP protocol mode and accepts requests from `mod_oc4j` running in Oracle HTTP Server.

If you do not select this option, the OC4J instance will listen for requests from browser clients using its own HTTP listener. The OC4J instance will be configured so that its default web site is running in HTTP protocol mode and can be directly accessed from browser clients.

You can change how this OC4J instance is accessed following installation. See "Configuring Multicast Discovery with `opmnctl`" in the *Oracle Containers for J2EE Configuration and Administration Guide*.

Specify the hostname and port of the load balancer or the Oracle HTTP Server

Specify the **IP Address** and the **Port** number of the load balancer or Oracle HTTP Server from which you will accept requests.

Configure this instance to be part of an Oracle Application Server cluster topology

Select this option if you would like to configure this instance to be part of an Oracle Application Server cluster topology. You may also configure the cluster topology following installation. See [Section 7.4, "Configuring OracleAS Clusters"](#) for details.

Specify the Oracle Application Server cluster discovery address

Specify the **IP Address** and the **Port** for the multicast address shared by all the nodes in the cluster.

Note:

- When installing the first instance of the cluster, you only need to provide the discovery address. You do not need to perform any additional steps before installing the first instance of the cluster.
 - All nodes within the topology must be configured to use the same multicast address and port.
 - The multicast address must be within the valid address range, which is 224.0.1.0 to 239.255.255.255.
 - The installer does not validate the IP address or port of the cluster discovery address.
-

If you are adding an instance to an existing cluster and do not know the multicast address, find the `<discover>` element in the `opmn.xml` file on an Oracle Application Server instance in the topology. The `<discover>` element should appear like this:

```
<notification-server>
  <topology>
    <discover list="*225.0.0.20:8001"/>
  </topology>
  ...
</notification-server>
```

In this example, the IP address is 225.0.0.20 and the port is 8001.

5.3.9 Cluster Topology Configuration Screen - J2EE Server and Web Server Installation

Select whether you would like to configure this instance to be part of an Oracle Application Server cluster topology.

Figure 5–10 Oracle Universal Installer: Cluster Topology Configuration (J2EE Server and Web Server Installation)

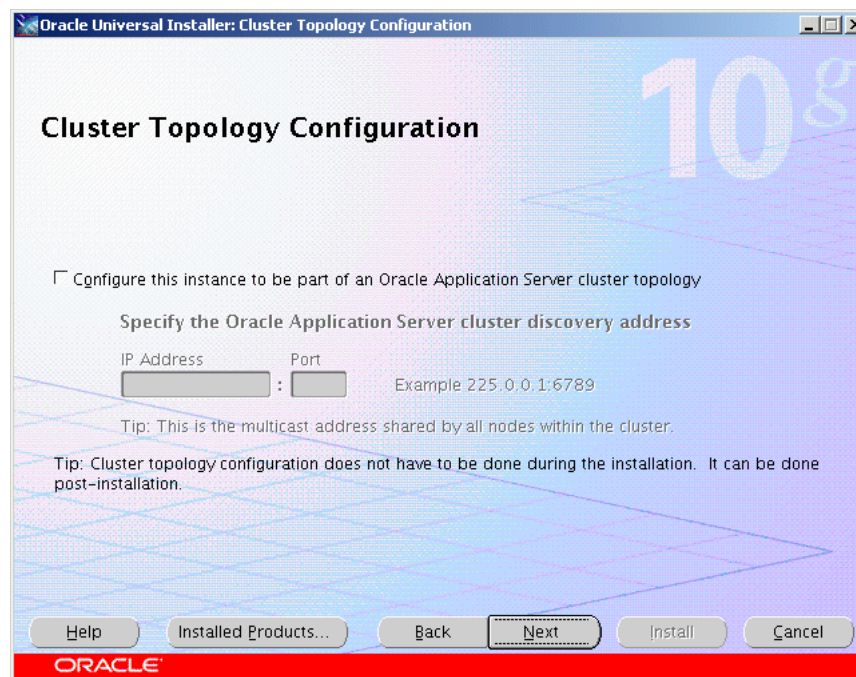

Configure this instance to be part of an Oracle Application Server cluster topology

Select this option if you would like to configure this instance to be part of an Oracle Application Server cluster topology. You may also configure the cluster topology following installation. See [Section 7.4, "Configuring OracleAS Clusters"](#) for details.

Specify the Oracle Application Server cluster discovery address

Specify the **IP Address** and the **Port** for the multicast address shared by all the nodes in the cluster.

Note:

- When installing the first instance of the cluster, you only need to provide the discovery address. You do not need to perform any additional steps before installing the first instance of the cluster.
 - All nodes within the topology must be configured to use the same multicast address and port.
 - The multicast address must be within the valid address range, which is 224.0.1.0 to 239.255.255.255.
 - The installer does not validate the IP address or port of the cluster discovery address.
-
-

If you are adding an instance to an existing cluster and do not know the multicast address, find the `<discover>` element in the `opmn.xml` file on an Oracle Application Server instance in the topology. The `<discover>` element should appear like this:

```
<notification-server>
  <topology>
```

```

    <discover list="*225.0.0.20:8001"/>
  </topology>
  ...
</notification-server>

```

In this example, the IP address is 225.0.0.20 and the port is 8001.

5.3.10 Cluster Topology Configuration Screen - J2EE Server Installation

Select whether you would like to configure this instance to be part of an Oracle Application Server cluster topology.

Figure 5–11 Oracle Universal Installer: Cluster Topology Configuration (J2EE Server)

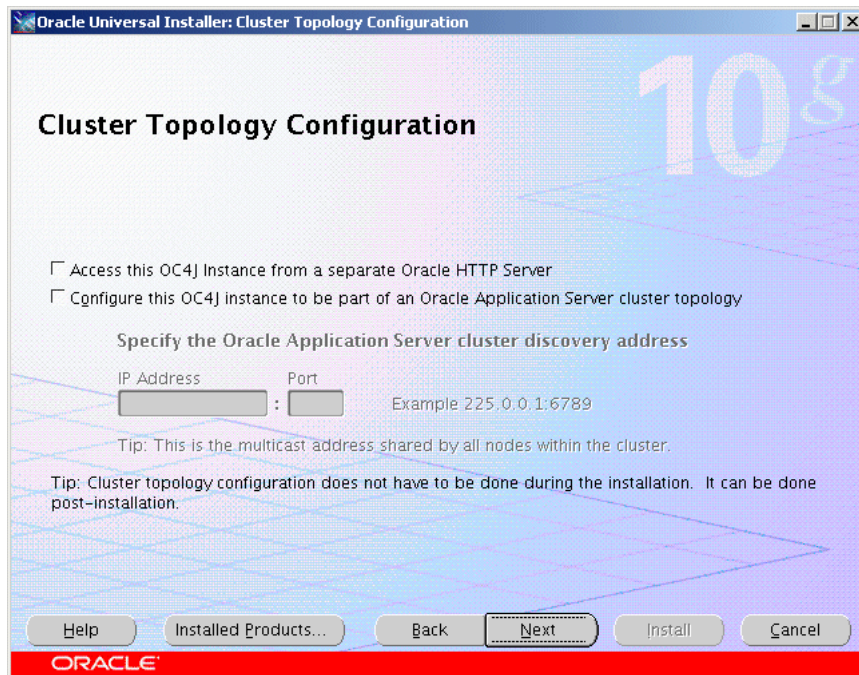

Access this OC4J Instance from a separate Oracle HTTP Server

Select this option if you want the OC4J instance to accept requests from an Oracle HTTP Server instance. If you select this option, then the OC4J instance will be configured so that its default web site is running in AJP protocol mode and accepts requests from `mod_oc4j` running in Oracle HTTP Server.

If you do not select this option, the OC4J instance will listen for requests from browser clients using its own HTTP listener. The OC4J instance will be configured so that its default web site is running in HTTP protocol mode and can be directly accessed from browser clients.

You can change how this OC4J instance is accessed following installation. See "Configuring Multicast Discovery with `opmnctl`" in the *Oracle Containers for J2EE Configuration and Administration Guide*.

Configure this OC4J instance to be part of an Oracle Application Server cluster topology

Select this option if you would like to configure this OC4J instance to be part of an Oracle Application Server cluster topology. You may also configure the cluster

topology following installation. See [Section 7.4, "Configuring OracleAS Clusters"](#) for details.

Specify the Oracle Application Server cluster discovery address

Specify the **IP Address** and the **Port** for the multicast address shared by all the nodes in the cluster.

Note:

- When installing the first instance of the cluster, you only need to provide the discovery address. You do not need to perform any additional steps before installing the first instance of the cluster.
 - All nodes within the topology must be configured to use the same multicast address and port.
 - The multicast address must be within the valid address range, which is 224.0.1.0 to 239.255.255.255.
 - The installer does not validate the IP address or port of the cluster discovery address.
-
-

If you are adding an instance to an existing cluster and do not know the multicast address, find the `<discover>` element in the `opmn.xml` file on an Oracle Application Server instance in the topology. The `<discover>` element should appear like this:

```
<notification-server>
  <topology>
    <discover list="*225.0.0.20:8001"/>
  </topology>
  ...
</notification-server>
```

In this example, the IP address is 225.0.0.20 and the port is 8001.

5.3.11 Cluster Topology Configuration Screen - Web Server Installation

Select whether you would like to configure this instance to be part of an Oracle Application Server cluster topology.

Figure 5–12 Oracle Universal Installer: Cluster Topology Configuration (Web Server)

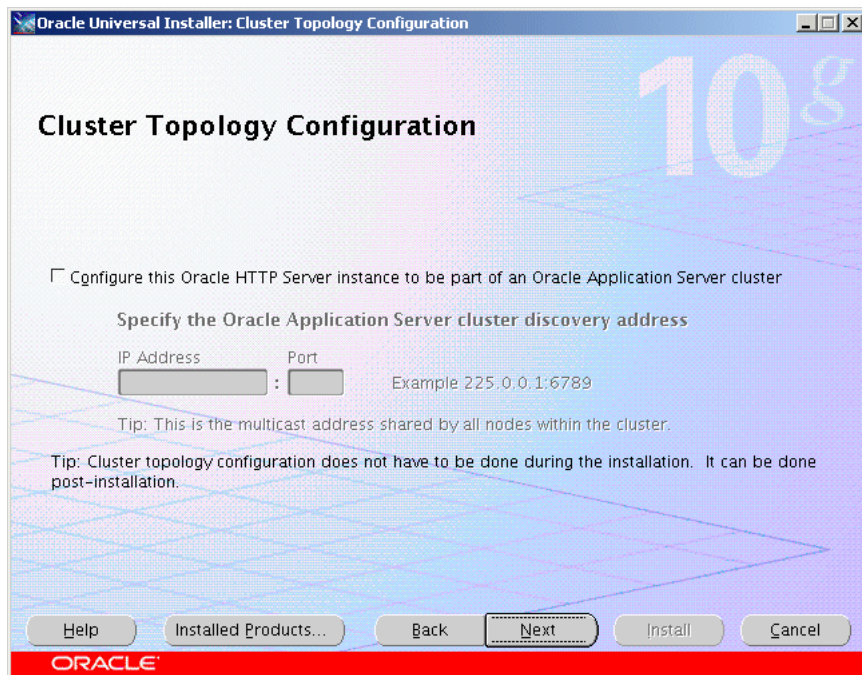

Configure this Oracle HTTP Server instance to be part of an Oracle Application Server cluster

Select this option if you would like to configure this instance to be part of an Oracle Application Server cluster. You may also configure the cluster following installation. See [Section 7.4, "Configuring OracleAS Clusters"](#) for details.

Specify the Oracle Application Server cluster discovery address

Specify the **IP Address** and the **Port** for the multicast address shared by all the nodes in the cluster.

Note:

- When installing the first instance of the cluster, you only need to provide the discovery address. You do not need to perform any additional steps before installing the first instance of the cluster.
 - All nodes within the topology must be configured to use the same multicast address and port.
 - The multicast address must be within the valid address range, which is 224.0.1.0 to 239.255.255.255.
 - The installer does not validate the IP address or port of the cluster discovery address.
-
-

If you are adding an instance to an existing cluster and do not know the multicast address, find the `<discover>` element in the `opmn.xml` file on an Oracle Application Server instance in the topology. The `<discover>` element should appear like this:

```
<notification-server>
  <topology>
    <discover list="*225.0.0.20:8001"/>
```

```

</topology>
...
</notification-server>

```

In this example, the IP address is 225.0.0.20 and the port is 8001.

5.3.12 Summary Screen

Check and verify that the installation parameters shown in this window are correct.

Figure 5–13 Oracle Universal Installer: Summary Screen

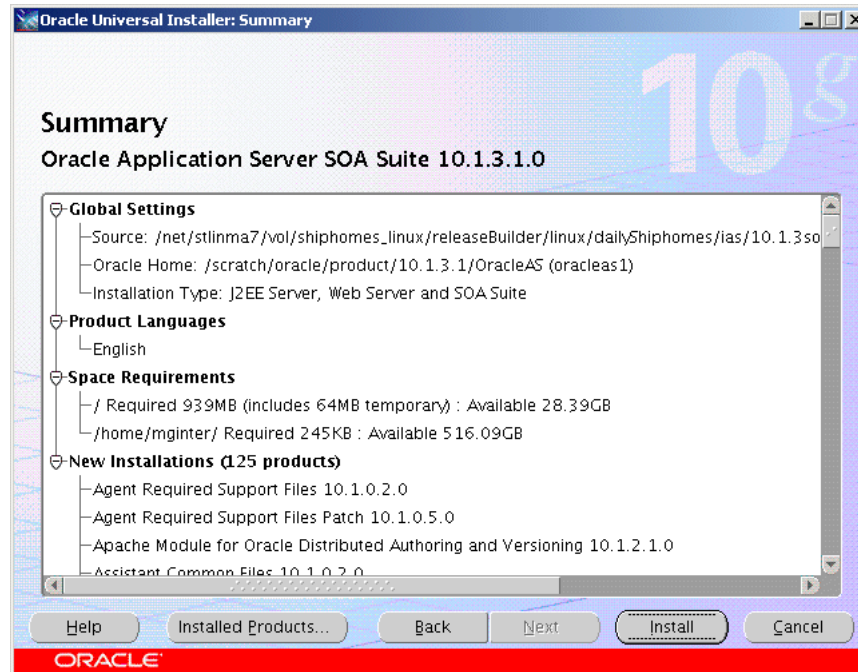

Click **Install** to begin the installation.

5.3.13 Install Screen

This screen shows the progress of the installation.

Figure 5–14 Oracle Universal Installer: Install Screen

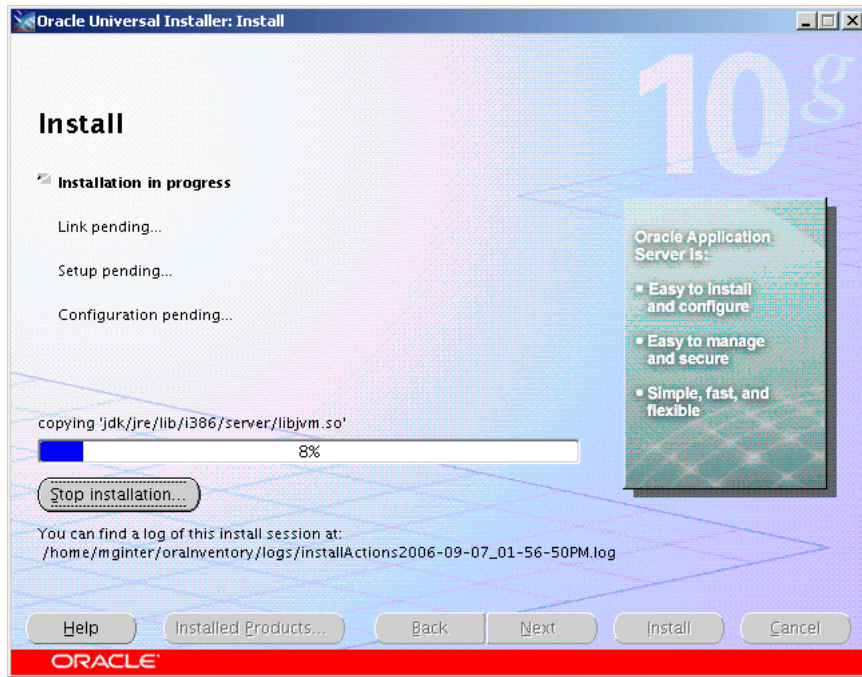

Click **Stop Installation** if you want to abort the installation. You will be asked to verify that you want to stop the installation.

This screen also provides the location of the install log, in case you want to view the contents of the log.

5.3.14 Configuration Assistants Screen

This screen shows the name, status, and tool type for tools recommended to be run before completing the installation.

Figure 5–15 Oracle Universal Installer: Configuration Assistants Screen

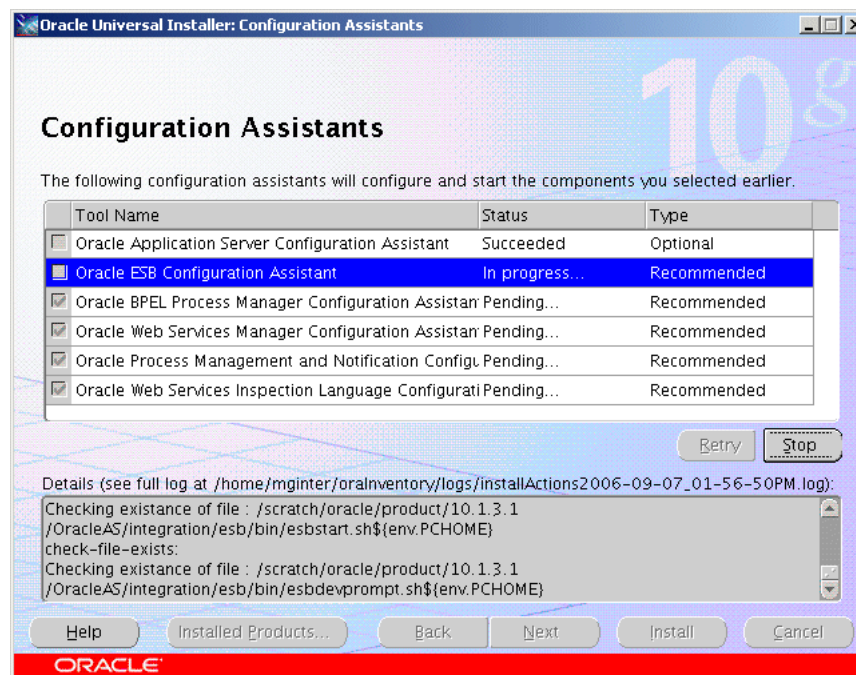

A tool may have one of the following states, as shown in the status column:

- **Succeeded:** The tool ran successfully.
- **Failed:** The tool ran, but failed.
- **Pending:** The tool is waiting to run.
- **Cancelled:** The tool was cancelled by the user (by clicking **Stop**).
- **In Progress:** The tool is currently running.
- **Skipped:** A configuration assistant running before this tool was cancelled or failed. Tools that follow a failed or cancelled tool are skipped.

When you select a tool, its details are shown in the Details box. Details are displayed as the tool is running. If you want to stop a configuration assistant while it is running, click **Stop**.

If all tools succeed on the first try, OUI automatically proceeds to the next page. Otherwise, OUI remains on the Configuration Assistants page until all tools are successful. You can then click **Next** to proceed.

If one or more tools fail, OUI does not proceed to the next page. Instead, you can read the details of failed tools, fix the problems, and try running the configuration assistant again. You should also consult the installation document for the product being installed for instructions on what to do if a tool fails. For all failed or skipped tools, OUI generates a list of the tool names and the commands used to run them; you can copy/paste this information directly into a shell script or batch file to run these tools after installation is complete.

By default, the check box in the Retry column will be checked for all tools that failed or were skipped. To retry all checked configuration assistants, click **Retry**.

To continue without fixing the problem, click **Next**.

Note: The installation is considered successful even if all configuration assistants failed, irrespective of their type (Recommended or Optional). However, failing to successfully run all recommended tools results in an improperly configured product that may not function.

5.3.15 End of Installation Screen

This screen tells you whether or not your Oracle Application Server installation was successful and displays some important information that you must remember about the products you have installed. For example, it might contain information about the URLs for particular Web applications. Write down this information so that you can remember it.

This information can also be found in the `ORACLE_HOME/install/readme.txt` file.

Figure 5–16 Oracle Universal Installer: End of Installation

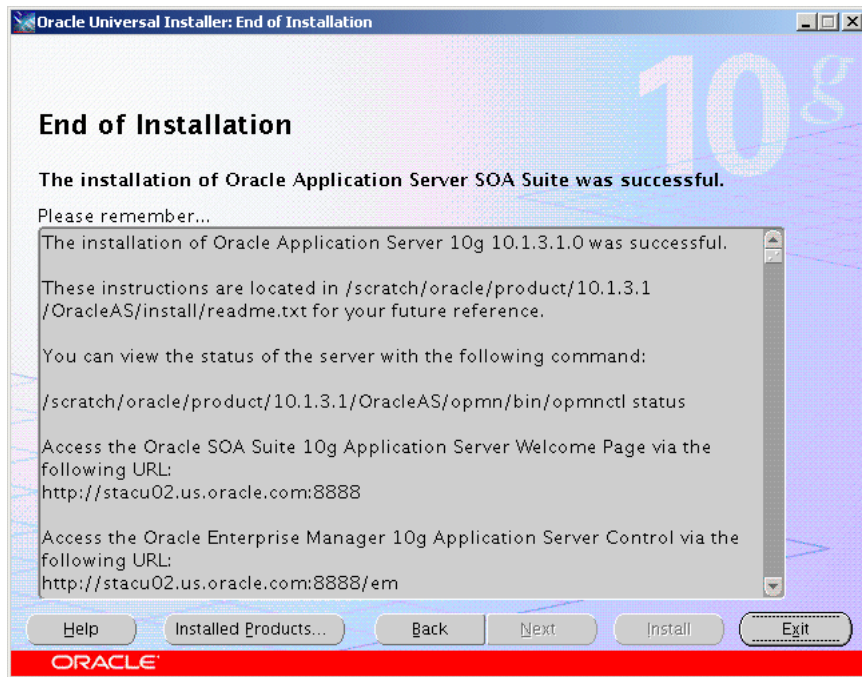

To view release notes for the products you have installed, click **Release Information** or see the documentation page on OTN (<http://www.oracle.com/technology/documentation>).

Click **Exit** to exit the Oracle Universal Installer.

5.4 Troubleshooting Information

If you encounter any problems with the installation, configuration assistants, or product in general, refer to [Appendix E, "Troubleshooting"](#) for common problems and solutions.

5.5 What Should I Do Next?

After the installation is complete, you should:

- Refer to [Chapter 7](#) for instructions and information about postinstallation tasks you should perform.
- Refer to the *Oracle Application Server Administrator's Guide* for information about how to configure, administer, and manage Oracle Application Server after it has been successfully installed.

Installing in High Availability Environments

This chapter provides an overview of the high availability configurations supported by Oracle Application Server and instructions for installation.

Contents of this chapter:

- [Section 6.1, "Overview of High Availability Configurations"](#)
- [Section 6.2, "Requirements for High Availability Configurations"](#)
- [Section 6.3, "Creating the Active-Active Topology"](#)
- [Section 6.4, "Creating the Active-Passive Topology"](#)
- [Section 6.5, "Creating an OracleAS Disaster Recovery Configuration"](#)

6.1 Overview of High Availability Configurations

This chapter provides only a brief overview of the high availability configurations in Oracle Application Server. For a complete description of the configurations, see the *Oracle Application Server High Availability Guide*.

Oracle Application Server supports the following types of high availability configurations at installation time. Note that there are multiple variants of each type.

- [Section 6.1.1, "Active-Active Topologies: OracleAS Clusters"](#)
- [Section 6.1.2, "Active-Passive Topologies: OracleAS Cold Failover Clusters"](#)
- [Section 6.1.3, "OracleAS Disaster Recovery"](#)

For a quick summary of the high availability configurations, see [Section 6.1.4, "Summary of Differences"](#).

6.1.1 Active-Active Topologies: OracleAS Clusters

Oracle Application Server provides an active-active redundant model for all its components with OracleAS Clusters. In an OracleAS Clusters configuration, two or more Oracle Application Server instances are configured to serve the same workload. These instances can run on the same machine or on different machines.

The instances are front-ended by an external load balancer, which directs requests to any of the active instances. Instead of an external load balancer, you can also run a software load balancer to distribute the requests. In production environment, however, a hardware load balancer is recommended.

Common properties of an OracleAS Clusters configuration include:

- Similar instance configuration

The instances need to serve the same workload or applications. Some configuration properties should have similar values across instances so that the instances can deliver the same reply to the same request. Other configuration properties may be instance-specific, such as local host name information.

If you make a configuration change to one instance, you should also make the same change to the other instances in the active-active topology. The "Configuring and Managing Clusters" chapter in the *Oracle Containers for J2EE Configuration and Administration Guide* lists the files that contain properties that should be replicated.

- Independent operation

If one Oracle Application Server instance in an active-active topology fails, the other instances in the cluster continue to serve requests. The load balancer directs requests only to instances that are alive.

Advantages of an OracleAS Clusters configuration include:

- Increased availability

An active-active topology is a redundant configuration. Loss of one instance can be tolerated because other instances can continue to serve the same requests.

- Increased scalability and performance

Multiple identically-configured instances provide the capability to share a workload among different machines and processes. You can scale the topology by adding new instances as the number of requests increase.

For instructions on creating the OracleAS Clusters configuration, see [Section 6.3, "Creating the Active-Active Topology"](#).

6.1.2 Active-Passive Topologies: OracleAS Cold Failover Clusters

Oracle Application Server provides an active-passive model for all its components in OracleAS Cold Failover Clusters. In an OracleAS Cold Failover Cluster topology, two Oracle Application Server instances are configured to serve the same application workload but only one is active at any particular time. The passive instance runs (that is, becomes active) only when the active instance fails. These instances run on nodes that are in a hardware cluster.

Common properties of an OracleAS Cold Failover Cluster topology include:

- Hardware cluster

In an OracleAS Cold Failover Cluster topology, you run Oracle Application Server on machines that are in a hardware cluster, with vendor clusterware running on the machines.

- Shared storage

You install the Oracle home for the Oracle Application Server instance on storage shared by the machines in the hardware cluster.

The active node in the OracleAS Cold Failover Cluster topology mounts the shared storage so that it has access to the Oracle home. If it fails, the passive instance mounts the shared storage and accesses the same Oracle home.

- Virtual hostname

The virtual hostname gives clients a single system view of the Oracle Application Server middle tier. Clients use the virtual hostname to access the Oracle Application Server middle tier.

The virtual hostname is associated with a virtual IP. This name-IP entry must be added to the DNS that the site uses. For example, if the two physical hostnames of the hardware cluster are `node1.mycompany.com` and `node2.mycompany.com`, the single view of this cluster can be provided by the virtual hostname `apps.mycompany.com`. In the DNS, `apps` maps to a virtual IP address that floats between `node1` and `node2` via a hardware cluster. Clients access Oracle Application Server using `apps.mycompany.com`; they do not know which physical node is active and actually servicing a particular request.

You can specify the virtual hostname during installation. See [Section 6.4, "Creating the Active-Passive Topology"](#).

- Failover procedure

An active-passive configuration also includes a set of scripts and procedures to detect failure of the active instance and fail over to the passive instance while minimizing downtime.

Advantages of an OracleAS Cold Failover Cluster topology include:

- Increased availability

If the active instance fails for any reason or must be taken offline, an identically configured passive instance is prepared to take over at any time.

- Reduced operating costs

In an active-passive topology only one set of processes is up and serving requests. Managing the active instance is generally easier than managing an array of active instances.

- Application independence

Some applications may not be suited to an active-active topology. This may include applications that rely heavily on application state or on information stored locally. An active-passive topology has only one instance serving requests at any particular time.

For instructions on creating the OracleAS Cold Failover Cluster configuration, see [Section 6.4, "Creating the Active-Passive Topology"](#).

6.1.3 OracleAS Disaster Recovery

OracleAS Disaster Recovery configurations have the following characteristics:

- A production site and a standby site that mirrors the production site. Typically, these sites are located some distance from each other to guard against site failures such as floods, fires, or earthquakes. During normal operation, the production site handles all the requests. If the production site goes down, the standby site takes over and handles all the requests.
- Each site has all the hardware and software to run. It contains nodes for running Oracle Application Server instances, load balancers, and DNS servers.

For installation details, see [Section 6.5, "Creating an OracleAS Disaster Recovery Configuration"](#).

6.1.4 Summary of Differences

[Table 6–1](#) summarizes the differences among the high availability configurations.

Table 6–1 Differences Among the High Availability Configurations

	OracleAS Cold Failover Cluster	OracleAS Clusters	OracleAS Disaster Recovery
Node configuration	Active-Passive	Active-Active	Active-Passive
Hardware cluster	Yes	No	Optional (hardware cluster required only if you installed the OracleAS Infrastructure in an OracleAS Cold Failover Cluster configuration)
Virtual hostname	Yes	No	Yes
Load balancer	No	Yes	No
Shared storage	Yes	No	No

6.2 Requirements for High Availability Configurations

This section describes the requirements common to all high availability configurations. In addition to these common requirements, each configuration has its own specific requirements. See the individual chapters for details.

Note: You still need to meet the requirements listed in [Chapter 2, "Requirements"](#), plus requirements specific to the high availability configuration that you plan to use.

The common requirements are:

- [Section 6.2.1, "Check Minimum Number of Nodes"](#)
- [Section 6.2.2, "Check That Groups Are Defined Identically on All Nodes"](#)
- [Section 6.2.3, "Check the Properties of the oracle User"](#)
- [Section 6.2.4, "Check for Previous Oracle Installations on All Nodes"](#)

6.2.1 Check Minimum Number of Nodes

You need at least two nodes in a high availability configuration. If a node fails for any reason, the second node takes over.

6.2.2 Check That Groups Are Defined Identically on All Nodes

Check that the `/etc/group` file on all nodes in the cluster contains the operating system groups that you plan to use. You should have one group for the `oraInventory` directory, and one or two groups for database administration. The group names and the group IDs must be the same for all nodes.

See [Section 2.6, "Operating System Groups"](#) for details.

6.2.3 Check the Properties of the oracle User

Check that the `oracle` operating system user, which you log in as to install Oracle Application Server, has the following properties:

- Belongs to the `oinstall` group and to the `osdba` group. The `oinstall` group is for the `oraInventory` directory, and the `osdba` group is a database administration group. See [Section 2.6, "Operating System Groups"](#) for details.

- Has write privileges on remote directories.

6.2.4 Check for Previous Oracle Installations on All Nodes

Check that all the nodes where you want to install in a high availability configuration do not have existing oraInventory directories.

Details of all Oracle software installations are recorded in the Oracle Installer Inventory directory. Typically, this directory is unique to a node and named oraInventory. The directory path of the Oracle Installer Inventory directory is stored in the oraInst.loc file.

The existence of this file on a node confirms that the node contains some Oracle software installation. Since the high availability configurations require installations on multiple nodes with Oracle Installer Inventory directories on a file system that may not be accessible on other nodes, the installation instructions in this chapter and subsequent chapters for high availability configurations assume that there have not been any previous installations of any Oracle software on any of the nodes that are used for this high availability configuration. The oraInst.loc file and the Oracle Installer Inventory directory should not exist on any of these nodes prior to these high availability installations.

To check if a node contains an oraInventory directory that could be detected by the installer:

1. On each node, check for the existence of the oraInst.loc file. This file is stored in the /etc directory.

If a node does not contain this file, then it does not have an oraInventory directory that will be used by the installer. You can check the next node.

2. For nodes that contain the oraInst.loc file, rename the file and the oraInventory directory. The installer then prompts you to enter a location for a new oraInventory directory.

For example enter the following commands as root:

```
# cat /etc/oraInst.loc
inventory_loc=/localfs/app/oracle/oraInventory
inst_group=dba
# mv /etc/oraInst.loc /etc/oraInst.loc.orig
# mv /localfs/app/oracle/oraInventory /localfs/app/oracle/oraInventory.orig
```

Since the oraInst.loc file and the Oracle Installer Inventory directory are required only during the installation of Oracle software, and not at runtime, renaming them and restoring them later does not affect the behavior of any installed Oracle software on any node. Make sure that the appropriate oraInst.loc file and Oracle Installer Inventory directory are in place before starting the Oracle Universal Installer.

Note: For an OracleAS Disaster Recovery configuration, the correct oraInst.loc file and associated oraInventory directory are required during normal operation, not just during installation.

6.3 Creating the Active-Active Topology

This section describes how to install Oracle Application Server in an active-active topology with OracleAS Clusters. OracleAS Clusters is one of the high availability environments supported by Oracle Application Server.

Contents of this section:

- [Section 6.3.1, "Active-Active Topologies: Introduction"](#)
- [Section 6.3.2, "OracleAS Clusters in Active-Active Topologies"](#)
- [Section 6.3.3, "Properties of Oracle Application Server Instances in Active-Active Topologies"](#)
- [Section 6.3.4, "Installation Steps for Active-Active Topologies"](#)
- [Section 6.3.5, "Supporting Procedures for Creating the Active-Active Topology"](#)

6.3.1 Active-Active Topologies: Introduction

An active-active topology consists of redundant middle-tier instances that deliver greater scalability and availability than a single instance. Active-active topologies remove the single point of failure that a single instance poses. While a single Oracle Application Server instance leverages the resources of a single host, a cluster of middle-tier instances spans multiple hosts, distributing application execution over a greater number of CPUs. A single Oracle Application Server instance is vulnerable to the failure of its host and operating system, but an active-active topology continues to function despite the loss of an operating system or a host, hiding any such failure from clients.

In active-active topologies, all the instances are active at the same time. This is different from active-passive topologies, where only one instance is active at any time.

The nodes in the active-active topologies are not in a hardware cluster.

Load Balancer Requirements

Active-active topologies use a load balancer to direct requests to one of the Oracle Application Server instances in the topology. In other words, the Oracle Application Server instances are fronted by the load balancer.

You configure the load balancer with virtual server names for HTTP and HTTPS traffic. Clients use the virtual server names in their requests. The load balancer directs requests to an available Oracle Application Server instance.

See the *Oracle Application Server High Availability Guide* for a list of features that your load balancer should have.

Figures of Active-Active Topologies

The following figures show two active-active topologies. The difference in the topologies is whether you install Oracle HTTP Server and OC4J in the same Oracle home or in separate Oracle homes.

[Figure 6–1](#) shows an active-active topology with Oracle HTTP Server and OC4J in the same Oracle home. [Figure 6–2](#) shows an active-active topology with Oracle HTTP Server and OC4J in separate Oracle homes.

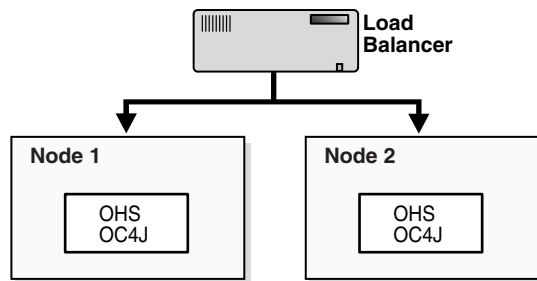
Figure 6–1 Active-Active Topology with Oracle HTTP Server and OC4J in the Same Oracle Home

Variation: You can use Oracle Identity Management from 10.1.2 with this topology.

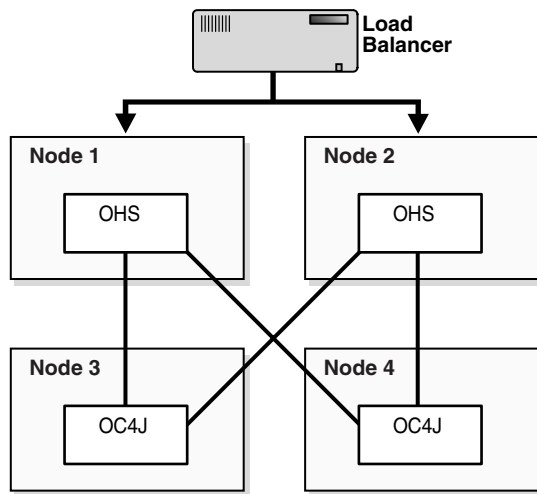
Figure 6–2 Active-Active Topology with Oracle HTTP Server and OC4J in Separate Oracle Homes

Variation:

- You can use Oracle Identity Management from 10.1.2 with this topology.
- You can use Oracle HTTP Server from 10.1.2 with this topology.

6.3.2 OracleAS Clusters in Active-Active Topologies

All the Oracle Application Server instances in an active-active topology belong to the same cluster. Oracle HTTP Server forwards application requests only to OC4J instances that belong to the same cluster.

You can cluster instances with OPMN using one of the following ways:

- All the instances use the same multicast IP address and port.
- All the instances are chained to the same discovery server.
- Each instance specifies all other instances in the `opmn.xml` configuration file.
- If the instances run on nodes that are on different subnets, you have to designate a node to be the gateway server, which bridges the instances on the different subnets.

Clustering with OPMN also enables you to use the `@cluster` parameter in some `opmnctl` commands. Commands that use the `@cluster` parameter apply to all instances in the cluster. For example, you can use the `@cluster` parameter to start all components in all instances in the cluster.

OC4J instances in a cluster have the following features:

- OC4J instances have cluster-wide properties as well as instance-specific properties. Cluster-wide properties are properties whose values are identical for all OC4J instances in the cluster. Instance-specific properties are properties that have different values for each OC4J instance. For a list of cluster-wide properties, see the "Configuring and Managing Clusters" chapter in the *Oracle Containers for J2EE Configuration and Administration Guide*.
- If you modify a cluster-wide property in one OC4J instance, make sure that you propagate the change to all other OC4J instances in the cluster.
- When you deploy an application to an OC4J instance, you also need to deploy it on all other OC4J instances in the cluster.
- The number of OC4J processes is an instance-specific property: it can be different for each OC4J instance. This must be configured for each Oracle Application Server instance in the cluster. The OC4J process configuration provides flexibility to tune according to the specific hardware capabilities of the host. By default, each OC4J instance is instantiated with a single OC4J process.

For details, see the "Configuring and Managing Clusters" chapter in the *Oracle Containers for J2EE Configuration and Administration Guide*.

6.3.3 Properties of Oracle Application Server Instances in Active-Active Topologies

Because the load balancer can send a request to any Oracle Application Server instance in the topology, you need to ensure that the instances are configured in the same manner so that clients get the same response regardless of which instance handles the request. This includes the following:

- Deploy the same applications on each OC4J instance in the topology.
- Ensure that you replicate state and stateful session bean information across OC4J instances so that in the event that an OC4J instance fails, another OC4J instance contains the state information and can continue the session.
- Ensure that configuration properties for all the OC4J instances in the topology are identical. These configuration properties are listed in chapter 8, "Configuring and Managing Clusters", in section "Replicating Changes Across a Cluster", in the *Oracle Containers for J2EE Configuration and Administration Guide*.

6.3.4 Installation Steps for Active-Active Topologies

To create the topology shown in [Figure 6–1](#) or [Figure 6–2](#), you perform the following steps:

Step 1: [Configure the Load Balancer with Virtual Server Names](#)

Step 2: [Install Oracle HTTP Server and OC4J and Cluster the Instances using OPMN](#)

Step 3: [Cluster the OC4J Components to Create an Application Cluster](#)

The following sections describe the steps in detail.

Step 1 Configure the Load Balancer with Virtual Server Names

Refer to your load balancer documentation for configuration steps. On your load balancer, you need to configure a virtual server name and port for HTTP traffic, and another virtual server name and port for HTTPS traffic. The port numbers for the virtual server names should match the port numbers at which Oracle HTTP Server is listening. Clients will use the virtual server names and ports to access Oracle Application Server instances.

Step 2 Install Oracle HTTP Server and OC4J and Cluster the Instances using OPMN

You can install Oracle HTTP Server and OC4J in the same Oracle home (see [Figure 6-1](#)), or in different Oracle homes (see [Figure 6-2](#)).

For Oracle Application Server instances that you want to group in the same active-active topology, you need to place them in the same cluster. This enables communication between the Oracle HTTP Server and OC4J instances, and simplifies the management of Oracle Application Server instances. OracleAS Clusters enable you to use the `@cluster` parameter for the `opmnctl` command to manage all the instances in the cluster.

You can create clusters using one of the following methods:

- **Dynamic Discovery Method**

In this method, each ONS node within the same subnet announces its presence with a multicast message. The cluster topology map for each node is automatically updated as nodes are added or removed, enabling the cluster to be self-managing.

If you use this method, you should specify the multicast address and port on the Cluster Topology Configuration screen in the installer.

- **Discovery Server Method**

In this method, specific nodes within a cluster are configured to serve as "discovery servers", which maintain the topology map for the cluster; the remaining nodes then connect with one another via this server.

If you use this method, you can define a cluster for OPMN by specifying the names of the Oracle Application Server instances explicitly in the `opmn.xml` file of each instance by following the steps in [Section 6.3.5.1, "Setting up Clusters with the Discovery Server Method"](#) after installation.

- **Gateway Method**

This configuration is used to connect topologies separated by firewalls or on different subnets using specified "gateway" nodes.

If you use this method, see the section "Configuring Cross-Topology Gateways" in the *Oracle Containers for J2EE Configuration and Administration Guide* for configuration details.

You can perform either an integrated installation or a distributed installation.

- **For Integrated Installations (Oracle HTTP Server and OC4J in the Same Oracle Home)**

You install Oracle Application Server on the local storage of each node in the active-active topology.

Perform an advanced installation by following the steps in [Section 5.2.3, "Installing J2EE Server and Web Server"](#) so that both Oracle HTTP Server and OC4J will run from the same Oracle home.

During the installation procedure, follow the prompts, ensuring you perform the following:

- On the Administration Instance Settings screen:
 - If you want this node to administer the cluster using Application Server Control, select **Configure this as an Administration OC4J instance**. In a cluster topology, only one instance should be configured as an

Administration OC4J instance. Note that the Administration OC4J instance for the cluster does not have to be the first installed node.

- If you do not want this node to administer the cluster, deselect **Configure this as an Administration OC4J instance**.

- If you are using the dynamic discovery method to cluster the Oracle Application Server instances for OPMN, perform the following:

On the Cluster Topology Configuration screen, select **Configure this instance to be part of an Oracle Application Server cluster topology**. Specify the **IP Address** and **Port** for the multicast address shared by all the nodes in the cluster.

Note that the multicast address must be between 224.0.0.1 and 239.255.255.255. If you are installing on the first node in the cluster, you may choose any IP address and port, as long as it falls in the multicast address range.

Note the following:

- Set the Oracle home to be on the local storage of each node.
- Ensure that the same component uses the same port number in each Oracle Application Server instance in the cluster. For example, ensure that Oracle HTTP Server is listening at the same port number for all instances in the cluster.
- To simplify administering the instances, use the same Oracle home path and the same instance name for each node.
- If you are using the discovery server method to cluster the Oracle Application Server instances for OPMN, be sure to perform the steps in [Section 6.3.5.1, "Setting up Clusters with the Discovery Server Method"](#) after installation.
- If you are using the gateway method to cluster the Oracle Application Server instances for OPMN, see the section "Configuring Cross-Topology Gateways" in the *Oracle Containers for J2EE Configuration and Administration Guide* for configuration details.
- **For Distributed Installations (Oracle HTTP Server and OC4J in Different Oracle Homes)**

You install Oracle Application Server on the local storage of each node in the active-active topology.

For the nodes where you want to run Oracle HTTP Server, follow the steps in [Section 5.2.5, "Installing Web Server"](#). For the nodes where you want to run OC4J, follow the steps in [Section 5.2.4, "Installing J2EE Server"](#).

During installation, select the following options:

- On the Administration Instance Settings screen:
 - If you want this node to administer the cluster using Application Server Control, select **Configure this as an Administration OC4J instance**. In a cluster topology, only one instance should be configured as an Administration OC4J instance. Note that the Administration OC4J instance for the cluster does not have to be the first installed node.
 - If you do not want this node to administer the cluster, deselect **Configure this as an Administration OC4J instance**.
- If you are using the dynamic discovery method to cluster the Oracle Application Server instances for OPMN, perform the following:

- If you are installing Oracle HTTP Server, select **Configure this HTTP Server instance to be part of an Oracle Application Server cluster** on the "Cluster Topology Configuration" screen. Specify the **IP Address** and **Port** for the multicast address shared by all the nodes in the cluster.
- If you are installing OC4J, select **Configure this OC4J instance to be part of an Oracle Application Server cluster topology** on the "Cluster Topology Configuration" screen. Specify the **IP Address** and **Port** for the multicast address shared by all the nodes in the cluster and select **Access this OC4J Instance from a separate Oracle HTTP Server**.

Note that the multicast address must be between 224.0.0.1 and 239.255.255.255. If you are installing on the first node in the cluster, you may choose any IP address and port, as long as it falls in the multicast address range.

Note the following:

- Set the Oracle home to be on the local storage of each node.
- Ensure that the same component uses the same port number in each Oracle Application Server instance in the cluster. For example, ensure that Oracle HTTP Server is listening at the same port number for all instances in the cluster.
- To simplify administering the instances, use the same Oracle home path and the same instance name for each node.
- If you are using the discovery server method to cluster the Oracle Application Server instances for OPMN, be sure to perform the steps in [Section 6.3.5.1, "Setting up Clusters with the Discovery Server Method"](#) after installation.
- If you are using the gateway method to cluster the Oracle Application Server instances for OPMN, see the section "Configuring Cross-Topology Gateways" in the *Oracle Containers for J2EE Configuration and Administration Guide* for configuration details.

Step 3 Cluster the OC4J Components to Create an Application Cluster

You can also cluster the OC4J components within the Oracle Application Server instances. This type of cluster is called Application Cluster.

Application Clusters provides the following features:

- Replication of objects and data contained in an HTTP session or a stateful session Enterprise JavaBean
- In-memory replication using multicast or peer-to-peer communication, or persistence of state to a database
- Load-balancing of incoming requests across OC4J instances
- Transparent failover across applications within the cluster

Application Clusters Defined at the Global Level or Application Level

You can define properties of an application cluster at the global level or at the application level. Properties defined at the global level apply to all applications, but you can override specific properties by defining them at the application level.

To define properties at the global level, you define them in the `ORACLE_HOME/j2ee/home/config/application.xml` file, which is the configuration file for the global default application.

To define properties at the application level, you define them in the application's `orion-application.xml` file. When you deploy the application, the file is located in the `ORACLE_HOME/j2ee/home/application-deployments/<app-name>/` directory.

Procedure

To create an application cluster at either the global or application level, you perform these steps:

1. Add an empty `<distributable/>` tag to the `web.xml` file for all Web modules that are part of an application configured for clustering.
2. Specify the mechanism for replicating state and session information between Oracle Application Server instances. You choose one of the following replication mechanisms:

Table 6–2 Application Cluster Replication Mechanisms

Replication Mechanism	Description
Multicast	OC4J instances use a multicast address and port to replicate information between themselves. See Section 6.3.5.2, "Setting up Multicast Replication" for details.
Peer-to-peer	Oracle Application Server supports two types of peer-to-peer replication: dynamic and static. <ul style="list-style-type: none"> ▪ In dynamic peer-to-peer replication, OC4J discovers other OC4J instances through OPMN. You do not have to list the names of the instances in a configuration file. ▪ In static peer-to-peer replication, you list the names of the instances that you want to be involved in the replication. See Section 6.3.5.3, "Setting up Peer-to-Peer Replication" for details.
Replication to database	State and session information are saved to the database that you specify. The database must be defined in the <code>data-sources.xml</code> file. See Section 6.3.5.4, "Setting up Replication to a Database" for details.

3. Specify how often and which data are replicated. See [Section 6.3.5.5, "Setting the Replication Policy"](#) for details.
4. Specify the number of nodes to replicate the data to. See [Section 6.3.5.6, "Specifying the Number of Nodes to Replicate To"](#) for details.

For details, see the "Application Clustering in OC4J" chapter in the *Oracle Containers for J2EE Configuration and Administration Guide*.

6.3.5 Supporting Procedures for Creating the Active-Active Topology

This section describes some common procedures that you may need to perform to maintain the active-active topology:

- [Section 6.3.5.1, "Setting up Clusters with the Discovery Server Method"](#)
- [Section 6.3.5.2, "Setting up Multicast Replication"](#)

- Section 6.3.5.3, "Setting up Peer-to-Peer Replication"
- Section 6.3.5.4, "Setting up Replication to a Database"
- Section 6.3.5.5, "Setting the Replication Policy"
- Section 6.3.5.6, "Specifying the Number of Nodes to Replicate To"

6.3.5.1 Setting up Clusters with the Discovery Server Method

If you do not want to use the multicast method, you can define a cluster by specifying the names of the nodes running the Oracle Application Server instances in the `opmn.xml` file of each instance.

Example: if you want to cluster four instances (`inst1.node1.mycompany.com`, `inst2.node2.mycompany.com`, `inst3.node3.mycompany.com`, `inst4.node4.mycompany.com`), you would perform these steps:

1. Designate at least one of the instances to serve as the "discovery server". The discovery server maintains the topology for the cluster.

This example assumes that `inst1.node1.mycompany.com` and `inst2.node2.mycompany.com` will be the discovery servers for the cluster.

In distributed installations (Oracle HTTP Server and OC4J on different Oracle homes), any instance, whether running Oracle HTTP Server or OC4J, can serve as the discovery server.

2. In the `opmn.xml` file for all instances in the cluster, specify the nodes that are running the discovery servers (`node1.mycompany.com` and `node2.mycompany.com` in the example).

In the example, the `opmn.xml` file is changed to include the following lines:

```
<notification-server>
  <topology>
    <discover
      list="node1.mycompany.com:6201,node2.mycompany.com:6201" />
    </topology>
    ...
  </notification-server>
```

The 6201 specifies the port number at which the notification server is listening. You can find this value in the `opmn.xml` file of that instance.

If you have more than one discovery server, you separate them with the comma character.

3. On all the instances, run "`opmnctl reload`" to force OPMN to read the updated `opmn.xml` file.

```
> ORACLE_HOME/opmn/bin/opmnctl reload
```

6.3.5.2 Setting up Multicast Replication

Multicast replication is the default replication type. To set up an application to use multicast replication, you can just add the empty `<cluster/>` tag to the application's `orion-application.xml` file or to the global `ORACLE_HOME/j2ee/home/config/application.xml` file. For example:

```
<orion-application ... >
  ...
  <cluster/>
```

```
</orion-application>
```

You need to add the `<cluster/>` tag on all nodes where the application is deployed.

By default, multicast replication uses multicast address 230.230.0.1 and port 45566. If you want to change these values, you specify the desired values in the `ip` and `port` attributes of the `multicast` element. For example, the following snippet shows the `ip` and `port` attributes set to customized values:

```
<orion-application ... >
...
<cluster allow-colocation="false">
  <replication-policy trigger="onShutdown" scope="allAttributes"/>
  <protocol>
    <multicast ip="225.130.0.0" port="45577" bind-addr="226.83.24.10"/>
  </protocol>
</cluster>
</orion-application>
```

The multicast address must be between 224.0.1.0 and 239.255.255.255.

Description of other tags and attributes used in the snippet above:

- `allow-colocation`: specifies whether or not application state is replicated to other Oracle Application Server instances running on the same host. The default is `true`.
- `trigger` and `scope`: see [Section 6.3.5.5, "Setting the Replication Policy"](#).
- `bind-addr`: specifies the IP of the network interface card (NIC) to bind to. This is useful if the host machine has multiple NICs, each with its own IP address.

6.3.5.3 Setting up Peer-to-Peer Replication

Oracle Application Server supports two types of peer-to-peer replication: dynamic and static.

- In dynamic peer-to-peer replication, OC4J discovers other OC4J instances through OPMN. You do not have to list the names of the instances in a configuration file.
- In static peer-to-peer replication, you list the names of the instances that you want to be involved in the replication.

Dynamic Peer-to-Peer Replication

To specify dynamic peer-to-peer replication, you include an empty `<opmn-discovery/>` tag in the application's `orion-application.xml` file or in the global `ORACLE_HOME/j2ee/home/config/application.xml` file

```
<orion-application ... >
...
<cluster allow-colocation="false">
  <replication-policy trigger="onShutdown" scope="allAttributes"/>
  <protocol>
    <peer>
      <opmn-discovery/>
    </peer>
  </protocol>
</cluster>
</orion-application>
```

You defined how OPMN discovers instances in a cluster in step 2, "[Install Oracle HTTP Server and OC4J and Cluster the Instances using OPMN](#)" on page 6-9.

Static Peer-to-Peer Replication

To specify static peer-to-peer replication, you list the names of the hosts in the `<node>` element in the application's `orion-application.xml` file or in the global `ORACLE_HOME/j2ee/home/config/application.xml` file. For each node, you specify another node in the active-active topology such that all the nodes in the topology are connected in the chain. For example, if you have three Oracle Application Server instances in your topology, node 1 can specify node 2, node 2 can specify node 3, and node 3 can specify node 1.

Example:

On node 1, the `<node>` tag specifies node 2:

```
<orion-application ... >
...
<cluster allow-colocation="false">
  <replication-policy trigger="onShutdown" scope="allAttributes"/>
  <protocol>
    <peer start-port="7900" range="10" timeout="6000">
      <node host="node2.mycompany.com" port="7900"/>
    </peer>
  </protocol>
</cluster>
</orion-application>
```

On node 2, the `<node>` tag specifies node 3:

```
<orion-application ... >
...
<cluster allow-colocation="false">
  <replication-policy trigger="onShutdown" scope="allAttributes"/>
  <protocol>
    <peer start-port="7900" range="10" timeout="6000">
      <node host="node3.mycompany.com" port="7900"/>
    </peer>
  </protocol>
</cluster>
</orion-application>
```

On node 3, the `<node>` tag specifies node 1:

```
<orion-application ... >
...
<cluster allow-colocation="false">
  <replication-policy trigger="onShutdown" scope="allAttributes"/>
  <protocol>
    <peer start-port="7900" range="10" timeout="6000">
      <node host="node1.mycompany.com" port="7900"/>
    </peer>
  </protocol>
</cluster>
</orion-application>
```

Another way of doing this is to have all the nodes specify the same node. In a three-node example, you could also have nodes 1 and 2 specify node 3, and node 3 can specify either node 1 or node 2.

Description of the tags and attributes used in the example above:

- `start-port`: specifies the first port on the local node that Oracle Application Server tries to bind to for peer communication. If this port is already in use, Oracle

Application Server increments the port number until it finds an available port. The default is 7800.

- `timeout`: specifies the length of time in milliseconds to wait for a response from the specified peer node. The default is 3000 milliseconds.
- `host`: specifies the name of the peer node.
- `port`: specifies the port to use on the specified host (in the `host` attribute) for peer communication. The default is 7800.
- `range`: specifies the number of times to increment the port specified on the `port` (not `start-port`) attribute. The default is 5.

Note the following:

- In static peer-to-peer replication, the application's `orion-application.xml` file is different for each instance. When you deploy your application, you have to make sure that you update the `orion-application.xml` accordingly.

6.3.5.4 Setting up Replication to a Database

In this replication mechanism, the replicated data is saved to a database. You specify the database in the `<database>` tag in the application's `orion-application.xml` file or in the global `ORACLE_HOME/j2ee/home/config/application.xml` file. For example:

```
<orion-application ... >
...
  <cluster allow-colocation="false">
    <replication-policy trigger="onShutdown" scope="allAttributes"/>
    <protocol>
      <database data-source="jdbc/MyOracleDS"/>
    </protocol>
  </cluster>
</orion-application>
```

The value for the `data-source` attribute must match the data source's `jndi-name` as specified in the `data-sources.xml` file. See the *Oracle Containers for J2EE Services Guide* for details on creating and using data sources.

6.3.5.5 Setting the Replication Policy

Attributes in the `<replication-policy>` tag enable you to specify which data is to be replicated and how frequently the data is replicated.

The trigger attribute

The `trigger` attribute specifies when replication occurs. [Table 6-3](#) describes supported values for this attribute:

Table 6–3 Values for the trigger Attribute

Value	HttpSession	Stateful Session Bean
onSetAttribute	Replicate each change made to an HTTP session attribute at the time the value is modified. From a programmatic standpoint, replication occurs each time <code>setAttribute()</code> is called on the <code>HttpSession</code> object. This option can be resource intensive in cases where the session is being extensively modified.	Not applicable.
onRequestEnd (default)	Queue all changes made to HTTP session attributes, then replicate all changes just before the HTTP response is sent.	Replicate the current state of the bean after each EJB method call. The state is replicated frequently, but offers higher reliance.
onShutdown	Replicate the current state of the HTTP session whenever the JVM is terminated gracefully, such as with Control-C. State is not replicated if the host is terminated unexpectedly, as in the case of a system crash. Because session state was not previously replicated, all session data is sent across the network at once upon JVM termination, which can impact network performance. This option can also significantly increase the amount of time needed for the JVM to shut down.	Replicate the current state of the bean whenever the JVM is terminated gracefully. State is not replicated if the host is terminated unexpectedly, as in case of a system crash. Because bean state was not previously replicated, all state data is sent across the network at once upon JVM termination, which can impact network performance. This option may also significantly increase the amount of time needed for the JVM to shut down.

The scope attribute

The `scope` attribute specifies which data is replicated. [Table 6–4](#) describes supported values for the attribute:

Table 6–4 Values for the scope Attribute

Value	HttpSession	Stateful Session Bean
modifiedAttributes	Replicate only the modified HTTP session attributes. This is the default replication setting for <code>HttpSession</code> .	Not applicable.
allAttributes	Replicate all attribute values set on the HTTP session.	Replicate all member variable values set on the stateful session bean. This is the default replication setting for stateful session beans.

6.3.5.6 Specifying the Number of Nodes to Replicate To

To specify the number of nodes to replicate to, use the `write-quota` attribute of the `<cluster>` tag. For example, the following snippet specifies that the replicated data is replicated to two other nodes.

```
<orion-application ... >
...
<cluster allow-colocation="false" write-quota="2">
  <replication-policy trigger="onShutdown" scope="allAttributes"/>
  <protocol>
    <peer>
      <opmn-discovery/>
    </peer>
  </protocol>
</cluster>
</orion-application>
```

The default is 1.

Recommendations: For a two-node active-active topology, set `write-quota` to 1, so that the data is replicated to the other node.

For topologies with three or more nodes, set `write-quota` to at least 2 to ensure that the data is replicated to at least two other nodes.

To replicate data to all nodes in the topology, set `write-quota` to the total number of nodes in the topology. It is possible to write back to the same node if there is another instance running on that node.

The `write-quota` attribute is not used if you are replicating to database.

6.4 Creating the Active-Passive Topology

This section describes how to install Oracle Application Server in an active-passive topology with OracleAS Cold Failover Cluster. OracleAS Cold Failover Cluster is one of the high availability environments supported by Oracle Application Server.

Contents of this section:

- [Section 6.4.1, "Active-Passive Topologies: Introduction"](#)
- [Section 6.4.2, "Overview of Installation Steps for OracleAS Cold Failover Cluster"](#)
- [Section 6.4.3, "Preinstallation Steps for OracleAS Cold Failover Cluster"](#)
- [Section 6.4.4, "OracleAS Cold Failover Cluster: Details of Installation Steps"](#)

6.4.1 Active-Passive Topologies: Introduction

An active-passive topology consists of the following:

- Two nodes in a hardware cluster
- A virtual hostname and IP address
- A shared storage, to be shared between the two nodes

You install the Oracle home on the shared storage. During runtime in an active-passive topology, only one node is active. The other node is passive. The active node mounts the shared storage so that it can access the files and runs all the processes and handles all the requests. Clients access the active node through the virtual hostname. Clients do not need to know the physical hostnames of the nodes in the topology.

If the active node fails for any reason, a failover event occurs and the passive node takes over and becomes the active node. It mounts the shared storage and runs all the processes and handles all the requests. The virtual hostname and IP now point to the passive node. Clients, because they access the nodes using the virtual hostname, do not know that it is the passive node that is servicing their requests.

The nodes need to be in hardware cluster to enable failover.

Note: Installing the Oracle home on the local storage of each node in the OracleAS Cold Failover Cluster topology is not supported. You have to install it on the shared storage.

Vendor Clusterware

The two nodes in an active-passive topology are in a hardware cluster, which typically includes some vendor clusterware. For a list of certified clusterware, visit the Oracle Technology Network website (<http://www.oracle.com/technology>).

These products must be installed on both nodes (active and passive) in the topology.

Figures of Active-Passive Topologies

Figure 6-3 shows a diagram of an active-passive topology with the Oracle Application Server Oracle home installed on the shared storage. The Oracle home contains both Oracle HTTP Server and OC4J. Figure 6-4 shows a distributed active-passive topology, where Oracle HTTP Server and OC4J are installed on different Oracle home.

Figure 6-3 Active-Passive Topology with Oracle HTTP Server and OC4J in the Same Oracle Home

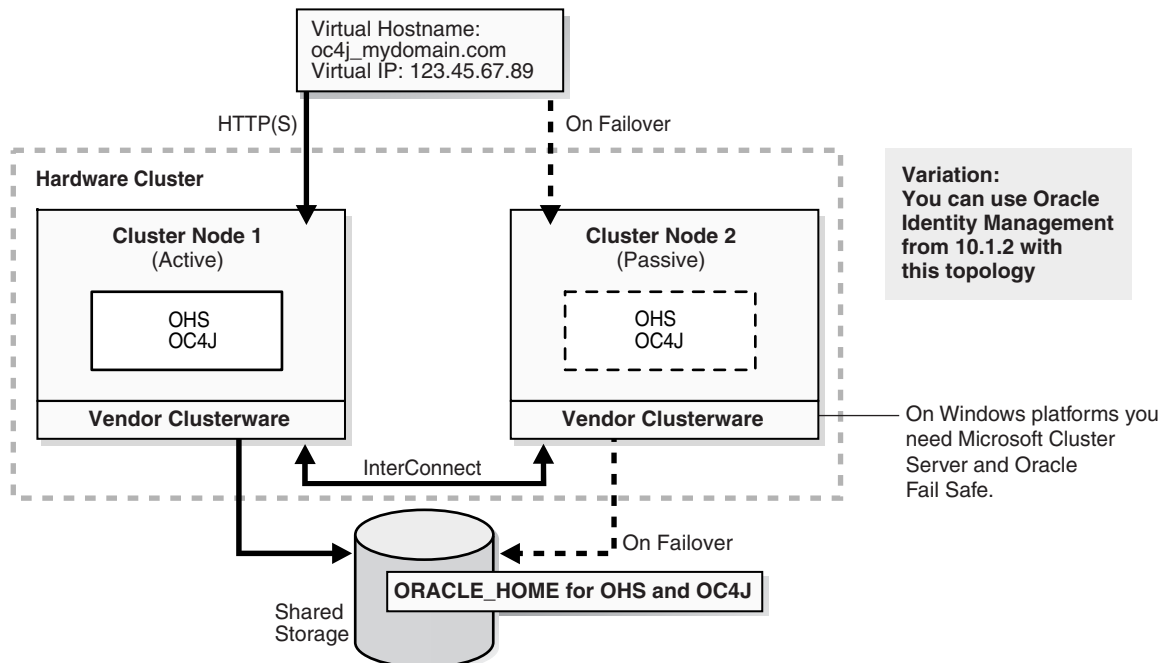
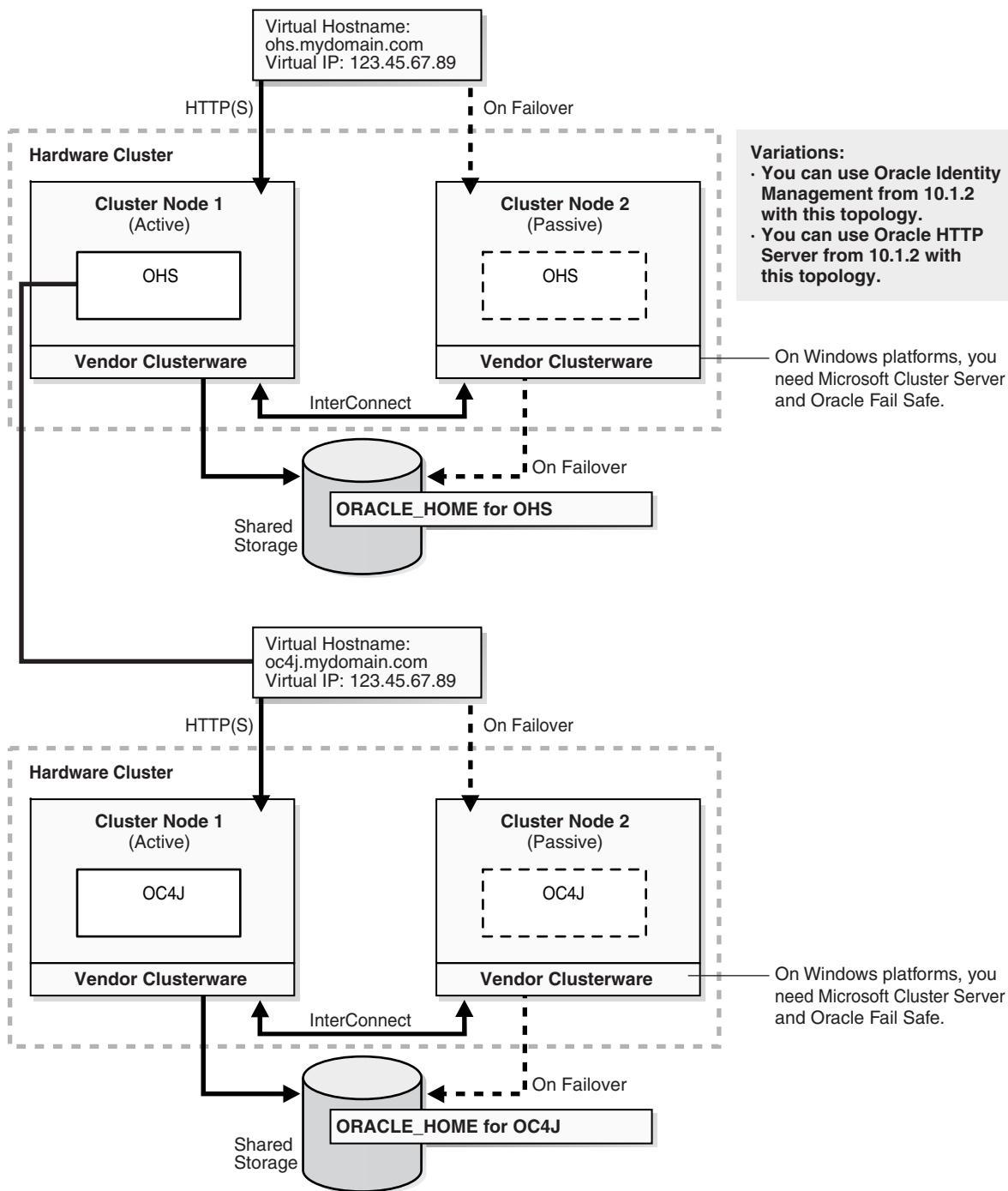

Figure 6–4 Active-Passive Topology with Oracle HTTP Server and OC4J in Separate Oracle Homes



6.4.2 Overview of Installation Steps for OracleAS Cold Failover Cluster

Follow the steps in [Table 6–5](#) to create the OracleAS Cold Failover Cluster configuration. If you are installing Oracle HTTP Server and OC4J in the same Oracle Home ([Figure 6–3](#)), perform the steps on the hardware cluster. If you are installing Oracle HTTP Server and OC4J in separate Oracle Homes ([Figure 6–4](#)), perform each step on both hardware clusters.

Table 6–5 Overview of Installation Steps for OracleAS Cold Failover Cluster

Step	Description
1. Perform Preinstallation Steps	Preinstallation tasks, described in Section 6.4.3 include: <ul style="list-style-type: none"> ▪ Section 6.4.3.1, "Map the Virtual Hostname and Virtual IP Address" ▪ Section 6.4.3.2, "Set Up a File System That Can Be Mounted from Both Nodes"
2. Set VIRTUAL_HOST_NAME Environment Variable	Set the VIRTUAL_HOST_NAME variable to the virtual hostname.
3. Install Oracle Application Server on the Shared Disk	In this step, you run the installer from either node of the hardware cluster to install Oracle HTTP Server and OPMN on the shared disk.
4. (optional) Configure the Oracle Application Server Instance for SSL	If you want the Oracle Application Server instance to use SSL, enable SSL in the Oracle Application Server installation.
5. (optional) Create a File System on the Shared Disk for OracleAS JMS File-Based Persistence	If you are using OracleAS JMS, create a file system on the shared disk.

6.4.3 Preinstallation Steps for OracleAS Cold Failover Cluster

Before installing Oracle Application Server in an OracleAS Cold Failover Cluster, perform these procedures:

- [Section 6.4.3.1, "Map the Virtual Hostname and Virtual IP Address"](#)
- [Section 6.4.3.2, "Set Up a File System That Can Be Mounted from Both Nodes"](#)

Note: In addition to the requirements listed in this chapter, ensure that you meet the requirements described in [Section 6.2, "Requirements for High Availability Configurations"](#).

6.4.3.1 Map the Virtual Hostname and Virtual IP Address

Each node in an OracleAS Cold Failover Cluster configuration is associated with its own physical IP address. In addition, the active node in the cluster is associated with a virtual hostname and virtual IP address. This allows clients to access the OracleAS Cold Failover Cluster using the virtual hostname.

Virtual hostnames and virtual IP addresses are any valid hostname and IP address in the context of the subnet containing the hardware cluster.

Note: Map the virtual hostname and virtual IP address only to the active node. Do not map the virtual hostname and IP address to both active and passive nodes at the same time. When you failover, only then map the virtual hostname and IP address to the passive node, which is now the active node.

Note: Before attempting to complete this procedure, ask the system or network administrator to review all the steps required. The procedure will reconfigure the network settings on the cluster nodes and may vary with differing network implementations.

The following example configures a virtual hostname called `vhost.mydomain.com`, with a virtual IP of `138.1.12.191`:

1. Register the virtual hostname and IP address with DNS for the network.

For example, register the `vhost.mydomain.com/138.1.12.191` pair with DNS.

2. Determine the primary public network interface.

The primary public network interface for Ethernet encapsulation is typically `eth0`. Use the following command and search for a network interface that has an `inet addr` value of the physical IP address of the node:

```
/sbin/ifconfig
```

3. Find an available index number for the primary public network interface.

For example, if the following is the output of the `/sbin/ifconfig` command and `eth0` is determined to be the primary public interface in step 2, then `eth0:1` is available for an additional IP address:

```
eth0      Link encap:Ethernet  HWaddr 00:B0:D0:68:B4:3D
          inet addr:130.35.137.46  Bcast:130.35.139.255 Mask:255.255.252.0
          UP BROADCAST RUNNING MULTICAST  MTU:1500  Metric:1
          RX packets:608598569 errors:8 dropped:0 overruns:0 frame:8
          TX packets:578257570 errors:111 dropped:0 overruns:0 carrier:111
          collisions:0 txqueuelen:100
          RX bytes:2407934851 (2296.3 Mb)  TX bytes:3386476912 (3229.5 Mb)
          Interrupt:26 Base address:0xe0c0 Memory:fbefc000-fbefc038

eth1      Link encap:Ethernet  HWaddr 00:02:B3:28:80:8C
          inet addr:10.0.0.1  Bcast:10.255.255.255 Mask:255.0.0.0
          UP BROADCAST RUNNING MULTICAST  MTU:1500  Metric:1
          RX packets:781415 errors:0 dropped:0 overruns:0 frame:0
          TX packets:725511 errors:0 dropped:0 overruns:0 carrier:0
          collisions:0 txqueuelen:100
          RX bytes:280473135 (267.4 Mb)  TX bytes:254651952 (242.8 Mb)
          Interrupt:23 Base address:0xccc0 Memory:fabff000-fabff038

lo        Link encap:Local Loopback
          inet addr:127.0.0.1 Mask:255.0.0.0
          UP LOOPBACK RUNNING  MTU:16436  Metric:1
          RX packets:114185902 errors:0 dropped:0 overruns:0 frame:0
          TX packets:114185902 errors:0 dropped:0 overruns:0 carrier:0
          collisions:0 txqueuelen:0
          RX bytes:2307872746 (2200.9 Mb)  TX bytes:2307872746 (2200.9 Mb)
```

4. Add the virtual IP address to the primary public network interface by running the following command, as the root user, using the available index number from step 3:

```
/sbin/ifconfig <primary_public_interface>:<available_index> <virtual_ip_
address> netmask <netmask_value> up
```

For example, enter the following command if `eth0:1` is available:

```
/sbin/ifconfig eth0:1 138.1.12.191 up
```

5. Check that the virtual IP address is configured correctly:
 - a. Use the instructions listed in step 2 to confirm the new entry for the `primary_public_interface:available_index` entry created in step 4.

- b. Try to connect to the node using the virtual hostname and virtual IP address from another node. For example, entering both of the following commands from a different node should provide a login to the node you configured in this procedure:

```
telnet hostname.domain
telnet ip_address
```

For example, enter:

```
telnet vhost.mydomain.com
telnet 138.1.12.191
```

On Failover

If the active node fails, then the passive node takes over. If you do not have a clusterware agent to map the virtual IP from the failed node to the passive node, then you have to do it manually. You have to remove the virtual IP mapping from the failed node, and map it to the passive node.

1. On the failed node, remove the virtual IP address by running the following command as the root user:

```
/sbin/ifconfig configured_interface down
```

For example, enter the following command if `eth0:1` is configured with the virtual IP address:

```
/sbin/ifconfig eth0:1 down
```

Note: Use the commands in step 2 of the previous procedure to confirm that the virtual IP address has been removed.

2. On the passive node, add the virtual IP address.

On the passive node, follow steps 2 to 5 of the previous procedure to add and confirm the virtual IP address on the passive node.

6.4.3.2 Set Up a File System That Can Be Mounted from Both Nodes

Although the hardware cluster has shared storage, you need to create a file system on this shared storage such that both nodes of the OracleAS Cold Failover Cluster can mount this file system. You will use this file system for the following directories:

- Oracle home directory for the Oracle Application Server instance
- The oraInventory directory

For disk space requirements, see [Section 2.2, "System Requirements"](#).

If you are running a volume manager on the cluster to manage the shared storage, refer to the volume manager documentation for steps to create a volume. Once a volume is created, you can create the file system on that volume.

If you do not have a volume manager, you can create a file system on the shared disk directly. Ensure that the hardware vendor supports this, that the file system can be mounted from either node of the OracleAS Cold Failover Cluster, and that the file system is repairable from either node if a node fails.

To check that the file system can be mounted from either node, do the following steps:

1. Set up and mount the file system from node 1.
2. Unmount the file system from node 1.
3. Mount the file system from node 2 using the same mount point that you used in step 1.
4. Unmount it from node 2, and mount it on node 1, because you will be running the installer from node 1.

Note: Only one node of the OracleAS Cold Failover Cluster should mount the file system at any given time. File system configuration files on all nodes of the cluster should not include an entry for the automatic mount of the file system upon a node restart or execution of a global mount command. For example, on UNIX platforms, do not include an entry for this file system in `/etc/fstab` file.

6.4.4 OracleAS Cold Failover Cluster: Details of Installation Steps

This section lists the steps for installing OracleAS Cold Failover Cluster.

If you are installing Oracle HTTP Server and OC4J in separate Oracle Homes, you need to perform each of these steps on both clusters.

Step 1 Perform Preinstallation Steps

Perform the preinstallation steps listed in [Section 6.4.3, "Preinstallation Steps for OracleAS Cold Failover Cluster"](#).

Step 2 Set VIRTUAL_HOST_NAME Environment Variable

Set the `VIRTUAL_HOST_NAME` environment variable to the virtual hostname on either node of the hardware cluster. You will perform the install from this node onto the shared disk in the next step. To find out more about how to set environment variables, see [Section 2.10, "Environment Variables"](#).

Step 3 Install Oracle Application Server on the Shared Disk

Install Oracle Application Server on the shared disk of the hardware cluster from the node where you set the `VIRTUAL_HOST_NAME` environment variable.

- **For OracleAS Cold Failover Cluster with Oracle HTTP Server and OC4J in the Same Oracle Home**

Follow the steps in [Section 5.2.3, "Installing J2EE Server and Web Server"](#). During installation, perform the following actions:

- On the "Administration Instance Settings" screen, select **Configure this as an Administration OC4J instance** if you want to configure Application Server Control for administering the OC4J instance. Otherwise, deselect this option.

- **For OracleAS Cold Failover Cluster with Oracle HTTP Server and OC4J in Separate Oracle Homes**

If you are installing on the hardware cluster where you want to run Oracle HTTP Server, follow the steps in [Section 5.2.5, "Installing Web Server"](#). During installation, perform the following actions:

- If you want to route all requests to OC4J through the Oracle HTTP Server, select **Configure this HTTP Server instance to be part of an Oracle**

Application Server cluster on the "Cluster Topology Configuration" screen. Specify the **IP Address** and **Port** for the multicast address shared by all the nodes in the cluster.

- If you do not want to route all requests to OC4J through the Oracle HTTP Server, deselect **Configure this HTTP Server instance to be part of an Oracle Application Server cluster** on the "Cluster Topology Configuration" screen.

If you are installing on the hardware cluster where you want to run OC4J, follow the steps in [Section 5.2.4, "Installing J2EE Server"](#). During installation, perform the following actions:

- On the "Administration Instance Settings" screen, select **Configure this as an Administration OC4J instance** if you want to configure Application Server Control for administering the OC4J instance. Otherwise, deselect this option.
- If you want to route all requests to OC4J through the Oracle HTTP Server, select **Configure this OC4J instance to be part of an Oracle Application Server cluster topology** on the "Cluster Topology Configuration" screen. Specify the **IP Address** and **Port** for the multicast address shared by all the nodes in the cluster. Select **Access this OC4J Instance from a separate Oracle HTTP Server**.
- If you do not want to route all requests to OC4J through the Oracle HTTP Server, deselect **Configure this OC4J instance to be part of an Oracle Application Server cluster topology** on the "Cluster Topology Configuration" screen.

Step 4 (optional) Configure the Oracle Application Server Instance for SSL

If you want the Oracle Application Server instance to use SSL, follow the steps in the *Oracle Application Server Administrator's Guide*.

Step 5 (optional) Create a File System on the Shared Disk for OracleAS JMS File-Based Persistence

If you are using OracleAS JMS with file-based persistence, create a file system on the shared disk for the OracleAS JMS queues, and mount this file system from node 1.

6.5 Creating an OracleAS Disaster Recovery Configuration

This section describes how to install Oracle Application Server in OracleAS Disaster Recovery configurations. OracleAS Disaster Recovery is one of the high availability environments supported by Oracle Application Server.

Contents of this section:

- [Section 6.5.1, "OracleAS Disaster Recovery: Introduction"](#)
- [Section 6.5.2, "Setting up the OracleAS Disaster Recovery Environment"](#)
- [Section 6.5.3, "Installing Oracle Application Server in an OracleAS Disaster Recovery Environment"](#)
- [Section 6.5.4, "Installing the OracleAS 10g \(10.1.3.1.0\) Standalone Install of OracleAS Guard into Oracle Homes"](#)
- [Section 6.5.5, "Patching OracleAS Guard Release 10.1.2.n.n with Release 10.1.3.1.0"](#)
- [Section 6.5.6, "What to Read Next"](#)

6.5.1 OracleAS Disaster Recovery: Introduction

Use the OracleAS Disaster Recovery environment when you want to have two physically separate sites in your environment. One site is the production site, and the other site is the standby site. The production site is active, while the standby site is passive; the standby site becomes active when the production site goes down.

OracleAS Disaster Recovery supports a number of basic topologies for the configuration of the Infrastructure and middle tier on production and standby sites. OracleAS Disaster Recovery supports these basic topologies:

- Symmetrical topologies -- strict mirror of the production site with collocated Oracle Identity Management and OracleAS Metadata Repository Infrastructure
- Asymmetrical topologies -- simple asymmetric standby topology with collocated Oracle Identity Management and OracleAS Metadata Repository Infrastructure
- Separate OracleAS Metadata Repository for OracleAS Portal with collocated Oracle Identity Management and OracleAS Metadata Repository Infrastructure (the Departmental Topology)
- Distributed Application OracleAS metadata Repositories with Non collocated Oracle Identity Management and OracleAS Metadata Repository Infrastructure
- Redundant Multiple OracleAS 10.1.3 Home J2EE Topology
- Redundant Single OracleAS 10.1.3 Home J2EE Topology Integrated with an Existing Oracle Identity Management 10.1.2.0.2 Topology

In a symmetric topology, each node in the standby site corresponds to a node in the production site. This includes the nodes running both OracleAS Infrastructure and middle tiers. In an asymmetric topology, the number of instances required on the standby site are fewer than the number on the production site and the number of instances required on the standby site must be the minimum set of instances required to run your site in the event of a switchover or failover operation. The last two supported topologies are particularly important in OracleAS Release 10.1.3.1.0. See the *Oracle Application Server High Availability Guide* for a detailed description of these topologies.

As a small variation to this environment, you can set up the OracleAS Infrastructure on the production site in an OracleAS Cold Failover Cluster environment. See [Section 6.5.2.4, "If You Want to Use OracleAS Cold Failover Cluster on the Production Site \(OracleAS 10.1.2.n.n only\)"](#) for details.

For these supported topologies, OracleAS Guard will be installed in every Oracle home on every system that is part of your production and standby topology configured for the OracleAS Disaster Recovery solution.

OracleAS Guard can be installed as a standalone install kit located on OracleAS Companion CD #2. See [Section 6.5.4, "Installing the OracleAS 10g \(10.1.3.1.0\) Standalone Install of OracleAS Guard into Oracle Homes"](#) for more information about when this standalone kit should be installed.

[Figure 6–5](#) shows an example symmetric OracleAS Disaster Recovery environment. Each site has two nodes running middle tiers and a node running OracleAS Infrastructure.

Data Synchronization

For OracleAS Disaster Recovery to work, data between the production and standby sites must be synchronized so that failover can happen very quickly. Configuration changes done at the production site must be synchronized with the standby site.

You need to synchronize two types of data. The synchronization method depends on the type of data:

- Use Oracle Data Guard to synchronize data in the OracleAS Metadata Repository databases on the production and standby sites. You can configure Oracle Data Guard to perform the synchronization.
- Use the backup and recovery scripts to synchronize data outside of the database (such as data stored in configuration files).

See the *Oracle Application Server High Availability Guide* for details on how to use Oracle Data Guard and the backup and recovery scripts.

Figure 6–5 OracleAS Disaster Recovery Environment

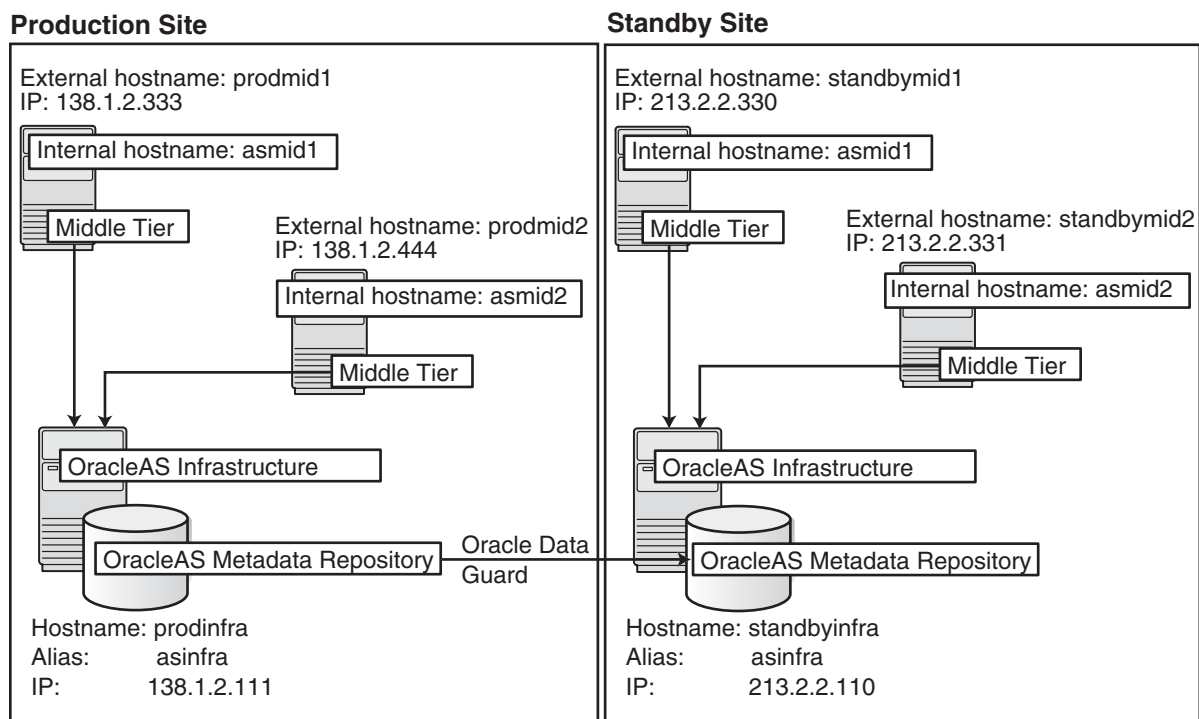

6.5.2 Setting up the OracleAS Disaster Recovery Environment

Before you can install Oracle Application Server in an OracleAS Disaster Recovery environment, you have to perform these steps:

- [Section 6.5.2.1, "Ensure Nodes Are Identical at the Operating System Level"](#)
- [Section 6.5.2.2, "Set Up staticports.ini File"](#)
- [Section 6.5.2.3, "Set Up Identical Hostnames on Both Production and Standby Sites"](#)
- [Section 6.5.2.4, "If You Want to Use OracleAS Cold Failover Cluster on the Production Site \(OracleAS 10.1.2.n.n only\)"](#)

6.5.2.1 Ensure Nodes Are Identical at the Operating System Level

Ensure that the nodes are identical with respect to the following items:

- The nodes are running the same version of the operating system.

- The nodes have the same operating system patches and packages.
- You can install Oracle Application Server in the same directory path on all nodes.

6.5.2.2 Set Up `staticports.ini` File

The same component must use the same port number on the production and standby sites. For example, if Oracle HTTP Server is using port 80 on the production site, it must also use port 80 on the standby site. To ensure this is the case, create a `staticports.ini` file for use during installation. This file enables you to specify port numbers for each component. See [Section 2.5.3, "Using Custom Port Numbers \(the "Static Ports" Feature\)"](#) for details.

6.5.2.3 Set Up Identical Hostnames on Both Production and Standby Sites

The names of the corresponding nodes on the production and standby sites must be identical, so that when you synchronize data between the sites, you do not have to edit the data to fix the hostnames.

For the Infrastructure Nodes

For the node running the infrastructure, set up a virtual name. To do this, specify an alias for the node in the `/etc/hosts` file.

For example, on the infrastructure node on the production site, the following line in the `hosts` file sets the alias to `asinfra`:

```
138.1.2.111 prodinfra asinfra
```

On the standby site, the following line sets the node's alias to `asinfra`.

```
213.2.2.110 standbyinfra asinfra
```

When you install OracleAS Infrastructure on the production and standby sites, you specify this alias (`asinfra`) in the Specify Virtual Hostname screen. The configuration data will then contain this alias for the infrastructure nodes.

For the Middle-Tier Nodes

For the nodes running the middle tiers, you cannot set up aliases like you did for the infrastructure nodes because the installer does not display the Specify Virtual Hostname screen for middle-tier installations. When installing middle tiers, the installer determines the hostname automatically by calling the `gethostname()` function. You want to be sure that for each middle-tier node on the production site, the corresponding node on the standby site returns the same hostname.

To do this, set up a local, or internal, hostname, which could be different from the public, or external, hostname. You can change the names of the nodes on the standby site to match the names of the corresponding nodes on the production site, or you can change the names of the nodes on both production and standby sites to be the same. This depends on other applications that you might be running on the nodes, and whether changing the node name will affect those applications.

1. On the nodes whose local names you want to change, reconfigure the node so that the `hostname` command returns the new local hostname.

Note: The procedure to change the hostname of a system differs between different operating systems. Contact the system administrator of your system to perform this step. Note also that changing the hostname of a system will affect installed software that has a dependency on the previous hostname. Consider the impact of this before changing the hostname.

2. Enable the other nodes in the OracleAS Disaster Recovery environment to be able to resolve the node using the new local hostname. You can do this in one of two ways:

Method 1: Set up separate internal DNS servers for the production and standby sites. This configuration allows nodes on each site (production or standby) to resolve hostnames within the site. Above the internal DNS servers are the corporate, or external, DNS servers. The internal DNS servers forward non-authoritative requests to the external DNS servers. The external DNS servers do not know about the existence of the internal DNS servers. See [Figure 6-6](#).

Figure 6-6 Method 1: Using DNS Servers

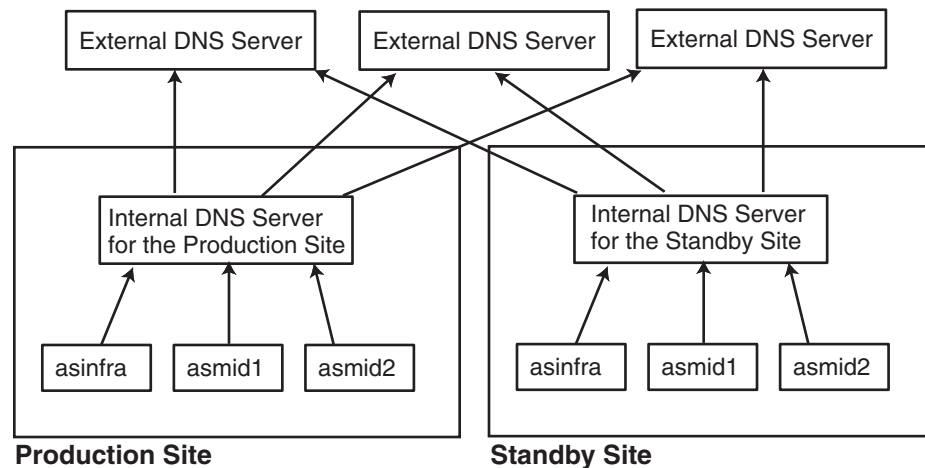

Method 1 Details

- a. Make sure the external DNS names are defined in the external DNS zone.

Example:

```

prodmid1.us.oracle.com    IN  A  138.1.2.333
prodmid2.us.oracle.com    IN  A  138.1.2.444
prodingf.us.oracle.com    IN  A  138.1.2.111
standbymid1.us.oracle.com IN  A  213.2.2.330
standbymid2.us.oracle.com IN  A  213.2.2.331
standbyinf.us.oracle.com  IN  A  213.2.2.110
    
```

- b. At the production site, create a new zone at the production site using a domain name different from your external domain name. To do this, populate the zone data files with entries for each node in the OracleAS Disaster Recovery environment.

For the infrastructure node, use the virtual name or alias.

For the middle-tier nodes, use the node name (the value in `/etc/nodename`).

The following example uses "asha" as the domain name for the new zone.

```
asmid1.asha    IN  A  138.1.2.333
asmid2.asha    IN  A  138.1.2.444
asinfra.asha   IN  A  138.1.2.111
```

Do the same for the standby site. Use the same domain name that you used for the production site.

```
asmid1.asha    IN  A  213.2.2.330
asmid1.asha    IN  A  213.2.2.331
asinfra.asha   IN  A  213.2.2.110
```

- c. Configure the DNS resolver to point to the internal DNS servers instead of the external DNS server.

In the `/etc/resolv.conf` file for each node on the production site, replace the existing name server IP address with the IP address of the internal DNS server for the production site.

Do the same for the nodes on the standby site, but use the IP address of the internal DNS server for the standby site.

- d. Create a separate entry for Oracle Data Guard in the internal DNS servers. This entry is used by Oracle Data Guard to ship redo data to the database on the standby site.

In the next example, the "remote_infra" entry points to the infrastructure node on the standby site. This name is used by the TNS entries on both the production and standby sites so that if a switchover occurs, the entry does not have to be changed.

Figure 6–7 Entry for Oracle Data Guard in the Internal DNS Servers

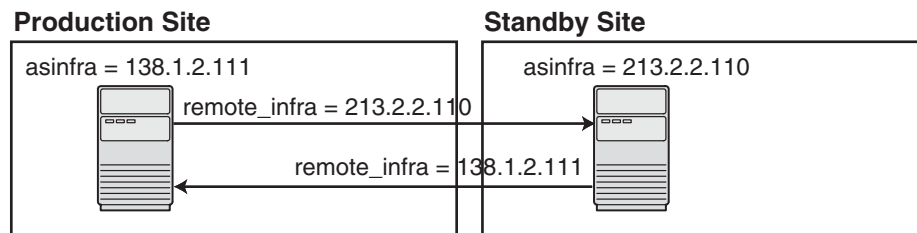

On the production site, the DNS entries look like this:

```
asmid1.asha    IN  A  138.1.2.333
asmid2.asha    IN  A  138.1.2.444
asinfra.asha   IN  A  138.1.2.111
remote_infra.asha IN A  213.2.2.110
```

On the standby site, the DNS entries look like this:

```
asmid1.asha    IN  A  213.2.2.330
asmid2.asha    IN  A  213.2.2.331
asinfra.asha   IN  A  213.2.2.110
remote_infra.asha IN A  138.1.2.111
```

Method 2: Edit the `/etc/hostsfile` on each node on both sites. This method does not involve configuring DNS servers, but you have to maintain the `hosts` file on each node in the OracleAS Disaster Recovery environment. For example, if an IP

address changes, you have to update the files on all the nodes, and restart the nodes.

Method 2 Details

- a. On each node on the production site, include these lines in the `/etc/hosts` file. The IP addresses resolve to nodes on the production site.

Note: In the `hosts` file, be sure that the line that identifies the current node comes *immediately* after the `localhost` definition (the line with the 127.0.0.1 address).

```
127.0.0.1    localhost
138.1.2.333  asmid1.oracle.com  asmid1
138.1.2.444  asmid2.oracle.com  asmid2
138.1.2.111  asinfra.oracle.com asinfra
```

- b. On each node on the standby site, include these lines in the `hosts` file. The IP addresses resolve to nodes on the standby site.

Note: In the `hosts` file, be sure that the line that identifies the current node comes *immediately* after the `localhost` definition (the line with the 127.0.0.1 address).

```
127.0.0.1    localhost
213.2.2.330  asmid1.oracle.com  asmid1
213.2.2.331  asmid2.oracle.com  asmid2
213.2.2.110  asinfra.oracle.com asinfra
```

- c. Ensure that the "hosts:" line in the `/etc/nsswitch.conf` file has "files" as the first item:

```
hosts:    files nis dns
```

The entry specifies the ordering of the name resolution. If another method is listed first, then the node will use the other method to resolve the hostname.

Note: Restart the nodes after editing these files.

Verifying that the Nodes Resolve the Hostnames Correctly

After making the changes and restarting the nodes, check that the nodes resolve the hostnames properly by running the following commands:

- On the middle-tier nodes on both sites, you must set the internal hostname. For example, for the `prodmid1` middle-tier, set the internal hostname as `asmid1` as follows:

```
> hostname asmid1
```

- On the middle-tier nodes on both sites, run the `hostname` command. This should return the internal hostname. For example, the command should return "asmid1" if you run it on `prodmid1` and `standbymid1`.

```
prompt> hostname
asmid1
```

- On each node, ping the other nodes in the environment using the internal hostname as well as the external hostname. The command should be successful. For example, from the first midtier node, `prodmid1`, run the following commands:

```
prompt> ping prodinfra ping the production infrastructure node
PING prodinfra: 56 data bytes
64 bytes from prodinfra.oracle.com (138.1.2.111): icmp_seq=0. time=0. ms
^C

prompt> ping iasinfra ping the production infrastructure node
PING iasinfra: 56 data bytes
64 bytes from iasinfra.oracle.com (138.1.2.111): icmp_seq=0. time=0. ms
^C

prompt> ping iasmid2 ping the second production midtier node
PING iasmid2: 56 data bytes
64 bytes from iasmid2.oracle.com (138.1.2.444): icmp_seq=0. time=0. ms
^C

prompt> ping prodmid2 ping the second production midtier node
PING prodmid2: 56 data bytes
64 bytes from prodmid2.oracle.com (138.1.2.444): icmp_seq=0. time=0. ms
^C

prompt> ping standbymid1 ping the first standby midtier node
PING standbymid1: 56 data bytes
64 bytes from standbymid1.oracle.com (213.2.2.330): icmp_seq=0. time=0. ms
^C
```

6.5.2.4 If You Want to Use OracleAS Cold Failover Cluster on the Production Site (OracleAS 10.1.2.n.n only)

Note: You must perform this installation in an OracleAS Release 10.1.2.n.n environment, where *n.n* represents 0.0 or higher. This information is presented here for informative purposes only.

On the production site of a OracleAS Disaster Recovery system, you can set up the OracleAS Infrastructure to run in a OracleAS Cold Failover Cluster configuration. In this case, you have two nodes in a hardware cluster, and you install the OracleAS Infrastructure on a shared disk. See Chapter 11, "Installing in High Availability Environments: OracleAS Cold Failover Cluster" in the *Oracle Application Server Installation Guide 10g Release 2 (10.1.2)* Documentation set for details.

Figure 6–8 Infrastructure in an OracleAS Cold Failover Cluster Configuration

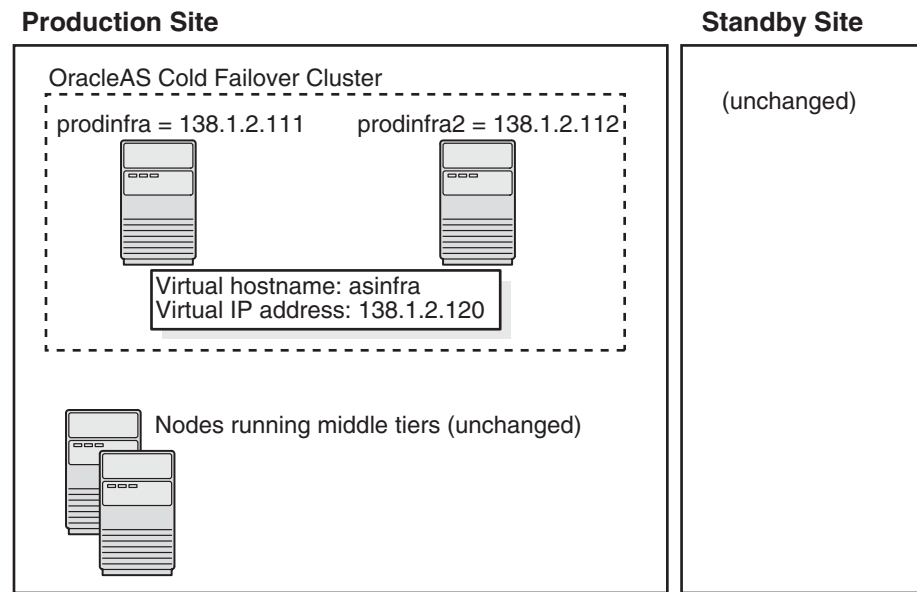

To set up OracleAS Cold Failover Cluster in this environment, use the virtual IP address (instead of the physical IP address) for asinfra.asha on the production site. The following example assumes 138.1.2.120 is the virtual IP address.

```

asmid1.asha      IN  A  138.1.2.333
asmid2.asha      IN  A  138.1.2.444
asinfra.asha     IN  A  138.1.2.120      this is a virtual IP address
remote_infra.asha IN  A  213.2.2.110
    
```

On the standby site, you still use the physical IP address for asinfra.asha, but the remote_infra.asha uses the virtual IP address.

```

asmid1.asha      IN  A  213.2.2.330
asmid2.asha      IN  A  213.2.2.331
asinfra.asha     IN  A  213.2.2.110      physical IP address
remote_infra.asha IN  A  138.1.2.120      virtual IP address
    
```

6.5.3 Installing Oracle Application Server in an OracleAS Disaster Recovery Environment

For OracleAS Release 10.1.3.1.0, you can only install middle tiers on the production and standby sites.

Install Oracle Application Server as follows:

Note: For all of the installations, be sure to use staticports.ini to specify port numbers for the components. See [Section 6.5.2.2, "Set Up staticports.ini File"](#).

Install Middle Tiers (OracleAS Release 10.1.3.1.0 only)

1. Install middle tiers on the production site.
2. Install middle tiers on the standby site.

Install OracleAS Infrastructure and Middle Tiers (Release 10.1.2.n.n only)

Note: You must perform this installation in an OracleAS Release 10.1.2.n.n environment, where *n.n* represents 0.0 or higher. This information is presented here for informative purposes only.

1. Install OracleAS Infrastructure on the production site.
2. Install OracleAS Infrastructure on the standby site.
3. Start the OracleAS Infrastructure in each site before installing the middle tiers for that site.
4. Install middle tiers on the production site.
5. Install middle tiers on the standby site.

6.5.3.1 Installing the OracleAS Infrastructure (OracleAS Release 10.1.2.n.n Only)

Note: You must perform this installation in an OracleAS Release 10.1.2.n.n environment, where *n.n* represents 0.0 or higher. This information is presented here for informative purposes only.

In an OracleAS Release 10.1.2.0.0 environment, you must install the Oracle Identity Management and the OracleAS Metadata Repository components of OracleAS Infrastructure on the same node. You cannot distribute the components over multiple nodes. In an OracleAS Release 10.1.2.0.2 environment, you can distribute the components over multiple nodes.

The installation steps are similar to that for OracleAS Cold Failover Cluster. See Section 11.3, "Installing an OracleAS Cold Failover Cluster (Infrastructure) Configuration" in the *Oracle Application Server Installation Guide 10g Release 2 (10.1.2)* Documentation set for the screen sequence.

Note the following points:

- Select Configuration Options screen: be sure you select **High Availability and Replication**. See Table 11–5, step 2.
- Specify Virtual Hostname screen: enter an alias as the virtual address (for example, asinfra.oracle.com). See Table 11–5, step 6.

6.5.3.2 Installing Middle Tiers (OracleAS Release 10.1.3.1.0 and 10.1.2.n.n)

Depending on your configuration, you can install OracleAS 10.1.3.1.0 middle tiers or OracleAS 10.1.2.n.n middle tiers, where *n.n* represents 0.0 or higher.

OracleAS Release 10.1.3.1.0

On OracleAS release 10.1.3.1.0, you can install any type of middle tier that you like:

For installing J2EE Server, see [Section 5.2.4, "Installing J2EE Server"](#).

For installing Web Server, see [Section 5.2.5, "Installing Web Server"](#).

For installing J2EE Server and Web Server, see [Section 5.2.3, "Installing J2EE Server and Web Server"](#).

For installing J2EE Server, Web Server and SOA Suite, see [Section 5.2.2, "Installing J2EE Server, Web Server and SOA Suite"](#).

OracleAS Release 10.1.2.n.n

Note: You must perform this installation in an OracleAS Release 10.1.2.n.n environment, where *n.n* represents 0.0 or higher. This information is presented here for informative purposes only.

On OracleAS Release 10.1.2.n.n, you can install any type of middle tier that you like:

For installing J2EE and Web Cache, see Section 7.9 "Installing J2EE and Web Cache in a Database-Based Farm Repository and with Oracle Identity Management Access" in the *Oracle Application Server Installation Guide* for 10g Release 2 (10.1.2).

For installing Portal and Wireless or Business Intelligence and Forms, see Section 7.13, "Installing Portal and Wireless or Business Intelligence and Forms".

Note the following points on OracleAS 10.1.2.n.n:

- When the installer prompts you to register with Oracle Internet Directory, and asks you for the Oracle Internet Directory hostname, enter the alias of the node running OracleAS Infrastructure (for example, asinfra.oracle.com).

6.5.4 Installing the OracleAS 10g (10.1.3.1.0) Standalone Install of OracleAS Guard into Oracle Homes

OracleAS 10g (10.1.3.1.0) standalone install of OracleAS Guard is located on Companion CD Disk 2. This standalone install of OracleAS Guard can be installed in the following environments:

- In its own home in the case when you are cloning an instance or topology to a new standby system (see the section on standby site cloning in *Oracle Application Server High Availability Guide* for more information).
- Oracle database server home for an OracleAS Metadata Repository configuration created using OracleAS Metadata Repository Creation Assistant.
- OracleAS Disaster Recovery full site upgrade from OracleAS 10g (9.0.4) to OracleAS 10g (10.1.3.1.0) (see the chapter on OracleAS Disaster Recovery site upgrade procedure in *Oracle Application Server High Availability Guide* for more information).
- OracleAS Guard patch upgrade from OracleAS 10g (10.1.2.0.0) to OracleAS 10g (10.1.2.0.2) (see [Section 6.5.5, "Patching OracleAS Guard Release 10.1.2.n.n with Release 10.1.3.1.0"](#) for more information).

If this is an upgrade installation of OracleAS Guard, make a copy of your `dsa.conf` configuration file to save your current settings for your OracleAS Guard environment. After running the OracleAS 10g (10.1.3.1.0) standalone install kit of OracleAS Guard, you can restore your saved `dsa.conf` configuration file with your settings to continue using the same settings for the upgraded OracleAS Guard environment.

To run the OracleAS 10g (10.1.3.1.0) standalone install kit of OracleAS Guard, run the kit in the following directory path:

On UNIX systems:

```
/Disk2/asg/install/runInstaller
```

Choose the type of install that you want. Choose **Typical** for most installations. Choose **Custom or Reinstall** for upgrading from an older release of OracleAS Guard to the current release.

Enter the `oc4jadmin` account password to continue the installation.

6.5.5 Patching OracleAS Guard Release 10.1.2.n.n with Release 10.1.3.1.0

If you already have an OracleAS Disaster Recovery environment set up using OracleAS Guard Release 10.1.2.n.n (where *n.n* represents 0.0 or higher, you can patch OracleAS Guard in your environment to take advantage of new features and support for the topologies described in [Section 6.5.1, "OracleAS Disaster Recovery: Introduction"](#). To patch your OracleAS Disaster Recovery environment, follow these basic steps:

1. Stop the OracleAS Guard server in all OracleAS 10.1.2.n.n Oracle homes on both production and standby sites using the following `opmnctl` command:

On UNIX systems:

```
<ORACLE_HOME>/opmn/bin/opmnctl stopall
```

2. Install the OracleAS 10g (10.1.3.1.0) standalone install of OracleAS Guard into each Oracle home on the production and standby sites.

If multiple Oracle homes exist on the same system, ensure that different ports are configured for each of the OracleAS Guard servers in this configuration file.

Because this is an upgrade installation of OracleAS Guard, make a copy of your `dsa.conf` configuration file to save your current settings for your OracleAS Guard environment. After running the OracleAS 10g (10.1.3.1.0) standalone install kit of OracleAS Guard, you can restore your saved `dsa.conf` configuration file with your settings to continue using the same settings for the upgraded OracleAS Guard environment.

On UNIX systems:

```
<ORACLE_HOME>/dsa/dsa.conf
```

3. Start the OracleAS Guard server in all OracleAS 10.1.3.1.0 Oracle homes on both production and standby sites using the following `opmnctl` command:

On UNIX systems:

```
<ORACLE_HOME>/opmn/bin/opmnctl startall  
<ORACLE_HOME>/opmn/bin/opmnctl startproc ias-component=ASG
```

6.5.6 What to Read Next

For information on how to manage your OracleAS Disaster Recovery environment, such as setting up Oracle Data Guard and configuring the OracleAS Metadata Repository database, see the *Oracle Application Server High Availability Guide*.

Postinstallation Tasks

Contents:

- [Section 7.1, "State of Oracle Application Server Instances After Installation"](#)
- [Section 7.2, "Passwords for Oracle Application Server Components"](#)
- [Section 7.3, "NFS Installations"](#)
- [Section 7.4, "Configuring OracleAS Clusters"](#)
- [Section 7.5, "Backup and Recovery"](#)
- [Section 7.6, "SSL"](#)
- [Section 7.7, "Operating System Locale and NLS_LANG Environment Variable"](#)
- [Section 7.8, "Proxy Settings"](#)
- [Section 7.9, "What to Do Next"](#)

7.1 State of Oracle Application Server Instances After Installation

After installation, the components that you have configured are started up (unless you have configured them to use ports lower than 1024, in which case you have to start them up manually).

You can view the Welcome page and the Application Server Control page in a browser. The URLs for these pages are shown in the last screen of the installer. You can view the contents of the last screen in the file `ORACLE_HOME/install/readme.txt`.

You can use scripts or you can use the Oracle Enterprise Manager 10g Application Server Control to start and stop Oracle Application Server instances. See the *Oracle Application Server Administrator's Guide* for details.

7.2 Passwords for Oracle Application Server Components

By default, all passwords for Oracle Application Server components are set to be the same as the Oracle Application Server instance password. For security reasons, you should change the passwords of the various components to have different values.

See the *Oracle Application Server Administrator's Guide* and the component guides in the Oracle Application Server Documentation Library for details on how to alter the passwords for the components you have installed.

7.3 NFS Installations

If you installed Oracle Application Server on an NFS disk, you need to edit the `LockFile` directive in the `ORACLE_HOME/Apache/Apache/conf/httpd.conf` file so that it points to a local disk. This file is used by the Oracle HTTP Server component.

See the *Oracle HTTP Server Administrator's Guide* for details.

7.4 Configuring OracleAS Clusters

If you did not configure OracleAS Clusters during installation, you can use Oracle Process Manager and Notification Server (OPMN) commands to do so following installation. See "Configuring Cluster Topologies" in the *Oracle Application Server Administrator's Guide* for details.

7.5 Backup and Recovery

After installation would be a good time to start backing up the files, and to set up your backup and recovery strategy. See the *Oracle Application Server Administrator's Guide* for details.

7.6 SSL

By default, all components are configured for SSL. For more information, see the SSL section in the *Oracle Application Server Administrator's Guide*.

7.7 Operating System Locale and NLS_LANG Environment Variable

If you installed Oracle Application Server in a non-English language environment, please check your settings as described in these sections:

- [Section 7.7.1, "Check the Operating System Locale"](#)
- [Section 7.7.2, "Check the NLS_LANG Setting"](#)

7.7.1 Check the Operating System Locale

To make sure the default locale is set properly, verify that the `LC_ALL` or `LANG` environment variables are set with the appropriate values. To check the current setting, run the `locale` command:

```
prompt> locale
```

7.7.2 Check the NLS_LANG Setting

To check the `NLS_LANG` setting:

1. Make sure the value of the `NLS_LANG` environment variable is compatible with the default locale setting of the operating system. See the *Oracle Application Server Globalization Guide* for details, including a list of files that set this variable. You might need to edit the value of the `NLS_LANG` variable in these files.
2. Check that the `NLS_LANG` setting in the `ORACLE_HOME/opmn/conf/opmn.xml` file is identical to the `NLS_LANG` environment variable.

Example: The `NLS_LANG` setting in the `opmn.xml` file might look something like this:

```

<environment>
  <variable id="TMP" value="/tmp"/>
  <variable id="NLS_LANG" value="JAPANESE_JAPAN.JA16SJIS"/>
</environment>

```

7.8 Proxy Settings

If you want the Oracle Application Server instance to use a proxy server, perform the following steps:

1. Run the following command to shutdown all processes:

```
prompt> ORACLE_HOME/opmn/bin/opmnctl shutdown
```

2. To set the proxy server for BPEL, modify the following lines in the ORACLE_HOME/bpel/bin/obsetenv.sh file:

```

PROXY_SET="true"
...
if [ "${PROXY_SET}" = "true" ]
then
  OB_JAVA_PROPERTIES="-Dhttp.proxySet=true -Dhttp.proxyHost=proxy_server_
hostname -Dhttp.proxyPort=proxy_server_port -Dhttp.nonProxyHosts=localhost|non_
proxy_host|other_non_proxy_hosts"

```

3. To set the proxy server for OC4J, modify the following lines for the OC4J module in the ORACLE_HOME/opmn/config/opmn.xml file:

```

<process-type id="oc4j_instance_name" module-id="OC4J" status="enabled">
  <module-data>
    <category id="start-parameters">
      <data id="java-options" value= ...
        -Dhttp.proxySet=true -Dhttp.proxyHost=proxy_server_hostname
        -Dhttp.proxyPort=proxy_server_port
        -Dhttp.nonProxyHosts=localhost|non_proxy_host|other_non_proxy_hosts"/>
    </category>

```

7.9 What to Do Next

After installing Oracle Application Server, you should read the *Oracle Application Server Administrator's Guide*. Specifically, you should read the "Getting Started After Installing Oracle Application Server" chapter.

You should also perform a complete Oracle Application Server environment backup after installing Oracle Application Server. This enables you to restore a working environment in case something goes wrong. For details on how to perform a complete Oracle Application Server environment backup, see the *Oracle Application Server Administrator's Guide*.

You should also perform a complete Oracle Application Server environment backup after each successful patchset upgrade and after each successful configuration change.

Silent and Non-Interactive Installation

This appendix describes how to install Oracle Application Server in silent mode. This appendix contains the following topics:

- [Section A.1, "Silent Installation"](#)
- [Section A.2, "Non-Interactive Installation"](#)
- [Section A.3, "Preinstallation"](#)
- [Section A.4, "Create the Response File"](#)
- [Section A.5, "Start the Installation"](#)
- [Section A.6, "Postinstallation"](#)
- [Section A.7, "Security Tips for Silent and Non-Interactive Installations"](#)
- [Section A.8, "Deinstallation"](#)

A.1 Silent Installation

Silent installation eliminates the need to monitor the Oracle Application Server installation because there is no graphical output and no input by the user.

Silent installation of Oracle Application Server is accomplished by supplying the Oracle Universal Installer with a response file and specifying the `-silent` flag on the command line. The response file is a text file containing variables and parameter values which provide answers to the installer prompts.

If this is a first time installation of Oracle Application Server, you must create the `oraInst.loc` file before starting. File creation is described in [Section A.3, "Preinstallation"](#).

Following installation of Oracle Application Server, you need to run the `root.sh` script as the root user. The `root.sh` script detects settings of environment variables and enables you to enter the full path of the local bin directory.

Use silent installation of Oracle Application Server when there are similar installations on more than one computer. Additionally, use silent install when performing the Oracle Application Server installation from a remote location using the command line.

A.2 Non-Interactive Installation

Non-interactive installations also use a response file to automate the Oracle Application Server installation. In non-interactive installations, there is graphical output and users may enter input.

Non-interactive installation of Oracle Application Server is also accomplished by supplying the Oracle Universal Installer with a response file but without specifying the `-silent` flag on the command line. The response file is a text file containing variables and parameter values which provide answers to the installer prompts. If you have not provided responses to all of the installer prompts, you need to enter information during the installation.

If this is a first time installation of Oracle Application Server, you must create the `oraInst.loc` file before starting. File creation is described in [Section A.3, "Preinstallation"](#).

Following installation of Oracle Application Server, you need to run the `root.sh` script as the root user. The `root.sh` script detects settings of environment variables and enables you to enter the full path of the local bin directory.

Use non-interactive installation of Oracle Application Server when there are specific screens you want to observe during installation.

A.3 Preinstallation

1. Log in as the root user.

```
prompt> su
```

2. Create the `/etc/oraInst.loc` file. This file specifies the inventory directory that the installer will use.

Using a text editor such as `vi` or `emacs`, enter the following line in the file:

```
inventory_loc=oui_inventory_directory
```

Replace `oui_inventory_directory` with the full path to the directory where you want the installer to create the inventory directory. For example:

```
inventory_loc=/scratch/oraInventory
```

Make sure that the `oinstall` operating system group has write permissions to this directory. For more information about the inventory directory and the group that owns it, see [Section 2.6.1, "Create a Group for the Inventory Directory"](#).

3. Create an empty `/etc/oratab` file.

```
# touch /etc/oratab
```

4. Exit from the root user.

```
# exit
```

A.4 Create the Response File

Before doing a silent or non-interactive installation, you must provide information specific to your installation in a response file. The installer will fail if you attempt an installation using a response file that is not configured correctly. Response files are text files that you can create or edit in a text editor.

A.4.1 Creating Response Files from Templates

Templates for response files are available in the `stage/Response` directory on Disk 1 of the Oracle Application Server CD-ROM. Response file templates are available for the following installation types:

Table A-1 Response File Templates in the `stage/Response` Directory

Installation Type	Filename
Basic Installation: J2EE Server and SOA Suite	<code>oracle.as.j2ee.top.allProducts.rsp</code>
Advanced Installation: J2EE Server, Web Server and SOA Suite	<code>oracle.as.j2ee.top.allProducts.rsp</code>
Advanced Installation: J2EE Server	<code>oracle.as.j2ee.top.core.rsp</code>
Advanced Installation: Web Server	<code>oracle.as.j2ee.top.httpServer.rsp</code>
Advanced Installation: J2EE Server and Web Server	<code>oracle.as.j2ee.top.allProductsNoSOA.rsp</code>

See the template files for descriptions of the parameters in the file.

Note: For Boolean parameters, specify either "true" or "false".

If you are performing a basic installation of J2EE Server and SOA Suite, you must set the following variables in the response file:

```
b_oneClick=true
s_installOption="installSOABasic"
```

A.4.2 Creating Response Files by Using the Record Mode in the Installer

You can run the installer in record mode to save your inputs to a file that you can use later as a response file. This feature is useful if you need to perform the same installation on different computers.

To run the installer in record mode:

1. Start up the installer with the `-record` and `-destinationFile` parameters.

```
prompt> /path/to/runInstaller -record -destinationFile newResponseFile
```

Replace *newResponseFile* with the full path to the response file that you want the installer to create. Example: `/opt/oracle/myJ2EEResponse.rsp`.

2. Enter your values in the installer screens. The installer will write these values to the file specified in the `-destinationFile` parameter.

When you click the **Install** button, the installer automatically writes all your values to the specified file. At this point, you can complete the installation on this computer, or you can exit without performing the installation.

Secure information, such as passwords, is not written to the file, so you must modify the response file before you can use it. To set the password, modify the `s1_adminDialogReturn` parameter. See the generated response file for a description of the parameter.

Note: Response files created by record mode can only be used for non-interactive installations. You cannot use a response file created by record mode in a silent installation.

A.4.3 Example Response Files

The following sections shows example response files for the following Oracle Application Server installation types:

- [Section A.4.3.1, "Example Response File for Basic Installation: J2EE Server and SOA Suite"](#)
- [Section A.4.3.1, "Example Response File for Basic Installation: J2EE Server and SOA Suite"](#)
- [Section A.4.3.3, "Example Response File for Advanced Installation: J2EE Server and Web Server"](#)
- [Section A.4.3.4, "Example Response File for Advanced Installation: J2EE Server"](#)
- [Section A.4.3.5, "Example Response File for Advanced Installation: Web Server"](#)

Note: Be sure that you read the description of each *parameter=value* in the provided sample files, and edit *value* accordingly for your environment.

A.4.3.1 Example Response File for Basic Installation: J2EE Server and SOA Suite

The following shows an example of a response file for a **silent** installation of Basic Installation: J2EE Server and SOA Suite as described in [Section 4.2, "Basic Installation Steps"](#).

```
RESPONSEFILE_VERSION=2.2.1.0.0
UNIX_GROUP_NAME="install"
FROM_LOCATION="/mount_point/Disk1/stage/products.xml"
FROM_LOCATION_CD_LABEL="LABEL1"
ORACLE_HOME="/local_location/oracle_home"
ORACLE_HOME_NAME="OHOME1"
SHOW_SPLASH_SCREEN=false
SHOW_WELCOME_PAGE=false
SHOW_INSTALL_PROGRESS_PAGE=false
SHOW_COMPONENT_LOCATIONS_PAGE=false
SHOW_CUSTOM_TREE_PAGE=false
SHOW_SUMMARY_PAGE=false
SHOW_REQUIRED_CONFIG_TOOL_PAGE=false
SHOW_OPTIONAL_CONFIG_TOOL_PAGE=false
SHOW_RELEASE_NOTES=false
SHOW_ROOTSH_CONFIRMATION=false
SHOW_END_SESSION_PAGE=false
SHOW_EXIT_CONFIRMATION=false
NEXT_SESSION=false
NEXT_SESSION_ON_FAIL=false
SHOW_DEINSTALL_CONFIRMATION=false
SHOW_DEINSTALL_PROGRESS=false
SHOW_IAS_COMPONENT_CONFIG_PAGE=false
ACCEPT_LICENSE_AGREEMENT=true
RESTART_SYSTEM=<Value Unspecified>
CLUSTER_NODES=<Value Unspecified>
```

```

OUI_HOSTNAME=localhost.mycompany.com

PreReqConfigSelections=""
n_ValidationPreReqConfigSelections=0
SELECTED_LANGUAGES={"en"}

TOPLEVEL_COMPONENT={"oracle.as.j2ee.top","10.1.3.1.0"}
DEINSTALL_LIST={"oracle.as.j2ee.top","10.1.3.1.0"}
INSTALL_TYPE="allProducts"
b_oneClick=true
s_installOption="installSOABasic"
sl_DlgClusterInfoSOAReturn={"NO","","","NO","",""}
n_DlgClusterInfoWebValidate=0
bMaskValidationClusterWebInfo=false
b_accessFromSeperateOHS=false
b_ohsType="oc4j"
s_deinstallOption="deinstallSOA"
nValidationSpecifyRepository=0
bMaskValidationRepository=false
s_asInstanceName="appserver"
s_adminName="oc4jadmin"
s_adminPassword="welcome1"
s_adminPasswordConfirm="welcome1"
b_useRemoteInstance=false
b_useLocalInstance=true
s_oc4jInstanceName="home"
oracle.as.j2ee.top:sl_
adminDialogReturn={"appserver","oc4jadmin","welcome1","welcome1","true","home"}
s_selection="Using the local Application Server Control installed with this
instance"
oracle.as.j2ee.top:n_validateAdminDialogInfo=0
oracle.as.j2ee.top:bMaskValidationAdminInfo=false
sDBType="oracle"
sDBTypeName="Oracle Database"
s_dbHost="dbhost.mycompany.com"
s_dbPort="1521"
s_dbSid="orcl.mycompany.com"
oracle.as.j2ee.top:s_dbUser="SYS"
oracle.as.j2ee.top:s_dbPassword="welcome1"
oracle.as.j2ee.top:s_bpelPwd="orabpel"
oracle.as.j2ee.top:s_esbPwd="oraesb"
oracle.as.j2ee.top:s_wsmPwd="orawsm"
szl_PasswordUserInput={"orabpel","oraesb","orawsm"}
nValidationSpecifyPassword=0
bMaskValidationPassword=false
b_autoPortDetect=true
DEPENDENCY_
LIST={"oracle.iaspt:10.1.3.0.0","oracle.java.jdbc.datadirect:10.1.2.0.1","oracle.x
ds:10.1.3.0.0","oracle.as.welcomepages:10.1.3.1.0","oracle.askernel.common:10.1.3.
0.0","oracle.iappserver.iappcore:10.1.3.0.0","oracle.options.ano.fullssl:10.1.0.2.
0"}

```

A.4.3.2 Example Response File for Advanced Installation: J2EE Server, Web Server and SOA Suite

The following shows an example of a response file for a **silent** installation of Advanced Installation: J2EE Server, Web Server and SOA Suite as described in [Section 5.2.2, "Installing J2EE Server, Web Server and SOA Suite"](#).

```

RESPONSEFILE_VERSION=2.2.1.0.0
UNIX_GROUP_NAME="install"
FROM_LOCATION="/mount_point/Disk1/stage/products.xml"
FROM_LOCATION_CD_LABEL="LABEL1"
ORACLE_HOME="/local_location/oracle_home"
ORACLE_HOME_NAME="OHOME1"
SHOW_SPLASH_SCREEN=false
SHOW_WELCOME_PAGE=false
SHOW_INSTALL_PROGRESS_PAGE=false
SHOW_COMPONENT_LOCATIONS_PAGE=false
SHOW_CUSTOM_TREE_PAGE=false
SHOW_SUMMARY_PAGE=false
SHOW_REQUIRED_CONFIG_TOOL_PAGE=false
SHOW_OPTIONAL_CONFIG_TOOL_PAGE=false
SHOW_RELEASE_NOTES=false
SHOW_ROOTSH_CONFIRMATION=false
SHOW_END_SESSION_PAGE=false
SHOW_EXIT_CONFIRMATION=false
NEXT_SESSION=false
NEXT_SESSION_ON_FAIL=false
SHOW_DEINSTALL_CONFIRMATION=false
SHOW_DEINSTALL_PROGRESS=false
SHOW_IAS_COMPONENT_CONFIG_PAGE=false
ACCEPT_LICENSE_AGREEMENT=true
RESTART_SYSTEM=<Value Unspecified>
CLUSTER_NODES=<Value Unspecified>

OUI_HOSTNAME=localhost.mycompany.com

PreReqConfigSelections=""
n_ValidationPreReqConfigSelections=0
SELECTED_LANGUAGES={"en"}

TOPLEVEL_COMPONENT={"oracle.as.j2ee.top","10.1.3.1.0"}
DEINSTALL_LIST={"oracle.as.j2ee.top","10.1.3.1.0"}
INSTALL_TYPE="allProducts"
b_oneClick=false
s_installOption="installSOAAdvanced"
sl_DlgClusterInfoSOAReturn={"NO"," ", " ", "NO", " ", ""}
b_configureCluster=false
n_DlgClusterInfoSOAValidate=0
bMaskValidationClusterInfoSOA=false
n_DlgClusterInfoWebValidate=0
bMaskValidationClusterWebInfo=false
b_accessFromSeparateOHS=false
b_ohsType="local"
s_deinstallOption="deinstallSOA"
nValidationSpecifyRepository=0
bMaskValidationRepository=false
s_asInstanceName="appserver"
s_adminName="oc4jadmin"
s_adminPassword="welcome1"
s_adminPasswordConfirm="welcome1"
b_useRemoteInstance=false
b_useLocalInstance=true
s_oc4jInstanceName="oc4j_soa"
oracle.as.j2ee.top:sl_
adminDialogReturn={"appserver","oc4jadmin","welcome1","welcome1","true", "oc4j_
soa"}
s_selection="Using the local Application Server Control installed with this

```



```

instance"
oracle.as.j2ee.top:n_validateAdminDialogInfo=0
oracle.as.j2ee.top:bMaskValidationAdminInfo=false
sDBType="oracle"
sDBTypeName="Oracle Database"
s_dbHost="dbhost.mycompany.com"
s_dbPort="1521"
s_dbSid="orcl.mycompany.com"
oracle.as.j2ee.top:s_dbUser="SYS"
oracle.as.j2ee.top:s_dbPassword="welcome1"
oracle.as.j2ee.top:s_bpelPwd="orabpel"
oracle.as.j2ee.top:s_esbPwd="oraesb"
oracle.as.j2ee.top:s_wsmPwd="orawsm"
szl_PasswordUserInput={"orabpel", "oraesb", "orawsm"}
nValidationSpecifyPassword=0
bMaskValidationPassword=false
szl_RepositoryUserInput={"Oracle
Database", "SYS", "welcome1", "dbhost.mycompany.com:1521", "", "",
"orcl.mycompany.com"}
szl_PortListSelect={"YES", "/private/jdoe/mystaticports.ini"}
b_autoPortDetect=true
DEPENDENCY_
LIST={"oracle.iaspt:10.1.3.0.0", "oracle.java.jdbc.datadirect:10.1.2.0.1", "oracle.x
ds:10.1.3.0.0", "oracle.as.welcomepages:10.1.3.1.0", "oracle.askernel.common:10.1.3.
0.0", "oracle.iappserver.iappcore:10.1.3.0.0", "oracle.options.ano.fullssl:10.1.0.2.
0", "oracle.apache:10.1.3.0.0"}

```

A.4.3.3 Example Response File for Advanced Installation: J2EE Server and Web Server

The following shows an example of a response file for a **silent** installation of Advanced Installation: J2EE Server and Web Server as described in [Section 5.2.3, "Installing J2EE Server and Web Server"](#).

```

RESPONSEFILE_VERSION=2.2.1.0.0
UNIX_GROUP_NAME="install"
FROM_LOCATION="/mount_point/Disk1/stage/products.xml"
FROM_LOCATION_CD_LABEL="LABEL1"
ORACLE_HOME="/local_location/oracle_home"
ORACLE_HOME_NAME="OHOME1"
SHOW_SPLASH_SCREEN=false
SHOW_WELCOME_PAGE=false
SHOW_INSTALL_PROGRESS_PAGE=false
SHOW_COMPONENT_LOCATIONS_PAGE=false
SHOW_CUSTOM_TREE_PAGE=false
SHOW_SUMMARY_PAGE=false
SHOW_REQUIRED_CONFIG_TOOL_PAGE=false
SHOW_OPTIONAL_CONFIG_TOOL_PAGE=false
SHOW_RELEASE_NOTES=false
SHOW_ROOTSH_CONFIRMATION=false
SHOW_END_SESSION_PAGE=false
SHOW_EXIT_CONFIRMATION=false
NEXT_SESSION=false
NEXT_SESSION_ON_FAIL=false
SHOW_DEINSTALL_CONFIRMATION=false
SHOW_DEINSTALL_PROGRESS=false
SHOW_IAS_COMPONENT_CONFIG_PAGE=false
ACCEPT_LICENSE_AGREEMENT=true
RESTART_SYSTEM=<Value Unspecified>

```

```
CLUSTER_NODES=<Value Unspecified>
OUI_HOSTNAME=localhost.mycompany.com
PreReqConfigSelections=""
n_ValidationPreReqConfigSelections=0
SELECTED_LANGUAGES={"en"}
TOPLEVEL_COMPONENT={"oracle.as.j2ee.top","10.1.3.1.0"}
DEINSTALL_LIST={"oracle.as.j2ee.top","10.1.3.1.0"}
INSTALL_TYPE="allProductsNoSOA"
b_oneClick=false
s_installOption="installSOAAdvanced"
sl_DlgClusterInfoWebReturn={"NO","",""}
b_configureCluster=false
n_DlgClusterInfoWebValidate=0
bMaskValidationClusterWebInfo=false
b_accessFromSeparateOHS=false
b_ohsType="local"
s_deinstallOption="deinstallSOA"
nValidationSpecifyRepository=0
bMaskValidationRepository=false
s_asInstanceName="appserver"
s_adminName="oc4jadmin"
s_adminPassword="welcome1"
s_adminPasswordConfirm="welcome1"
b_useRemoteInstance=false
b_useLocalInstance=true
s_oc4jInstanceName="my_OC4J"
oracle.as.j2ee.top:sl_
adminDialogReturn={"appserver","oc4jadmin","welcome1","welcome1","true","my_
OC4J"}
s_selection="Using the local Application Server Control installed with this
instance"
oracle.as.j2ee.top:n_validateAdminDialogInfo=0
oracle.as.j2ee.top:bMaskValidationAdminInfo=false
sDBType="oracle"
sDBTypeName="Oracle Database"
s_dbHost=""
s_dbPort=""
s_dbSid=""
oracle.as.j2ee.top:s_dbUser=""
oracle.as.j2ee.top:s_dbPassword=""
oracle.as.j2ee.top:s_bpelPwd=""
oracle.as.j2ee.top:s_esbPwd=""
oracle.as.j2ee.top:s_wsmPwd=""
szl_PasswordUserInput={"","",""}
nValidationSpecifyPassword=0
bMaskValidationPassword=false
szl_RepositoryUserInput={"Oracle Database","","":", "", ""}
b_autoPortDetect=true
DEPENDENCY_
LIST={"oracle.iaspt:10.1.3.0.0","oracle.java.jdbc.datadirect:10.1.2.0.1","oracle.x
ds:10.1.3.0.0","oracle.as.welcomepages:10.1.3.1.0","oracle.askernel.common:10.1.3.
0.0","oracle.iappserver.iappcore:10.1.3.0.0","oracle.options.ano.fullssl:10.1.0.2.
0","oracle.apache:10.1.3.0.0"}
```

A.4.3.4 Example Response File for Advanced Installation: J2EE Server

The following shows an example of a response file for a **silent** installation of Advanced Installation: J2EE Server as described in [Section 5.2.4, "Installing J2EE Server"](#).

```

RESPONSEFILE_VERSION=2.2.1.0.0
UNIX_GROUP_NAME="install"
FROM_LOCATION="/mount_point/Disk1/stage/products.xml"
FROM_LOCATION_CD_LABEL="LABEL1"
NEXT_SESSION_RESPONSE=<Value Unspecified>
ORACLE_HOME="/local_location/oracle_home"
ORACLE_HOME_NAME="OHOME1"
SHOW_SPLASH_SCREEN=false
SHOW_WELCOME_PAGE=false
SHOW_INSTALL_PROGRESS_PAGE=false
SHOW_COMPONENT_LOCATIONS_PAGE=false
SHOW_CUSTOM_TREE_PAGE=false
SHOW_SUMMARY_PAGE=false
SHOW_REQUIRED_CONFIG_TOOL_PAGE=false
SHOW_OPTIONAL_CONFIG_TOOL_PAGE=false
SHOW_RELEASE_NOTES=false
SHOW_ROOTSH_CONFIRMATION=false
SHOW_END_SESSION_PAGE=false
SHOW_EXIT_CONFIRMATION=false
NEXT_SESSION=false
NEXT_SESSION_ON_FAIL=false
SHOW_DEINSTALL_CONFIRMATION=false
SHOW_DEINSTALL_PROGRESS=false
SHOW_IAS_COMPONENT_CONFIG_PAGE=false
ACCEPT_LICENSE_AGREEMENT=true
RESTART_SYSTEM=<Value Unspecified>
CLUSTER_NODES=<Value Unspecified>
OUI_HOSTNAME=localhost.mycompany.com
PreReqConfigSelections=""
n_ValidationPreReqConfigSelections=0
SELECTED_LANGUAGES={"en"}
TOplevel_COMPONENT={"oracle.as.j2ee.top", "10.1.3.1.0"}
DEINSTALL_LIST={"oracle.as.j2ee.top", "10.1.3.1.0"}
INSTALL_TYPE="core"
b_oneClick=false
s_installOption="installSOAAdvanced"
sl_DlgClusterInfoReturn={"NO", "NO", "", ""}
b_configureCluster=false
n_DlgClusterInfoWebValidate=0
bMaskValidationClusterWebInfo=false
b_accessFromSeperateOHS=false
b_ohsType="local"
s_deinstallOption="deinstallSOA"
nValidationSpecifyRepository=0
bMaskValidationRepository=false
s_asInstanceName="appserver"
s_adminName="oc4jadmin"
s_adminPassword="welcome1"
s_adminPasswordConfirm="welcome1"
b_useRemoteInstance=false
b_useLocalInstance=true
s_oc4jInstanceName="home"
oracle.as.j2ee.top:sl_
adminDialogReturn={"appserver", "oc4jadmin", "welcome1", "welcome1", "true", "home"}
s_selection="Using the local Application Server Control installed with this
instance"
oracle.as.j2ee.top:n_validateAdminDialogInfo=0
oracle.as.j2ee.top:bMaskValidationAdminInfo=false
SDBType="oracle"
SDBTypeName="Oracle Database"

```

```

s_dbHost=""
s_dbPort=""
s_dbSid=""
oracle.as.j2ee.top:s_dbUser=""
oracle.as.j2ee.top:s_dbPassword=""
oracle.as.j2ee.top:s_bpelPwd=""
oracle.as.j2ee.top:s_esbPwd=""
oracle.as.j2ee.top:s_wsmPwd=""
szl_PasswordUserInput={"", "", ""}
nValidationSpecifyPassword=0
bMaskValidationPassword=false
szl_RepositoryUserInput={"Oracle Database","", "", ":", "", "", "orcl.mycompany.com"}
szl_PortListSelect={"YES", "/private/jdoe/mystaticports.ini"}
b_autoPortDetect=true
DEPENDENCY_
LIST={"oracle.iaspt:10.1.3.0.0", "oracle.java.jdbc.datadirect:10.1.2.0.1", "oracle.x
ds:10.1.3.0.0", "oracle.as.welcomepages:10.1.3.1.0", "oracle.askernel.common:10.1.3.
0.0", "oracle.iappserver.iappcore:10.1.3.0.0", "oracle.options.ano.fullssl:10.1.0.2.
0", "oracle.apache:10.1.3.0.0"}

```

A.4.3.5 Example Response File for Advanced Installation: Web Server

The following shows an example of a response file for a **silent** installation of Advanced Installation: Web Server as described in [Section 5.2.5, "Installing Web Server"](#).

```

RESPONSEFILE_VERSION=2.2.1.0.0
UNIX_GROUP_NAME="install"
FROM_LOCATION="/mount_point/Disk1/stage/products.xml"
FROM_LOCATION_CD_LABEL="LABEL1"
ORACLE_HOME="/local_location/oracle_home"
ORACLE_HOME_NAME="OHOME1"
SHOW_SPLASH_SCREEN=false
SHOW_WELCOME_PAGE=false
SHOW_INSTALL_PROGRESS_PAGE=false
SHOW_COMPONENT_LOCATIONS_PAGE=false
SHOW_CUSTOM_TREE_PAGE=false
SHOW_SUMMARY_PAGE=false
SHOW_REQUIRED_CONFIG_TOOL_PAGE=false
SHOW_OPTIONAL_CONFIG_TOOL_PAGE=false
SHOW_RELEASE_NOTES=false
SHOW_ROOTSH_CONFIRMATION=false
SHOW_END_SESSION_PAGE=false
SHOW_EXIT_CONFIRMATION=false
NEXT_SESSION=false
NEXT_SESSION_ON_FAIL=false
SHOW_DEINSTALL_CONFIRMATION=false
SHOW_DEINSTALL_PROGRESS=false
SHOW_IAS_COMPONENT_CONFIG_PAGE=false
ACCEPT_LICENSE_AGREEMENT=true
RESTART_SYSTEM=<Value Unspecified>
CLUSTER_NODES=<Value Unspecified>

OUI_HOSTNAME=localhost.mycompany.com

PreReqConfigSelections=""
n_ValidationPreReqConfigSelections=0
SELECTED_LANGUAGES={"en"}

TOPLEVEL_COMPONENT={"oracle.as.j2ee.top", "10.1.3.1.0"}

```

```

DEINSTALL_LIST={"oracle.as.j2ee.top","10.1.3.1.0"}
INSTALL_TYPE="httpServer"
b_oneClick=false
s_installOption="installSOAAdvanced"
sl_DlgClusterInfoWebReturn={"NO","",""}
b_configureCluster=false
n_DlgClusterInfoWebValidate=0
bMaskValidationClusterWebInfo=false
b_accessFromSeparateOHS=false
b_ohsType="local"
s_deinstallOption="deinstallSOA"
nValidationSpecifyRepository=0
bMaskValidationRepository=false
s_asInstanceName="appserver"
s_adminName="oc4jadmin"
s_adminPassword="welcome1"
s_adminPasswordConfirm="welcome1"
b_useRemoteInstance=false
b_useLocalInstance=true
s_oc4jInstanceName="home"
oracle.as.j2ee.top:sl_
adminDialogReturn={"appserver","oc4jadmin","welcome1","welcome1","true","home"}
s_selection="Using the local Application Server Control installed with this
instance"
oracle.as.j2ee.top:n_validateAdminDialogInfo=0
oracle.as.j2ee.top:bMaskValidationAdminInfo=false
sDBType="oracle"
sDBTypeName="Oracle Database"
s_dbHost=""
s_dbPort=""
s_dbSid=""
oracle.as.j2ee.top:s_dbUser=""
oracle.as.j2ee.top:s_dbPassword=""
oracle.as.j2ee.top:s_bpelPwd=""
oracle.as.j2ee.top:s_esbPwd=""
oracle.as.j2ee.top:s_wsmPwd=""
szl_PasswordUserInput={"","",""}
nValidationSpecifyPassword=0
bMaskValidationPassword=false
szl_RepositoryUserInput={"Oracle Database","","":",", "", ""}
szl_PortListSelect={"YES","/private/jdoe/mystaticports.ini"}
b_autoPortDetect=true
DEPENDENCY_
LIST={"oracle.iaspt:10.1.3.0.0","oracle.java.jdbc.datadirect:10.1.2.0.1","oracle.x
ds:10.1.3.0.0","oracle.as.welcomepages:10.1.3.1.0","oracle.askernel.common:10.1.3.
0.0","oracle.iappserver.iappcore:10.1.3.0.0","oracle.options.ano.fullssl:10.1.0.2.
0","oracle.apache:10.1.3.0.0"}

```

A.5 Start the Installation

To make the installer use the response file, specify the location of the response file that you want to use as a parameter when starting the installer.

To perform a non-interactive installation:

```

prompt> setenv DISPLAY hostname:0.0
prompt> runInstaller -responseFile absolute_path_and_filename

```

To perform a silent installation, use the `-silent` parameter:

```
prompt> runInstaller -silent -responseFile absolute_path_and_filename
```

A.6 Postinstallation

The success or failure of the non-interactive and silent installations is logged in the `installActions<time_stamp>.log` file. Additionally, the silent installation creates the `silentInstall<time_stamp>.log` file. The log files are created in the `oraInventory/logs` directory.

The `silentInstall<time_stamp>.log` file contains the following line if the installation was successful:

```
The installation of OracleAS <Installation Type> was successful.
```

The `installActions<time_stamp>.log` file contains specific information for each Oracle Application Server installation type.

See Also: [Appendix D, "Configuration Assistants"](#)

A.7 Security Tips for Silent and Non-Interactive Installations

One of the pieces of information in the response file is the installation password. The password information is in clear text.

To minimize security issues regarding the password in the response file, follow these guidelines:

- Set the permissions on the response files so that they are readable only by the operating system user who will be performing the silent or non-interactive installation.
- If possible, remove the response files from the system after the silent or non-interactive installation is completed.

A.8 Deinstallation

You can perform a silent deinstallation of Oracle Application Server by supplying a silent deinstallation parameter to the response file you used for installation.

Modify the following parameter in your installation response file:

```
REMOVE_HOMES={"<ORACLE_HOME to be removed>"}
```

For example:

```
REMOVE_HOME="/local_location/oracle_home"
```

Note: You still need to follow the clean up steps described in [Appendix C, "Deinstallation and Reinstallation"](#). The silent deinstallation command only replaces the step where you run the installer interactively to deinstall the instance.

To perform a silent deinstallation, use the `-deinstall` parameter when entering the command:

```
prompt> runInstaller -silent -deinstall -responseFile absolute_path_and_filename
```

Default Port Numbers

By default, the installer assigns port numbers to components from a set of default port numbers. This appendix contains a list of these port numbers.

If you want to use a different set of port numbers, you have to create a file called `staticports.ini`, in which you list the port numbers that you want to use. See [Section 2.5.3, "Using Custom Port Numbers \(the "Static Ports" Feature\)"](#) for details.

This appendix contains the following topics:

- [Section B.1, "Method of Assigning Default Port Numbers"](#)
- [Section B.2, "Default Port Numbers"](#)
- [Section B.3, "Ports to Open in Firewalls"](#)

B.1 Method of Assigning Default Port Numbers

The installer assigns default port numbers to each component using the following method:

1. The installer checks if the default port number is in use. If it is not in use, the installer assigns it to the component.
2. If the default port number is already in use by an Oracle product or by any running application, the installer tries the lowest number in the port number range. It keeps trying the port numbers in the range until it finds one that is available.

B.2 Default Port Numbers

[Table B-1](#) lists the default port numbers for components. The last column, [Name in `staticports.ini`](#), specifies the component name as it appears in the `staticports.ini` file, which enables you to override the default port numbers. See [Section 2.5.3, "Using Custom Port Numbers \(the "Static Ports" Feature\)"](#) for details.

Table B-1 Default Port Numbers and Ranges (Grouped by Component)

Component	Default Port	Port Number Range	Name in staticports.ini
Oracle Process Manager and Notification Server (OPMN)			
Oracle Notification Server Request Port	6003	6003 - 6099	Oracle Notification Server Request port
Oracle Notification Server Local Port	6100	6100 - 6199	Oracle Notification Server Local port
Oracle Notification Server Remote Port	6200	6200 - 6299	Oracle Notification Server Remote port
Oracle Application Server Containers for J2EE (OC4J)			
OC4J AJP	12501	12501 - 12600	Not settable through staticports.ini
OC4J RMI	12401	12401 - 12500	Not settable through staticports.ini
JMS	12601	12601 - 12700	Not settable through staticports.ini
IIOP	13301	13301 - 13400	Not settable through staticports.ini
IIOPS1	13401	13401 - 13500	Not settable through staticports.ini
IIOPS2	13501	13501 - 13600	Not settable through staticports.ini
Oracle HTTP Server			
Oracle HTTP Server Listen Port	7777	7777 - 7877, 8888	Not settable through staticports.ini
Oracle HTTP Server Listen (SSL) Port	4443	4443	Not settable through staticports.ini
Oracle HTTP Server Port	7777	7777 - 7877, 8888	Oracle HTTP Server port
Oracle HTTP Server SSL Port	4443	443, 4443	Oracle HTTP Server SSL port
Java Object Cache	7000	7000 - 7099	Not settable through staticports.ini
Port Tunneling	7501	7501 - 7599	Not settable through staticports.ini
Oracle HTTP Server Diagnostic port	7200	7200 - 7299	Not settable through staticports.ini
Oracle Application Server Guard			
Oracle Application Server Guard	7890	7890 - 7895	ASG port

B.3 Ports to Open in Firewalls

If you plan to install Oracle Application Server behind firewalls, you need to open certain ports in the firewall during installation (and also during runtime).

For a 10g Release 3 (10.1.3.1.0) middle-tier instance, you need access to Oracle Notification Server and AJP ports. You need to open the following ports used by these components in the firewall:

- OPMN Oracle Notification Server remote port
- OC4J AJP port

Deinstallation and Reinstallation

This appendix guides you through the deinstallation and reinstallation process for Oracle Application Server.

- [Section C.1, "Deinstallation Procedure: Overview"](#)
- [Section C.2, "Deinstalling Procedure"](#)
- [Section C.3, "Cleaning Up Oracle Application Server Processes"](#)
- [Section C.4, "Reinstallation"](#)

C.1 Deinstallation Procedure: Overview

Follow these high-level steps to deinstall Oracle Application Server (the details are provided in later sections):

1. Run the installer and click the **Deinstall Products** button.
2. Clean up any remaining files.

Items to Remove or Clean Up

To deinstall Oracle Application Server instances, you have to clean up the items listed in [Table C-1](#). The procedures are described later in this appendix.

Table C-1 *Items to Deinstall*

Item to Clean Up	Tool to Use
Files from the Oracle home directory	Installer If the installer does not remove all the files, you can remove the remaining files using the <code>rm</code> command.
Entries for the deleted instance in the Inventory directory	Installer
Instance name from Farm page	Installer
Entries for the deleted instance in the <code>/etc</code> directory	You have to remove the entries manually. See Step 6 on page C-2.

The installer does not permit custom deinstallation of individual components.

C.2 Deinstalling Procedure

1. Log in as the operating system user who installed the instance you want to deinstall.
2. Stop all processes associated with the instance you want to deinstall.
See the *Oracle Application Server Administrator's Guide* for details on how to stop the processes.

3. Start the installer.

```
prompt> $ORACLE_HOME/oui/bin/runInstaller
```

4. Follow these steps in the installer.
 - a. Welcome screen: Click **Deinstall Products**.
 - b. Inventory screen: Select the instance you want to deinstall, and click **Remove**.
 - c. Confirmation screen: Verify the components selected for deinstallation. Click **Yes** to continue.
 - d. Deinstallation Progress screen: Monitor the progress of the deinstallation.
 - e. Exit the installer when the deinstallation is complete.
5. Delete any remaining files in the deleted instance's Oracle home directory.

```
prompt> rm -rf $ORACLE_HOME
```

6. Remove the line for the deinstalled instance from the `/etc/oratab` file.

Towards the end of the file, you should see lines that specify the Oracle home directory. Remove the line for the Oracle home that you deinstalled. For example, if your Oracle home is `/private1/j2ee`, the line would look like the following:

```
*:/private1/j2ee:N
```

C.3 Cleaning Up Oracle Application Server Processes

If you forgot to shut down Oracle Application Server processes before starting the installation, you have to kill the processes because the files for these processes are deleted. To check for processes that are still running, run the `ps` command:

```
prompt> ps -ef
```

To kill a process, use the `kill` command:

```
prompt> kill -9 process_id
```

You can determine the `process_id` from the `ps` command.

If you need to shut down the `dcmtcl` shell process, you can try exiting the shell by typing `exit`.

C.4 Reinstallation

The installer does not allow reinstallation of an Oracle Application Server instance in a directory that already contains an Oracle Application Server instance. To reinstall

Oracle Application Server in the same directory, you have to deinstall and then install it.

Configuration Assistants

This appendix lists the configuration assistants and the location of their log files.

- [Section D.1, "Troubleshooting Configuration Assistants"](#)
- [Section D.2, "Description of Oracle Application Server Configuration Assistants"](#)

D.1 Troubleshooting Configuration Assistants

Contents:

- [Section D.1.1, "General Tips"](#)
- [Section D.1.2, "Configuration Assistant Result Codes"](#)

D.1.1 General Tips

If a configuration assistant fails, try the following steps to correct the problem:

1. Review the installation log files listed in [Section E.1, "Log Files"](#).
2. Review the log files for the failed configuration assistant. Configuration assistant log files are listed in [Section D.2, "Description of Oracle Application Server Configuration Assistants"](#). Try to fix the issue that caused the error.
3. If the failed configuration assistant has any dependencies, then run the dependencies again. You must do this even if the dependency completed successfully.
4. If an optional configuration assistant fails, and it does not have any dependencies, run the remaining configuration assistants. Uncheck the cancelled optional configuration assistant, highlight and check the next listed configuration assistant, and click **Retry**.
5. If configuration assistant failure occurs when running configuration assistant execution commands on the command line, then re-run the configuration assistant execution command again.

You can use the generated script file named `configtoolcmds.pl` located in the `ORACLE_HOME/bin` directory to execute the failed configuration assistant again. The `configtoolcmds.pl` script is generated after you exit the installer. During silent or non-interactive installation, the `configtoolcmds.pl` script is generated immediately after configuration assistant failure.

6. If you see a "Fatal Error. Reinstall" message, find the cause of the problem by analyzing the log files. You cannot recover from a fatal error by correcting the problem and continuing. You must remove the current installation and reinstall Oracle Application Server. The following tasks describe the recovery procedure:

- a. Deinstall the failed installation using the procedure described in [Appendix C, "Deinstallation and Reinstallation"](#).
- b. Correct the cause of the fatal error.
- c. Reinstall Oracle Application Server.
- d. If the fatal error reoccurs, then you must remove all Oracle installations from your computer.

D.1.2 Configuration Assistant Result Codes

If a configuration assistant fails, the bottom half of the installation screen displays the error message, and the configuration assistant writes its result code ([Table D-1](#)) to the following log file:

```
oraInventory/logs/installActionstimestamp.log
```

Table D-1 Result Codes for Configuration Assistants

Result Code	Description
0	Configuration assistant succeeded
1	Configuration assistant failed
-1	Configuration assistant cancelled

D.2 Description of Oracle Application Server Configuration Assistants

[Table D-2](#) lists the Oracle Application Server configuration assistants in alphabetical order. Different installations use different configuration assistants depending on installation type and configuration options you selected.

Table D-2 Oracle Application Server Configuration Assistants

Configuration Assistant	Description	Log File Location
Oracle Application Server Configuration Assistant	Enables Java Single Sign-On for Application Server Control.	ORACLE_HOME/cfgtoollogs/configtoolstimestamp.log
Oracle ESB Configuration Assistant	Deploys and configures Enterprise Service Bus applications to the active OC4J instance. For a basic installation, the active OC4J instance is named home. For an advanced installation of J2EE Server, Web Server and SOA Suite, the name of the active OC4J instance is specified on the Administration Settings screen.	ORACLE_HOME/cfgtoollogs/configtoolstimestamp.log
Oracle BPEL Process Manager Configuration Assistant	Deploys and configures Business Process Execution Language Process Manager applications to the active OC4J instance. For a basic installation, the active OC4J instance is named home. For an advanced installation of J2EE Server, Web Server and SOA Suite, the name of the active OC4J instance is specified on the Administration Settings screen.	ORACLE_HOME/cfgtoollogs/configtoolstimestamp.log

Table D-2 (Cont.) Oracle Application Server Configuration Assistants

Configuration Assistant	Description	Log File Location
Oracle Web Services Manager Configuration Assistant	Deploys and configures Web Services Manager applications to the active OC4J instance. For a basic installation, the active OC4J instance is named home. For an advanced installation of J2EE Server, Web Server and SOA Suite, the name of the active OC4J instance is specified on the Administration Settings screen.	ORACLE_HOME/cfgtoollogs/ configtoolstimestamp.log
OPMN Configuration Assistant	Starts OPMN and OPMN-managed processes.	ORACLE_HOME/cfgtoollogs/ configtoolstimestamp.log ORACLE_HOME/opmn/logs/opmn.log
Oracle Web Services Inspection Language Configuration Assistant	Deploys the Web Services Inspection Language application.	ORACLE_HOME/cfgtoollogs/ configtoolstimestamp.log ORACLE_HOME/cfgtoollogs/wsil.txt

Troubleshooting

This appendix describes solutions to common problems that you might encounter when installing Oracle Application Server. It contains the following sections:

- [Section E.1, "Log Files"](#)
- [Section E.2, "General Troubleshooting Tips"](#)
- [Section E.3, "Installation Problems and Solutions"](#)
- [Section E.4, "Need More Help?"](#)

E.1 Log Files

The installer writes the following log files:

- `oraInventory_location/logs/installActionstimestamp.log`
- `oraInventory_location/logs/oraInstalltimestamp.err`
- `oraInventory_location/logs/oraInstalltimestamp.out`

E.2 General Troubleshooting Tips

If you encounter an error during installation:

- Read the *Oracle Application Server Release Notes* for the latest updates. The release notes are available with the platform-specific documentation. The most current version of the release notes is available on Oracle Technology Network (<http://www.oracle.com/technology/documentation>).
- Verify that your computer meets the requirements specified in [Chapter 2, "Requirements"](#).
- If you entered incorrect information on one of the installation screens, return to that screen by clicking **Back** until you see the screen.
- If a configuration assistant failed, check the log file for that configuration assistant. [Section D.2, "Description of Oracle Application Server Configuration Assistants"](#) lists the configuration assistants and the location of their log files. If you do not see log files from some configuration assistants in the `ORACLE_HOME/cfgtoollogs` directory, exit the installer. This causes the installer to copy the log files to that directory.
- If an error occurred while the installer is copying or linking files:
 1. Note the error and review the installation log files.

2. Remove the failed installation by following the steps in [Appendix C, "Deinstallation and Reinstallation"](#).
3. Correct the issue that caused the error.
4. Restart the installation.

E.3 Installation Problems and Solutions

This section describes common installation problems and solutions:

- [Section E.3.1, "Location of Log Files"](#)
- [Section E.3.2, "Linking Failed, ORA Errors"](#)
- [Section E.3.3, "Prerequisite Checks Fail at the Start of Installation"](#)
- [Section E.3.4, "Installer Disappears After Running the Preinstallation Checks"](#)
- [Section E.3.5, "Unable to Clean Up a Failed Installation"](#)
- [Section E.3.6, "User Interface Does Not Display in the Desired Language, or Does Not Display Properly"](#)
- [Section E.3.7, "Configuration Assistant Failures - General"](#)

E.3.1 Location of Log Files

There are two sets of log files:

- The installer writes the following log files:
 - `oraInventory_location/logs/installActionstimestamp.log`
 - `oraInventory_location/logs/oraInstalltimestamp.err`
 - `oraInventory_location/logs/oraInstalltimestamp.out`
 - `Oracle_Home/install/make.log`
- The configuration assistants write log files in the `ORACLE_HOME/cfgtoollogs` directory.

Note that if you want to access the log files created by the configuration assistants, you need to exit the installer first. The log files are inaccessible if the installer is still in use.

E.3.2 Linking Failed, ORA Errors

Problem

Linking failed, and ORA errors were displayed during installation

Solution

Exit the installer and check the log files for any error message. In particular, check the `ORACLE_HOME/install/make.log` file.

Remove the failed installation. Before reinstalling Oracle Application Server, make sure that your computer meets all the requirements listed in [Chapter 2, "Requirements"](#).

Check especially the following requirements:

- Check that the kernel parameters are set to the proper values. Note that if you change the value of a kernel parameter, you must exit the installer and restart your computer for the new value to take effect.
- Check that you are installing Oracle Application Server in a valid directory. For example, you cannot install Oracle Application Server in a database Oracle home. See [Section 2.12](#) for a complete list.

E.3.3 Prerequisite Checks Fail at the Start of Installation

Problem

The prerequisite checks that are run at the start of installation failed

Solution

If the prerequisite checks display warnings about missing operating system patches or patch bundles, the patch may actually be missing, or it may have been superseded. If your computer contains the patch that supersedes it, you can ignore the warning.

See [Section 2.3, "Software Requirements"](#) for a list of required operating system patches.

E.3.4 Installer Disappears After Running the Preinstallation Checks

Problem

The installer disappears after running preinstallation checks

Solution

The directory that is the mount point of the CD-ROM or DVD-ROM was mounted with incorrect permissions, and this caused the `pwd` command to not work correctly. When you run `pwd`, it returns "cannot determine current directory".

To fix:

1. Unmount the CD-ROM.
2. Change permissions of the mount directory to 755.
3. Remount the CD-ROM.

The installer should now run correctly.

E.3.5 Unable to Clean Up a Failed Installation

If your installation was not successful, you have to uninstall it first before you can install Oracle Application Server again. Refer to [Appendix C, "Deinstallation and Reinstallation"](#) for instructions.

E.3.6 User Interface Does Not Display in the Desired Language, or Does Not Display Properly

Problem

Messages do not appear in the desired language, or messages are not displayed correctly

Solution

Currently Oracle Application Server does not support adding or removing languages after installation.

If you are serving non-English content, be sure you add all the languages that you need during installation. To add languages during installation, click the **Product Languages** button in the "Select Installation Type" screen. To see which languages are installed by default, see [Section 3.3, "Installing Additional Languages"](#).

If you are serving non-English content and forgot to click the Product Languages in the installation, the user interface might not display properly because the required fonts were not installed. You can fix this by contacting Customer Service for the requirement fonts.

E.3.7 Configuration Assistant Failures - General

This section describes general tips for troubleshooting configuration assistant failures. See the next sections for specific configuration assistant failures. See also [Appendix D, "Configuration Assistants"](#).

Problem

Configuration assistant failed

Solution

Configuration assistants fail from a variety of causes. Some things you can check are:

- Check the log files for the failed configuration assistant to determine the problem. The log files are located in the `ORACLE_HOME/cfgtoollogs` directory.
Fix the problem indicated in the log file, and click **Retry** to rerun the failed configuration assistant.

If the configuration assistant fails while running configuration assistant execution commands on the command line, then run the configuration assistant execution command again.

You can use the generated script file named `configtoolcmds.pl` located in the `ORACLE_HOME/bin` directory to run the failed configuration assistant again. The `configtoolcmds.pl` script is generated after you exit the installer. During silent or non-interactive installation, the `configtoolcmds.pl` script is generated immediately after configuration assistant failure.

E.4 Need More Help?

If this appendix does not solve the problem you encountered, try these other sources:

- *Oracle Application Server Release Notes*, available on the Oracle Technology Network (<http://www.oracle.com/technology/documentation>)
- *OracleMetaLink* (<http://metalink.oracle.com>)

If you do not find a solution for your problem, open a service request.

Numerics

256 color requirement, 2-4

A

active-active topology
 creating, 6-5
 installation, 6-8
 introduction, 6-6
 supporting procedures, 6-12

active-passive topology
 creating, 6-18
 installation details, 6-24
 installation overview, 6-20
 introduction, 6-18
 OracleAS Cold Failover Cluster, 6-2
 preinstallation steps, 6-21

additional languages, 3-2

advanced installation, 5-1
 installation steps, 5-2
 installed components, 5-1
 J2EE Server, 5-5
 J2EE Server and Web Server, 5-4
 J2EE Server, Web Server and SOA Suite, 5-3
 Web Server, 5-6

B

backup and recovery
 in OracleAS Disaster Recovery environment, 6-27
 postinstallation, 7-2

Bash shell
 setting shell limits, 2-13

basic installation, 4-1
 installation steps, 4-2
 installed components, 4-1

Bourne shell
 setting shell limits, 2-13

browser requirement, 2-4

C

C shell
 setting shell limits, 2-13

CD-ROM
 copying to hard drive, 2-24

 format of, 3-7
 mount point, 3-7

CLASSPATH environment variable, 2-21

_CLUSTER_NETWORK_NAME_ environment variable, 6-29

components
 default port numbers, B-1
 how to assign custom port numbers, 2-15

configuration assistants, D-1
 dependencies, D-1
 descriptions of, D-2
 error codes, D-2
 fatal errors, D-1
 troubleshooting, D-1

console
 installing from, 2-4

copying CD-ROM/DVD to hard drive, 2-24

CPU requirements, 2-3

csh.login file, 2-14

csh.login.local file, 2-14

custom ports
 see static ports

D

default port numbers, 2-14, B-1

deinstallation, C-1
 overview, C-1
 silent mode, A-12

deinstallation procedure, C-2

DHCP
 installing on DHCP computers, 2-23

disk space requirements, 2-3

DISPLAY environment variable, 2-21

DNS server for name resolution (OracleAS Disaster Recovery), 6-29

DVD
 copying to hard drive, 2-24
 format of, 3-7
 mount point, 3-7

E

environment variables, 2-20
 _CLUSTER_NETWORK_NAME_, 6-29
 CLASSPATH, 2-21

- DISPLAY, 2-21
- LD_BIND_NOW, 2-23
- LD_LIBRARY_PATH, 2-21
- NLS_LANG, 7-2
- ORA_NLS, 2-23
- PATH, 2-21
 - set in .profile file, 2-21
 - su command and, 2-21
- TMP, 2-22
- TMPDIR, 2-22
- TNS_ADMIN, 2-22
- error codes from configuration assistants, D-2
- /etc directory, 3-5
 - oraInst.loc file, 2-18
- /etc/csh.login file, 2-14
- /etc/csh.login.local file, 2-14
- /etc/group file, 6-4
- /etc/pam.d/login file, 2-13
- /etc/profile file, 2-14
- /etc/profile.local file, 2-14
- /etc/resolve.conf file, 6-30
- /etc/security/limits.so file, 2-13

F

- failover (OracleAS Cold Failover Cluster), 6-23
- fatal errors, D-1
- files
 - default shell startup file, 2-14
 - /etc/csh.login, 2-14
 - /etc/csh.login.local, 2-14
 - /etc/pam.d/login, 2-13
 - /etc/profile, 2-14
 - /etc/profile.local, 2-14
 - /etc/security/limits.so, 2-13
- firewalls
 - and ports, B-2
- first-time installation of any Oracle product, 3-2
- font problems, E-3

G

- groupadd command, 2-18
- groups (operating system)
 - see* operating system groups
- groups command, 2-19

H

- high availability environments, 6-1
 - active-active topology, 6-5
 - active-passive topology, 6-18
 - /etc/group file, 6-4
 - inventory directory, 6-5
 - oracle user, 6-4
 - OracleAS Clusters, 6-5
 - OracleAS Cold Failover Cluster, 6-18
 - overview, 6-1
 - requirements, 6-4
 - summary of differences, 6-3
- hostname requirement, 2-2

- hosts file for name resolution (OracleAS Disaster Recovery), 6-30
- httpd.conf file, 2-17

I

- installActions.log, A-12
- installation
 - advanced
 - see* advanced installation
 - basic
 - see* basic installation
 - J2EE Server, 5-5
 - J2EE Server and Web Server, 5-4
 - J2EE Server, Web Server and SOA Suite, 5-3
 - Web Server, 5-6
- installation steps
 - advanced installation, 5-2
 - basic installation, 4-2
- installation types, 1-2
- installer
 - see* Oracle Universal Installer
- installing additional languages, 3-2
- installing from hard drive, 2-24
- instance names, 3-3
 - how they are used, 3-3
 - restrictions, 3-3
 - valid characters, 3-3
- inventory directory, 3-2, 3-5
 - group for, 2-18
 - location of, 2-18
- IP
 - installing on a computer with multiple IP addresses, 2-24
 - requirements, 2-2

J

- J2EE Server
 - installation, 5-5
- J2EE Server and Web Server
 - installation, 5-4
- J2EE Server, Web Server and SOA Suite
 - installation, 5-3

K

- Korn shell
 - setting shell limits, 2-13

L

- languages, installing additional, 3-2
- LD_BIND_NOW environment variable, 2-23
- LD_LIBRARY_PATH environment variable, 2-21
- limit command, 2-14
- limits.so file, 2-13
- linking failed, E-2
- log files, E-1
 - from non-interactive installations, A-12
 - location of, E-2

login file, 2-13

M

memory requirements, 2-3

middle tiers

installing in OracleAS Disaster Recovery, 6-34

monitor requirements, 2-4

mount point for CD-ROM, 3-7

mount point for DVD, 3-7

multihomed computers, installing on, 2-24

N

name resolution (OracleAS Disaster Recovery), 6-29

using DNS servers, 6-29

using hosts file, 6-30

names of instances

see instance names

Network Appliance filers, 2-27

network requirements, 2-2

network topics, 2-23

installing from hard drive, 2-24

installing from remote CD-ROM/DVD drive, 2-25

installing on DHCP computers, 2-23

installing on multihomed computers, 2-24

NFS storage, 2-27

remote installations, 2-26

NFS installations

configuring Oracle HTTP Server, 7-2

NFS storage, 2-27

NIS and NIS+, 2-27

NLS_LANG environment variable, 7-2

nofile

shell limit on Linux, 2-13

non-interactive installations, A-1

deinstalling, A-12

log files, A-12

postinstallation steps, A-12

preinstallation steps, A-2

security tips, A-12

noproc

shell limit on Linux, 2-13

O

oc4jadmin user, 3-4

password for, 3-4

oinstall group, 2-18, 3-2

operating system

patches, 2-4

operating system groups, 2-18

for inventory directory, 2-18

groups command, 2-19

oinstall group, 2-18

operating system patches

Red Hat Enterprise Linux AS/ES 3.0, 2-5

Red Hat Enterprise Linux AS/ES 4.0, 2-7

SUSE Linux Enterprise Server 9, 2-10

operating system users, 2-18

groups command, 2-19

oracle user, 2-19

ORA_NLS environment variable, 2-23

Oracle Data Guard (for OracleAS Disaster Recovery), 6-27, 6-30

Oracle Database 10g, 2-20

Oracle E-Delivery, 3-6

Oracle Enterprise Manager Application Server Control

URL, 7-1

Oracle home

directory, 3-1

installing in a non-empty, 3-2

installing in an existing, 3-2

naming, 3-1

Oracle HTTP Server

configuring static ports, 2-17

in NFS installations, 7-2

Oracle MetaLink

using to obtain updates to 10.1.3.1.0, 2-2

oracle software owner user

setting shell limits, 2-13

Oracle Universal Installer

disappears after preinstallation checks, E-3

log files, E-1

prerequisite checks, 2-28

starting, 3-8

where it writes files, 3-5

oracle user, 2-18, 2-19, 6-4

setting shell limits, 2-13

OracleAS Clusters

see active-active topology

OracleAS Cold Failover Cluster

advantages, 6-3

failover, 6-23

in OracleAS Disaster Recovery environment, 6-32

mapping virtual hostname, 6-21

mapping virtual IP address, 6-21

preinstallation steps, 6-21

see active-passive topology

setting up mountable file system, 6-23

OracleAS Disaster Recovery

data synchronization, 6-26

installation steps, 6-33

installing middle tiers, 6-34

installing OracleAS Infrastructure, 6-34

name resolution, 6-29

Oracle Data Guard, 6-30

setting up, 6-27

setting up identical hostnames, 6-28

staticports.ini file, 6-28

with OracleAS Cold Failover Cluster, 6-32

OracleAS Infrastructure

installing in OracleAS Disaster Recovery, 6-34

oraInst.loc file, 2-18

creation (non-interactive installations), A-2

oraInventory directory, 2-18, 3-2

P

- passwd command, 2-19
- passwords
 - for oc4jadmin user, 3-4
- patches
 - see* operating system.
- PATH environment variable, 2-21
- ports, 2-14
 - checking if a port is in use, 2-14
 - choosing port numbers, 2-16
 - list of default port numbers, B-1
 - static ports, 2-15
 - to open in firewalls, B-2
 - using default port numbers, 2-14
- postinstallation steps, 7-1
 - for silent or non-interactive installations, A-12
- preinstallation steps
 - for silent and non-interactive installations, A-2
- prerequisite checks, 2-28
 - failures, E-3
- processor, 2-3
- Product Languages button, 3-2
- .profile file, 2-21
- profile file, 2-14
- profile.local file, 2-14

R

- RAM requirements, 2-3
- record mode in the installer, A-3
- Red Hat Enterprise Linux AS/ES 3.0, patches
 - required for, 2-5
- Red Hat Enterprise Linux AS/ES 4.0, patches
 - required for, 2-7
- remote installations, 2-25, 2-26
- requirements
 - browser, 2-4
 - disk space, 2-3
 - environment variables, 2-20
 - for DHCP computers, 2-23
 - for multihomed computers, 2-24
 - hostname, 2-2
 - IP, 2-2
 - memory, 2-3
 - monitor, 2-4
 - network, 2-2
 - operating system patches, 2-4
 - processor, 2-3
 - swap space, 2-4
- response files, A-1
 - creating, A-2
 - creating using the record mode, A-3
 - examples, A-4
 - specifying on command-line, A-11
 - templates, A-3
- root user, 3-5
- root.sh, 3-5
- runInstaller command
 - executeSysPrereqs parameter, 2-2
 - on CD-ROM, 3-8

- on DVD, 3-8

S

- security tips for silent and non-interactive installations, A-12
- setting shell limits, 2-13
- shared storage, 6-2
- shell
 - default shell startup file, 2-14
- shell limits, 2-13
- silent installations, A-1
 - deinstalling, A-12
 - postinstallation steps, A-12
 - preinstallation steps, A-2
 - security tips, A-12
- silentInstall.log, A-12
- SSL
 - postinstallation configuration, 7-2
- starting Oracle Universal Installer, 3-8
- startup file
 - default shell startup file, 2-14
- static ports, 2-15
 - for Oracle HTTP Server, 2-17
 - not working, 2-16
- staticports.ini file, 2-15
 - creating, 2-15
 - format, 2-15
 - in OracleAS Disaster Recovery, 6-28
- su command, 2-21
- SUSE Linux Enterprise Server 9, patches required for, 2-10
- swap space requirement, 2-4
- system requirements, 2-2

T

- tcsh shell
 - setting shell limits, 2-13
- /tmp directory, 2-22, 3-5
 - space required in, 2-4
- TMP environment variable, 2-22
- TMPDIR environment variable, 2-22
- TNS_ADMIN environment variable, 2-22
- tnsnames.ora file, 2-22
- topologies
 - 10.1.3.1.0 middle tiers, 1-3
 - high availability, 1-3
 - integrated web server and OC4J middle tier, 1-5
 - J2EE server and separate SOA applications with a remote oracle HTTP server, 1-11
 - J2EE server and the SOA suite with a remote HTTP server, 1-8
 - J2EE server with the SOA suite, 1-6
 - J2EE server, web server, and the SOA suite, 1-7
 - multiple SOA middle tiers with a remote oracle HTTP server, 1-14
 - SOA administration instance, 1-6

- standalone OC4J instance, 1-5
 - with 10.1.2 Oracle HTTP Server, 1-4
 - with 10.1.2 OracleAS Web Cache, 1-4
 - with 10.1.2 OracleAS Web Cache cluster, 1-4
 - with 10.1.4 or 10.1.2 OracleAS Infrastructure, 1-4
- supported, 1-2 to 1-17
- trigger attribute (for replication-policy), 6-16
- troubleshooting, E-1
 - configuration assistants, D-1
 - general tips, E-1

U

- ulimit command, 2-14
- UNIX commands
 - groupadd, 2-18
 - limit, 2-14
 - passwd, 2-19
 - ulimit, 2-14
 - useradd, 2-19
- UNIX users
 - setting shell limits, 2-13
- user interface problems, E-3
- useradd command, 2-19
- users
 - setting shell limits for UNIX users, 2-13
- users (operating system)
 - see* operating system users

V

- virtual IP, 6-3

W

- Web Server
 - installation, 5-6
- Welcome page, URL for, 7-1
- write-quota attribute (in cluster tag), 6-18

X

- X Windows
 - installing from, 2-4

