

Oracle® Retail Price Optimization
User Guide
Release 12.0

July 2006

Price Optimization User Guide, Release 12.0

© Copyright 2006 Oracle. All rights reserved.

The Programs (which include both the software and documentation) contain proprietary information; they are provided under a license agreement containing restrictions on use and disclosure and are also protected by copyright, patent, and other intellectual and industrial property laws. Reverse engineering, disassembly, or decompilation of the Programs, except to the extent required to obtain interoperability with other independently created software or as specified by law, is prohibited.

The information contained in this document is subject to change without notice. If you find any problems in the documentation, please report them to us in writing. This document is not warranted to be error-free. Except as may be expressly permitted in your license agreement for these Programs, no part of these Programs may be reproduced or transmitted in any form or by any means, electronic or mechanical, for any purpose.

If the Programs are delivered to the United States Government or anyone licensing or using the Programs on behalf of the United States Government, the following notice is applicable:

U.S. GOVERNMENT RIGHTS Programs, software, databases, and related documentation and technical data delivered to U.S. Government customers are "commercial computer software" or "commercial technical data" pursuant to the applicable Federal Acquisition Regulation and agency-specific supplemental regulations. As such, use, duplication, disclosure, modification, and adaptation of the Programs, including documentation and technical data, shall be subject to the licensing restrictions set forth in the applicable Oracle license agreement, and, to the extent applicable, the additional rights set forth in FAR 52.227-19, Commercial Computer Software—Restricted Rights (June 1987). Oracle Corporation, 500 Oracle Parkway, Redwood City, CA 94065

The Programs are not intended for use in any nuclear, aviation, mass transit, medical, or other inherently dangerous applications. It shall be the licensee's responsibility to take all appropriate fail-safe, backup, redundancy and other measures to ensure the safe use of such applications if the Programs are used for such purposes, and we disclaim liability for any damages caused by such use of the Programs.

Oracle, JD Edwards, PeopleSoft, and Retek are registered trademarks of Oracle Corporation and/or its affiliates. Other names may be trademarks of their respective owners.

The Programs may provide links to Web sites and access to content, products, and services from third parties. Oracle is not responsible for the availability of, or any content provided on, third-party Web sites. You bear all risks associated with the use of such content. If you choose to purchase any products or services from a third party, the relationship is directly between you and the third party. Oracle is not responsible for: (a) the quality of third-party products or services; or (b) fulfilling any of the terms of the agreement with the third party, including delivery of products or services and warranty obligations related to purchased products or services. Oracle is not responsible for any loss or damage of any sort that you may incur from dealing with any third party.

Contents

1. Getting Started

About Oracle Retail Price Optimization	2
Checking Your Price Browser Settings	4
Cache Settings	9
Checking Your Merchant Desktop Browser Settings.....	11
Java Runtime Environment (JRE)	11
Logging on to Price	14
Understanding Timeouts	16
Understanding Navigation	17
Logging on to Merchant Desktop and Price.....	18
Understanding Navigation	22
Understanding Timeouts	22
Changing Your Password	24
User Profile screen	26
Access Levels	26
Understanding the Price User Interface	28
Understanding the Merchant Desktop User Interface	31
Price Schedule	35
Quick Reference to Common Price Tasks.....	36

2. Personalizing Merchant Desktop

About Merchant Desktop	41
About Personalization	42
Personalization Privileges.....	42
Personalizing Your View	43
Personalizing Screens.....	46
Personalizing Components.....	49
About Screens	50
Screen Types	50
About Components.....	52
Component Types	52

Contents

News Feed Component Type	54
HTTP Links Component Type	56
HTML Component Type	57
Alerts Component Type.....	58
Taking Action on Alerts.....	61
Oracle Retail Product Component Type.....	63
Report Component Type	64
Graph Component Type	65
Pie Charts.....	65
Bar Charts	66
Filter Component Type.....	67
Filtered Report Component Type	68
Filtered Graph Component Type.....	69
Top/Bottom Component Type.....	70
Numbered Prompts	70
Parameters Common to All Component Personalization Screens	73
3. Managing Markdowns	
Making Markdown Decisions	78
Reviewing Markdown Suggestions	78
Opening Worksheets.....	79
Editing Worksheets.....	81
Worksheet Summaries screen.....	83
Asking What If	86
The What-If Screen	87
Titles and Messages	87
Action	88
Forecast and Metrics.....	89
Scenario Settings Table.....	95
Graph	97
Creating What-If Scenarios	99
Applying the Optimize-to-Budget Feature.....	108
Optimize-to-Budget and Markdown Accounting	108
Before You Begin	108

Selecting Markdown Prices.....	114
Locating an Item or Pricing Group.....	114
Taking Recommended Markdowns.....	115
Changing a Markdown.....	116
Taking Markdowns in a Group.....	117
Taking Accelerated Markdowns.....	119
Removing a Markdown.....	121
Reverting a Markdown.....	122
Deciding Not to Take a Recommended Markdown.....	123
Viewing Results of Pricing Decisions.....	123
Saving Changes.....	123
Viewing Forecasts for One or More Worksheets.....	124
Recommended Forecast screen.....	125
Metrics.....	125
Viewing Item Details.....	127
Item Messages.....	128
Worksheet screen.....	130
Items and Pricing Groups in Data Views.....	130
Taken Markdown Status.....	133
Approving Decisions.....	134
Submitting Worksheets for Approval.....	134
Approving Worksheets.....	135
Declining Worksheets.....	135
Executing Worksheets.....	136

4. Managing Merchandise

About Maintaining Merchandise.....	138
About Exit Dates and Exit Date Inventory.....	139
Exit Dates.....	139
Target Exit Date Inventory and Sell-Through Percent.....	140
Exit Date Inventory.....	140
Sell-Through Percent.....	140
Managing Exit Dates.....	141
Changing Exit Dates from Their Default Values.....	141

Contents

Resetting Exit Dates to Their Default Values	143
Removing Exit Dates	144
Setting Exit Inventory or Sell-Through Targets	145
Setting for Multiple Items or Pricing Groups at a Time	145
Setting for One Item or Pricing Group at a Time	147
Maintaining Pricing Groups	148
Creating New Pricing Groups.....	148
Adding Items to Pricing Groups	150
Removing Items from Pricing Groups.....	152
Changing Pricing Group Names	153
Deleting Pricing Groups	154
5. Managing Worksheets	
Displaying Columns.....	156
Hiding Columns	157
Reordering Columns	158
Creating Columns.....	159
Editing Columns.....	161
Deleting Columns.....	163
Definition for Column dialog box.....	164
Sorting Data.....	166
Filtering Data.....	167
Filtering by Columns	167
Filtering by Merchandise Hierarchy	168
Exporting Data	169
Printing Data	170
Items which satisfy the selected alert screen.....	171
6. Reviewing Reports	
About Standard Reports	174
Understanding Dates in Reports	175
Creating Standard Reports.....	176
Accessing Standard Reports.....	179

Deleting Standard Reports.....	181
About Enhanced Reporting	182
Accessing Enhanced Reports	183
Report Data.....	183
Opening Enhanced Reports.....	184
A. Troubleshooting	
Price Problems and Solutions.....	188
ActiveX Downloads and Firewalls.....	191

Contents

Preface

This guide describes how to use Price to access worksheets and key items so that you can review forecasts and make markdown decisions. It is intended for buyers, assistant buyers, planners, GMMs, DMMs. In addition, this guide explains the optional Merchant Desktop feature, which provides you with access to all Oracle Retail products and enhanced reporting. Whether or not you have access to Merchant Desktop depends on whether your company is using that feature, and on how your Price application has been installed.

Audience

This guide assumes that you understand and have experience with the following:

- Using a browser
- Retail metrics
- Reading reports
- Your merchandise and location hierarchies, including your company's naming conventions for your merchandise

Documentation Accessibility

Our goal is to make Oracle products, services, and supporting documentation accessible, with good usability, to the disabled community. To that end, our documentation includes features that make information available to users of assistive technology. This documentation is available in HTML format, and contains markup to facilitate access by the disabled community. Accessibility standards will continue to evolve over time, and Oracle is actively engaged with other market-leading technology vendors to address technical obstacles so that our documentation can be accessible to all of our customers. For more information, visit the Oracle Accessibility Program Web site at

<http://www.oracle.com/accessibility/>

Accessibility of Code Examples in Documentation

Screen readers may not always correctly read the code examples in this document. The conventions for writing code require that closing braces should appear on an otherwise empty line; however, some screen readers may not always read a line of text that consists solely of a bracket or brace.

Accessibility of Links to External Web Sites in Documentation

This documentation may contain links to Web sites of other companies or organizations that Oracle does not own or control. Oracle neither evaluates nor makes any representations regarding the accessibility of these Web sites.

TTY Access to Oracle Support Services

Oracle provides dedicated Text Telephone (TTY) access to Oracle Support Services within the United States of America 24 hours a day, seven days a week. For TTY support, call 800.446.2398.

Related Documents

For additional information about using Price, see the following:

- *Oracle Retail Price Optimization Installation Guide* for instructions on setting up the application server and database environment for Price as well as installing Price.
- *Oracle Retail Price Optimization Configuration Guide* for instructions on configuring the Price front end (user interface), loading data, and configuring and performing runs.
- *Oracle Retail Price Optimization User Guide* for information on how to use Price and on all its functionality and screens.
- *Oracle Retail Price Optimization Operations Guide* for instructions on weekly processes and maintaining Price.
- *Oracle Retail Price Optimization Administration Guide* for information intended for system administrators, including how to use the User Management component, and how to work with the Business Rules Property Manager.
- *Oracle Retail Price Optimization Online Help* for instructions on accessing worksheets, key items, forecasts, reports, etc., and for using features such as What If and Optimize to Budget.
- If your installation of Price includes Merchant Desktop, see the Merchant Desktop Help for instructions on accessing Price, Price merchandise alerts, and enhanced reporting; using worksheets, What If, and Optimize to Budget features; and personalizing your desktop.

Conventions

The following text conventions are used in this document:

Convention	Description
>	Shows navigation through the user interface. For example, Click Tools menu > Internet Options means to click the Tools menu and then the Internet Options menu item.
Monospace	Represents text that you must type
<i>Monospace italic</i>	Indicates a variable for which you supply a value
Note:	Indicates exceptions and information that, if omitted, can cause you to perform one or more actions again
Caution:	Indicates danger to the integrity of the data or system

1

Getting Started

This chapter contains the following information:

- “About Oracle Retail Price Optimization” on page 2
- “Checking Your Price Browser Settings” on page 4
- “Checking Your Merchant Desktop Browser Settings” on page 11
- “Logging on to Price” on page 14
- “Logging on to Merchant Desktop and Price” on page 18
- “Changing Your Password” on page 24
- “User Profile screen” on page 26
- “Understanding the Price User Interface” on page 28
- “Understanding the Merchant Desktop User Interface” on page 31
- “Price Schedule” on page 35
- “Quick Reference to Common Price Tasks” on page 36

About Oracle Retail Price Optimization

The timing and depth of markdowns are important levers for managing the optimal balance of profitability and returns. To help you manage these levers, Price makes recommendations for markdowns within the constraints of your company's particular business requirements.

The markdowns that Price recommends:

- Bring inventory to the desired level, not only during the full-price selling period, but also during price-break sales.
- Maximize total gross margin dollars over the entire product lifecycle.

In addition to markdown recommendations, Price provides data about sales, gross margin, and inventory. This information can help you understand in-season performance as well as assess the impact of markdown decisions prior to execution.

Price provides the following features:

- **Centralized information** - Allows you to quickly focus on the merchandise that need special attention. If your company is using the Merchant Desktop feature, you can view this information on your desktop in a variety of forms, including reports, graphs, and a special Top/Bottom feature. For details on the Merchant Desktop feature, see “Personalizing Merchant Desktop” on page 39. For details on the Top/Bottom feature, see “Top/Bottom Component Type” on page 70.
- **Automated analysis** - Helps you to test possible scenarios, forecast demand in each scenario, and select the optimal scenario. You can test multiple scenarios prior to making a markdown decision. For more details, see “Asking What If” on page 86.
- **Automated optimize-to-budget process** - Enables you to take the optimal markdowns while remaining within your monthly budget. For more details, see “Applying the Optimize-to-Budget Feature” on page 108.
- **Standardized markdown process** - Enables you to maximize gross margin dollars and meet defined sell-through targets, while conforming to your business constraints. For details, see “Selecting Markdown Prices” on page 114, “Approving Decisions” on page 134, and the Business Rules section of the *Oracle Retail Price Optimization Administration Guide*.
- **Increased visibility** - Lets you examine store-level product demand over the entire merchandise lifecycle.

- **Updated recommendations each week** - Facilitates decision-making that is based on recent data, including new sales, inventory, price levels, planned promotions, and other relevant data.
- **Support for customized user preferences** - Enables you to tailor the information that is displayed on each screen to your particular needs. For details, see “Managing Worksheets” on page 155. If your company is also using the Merchant Desktop feature, see “Personalizing Merchant Desktop” on page 39.

Checking Your Price Browser Settings

Price is a web application that runs in the Microsoft® Internet Explorer web browser, version 6.0 or newer.

Note: In addition to the Internet Explorer web browser, your PC must be set up with Microsoft Excel 2000 or newer if you want to export Price data or access Price standard reports.

Before you attempt to access Price, check your browser settings for the following:

Note: Price 12.0 supports nine languages: English, German, Spanish, French, Japanese, Korean, Portuguese, simplified Chinese, Taiwan Chinese. To change language settings take care that your internet browser settings and Windows control panel settings are set to the same language. For more information, see the Localization chapter in the Price Configuration Guide.

Note: If you are using the Merchant Desktop feature, there are additional browser settings you must check as explained in “Checking Your Merchant Desktop Browser Settings” on page 11.

- **Security settings for Price URL** - Add the Price URL to the appropriate zone (Local intranet or Trusted sites) to ensure that the Price application will use the security settings for this zone.

Important: Do *not* use the Internet zone to configure browser settings for Price. Use only the Local intranet zone or the Trusted sites zone, as explained in the following table.

If	Configure browser settings for
Price is installed and hosted by your company	Local intranet zone Note: The default security settings for the Local intranet zone are not sufficient. Therefore, make sure that you adjust the security settings as explained in the following procedure.

If	Configure browser settings for
<p>Price is installed and hosted by Oracle Retail</p>	<p>Trusted sites zone</p> <p>When Oracle Retail hosts Price for you, Internet security settings apply by default, and these settings are not sufficient for Price. Therefore, add the Price URL to the list of Trusted sites. Even though the default security settings for Trusted sites may be sufficient for Price, it is highly recommended that you check them as explained in the following procedure.</p>
<p>The application language must be changed (other than English) to any of the following languages:</p> <p>English, German, Spanish, French, Japanese, Korean, Portuguese, simplified Chinese, Taiwan Chinese</p>	<p>Windows Control Panel selections and your Internet browser setting selections must be set to match the same language.</p> <p>Select the languages button on the Internet Options pop up screen. For more information, see the Localization chapter within the Price Configuration Guide.</p> <p>Select the same language on your Windows Control Panel, Regional and Language Options. For more information, see the Localization chapter in the Price configuration Guide.</p>

- **Scripting** - Typically, the Internet Explorer default settings are sufficient. However, it is a good idea to check scripting options for the Price-specific zone (Local intranet or Trusted sites) as outlined in the following procedure. Scripting is required for most Price functions, including reporting.

To configure Internet Explorer for Price:

1. Start Internet Explorer as you normally do.
2. From the Tools menu, select **Internet Options**.
3. On the Internet Options dialog box, click the **Security** tab.
4. On the Security tab, click **Local intranet**, or, if you have been instructed to do so by the administrator, **Trusted sites**, and then click the **Sites** button.

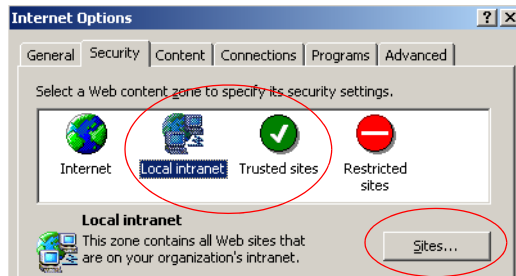

Important: Do *not* select Internet unless you have been instructed to do so by the administrator. In most cases, the Price application will be available on your company's intranet or on a Oracle Retail trusted site.

If you selected Local intranet, go to step 5. If you selected Trusted sites, go to step 6. (The Local Intranet dialog box in step 5 does not appear when you select Trusted sites.)

5. On the Local intranet dialog box, click the **Advanced** button (as in the following example).

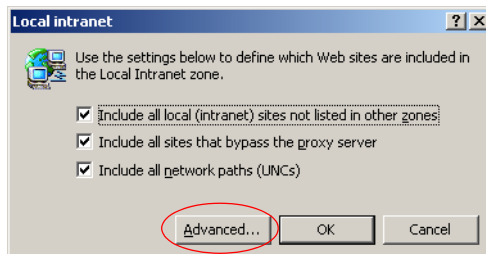

6. On the resulting Local intranet or Trusted sites dialog box, add the Price URL if it is not already listed.

To do so, type the Price URL in the Add this Web site to the zone text box (similar to the following example) and click **Add**. When the URL appears in the Web sites list, click **OK**.

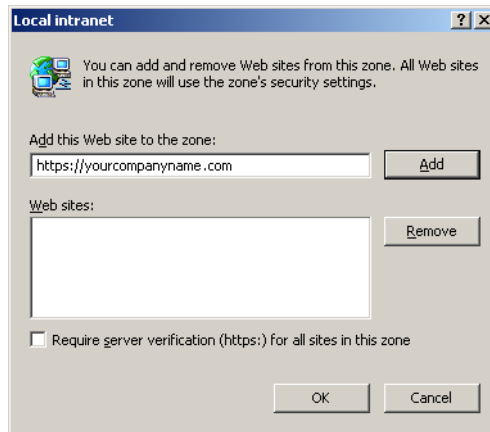

7. If the Local Intranet dialog box from step 5 is still open, click **OK** to close it.
8. On the Internet Options dialog box, Security tab, select **Local intranet** or **Trusted sites** (as in the following example) and then click the **Custom Level** button.

Also, if you are changing the language settings to match your Windows control panel language settings, select the language setting within Internet Options from your internet browser. For more information, see the Localization chapter within the *Oracle Retail Price Optimization Configuration Guide*.

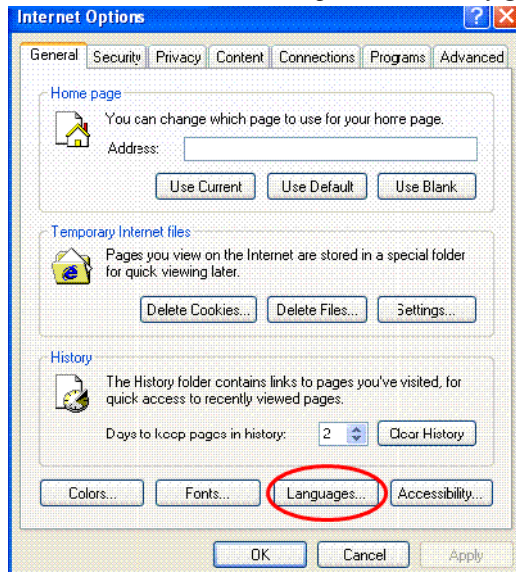

9. On the Security Settings dialog box, make sure the following commands are set to Prompt or Enable, and then click **OK**.

The *Prompt* setting provides a message box each time Internet Explorer encounters the specified command (e.g., Download signed ActiveX controls). The *Enable* setting bypasses the message box and instead performs the specified command without notifying you.

In general, you could select Prompt for the download options because the downloads typically occur one time. For the running and scripting options, however, you could select Enable because those commands occur frequently. (If you would set these options to Prompt, you might have to respond to a message box several times in one Price session.)

- **Download signed ActiveX controls**
- **Run ActiveX controls and plug-ins**
- **Script ActiveX controls marked safe for scripting**
- **File download**
- **Active scripting**
- **Initialize and script ActiveX controls not marked as safe** - A Microsoft ActiveX[®] control is required each time you export to Excel. While this ActiveX control is *signed*, it is not marked as safe (meaning that it could potentially be used to do unsafe things). If you set this option to Prompt, you will be prompted each time you select the Price Export action.

The following example uses the Prompt setting for the **Initialize and script ActiveX controls not marked as safe** command.

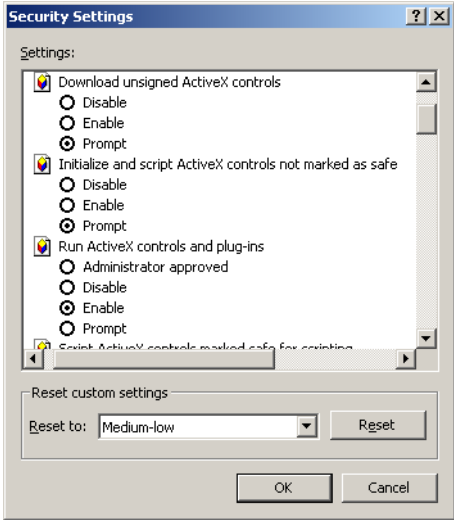

The following example shows the prompt that appears when there is a request from an application to use an ActiveX control that is not marked as safe.

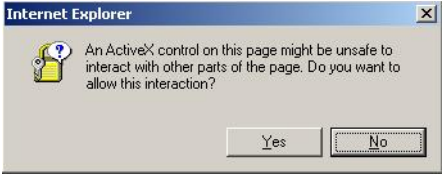

10. On the Internet Options dialog box, click **OK** to return to the browser.

What to Do Next

If you are using the Merchant Desktop feature, see “Checking Your Merchant Desktop Browser Settings” on page 11.

See “Logging on to Price” on page 14.

Cache Settings

In most cases, you do not need to check your cache settings. The Internet Explorer default cache setting is Automatic, which is sufficient for Price. The Automatic setting ensures that Internet Explorer checks for updates to the Price software. If you do want to check your cache settings, use the following procedure.

To check Internet Explorer cache settings:

1. From the Tools menu, select **Internet Options**.

Chapter 1
Getting Started

2. On the Internet Options dialog box, General tab, Temporary Internet Files section, click the **Settings** button.
3. On the Settings dialog box, select **Automatically** (as in the following example) if it is not selected already, and click **OK**.

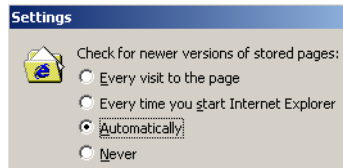

Note: You can also select **Every visit to page**.

4. On the Internet Options dialog box, click **OK** to return to the browser.

Checking Your Merchant Desktop Browser Settings

The following sections pertain to the optional Merchant Desktop feature. If your company is not using Merchant Desktop, these sections do not apply to you.

Note: The optimum resolution for viewing Merchant Desktop screens is 1280 x 1024 or 1280 x 960. If you are using a laptop or other device that does not permit resolution that high, however, you may need to set the resolution to something like 1024 x 768. The optimum number of colors is True Color (32 bit).

In addition, your computer must meet the following requirements to use Merchant Desktop:

- Internet Explorer 6.0 or newer
- Java™ Runtime Environment (JRE) 1.4.2 or newer
- Java scripting enabled
- Cookies enabled

Because you will be accessing Price from the same browser, make sure that you also check the browser settings for Price as explained in “Checking Your Price Browser Settings” on page 4.

Java Runtime Environment (JRE)

If you are not using the enhanced reporting feature, which provides the MicroStrategy® Web Universal application through Merchant Desktop, you can skip this section.

The Java 2 Standard Edition JRE 1.4.2 or higher is required for viewing the hierarchical trees (similar to the tree in Windows explorer) from which you select reports, graphs, and levels of the merchandise and location hierarchies, and time periods. Following is a small portion of the tree from which you select reports.

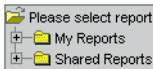

If you don't have the JRE installed, you may be prompted to install it when you first access a Merchant Desktop reporting component. Follow the steps below to download (if necessary) and install JRE.

To download JRE 1.4.2:

1. Start Internet Explorer and enter the following URL:
`http://java.sun.com/j2se/1.4.2/download.html`
2. In the J2SE v 1.4.2_*nm* JRE section, click the **Download J2SE JRE** link.
3. On the download screen, click the download icon for one of the Windows platform files. (Both files install the correct JRE.)
4. Answer the prompts as you normally do when downloading files from the Internet.

To install JRE 1.4.2:

1. If Merchant Desktop did not prompt you to download and install the JRE, double-click the file you downloaded in the previous procedure.
`j2re-1_4_2_04-windows-i586-p.exe`
or
`j2sdk-1_4_2_04-windows-i586-p-iftw.exe`
2. Respond to each of the installation wizard screens.
For the set up type, accept the default, which is **Typical**.
3. After the install is complete, restart your computer.
4. Start Internet Explorer and select **Tools** menu > **Internet Options**.
5. On the Internet Options dialog box, click the **Advanced** tab and scroll down to the Java (Sun) section.

6. Verify that **Use Java 2 v1.4.2_nn ...** option is selected, as shown below.

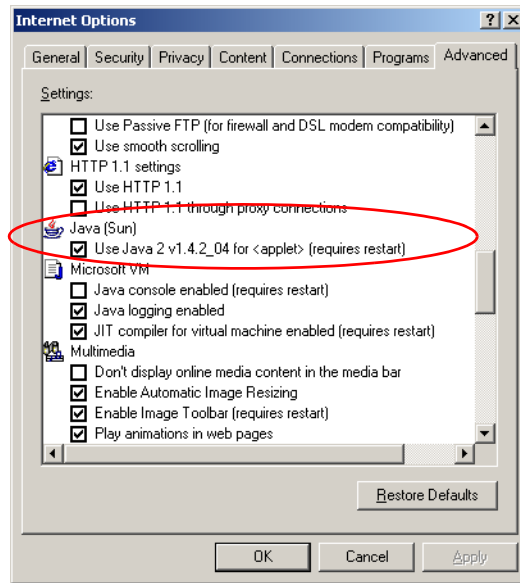

When your computer has successfully restarted, and the Java option is selected, see “Logging on to Merchant Desktop and Price” on page 18.

Logging on to Price

If you are using Price without the Merchant Desktop feature, follow the instructions in this section. If you are using Merchant Desktop with Price, follow the log on instructions in “Logging on to Merchant Desktop and Price” on page 18.

Before you access Price for the first time, do the following:

- Check your settings for Microsoft Internet Explorer. For details, see “Checking Your Price Browser Settings” on page 4.
- Obtain the following from the Price administrator:
 - The Price URL (uniform resource locator); the URL is sometimes referred to as the “web address.” This is what you will enter from your Internet browser to access Price. The URL will look similar to the following:

`https://yourcompanyname.p4p.oracle.com`

- A username and password. You will enter your username and password on the Price login screen.

To access Price:

1. Start Internet Explorer as you normally do.
2. In the Address field, enter the Price URL for your company and press Enter.

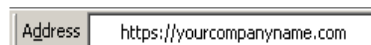

The image shows a close-up of an Internet Explorer address bar. The text 'Address' is visible on the left side of the bar, and the URL 'https://yourcompanyname.com' is entered into the main field.

Note: Make sure you use **https** (instead of just http).

If you have not downloaded the Microsoft Common Dialog control yet, a prompt appears asking you to do so. Otherwise, the Price login screen appears.



To avoid further prompts of this security warning, click the Always trust content from Microsoft Corporation check box and click the **Yes** button.

The Microsoft Common Dialog control is downloaded to your computer and appears in the Downloaded Program Files directory.

3. On the login screen, enter your username and password in the appropriate fields and then click the **Login** button.

Your username and password are case-sensitive. If you are unable to log in, check your keyboard to make sure that the Caps Lock key is not selected.

If you forget your password, contact the Price administrator to get a new password.

When you successfully enter your username and password, the Price Main Menu appears.

What to Do Next

For information on how to use the Price user interface, see “Understanding the Price User Interface” on page 28. Otherwise, select any of the following links from the Main Menu, depending on what you want to accomplish:

- **Markdowns.** For details, see “Making Markdown Decisions”, explained on page 78.
- **Maintaining Merchandise.** For details, see “About Maintaining Merchandise” on page 138.
- **Business Rule Property Manager.** For details, see the Business Rules section of the *Oracle Retail Price Optimization Administration Guide*.

- **User Management.** This link appears only if your user account has been assigned a role to perform user management functions. For details, see the User Management section of the *Oracle Retail Price Optimization Administration Guide*.
- **User Profiles.** For details, see “Changing Your Password” on page 24.
- **Reports.** For details, see “About Standard Reports” on page 174.

You can return to the Main Menu by clicking the Main Menu link in the upper-right of most Price screens.

Understanding Timeouts

Important: After you are logged on, Price will time out after one hour of inactivity on the *server*. This means that although you may be working with worksheets, the timeout message could still appear because the server is inactive when you are manipulating worksheets. Therefore, it is recommended that you save your work regularly.

A message similar to the following appears five minutes before the timeout occurs, giving you the opportunity to save your work.

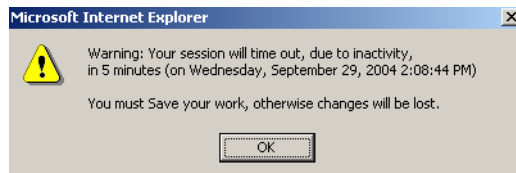

If your session does time out, the following message appears:

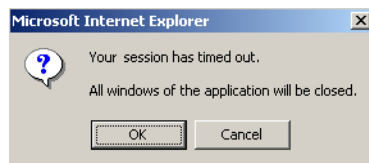

When this occurs, click **OK**. The Login screen appears and you must enter your username and password again.

Additionally, the Business Rules Property Manager utility and the User Management utility (not available to most users) have separate timeouts. Thus, if you access either of these utilities and then leave them inactive, similar timeout messages will appear.

Understanding Navigation

While you use Price, always use the Price buttons, menus, and links to navigate from screen to screen. For example, when you are finished with a worksheet and want to return to the Worksheet Summaries screen, click the **Done** button rather than clicking the X in the upper-right corner of the Internet Explorer window. If you do click the X, the following warning appears.

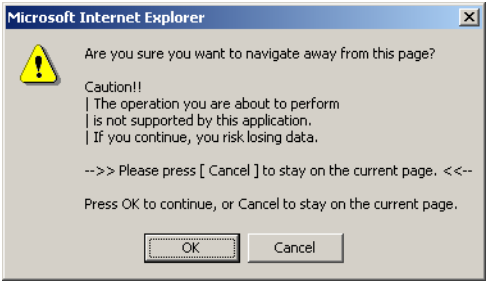

Click **Cancel** on this dialog box and then navigate from the Price screen using the Price buttons or links.

Logging on to Merchant Desktop and Price

The following sections pertain to the optional Merchant Desktop feature. If your company is not using Merchant Desktop, these sections do not apply to you.

Before you access Merchant Desktop or Price for the first time, make sure you have checked your browser settings as explained in the following sections:

- “Checking Your Price Browser Settings” on page 4
- “Checking Your Merchant Desktop Browser Settings” on page 11

To log on to Merchant Desktop and Price:

1. Start Internet Explorer as you normally do.

Note: Do not open a new window for Merchant Desktop via File > New Window. Only one Merchant Desktop user should be logged on a computer at a time. Otherwise, unpredictable results can occur.

2. In the Address field, enter the URL for your company (similar to the following) and press Enter.

Address

Note: Make sure you use **https** (instead of just http).

If you have not downloaded the Microsoft Common Dialog control yet, a prompt appears asking you to do so. Otherwise, the Price login screen appears.



To avoid further prompts of this security warning, click the Always trust content from Microsoft Corporation check box and click the **Yes** button.

The Microsoft Common Dialog control is downloaded to your computer and appears in the Downloaded Program Files directory. After you click Yes, the Price login screen appears.

3. On the login screen, enter your username and password in the appropriate fields and then click the **Login** button.

Your username and password are case-sensitive. If you are unable to log in, check your keyboard to make sure that the Caps Lock key is not selected.

When you successfully enter your username and password, Merchant Desktop appears with the view (default screen and horizontal row of available screens) that the administrator has assigned to you. (The view and administrative rights assigned to your login name determine what is displayed.)

If the administrator has not yet assigned a view to you, the Unassigned View Screen appears with a message to contact the administrator.

In most cases, your assigned view will be customized for your company and possibly for your department. Following is a sample view that a buyer might use, with access to Oracle Retail products, retail news, and reports. Other screens (accessed by clicking each tab) provide markdown information and forecasts.

Chapter 1
Getting Started

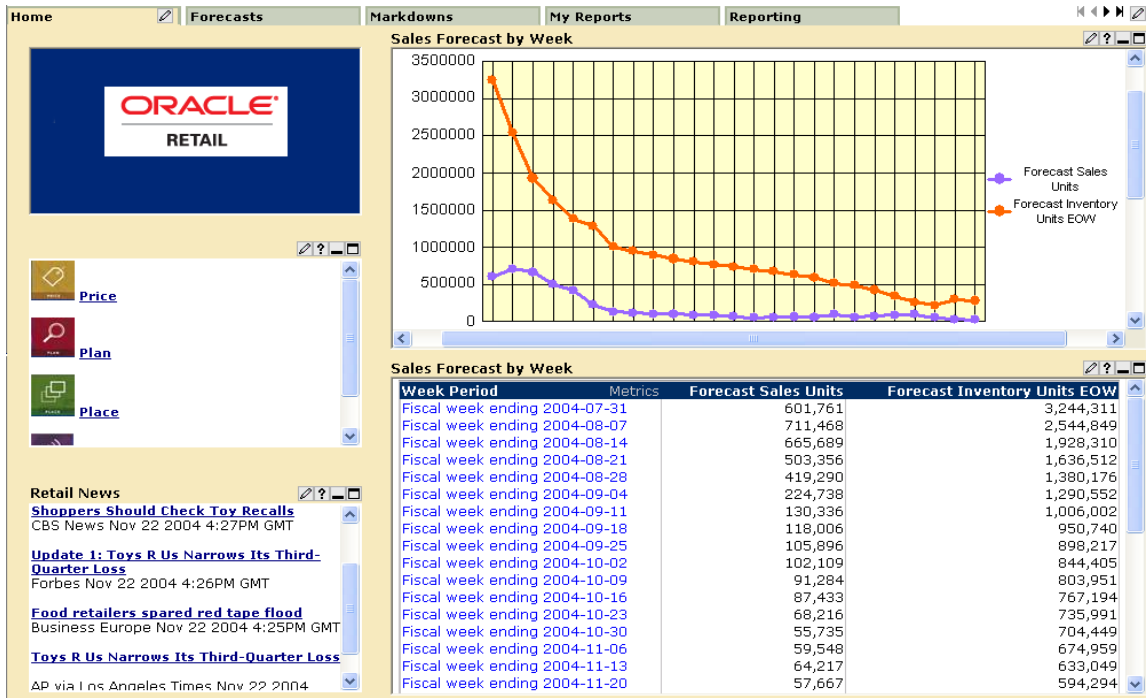

- If you also want to access Price, scan your Merchant Desktop screens to locate the Oracle Retail component window. It may look similar to the following:



For more information on this component window, see “Oracle Retail Product Component Type” on page 63.

- On the Oracle Retail products component window (which may be named differently at your site), click the **Price** link.

The Price Main Menu appears. When you log on to the Merchant Desktop, your username and password are automatically verified against the Oracle Retail products at your site; therefore, you do not have to log on to Price separately.

To exit Price and return to Merchant Desktop, click the Close link in the upper-right of any Price screen.

What to Do Next

For information on how to use Merchant Desktop, see “Understanding the Merchant Desktop User Interface” on page 31. In addition:

- To customize your view of Merchant Desktop, see “Personalizing Your View” on page 43.
- To access enhanced reports, see “Accessing Enhanced Reports” on page 183.

For information on how to use Price, see “Understanding the Price User Interface” on page 28. Otherwise, each Price main menu item is explained in the following sections:

- **Markdowns.** For details, see “Making Markdown Decisions”, explained on page 78.
- **Maintaining Merchandise.** For details, see “About Maintaining Merchandise” on page 138.
- **Business Rule Property Manager.** For details, see the Business Rules section of the *Oracle Retail Price Optimization Administration Guide*.
- **User Management.** This link appears only if your user account has been assigned a role to perform user management functions. For details, see the User Management section of the *Oracle Retail Price Optimization Administration Guide*.
- **User Profiles.** For details, see “Changing Your Password” on page 24.
- **Reports.** For details, see “About Standard Reports” on page 174.

For both Merchant Desktop and Price, review “Understanding Navigation” on page 22 and “Understanding Timeouts” on page 22.

Getting Help

While you are in the Merchant Desktop user interface, you can access help at any time by clicking the help icon  or by clicking the Help link in the upper-right of the Merchant Desktop screen, as shown below.



Likewise, to access Price help, click the Help link in the upper-right of any Price screen, as shown below. Notice that instead of a Logout link, the Price screen displays a Close link. Click Close to exit Price and return to Merchant Desktop.



Understanding Navigation

In general, use the Merchant Desktop screen tabs to navigate from screen to screen instead of using the browser's back and forward buttons. No error message appears if you attempt to do so, but it is good practice to always use the Merchant Desktop tabs, links, and buttons instead of those provided by the browser.

For Price, always use the Price buttons, menus, and links to navigate from screen to screen. For example, when you are finished with a worksheet and want to return to the Worksheet Summaries screen, click the **Done** button rather than clicking the X in the upper-right corner of the Internet Explorer window. If you do click the X, the following warning appears.

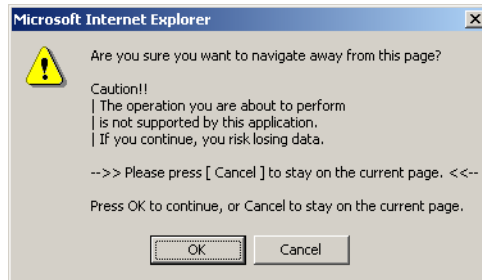

When this occurs, simply click **Cancel** and then navigate via the Price user interface.

Understanding Timeouts

Merchant Desktop and Price have independent timeouts. Thus, if you work only in Price for a long time, a timeout message for Merchant Desktop may appear.

Likewise, if Price is open and you work in Merchant Desktop for a long time, a timeout message for Price may appear.

Merchant Desktop Timeouts

Important: After you are logged on, Merchant Desktop will time out after approximately 20 minutes of inactivity. This is independent of any Price activity. Therefore, it is recommended that you save your work regularly.

A message similar to the following appears five minutes before the timeout occurs, giving you the opportunity to save your work.

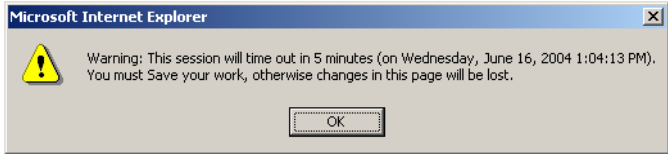

When this message appears, click **OK**.

- If your session has not timed out yet, you can continue working.
- If your session has timed out, the login screen will appear when you first attempt to navigate or perform another action on the screen.

Price and Related Timeouts

Important: After you are logged on, Price will time out after 20 minutes of server inactivity. Thus, although you may be working with worksheets, the timeout message could still appear because the server is inactive when you are manipulating worksheets. Therefore, it is recommended that you save your work regularly.

A message similar to the following appears five minutes before the timeout occurs, giving you the opportunity to save your work.

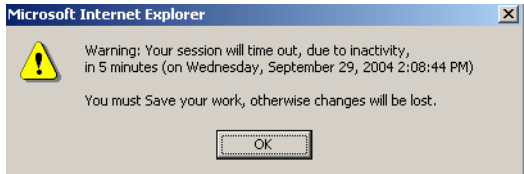

If your session does time out, the following message appears:

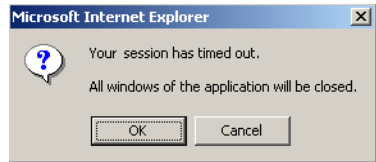

When this message appears, click **OK**. The Login screen appears and you must enter your username and password again.

Additionally, the Business Rules Property Manager utility and the User Management utility (not available to most users) have separate timeouts. Thus, if you access either of these utilities from Price and then leave them inactive, similar timeout messages will appear.

Changing Your Password

After you log in to Price the first time, it is a good idea to change your password from the one given to you by the administrator.

Note: If you forget your password, contact the Price administrator to get a new password.

To change your password:

1. From the Main Menu, click **User Profiles**.

The User Profile screen appears, as in the following example.

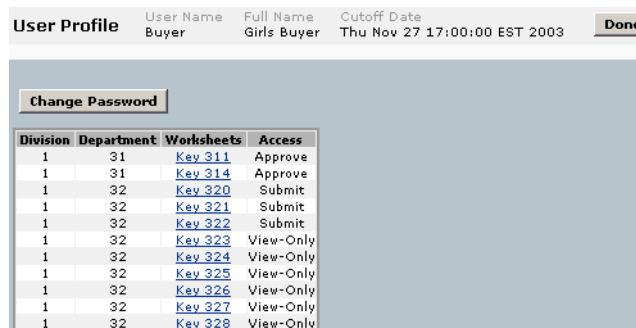

The screenshot shows a 'User Profile' window with the following information:

User Name	Full Name	Cutoff Date
Buyer	Girls Buyer	Thu Nov 27 17:00:00 EST 2003

Below this is a 'Change Password' button and a table of user access details:

Division	Department	Worksheets	Access
1	31	Key 311	Approve
1	31	Key 314	Approve
1	32	Key 320	Submit
1	32	Key 321	Submit
1	32	Key 322	Submit
1	32	Key 323	View-Only
1	32	Key 324	View-Only
1	32	Key 325	View-Only
1	32	Key 326	View-Only
1	32	Key 327	View-Only
1	32	Key 328	View-Only

2. Click **Change Password**.

The Set Password for user: *username* dialog box appears.



The dialog box is titled 'Set Password for user: user' and has 'Done' and 'Cancel' buttons. It contains three input fields:

- Old Password
- New Password
- Confirm New Password

3. Complete the Set Password for user: *username* dialog box as follows:

Important: All passwords are case-sensitive. Make sure that the Caps Lock key is not selected.

- a. In the Old Password text box, type your existing password.
- b. In the New Password text box, type your new password. You can use any combination of letters, numbers, and symbols, up to 50 characters.

c. In the Confirm New Password text box, type your new password again.

4. Click **Done**.

If the new password does not match the confirmation password, an error message appears. Click OK on the error message dialog box and complete the New Password and Confirm New Password text boxes again.

Otherwise, the dialog box closes and the User Profile screen appears. There is no confirmation message.

Your password is changed to the new password you entered. You must use this password the next time you want to log on to Price.

User Profile screen

The User Profile screen appears when you select User Profiles from the Main Menu. Both your username, which you used to log in to the application, and your full name are displayed on the top of this screen. The cutoff date, which is the date by which worksheets must be submitted and approved, is also displayed.

Use the User Profile screen to do the following:

- Change your password. For details, see “Changing Your Password” on page 24.
- View a list of the worksheets you can access along with the level of access you have to each.
- Navigate directly to a worksheet. To do so, click the worksheet link in the Worksheets column.

Access Levels

The following table describes Price access levels to worksheets. The access levels for each worksheet are set by the administrator. The Action list box and buttons that appear on the worksheet determine what actions you can perform on each worksheet.

Access level	Description
View-only	You can view the contents of the worksheet, sort and filter the worksheet data, and perform a what-if analysis, but you cannot change it or take markdowns for it. When you access a worksheet for which you have view-only access, the following appears at the top of the worksheet: Warning: The worksheet is read-only. The Done button is the only available button.
Submit	You can edit the worksheet, take or remove markdowns, perform what-if and optimize-to-budget analyses, and submit the worksheet for approval. You can also save the changes you make to the worksheet. However, you cannot approve (or decline) the changes made to this worksheet.

Access level	Description
Approve	You can perform all of the actions allowed by the Submit access level, but you can additionally approve or decline submitted worksheets.

Understanding the Price User Interface

The following illustration shows features common to most Price screens.

Note: Although your Price screens will have the same features, the column names and metrics are typically customized for each site. Therefore, your screens may display column headings and metrics that do not appear in the screen captures.

The screenshot shows a software interface for price management. At the top, there are navigation links (About, Help, Logout, Main Menu) and a status bar with 'Worksheet' as the screen name. Below this, there are data view tabs: 'Items By Name', 'Items (Flat)', 'Pricing Groups', and 'Items By Pricing Group'. The main area contains a table with columns for Description, item_id, Target ST% EOL, Target OH EOL, Taken MD Cost, Taken MD, Curr % Off, Rtl Price, and TW. The table is annotated with 'Action list' and 'Hierarchy filters'. At the bottom, there are summary metrics and status fields for '# Recs', '# Taken', 'Status', 'Not Submitted', 'Effective Date', and 'Modified By'. Red annotations highlight various features: 'Merchandise hierarchy position' (gray text), 'Deadline to take and submit markdowns' (cutoff date), 'General links' (top right), 'Command buttons' (Save, Submit, Done), 'Data view tabs', 'Check box to select all items', 'Check boxes to select individual items', 'Expand + and Collapse -', 'Link to display item information', and 'Customizable rows and columns'.

Screen area	Description
Merchandise hierarchy position	This gray text displays the names of the levels in your merchandise hierarchy, while the black text displays the current position in the hierarchy.
Deadline to take and submit markdowns	This date and time, commonly called the <i>cutoff date</i> , indicate the time by which you must take and submit markdowns so that they will be reflected in the next Price optimization and in your company's pricing system.

Screen area	Description
General links	<p>About - Shows the version number, build number, date, time, and status of Price.</p> <p>Help - Opens a browser that displays the online help system. When you click the Help link, a File Download dialog box may appear, asking if you would like to open the file or save it to your computer. It is recommended that you click Open to use the help system from its current location.</p> <p>Logout - Click this link to end your Price session.</p> <p>Main Menu - Opens the Price Main Menu, from which you can access worksheets, merchandise, Business Rule Property Manager, the worksheet rights assigned to your user account, and reports.</p>
Screen name	All screens are referred to by the screen name. Unlike the names of hierarchy levels and columns, the screen names are constant for all Price implementations.
Command buttons	The names of the buttons vary slightly from screen to screen, but in general most screens provide a Save button and a Done button. It is important to regularly save your changes, especially if a time out message appears. See “Understanding Timeouts” on page 22 for more information.
Data view tabs	<p>One or more data view tabs are typically available, each describing the type or organization of merchandise data. Each view contains items or pricing groups (formerly called <i>collections</i>):</p> <ul style="list-style-type: none"> • Items - You can change the price, but you can’t expand them. • Pricing groups - You can change the price for the entire group, and you can expand the group and change the price on the expanded items within the group.

Screen area	Description
Action list	<p>The Action list contains the actions you can perform on the current screen. Some actions require that you select one or more items first, and other actions apply to all of the data on the screen.</p> <p>After you select an action, click the Apply button.</p>
Hierarchy filters	<p>From these list boxes, you can filter the items or pricing groups that appear on the worksheet.</p> <p>After you select a merchandise or location hierarchy level, click the Show button.</p>
Item or pricing group data	<p>This section contains the actual data. The two left most columns are for selecting the items or pricing groups on which you want to perform an action.</p>
Summary metrics and status	<p>These are customized to reflect the metrics that are most important to your stores.</p>

Understanding the Merchant Desktop User Interface

The following sections pertain to the optional Merchant Desktop feature. If your company is not using Merchant Desktop, these sections do not apply to you.

Your Merchant Desktop may display names and metrics that do not appear in the screen captures in this help guide.



Note: The pencil buttons for personalizing the view, screens, or components, appear only if the administrator has given your user account those permissions.





The screenshot shows the Oracle Retail Merchant Desktop interface. The top navigation bar includes Home, Forecasts, Markdowns, View, My Reports, and Reporting. The main content area is divided into several sections:



- Left Sidebar:** Contains navigation icons for Price, Plan, and Place. Below these is a "Retail News" section with several news items, each with a "Title bar" and a "Screen" icon.
- Top Right:** A "View" tab is active, and "View scroll arrows" are visible.
- Main Chart:** A line chart titled "Sales Forecast by Week" showing "Forecast Sales Units" (purple line) and "Forecast Inventory Units EOW" (orange line) from July 2004 to November 2004. A "Component personalization" icon is located near the chart.
- Main Table:** A table titled "Sales Forecast by Week" with columns for "Week Period", "Metrics", "Forecast Sales Units", and "Forecast Inventory Units EOW".

Annotations in red boxes and arrows point to various elements: "Screen personalization" points to the Home icon; "View personalization" points to the View tab; "Component personalization" points to a pencil icon near the chart; "Components" points to a large red arrow pointing to the chart area; "Title bar" points to the title of a news item; and "Screen" points to the screen icon of a news item.

Week Period	Metrics	Forecast Sales Units	Forecast Inventory Units EOW
Fiscal week ending 2004-07-31		601,761	3,244,311
Fiscal week ending 2004-08-07		711,468	2,544,849
Fiscal week ending 2004-08-14		665,689	1,928,310
Fiscal week ending 2004-08-21		503,356	1,636,512
Fiscal week ending 2004-08-28		419,290	1,380,176
Fiscal week ending 2004-09-04		224,738	1,290,552
Fiscal week ending 2004-09-11		130,336	1,005,002
Fiscal week ending 2004-09-18		118,006	950,740
Fiscal week ending 2004-09-25		105,896	898,217
Fiscal week ending 2004-10-02		102,109	844,405
Fiscal week ending 2004-10-09		91,284	803,951
Fiscal week ending 2004-10-16		87,433	767,194
Fiscal week ending 2004-10-23		68,216	735,991
Fiscal week ending 2004-10-30		55,735	704,449
Fiscal week ending 2004-11-06		59,548	674,959
Fiscal week ending 2004-11-13		64,217	633,049
Fiscal week ending 2004-11-20		57,667	594,294

Feature	Description
View	<p>The row of screen tabs from which you can access each screen</p> <p>Click the pencil button  at the end of the row to display the View Personalization screen, from which you can change the names and order of the screens and add additional screens.</p>
Screen	<p>For the selected screen tab, the collection of the individual component windows</p> <p>Click the screen name on each tab to display that screen.</p> <p>Click the pencil button  next to the screen name to display Screen Personalization, where you can change the screen name and position and types of components.</p>
Component	<p>Within a screen, each individual window, typically with a border and title bar. However, component windows can be customized to hide the title bar.</p> <p>If available, click the pencil button  in the title bar of each component to display the Component Personalization screen, where you can change the title bar name and modify component contents and display.</p>
Title bar	<p>For each component, the text that identifies the component and the personalize, help, minimize, and maximize buttons.</p> <p>Note: Title bars may not be available depending on how the administrator has set up Merchant Desktop.</p>

Feature	Description
<p>Component title bar buttons</p>	<p> - Pencil button that displays the component personalization screen where you can change component contents or component parameters such as show/hide title bar. If this button does not appear, the administrator has disabled that feature.</p> <p> - Help button that displays help for that component</p> <p> - Minimize button that hides the component contents (not the title bar). The minimize function is intended for you to temporarily hide a component. Therefore, the component is minimized only until you click another screen. If you do not want a component to appear at all, remove it via Screen Personalization or ask the administrator to remove it for you.</p> <p> - Maximize button that expands the component to fill the screen. The maximize function is intended for you to temporarily expand a component for easier viewing. Therefore, the component is maximized only until you click another screen. If you want the component to appear on its own screen so that is always enlarged, ask the administrator to add this screen for you.</p> <p> - Restore button that returns the component to its original state after it has been minimized or maximized.</p>

Feature	Description
<p>View scroll arrows (grayed out in the picture above)</p> 	<p>From left to right, the scroll arrows display the tabs as follows - the first tab in the series, the next tab to the left in the series, the next tab to the right in the series, and the last tab in the series.</p> <p>Gray indicates that the arrow is disabled because there are no tabs to display in that direction.</p> <p>The number of tabs displayed at one time depends on the length of each tab name, the amount of space available on the screen, and the screen resolution. When there are more tabs than can fit in a view, you must use the scroll arrows to display the other tabs.</p> <ul style="list-style-type: none"> • When scrolling is in effect, the position of the selected tab is not static - as you click the right arrow to display the next tab in the series, the selected tab moves one position to the left. Thus, it is possible for the selected tab to scroll out of sight even though the contents of that tab (the corresponding screen) remains visible. • When scrolling is not in effect, all tabs are visible at all times.
<p>General links (not pictured above)</p> 	<p>About - Shows the version number, build number, date, time, and status of Merchant Desktop.</p> <p>Help - Opens a browser window that displays the online help system.</p> <p>Logout - Ends your Merchant Desktop session and displays the login screen.</p>

Price Schedule

Typically, you can log on to Price at any time. However, there are a few very short periods (generally about five minutes) when the administrator (at your company or Oracle Retail Professional Services) will disable logins so that they can collect approved markdowns and generate the new prices for your pricing system.

In general, there are two periods in the Price schedule:

- **Decision period.** The decision period is typically Monday and Tuesday. During the decision period, you can use all of the Price features to which you have access. The most important tasks during the decision period are taking markdowns and submitting, approving, or declining worksheets (depending on your access level).

The decision period is in effect until the date and time designated by the cutoff date. The cutoff date appears on all Price screens, as in the following example:

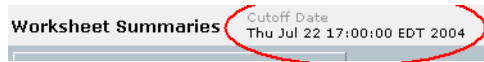

- **“Read-only” period.** The “read-only” period is typically Wednesday through Sunday, and it begins at the time designated by the cutoff date. During this period, the markdowns you submitted are imported into your company’s pricing system, and Price gathers sales and other data in order to produce recommendations and forecasts that will be ready for you on Monday (or the day designated for your decision period).

The intent is that no markdowns are submitted during the read-only period, but this is not explicitly enforced because there are occasions when certain items require accelerated markdowns. Thus, if necessary, you can submit markdowns during this time as explained in “Taking Accelerated Markdowns” on page 119. Otherwise, you can perform Price tasks such as the following:

- “Viewing Forecasts for One or More Worksheets”, explained on page 124
- “Asking What If”, explained on page 86
- “Changing Your Password”, explained on page 24

Note: Check with the administrator to determine the exact Price schedule for your company.

Quick Reference to Common Price Tasks

The following table lists the key tasks that you will perform using Price.

To perform most of these tasks, you must first log in and select **Markdowns** from the Main Menu. You can initiate most of the following tasks from the Worksheet Summaries screen that appears.

Key task	Steps	Purpose
<p>Reviewing Markdown Suggestions</p> <p>For details, see page 78.</p>	<p>Select a worksheet by clicking its link in the Key column (or the equivalent column that contains links to worksheets).</p>	<p>Each week, Price analyzes your most recent sales and inventory data to calculate markdown recommendations. The goal of the recommendation for each item is to maximize gross margin and sell through.</p>
<p>Viewing Forecasts for One or More Worksheets</p> <p>For details, see page 124.</p>	<p>Select the worksheet(s) to include by clicking the corresponding check box.</p> <p>From the Action list box, select Show Recommended Forecast and click Apply.</p>	<p>Before you change a markdown price for an item, it's a good idea to view its forecast.</p>
<p>Asking What If</p> <p>For details, see page 86.</p>	<p>Select a worksheet by clicking its link in the Key column.</p> <p>On the Items Worksheet, select the item(s) you want to analyze, then select What If from the Action list box and click Apply.</p> <p>On the What If screen, select the Price Ladder and the Override Price.</p> <p>Click Recalculate to see the way these price changes impact the forecasted sales, inventory, and gross margin.</p>	<p>After reviewing an item's forecast, you might decide that you would like to see how changes to the markdown schedule would alter its forecast.</p>

Key task	Steps	Purpose
<p>Applying the Optimize-to-Budget Feature</p> <p>For details, see page 108.</p>	<p>Select the worksheet that includes the items you want to mark down by clicking its link in the Key column.</p> <p>On the Items Worksheet, select the item(s) to which you want to apply the budget, and from the Action list, select Optimize to Budget and click Apply.</p>	<p>If you are not sure how to apply your markdown dollars, use the Price optimize-to-budget feature. The optimize-to-budget feature assesses items with pending markdowns and applies the markdown budget dollars to items that can yield higher gross margin and sell through.</p>
<p>Taking Recommended Markdowns</p> <p>For details, see page 115.</p>	<p>Select the worksheet that includes the items you want to mark down by clicking its link in the Key column.</p> <p>On the Items Worksheet, select the item(s) for which you want to take markdowns, and then select Take Markdown or Take Markdown Adv from the Action list box and click Apply.</p> <p>Click Save to save your changes and update the Summary Metrics at the bottom of the worksheet.</p>	<p>Once you decide which items you would like to mark down, you are ready to take your markdowns and save them.</p>
<p>Submitting Worksheets for Approval</p> <p>For details, see page 134.</p>	<p>Once you have taken markdowns (see steps above), click Submit.</p>	<p>Your markdown decisions are not submitted for approval unless you take this step.</p>
<p>Approving Worksheets</p> <p>For details, see page 135.</p>	<p>Once a worksheet has been submitted, from the Worksheet Summaries screen click the check box for each worksheet to be approved.</p> <p>Select Approve from the Action list box and click Apply.</p>	<p>You must have approval access rights to complete this task.</p>

Chapter 1
Getting Started

Key task	Steps	Purpose
<p>Managing Worksheets</p> <p>For details, see page 155.</p>	<p>From the Action list box on the Worksheet Summaries screen or on a worksheet, select Sort Table, Filter Table, or Modify Columns.</p> <p>Note: The Filter Table action is not available on the Worksheet Summaries screen, and it may not be available on all tabs on the worksheets.</p>	<p>Worksheets are the starting point for your markdown analysis. You can set up your worksheets to display the data in whatever way you prefer.</p>
<p>Exporting Data or Printing Data</p> <p>For details, see page 169.</p>	<p>Select the worksheet you want to export by clicking its link in the Key column.</p> <p>On the Items Worksheet, select the item(s) you want to export, select Print or Export from the Action list box, and click Apply.</p>	<p>At any point in the markdown process, you can export a worksheet to Microsoft Excel.</p> <p>Note: Microsoft Excel 2000 or newer is required to use the Price export feature.</p>
<p>Managing Business Rules</p>	<p>From the Main Menu, click Business Rule Property Manager.</p>	<p>Business rules are your company guidelines that Price uses when making pricing and markdown decisions. You may want to access business rules to determine why or why not Price made a markdown recommendation. In addition, you may want to change a business rule setting.</p> <p>Note: You can access Business Rule Manager only if your user account has been assigned the rights to do so.</p>
<p>Reviewing Reports</p> <p>For details, see page 173.</p>	<p>From the Main Menu, click Reports.</p> <p>If you are using the Merchant Desktop feature, click the Reporting tab to access enhanced reporting.</p>	<p>Price provides you with reports that display your data with a variety of metrics that can help you to make business decisions.</p>

This chapter includes the following information:

- “About Merchant Desktop” on page 41
- “About Personalization” on page 42
- “Personalizing Your View” on page 43
- “Personalizing Screens” on page 46
- “Personalizing Components” on page 49
- “About Screens” on page 50
- “About Components” on page 52
- “News Feed Component Type” on page 54
- “HTTP Links Component Type” on page 56
- “HTML Component Type” on page 57
- “Alerts Component Type” on page 58
- “Oracle Retail Product Component Type” on page 63
- “Report Component Type” on page 64
- “Graph Component Type” on page 65
- “Filter Component Type” on page 67

“Filtered Report Component Type” on page 68

“Filtered Graph Component Type” on page 69

“Top/Bottom Component Type” on page 70

“Parameters Common to All Component Personalization Screens” on page 73

About Merchant Desktop

The following sections pertain to the optional Merchant Desktop feature. If your company is not using Merchant Desktop, these sections do not apply to you.

Merchant Desktop is the in-season management tool for all of your Oracle Retail products - Price, Plan, Place, and Promote. In addition to giving you seamless single-sign on to all of your Oracle Retail products, Merchant Desktop also:

Tracks against your plan data so that you can measure current performance against past, present, and forecasted performance

Monitors internal events (such as promotions) and external events (such as competitors' promotions, weather conditions, sports, etc.)

Alerts you to specific problems or opportunities with your assigned departments or key items

Provides reports and graphs that expose the data within the Oracle Retail suite in meaningful ways

When you first access your Merchant Desktop, Oracle Retail Professional Services or an administrator will have created a view and some screens for you. You can customize those screens and create new ones depending on the access rights assigned to your user account.

About Personalization

When you first log on to the Merchant Desktop, a view with one or more screens and components appears. This view is created for you by the administrator. Depending on the privileges the administrator assigned to your user account, you may be able to personalize the following:

Screen tab names and order, along with adding new screens

Component position and type

The color scheme or “skin” of the view, which affects each screen and component

Different aspects of each component, depending on the component type, such as the title bar of each component or the padding around it. For information on making these modifications, see “Parameters Common to All Component Personalization Screens” on page 73.

Personalization Privileges

Pencil buttons  denote personalization. When you click a pencil button, the corresponding personalization screen appears.

If no pencil buttons appear, you have a standard user account, and the administrator has denied all personalizing. In this case, you will find that the view, screens, and/or components are updated with a new look or new information each time the administrator makes updates.

If the pencil button appears, possibly in some places but not others, you have a power user account, and the administrator has allowed you to personalize only some elements.

Before you make any personalization changes, understand that once you do so, you will no longer be able to receive updates to the view or screen from the administrator. It is possible, however, for the administrator to remove the view or one or more screens.

If some parameters are missing when you compare a personalization screen to the help, the administrator has prohibited the missing parameters from being changed. You can change any of the available parameters.

As explained in “Parameters Common to All Component Personalization Screens” on page 73, you can always opt to switch to the default (administrator) setting by selecting the Use Default check boxes.

Personalizing Your View

You must have a power user account to make any changes. If no pencil buttons are available when you log on to Merchant Desktop, you most likely have a standard user account.

Your view is the row of tabs that appear underneath the Oracle banner.



As long as the administrator has given you privileges to do so, you can personalize your view as follows:

- Add one or more screens

- Remove one or more screens

- Reorder the screens

- Set the home screen (the one that is selected when you first log on)

- Change the skin (color scheme)

To personalize your view:

At the right end of the row of screen tabs, click the pencil button .

If the pencil button  is not available, the administrator has prohibited changes to the view. Otherwise, the View Personalization screen appears.

Complete the View Personalization screen as follows:

Notes:

If one of the parameters listed below is missing from the screen, the administrator has prohibited that parameter from being changed.

If the parameter appears but is grayed out and you can't edit it, clear the Use Default check box. That will allow you to change the parameter, but it will not allow you to receive updates from the administrator for that parameter.

To	Do this
Add a screen	In the Available Screens list, click the screen name and then click the Add button. The screen name moves to the Screens In View list.
Remove a screen	In the Screens In View list, click the screen name and then click the Remove button. The screen name is removed from the list.
Reorder the screens	In the Screens In View list, click a screen name and then click the Top, Up, Down, or Bottom buttons to move the screen name to its target position.
Change the skin	<p>Change skins when you want to adjust the dominant color scheme of your view, screens, and components.</p> <p>You can select skins from those provided by the administrator.</p> <p>From the Skin list box, select the name of a skin. Each skin name includes the predominant color.</p> <p>The color scheme of the skin you selected is applied to all of the screen tabs and all of the component title bars.</p>
Set the home screen	<p>From the Home Screen list box, select the name of the screen that you want to have the focus when you first log on. Setting the default home screen is different from setting screen order.</p> <p>Screen order determines the order of the tabs from left to right.</p> <p>Home screen determines which of those tabs is in the foreground when you log on.</p> <p>For example, you could set the first (left most) screen to be the home screen, or you could set the third screen to be the home screen.</p>

When the View Personalization screen reflects the changes you want, click the **Save** button.

The updates are effective immediately.

Personalizing Screens

You must have a power user account to make any changes. If no pencil buttons are available when you log on to Merchant Desktop, you most likely have a standard user account.

You can personalize screens to the extent permitted by the administrator. Following is a list of the changes you can make:

Screen name - The text that appears on each screen tab and the corresponding personalization screen. Rename a screen when you want different text to appear on the screen tab.

Screen layout - The order and position of the components

Components - The number and type of components that appear on the screen

To personalize a screen:

Click the tab of the screen you want to personalize.

The screen appears, and a pencil button  appears next to the name of the screen, as in this example:

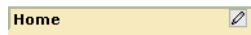

Click the pencil button .

The Screen Personalization screen appears.

Complete the Screen Personalization screen as follows.

Notes:

If one of the parameters listed below is missing from the screen, the administrator has prohibited that parameter from being changed.

If the parameter appears but is grayed out and you can't edit it, clear the Use Default check box. That will allow you to change the parameter, but it will not allow you to receive updates from the administrator for that parameter.

To	Do this
Change the screen name	<p>Enter new text in the Display Name text box.</p> <p>The text on the screen tab as well as the title bar of the personalization screen update with this text.</p>
Change the position of components	<p>You can change the order and position of components within the confines of the assigned screen layout type. For example, if the screen is assigned a two-column layout, you cannot change that to a three-column layout.</p> <p>If you need a different layout, such as more columns or a different arrangements of rows and columns, request that from the administrator.</p> <p>Finally, if the layout is a 1-, 2-, or 3-column open layout, you can add as many components as necessary, limited only by the memory available to your browser.</p> <p>In the layout, click the name of the component you want to move and drag it to the target location.</p> <p>When you click the name of a component, it is highlighted in green indicating that you can “go” or “drag” the component to a cell in the layout</p> <p>As you drag the component across the layout, a red outline indicates where you can “stop” or “drop” that component.</p> <p>A displaced component moves to the open spot left by the moved component</p>

To	Do this
Change the number of components	<p>Note: You can add unlimited components only to the one-column, two-column, and three-column layouts. For the other layouts, the maximum number of components is from one to six. You can leave a layout cell blank.</p> <p>To remove a component, click the X in the upper-right corner of that component's cell</p> <p>To add a component, click it in the list box on the left and drag it to its target location</p> <p>You can add multiple copies of a component to one screen <i>except for the Alerts component</i>. You can add only one copy of the Alerts component per screen.</p>
Change the type of components	<p>Note: Some screens have components added to them by default. For example, the Filter Component Type is always on the Performance screen, and you cannot remove it.</p> <p>Select the new component type from the list box and drag it to its target location.</p>
Edit the component	<p>Click the pencil button  and complete the resulting component screen.</p> <p>To save the change to the component, you must click Save both on the component screen and on the Screen personalization screen.</p>

Click the **Save** button.

The changes you made are effective immediately.

Personalizing Components

You must have a power user account to make any changes. If no pencil buttons are available when you log on to Merchant Desktop, you most likely have a standard user account.

You can personalize components to the extent permitted by the administrator. In addition, the features you can personalize depend on the component type. In general, you can change the following:

Rename the title that appears in the title bar, or simply hide it

Adjust the spacing between components

Change the content of a component

Change the look or behavior of the content

To personalize a component:

On the component you want to personalize, click the pencil button .

A screen that corresponds to the component type appears. This screen is titled the same as the component.

Complete the screen. The parameters differ depending on the component type:

For information on parameters common to all components, see “Parameters Common to All Component Personalization Screens” on page 73

For information on the parameters unique to each component, click the help button  in the upper-right of the screen. Each corresponding help topic explains the parameters on that screen.

When the screen reflects your choices, click the **Save** button.

The changes take effect immediately.

About Screens

Screens are the containers for components (each within its own window). Essentially, screens provide layout while component windows provide content. On the Merchant Desktop, screens are identified by the row of tabs that appear near the top of the screen. Each screen consists of the following:

A type (Standard, Performance, Top/Bottom, or Reporting)

A layout (such as one column, two column, etc.)

One or more components

Screen Types

Screen type	Description
Standard	The Standard screen is the most flexible of all of the screen types, and it allows you to add all of the component types.
Top/Bottom	The Top/Bottom screen type provides a quick and easy way for you to access the top or bottom <i>n</i> percent of a variety of metrics. For example, you could select to view the bottom 20% of styles (from the merchandise hierarchy) by GM % across sales to date (STD) for Department <i>N</i> . The result is a “Top/Bottom” report of your selected metrics.
Reporting	The Reporting screen provides access to reports and graphs that have been supplied with Oracle Retail Price, Plan, Place, or Promote products, or any reports that an administrator has created at your site. For details, see “About Enhanced Reporting” on page 182.

Screen type	Description
Performance	<p>The Performance screen is a special screen type that consists of the following component types:</p> <p>“Filter Component Type”, explained on page 67 - Provides the merchandise, location, and time hierarchies by which you can dynamically update special reports and graphs.</p> <p>“Filtered Report Component Type”, explained on page 68 - Displays the special reports that interact with the merchandise, location, and time hierarchies provided by the Filter component.</p> <p>“Filtered Graph Component Type” on page 69 - Displays the special graphs that interact with the merchandise, location, and time hierarchies provided by the Filter component.</p> <p>The key difference between the Performance screen type and the Standard screen type is that from the Performance screen, you can select merchandise and location hierarchy levels across time. As you make these selections, the reports and/or graphs on the Performance screen update dynamically.</p>

About Components

Components are boxes of content that are placed in a screen. Components are similar to the windows you are familiar with in the Windows operating system - you can resize them, minimize them, maximize them, change their position, and close them.

Each component belongs to a parent (or owner) screen. Thus, you can access and view that component only from that parent screen. Because of this ownership, the Merchant Desktop system administrator may or may not allow you to customize each component.

The same component can appear multiple times on one screen, and it can appear on multiple screens.

On the Merchant Desktop, components are identified by borders and controls such as a pencil button  and an X in the upper-right corner. Component windows consist of the following:

Properties that are common to all components, such as:

A type, which determines the content and properties you can set

A title bar description

A size and position in its parent (owner) screen

A skin (color scheme) inherited from its parent (owner) screen

Properties that are unique to each component, such as scrolling patterns for the news feed component or specific URLs for the HTTP links component

Component Types

Each component type determines the content you can add as well as the properties you can set. Merchant Desktop provides the following component types:

“News Feed Component Type” on page 54

“HTTP Links Component Type” on page 56

“HTML Component Type” on page 57

“Alerts Component Type” on page 58

“Oracle Retail Product Component Type” on page 63

“Report Component Type” on page 64

“Graph Component Type” on page 65

“Filter Component Type” on page 67

“Filtered Report Component Type” on page 68

“Filtered Graph Component Type” on page 69

News Feed Component Type

Retail News

- **Stores of the Future**
Have consumers have begun defecting from the culture of shopping? The New York Times reports that some say, "yes," pointing to micro assortments of well-chosen goods as the answer. Free registration required....

The news component is designed to display retail and other news headlines as RSS (*Rich Site Summary* or *Really Simple Syndication*) feeds.



To pause the scrolling or fading, simply place the mouse pointer on the text. When you move the pointer, the text begins scrolling or fading again.

When you click any of the listed story titles, a new browser window opens with the text of the story.

If this message appears	Do this
Error parsing RSS NEWS FEED. Bad XML File.	Wait until the host site updates its XML file. The XML file contains the contents of the news feed.
Error in RSS News Feed.	Wait until the host site updates its XML file. The XML file contains the contents of the news feed.
Too much data to download.	Decrease the number of links displayed and/or hide the summaries/first sentences. (Click the pencil button and complete the resulting News Feed Component screen.) This message appears when the XML contains greater than 10,000 characters for display.

Note: This section describes the function of the News Feed component, not its contents. If you are unsure about the contents, see the administrator.

Otherwise, to change the appearance or contents of this News Feed component,

click the pencil button  in the title bar and click the help button  for information on each parameter. If the pencil button is not present in the title bar, the administrator has prohibited this component from being changed.

HTTP Links Component Type



The HTTP Links component displays links to any web site. For example, you may want to display links to competitors' web sites, or you may want to display links to sites that you access often throughout the day.



When you click a link, a new browser window opens. To return to Merchant Desktop, do any of the following:

Close the browser window that just opened.

Click Oracle Retail Merchant Desktop in the task bar.

Press Alt+Tab until the Internet Explorer Merchant Desktop icon is selected.

Note: This section describes the function of the HTTP Links component, not its contents. If you are unsure about the contents, see the administrator.

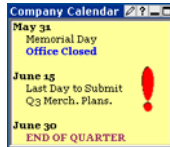

Otherwise, to change the appearance or contents of this HTTP Links component, click the pencil button  in the title bar and click the help button  for information on each parameter. If the pencil button is not present in the title bar, the administrator has prohibited this component from being changed.

HTML Component Type









The HTML component displays information that originates in HTML format. It is intended for displaying corporate calendars, promotional event dates, company intranets, etc.

Note: This section describes the function of the HTML component, not its contents. If you are unsure about the contents, see the administrator.

Otherwise, to change the appearance or contents of this HTML component, click the pencil button  in the title bar and click the help button  for information on each parameter. If the pencil button is not present in the title bar, the administrator has prohibited this component from being changed.

Alerts Component Type

Level	Description	Benefit	Recommendation	View Details
	Buy More	\$73,617,930.00	3,303,130	WOMENS DENIM/ACME
	Buy More	\$11,547,740.00	412,170	WOMENS PANTS/ACME
	Buy More	\$7,881,620.00	454,140	WOMENS FALL KNIT TOPS/ACME
	Buy More	\$6,002,620.00	243,910	WOMENS BOTTOMS/ACME
	Buy More	\$5,552,220.00	334,410	WOMENS FOOTWEAR/ACME
	Buy More	\$5,422,730.00	253,550	MENS FALL KNIT SHIRTS/ACME

The Alerts component provides notifications for merchandise that meets pre-defined criteria for pre-defined events.

Alerts signal you of events such as:

An opportunity to make more money because a particular item is selling very well. You can think of this as a “buy more” type of alert.



A possibility of losing money if orders are not canceled because an item is not selling well. You can think of this as a “cancel orders” type of alert.

The administrator determines which alerts are available as well as the alert triggers and priorities.

Most alerts are actionable; that is, you can click the hierarchy level link in the View Details column to display the affected merchandise. For more information, see “Taking Action on Alerts” on page 61.

Alerts appear only for the portions of the merchandise and location hierarchies to which you have been assigned access. You can limit the list to only those in which you are interested in the following ways:

Use the Hide check box as explained in the table on the previous page.

If the administrator has allowed you to personalize the Alerts component, click the pencil button  (available only if you have personalization rights) and click the help button  for information on each parameter.

All alerts are cleared and populated weekly, typically in conjunction with each Price optimization.

Note: If you have privileges to personalize screens, you can have only one Alerts component per screen.

The following table explains each element of the Alerts component.

Element	Description
Level column	<p>Displays one of the following icons:</p> <ul style="list-style-type: none"> ● - Denotes a high priority alert ◐ - Denotes a medium priority alert ◑ - Denotes a low priority alert <p>The priorities are based on the amount of benefit to be derived by acting on the alert. The benefit dollar value is displayed in the Benefit column.</p> <p>An administrator determines what constitutes a high, medium, and low priority alert by setting a range of dollars for each alert configuration. For example, if an administrator sets a range of \$10,000 to \$50,000, the values are used to set the priorities follows:</p> <p>\$0 to \$9,999 is a low priority</p> <p>\$10,000 to \$50,000 is a medium priority</p> <p>\$50,001 and higher is a high priority</p>
Description column	<p>Displays the name of the alert configuration, which is named by an administrator. Each alert configuration contains values that set benefit priority levels and values that trigger the alert. The values that trigger the alert are unique for each alert, and they are displayed on the Items which satisfy the selected alert screen.</p>
Benefit column	<p>Displays the total amount, in dollars (no cents) that you can make or lose on the affected items. The dollar value is rounded to the nearest ten.</p> <p>Note: This dollar amount is an <i>approximation</i>, not an exact value.</p>
Recommendation column	<p>Displays the total number of units that you must cancel orders for or buy more of for the affected items. The units are rounded to the nearest ten.</p> <p>Note: The number of units is an <i>approximation</i>, not an exact value.</p>

Element	Description
View Details column	<p>Displays the hierarchy levels for which the alert was generated.</p> <p>The hierarchy levels are the same levels at which Price worksheets are set.</p> <p>Each hierarchy level is a link that you can click to display a details screen that explicitly lists each item concerned in the alert.</p> <p>For details on this screen, see “Items which satisfy the selected alert screen” on page 171.</p>
Hide column	<p>Displays a check box that lets you temporarily hide alerts from the screen. Use this check box for alerts that you are not interested in and for alerts whose item worksheets you have already updated to rectify the issue raised by the alert.</p> <p>To hide an alert, click the check box and then click the Show Open link.</p> <p>To later view any alerts that you have hidden, click the Show Hidden link. (Alternatively, you could click the Show All link, which would display both hidden and open alerts.)</p> <p>To remove (instead of hiding) one or more alerts from the screen, click the pencil button (if available) and complete the Alerts Component screen. If the pencil button is unavailable, an administrator has prohibited the Alerts Component from being personalized.</p>
Show All link	Click this link to display all Alerts, even those you previously marked to hide (via the check box in the Hide column).
Show Hidden link	Click this link to display only alerts you previously marked to hide (via the check box in the Hide column).
Show Open link	Click this link to display only alerts that you did not previously mark to hide. This is useful especially when you hide alerts whose worksheets you have already updated to address the issues raised by the alert.

Element	Description
Top link	Click this link to display the first page of alerts. The number of rows per alerts page is determined by the Visible Rows option on the Alerts Component screen. To change this, click the pencil icon on the Alerts component title bar. If the pencil icon or the Visible Rows option is not available to you, check with the administrator to have the number of rows per page changed.
Page Up link	Click this link to display one page higher.
Page Down link	Click this link to display one page lower.
Bottom link	Click this link to display the last page of alerts.

Taking Action on Alerts

Most alerts provide a link to the affected merchandise. From there, you can go directly to the relevant Oracle Retail product to make any necessary changes.

To take action on an alert:

For the alert you want to take action on, navigate to the View Details column and click the merchandise hierarchy link.

The Items which satisfy the selected alert screen appears. This screen lists each item from the worksheet that triggered the alert.

To view these items within the context of their worksheet, click the **View Worksheet** button.

The corresponding Price worksheet appears. Items that triggered the “cancel orders” (“underperforming item”) alert appear on the worksheet. Items that triggered the “buy more” alert do not appear on the worksheet. To add these items, see “Editing Worksheets” on page 81.

If possible, make necessary changes on the worksheet. In most cases, however, since you will likely be canceling orders or buying more of an item, you will probably note the item name and number and forward that to the person responsible for managing orders.

When you are finished viewing the alerted items within the context of their worksheet, click the **Close** link.

The worksheet closes

On the Items which satisfy the selected alert, click the **Done** button.

On the Alerts component, select the Hide check box as an indication that you have reviewed or taken action on that alert.

Oracle Retail Product Component Type



The product component provides links to Oracle Retail products such as Price, Plan, Place, and Promote.



Access to Oracle Retail products is seamless - when you log on to the Merchant Desktop, your username and password are automatically verified against the Oracle Retail products at your site. Therefore, just click the Oracle Retail product link and the Main menu screen appears.

Note that Price appears in a separate browser window.

To return to Merchant Desktop without quitting Price, click the **Merchant Desktop** icon in the task bar.

To quit Price, click the **Close** link in the upper-right corner of the Price user interface.

Note: This section describes the function of the Oracle Retail Product component, not its contents. If you are unsure about the contents, see the administrator.

Otherwise, to change the appearance or contents of this Oracle Retail product component, click the pencil button  in the title bar and click the help button  for information on each parameter. If the pencil button is not present in the title bar, the administrator has prohibited this component from being changed.



Report Component Type



The Report component provides you with a single report specific to your company's data and Oracle Retail products.

While the Reporting screen (see “Screen Types” on page 50) provides access to all graphs and reports, you may want to set up a component for a specific report for which you have created custom filters. For that case, Merchant Desktop provides you with this Report component (as well as a “Graph Component Type” on page 65).

Note: This section describes the function of the Report component, not its contents. If you are unsure about the contents, see the administrator.

To change the appearance or contents of this Report component, click the pencil button  in the title bar and click the help button  for information on each parameter. If the pencil button is not present in the title bar, the administrator has prohibited this component from being changed.

Graph Component Type



The Graph component provides you with a single graph specific to your company’s data and Oracle Retail products.

While the Reporting screen (see “Screen Types” on page 50) provides access to all graphs and reports, you may want to set up a component for a specific graph that you have customized. For that case, Merchant Desktop provides you with this Graph component (as well as a “Report Component Type” on page 64).

Pie Charts

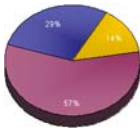

Merchant Desktop comes with the following pre-defined pie charts:

Markdown sequence - Breakdown of current markdown recommendations by first markdown, second markdown, third markdown, fourth markdown, etc.

Sales by type - Shows the breakdown of sales for full-price, POS, clearance, or other types, summed across locations, and time periods.

Sales-to-inventory comparison - Compares sales over a specified period to your current inventory.

Bar Charts

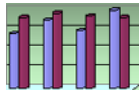

Merchant Desktop comes with the following pre-defined bar charts:

Performance versus plan - Compares actual and/or forecasted performance to plan.

Onhand inventory at outdate - Displays a time series of inventory projected to exist at its outdate.



Gross margin by merchandise - Displays gross margin metrics for specified areas of the merchandise hierarchy.

Markdown budget breakdown - Compares the markdown budget to the taken (actual) and yet-to-be-taken (forecasted) markdown dollars.

Sales and inventory time series - Displays sales against inventory over a specified period of time.

This week / last week - Compares selected metrics for the current week and one week back, by merchandise or by department.

Note: This section describes the function of the Graph component, not its contents. If you are unsure about the contents, see the administrator.

To change the appearance or contents of this Graph component, click the pencil button  in the title bar and click the help button  for information on each parameter. If the pencil button is not present in the title bar, the administrator has prohibited this component from being changed.

Filter Component Type

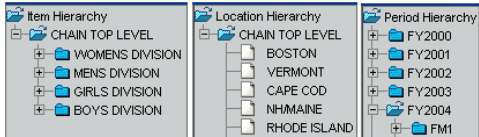



The Filter component is a special component that is designed to provide merchandise, store, and time filters for the Filtered Report component type and the Filtered Graph component type.

The Filter component is not meant to be used alone. Instead, when it is placed on a screen with the Filtered Report component type and the Filtered Graph component type, it dynamically updates those reports and graphs based on your merchandise (item), location, and period (time) hierarchy selections.

The Filter component is designed to be added to the Performance screen type.

Note: This section describes the function of the Filter component, not its contents. If you are unsure about the contents, see the administrator.

To change the appearance or contents of this Filter component, click the pencil button  in the title bar and click the help button  for information on each parameter. If the pencil button is not present in the title bar, the administrator has prohibited this component from being changed.

Filtered Report Component Type

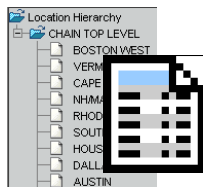



The Filtered Report component is a special component designed to work with the “Filter Component Type” on page 67. The Filtered Report component updates dynamically based on the merchandise, location, and period hierarchies on the Filter component.

If you want a stand-alone single report without dynamic merchandise, location, and period filtering, use the “Report Component Type” on page 64.

Typically, you would use the Filtered Report component on the Performance screen type.

Note: This section describes the function of the Filtered Report component, not its contents. If you are unsure about the contents, see the administrator.

To change the appearance or contents of this Filtered Report component, click the pencil button  in the title bar and click the help button  for information on each parameter. If the pencil button is not present in the title bar, the administrator has prohibited this component from being changed.

Filtered Graph Component Type

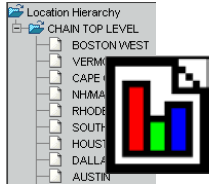



The Filtered Graph component is a special component designed to work with the “Filter Component Type” on page 67. The Filtered Graph component can update dynamically based on the merchandise, location, and period hierarchies on the Filter component.

If you want a stand-alone single graph without dynamic merchandise, location, and period filtering, use the “Graph Component Type” on page 65.

Typically, you would use the Filtered Graph component on the Performance screen type.

Note: This section describes the function of the Filtered Graph component, not its contents. If you are unsure about the contents, see the administrator.

To change the appearance or contents of this Filtered Graph component, click the pencil button  in the title bar and click the help button  for information on each parameter. If the pencil button is not present in the title bar, the administrator has prohibited this component from being changed.

Top/Bottom Component Type

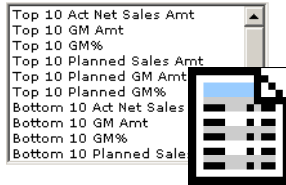

The Top/Bottom component provides you with the filters necessary to dynamically create a Top/Bottom report (see “Screen Types” on page 50) that shows you the top/bottom 10 or 20 items in your area of interest.

To create a Top/Bottom report:

Select a filter for each of the Numbered Prompts.

If you can't scroll down to all of the prompts, either use the wheel on your mouse, or use the horizontal scroll bar to scroll right so that the MicroStrategy scroll bar appears.

Click the **Execute Report** button

The resulting report appears in the same window.

When you are finished reviewing the report, click the Top/Bottom tab again to create a new Top/Bottom report, or click any other screen tab.

The Top/Bottom reports are meant to be generated dynamically on an as-needed basis, so you cannot save these reports to your personal report folder.

Numbered Prompts

Before answering the prompts, have a general idea of the merchandise you want to view and at what level. For example, you might want to view the top 10 GM-producing classes of items by department.

Merchandise Level and Filter - Select the level(s) by which you want to view and filter the report.

For example, if you are interested in the Mens Division and the Womens Division, expand the hierarchy in the left list box. Select each division and click the right arrow to move the selection(s) to the right list box.

You make more than one selection at a time by pressing the Ctrl key as you click

each item.

If you select items from different levels of the hierarchy (e.g., you make some selections from a Class level and some from a Category level), options appear asking if you want to match All Selections or Any Selections.

Grouping Level of Merchandise - Select the level by which you want your report to be organized. The level you select is reflected in the first column of the report.

Building on the previous example, you may want to view the rankings of the divisions by department. In this case, you would select Department.

Ranking Filter - Select the type of Top/Bottom report, i.e., the top 10/20 or bottom 10/20 of sales or gross margin (by amount or percent, and for planned or actual). The following columns appear in all Top/Bottom reports:

- Act Sales Amt Net
- Act GM Amt
- Act GM%
- Planned GM Amt
- Planned GM%

Note: The report is not ordered by the ranking you set. Also note that the ranking you selected does not appear on the report.

Time filter - Select the period for which you want to view data. The time filter does not appear on the report:

Filter	Description
YTD	Year to date
Actual STD	Actual season to date
Forecast STD	Forecast season to date
BOS	Beginning of season
EOS	End of season
BOQ	Beginning of quarter
EOQ	End of quarter

Filter	Description
QTD	Quarter to date
BOM	Beginning of month
EOM	End of month
MTD	Month to date
Current Week	Provides forecast data
Last Week	Provides actual data

Note: If you compare actuals from the Top/Bottom report to actuals on the Price worksheets, you may find that they do not always match. Depending on the actuals that your company is submitting, it may be that more actuals are being submitted than for the items defined in Price. The Top/Bottom report uses the submitted actuals.

You cannot change the appearance or contents of the Top/Bottom component. If you need additional filters, see the administrator.

Note: This section describes the function of the Top/Bottom component, not its contents. If you are unsure about the contents, see the administrator.

Parameters Common to All Component Personalization Screens

All components provide the following parameters, which affect the title bar, component window padding and height, and whether or not you want to use administrator default settings.

Note: If any of the parameters listed below are missing from the screen, the administrator has prohibited that parameter from being edited.

Display Name: Type the text that you want to appear in the title bar of the component window, up to 50 characters.

Description: Type any notes or information that you want to remember about this component. This information appears only on the user personalization screens - it does not appear on the component window itself. The maximum number of characters allowed is 255.

Padding Width: This option determines the amount of padding (spacing) around each component, and thus, in combination with the other components, the amount of spacing between components.

Select one of the options described in the following table. An example of the Thin and Thick options appears after the table.

Option	Description
Thin	Approximately 5 pixels around each component window, resulting in approximately 10 pixels between components.
Medium	Approximately 10 pixels around each component window, resulting in approximately 20 pixels between components.
Thick	Approximately 20 pixels around each component window, resulting in approximately 40 pixels between components.

Chapter 2 Personalizing Merchant Desktop







Thin

Thick

Height: Height applies only to component windows in the 1-, 2-, and 3-column layouts. If the component window is in a fixed layout (such a Layout 1, Layout 1 Inverted, etc.), the height of the component window is set in the screen layout and you cannot change it. You can set the height in pixels or percent, as follows:

Pixels - In general, a pixel is one tiny square of an image on your monitor, and the exact size of the pixel depends on the resolution of your monitor. Because of this, you may need to experiment with the number of pixels you enter. Enter pixels in whole numbers.

Percent - Type the percentage of the screen that you want the component window to use. Enter the percents in whole numbers.

Title Bar: The title bar is the top row of the component window, which displays the pencil , help , minimize , maximize , and, when applicable, restore  buttons.

Select **Show** to display the title bar.

Select **Hide** to show only the border of the component window with no title bar. If you later want to Show the title bar, follow this procedure:

To show a hidden title bar:

For the screen that contains the component with the hidden title bar, click the screen tab and corresponding pencil button

On the Screen Personalization screen in the graphic of the screen layout, click the

pencil button of the component whose title bar you want to show.

On the component personalization screen, select the **Show** option and click the **Save** button.

On the Screen Personalization screen, make any other changes necessary and then click the **Save** button.

The screen appears, and the title bar is back on the component window.

Use Default: This check box determines whether or not you want to use the entry set by the administrator:

If you want your changes to be in effect, regardless of any changes the administrator makes to this component parameter, clear the Use Default check box. When you select the Use Default check box, the parameter is disabled. To enable it for editing, you must clear the Use Default check box.

For example, if you add your favorite retail web site to an HTTP links component and the administrator adds a new one, the component will not display the new site until you clear the Use Default check box.

To determine what the administrator's default value is before you clear the Use Default check box, hover (place the mouse pointer over) the parameter. The hover text that appears displays the administrator's default value.

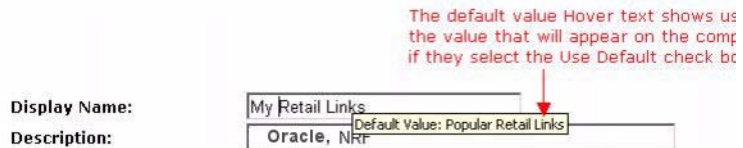

If you want the component to display all of the changes the administrator makes to this particular parameter, select the Use Default check box.

In this case the parameter would be automatically updated for you each time the administrator made a change.

Chapter 2
Personalizing Merchant Desktop

3

Managing Markdowns

This chapter includes the following information:

- “Making Markdown Decisions” on page 78
- “Opening Worksheets” on page 79
- “Editing Worksheets” on page 81
- “Worksheet Summaries screen” on page 83
- “Asking What If” on page 86
- “The What-If Screen” on page 87
- “Creating What-If Scenarios” on page 99
- “Applying the Optimize-to-Budget Feature” on page 108
- “Selecting Markdown Prices” on page 114
- “Viewing Forecasts for One or More Worksheets” on page 124
- “Recommended Forecast screen” on page 125
- “Viewing Item Details” on page 127
- “Worksheet screen” on page 130
- “Approving Decisions” on page 134

Making Markdown Decisions

To make markdown decisions, start with the Worksheet screen. The Worksheet screen is the hub of your pricing activities. From the Worksheet screen, you can:

- Consider markdown decisions by evaluating recommendations. Specifically, the worksheet provides valuable features for helping you to make your markdown decisions – “Asking What If” on page 86 (the What-If feature) and “Applying the Optimize-to-Budget Feature” on page 108 (replaces the fit-to-budget feature).
- Act on your decisions by taking, or not taking, markdowns. For details, see “Selecting Markdown Prices” on page 114.

Reviewing Markdown Suggestions

When you review markdown suggestions, keep the following in mind:

- **Lifecycle** – The goal is to maximize gross margin over the full lifecycle through both full price and price-break sales.
- **Exit date and Exit inventory** – The number of weeks prior to the exit date affects the depth and timing of markdown recommendations. Price recommends markdowns to stimulate sales to achieve the desired inventory at the exit date. If an exit inventory value is not set, Price assumes that the exit inventory target is zero.
- **Up-to-the-minute information** – Because you are closest to your business, you may have more recent information that could affect markdown recommendations. The final decision to implement or delay a markdown lies with you.
- **Opportunity cost** – Keep in mind the gross margin that is lost by not taking a recommended markdown. This cost is the most immediate indicator of the effect of not taking a markdown recommendation at the optimal time and depth. The greater the opportunity cost, the greater the risk that not taking the markdown recommendation presents.

Opening Worksheets

Worksheets are the starting point for your markdown analysis; they display items and pricing groups with associated pricing information. From each worksheet, you can do the following.

- Change markdown prices
- Take (or not take) markdowns
- Select items for forecasting, What-If analysis, and optimize-to-budget
- View item properties

You can access only those worksheets that are assigned to you by an administrator.

To open your worksheets:

1. From the Main Menu, click **Markdowns**.

The Worksheet Summaries screen appears, as in the following example. (Your Worksheet Summaries screen may appear with columns that are named differently.) For details, see “Worksheet Summaries screen” on page 83.

Worksheet Summaries		Cutoff Date		Thu Dec 18 17:00:00 EST 2003		Done				
Action										
(select action)							Apply			
<input type="checkbox"/>	Division	Key	Status	# Mod	# Accepted	On Hand	On Order	# Recs	Oppty. Cost	Lost Oppty. Cost
<input type="checkbox"/>	1			15	15	25846804	5750083	318	328503	326412
<input type="checkbox"/>		311	Not Submitted	0	0	1840199	509964	15	17101	17101
<input type="checkbox"/>		312	Not Submitted	12	12	278775	175015	0	0	0
<input type="checkbox"/>		313	Not Submitted	0	0	200000	95643	0	0	0
<input type="checkbox"/>		314	Not Submitted	0	0	329150	59734	1	2418	2418
<input type="checkbox"/>		315	Not Submitted	0	0	316367	110832	0	0	0
<input type="checkbox"/>		316	Not Submitted	3	3	455369	44127	12	7079	4988
<input type="checkbox"/>		320	Not Submitted	0	0	451244	53643	0	0	0
<input type="checkbox"/>		321	Not Submitted	0	0	81914	91857	0	0	0
<input type="checkbox"/>		322	Not Submitted	0	0	122	166331	0	0	0
<input type="checkbox"/>		323	Not Submitted	0	0	2061516	315236	17	14598	14598
<input type="checkbox"/>		324	Not Submitted	0	0	764253	135549	16	14145	14145
<input type="checkbox"/>		325	Not Submitted	0	0	189679	61957	0	0	0
<input type="checkbox"/>		326	Not Submitted	0	0	485886	142863	0	0	0

2. In the Key column (or the equivalent column on your Worksheet Summaries screen that contains links to worksheets), click the link that corresponds to the worksheet you want to open.

Chapter 3
Managing Markdowns

The corresponding Worksheet screen appears, as in the following example. (Your Worksheet screen may appear with different tabs and columns.) For details, see “Worksheet screen” on page 130.

The screenshot shows the 'Worksheet' application interface. At the top, there are fields for 'Division' (1), 'Department' (32), 'Key' (323), and 'Cutoff Date' (Thu Jul 22 17:00:00 EDT 2004). There are buttons for 'Save', 'Submit', and 'Done'. Below this are tabs for 'Items By Name', 'Items (Flat)', 'Pricing Groups', and 'Items By Pricing Group'. The 'Pricing Groups' tab is active. Below the tabs is an 'Action' dropdown menu with '(select action)' and an 'Apply' button. There are also dropdowns for 'Class', 'Sub Class', 'Item', and 'Region', each with a 'Show' button. The main area is a table with the following columns: Description, item_id, Target ST% EOL, Target OH EOL, Taken MD Cost, Taken MD, Curr % Off, and RR Price TW. The table contains several rows of data, including items like '1X1 RIB CREW/FAL/2002' and 'BASIC RINGER/HOL/2002'. At the bottom, there is a status bar with fields for '# Recs', '# Taken', 'Status' (Not Submitted), 'Modified By', and 'Effective Date' (Sat, Jul 17, 2004).

Description	item_id	Target ST% EOL	Target OH EOL	Taken MD Cost	Taken MD	Curr % Off	RR Price TW
1X1 RIB CREW/FAL/2002		75.00%	68194	\$0.00	Not Taken	31.03%	\$10.00
1X1 RIB CREW/FAL/2002		75.00%	68194	\$0.00	Not Taken	31.03%	\$10.00
1X1 RIB CREW	14589065	75.00%	8141	\$0.00	Not Taken	31.03%	\$10.00
1X1 RIB CREW	14589067	75.00%	5270	\$0.00	Not Taken	31.03%	\$10.00
1X1 RIB CREW	14589071	75.00%	6648	\$0.00	Not Taken	31.03%	\$10.00
BASIC RINGER/HOL/2002	14588701	75.00%	44	\$0.00	Not Taken	0.00%	\$8.50
CHST STRP RGBY/FAL/2002		75.00%	23027	\$0.00	Not Taken	26.67%	\$16.50

From each Worksheet screen, you can complete the following tasks:

- “Asking What If”, explained on page 86
- “Applying the Optimize-to-Budget Feature”, explained on page 108
- “Selecting Markdown Prices”, explained on page 114
- “Saving Changes”, explained on page 123
- “Viewing Results of Pricing Decisions”, explained on page 123
- “Viewing Item Details”, explained on page 127
- “Executing Worksheets”, explained on page 136

Editing Worksheets

You can edit worksheets to add or remove items that are not currently recommended for a markdown. When items are in the markdown cycle, you cannot add them to or remove them from worksheets.

This procedure is especially useful when you want to view items that triggered a “buy more” alert. Because worksheets are intended to display items that have been recommended for a markdown, items that are selling well do not appear on them by default. If you want to view those items and their related metrics, you can do so by using the following procedure. For more information on alerts see “Alerts Component Type” on page 58.

To add/remove non-recommended items to/from a worksheet:

1. From a worksheet, select the data view tab for the items or pricing groups you want to work with.
2. From the Action list box, select **Edit Worksheet** and click **Apply**.

If the worksheet data view was items, the Edit Item Worksheet screen appears as in the example below (your Edit Item Worksheet screen may appear with columns that are named differently). The non-recommended items that can be added to the worksheet appear on the bottom of the screen; the non-recommended items that can be removed from the worksheet appear in the top section.

Worksheet

Remove non-recommended items from the worksheet

(select action) ▾ **Apply**
Find by Item **Search**Class ▾ Sub Class ▾ Item ▾ **Show**

<input type="checkbox"/>	Division	Department	Key	Class	Sub Class	Item	Description	Inventory	Rec. Pr.	Orig. Pr.	Curr Retl.
<input type="checkbox"/>	1	35	351	8	3	179063	HALWEEN COLLAR	1229		\$3.50	\$3.50
<input type="checkbox"/>	1	35	351	8	3	179063	HALWEEN COLLAR	2541		\$3.50	\$3.50
<input type="checkbox"/>	1	35	351	8	1	179068	GLOW BONE	12058		\$2.50	\$2.50
<input type="checkbox"/>	1	35	351	8	1	179074	RUBBER BONE	6680		\$3.50	\$3.50

Add non-recommended items to worksheet

(select action) ▾ **Apply**
Find by Item **Search**Class ▾ Sub Class ▾ Item ▾ **Show**

<input type="checkbox"/>	Division	Department	Key	Class	Sub Class	Item	Description	Inventory	Rec. Pr.	Orig. Pr.	Curr Retl.
<input type="checkbox"/>	1	35	351	8	3	179063	HALWEEN COLLAR	1229		\$3.50	\$3.50
<input type="checkbox"/>	1	35	351	8	3	179063	HALWEEN COLLAR	2541		\$3.50	\$3.50
<input type="checkbox"/>	1	35	351	8	1	179068	GLOW BONE	12058		\$2.50	\$2.50
<input type="checkbox"/>	1	35	351	8	1	179074	RUBBER BONE	6680		\$3.50	\$3.50

3. To add non-recommended items to the worksheet, use any of the following methods:

Click the check box of each item or pricing group you want to add and then from the Action list box, select **Add Items** and click **Apply**.

or

If filter list boxes are available, use them to filter by the merchandise hierarchy and click **Show**. Then, click the top left check box to select all of the items or pricing groups. From the Action list box, select **Add Items** and click **Apply**.

In both cases, the items appear in the top section of the worksheet.

4. To remove items from the worksheet, use any of the following methods. (These methods are similar to those described in step 3.)

Click the check box of each item you want to add and then from the Action list box, select **Remove Items** and click **Apply**.

or

If filter list boxes are available, use them to filter by the merchandise hierarchy and click **Show**. Then, click the top left check box to select all of the items. From the Action list box, select **Remove Items** and click **Apply**.

In both cases, the items appear in the bottom section of the worksheet.

5. When you are finished adding/removing items to/from the worksheet, click the **Worksheet** button in the upper-right corner of the screen.

All of the non-recommended items that you added appear on your original worksheet. Likewise all of the non-recommended items that you removed no longer appear on your original worksheet.

Worksheet Summaries screen

To access the Worksheet Summaries screen, click **Markdowns** from the Main Menu. The Worksheet Summaries screen displays a list of the worksheets you can access, along with a summary of each worksheet and its current status.

Use the Worksheet Summaries screen to accomplish the following tasks:

- “Opening Worksheets” on page 79
- “Viewing Forecasts for One or More Worksheets” on page 124
- “Approving Worksheets” on page 135
- “Declining Worksheets” on page 135

The typical Worksheet Summaries screen includes the following features. The column names and content are customized for each Price implementation. Therefore, if you are unsure about the meaning of a column, check with the administrator.

Feature	Description
Check boxes	Use to select one or more worksheets for which you want to view a forecast
Action list and Apply button	Use to select an action you want to perform on the selected worksheets
Done button	Use to save the changes you made and return to the Main Menu

The metrics displayed on the Worksheet Summaries screen are configured during system set up to display the information most meaningful for your business. Thus the specific metrics that appear depend on your configuration. Some common metrics and definitions include the following.

Metric	Description
# Rec MD	The total number of items recommended for markdowns this week.

Chapter 3
Managing Markdowns

Metric	Description
Rec MD \$	The total dollar amount of the recommended markdowns in the worksheet (using retail accounting).
Rec MD \$ Cost	The total dollar cost of the inventory for the recommended markdowns in the worksheet
Taken MD \$	The total dollar amount of taken markdowns in the worksheet (using retail accounting).
Taken MD \$ Cost	The total dollar cost of the inventory for the taken markdowns in the worksheet
# Added MD	The total number of markdowns that have been added in addition to those that Price recommended.
# Taken MD	The total of recommended and non-recommended markdowns taken this week. Recommended markdowns are those recommended by Price, and non-recommended markdowns are those buyers may have added on their own.
# Rec MD Taken	Of the items for which Price recommended a markdown, the number of those items for which a markdown has been taken. However, the <i>recommended</i> price might not have been taken. For example, the total number of recommended markdowns taken includes recommended markdowns taken to any price - recommended, shallower, or deeper.
# Rec MD Taken Deeper	Of the number of recommended markdowns, this is the number that were taken at a lower price than the recommended one
# Rec MD Taken Shallower	Of the number of recommended markdowns, this is the number that were taken at a higher price than the recommended one

Metric	Description
Oppy Cost	Opportunity Cost is the dollar amount you can generate in profit by taking the recommended markdowns
Lost Oppy Cost	Lost Opportunity Cost is the dollar amount lost by not taking the recommended markdowns
MD Budget	The total markdown budget for the current month, in dollars.
MD Budget Next	The total markdown budget for the following month, in dollars.
Status	<p>One of the following:</p> <ul style="list-style-type: none"> • Not Submitted – This worksheet must be submitted or none of the markdowns or other price changes can take effect. • Submitted for approval – This worksheet has been submitted and is waiting for someone with approval rights to approve it. This worksheet must be approved or none of the markdowns or other price changes can take effect. • Approved – This worksheet has been approved. The markdowns and other price changes will be sent to the pricing system.
Modified By	The user name of the person who last modified this worksheet
Modified Time	The time this worksheet was last modified

Asking What If

Asking what if refers to the capability to experiment with different markdown choices and target values and compare those outcomes to the original weekly forecast. You may enter your own markdown prices and other scenario variables to see the resulting forecast for the selected items. In a quick, interactive manner, the What-If feature provides you with an idea of how these changes might affect your key items.

Before you use the What-If feature, make sure you also understand the relationship between What-If and the following:

- Hierarchies
- Security Permission (User Roles)
- Business Rules

Hierarchies (and Attributes) are various levels created within Price to organize and assign your company's data, security permission (user roles), and business rules. Understanding this interaction will assist you in using and correctly evaluating What-If scenario forecasts. To review Security Permission and Business Rules, see the Business Rules section of the *Oracle Retail Price Optimization Administration Guide*.

The following sections give you a basic understanding and ability to successfully use the What-If functionality:

The What-If Screen

- Title and Messages
- Action
- Forecast and Metrics
- Scenario Settings Table
- Graph

Creating What-If Scenarios

The What-If Screen

The field labels displayed on the What-If screen are configured at system set up to display the information most meaningful to your company.

The What-If screen is divided into five sections as illustrated below:

The screenshot shows the 'What If' application window with the following sections:

- Section 1:** Title 'What If' and item information: '1 item involving 0 Pricing Groups. Recommendations have forecast for 1 item.'
- Section 2:** Action menu with options like 'Recalculate', 'Show Initial Recommendations', and 'View Optimization Messages'.
- Section 3:** Data tables for 'LTD', 'TTODS', and monthly forecasts from 11/02/2002 to 11/05/2002. It includes rows for 'Ticket Price', 'Sales \$', 'Sales Units', 'GM %', 'MD %', 'Discount \$', 'Sell Thru %', 'EDP Units', and 'EDP \$ (Retail)'. A 'WOMENS' dropdown menu is visible.
- Section 4:** 'Scenario Settings (across all forecasted items)' table with columns for 'Scenario Variable', 'Scenario Override', 'Value Used', and 'Current Setting'. It shows 'Inventory' with a value of 161.
- Section 5:** A line graph showing a downward trend from a value of 160 to 120.

Titles and Messages

This section of the What-If screen displays both the title of the screen and information about the items selected. Item information is illustrated in green print and lists the following:

- If any of the selected items are also included in Pricing Groups
- How many of the selected items have recommendations
- The recalculation count, if present
- How many items have been included in the What-If forecast

Error messages appear red print

The screenshot shows the 'What If' application window with a green message: '1 item involving 0 Pricing Groups. Recommendations have forecast for 1 item.'

Action

Once you have evaluated, viewed, entered and/or changed information on the What-If screen, you may:

- Recalculate
- View and/or reset the What-If forecast to the initial recommendation(s)
- View optimization messages
- Take the Price initial optimized markdown recommendation(s)
- Take altered markdown recommendations after you select Recalculate
- Print and Export information

To take Action and access the Action drop-down list, navigate to the Action field and click directly on the down arrow within the field.

The Action drop-down list appears:

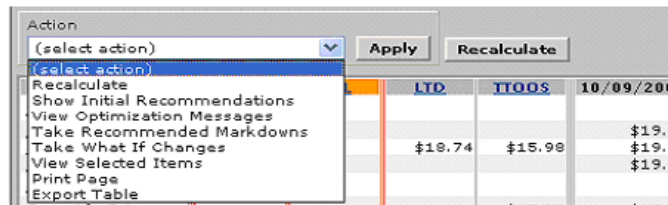

The following are definitions for the Action drop-down list:

Action Drop-Down List	Definition
Recalculate	Using markdowns and other value changes, re-optimize and show the new forecast.
Show Initial Recommendations	Redisplays and resets the initial Price recommended markdown(s).

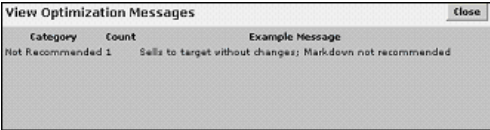
Action Drop-Down List	Definition
View Optimization Messages	<p>When selected, a pop-up displays information messages for the initial Price optimization or your recalculated optimization:</p> 
Take Recommended Markdowns	Allows you to take the original or initial recommended markdown recommendations as in the Price Worksheet.
Take What-If Changes	Allows you to take your What-If changes from the What-If screen (including the business rule changes). If not changed, this value will be used in the next Price optimization.
Print Page	Select the Print option to print the information on the What-If screen.
Export Page	Allows you to download information on the What-If screen and export and save the file.

The Action section also contains two buttons to the right of the Action field:

1. **Apply Button** - Click **Apply** after you select an Action from the available Action drop-down list within the Action field.
2. **Recalculate Button** - Performs the same action as Recalculate in the Action drop-down list. Either Recalculate directly from clicking on the button or Recalculate from the Action drop-down list.

Forecast and Metrics

Within the What-If screen (and all throughout the Price application) are field labels that organize the presentation of field information and calculations. Metrics are both field labels and the field contents that display numbers, dates and other results. Metrics are configured during system set-up and reflect your company's unique business.

Chapter 3
Managing Markdowns

The What-If Forecast and Metrics section resembles a table with labels listed across the top (Column Metrics) and down the left side (Row Metrics), see example below:

	FCEOL	EOL	LTD	TTOOS	11/02/2002	11/09/2002	11/16/2002	11/23/2002	11/30/2002
Fill Right/Left					< >	< >	< >	< >	< >
Opt Ticket Price					\$5.00	\$1.99	\$1.99	\$1.99	\$1.99
Opt Sales Price			\$4.93	\$2.30	\$5.00	\$2.10	\$1.99	\$1.99	\$1.99
Orig. Price					\$5.00	\$5.00	\$5.00	\$5.00	\$5.00
Price Ladder									
Override Price				\$2.30	\$5.00				
Ticket Price					\$5.00	\$1.99	\$1.99	\$1.99	\$1.99
Sales Price					\$5.00	\$2.10	\$1.99	\$1.99	\$1.99
Sales \$	\$35,744.79	\$135,744.79	\$105,140.16	\$30,604.63	\$6,195.00	\$8,097.60	\$5,914.28	\$5,591.90	\$4,805.00
Sales Units	34,633	34,633	21,341	13,292	1,239	3,856	2,972	2,810	2,400
GM \$	\$7,733.79	\$7,733.79							
GM %	42.5 %	42.5 %							
MU %					60.0 %	-0.5 %	-0.5 %	-0.5 %	-0.5 %
MD \$				\$71,376.13	\$0.00	\$71,376.13	\$0.00	\$0.00	\$0.00
Discount \$				\$71,376.13	\$0.00	\$71,376.13	\$0.00	\$0.00	\$0.00
Sell Thru %				53.3 %	5.0 %	16.3 %	15.0 %	16.6 %	17.2 %
Sell Thru % (Total)	74.8 %	74.8 %	46.1 %	28.7 %	2.7 %	8.3 %	6.4 %	6.1 %	5.2 %
EOP Units	11,660	11,660	24,952	11,660	23,713	19,857	16,885	14,075	11,660
EOP \$ (Retail)	\$23,203.4	\$23,203.4	\$124,760	\$23,203.4	\$118,565	\$39,515.43	\$33,601.15	\$28,009.25	\$23,203.4
EOP \$ (Cost)	\$23,320	\$23,320	\$49,904	\$23,320	\$47,426	\$39,714	\$33,770	\$28,150	\$23,320
Promo Flag									

Click directly on the Metric labels to get a detailed definition of the information represented by the Metric. Scroll across the row or down the column to view the Metric contents.

The following are some common Column Metrics and their definitions:

Column Metric	Definition
FCEOL	ForeCasted End Of Life represents the forecasted total from the beginning of the life cycle to the exit date, using the forecast and markdowns from the weekly run.
EOL	End Of Life represents the sum of the LTD and TTOOS totals, representing the forecasted totals from the beginning of the life cycle to the exit date. This uses the forecast and markdowns from the What-If simulation, if re-calculation has occurred. Otherwise it is the same as FCEOL.
LTD	Life To Date is the total from the beginning of the life cycle to the most recent week of history.
TTOOS	Total Til Out Of Stock represents the forecasted total from the start of the simulation to the exit date. Displays the initial Price markdown recommendations or after a Show Initial action. Displays the forecast and markdowns from the What-If simulation, if a re-calculation has occurred.

Column Metric	Definition
Dates	The fiscal weeks' forecast until the End of Life for the items selected.

The following are some common Row Metrics and their definitions:

Row Metric	Definition
Fill Right/Left	Once a Price Ladder and/or Override Price have been entered (or left blank), click the Fill Right/Left arrows to automatically fill the empty fields with the values you select.
OPT Ticket Price	Optimized Ticket Price represents the Ticket Price forecasted during the Price weekly run for the end of the specific time period.
OPT Sales Price	Optimized Sales Price is the forecasted Sales Price for the week, assuming all recommended markdowns are taken. This price may be lower than the forecasted ticket price due to promotions. It may be higher than the ticket price in markdown weeks since some sales in those weeks may be forecasted to occur prior to the markdown.
Orig. Price	Original Retail Price represents the ticketed price of the item before any markdown recommendations taken.

Row Metric	Definition
Price Ladder	<p>The available price ladders listed in the drop-down field will dynamically change the available options listed in the subsequent Override Price drop-down field.</p> <p>You may leave this field blank (not make a selection) -OR-</p> <p>Select a ladder from the drop-down list of price ladder options. Each price ladder represents a list of store-supported prices to which the merchandise may be marked down. These price ladders are configured to represent your company's business. Overall, the types of ladders that may be configured in the Price system are as follows:</p> <ul style="list-style-type: none"> • Perm Price Point - use permanent accounting, specify a dollar value • Perm Percent Off - use permanent accounting, specify a percent of full price • Temporary Price Point - use temporary accounting, specify as a dollar value • Temporary Percent Off - use temporary accounting, specify as a percent of full price • POS- Percent - use temporary accounting, specify as a percent off the current ticket price

Row Metric	Definition
Override Price	<p>If you left the Price Ladder field blank (no selection from the drop-down list is made), the following choices are available in the Override Price drop-down list:</p> <ul style="list-style-type: none"> • Ticket - Select this to make no change, accept values as is • Recommended - Select this to markdown to the initial/untaken Price recommendations • Recommended as Temp - Select this to markdown to the recommended level, but use temporary markdowns <p>If you select a Price Ladder from the Price Ladder field, the Override Price drop-down list updates with either a list of prices or a list of percents off, dynamically changing to match the Price ladder selected.</p>
Ticket Price	<p>Ticket Price resulting from the What-If optimization. If no re-calculation has occurred, this will be the same as OPT Ticket Price. The Ticket Price is inventory-weighted averages across the forecasted items.</p>
Sales Price	<p>Sales Price resulting from the What-If optimization including Temporary, POS, and Promotions. In weeks with markdowns, this number may be higher than the ticket price if any sales occurred at the pre-markdown price. The Sales Price is sales-weighted averages across the forecasted items.</p>
Sales \$	<p>The total Sales Dollars for the specified time period.</p>
Sales Units	<p>The total Sales Units for the specified time period.</p>
GM \$	<p>Gross Margin Dollars include the sales dollars minus (Unit Cost multiplied by Total Units) plus (Residual value of unsold units).</p>
GM %	<p>Gross Margin Percent is the Gross Margin Dollars divided by Sales Dollars.</p>

Chapter 3
Managing Markdowns

Row Metric	Definition
MU %	MarkUp Percent is the (Ticket Price minus Unit Cost) divided by Ticket Price.
MD \$	MarkDown Dollars equals the forecasted markdown cost for the specified time period. The markdown cost is the sum of the costs based on permanent markdowns.
Discount \$	Discount Dollars is the forecasted discount cost for the specified time period. The discount cost is the sum of permanent and temporary markdown costs as well as promotions.
Sell Thru %	Sell Through Percent represents the Percentage of units sold during a given period, relative to units at the beginning of that period. Calculated as follows: Sales Units divided by (Cumulative Sales Units plus EOP Units). Cumulative Sales Units are the total sales through the period and EOP Units are the forecasted remaining units at the end of the period.
Sell Thru % (Total)	Percentage of units sold during a given period, relative to total buy quantity. Calculated as: Sales Units divided by (Cumulative Sales Units plus EOP Units). Cumulative Sales Units are total sales through the period and EOP Units are the forecasted remaining units at the end of the period.
EOP Units	End Of Period Units represent the Forecasted remaining units at the end of the period.
EOP\$ (Retail)	End Of Period Dollars (Retail Value) is the Forecasted retail value of remaining units at the end of the period.
EOP\$ (Cost)	End Of Period Dollars (Cost Value) is the Forecasted cost of remaining units at the end of the period.
Promo Flag	Indicates that the selected item(s) have a planned promotional event.

Scenario Settings Table

When an item is selected for evaluation on the What-If page, Price automatically populates the screen with the item's markdown metrics and Scenario Settings from the most current Price optimization.

Scenario Settings are a set of operational constraints (business rules) contained in a table located on the What-If screen. For an explanation of business rules, see the Business Rules section of the *Oracle Retail Price Optimization Administration Guide*. Overriding the Scenario Variables Settings allows you to experiment with markdown recommendations and forecast what will happen if these changes are applied to the selected items. The What-If function uses values from the table and metrics available for manipulation on the What-If screen to recalculate the optimal markdown forecast.

Select a Scenario Variable by clicking in the box to the left of the Scenario Variable column. Enter the Override Value associated with the Scenario Variable. A description of the Scenario Settings columns and fields are listed below:

Scenario Settings (across all forecasted items)				
	Scenario variable	Override Value	Value Used	Current Setting (default)
<input type="checkbox"/>	Current Inventory		1002 - 5486	1002 - 5486
<input checked="" type="checkbox"/>	Exit Dates	03/21/05	03/21/05	03/03/05 - 03/25/05
<input type="checkbox"/>	Target Sell Thru %		12% - 17%	12% - 17%
<input type="checkbox"/>	Salvage Value	5	4% - 6%	4% - 6%

COLUMNS in the Scenario Settings Table:

- Selection box Selecting the check box allows you to enter values in the Override Value field.
- Scenario variable The operational constraint or Business Rule available to override.

Override variable	<p>Selection Box must be checked in order to enter values in the Override Value field. The value (number, date, %) in this field will override the current value last submitted within Business Rules Manager, Item Maintenance or a previous What-If Take Changes action.</p> <p>This value matches the forecast displayed in the grid and will be used for recalculation when applied.</p>
Value used	<p>Most recently altered Scenario Variable Override value. Use this field value in conjunction with the Current Setting (default) value to determine if the What-If forecast differs from the default settings. Information in the Value Used field will correspond to the Grid in the lower right of the What-If screen.</p>
Current setting (default)	<p>Values that will be used to calculate What-If forecasts, Grids and the next model run if no Override Value is entered. The Current Settings reflect up-to-date values that may have been set via the Business Rules Manager, Item Maintenance, or a previous What-If Take Changes action.</p>

ROWS in the Scenario Settings Table:

Current Inventory	<p>Changing this value will allow you to experiment with canceling existing inventory orders or making new orders. This value may be represented as a range of numbers of units or a percentage of beginning on hand inventory.</p>
Exit Dates	<p>The desired target date (expressed as mm/dd/yyyy) for selling out the inventory.</p>
Target Sell Thru %	<p>The desired target inventory level at the exit date, usually specified as a % of the original retail price.</p>
Salvage Value	<p>Value of any inventory left beyond the target exit date, usually specified as a % of the original retail price.</p>

Graph

The graph on the What-If screen is a visual representation of the week-to-week EOP Units (End of Period Inventory) and Sales Units. The What-If graph displays the inventory and sales data for the initial Price forecast and for your What-If scenario forecast, as shown in Before Recalculating and After Recalculating. The graph is located at the bottom right of the What-If screen and changes dynamically to show you the impact of price changes.

Before recalculating:

The Graph initially displays two lines with solid, colored square (orange) and circular (blue) points. The circular points represent the Forecasted Inventory in Units, the square points denote the Forecasted Sales within the time frame targeted to sell the selected items.

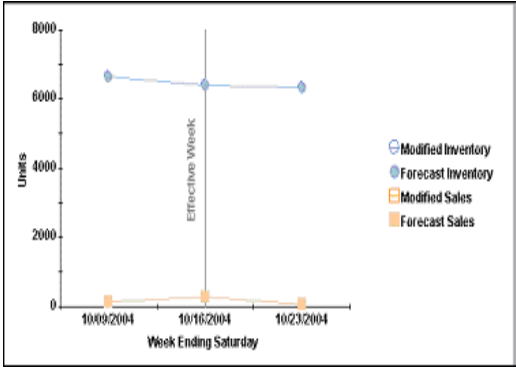



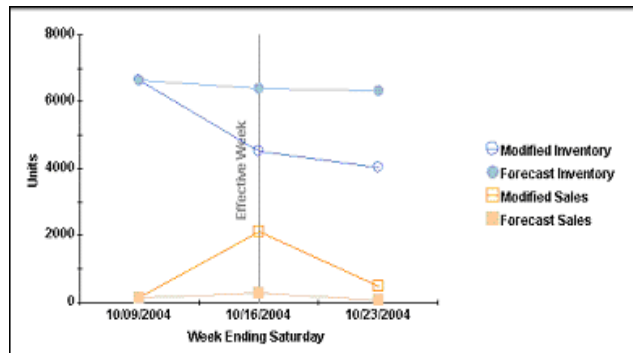

After recalculating:

The Graph will display four lines after recalculating. The two solid, colored square and circular points still represent the Forecasted Sales and Inventory Units (as mentioned previously). The two hollow, colored square and circular points represent the modified, What-If optimized results. The hollow square points (orange line) illustrate the new modified Sales Units expected to sell within the time period listed. The hollow circular points (blue line) show the modified Inventory Units expected to sell after the What-If recalculation.

Chapter 3
Managing Markdowns



Symbol	Description
	Modified Inventory - Hollow, circular, blue line
	Forecast Inventory - Solid, circular, blue line
	Modified Sales - Hollow, square, orange line
	Forecast Sales - Solid, square, orange line

Creating What-If Scenarios

A What-If scenario is the result of changes made to markdown prices and Scenario Override Values for selected items. To see the results of a scenario, you may click **Recalculate** (or select Recalculate from the Action drop-down list, then click **Apply**) to update the forecasts and graph. From there, you may compare Gross Margin and other metrics for both the Price initial recommendations and your What-If scenarios.

Creating a What-If scenario with changes made to Markdown Prices and Pricing Ladders:

1. On your Worksheet, click the check box next to each item you want to include in a What-If scenario. *You may select up to 100 items.*

For best results, select items with similar pricing and/or operational constraints. For example, though you could select an item with a current price of 29.99 and another item with a current price of 3.99, the What-If results will be easier to interpret if you create separate What-If scenarios for disparately priced items.

2. From the Action field drop-down list, select What-If, then click **Apply**.

The What-If screen appears showing the recommended forecast for the items selected:

The screenshot shows the 'What If' application window. At the top, it indicates '3 Items Involving 8 Pricing Groups' and 'Revised recommendations have forecast for 3 items'. Below this is an 'Action' dropdown menu with 'Apply' and 'Recalculate' options. The main area contains a table with columns for 'Item', 'EODL', 'LTD', 'TTODL', and five dates from 11/02/2002 to 11/29/2002. The table lists various items like 'Full Book Left', 'Dist Ticket Price', 'Dist Sales Price', 'Dist Price', 'Price Ladder', 'Discount Price', 'Ticket Price', 'Sales Price', 'Sales Value', 'CPI %', 'Mkt %', 'Mkt \$', 'Discount %', 'Sales Item %', 'Sales Item % (Total)', 'EQP Units', 'EQP \$ (Total)', and 'EQP \$ (Unit)'. Below the table is a 'Scenario Settings' section with fields for 'Scenario Variable', 'Scenario Override', 'Value Used', and 'Current Setting'. At the bottom right, there is a line graph showing 'Units' on the y-axis (0 to 160) and 'Week Ending Saturday' on the x-axis (11/02/2002 to 01/04/2003). The graph plots 'Modified Inventory' (blue line with circles), 'Forecast Inventory' (green line with squares), 'Modified Sales' (orange line with triangles), and 'Forecast Sales' (red line with diamonds).

Scroll to the right to view the number of weeks until the target Exit Date. The What-If screen does not display recommendations for weeks past the latest Outdate.

- In the first week displayed, select the type of markdown you wish to experiment with.

Note: The orange dated column is the first week your Taken changes may be put into effect.

To...	Do the following...
enter a markdown price	<p>From the Price Ladder drop-down list, select a Price Ladder for permanent markdown prices, temporary markdown prices, or POS percent off.</p> <ul style="list-style-type: none"> If you select a price or percent off from a permanent markdown Price Ladder, both the Sales Price and the Ticket Price change to the selected value. If you select a price or percent off from a temporary markdown price ladder, the Sales Price changes to the selected value, and the Ticket Price remains unchanged. If you select a percent off (from a POS Percent Price Ladder), the percent off is applied to the ticket price currently in effect to produce a new Sales Price. <p>From the Override Price drop-down list, select the price or percent off (depending on the Price Ladder options selected) you wish to experiment with.</p>
use the Price markdown initial recommendations using permanent markdowns	From the Price Ladder drop down list, make sure no Price Ladder is selected. From the Override Price drop-down list, select Recommended.
take the Ticket price without specifying a markdown	From the Price Ladder drop down list, make sure no Price Ladder is selected. From the Override Price drop-down list, select Ticket.

To...	Do the following...
use the Price initial markdown recommendation using temporary markdowns	From the Price Ladder drop down list, make sure no Price Ladder is selected. From the Override Price drop-down list, select Rec as Temp .

- Click the right and left arrow buttons to quickly populate data to weeks as necessary. The arrows assist you in populating the successive weeks with values selected in the Price Ladder field and Override Price field.

For example:

- Select a value in the Price Ladder field from the drop-down list.
- Select the corresponding Override Price from the Override Price drop-down list:



- Click on the Right arrow. Price automatically populates the same values in the Price Ladder field and Override Price field to all the fields to the right:

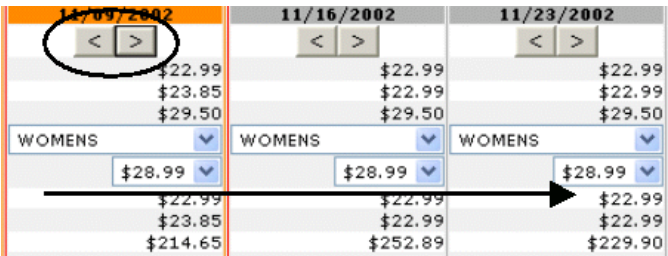

- Repeat steps 3 and 4 until each week reflects your markdown choices.
 You may click **Recalculate** as you make each change, or you could wait until you have made all of your changes.
- When each week reflects your choices, click **Recalculate**.
 (Alternatively, you could select **Recalculate** from the Action drop-down list and

then click **Apply**.)

The effects of your markdown selections appear in the EOL column and in the graph.

7. View the resulting What-If scenario forecast for the weeks listed on the What-If screen.
8. After you review the What-If results, you may perform any of the actions listed in the table below:

To...	Do the following...
keep a record of the changes you made for future reference	<p>From the Action field's drop-down list, select Print Page and click Apply.</p> <p>On the Print dialog box that appears, adjust the orientation and paper size to your needs.</p>
make no changes and return to the worksheet from which you first selected the items for What-If analysis	<p>Click Cancel.</p> <p>Your What-If modifications are not saved, and they have no effect on any markdowns.</p>
take the initial markdowns recommended by Price, do not apply What-If changes	<p>From the Action field's drop-down list, select Take Recommended Markdowns and click Apply.</p> <p>The worksheet from which you first selected the item(s) for What-If analysis appears, and the status for the item(s) is Taken Item Recommended or Taken Pricing Group Recommended.</p>

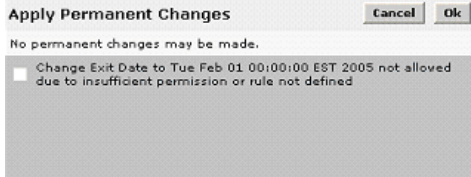
To...	Do the following...
<p>take the changes as modified for the item(s) currently selected for the What-If scenario</p>	<p>From the Action field's drop-down list, select Take What-If Changes and click Apply.</p> <p>The worksheet from which you first selected the item(s) appears, and the status for the item(s) is Taken from What-If.</p> <p>Regardless of the changes you made for all of the weeks displayed in the What-If scenario, only the changes for the current effective date are applied to the next weekly optimization.</p> <p>For example, if the current effective date is 3/24/2004 (indicated by an orange border on the What-If screen). Then, if you decide to modify the markdowns for that week and two other weeks, only the markdown for 3/24/2004 is Taken when you select the Take What-If Changes action option.</p> <p>If any of the changes cannot be made, a pop-up box appears with more information:</p> 
<p>Note: You may change Markdown Prices, Ladder Selections, and Operational Constraints within the Scenario Settings Table all within a single What-If scenario.</p>	

Creating a What-If scenario with changes made to Operational Constraints listed in the Scenario Settings Table:

1. On your Worksheet, click the check box next to each item you want to include in a What-If scenario. *You may select up to 100 items.*

For best results, select items with similar pricing and/or operational constraints. For example, though you could select an item with a current target Exit Date of

Chapter 3
Managing Markdowns

December and another item with a current target Exit Date of October, the What-If results will be easier to interpret if you create separate What-If scenarios for items with disparate operational constraints.

- From the Action field drop-down list, select What-If and click **Apply**.

The What-If screen appears showing the recommended forecast:

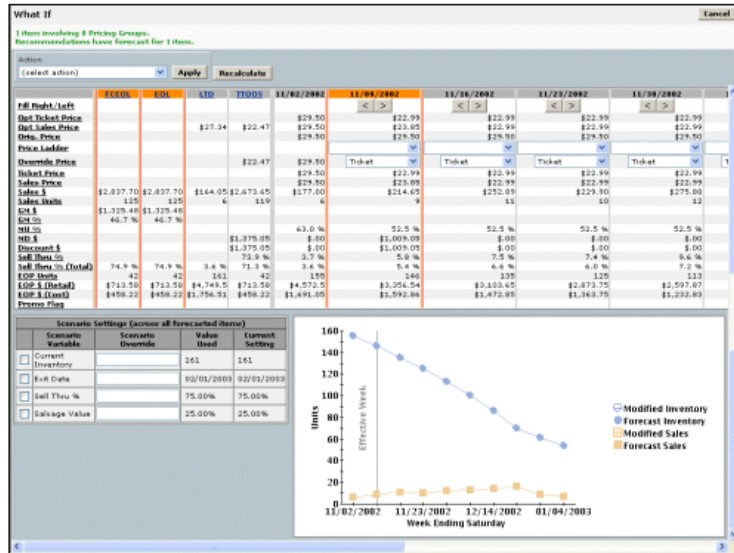

Scroll to the right to view the number of weeks until the target Exit Date. The What-If screen does not display recommendations for weeks past the latest Outdate.

- In the first week for which you want to make a change, leave the Initial Price recommended markdown as it is.

Note: The orange dated column is the first week your Taken changes may be put into effect.

To...	Do the following...
use the Price markdown recommendation	From the Price Ladder drop down list, make sure no Price Ladder is selected. From the Override Price drop-down list, select Recommended.

To...	Do the following...
take the Ticket price without specifying a markdown	From the Price Ladder drop down list, make sure no Price Ladder is selected. From the Override Price drop-down list, select Ticket.
use the Price markdown recommendation using temporary markdowns	From the Price Ladder drop down list, make sure no Price Ladder is selected. From the Override Price drop-down list, select Rec as Temp .
Note: You may change Markdown Prices, Ladder Selections, and Operational Constraints within the Scenario Settings table all within a single What-If scenario. This example will focus on the Scenario Settings Table only.	

4. Leave the Price Ladder field blank (do not select a value). Leave the Override Price field as Ticket (this is the Price Recommended markdown default value for this field).
5. Navigate to the Scenario Settings table located to the lower left of the What-If screen:

	Scenario Variable	Scenario Override	Value Used	Current Setting
<input type="checkbox"/>	Current Inventory	<input type="text"/>	161	161
<input type="checkbox"/>	Exit Date	<input type="text"/>	02/01/2003	02/01/2003
<input type="checkbox"/>	Sell Thru %	<input type="text"/>	75.00%	75.00%
<input type="checkbox"/>	Salvage Value	<input type="text"/>	25.00%	25.00%

To review the definitions of the rows and columns within the Scenario Settings table, see “Scenario Settings Table” on page 95.

6. Click in the box to the left of the Scenario Variable you wish to change.

To...	Do the following...
<p>increase or decrease the Current Inventory Levels</p>	<p>Note the Current Setting field and the value listed in the Current Inventory row:</p> <p>To Increase the Inventory Level, make sure the Scenario Override number you enter is Greater than the number listed.</p> <p>To Decrease the Inventory Level, enter a number in the Scenario Override field that is Smaller than the number in the Current Setting field.</p>
<p>extend or shorten the Exit Date</p>	<p>Note the Current Setting field and the date listed in the Exit Date row:</p> <p>To Extend the Exit Date, make sure the Scenario Override date you enter is After the date listed.</p> <p>To Shorten the Exit Date, enter a date in the Scenario Override field that is Before the date in the Current Setting field.</p>
<p>increase or decrease the Sell Thru Percent</p>	<p>Note the Current Setting field and the percent listed in the Sell Thru Percent row.</p> <p>To Increase the Sell thru Percent, make sure the Scenario Override percent you enter is Greater than the percent listed.</p> <p>To Decrease the Sell Thru Percent, enter a percent in the Scenario Override field that is Smaller than the percent in the Current Setting field.</p>

To...	Do the following...
increase or decrease the Salvage Value	<p>Note the Current Setting field and the percent listed in the Sell Thru Percent row.</p> <p>To Increase the Salvage Value Percent, make sure the Scenario Override percent you enter is Greater than the percent listed.</p> <p>To Decrease the Salvage Value Percent, enter a percent in the Scenario Override field that is Smaller than the percent in the Current Setting field.</p>

7. Go to the Action field located in the upper left of the What-If screen. Either click **Recalculate**, or click the down arrow in the Action field. Select Recalculate from the Action Field's drop-down list. Click **Apply**.
8. After viewing the What-If forecast scenario, decide to take an Action from the Action section. See “Action” on page 88 for information.

Note: If you select Take What-If Changes after changing the following:

- Markdowns for dates other than the Effective Date (the first week listed in the Dates column of the What-If forecast scenario).
- Inventory amounts

A pop-up screen will appear indicating No permanent changes may be made.

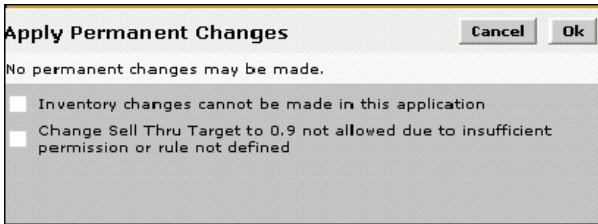

Click **OK** or **Cancel** to exit out of the screen, or click on the check box in front of the change to be made in the What-If screen.

9. View the resulting What-If scenario forecast for the weeks listed on the What-If screen.

Applying the Optimize-to-Budget Feature

The optimize-to-budget feature assesses all selected items with markdown recommendations and intelligently applies your markdown budget dollars to provide the greatest gross margin. The results for each item might be the original optimal markdown, a shallower markdown, or no markdown.

Specifically, the optimize-to-budget feature allows you to do the following:

- Select only those items you want to include in the optimize-to-budget analysis.
- Take priority markdowns and exclude them from the optimize-to-budget analysis so that the markdowns are not altered. The optimize-to-budget feature will deduct the cost of those markdowns out of the total budget *prior to* optimizing your budget across the rest of the eligible items, resulting in a more accurate allocation of the budget.

Optimize-to-Budget and Markdown Accounting

In the optimize-to-budget feature, Price calculates the cost of the markdown assuming a permanent price change. A permanent price change is the markdown cost associated with owned inventory.

Before You Begin

Important: It is highly recommended that you apply the optimize-to-budget feature *before* you perform item and pricing group maintenance. The markdown recommendations that appear on your worksheets are generated based on the pricing groups and items as they existed at the time of Price optimization. Therefore, if you make changes to pricing groups before applying the optimize-to-budget feature, you are bypassing that optimization.

You can still manually change markdowns after you apply the optimize-to-budget feature.

To apply the optimize-to-budget feature:

1. From the Main Menu, select **Markdowns**.
 The Worksheet Summaries screen appears.
2. From the Worksheet Summaries screen, select the worksheet to which you want to apply the optimize-to-budget feature.
 The selected worksheet appears.
3. Do one of the following.

Note: If you take markdowns before applying the optimize-to-budget feature, you are prompted (as shown in step 4) to include or exclude those markdowns before the actual optimize-to-budget analysis.

If	Do this
You want the optimize-to-budget feature to analyze the entire worksheet (except for items you may have added manually)	Click the top left check box to select all items on the worksheet.
You want the optimize-to-budget feature to analyze some items (except for items you may have added manually) but not others	Click the check box next to each item you want to include in the optimize-to-budget analysis.
You want to take some markdowns and you want to exclude those items from the optimize-to-budget analysis	Take the markdowns as you usually do. Click the check box next to the remaining items that you want to include in the optimize-to-budget analysis.
You want to take some markdowns but still include those items in the optimize-to-budget analysis	Click the check box next to the items that you want to include in the optimize-to-budget analysis, even if you have already taken markdowns for them.

- From the Action list, select **Optimize to Budget** and click **Apply**.

If taken markdowns are included in the selected items, a confirmation dialog box appears asking if you want to include or exclude those items from the analysis.

Confirmation

You have selected 2 Taken Items. If you choose to proceed, you will lose all prior MD's taken on these items.

EXCLUDE selected taken items. This will exclude all taken items selected and you will retain previously taken MD's

INCLUDE selected taken items. This will include all taken items selected for optimization and you will lose previously taken MD's

Otherwise, the Optimize To Budget dialog box appears. Depending on the Price implementation for your company, your markdown budget may already appear in this dialog box.

Optimize To Budget

By selecting this action, PL Price will evaluate the best combination of price reductions for the selected items that will both, fit within the budget to optimize within, AND maximize gross margin dollars.

Please enter the numeric value of the amount without symbols or decimal digits. E.g. For "\$1000.00" please enter "1000".

Monthly MD Budget	0
Committed MD \$	0
Taken MD \$ (this week)	0
MD Budget Balance	0
MD \$ to reserve for remaining periods this month	0

Budget to Optimize within 0

Only evaluate PL Optimal price and PL No Action Taken options. No other price points will be evaluated if you select this option. (This is analogous to the Fit-To-Budget operation that was available in previous versions of this software.)

- Complete the Optimize To Budget dialog box using the following table as a guideline.

Field	Description
Monthly MD Budget	<p>This field may be pre-populated with the markdown budget as submitted by your company. If it is not, enter the dollar amount of your monthly markdown budget as a whole number, omitting the dollar sign, commas, and decimal value for cents.</p> <p>Example: If your markdown budget is \$1,790,000.50, you would enter 1790000.</p>
Committed MD \$	<p>This information is for display only, and it is populated only if your company has submitted this value. It represents all of the markdown dollars that have been taken (already executed in stores) for the previous weeks in this month. Markdowns that have been taken but that have not been executed in stores are <i>not</i> included in the dollar amount.</p>
Taken MD \$ (this week)	<p>This information is for display only. It reflects the taken markdown dollar amount as follows:</p> <ul style="list-style-type: none"> • It includes the dollar amount for markdowns you have taken on the worksheet but omitted from the optimize-to-budget feature. • It excludes the dollar amount for markdowns you have taken on the worksheet but selected for the optimize-to-budget feature (because these items may be assigned new markdown amounts based on the optimize-to-budget results).
MD Budget Balance	<p>This information is for display only. The markdown budget balance is calculated as follows:</p> <p>Monthly MD Budget - Committed MD \$ - Taken MD \$</p>

Field	Description
MD \$ to reserve for remaining periods this month	Enter the dollar amount of your budget that you want to save for the remainder of the month. This applies if you are executing your budget on a weekly basis. If you are not concerned about week-to-week budgets, leave this field blank.
Budget to Optimize within	Enter the dollar amount of your budget that you want the optimize-to-budget feature to use when you click Done.
Only evaluate PL Optimal price and PL No Action Taken options	This option is provided if you used the fit-to-budget feature (in previous Price releases) and want your markdown budget to be calculated in a similar way. The fit-to-budget approach considers only optimal (Price) recommendations; it does not consider shallower markdowns. (For details on the fit-to-budget feature, see the <i>Price User Guide</i> or help that accompanied earlier releases of Price.)

- When the Optimize To Budget dialog box reflects the entries you want, click **Done**.

When the reoptimization is finished, your worksheet is updated with the markdown recommendations that fit within your specified budget. The optimize-to-budget results are reflected in the following columns, which may be named differently at your company.

Taken MD (Budget Constrained for markdowns applied by optimize-to-budget)
 MD Price
 GM \$ Oppty
 GM \$ Oppty - Budget Constrained Price
 Budget Constrained Price
 MD Status

If the GM \$ Oppty - Budget Constrained Price column is 0, there is no revenue lost by the budget constraint. On the other hand, the value displayed by the GM \$ Oppty - Budget Constrained Price column is potentially lost revenue because of the budget constraint.

Note: The metrics at the bottom of the worksheet may or may not update, depending on the Price implementation at your site. If you are unsure about these metrics, check with the administrator.

7. Review the markdowns and, if necessary, make changes as you normally would.

For details on adjusting prices on your worksheets, see “Selecting Markdown Prices” on page 114.

8. When you are satisfied with the results on the worksheets, submit your worksheets for approval.

For details, see “Submitting Worksheets for Approval” on page 134.

Selecting Markdown Prices

If you are managing your markdowns within a budget, or if you just want to experiment with a markdown budget, it is recommended that you first use the optimize-to-budget feature as explained in “Applying the Optimize-to-Budget Feature” on page 108. After you use the optimize-to-budget feature, you can adjust prices as necessary before you take and submit markdowns.

Use the Worksheet screen to select markdown prices. From the Worksheet screen, you can complete the following tasks:

- “Locating an Item or Pricing Group” on page 114
- “Taking Recommended Markdowns” on page 115
- “Changing a Markdown” on page 116
- “Taking Markdowns in a Group” on page 117
- “Taking Accelerated Markdowns” on page 119
- “Removing a Markdown” on page 121
- “Reverting a Markdown” on page 122
- “Deciding Not to Take a Recommended Markdown” on page 123
- “Viewing Results of Pricing Decisions” on page 123
- “Saving Changes” on page 123

Locating an Item or Pricing Group

To locate a specific item or pricing group:

- Use the hierarchy drop-down lists to limit the merchandise that is displayed on the worksheet.

The hierarchy drop-down lists are named differently depending on your Price implementation. Following are examples of merchandise (class, sub class, and item) and location (region) hierarchy drop-down lists.

The image shows two examples of hierarchy drop-down lists. The first list is titled 'Class', 'Sub Class', and 'Item'. It has three dropdown menus with values '0', '1', and '175796' respectively, and a 'Show' button. The second list is titled 'Region' and has a single dropdown menu with a 'Show' button.

- Use the sort and filter features to control how the merchandise is displayed. See “Sorting Data” on page 166 and “Filtering Data” on page 167.

Taking Recommended Markdowns

If your merchandise is organized into pricing groups, Price makes two markdown recommendations - one for the entire pricing group and one for each individual item, as in the following example.

Desc.	Name	item_id	Rec Rtl	Grp Rec Rtl
STP ZIPCARDIGN/F2/2002	STP ZIPCARDIGN		\$17.40	\$16.99
STP ZIPCARDIGN/F2/2002	STP ZIPCARDIGN	14650035	\$17.99	\$16.99
STP ZIPCARDIGN/F2/2002	STP ZIPCARDIGN	14650037	\$16.99	\$16.99

In this example, the Rec Rtl column contains the markdown recommendation for each item, and the Grp Rec Rtl column contains the markdown recommendation for the pricing group (these columns may be named differently for your Price implementation).

Use this procedure when you want to take Price markdown recommendations “as is” with no changes. If you want to change one or more markdown recommendations, see “Changing a Markdown” on page 116.

You can take markdowns for individual items even when they are members of a pricing group.

To take a recommended markdown:

1. Select the check box for each item or grouping that you want to mark down. You can select more than one. Select all by selecting the box at the top of the column, as shown:

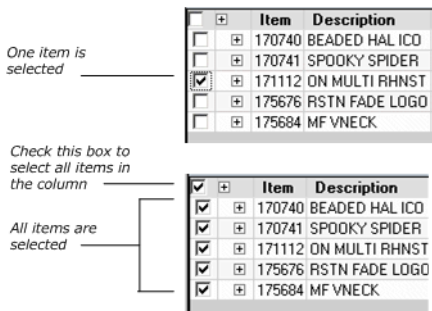

2. From the Action list box, select **Take Markdown** and then click **Apply**.
3. Repeat step 2 as necessary for other items on the worksheet.
4. When you have finished taking the recommended markdowns, click **Save**.

The summary metrics at the bottom of the worksheet show totals for the selected markdowns.

Changing a Markdown

For competitive or strategic reasons, you may want to change a markdown from the one recommended by Price. To change a markdown for one pricing group or item at a time, use the following procedure. To change a markdown to a common price for several items or pricing groups at a time, see “Taking Markdowns in a Group” on page 117.

To change a recommended markdown amount:

1. Select a data view tab (depending on your Price implementation, only one data view may be available) that presents the items in the way you want to change markdowns.

Common data views are explained in “Items and Pricing Groups in Data Views” on page 130.

2. From a worksheet, click the check box to select the item with the markdown price that you want to change.
3. From the Ladder (or the equivalent name for price ladder) column, select the appropriate value for the price ladder you want to use.
4. In the MD Pr (or the equivalent name for markdown price) column, select the new markdown price for each individual item or grouping you would like to change.
5. From the Action list box, select **Take Markdown** and click **Apply**.

The worksheet updates the Taken MD column (or the equivalent column in your Price implementation) with a status of Taken, and it updates the Taken MD Cost column (or the equivalent column in your Price implementation) with the cost of this markdown.

6. In order for these markdowns to be reported as input into your merchandise system, submit the worksheet by the cut off time as explained in “Submitting Worksheets for Approval” on page 134.

Taking Markdowns in a Group

Taking markdowns in a group (also known as taking advanced markdowns) allows you to select multiple items or pricing groups and then set them to a common price at one time. In other words, you make price changes to groups of items or pricing groups. The alternative is to set the common price for one item or pricing group at a time, as explained in “Taking Recommended Markdowns” on page 115.

To take markdowns in a group:

1. From the Worksheet screen, use the hierarchy list boxes and the Region list box (if available in your Price implementation) to filter the items or pricing groups that are displayed.
2. Click the check box for each item or pricing group that you want to markdown to the same price.
3. From the Action list box, select **Take Markdown Adv** and then click **Apply**.

The Take Markdown Advanced dialog box appears, as in the following example.

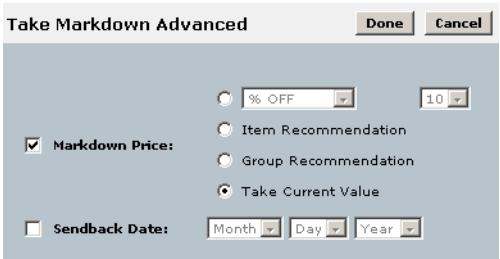

4. Click the Price Ladders check box, and select one of the following.

To	Select
Take a markdown from one of the price ladders defined for your company	The Markdown Price check box and the radio button next to the price ladder list box. Then select a price ladder and a price or percent off.
Take the recommended markdowns specific to individual items, even if the items are part of a pricing group	The Markdown Price check box and the Item Recommendation radio button

To	Select
Take the markdown that is recommended for the entire pricing group (instead of taking the markdowns recommended separately for each item in the group)	The Markdown Price check box and the Group Recommendation radio button.
Take the markdown(s) you entered or edited in the MD Price column (or the equivalent column in your Price implementation)	<p>The Markdown Price check box and the Take Current Value radio button.</p> <p>The Take Current Value option is the same as selecting the Take Markdown action. It is provided on the Take Markdown Advanced dialog box as a short cut.</p>

5. (Optional) If you also want to accelerate these markdowns, you can do so by selecting Sendback Date and selecting a date. However, make sure you understand how accelerated markdowns work, as explained in “Taking Accelerated Markdowns” on page 119. Also note that this feature may not be available, depending on your Price implementation.
6. When the Take Markdown Advanced dialog box reflects your selections, click **Done**.

The worksheet is updated with the new price ladder and markdown price information, and the Taken MD column (or the equivalent name in your Price implementation) for this item is changed from Not Taken to Taken.

Note: If you took accelerated markdowns, the Date Sent, Price Sent, and Ladder Sent columns (or the equivalent names in your Price implementation) are not populated until the Price system is updated with the accelerated sendback file, which contains the new accelerated prices.

7. In order for these markdowns to be reported as input into your merchandise system, submit the worksheet by the cut off time as explained in “Submitting Worksheets for Approval” on page 134.

Taking Accelerated Markdowns

Note: Depending on how Price is configured for your company, this feature may not be available.

Taking accelerated markdowns means that you temporarily override the markdown schedule to address poorly performing items quicker than if you followed the markdown schedule in place for your stores. (The markdown schedule typically runs from the day you receive sales information to make pricing decisions to the day the price changes are visible on the retail floor. In many cases, this can be 14 days.)

Taking an accelerated markdown changes the date the markdown decisions are sent back to you (called *sendback date*) so that you get the markdowns at a date earlier than the sendback date set for your stores. The markdown decisions (taken markdown recommendations) are then input into your pricing system, and from there they are implemented on the retail floor in time for the effective date of the markdown.

Note the following:

- You can take accelerated markdowns for items or pricing groups at or below the worksheet level.
- The sendback date for accelerated markdowns must be between the current date and the date set by your stores as the global sendback date.
- You can take an accelerated markdown for a given item once within the markdown schedule. (After an item has been submitted and approved with a new sendback date, a confirmation date in the sendback file is recorded in the Date Sent column on the worksheet. When the Date Sent is set, you cannot submit the item again during the current markdown schedule. If you want to submit another sendback date for that item, you must wait for the next markdown schedule, e.g., when you next receive sales information and markdown recommendations at the beginning of a new markdown schedule.)

To take accelerated markdowns:

1. From the Worksheet screen, use the hierarchy list boxes and the Region list box (if available in your Price implementation) to filter the items or pricing groups that are displayed.
2. Click the check box for each item or pricing group whose markdown you want to accelerate to a new sendback date.
3. From the Action list box, select **Take Markdown Adv** and then click **Apply**.

The Take Markdown Advanced dialog box appears, as in the following example.

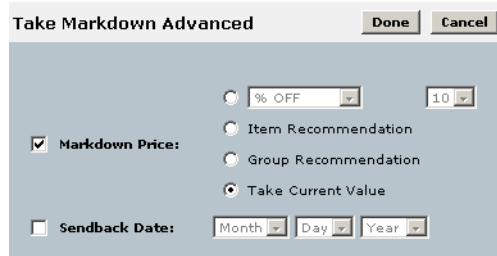

4. Click the Sendback Date check box and then select the month, day, and year for the sendback date.

Note: You can select only from the months, days, and years listed. These dates are within the valid range between the current day and the day set by your stores as the global sendback date.

5. (Optional) If you also want to set the selected items or pricing groups to a common markdown price, you can do so by selecting the Price Ladders check box, a price ladder, and a price (or percent off). For more information on this feature, see “Taking Markdowns in a Group” on page 117.
6. When the Take Markdown Advanced dialog box reflects your settings, click **Done**.

The worksheet is updated with the new sendback date in the Sendback Date (or the equivalent name in your Price implementation) column. The Sendback Date is the date by which you want to receive the sendback file (which will contain the new markdown price for the specified item(s)).

The remaining sendback date columns (the Date Sent, Price Sent, and Ladder Sent, or the equivalent in your Price implementation) are not populated until the Price system is updated with the accelerated sendback file, which contains the new accelerated prices.

7. In order for these markdowns to be reported as input into your merchandise system, submit the worksheet as explained in “Submitting Worksheets for Approval” on page 134.

Your worksheet must then be approved before the accelerated markdowns can be reflected in the sendback file.

Removing a Markdown

Note: You cannot remove a markdown after you have submitted a worksheet. After you submit markdowns, the worksheet is read-only.

Use the remove markdown feature when you have taken one or more markdowns (i.e., the Taken MD column displays a value *other than* Not Taken) but then decide that you do not want to take (accept) the specified markdowns.

Removing a markdown does not affect the markdown price or the sendback date (if specified). Instead, it simply changes the Taken MD status. Items with a Not Taken status do not receive a markdown price change.

If you have changed a markdown price or set a sendback date but want to revert back to the original Oracle Retail markdown price and global sendback date, see “Reverting a Markdown” on page 122.

To remove a markdown for a specific item or pricing group:

1. Select the check box for the item(s) or pricing group(s) whose markdowns you want to remove.
2. From the Action list, select **Remove Markdown** and click **Apply**.

The Taken MD column updates to Not Taken for the specified items.

What to Do Next

To change markdown prices to the Price recommendation and to change sendback dates to the global date for your company, see “Reverting a Markdown” on page 122.

To make these the final recommendations, you must submit the worksheet (“Submitting Worksheets for Approval” on page 134) and make sure it is approved (“Approving Worksheets” on page 135).

Reverting a Markdown

Note: You cannot revert a markdown price or sendback date after you have submitted a worksheet. After you submit a worksheet, the worksheet is read-only.

Use the revert markdown feature when you have changed one or more markdowns and/or specified a sendback date but then decide that you want to use the original Price markdown recommendation and global sendback date instead.

The Revert Markdown action changes an item's markdown status to Not Taken, in addition to clearing sendback dates and setting the price ladder/price point/% widgets to their initial state.

If you want to change the Taken MD status, see “Removing a Markdown” on page 121.

To revert a markdown for a specific item or pricing group:

1. Select the check box for the item(s) or pricing group(s) whose markdowns you want to revert back to the original Price markdown recommendation(s) (for the current week).
2. From the Action list, select **Revert Markdown** and click **Apply**.

The worksheet updates with the original Price markdown recommendation(s).

What to Do Next

To make these the final recommendations, submit the worksheet (“Submitting Worksheets for Approval” on page 134) and make sure it is approved (“Approving Worksheets” on page 135).

To remove the markdowns so that not even the Price markdown recommendation is taken, see “Removing a Markdown” on page 121.

Deciding Not to Take a Recommended Markdown

You may have more current data about your merchandise than the last weekly data sent to the Price optimization engine. As a result, you may decide not to take a recommended markdown for a particular reason.

Valid reasons for not taking a markdown recommendation include competition, incorrect exit dates, future promotions, pre-planned markdowns (national brand suppliers), and RTV (return to vendor) guaranteed sales/recall.

No action is required to postpone or defer a markdown. However, if you already applied the Take Markdown or Take Markdown Adv action to a worksheet, you must remove the markdown(s) before the cutoff date. See “Removing a Markdown” on page 121.

Viewing Results of Pricing Decisions

When you make changes to your worksheet and click Save, Price updates the summary metrics at the bottom of the screen. These metrics vary by Price implementation, but in general they summarize the results of the actions you have taken on the Worksheet screen, possibly including information such as the number of taken and modified recommendations, current and next month budgets, and opportunity costs.

Saving Changes

From the Worksheet screen you can save your changes in any of the following ways:

- Click **Save** to save any changes made to the worksheet.
- Click **Done** to save changes and exit the screen.
- Click **Submit** to save changes, exit the screen, and submit the changes for approval.

Viewing Forecasts for One or More Worksheets

To view a recommended forecast:

1. From the Worksheet Summaries screen, select one or more check boxes corresponding to the worksheets that you want to include in the forecast.
Note: To select all the worksheets, click the top check box.
2. From the Action list box, select **Show Recommended Forecast** and then click **Apply**.

The Recommended Forecast screen appears. For an explanation of the metrics on this screen, see “Recommended Forecast screen” on page 125.

Recommended Forecast Send to Excel Close							
Summary only includes items with exit dates and at least 4 weeks of sales							
	EOL	LTD	TTOOS	11/2/02	11/9/02	11/16/02	11/23/02
Sales \$	\$42089813.66	\$16649882.30	\$25439931.36	\$2006575.43	\$1911444.05	\$1983200.83	\$186118
GM \$	\$24,833,000.21	\$10,115,711.77	\$14,717,288.44	\$1,277,507.17	\$1,214,171.22	\$1,238,733.43	\$1,154,69
GM %	59.0 %	60.8 %	57.9 %	63.7 %	63.5 %	62.5 %	62
ST %	96.0 %	39.0 %	94.0 %	6.0 %	7.0 %	8.0 %	8
Inventory Units	114,421	2,061,516	114,421	1,920,857	1,786,317	1,643,275	1,507
Sales Units	3,309,958	1,362,863	1,947,095	140,659	134,540	143,042	135
EOH Inv \$	\$586,357.7	\$10,722,642.92	\$586,357.7	\$9,993,574.66	\$9,296,301.83	\$8,551,834.43	\$7,845,34

Recommended Forecast screen

Use the Recommended Forecast screen to view summary metrics for the weekly forecast for all items that have forecast information.

Some items have forecast information even though they do not have recommended markdowns. Each value on this screen is the sum of the corresponding values on all of the worksheets you selected when you chose to display the screen. Note that these values are view-only, and there are no item-level pricing drop-down lists.

From the Recommended Forecast screen you can:

- Send the summary to Excel.
- Click on column headings that are linked to descriptions of information in a column.

The Recommended Forecast screen always displays the forecast based on Price's markdown recommendations.

Metrics

The data displayed on the Recommended Forecast screen is configured at system set up to display the information most meaningful for your company. Thus, the metrics that appear on your Recommended Forecast screen depend on how your implementation of Price was configured.

To display the metric definition selected by your company, click the metric name. A smaller browser window appears with the metric name and definition.

Some common metrics and definitions include the following (starting with time periods):

Metric	Definition
LTD	Life to Date – The total from the beginning of the season to today.
TTOOS	Today till Out of Stock – The forecasted total from today until the exit date.

Chapter 3
Managing Markdowns

Metric	Definition
EOL	End of Life – The sum of the STD and TTOOS totals, representing the forecasted total from the beginning of the season to the exit date, using your What-If markdown schedule.
EOH Inv \$	The dollar value of the number of on-hand inventory units.
Forecast Price	The Price optimized price schedule, constrained by business rules and including any planned promotions.
Sales \$	The total sales, calculated in dollars summed for multiple items or weeks.
Sales Units	The total number of unit sales for a given time period.
GM \$	The dollar amount of gross margin generated for an item in a given time period.
GM %	The gross margin percent generated for an item in the relevant time period.
ST %	The sell-through, which is the percentage of inventory sold at a given point in time.
Inventory Units	The number of on-hand inventory units.

Viewing Item Details

To view detailed information about an item, click the item name link on the worksheet. This displays the Item Info dialog box, which provides you with the following:

- Edit Business Rules button - Opens the Business Rules Property Manger utility for the selected items. If this button does not appear, you do not have access to the Business Rules Property Manager. For more information, see .
- Print button - Opens a print dialog box so that you can print the displayed information for further review.
- Hierarchy Information - Shows you the item's place in the merchandise hierarchy.
- Markdown Information - Shows you the item's original retail price, its price last week, its current recommended price, and the outdate (exit date).
- Item Messages - Provides you with status messages that can give you insight into why an item did not receive a markdown recommendation. For a list of the item messages, see "Item Messages" on page 128.

For example, the illustration on the next page shows an item named PF MOCK and numbered 14498407. Clicking the name, which is an underlined link, opens the Item Info screen, which also contains links. Clicking the Division link opens the Division screen. In general, the additional screens provide more information about the item whose link you clicked.

The screenshot displays a software interface for managing items. At the top, there's a 'Worksheet' header with fields for Division (1), Department (31), Key (312), and Cutoff Date (Thu Jul 29 17:00:00 EDT 2004). Below this are tabs for 'Items By Name', 'Items (Flat)', 'Pricing Groups', and 'Items By Pricing Group'. A filter bar includes 'Action', 'Class', 'Sub Class', 'Item', and 'Region' dropdowns, along with 'Apply', 'Show', and 'Show' buttons. The main table lists items with columns: Name, item_id, hierarchy, Sls \$ LLLLW, ST% LLLLW, Sls Units LLLLW, Sls \$ LLLW, ST% LLLW, Sls Units LLLW, and Sls \$ LL. Four items are listed, all named 'PF MOCK'. Below the table, an 'Item Info' dialog box is open, showing 'Hierarchy Information' with fields for Division (1), Department (31), Key (312), Class (0), Sub Class (1), and Item (14498407). A 'Division' dialog box is also open, showing 'Top most level in merch hierarchy'. The 'Item Messages' section shows 'Not Recommended' with a description: 'Sells to target without c'.

Item Messages

On the Item Info dialog box, the message category is in bold text followed by the actual message in plain text.

This table lists the categories of messages that may appear in the Item Messages section of the Item Info dialog box. In general, the categories are grouped from most common to least common.

Category	Description
Not recommended	Indicates that the item has reached the date in its lifecycle when it can receive a markdown recommendation, but a recommendation would not be optimal for this item. This can occur when the next markdown price available on the price ladder is lower than the optimal markdown, so, given the history and business rule settings, it is better to wait.

Category	Description
Markdown blocked	Indicates that the item has reached the date in its lifecycle when it can receive a markdown recommendation, but a markdown recommendation was not allowed. In most cases, this is the result of promotions or a business rule setting.
Item data Inactivity Error Model configuration System	If any of these categories appear, inform the Price administrator or Oracle Retail Professional Services.

Worksheet screen

The Worksheet screen appears when you select a key (or the equivalent) from the Worksheet Summaries screen. Each Worksheet screen represents a key, which is a department or a level in the merchandise hierarchy, and it lists all of the key's merchandise items that are recommended for a markdown in the current week.

Use the Worksheet screen to view merchandise and make markdown decisions, as explained in “Selecting Markdown Prices” on page 114.

You can view merchandise and take markdowns on merchandise at the item and pricing group levels. The tabs, column names, and content that appear on the Worksheet screen are customized for each Price implementation. Therefore, if you are unsure about the meaning of a tab or column, check with the Price administrator. Following is a description of information that commonly appears on worksheets.

Note: The data that appears on each worksheet is current as of the last Price optimization. Thus, if you use Business Rules Property Manager to change item properties after the Price optimization, those changes are not reflected on the worksheet. The changes are, however, reflected on the Maintaining Merchandise screen, where you can also edit item properties.

Items and Pricing Groups in Data Views

Data views are configured during Price implementation, and in the user interface you can access them via the named tabs on Price screens, particularly the worksheet screen. Items appear on all worksheet data views whether they are independent or members of pricing groups. However, you can view worksheets in the following ways:

- Grouped by items - In this case, all items (independent and those that are members of a group) appear in the worksheet in order of the hierarchy sorting and filtering you have selected.
- Grouped by pricing groups - In this case, pricing groups appear first (you must expand them to view their items) followed by the independent items (those that are not members of a pricing group).

Data views are important because they determine, in part, the mechanism for taking markdowns. For example, you can always take a markdown by selecting one or more items or pricing groups and selecting the Take Markdowns action (see “Taking Recommended Markdowns” on page 115). You can also simultaneously change and take a single markdown for one or more items or pricing groups via the Take

Markdowns Adv action (see “Taking Markdowns in a Group” on page 117). However, each data view provides a level with the drop-down price ladders and price-ladder values that make it easier for you to select new markdown prices.

The following table describes some common data views and the level of the price ladder (MD Type in the following table) and price-ladder values (MD Price in the following table).

View	Description																								
Items By Name	<p>Displays an entry, including price or percent off ladder, for each item along with the item’s parent pricing group, if applicable. You can set markdowns on individual items, not a group.</p> <p>Use this data view when you want to set markdowns for individual items but you want the further context of which pricing group, if any, the item belongs to.</p> <table border="1"> <thead> <tr> <th>+</th> <th>Grp Desc.</th> <th>Name</th> <th>item_id</th> <th>MD Price</th> <th>MD Type</th> </tr> </thead> <tbody> <tr> <td>[-]</td> <td>STP ZIPCARDIGN/F2/2002</td> <td>STP ZIPCARDIGN</td> <td></td> <td></td> <td>WOMENS</td> </tr> <tr> <td></td> <td>STP ZIPCARDIGN/F2/2002</td> <td>STP ZIPCARDIGN</td> <td>14650035</td> <td>17.99</td> <td>WOMENS</td> </tr> <tr> <td></td> <td>STP ZIPCARDIGN/F2/2002</td> <td>STP ZIPCARDIGN</td> <td>14650037</td> <td>16.99</td> <td>WOMENS</td> </tr> </tbody> </table>	+	Grp Desc.	Name	item_id	MD Price	MD Type	[-]	STP ZIPCARDIGN/F2/2002	STP ZIPCARDIGN			WOMENS		STP ZIPCARDIGN/F2/2002	STP ZIPCARDIGN	14650035	17.99	WOMENS		STP ZIPCARDIGN/F2/2002	STP ZIPCARDIGN	14650037	16.99	WOMENS
+	Grp Desc.	Name	item_id	MD Price	MD Type																				
[-]	STP ZIPCARDIGN/F2/2002	STP ZIPCARDIGN			WOMENS																				
	STP ZIPCARDIGN/F2/2002	STP ZIPCARDIGN	14650035	17.99	WOMENS																				
	STP ZIPCARDIGN/F2/2002	STP ZIPCARDIGN	14650037	16.99	WOMENS																				
Items (Flat)	<p>Displays an entry, including price or percent off ladder, for each item, completely independent of pricing groups. In the Items (Flat) view, you can set markdowns on individual items, not on a group.</p> <p>Use this data view when you want to take markdowns for individual items.</p> <table border="1"> <thead> <tr> <th>Name</th> <th>item_id</th> <th>MD Price</th> <th>MD Type</th> </tr> </thead> <tbody> <tr> <td>STP ZIPCARDIGN</td> <td>14650035</td> <td>17.99</td> <td>WOMENS</td> </tr> <tr> <td>STP ZIPCARDIGN</td> <td>14650037</td> <td>16.99</td> <td>WOMENS</td> </tr> </tbody> </table>	Name	item_id	MD Price	MD Type	STP ZIPCARDIGN	14650035	17.99	WOMENS	STP ZIPCARDIGN	14650037	16.99	WOMENS												
Name	item_id	MD Price	MD Type																						
STP ZIPCARDIGN	14650035	17.99	WOMENS																						
STP ZIPCARDIGN	14650037	16.99	WOMENS																						

View	Description																									
<p>Pricing Groups</p>	<p>Displays each pricing group, including its price or percent off ladder, followed by items that are independent of pricing groups. To view the member items of each pricing group, expand the pricing group.</p> <p>You can change the price of pricing groups in a particular region, and you can take markdowns on entire pricing groups or on arbitrary collections of individual items, but you can't set item prices individually (unless you use the take advanced markdown feature, explained in "Taking Markdowns in a Group" on page 117).</p> <p>In the Pricing Groups view, you can set a markdown for an entire pricing group, but you can't set a separate markdown for a member of the pricing group.</p> <table border="1" data-bbox="739 765 1205 869"> <thead> <tr> <th></th> <th>Name</th> <th>item_id</th> <th>MD Price</th> <th>MD Type</th> </tr> </thead> <tbody> <tr> <td>[-]</td> <td>STP ZIPCARDIGN/F2/2002</td> <td></td> <td></td> <td>WOMENS</td> </tr> <tr> <td>[-]</td> <td>STP ZIPCARDIGN/F2/2002</td> <td></td> <td>17.99</td> <td>WOMENS</td> </tr> <tr> <td></td> <td>STP ZIPCARDIGN</td> <td>14650035</td> <td>\$17.99</td> <td>WOMENS</td> </tr> <tr> <td></td> <td>STP ZIPCARDIGN</td> <td>14650037</td> <td>\$16.99</td> <td>WOMENS</td> </tr> </tbody> </table>		Name	item_id	MD Price	MD Type	[-]	STP ZIPCARDIGN/F2/2002			WOMENS	[-]	STP ZIPCARDIGN/F2/2002		17.99	WOMENS		STP ZIPCARDIGN	14650035	\$17.99	WOMENS		STP ZIPCARDIGN	14650037	\$16.99	WOMENS
	Name	item_id	MD Price	MD Type																						
[-]	STP ZIPCARDIGN/F2/2002			WOMENS																						
[-]	STP ZIPCARDIGN/F2/2002		17.99	WOMENS																						
	STP ZIPCARDIGN	14650035	\$17.99	WOMENS																						
	STP ZIPCARDIGN	14650037	\$16.99	WOMENS																						
<p>Items By Pricing Group</p>	<p>Displays each pricing group and its member items. Each item is displayed with its price ladder.</p> <p>In the Items By Pricing Group view, you can set markdowns for individual items, and you can set markdowns on arbitrary collections of individual items.</p> <table border="1" data-bbox="739 1095 1205 1199"> <thead> <tr> <th></th> <th>Name</th> <th>item_id</th> <th>MD Price</th> <th>MD Type</th> </tr> </thead> <tbody> <tr> <td>[-]</td> <td>STP ZIPCARDIGN/F2/2002</td> <td></td> <td></td> <td>WOMENS</td> </tr> <tr> <td>[-]</td> <td>STP ZIPCARDIGN/F2/2002</td> <td></td> <td>\$17.40</td> <td>WOMENS</td> </tr> <tr> <td></td> <td>STP ZIPCARDIGN</td> <td>14650035</td> <td>17.99</td> <td>WOMENS</td> </tr> <tr> <td></td> <td>STP ZIPCARDIGN</td> <td>14650037</td> <td>16.99</td> <td>WOMENS</td> </tr> </tbody> </table>		Name	item_id	MD Price	MD Type	[-]	STP ZIPCARDIGN/F2/2002			WOMENS	[-]	STP ZIPCARDIGN/F2/2002		\$17.40	WOMENS		STP ZIPCARDIGN	14650035	17.99	WOMENS		STP ZIPCARDIGN	14650037	16.99	WOMENS
	Name	item_id	MD Price	MD Type																						
[-]	STP ZIPCARDIGN/F2/2002			WOMENS																						
[-]	STP ZIPCARDIGN/F2/2002		\$17.40	WOMENS																						
	STP ZIPCARDIGN	14650035	17.99	WOMENS																						
	STP ZIPCARDIGN	14650037	16.99	WOMENS																						
<p>Items (Aggregated)</p>	<p>Displays merchandise at the style level or some other level (depending on your implementation of Price) instead of the item level. You cannot drill down from this level, but you can take markdowns and make other changes that you would ordinarily make on worksheets.</p>																									

Taken Markdown Status

Most worksheets include a markdown status column that lists the status of the markdown for each item, pricing group, and items within pricing groups. A common name for this column is Taken MD, but the name might be different for your implementation.

Previously, the statuses were Taken (meaning that you had accepted a markdown on an item) or Not Taken (meaning that you had decided not to take the recommended markdown). The markdown statuses are now refined as follows:

Status	Description
Not Taken	You decided to delay (not take) the markdown.
Taken	You decided to take the Price recommendation as is.
Taken Modified	You decided to overwrite the Oracle Retail markdown recommendation and instead enter your own markdown price. This status applies to all items, regardless of whether or not they are members of a group.
Taken Item Rec	You decided to take the recommended markdown for the item instead of the recommended markdown for the group to which the items belongs.
Taken Pricing Grp Rec	You decided to the markdown that was recommended for the entire group instead of the markdowns that were recommend for each individual item.
Taken Mixed	This applies to pricing groups only. It indicates that you decided to apply a mixed approach to taking recommendations for the items in the group, i.e., taking the recommended markdown for some, entering a modified recommendation for some, and/or not taking a markdown for some.
Budget Constrained	You used the optimize-to-budget functionality and decided to take those markdown recommendations.

Approving Decisions

You can complete the following with the worksheets to which you have access:

- Submitting Worksheets for Approval
- Approving Worksheets (requires that you have Approve access)
- Declining Worksheets (requires that you have Approve access)
- Executing Worksheets (requires that you have Approve access)

Submitting Worksheets for Approval

Before you submit a worksheet(s):

- Make sure that the worksheet(s) reflects the markdowns you want. After you submit a worksheet, you can no longer make changes to it.
- Allow enough time for the worksheet to be approved and executed. In order for the worksheet's markdowns to be reported as input into your pricing system, the worksheet must be executed before the cutoff time.

When your worksheet(s) reflect the taken markdowns (and sendback dates, if applicable) you want, submit it for approval by clicking **Submit**.

After you submit the worksheet:

- The Worksheet Summaries screen appears with a status of Submitted for the affected worksheet.

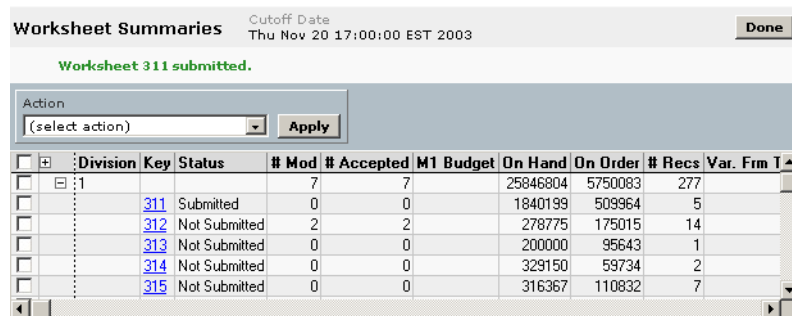

The screenshot shows the 'Worksheet Summaries' interface. At the top, it displays 'Cutoff Date: Thu Nov 20 17:00:00 EST 2003' and a 'Done' button. A green message states 'Worksheet 311 submitted.' Below this is an 'Action' dropdown menu with '(select action)' and an 'Apply' button. The main part of the screen is a table with the following columns: Division, Key, Status, # Mod, # Accepted, M1 Budget, On Hand, On Order, # Recs, Var. Frm, and T. The table contains five rows of data for keys 311 through 315.

Division	Key	Status	# Mod	# Accepted	M1 Budget	On Hand	On Order	# Recs	Var. Frm	T
1	311	Submitted	7	7		25846804	5750083	277		
	312	Not Submitted	2	2		1840199	509964	5		
	313	Not Submitted	0	0		278775	175015	14		
	314	Not Submitted	0	0		200000	95643	1		
	315	Not Submitted	0	0		329150	59734	2		
			0	0		316367	110832	7		

- You can no longer make any changes to the worksheet. You can open the worksheet, but a message appears telling you that the worksheet is read-only.

Approving Worksheets

If you have Approve access to a worksheet, you can approve a worksheet after it is submitted for approval.

To approve a worksheet:

1. From the Main Menu, click **Markdowns**.
 The Worksheet Summaries screen appears.
2. From the Worksheet Summaries screen, select the check box for each worksheet you want to approve. You can approve only worksheets that have a Submitted status and for which you have Approve access.
3. From the Action list box, select **Approve** and then click **Apply**.

Worksheet Summaries		Cutoff Date Thu Nov 20 17:00:00 EST 2003			
Action					
[select action]		Apply			
[select action]					
<input type="checkbox"/>	Show Recommended Forecast	# Mod	# Accepted	On Hand	On Order
<input type="checkbox"/>	Approve Worksheet	11	11	25846804	5750083
<input type="checkbox"/>	Decline Worksheet	0	0	1840199	509964
<input type="checkbox"/>	Sort Table	6	6	278775	175015
<input type="checkbox"/>	Modify Columns	0	0	200000	95643
<input type="checkbox"/>	Print or Export	0	0	329150	59734
<input checked="" type="checkbox"/>	315 Submitted	0	0	316367	110832
<input checked="" type="checkbox"/>	316 Submitted	0	0	455369	44127
<input checked="" type="checkbox"/>	320 Submitted	0	0	451244	53643

A confirmation dialog box appears with the keys of the approved worksheets, and the status for each approved worksheet changes to Approved.

All approved worksheets are executed when the cutoff time is reached.

Declining Worksheets

If you have Approve access to a worksheet, you can decline a worksheet after it is submitted for approval.

To decline a worksheet:

1. From the Main Menu, click **Markdowns**.
 The Worksheet Summaries screen appears.
2. From the Worksheet Summaries screen, select the check box for each worksheet you want to decline. You can decline only worksheets that have a Submitted or Approved status and for which you have Approve access.

- From the Action list box, select **Decline** and then click **Apply**.

	# Mod	# Accepted	On Hand	On Order		
(select action)						
Show Recommended Forecast	11	11	25846804	5750083		
Approve Worksheet						
Decline Worksheet	0	0	1840199	509964		
Sort Table	6	6	278775	175015		
Modify Columns	0	0	200000	95643		
Print or Export	0	0	329150	59734		
<input checked="" type="checkbox"/>	315	Submitted	0	0	316367	110832
<input checked="" type="checkbox"/>	316	Submitted	0	0	455369	44127
<input checked="" type="checkbox"/>	320	Submitted	0	0	451244	53643
<input checked="" type="checkbox"/>	321	Submitted	0	0	81914	91857

A confirmation dialog box appears with the keys of the declined worksheets, and the status for each declined worksheet changes to Not Submitted. However, the worksheets retain any changes that were made to them. These worksheets must be re-submitted and approved before they can be executed.

Executing Worksheets

After worksheets have been approved and appear on the Worksheet Summaries screen, they are ready to be executed. No explicit action is required to execute the worksheets. Worksheet execution is an automatic procedure that occurs after the cutoff time is reached. The execution procedure reports all markdowns into the merchandise system.

All worksheets must be approved by the cutoff time in order to be executed. If you are working in Price close to the cutoff time, you will receive a warning message similar to the following. Any worksheets that are open at the cutoff time will not be executed.

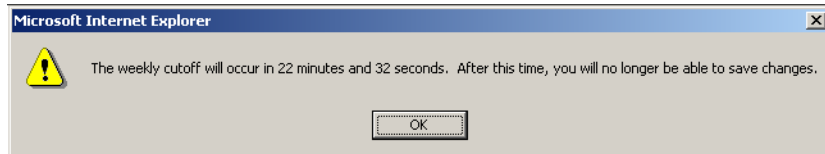

4

Managing Merchandise

This chapter includes the following information:

- “About Maintaining Merchandise” on page 138
- “About Exit Dates and Exit Date Inventory” on page 139
- “Managing Exit Dates” on page 141
- “Setting Exit Inventory or Sell-Through Targets” on page 145
- “Maintaining Pricing Groups” on page 148

About Maintaining Merchandise

You can maintain your merchandise by individual items or by pricing groups.

- Items are typically at a level in the merchandise hierarchy below the class or category level and above the color and size level. An item may also be known as a lot or a style. You can maintain the following aspects of items:
 - Change, remove, and reset (to the default values) exit dates
 - Modify item properties such as salvage value, target sell-through, and ending inventory units
- Pricing groups are sets of items that are grouped together by style, or color, or vendor, or a combination of these, or by any other merchandise attributes that are meaningful for your company. You can take the same markdown for an entire pricing group, or you can take different markdowns for each item. The outdate, target sell through, salvage value, etc., are derived from the individual item properties. With that in mind, you can maintain the following aspects of pricing groups:
 - Change, remove, and revert (to their original values) exit dates of the member items
 - Modify properties such as salvage value, target sell-through, and ending inventory units of the member items
 - Add items to the pricing group
 - Remove items from the pricing group
 - Create a new pricing group
 - Change a pricing group name

About Exit Dates and Exit Date Inventory

Typically, exit dates and exit date inventory (quantity or sell-through percent) are set by a Price administrator or Oracle Retail Professional Services at a high level in the merchandise and location hierarchies via Business Rule Property Manager. Your worksheets and key items then inherit those settings.

Exit Dates

Price does not recommend markdowns for any item without an exit date, or for any item with an exit date in the past. New items are eligible for markdown recommendations when their level in the merchandise and location hierarchy has been assigned an exit date. If you want to make items ineligible for markdown recommendations, remove the exit date from them.

Check with the Price administrator to find out what date ranges and days of the week are valid for exit dates for items and pricing groups.

For example, the Price administrator might configure a date range of 90 days from the effective date (the Saturday of the week the markdown price is effective in the stores). In this case, the exit date must be within that 90-day range. If the markdown price is implemented in the stores on 02/02/2004, the effective date is Saturday, 02/07/2004. Therefore, the exit date would have to be before 05/07/2004 to be within the 90-day range.

Similarly, if the Price administrator configures Sunday as the only day of the week that is valid for exit dates, any exit dates you enter must fall on a Sunday.

Enter exit dates and exit inventory targets 30 days prior to receipt. Each month, review the next month's receivings and provide exit dates for these items.

Changing the exit date causes inventory to be marked down more aggressively or more conservatively, depending on which direction the exit date is changed.

- Lengthening the exit date can lead to less aggressive markdowns; you have more time to sell so you might not need to lower the price as much.
- Shortening the exit date can lead to more aggressive markdowns; you have less time to sell, so you might need to make steeper price reductions.

For details on changing, resetting, and removing exit dates, see “Managing Exit Dates” on page 141.

Target Exit Date Inventory and Sell-Through Percent

Note: You can specify the number of inventory units you want remaining at the exit date, or you can specify a sell-through percent. You cannot set both. The selection – exit inventory units or exit sell-through percent – is made during the Price implementation.

Typically the Price administrator sets the exit inventory or sell-through targets when the exit date is set. The earlier the exit inventory or sell-through target is set, the more accurate the markdown recommendations will be.

Exit Date Inventory

Exit inventory is set as a percentage of the beginning inventory.

Depending on the amount of inventory:

- Lower exit inventory targets can lead to more aggressive markdown recommendations.
- Higher exit inventory targets can lead to less aggressive markdown recommendations.

Note: If no exit inventory target is provided for an item, Price assumes that the exit inventory target at the item's exit date is zero.

Sell-Through Percent

For sell-through percent:

- Lower sell-through percents can lead to less aggressive markdown recommendations.
- Higher sell-through percents can lead to more aggressive markdown recommendations.

Managing Exit Dates

For an explanation of exit dates, see “About Exit Dates and Exit Date Inventory” on page 139.

If your user account has access rights to Business Rule Property Manager, you can set exit dates for items or pricing groups anywhere on the merchandise and location hierarchy levels to which you have access.

Otherwise, you can also manage exit dates from the Maintaining Merchandise screen as follows:

- Change exit dates from their default values at or below a particular worksheet level. See “Changing Exit Dates from Their Default Values” on page 141.
- Reset changed exit dates to their default values, which are inherited from higher levels in the merchandise hierarchy. See “Resetting Exit Dates to Their Default Values” on page 143.
- Remove exit dates. See “Removing Exit Dates” on page 144.

Note: You can set exit dates only for those items and pricing groups that appear in your worksheets. If you want to set exit dates for items or pricing groups that don’t appear, check with the Price administrator about having them added.

Changing Exit Dates from Their Default Values

To set exit dates for individual items or pricing groups:

1. From the Main Menu, click **Maintaining Merchandise**.
The Maintaining Merchandise screen appears.
2. Click the tab that reflects the data view you want to work in. Sample data views include:
 - **Items By Name** - Items available at the selected hierarchy levels are listed in alphabetical order by name, with numbers appearing before letters.
 - **Items (Flat)** - Items are listed in the current sort order on the worksheet. To change this sort order, click a column heading.
 - **Pricing Groups** - Items are grouped by the pricing groups (formerly called collections) to which they were assigned.

- **Items (Aggregated)** - Merchandise is listed by the style level or some other level (depending on your implementation) instead of the item level.
3. Find the item(s) or pricing group(s) whose exit date you want to change or enter, and select the corresponding check box(es).
 4. From the Action list box, select **Change Item Prop. For Selected** and click **Apply**.

The Update Item Properties dialog box appears.

ORACLE Price Optimization About | Help

Update Item Properties Done Cancel

Uncheck the checkbox for properties you want to leave unchanged. If you select the checkbox and don't enter a value, the value of the property will be removed.

Update ST Perc Update Exit Date

Tgt ST %
[] %

Set Exit Date
Month [] Day [] Year []

5. Select the **Update Exit Date** check box, and use the Month, Day, and Year list boxes to select a new date.

The date you select must meet the restrictions set by the Price administrator. Typically, the date must fall within a range of valid dates and on a specific day of the week. (See “Exit Dates” on page 139 for an explanation.)

Important: If you are not changing the exit inventory or sell-through percent, clear the corresponding check box.

6. When the Update Item Properties dialog box reflects the settings you want, click **Done**.

A message appears that the operation was successful. Click **Done** on that message box to return to the items or pricing groups worksheet.

The new exit date appears on the items or pricing groups worksheet, and it takes effect with the following week’s recommendations.

Resetting Exit Dates to Their Default Values

Default exit dates are set by a Price administrator at a high level in the hierarchies.

To reset exit dates that you have changed or removed:

1. From the Main Menu, click **Maintaining Merchandise**.
2. Click the tab that reflects the data view you want to work in. Sample data views include:
 - **Items By Name** - Items available at the selected hierarchy levels are listed in alphabetical order by name, with numbers appearing before letters.
 - **Items (Flat)** - Items are listed in the current sort order on the worksheet. To change this sort order, click a column heading.
 - **Pricing Groups** - Items are grouped by the pricing groups (formerly called collections) to which they were assigned.
 - **Items (Aggregated)** - Merchandise is listed by the style level or some other level (depending on your implementation) instead of the item level.
3. Find the item(s) or pricing group(s) whose exit dates you want to revert back to their original values, and select the corresponding check box(es).
4. From the Action list box, select **Reset to Default** and click **Apply**.

The Reset Item Properties to Default dialog box appears.

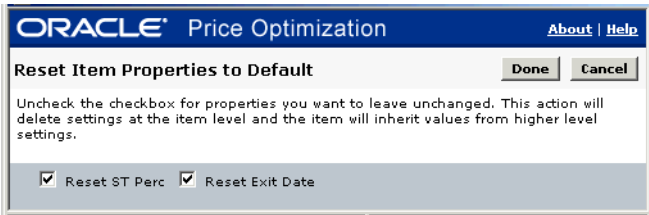

5. Make sure that the **Reset Exit Date** check box is selected.

Important: If you are not resetting sell-through percent, clear the Reset ST Perc check box.
6. When the Update Item Properties dialog box reflects the settings you want, click **Done**.

The Update Item Properties message box appears with a message that the operation was successful.

7. Click **Done** on that message box to return to the items or pricing groups worksheet.

The exit date for the selected item(s) or pricing group(s) is reverted back to the default date.

Removing Exit Dates

Removing an exit date also removes the affected item or pricing group from Price optimizations. Therefore, when you remove an exit date, Price will make no markdown recommendations. To include the item or pricing group in Price optimizations again, reset the exit date or add a new one.

To remove exit dates:

1. From the Main Menu, click **Maintaining Merchandise**.
2. Click the tab that reflects the data view you want to work in. Sample data views include:
 - **Items By Name** - Items available at the selected hierarchy levels are listed in alphabetical order by name, with numbers appearing before letters.
 - **Items (Flat)** - Items are listed in the current sort order on the worksheet. To change this sort order, click a column heading.
 - **Pricing Groups** - Items are grouped by the pricing groups (formerly called collections) to which they were assigned.
 - **Items (Aggregated)** - Merchandise is listed by the style level or some other level (depending on your implementation) instead of the item level.
3. Find the item(s) or pricing group(s) whose exit dates you want to remove, and select the corresponding check box(es).

4. From the Action menu, select **Remove Exit Dates** and click **Apply**.

The Update Item Properties message box appears with a message that the operation was successful.

5. Click **Done** on that message box to return to the items or pricing groups worksheet.

The exit date is removed, which means that Price will stop providing recommendations for the affected pricing groups and items. When you want to include these pricing groups and items in the weekly Price recommendations, change or reset the exit date. See “Resetting Exit Dates to Their Default Values” on page 143 for instructions.

Setting Exit Inventory or Sell-Through Targets

For an explanation of exit inventory and sell-through targets, see “About Exit Dates and Exit Date Inventory” on page 139.

If your user account has access rights to Business Rule Property Manager, you can set exit inventory or sell-through targets for items or pricing groups anywhere on the merchandise and location hierarchy levels to which you have access. When you use this method, the value you set at the highest level in the hierarchy is applied to the lowest level in the hierarchy until you or someone else overrides it.

Otherwise, you can also set exit inventory or sell-through targets in the following ways:

- By selecting individual items or pricing groups from a worksheet. See *Setting for Multiple Items or Pricing Groups at a Time*.
- By entering a value for one item or pricing group at a time. See *Setting for One Item or Pricing Group at a Time*.

Note: You can set exit inventory and sell-through targets only for those items and pricing groups that appear in your worksheets. If you want to set exit inventory and sell-through targets for items or pricing groups that don't appear, check with the Price administrator about having them added.

Setting for Multiple Items or Pricing Groups at a Time

To set exit inventory or sell-through targets for multiple items or pricing groups at a time:

1. From the Main Menu, click **Maintaining Merchandise**.
2. Click the tab that reflects the data view you want to work in. Sample data views include:
 - **Items By Name** - Items available at the selected hierarchy levels are listed in alphabetical order by name, with numbers appearing before letters.
 - **Items (Flat)** - Items are listed in the current sort order on the worksheet. To change this sort order, click a column heading.
 - **Pricing Groups** - Items are grouped by the pricing groups (formerly called collections) to which they were assigned.

- **Items (Aggregated)** - Merchandise is listed by the style level or some other level (depending on your implementation) instead of the item level.
3. Find the item(s) or pricing group(s) whose exit inventory or sell-through target you want to change or enter, and select the corresponding check box(es).
 4. From the Action list box, select **Change Item Prop. For Selected** and click **Apply**.

The Update Item Properties dialog box appears. The example below is from Oracle Retail Price implementation that standardized on sell-through percent rather than exit inventory.

ORACLE Price Optimization [About](#) | [Help](#)

Update Item Properties

Uncheck the checkbox for properties you want to leave unchanged. If you select the checkbox and don't enter a value, the value of the property will be removed.

Update ST Perc Update Exit Date

Tgt ST % %

Set Exit Date

Note: Depending on the Oracle Retail implementation at your site, exit inventory and sell-through percent may not be available to you.

5. Select the appropriate check box – either Update Exit Inventory or Update ST Perc – and enter a value in the corresponding text box. Using the example dialog box above, you would select **Update ST Perc** and enter a value in the **Tgt ST %** text box.

Important: If you are not changing the exit date, clear the Update Exit Date check box.

6. When the Update Item Properties dialog box reflects the settings you want, click **Done**.

A message appears that the operation was successful. Click **Done** on that message box to return to the items or pricing groups worksheet.

The new exit inventory or sell-through target appears on the items or pricing groups worksheet, and it takes effect with the following week's recommendations.

Setting for One Item or Pricing Group at a Time

To set exit inventory or sell-through targets for one item or pricing group at a time:

1. From the Main Menu, click **Maintaining Merchandise**.
2. Click the tab that reflects the data view you want to work in. Sample data views include:
 - **Items By Name** - Items available at the selected hierarchy levels are listed in alphabetical order by name, with numbers appearing before letters.
 - **Items (Flat)** - Items are listed in the current sort order on the worksheet. To change this sort order, click a column heading.
 - **Pricing Groups** - Items are grouped by the pricing groups (formerly called collections) to which they were assigned.
 - **Items (Aggregated)** - Merchandise is listed by the style level or some other level (depending on your implementation) instead of the item level.
3. Find the item or pricing group for which you want to set the exit inventory or sell-through target.
4. In the corresponding column, click and type the exit inventory or sell-through target value. Cells in which you can type value appear with a thin black border, as in the example below.

Savg Val.%	Tgt ST %
	0.00%

Note: Depending on the Price implementation at your site, exit inventory and sell-through percent may not be available to you. Further, the names of the exit inventory and sell-through percent columns may be different than those shown above.

5. Click **Save** or **Done** to save your changes.
The new exit inventory or sell-through target takes effect with the following week's recommendations.

Maintaining Pricing Groups

Maintaining pricing groups involves the following tasks:

- Creating New Pricing Groups
- Adding Items to Pricing Groups
- Removing Items from Pricing Groups
- Changing Pricing Group Names
- Deleting Pricing Groups

Creating New Pricing Groups

To create a new pricing group:

1. From the Main Menu, click **Maintaining Merchandise**.

The Maintaining Merchandise screen appears.

2. Click the tab that represents the data view you want to display.
3. From the hierarchy list boxes, select the areas to which you want to add this pricing group and click **Show**.

The current data view updates with the pricing groups in the selected hierarchy levels.

4. From the Action list box, click **Create Pricing Groups** and click **Apply**.

The Pricing Group Name dialog box appears.

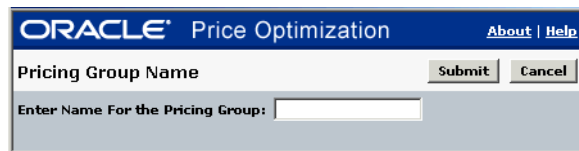

The screenshot shows a dialog box titled "ORACLE Price Optimization" with "About | Help" in the top right corner. The main area is labeled "Pricing Group Name" and contains a text input field with the placeholder text "Enter Name For the Pricing Group:". To the right of the input field are two buttons: "Submit" and "Cancel".

5. Enter a name for this pricing group, up to 200 characters using letters, numbers, spaces and dashes, and click **Submit**.

The Edit Pricing Groups screen appears with the new pricing group name at the top of the screen, as in the following example.

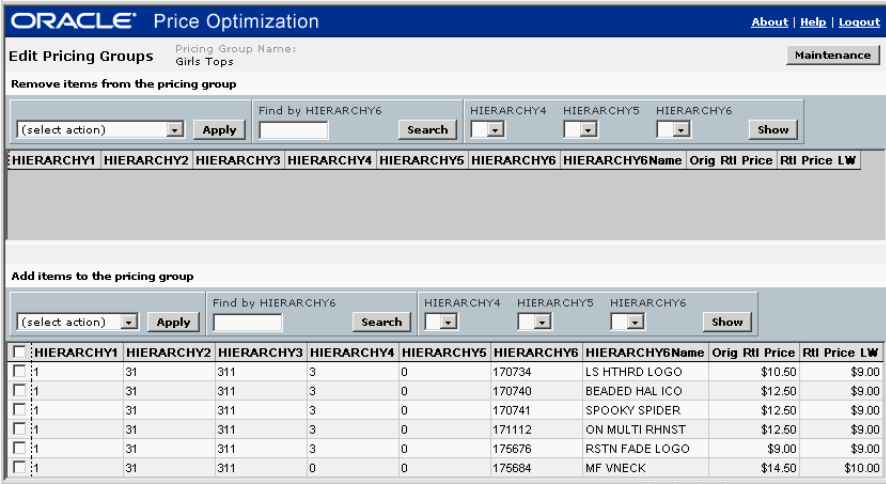

- In the bottom portion of the Edit Pricing Groups screen, select the check box for each item you want to add to the pricing group, and from the Actions list box, select **Add Items** and click **Apply**.

The item(s) you selected now appear in the top portion of the Edit Pricing Groups screen, where you can remove them from the pricing group if necessary.

- When you are finished adding items to this pricing group, click **Maintenance** to save your changes and to return to the Maintaining Merchandise screen.
- (Optional.) On the Maintaining Merchandise screen, update the exit date and exit inventory or sell-through target for each item in this pricing group. You can set these values on the item level only, not on the pricing group level.

- For exit dates, each pricing group uses the latest exit date of the items contained in the pricing group.

Important: All items must have an assigned exit date or Price will not consider the item for recommendations. However, even if one or more items in the pricing group is missing an exit date, Price will still consider the remainder of the pricing group for recommendations. (In previous releases of Price, one item without an exit date would make the entire pricing group ineligible for markdown recommendations.)

- For exit inventory, each pricing group uses an adjusted exit inventory target that is calculated based on each item’s individual target.

The alternative is to let the pricing group inherit the exit date and exit inventory or sell-through target as they are set in the business rules. See “About Exit Dates and Exit Date Inventory” on page 139 for more information.

Adding Items to Pricing Groups

To add items to a pricing group:

1. From the Main Menu, click **Maintaining Merchandise**.
 The Maintaining Merchandise screen appears.
2. Click the tab that represents the data view you want to display.
 In most cases you will probably select the Pricing Groups tab (or its equivalent), but you can also access the edit pricing groups link from the items views.
3. From the list boxes, select the hierarchy levels to display pricing groups (or items) and click **Show**.
4. For the pricing group (or item) to which you want to add items, click the **edit** link. The edit link is in the next to the last column in the same row as the pricing group (or item), as in the following example:

<input type="checkbox"/>	HIERARCHY6Name	Proj Sales \$ EOL	Proj ST% EOL	Total Buy	Target ST% EOL	New Sell Thru %	Target OH EOL	Effective Date	
<input type="checkbox"/>	Girls Tops - Logos	\$785,667	91.98%	97201	75%	75.00%	7,793	11/04/2002	edit
<input type="checkbox"/>	Girls Tops - Rhinestone	\$709,066	83.28%	100589	75%	75.00%	16,823	11/04/2002	edit
<input checked="" type="checkbox"/>		\$668,919	79.62%	81993	75%	75.00%	16,795	11/04/2002	

The Edit Pricing Groups screen appears.

5. In the bottom portion of the Edit Pricing Groups screen, click the check box of each item you want to add to this pricing group, and from the Actions list box,

select **Add Items** and click **Apply**.

Add items to the pricing group

		Find by HIERARCHY6		HIERARCHY4	HIERARCHY5	HIERARCHY6				
(select action) ▾		Apply		Search	▾	▾	▾	Show		
<input checked="" type="checkbox"/>	:1	31	311	3	0	170734	LS HTHRD LOGO	\$10.50	\$9.00	
<input type="checkbox"/>	:1	31	311	3	0	170740	BEADED HAL ICO	\$12.50	\$9.00	
<input type="checkbox"/>	:1	31	311	3	0	170741	SPOOKY SPIDER	\$12.50	\$9.00	
<input type="checkbox"/>	:1	31	311	3	0	171112	ON MULTI RHNST	\$12.50	\$9.00	
<input checked="" type="checkbox"/>	:1	31	311	3	0	175676	RSTN FADE LOGO	\$9.00	\$9.00	
<input type="checkbox"/>	:1	31	311	0	0	175684	MF VNECK	\$14.50	\$10.00	

The item(s) you selected now appear in the top portion of the Edit Pricing Group screen (as in the example below).

ORACLE Price Optimization About | Help | Logout

Edit Pricing Groups Pricing Group Name: Girls Tops Maintenance

Remove items from the pricing group

		Find by HIERARCHY6		HIERARCHY4	HIERARCHY5	HIERARCHY6				
(select action) ▾		Apply		Search	▾	▾	▾	Show		
<input type="checkbox"/>	:1	31	311	3	0	170734	LS HTHRD LOGO	\$10.50	\$9.00	
<input type="checkbox"/>	:1	31	311	3	0	175676	RSTN FADE LOGO	\$9.00	\$9.00	

Add items to the pricing group

		Find by HIERARCHY6		HIERARCHY4	HIERARCHY5	HIERARCHY6				
(select action) ▾		Apply		Search	▾	▾	▾	Show		
<input type="checkbox"/>	:1	31	311	3	0	170740	BEADED HAL ICO	\$12.50	\$9.00	
<input type="checkbox"/>	:1	31	311	3	0	170741	SPOOKY SPIDER	\$12.50	\$9.00	
<input type="checkbox"/>	:1	31	311	3	0	171112	ON MULTI RHNST	\$12.50	\$9.00	
<input type="checkbox"/>	:1	31	311	0	0	175684	MF VNECK	\$14.50	\$10.00	

- When you are finished adding items to this pricing group, click **Maintenance** to save your changes and to return to the Maintaining Merchandise screen.

Removing Items from Pricing Groups

To remove items from a pricing group:

1. From the Main Menu, click **Maintaining Merchandise**.

The Maintaining Merchandise screen appears.

2. Click the tab that represents the data view you want to display.

In most cases you will probably select the Pricing Groups tab (or its equivalent), but you can also access the edit pricing groups link from the items views.

3. From the list boxes, select the hierarchy levels to display pricing groups (or items) and click **Show**.
4. For the pricing group from which you want to remove items, click the edit link. The edit link is in the next to the last column in the same row as the pricing group, as in the following example:

	HIERARCHY6Name	Proj Sales \$ EOL	Proj ST% EOL	Total Buy	Target ST% EOL	New Sell Thru %	Target OH EOL	Effective Date	
<input type="checkbox"/>	Girls Tops - Logos	\$786,667	91.98%	97201	75%	75.00%	7,793	11/04/2002	edit delete
<input type="checkbox"/>	Girls Tops - Rhinestone	\$709,066	83.28%	100589	75%	75.00%	16,823	11/04/2002	edit delete
<input type="checkbox"/>		\$668,919	79.52%	81993	75%	75.00%	16,795	11/04/2002	

The Edit Pricing Groups screen appears.

5. In the top portion of the Edit Pricing Groups screen, click the check box of each item you want to remove from this pricing group, and from the Actions list box, select **Remove Items** and click **Apply**.

The item(s) you selected now appear in the bottom portion of the Edit Pricing Groups screen, where you can add them to other pricing groups if necessary.

6. When you are finished removing items from this pricing group, click **Maintenance** to save your changes and to return to the Maintaining Merchandise screen.

Changing Pricing Group Names

To change a pricing group name:

1. From the Main Menu, click **Maintaining Merchandise**.
The Maintaining Merchandise screen appears.
2. Click the tab that represents the data view you want to display.
In most cases you will probably select the Pricing Groups tab (or its equivalent), but you can also access the edit pricing groups link from the items views.
3. From the list boxes, select the hierarchy levels to display pricing groups (or items) and click **Show**.
4. For the pricing group whose name you want to change, click the edit link. The edit link is in the next to the last column in the same row as the pricing group, as in the following example:

<input type="checkbox"/>	<input type="checkbox"/>	HIERARCHY6Name	Proj Sales \$ EOL	Proj ST% EOL	Total Buy	Target ST% EOL	New Sell Thru %	Target OH EOL	Effective Date	
<input type="checkbox"/>	<input type="checkbox"/>	Girls Tops - Logos	\$785,667	91.98%	97201	75%	75.00%	7,793	11/04/2002	edit delete
<input type="checkbox"/>	<input type="checkbox"/>	Girls Tops - Rhinestone	\$709,066	83.28%	100589	75%	75.00%	16,823	11/04/2002	edit delete
<input type="checkbox"/>	<input type="checkbox"/>		\$668,919	79.52%	81983	75%	75.00%	16,795	11/04/2002	

The Edit Pricing Groups screen appears.

5. In the top portion of the Edit Pricing Groups screen, from the Actions list box, select **Specify Pricing Group Name** and click **Apply**.

The Pricing Group Name dialog box appears.

ORACLE Price Optimization [About](#) [Help](#)

Pricing Group Name

Enter Name For the Pricing Group:

6. Type a new name for this pricing group and click **Submit**. The name can be up to 200 characters. Valid characters are letters, numbers, spaces, and dashes (-).
The name of the pricing group is updated and appears at the top of the Edit Pricing Groups screen.

- Click **Maintenance** to return to the Maintaining Merchandise screen.

Deleting Pricing Groups

To delete a pricing group:

- From the Main Menu, click **Maintaining Merchandise**.
 The Maintaining Merchandise screen appears.
- On the Maintaining Merchandise screen, click the **Pricing Groups** tab (or its equivalent).
 The Pricing Groups tab appears.
- Select the hierarchy levels for the pricing group you want to delete and click **Show**.
- For the pricing group you want to delete, click the **delete** link. The delete link is in the last column in the same row as the pricing group, as in the following example:

ORACLE Price Optimization													About Help Logout Main Menu							
Maintaining Merchandise											Cutoff Date 05/25/2006 5:00 PM		Save Done							
Items By Name													Items (Flat)		Pricing Groups					
Action													HIERARCHY1		HIERARCHY2		HIERARCHY3			
[select action]													1		31		311		Show	
HIERARCHY4													HIERARCHY5		HIERARCHY6					
																	Show			
<input type="checkbox"/>	<input type="checkbox"/>	HIERARCHY6Name	Proj Sales	\$ EOL	Proj ST%	EOL	Total Buy	Target ST%	EOL	New Sell Thru %	Target OH	EOL	Effective Date							
<input type="checkbox"/>	<input type="checkbox"/>	Girls Tops - Logos	\$785,867		91.98%		97201		75%	75.00%	7,793		11/04/2002	edit	delete					
<input type="checkbox"/>	<input type="checkbox"/>	Girls Tops - Rhinestone	\$709,066		83.28%		100589		75%	75.00%	16,823		11/04/2002	edit	delete					
<input type="checkbox"/>	<input type="checkbox"/>		\$668,919		79.62%		81993		75%	75.00%	16,795		11/04/2002							

A confirmation dialog box appears asking if you want to delete this pricing group.

- Click **OK** to delete the pricing group.

The pricing group is removed from the list of pricing groups. Note, however, that the items in the pricing group are not deleted; they are still available to be added to other pricing groups, if necessary.

5

Managing Worksheets

This chapter includes the following information:

- “Displaying Columns” on page 156
- “Hiding Columns” on page 157
- “Reordering Columns” on page 158
- “Creating Columns” on page 159
- “Editing Columns” on page 161
- “Deleting Columns” on page 163
- “Definition for Column dialog box” on page 164
- “Sorting Data” on page 166
- “Filtering Data” on page 167
- “Exporting Data” on page 169
- “Printing Data” on page 170
- “Items which satisfy the selected alert screen” on page 171

Displaying Columns

You can display existing, previously defined columns. If you want to create a column, see “Creating Columns” on page 159.

To display a column on a worksheet:

1. From the Main Menu, click **Markdowns** or **Maintaining Merchandise** and navigate to the worksheet you want to work with.
2. From the Action list box, click **Modify Columns** and click **Apply**.

The Customize Table dialog box appears.

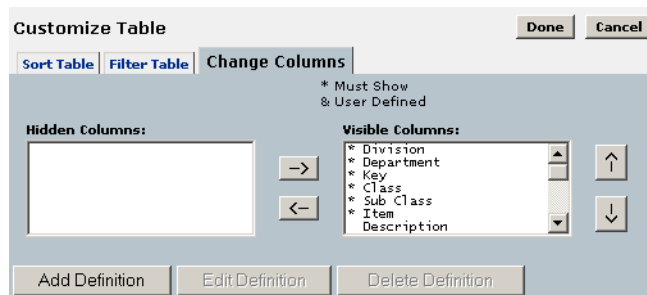

3. From the Hidden Columns list box, click the name of the column you want to display on your worksheet.

If no columns are listed in the Hidden Columns list box, all of the columns defined for this worksheet are already visible.

4. When the column you want to display is selected, click the right arrow button to move the column to the Visible Columns list box.

The column is added to the bottom of the Visible Columns list.

5. If you want to reposition the column, click the column name and click the up arrow button to move the column up or the down arrow button to move the column down.
6. Repeat steps 3 through 5 until you have added and repositioned all of the necessary columns, and then click **Done**.

The Customize Table dialog box closes and the worksheet updates with the columns you just added.

Hiding Columns

Hiding columns is a convenient way to customize your worksheets to show only the data you are interested in. You can hide almost all columns except for those designated by an asterisk (*) on the Customize Table dialog box.

To hide columns on a worksheet

1. From the Main Menu, click **Markdowns** or **Maintaining Merchandise** and navigate to the worksheet you want to work with.
2. From the Action list box, click **Modify Columns** and click **Apply**.

The Customize Table dialog box appears.

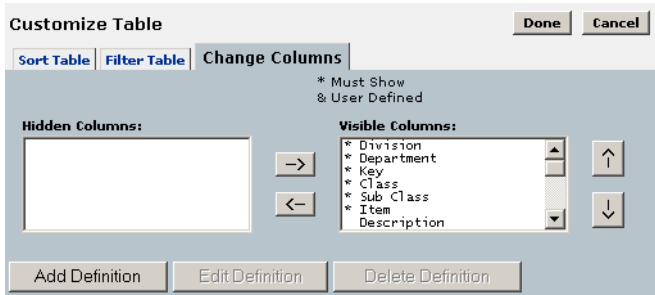

3. From the Visible Columns list box, click the name of the column you want to remove from your worksheet.
You cannot hide columns designated with an asterisk (*).
4. When the column you want to hide is selected, click the left arrow button to move the column to the Hidden Columns list box.
5. Repeat steps 3 and 4 until you have listed all of the columns you want to hide, and then click **Done**.

The Customize Table dialog box closes and the worksheet updates without the columns you just hid.

Reordering Columns

You can customize all of your worksheets by positioning the columns in the order that is most relevant to you.

To reorder columns on your worksheet:

1. From the Main Menu, click **Markdowns** or **Maintaining Merchandise** and navigate to the worksheet you want to work with.
2. From the Action list box, click **Modify Columns** and click **Apply**.

The Customize Table dialog box appears.

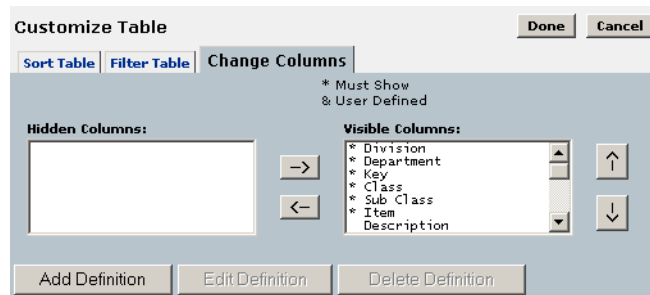

3. In the Visible Columns list box, click the name of the column you want to reposition on your worksheet.
4. When the column you want to reposition is selected, click the up arrow button to move the column up in the list, or click the down arrow button to move the column down in the list.
5. Repeat steps 3 and 4 until the columns are listed in the order you want, and then click **Done**.

The Customize Table dialog box closes and the worksheet updates with the new order of columns.

Creating Columns

If you want a value that is not already provided by the existing columns, you can create a new column that produces a value from one or more columns. For example, you may want the value of total inventory for a given item or pricing group. In this case, you could create a new column called Total Inventory that sums the values of the On Hand inventory column and the On Order inventory column.

The columns you add are available to your login only; they are not available to other Price users. In addition, the columns you add are specific to worksheet types. For example, if you add the Total Inventory column to the Worksheet Summaries worksheet, that column is not available to the pricing groups worksheets. However, if you add a column to a pricing groups worksheet, that column is available to all pricing groups worksheets to which you have access.

To create a column:

1. From the Main Menu, click **Markdowns** or **Maintaining Merchandise** and navigate to the worksheet to which you want to add a column.
2. From the Action list box, click **Modify Columns** and click **Apply**.

The Customize Table dialog box appears.

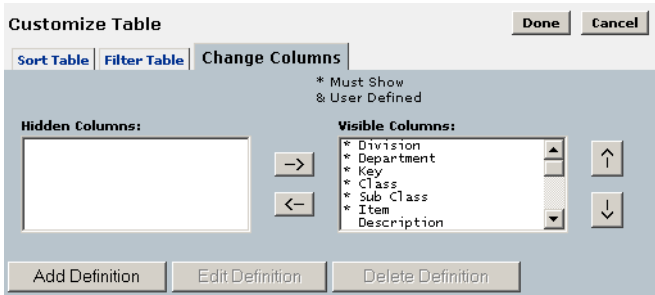

3. Click **Add Definition**.

The Definition for Column dialog box appears.

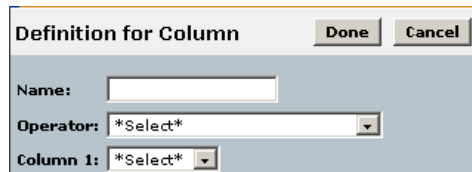

The image shows a dialog box titled "Definition for Column". At the top right of the dialog are two buttons: "Done" and "Cancel". Below the title bar, there are three input fields. The first is labeled "Name:" and is an empty text box. The second is labeled "Operator:" and is a dropdown menu with the text "*Select*" and a downward arrow. The third is labeled "Column 1:" and is also a dropdown menu with the text "*Select*" and a downward arrow.

4. Complete the “Definition for Column dialog box”, explained on page 164.
5. When the definition for your new column is complete, click **Done**.

The Definition for Column dialog box closes, and the column you just created appears in the Hidden Columns list. The column name is preceded by an ampersand (&) to indicate that it is a user-defined column.

6. On the Customize Table dialog box, select the column in the Hidden Columns list and click the right arrow button to move it to the Visible Columns list.

The column is added to the bottom of the Visible Columns list.

7. If necessary, reposition the new column by clicking the up and down arrows, and then click **Done**.

The Customize Table dialog box closes and the worksheet updates with the column you just created. The column is populated automatically.

Editing Columns

You can edit only columns that you have created, which are called user-defined columns and which are designated by an ampersand (&) preceding the column name on the Customize Table dialog box. You cannot edit the existing columns supplied by Price.

To edit columns:

1. From the Main Menu, click **Markdowns** or **Maintaining Merchandise** and navigate to the worksheet for which you want to edit a column.
2. From the Action list box, click **Modify Columns** and click **Apply**.

The Customize Table dialog box appears.

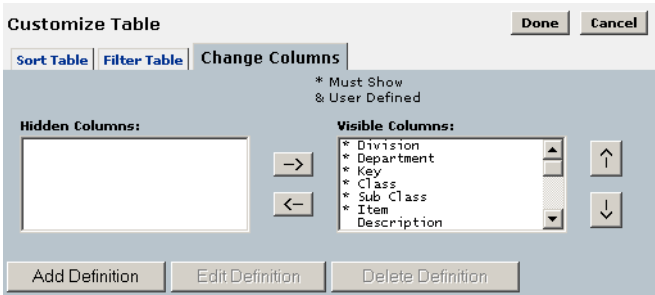

3. In the Hidden Columns list box or the Visible Columns list box, select the column you want to modify. You can edit only those columns whose names are preceded by an ampersand (&).
4. Click **Edit Definition**.

The Definition for Column dialog box appears, as in the example below.

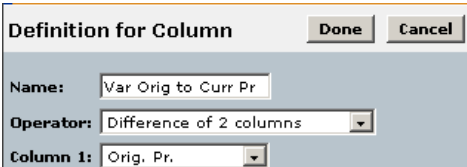

5. Update the “Definition for Column dialog box”, explained on page 164, as necessary.

6. When your changes are complete, click **Done**.

The Definition for Column dialog box closes, and the updated column remains in its original position on the Customize Table dialog box.

7. If necessary, move or reposition the column on the Customize Table dialog box, and click **Done**.

The Customize Table dialog box closes and the worksheet updates with the column you just modified.

Deleting Columns

You can delete only columns that you have created, which are called user-defined columns and which are designated by an ampersand (&) preceding the column name on the Customize Table dialog box.

To delete columns:

1. From the Main Menu, click **Markdowns** or **Maintaining Merchandise** and navigate to the worksheet from which you want to delete a column.
2. From the Action list box, click **Modify Columns** and click **Apply**.

The Customize Table dialog box appears.

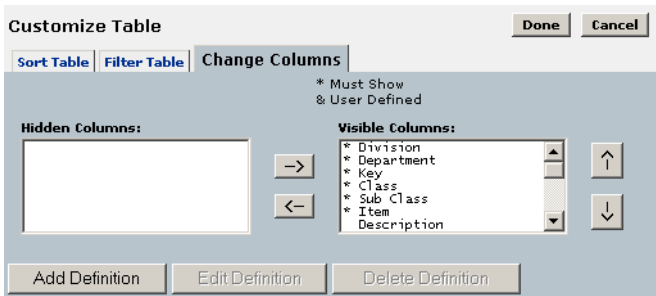

3. In the Hidden Columns list box or the Visible Columns list box, select the column you want to delete. You can delete only those columns whose names are preceded by an ampersand (&).
4. Click **Delete Definition**.

A confirmation dialog box appears, as in the example below.

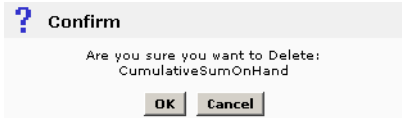

5. Click **OK** to delete the column.

The column is removed from the Customize Table dialog box. If you want to use this column again, you must recreate it.

Definition for Column dialog box

Use the Definition for Column dialog box to create a new user-defined column or to modify an existing user-defined column.

Field	Description
Name text box	<p>Enter the name of this column as you want it to appear on the worksheet. The size of the worksheet column will expand to fit the name.</p> <p>Use only letters and digits in the column name - no spaces or special characters.</p>
Operator list box	<p>Select one of the following:</p> <ul style="list-style-type: none">• Sum of 2 columns to add two columns. For example, you might want to add the On Hand inventory column and the On Order inventory column to show the total of all inventory that will be available for selling.• Difference of 2 columns to subtract one column from another. For example, you might want to see the difference between the Orig. Price column and the Rec. Price column to show the dollar amount by which the item has been reduced.• Ratio of 2 columns to divide two columns. For example, you might want to divide the On Hand inventory column by the On Order inventory column to produce of ratio of how much inventory is in stock to how much inventory you expect to arrive.• Cumulative sum of a column to show running (or incremental) totals. For example, you may want to see how the value of on hand inventory increases for each pricing group.
Column 1 list box	<p>Select the column appropriate for the operator that you selected. Make sure that you select only columns with numerical data; for example, the Status and Description columns cannot be calculated.</p>

Field	Description
Column 2 list box	If you selected Cumulative sum of a column as the operator, the Column 2 list box is disabled. Otherwise, select the column appropriate for the type of operation you selected.

Sorting Data

Sorting data allows you to display data in a specific order, such as highest to lowest gross margin and lowest to highest opportunity cost. By default, columns are sorted by opportunity cost.

To sort data:

1. From the Main Menu, click **Markdowns** or **Maintaining Merchandise** and navigate to the worksheet whose data you want to sort.
2. From the Action list box, click **Sort Table** and click **Apply**.

The Customize Table dialog box, Sort Table tab appears. The following example shows three sort criteria. (If the filter action is available for the worksheet, the Filter Table tab also appears on this dialog box.)

	A - Z	Z - A
Sort by: On Hand	<input checked="" type="radio"/>	<input type="radio"/>
Then by: On Order	<input checked="" type="radio"/>	<input type="radio"/>
Then by: Oppty. Cost	<input checked="" type="radio"/>	<input type="radio"/>

3. Enter sort criteria as follows:
 - a. Select a column from the first list box. This column becomes the primary sort column for the worksheet.
 - b. For that column, select a sort order, either ascending order (A - Z or 1 - 10) or descending order (Z - A or 10 - 1).
 - c. If you want the worksheet to be sorted by additional columns, select a column and sort order for the remaining two list boxes.
4. When the list boxes and sort order reflect the way you want the worksheet to be sorted, click **Done**.

The Customize Table dialog box closes, and the worksheet is updated to display data in the sort order you selected.

To remove one or more of the sort criteria, click ***Select*** from the list boxes and then click **Done**.

Filtering Data

Filtering allows you to display a subset of data that meets the criteria you define (such as Current Retail > \$10.00). You can filter by item and grouping attributes, or by using multiple criteria.

- Filtering by Columns
- Filtering by Merchandise Hierarchy

Filtering by Columns

To filter data by column, independent of the merchandise hierarchy:

1. From the Main Menu, click **Markdowns** or **Maintaining Merchandise** and navigate to the worksheet whose data you want to filter.
2. From the Action list box, click **Filter Table** and click **Apply**.

Note: The Filter Table action is not available on all worksheets.

The Customize table dialog box, Filter Table tab appears. The following example shows two filters already created.

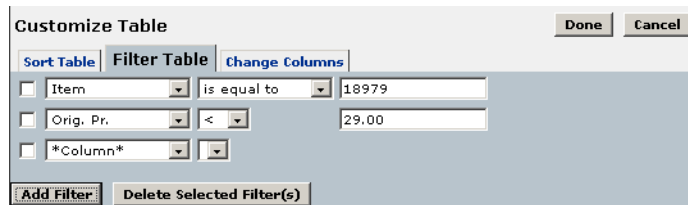

3. Add a filter as follows:
 - a. Click **Add Filter**. A new *Column* list appears.
 - b. From the *Column* list, select the column you want to filter by.
 - c. In the middle list box, select an operator (less than, less than or equal to, equal to, greater than, greater than or equal to).
 - d. In the text box, type a value appropriate for the data you want to filter.
4. Repeat step 3 until you have added the necessary number of filters, and then click **Done**. (The check boxes to the left of the *Column* lists apply only to the Delete Selected Filter(s) button; they do not affect which filters are used on the

current grid.)

The Customize Table dialog box closes, and the worksheet appears with data based on the filters you defined. In addition, the following message appears at the top of the screen:

This table has been filtered. Not all rows are visible.

To remove one or more of the filters, click the check box next to the filter(s) you want to remove, click **Delete Selected Filter(s)**, and then click **Done**.

Filtering by Merchandise Hierarchy

To filter data by the merchandise hierarchy:

1. From the Main Menu, click **Markdowns** or **Maintaining Merchandise** and navigate to the worksheet whose data you want to filter.
2. From the merchandise hierarchy drop-down lists, select Class, Sub Class, and Item (or whatever the equivalent is for your implementation of Price), depending on the level of data you want to display.

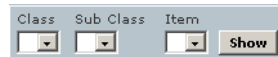

3. When the merchandise hierarchy filters reflect the level of data you want to display, click **Show**.

The worksheet appears with only the merchandise that meets the criteria you selected.

Exporting Data

You can export data from most Price worksheet or maintenance grids into Microsoft Excel 2000 or newer.

To export data from worksheets:

1. From the Main Menu, click **Markdowns** or **Maintaining Merchandise** and navigate to the worksheet whose data you want to export.
2. On the resulting screen, filter the worksheet or merchandise grid, expand/collapse rows, and show/hide columns to reflect the data you want to export. Only visible data is exported.
3. From the Action list box, click **Print or Export** and click **Apply**.

The following appears:

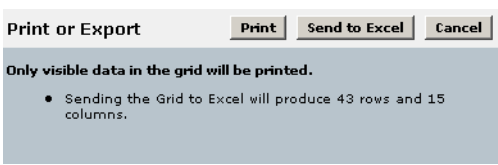

4. Click **Send to Excel**.

A message box appears with an Export Complete message followed by the path and file name of the Excel file. Additionally, an Excel spreadsheet file with the exported data opens in a new browser window.

If an error message appears instead, see “Price Problems and Solutions” on page 188.

Printing Data

You can print from most Price screens, including worksheets, merchandise, and business rules grids.

To print a worksheet:

1. From the Main Menu, click **Markdowns**, **Maintaining Merchandise**, or **Business Rule Property Manager** and navigate to the worksheet you want to print, or use filters to list the merchandise or business rules you want to print.
2. On the resulting screen, filter the worksheet, merchandise, or business rules grid, expand/collapse rows, and show/hide columns to reflect the data you want to print. Only visible data is printed.
3. From the Action list box, click **Print or Export** and click **Apply**.

The following appears:

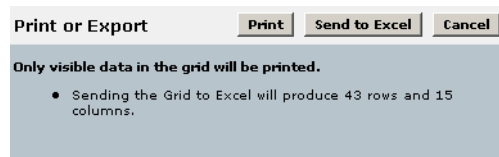

4. Click **Print**.

A print dialog box appears. This dialog box is part of your operating system and not Price.

5. Adjust the options on the dialog box as necessary and click **OK**.

Items which satisfy the selected alert screen

The Items which satisfy the selected alert screen appears when you click a hierarchy level in the Merchant Desktop Alerts component (View Details column). This screen lists the items that caused the alert.

This screen is for context only; you cannot make changes to this screen, but you can go directly to the corresponding worksheet by clicking the **View Worksheet** button. On the worksheet, you can make the changes necessary for the alerted items.

Important: For the “buy more” alert type, the Items which satisfy the selected alert screen displays the items that have triggered alert, but the worksheet that appears when you click View Worksheet does not. This is because worksheets are intended to display only items that have been recommended for a markdown, and an item that is recommended for a markdown is not a candidate for more orders. Thus, to view these non-recommended items on the worksheet, you must add them following this procedure, “Editing Worksheets” on page 81

As with all Price screens, the Items which satisfy the selected alert screen is typically customized for your company, and it is typically unique for each alert, as explained next.

Column	Description
Benefit	The approximate amount in dollars that you could make or lose on the selected items
Rec Units	The approximate number of units you need to buy or sell/cancel orders for
% Time OOS	The projected time you will be out of this item, expressed as a percentage of the number of weeks in the life cycle This is specific to the “buy more” alert type.
WOE	Weeks out early - The projected number of weeks (from the planned out date) that the item will sell out early This is specific to the “buy more” alert type.

Column	Description
WOS	Weeks of supply - The projected number of weeks of remaining supply This is specific to the “buy more” alert type.
Sls Units LW	The number of units sold last week
Excess Inv	Excess inventory - The projected number of units that will be left at the out date This is specific to the “cancel orders” alert.
% Inv Rem	Percent inventory remaining - The percentage of life cycle inventory (sold, on hand, and on order) that will be available at the out date This is specific to the “cancel orders” alert.
Sales Units LT D	The number of units sold to date
Out Date	The planned out date, i.e., the one originally set for this item
Proj Out Date	The projected out date if you make none of the recommended changes
MU %	The initial mark up per item. This is useful in determining the per-item profitability behind the recommendation. For example: <ul style="list-style-type: none"> • If the MU is 5%, there is not a much room for markdowns or promotions in the future. • If the MU is 60%, there is more flexibility in how the item can be cleared later.
Vendor	The vendor that supplied the item. This is useful because you can determine which items you can return to the vendor.

6

Reviewing Reports

This chapter includes the following information:

- “About Standard Reports” on page 174
- “Creating Standard Reports” on page 176
- “Accessing Standard Reports” on page 179
- “Deleting Standard Reports” on page 181
- “About Enhanced Reporting” on page 182
- “Accessing Enhanced Reports” on page 183
- “Opening Enhanced Reports” on page 184

About Standard Reports

Note: Additional, enhanced reports are available if you are using the Merchant Desktop feature. For details, see “About Enhanced Reporting” on page 182.

Price includes a reporting feature that lets you view data in ways that are not available in the worksheets. For example, you may want to view data similar to that in the worksheets, but you may want to view it across multiple worksheets.

The reports that are available to you are determined during the Price implementation. In some cases, there may be several pre-defined custom reports. In other cases, there may be just a few standard reports. This documentation references the two sample reports listed below. (These are sample reports, and they may not be available in the implementation of Price at your company.)

- **Sample MD Analysis report** – This report provides you with information to assess how markdowns are being implemented throughout departments. It includes items, pricing information (e.g., original, current ticketed, recommended), inventory information (e.g., on hand and on order), and financial summary metrics.
- **Sample Price Change report** – This report provides you with information for your pricing system. It includes a list of changed prices (current ticketed price and recommended ticketed price) for the current week and selected departments.

From each of the reports available to you, you create a report that you customize with the departments (and possibly other metrics, depending on the Price implementation) that you are interested in.

Each report you create represents data for the week in which you created it. When new data is available, just create another report.

All reports are in Microsoft Excel format.

For more information on reports, see:

- “Creating Standard Reports” on page 176
- “Accessing Standard Reports” on page 179
- “Deleting Standard Reports” on page 181

Understanding Dates in Reports

Several dates determine when items are first eligible to be include in Price optimization engine runs.

- First receipt date - In general terms, this date marks when activity for an item is first significant (e.g., Price will start tracking data activity). However, this date is supplied by your company, and its meaning depends on your company's implementation of Price. For example, a receipt date could indicate that an item number is being reused whereas no receipt date could indicate a new item number.
- Planned start date - The date that your company intends on selling the inventory.
- First inventory date - The date the inventory first appears in the stores. At this point, zero sales on reports indicates that the item is not selling rather than that the item is not available.
- First sale date - The date on which an item is first sold. This date is significant to you in reports because all life-to-date metric start with this date.
- Optimization (model) start date - (formerly called land date) The first date at which an item is considered available for sale. This date can be determined in a variety of ways, depending on how Price is configured for your company; it is not necessarily the same as the first sale date.

Creating Standard Reports

To create a report, you always start with the standard, custom, or sample reports (the terminology varies, depending on your site) provided by Price. Think of these reports as report templates that you customize with the information you want to include.

For example, you might use a Sample MD Analysis report to create two types of reports – one that includes only those departments for which you are responsible, and one that includes those departments and other similar departments for comparison purposes.

To create your reports:

1. From the Main Menu, click **Reports**.

The Reports page appears, as in the following example:

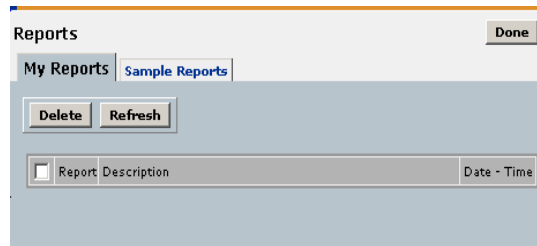

2. Click **Sample Reports** (this tab may be labeled Standard Reports or Run Reports or something else).

The Sample Reports appears, as in the following example

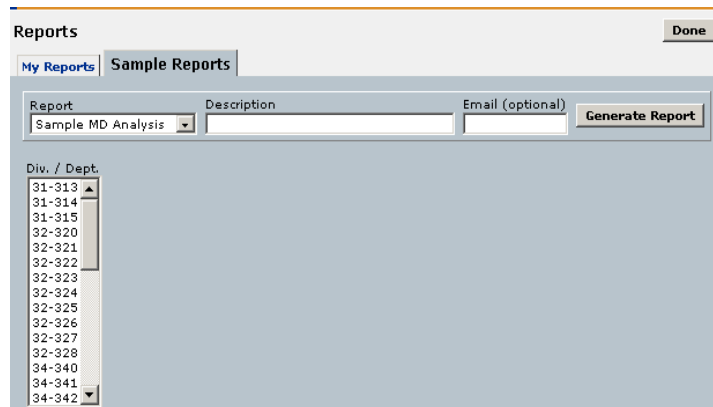

3. Complete the Sample Reports screen as follows:

- a. From the Report list box, select a report.

Depending on the report you select and depending on the Price implementation at your site, one or more options may appear.

- b. Select from any of the options that appear. In addition to the division and department list box, there may be options for including subtotals or for further filtering the data by category, class, etc.
- c. In the Description text box, enter a brief description for this report, such as the divisions and departments that are represented, or what you intend to use the report for.

The description is important when you create multiple reports from the same sample report. Your reports will be listed by sample report name, and the description helps you to differentiate them. In addition, the description is included in the actual report, directly underneath the report name.

If you omit a description, the reporting feature creates one for you using the the divisions and departments you select.

- d. (Optional.) Enter your email address. When you enter your email address, Price sends an email to you as soon as the report is generated. The email notification is especially useful when you select large amounts of data for your report. Depending on the amount of data you selected, the report could take several minutes or more to generate.

4. When the Sample Reports reflects your choices, click **Generate Report**.

A confirmation message appears, similar to the following:

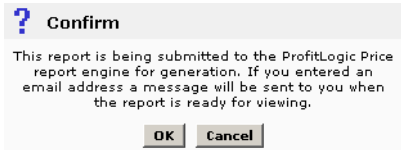

5. Click **OK** to generate the report.

If you entered your email address, Price will send a notification email to you when the report is complete.

In either case, the completed report appears in the list on the My Reports tab (or whatever name is configured for your site). To access the report, click the report name as explained in “Accessing Standard Reports” on page 179.

The reports you create are available only to your username; other users cannot access your reports. Also, your reports remain available until you delete them, as explained in “Deleting Standard Reports” on page 181. However, as new information becomes available each week, you must create new reports.

If you decide to change your report by adding or removing departments or other metrics, you must create a new report.

6. When you are finished creating reports, click **Done** to return to the Main Menu.

Accessing Standard Reports

You can access your reports any time that you have access to Price. If you haven't created any reports yet, see "Creating Standard Reports" on page 176.

To access your reports:

1. From the Main Menu, click **Reports**.

The Reports screen appears, as in the following example with some reports already created. The reports that appear on your screen will most likely have different names.

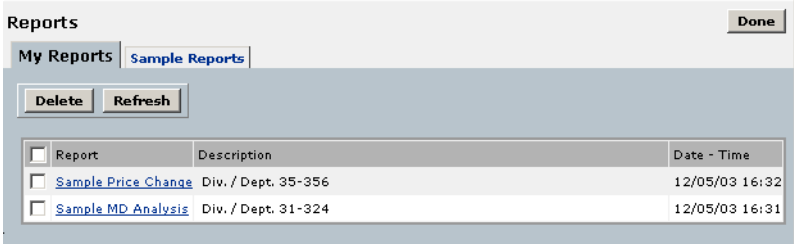

2. On the Reports screen, My Reports tab (this tab may be named differently at your site), click the name of the report you want to access.

If you created a report but it doesn't appear in the list of reports, click the **Refresh** button. This will update the list of reports to reflect all those that have been successfully generated. If the report still does not appear, it may not be generated yet. Depending on the amount data in the report, the generation can take several minutes.

If the Oracle Retail reports for your site include macros, a Microsoft Excel message appears notifying you that the report you are attempting to open contains macros. To open the report with the macros enabled, click the **Enable Macros** button.

Chapter 6
Reviewing Reports

The report appears in Microsoft Excel in a separate window, as in the following example.

	A	B	C	D	E	F	G
1							
2	Sample MD Analysis - 12/05/03 16:31						
3	Div. / Dept. 31-324						
4	Hier2 desc	Hier3 desc	Hier4 desc	Hier5 desc		Orig. Pr.	Curr. Retl.
5	GIRLS DIVISION						
6		GIRLS WOVEN ITEMS					
7			WOVEN SKIRTS				
8	GIRLS DIVISION	GIRLS WOVEN ITEMS	WOVEN SKIRTS	SHORT	14666659	\$16.50	\$16.50
9		GIRLS DENIM					
10			FASHION JEAN				
11	GIRLS DIVISION	GIRLS DENIM	FASHION JEAN	SOLID	14498259	\$22.50	\$18.00
12	GIRLS DIVISION	GIRLS DENIM	FASHION JEAN	SOLID	14498461	\$26.50	\$19.50
13	GIRLS DIVISION	GIRLS DENIM	FASHION JEAN	SOLID	14665335	\$19.50	\$19.50
14	GIRLS DIVISION	GIRLS DENIM	FASHION JEAN	SOLID	14499033	\$19.50	\$19.50
15	GIRLS DIVISION	GIRLS DENIM	FASHION JEAN	EMBELISHED	14498641	\$26.50	\$19.50
16	MENS						
17		MENS KNITS					
18			L/S KNITS				
19	MENS	MENS KNITS	L/S KNITS	SOLID	14589623	\$22.50	\$16.50
20	MENS	MENS KNITS	L/S KNITS	SOLID	14589625	\$22.50	\$16.50

3. If you want to access other reports, click the Reports screen window and click a different report. You can view multiple reports simultaneously.
4. For each open report, do any of the following:
 - Print the report by selecting **File > Print**.
 - Save the report to your computer if you want to make and save changes or send the report to a colleague. Save the report by selecting **File > Save As**.
 - Close the report by selecting **File > Close**.
5. When you are finished viewing reports, click **Done** to return to the Main Menu.

Deleting Standard Reports

When you are finished with a report, you can delete it from the list of reports on your My Reports tab (the tab may be named differently at your site). Once you delete a report, you must recreate it if you want to access it again.

To delete your reports:

1. From the Main Menu, click **Reports**.

The Reports screen appears, as in the following example with two reports already created.

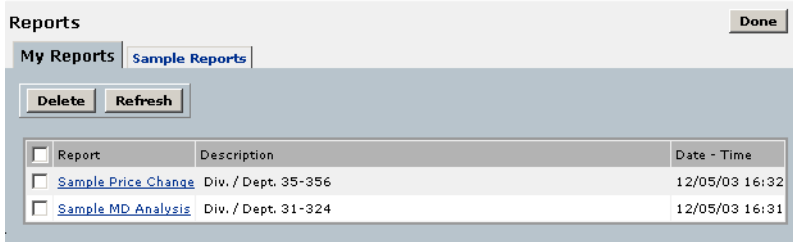

2. On the Reports screen, My Reports tab (this tab may be named differently at your site), click the check box for each report you want to delete.
3. Click **Delete**.

A confirmation message similar to the following appears.

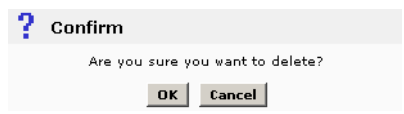

4. Click **OK**.
The selected report(s) is deleted and removed from the list of reports.
5. When you are finished deleting reports, click **Done** to return to the Main Menu.

About Enhanced Reporting

Merchant Desktop provides an enhanced reporting system that is in addition to the one available within Price. (If you are interested in the reports generated directly from Price, see “About Standard Reports” on page 174.)

The Merchant Desktop reporting system is provided by MicroStrategy Web Universal. Although you will always access reports (and graphs) from Merchant Desktop, the application that provides them is MicroStrategy Web Universal.

To access enhanced reporting, select the Reporting tab from your Merchant Desktop view. MicroStrategy Web Universal appears within the Merchant Desktop Reporting screen.

Just as access to Price is seamless, so is your access to MicroStrategy Web Universal. Once you log on to Merchant Desktop, you are logged on to MicroStrategy Web Universal.

Most of the time, you won’t notice a difference between Merchant Desktop and MicroStrategy Web Universal. The biggest difference is probably in the help systems.

Therefore, when you access reports or graphs, click the MicroStrategy help icon for information on how to subscribe to reports, customize reports, etc.

A few notes on MicroStrategy

In MicroStrategy reports and graphs, there is no way to drill back up. Instead of re-executing the graph or report, MicroStrategy recommends using the browser back button.

Using the back button is effective for most reports. However, it does not always work for reports executed from the Top/Bottom component. In some cases the Processing Request message may appear for several minutes. If this occurs, try clicking the back button twice or until the Top/Bottom component appears. Note, however, that you will have to make all of your selections again.

Another issue with MicroStrategy is when a graph first appears, it fits in the component window, but when you drill down or navigate to a different page, the graph becomes larger than the component window.

When this occurs, you must navigate to a different screen and then back to the screen that contains the graph.

If you find this happens too frequently, consider placing the graph in a larger component window. In some cases, you might even want one graph per screen, depending on the complexity of the graph.

Accessing Enhanced Reports

Merchant Desktop provides you with a variety of ways to access the enhanced reports.

- Reporting screen that displays the Share and My Reports folders. For instructions, see “Opening Enhanced Reports” on page 184.
- A screen that is named for a specific report
- A component within a screen

Initially, the only reports available to you will be in a reporting folder called Share. Only an administrator can create reports for this folder, but you can access every report in this folder.

From these shared reports, you can create your own copy of a report and save it to a folder called My Reports. Within your My Reports folder, you can create as many additional folders as necessary.

- You can copy reports and graphs, customize them, and save them to your own folder or to a share folder where other Merchant Desktop users can access them.
- You can print reports or export them to Excel or PDF format
- You can select reports and graphs for display on the “Report Component Type” on page 64 and the “Graph Component Type” on page 65.

Report Data

Updates you make to Price are updated in report data throughout the week, and then once a week the report data is updated with the results of Price optimization. Therefore, if you have executed or saved a report, it may not reflect the most current data a few days or a week later. If you are concerned about getting the most recent data, re-execute the report or ask the administrator to purge the MicroStrategy cache. Doing will ensure that report data is updated the next time you open it.

Opening Enhanced Reports

You can open reports only if the administrator has assigned the Reporting screen to your user account.

Note: The reporting system is provided by MicroStrategy Web Universal. When you access reporting, click the MicroStrategy help icon  for information on how to subscribe to reports, customize reports, etc.

To access reports:

1. From your Merchant Desktop, click the **Reporting** screen link.

Note: The first time you access reporting or any report or graph, there may be a delay before the actual reporting screen appears. If this is especially slow, inform the administrator.

The Reporting screen appears with MicroStrategy Web Universal options.

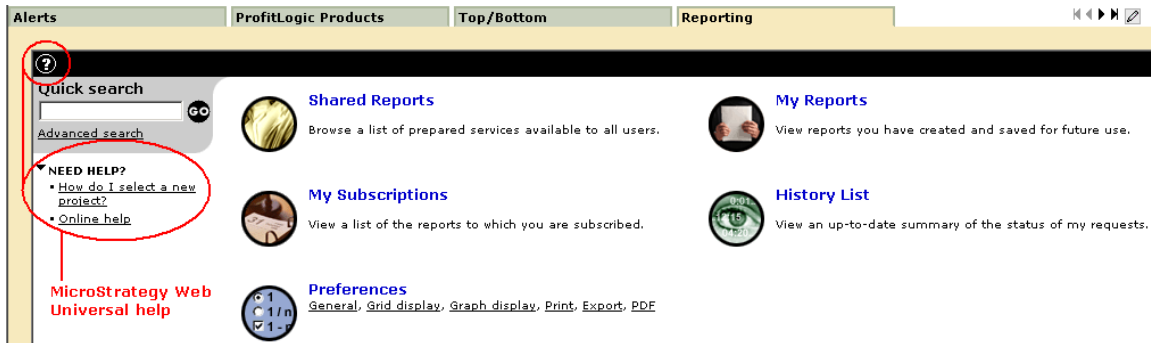

2. From the report options that appear, click one of the following links to access reports:
 - **Shared Reports** - A list of reports created by administrators and other users that they have elected to share with other Merchant Desktop users
 - **My Reports** - A list of reports that you have created
 - **My Subscriptions** - A list of reports that you have scheduled to be executed, typically on a recurring schedule

- **History List** - Depending on how the administrator has configured reporting, every report you have executed appears here, or only those reports you have selected for the history list appear here
3. Double-click the report you want to open. For information on navigating through reports, use the MicroStrategy help.

Note: If opening reports or drilling through reports is especially slow, inform the administrator.

Chapter 6
Reviewing Reports

A Troubleshooting

This appendix explains the following:

- “Price Problems and Solutions” on page 188

Price Problems and Solutions

Following are problems and solutions for Price.

Note: At the end of the table are several blank spaces for you to record problems and solutions specific to your company and customized Price implementation.

Problem	Solution
<p>You attempt to access the Price login screen, but a security warning message appears, asking if you want to install and run Service Pack 6 for Visual Basic.</p>	<p>See step 2 in “Logging on to Merchant Desktop and Price” on page 18.</p> <p>This is a normal, expected message when your PC is missing a Microsoft Common Control dialog that Price uses.</p>
<p>When you attempt to access the Price login screen, a blank screen appears instead.</p>	<p>See “ActiveX Downloads and Firewalls” on page 191.</p>
<p>After you enter your username and password and click Login, nothing happens.</p>	<p>It is possible that pop-up blocker software is prohibiting the Price main menu from appearing. Try disabling the software and then attempt to log in to Price again.</p>
<p>One or both of the following error messages occur:</p> <ul style="list-style-type: none"> • Error with Excel Initiation: ActiveX component can’t create object. - This occurs because of an Excel component that is marked as unsafe. Price does not install this component, but it does use it to export data to Excel. • Export did not succeed. The settings on your version of Internet Explorer may need to be altered to accommodate this feature. Please contact PC Support to correct this problem. - This occurs because Price requires the components to be scriptable even though not all of the components are marked as safe. 	<p>These messages indicate that the internet browser setting are incorrect for the Price zone (Local intranet or Trusted sites). To remedy this situation, follow the instructions in “Checking Your Price Browser Settings” on page 4, paying particular attention to the actual settings on the Security Settings dialog box.</p>

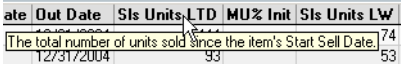
Problem	Solution
<p>Your password is no longer working</p>	<p>Passwords are case-sensitive, so make sure that the Caps Lock key has not been selected. In addition, if the administrator has changed your password or user name recently, it's possible that Internet Explorer is using the wrong stored password. This can occur when the only change in the user name or password is case.</p>
<p>You have been working in Price, but a timeout message still appears.</p>	<p>Timeout messages appear after a configured amount of time on the application server. Some of the actions you perform in the Price user interface do not communicate with the server and thus the server sends the timeout message.</p> <p>For more information, see "Understanding Timeouts" on page 22.</p>
<p>You can't figure out what some of the column names mean</p>	<p>When a column name or meaning is unclear, hold the mouse pointer of over the column name until the hover text appears, as in the example below. In most Price implementations, each column has hover text that explains the column name.</p> 
<p>The following error message appears:</p> <pre>A System error has occurred during this action. Please report this as a bug.</pre> <p>In addition, the following link appears in the upper-right corner of the screen:</p> <pre>Must define these in XActionServlet.java.</pre>	<p>At least once a week, Oracle Retail Professional Services must disable logins to Price (typically for about five minutes) so that they can synchronize markdown data. If you are using Price while the logins are disabled, this message appears.</p> <p>Just quit Price and check with an administrator or Professional Services to determine when Price will be available again.</p>

Appendix A
Troubleshooting

Problem	Solution

ActiveX Downloads and Firewalls

Sometimes ActiveX components cannot be downloaded or installed properly, even if all of the browser security settings are correct. The result is a white (blank) Internet Explorer screen when you attempt to access the Price login screen.

Two main issues can affect whether or not ActiveX components are successfully downloaded:

- Firewall restrictions
- A restriction on writing to the directory where the ActiveX components would be stored

The work around is to use a package called ActiveXInstaller.zip, which is located on the Price CD.

To use ActiveXInstaller.zip:

1. Unzip ActiveXInstaller.zip to a directory on the computer.
2. In the resulting PLActiveXInstaller folder, double-click the **ActiveXWrapper.html** file.

This opens the browser and downloads and installs the required components. When the ActiveX package is complete, you will receive a message.

3. Close the browser window and try accessing the Price login screen again.

If you still cannot access the Price login screen, try the following procedure to manually register the required ActiveX components.

To manually register the ActiveX components:

1. Obtain PLWebUI.cab from the Price CD.
2. Unzip PLWebUI.cab, which results in the following files:
PLWebUI.inf
PLWebUI.ocx
3. From a command prompt, type the following and press Enter:

```
regsvr32 PLWebUI.ocx
```

Appendix A
Troubleshooting

Glossary

access levels Access levels determine what actions you are permitted to perform on each worksheet. Price provides the following levels of access:

- View
- Submit
- Approve

blocking promotions Promotions that prevent a markdown either before, during, or after the promotion.

business rules Constraints and guidelines for making pricing and markdown decisions. Business rules may include guidelines and constraints such as the following:

- Markdowns must be at least 2 weeks apart.
- Markdowns must be at least 20% off current retail.
- Markdowns are recommended only for items with exit dates.

You cannot modify the business rules or the data that is covered by the rules. The rules and the data can be modified only as part of the implementation of Price, which is usually done by Oracle Retail Professional Services.

business rule instance The combination of the business rule and its value at the given hierarchy levels for the specified attributes.

chain level The highest level of your location hierarchy. At minimum, a typical location hierarchy consists of the chain level, a region level, and a store level.

clearance price ladder *See price ladder.*

collection *See pricing group.*

cutoff time For a certain period each week, all worksheets in Price are read-only until the following week's data is available. The beginning of this period is called the cutoff time.

dates and times *See times and dates.*

exit dates The exit date (also called the out date or the out-of-stock date) is the last day an item is scheduled to be on hand in the stores. At this date, the intent is for the item to have the specified exit inventory target transferred to an outlet or packed away for the season.

The exit date is an important factor in generating markdown decisions.

exit inventory targets The number of items specified to be remaining by the exit date. These items are then typically transferred to an outlet or packed away for the season.

item A level in the merchandise hierarchy below the class or category level and above the color and size level. An item may also be known as a lot or a style.

key A level in the merchandise hierarchy.

Glossary

location hierarchy The levels or groupings of stores in your company. Typically the levels in location hierarchies are chain, region (or zone), and store, as in the following example.

Level	Description
Highest	Chain
Middle	Region or zone
Lowest	Store

markdown recommendations The percent off that Price recommends, after applying business constraints, for applicable items or pricing groups. Price provides markdown recommendations weekly for your review, analysis, and facilitation of markdown decisions.

merchandise hierarchy The levels or groupings of product in your company, typically extending from SKU or size at the lowest level to company at the highest. The following table is an example of many levels in a merchandise hierarchy, from highest to lowest.

Level	Description
1 - Highest	Company
2	Division
3	Department
4	Category
5	Class
6	Subclass

Level	Description
7	Style
8	Lot
9	Item
10	Color
11	Size
12 - Lowest	SKU

password Your password is necessary to prevent unauthorized access to your data. Do not give your password to anyone, and if you think that someone has learned your password, change it as soon as possible.

price ladder, price-point ladder, price-percentage ladder, clearance price ladder *See also POS percent-off ticket price ladder.* A set of values that establish all possible prices for your merchandise (items and pricing groups).

A *price-point ladder* has a set of fixed prices, such as the following:

1.99
2.99
3.99
5.99
9.99

These values are called rungs.

A *price-percentage ladder* specifies percentages that are allowed as definitions for price markdowns, such as the following:

75%
67%
50%
33%
20%
10%

A *clearance price ladder* distinguishes prices with a particular decimal amount, such as the following:

0.97
1.97
2.97

If Price generates a recommended price that is not on your price ladder, Price converts the price to the next highest price in the ladder.

pricing group A set of items that are grouped together based on style, color, vendor or any combination of these and other attributes. Pricing groups can take the same markdown for the entire group, or each item within the group can take a different markdown. There are also pricing rules about pricing groups – these rules define inter-item pricing restrictions, such as a rule that markdowns must be set to the same price or percentage off.

POS percent-off ticket price ladder

See also price ladder. A list of percent-off values that can be applied to the ticket price (as opposed to the original retail price) of an item. The percent-off values are applied at POS (point of sale) and are accounted for as temporary markdowns.

promo indicators A promo indicator (“Promo”) appears next to an item to indicate that the item is recommended

for a markdown at a time that occurs either before or during an advertised promotion.

The indicator does not affect the way Price treats the item in the future; it only alerts you to potential pricing conflicts.

Promo indicators are assigned to merchandise at only the item-region level. Thus, you must expand pricing groups or chain level information in order to see them.

promotional effect The lift on items associated with markdowns and promotions in addition to the effect of simple price changes.

read-only period For a certain period each week, all worksheets in Price are read-only until the following week’s data is available. The beginning of this period is called the cutoff time.

region Typically the second level in the location hierarchy, between the chain and the store levels. Also called the zone level.

SKU Stock-Keeping-Unit. A SKU is the lowest level in the merchandise hierarchy. Typically the SKU is size, but it could be item or color.

status codes Status codes provide information about the merchandise displayed on a worksheet. Merchandise is assigned a status code to indicate that some action has been taken on it.

Status codes are assigned to merchandise only at the item region level. You must expand pricing group or chain level information in order to see a status code.

Status codes include:

Glossary

- **Added** – Assigned to any item that is added to a Worksheet, and that is not recommended for a markdown in the current week.
- **Modified** – Assigned to any item that is given a changed markdown; indicates that the markdown has been modified.

store level The lowest level in the location hierarchy, below chain and zone (region) levels.

times and dates Price handles time zones through an authoritative setting on the server and displaying the time zone explicitly whenever a time is displayed.

worksheet Grouping and display of items or pricing groups of items with associated pricing information. In Price, a worksheet is the screen on which you change markdown prices, take (or do not take) markdowns, and select items for forecasting and What-If analysis.

zone Typically the second level in the location hierarchy, between the chain and the store levels. Sometimes the zone is called the region level.

Index

A

- Accelerated markdowns 119
- Access levels 26
- Accessing
 - enhanced reports 183
 - Merchant Desktop 18
 - MicroStrategy reports 184
 - Price 18
 - standard reports 179
- Accessing Price
 - prerequisites 14
 - procedure 14
- Adding
 - screens to views 44
 - tabs to view 44
- Adding items to pricing groups 150
- Adding items to worksheets 81
- Alerts component 58
 - acting on alerts 61
 - benefit metric 59
 - buy more items do not appear on worksheet 61
 - priority icons 59
 - recommendation metric 59
- Approve access level 27
- Approved worksheet status 85
- Approving worksheets 135

B

- Benefit metric, alerts 59
- Browser settings 4
- Budget Constrained status 133

C

- Chain level
 - defined 1
- Changing colors (see Changing skins)
- Changing markdowns 116

- Changing skins 44
- Clearance price ladder (see Price ladder)
- Color schemes (see Skins)
- Colors, changing (see Skins)
- Columns
 - creating 159
 - deleting 163
 - displaying hidden 156
 - editing 161
 - hiding 157
 - reordering 158
 - repositioning 158
- Components
 - Alerts 58
 - changing colors (see changing skins)
 - composed of 52
 - customizing 49
 - defined 52
 - HTML 57
 - HTTP Links 56
 - links to web sites 56
 - list of types 52
 - News feed 54
 - placement related to screen layout 47
 - Price 63
 - renaming 49
 - repositioning 47
 - RSS feeds 54
 - web pages 57
- Creating columns 159
- Creating pricing group 148
- Creating reports 176
- Customizing components
 - general procedure 49
- Cutoff date 35
 - defined 1
 - related to approved worksheets 135

Index

D

- Decision period 35
- Declining worksheets 135
- Deleting
 - pricing groups 154
- Deleting columns 163
- Deleting pricing group 154
- Deleting reports 181
- Drag and drop
 - component positions 47

E

- Editing columns 161
- Editing worksheets 81
- Email notification for reports 177
- Emergency markdown 117
- Error in RSS News Feed 54
- Error parsing RSS NEWS FEED 54
- Errors
 - Error in RSS News Feed 54
 - Error parsing RSS NEWS FEED. 54
 - Too much data to download 54
- Excel, Microsoft
 - required for reports 174
- Executing worksheets 136
- Exit date inventory
 - effect of setting high or low 140
 - related to sell-through percent 140
 - setting 140, 145
- Exit date sell-through percent
 - effect of setting high or low 140
 - setting 140
- Exit dates
 - effect of changing 139
 - removing from items 144
 - reverting to original values 143
 - sell-through percent 140
 - setting 141
 - target inventory 140
 - when to set 139
- Exporting worksheet data 169

F

- Fit-to-budget feature (see Optimize-to-budget feature)
- Forecasts
 - viewing recommended 124

G

- Generating reports 176
- Gross margin and opportunity cost 78

H

- Help button 33
- Hidden columns
 - displaying 156
- HTML component 57
- HTML pages
 - component 57
- HTTP Links component 56

I

- Icons
 - alert priority 59
 - Merchant Desktop 33
- Internet Explorer settings 4
- Inventory
 - exit date 140
 - sell-through percent 140
- Item details, viewing 127
- Item status messages 128
- Items
 - adding to pricing groups 150
 - defined 1
 - removing from pricing groups 152
 - setting exit date inventory 145
 - setting exit dates 141
 - setting sell-through percent 145
 - viewing on worksheets 130

J

- Java Runtime Environment
 - required for Merchant Desktop 11
- JRE

required for Merchant Desktop 11

L

Levels of access to Price 26

Location hierarchy
chain level defined 1
defined 2

Logging in to Merchant Desktop 18

Logging in to Price 18

Logging on to Price 14

M

Macros in reports 179

Maintaining pricing groups 148

Markdown accounting
related to optimize-to-budget 108

Markdown budget
applying to pending markdowns 108
entering in optimize-to-budget 111

Markdown recommendations
defined 2

Markdown schedule
overriding 119
sendback date 119

Markdowns
accelerated 119
changing 116
deciding not to take 123
defined 2
from price ladder 117
removing 121
reverting 122
reviewing 78
status for taken 133
statuses 133
taking as a group 117

Maximize button 33

Merchandise hierarchy
defined 2

Merchandise, maintaining 138

Merchant Desktop
Price reports 174

Messages

item status 128

Metrics

worksheets 83

Microsoft Common Dialog control,
security warning 15

Microsoft Excel
required for reports 174

Minimize button 33

Mixed status 133

Modifying columns (see Editing
columns)

N

Names, changing for pricing groups 153

News component 54

Not submitted worksheet status 85

Not taken markdown status 133

Not Taken status 133

O

Opportunity cost 78

Optimize-to-budget feature
description 108
procedure 109
when to use 108

P

Password

case-sensitivity 15
changing 24
obtaining new 15

Pencil button 33

PL Group status 133

PL Item status 133

POS percent-off ticket price ladder 3

Price

accessing from Merchant Desktop 63
quitting 63
returning to Merchant Desktop 63

Price ladder
defined 2

Index

- selecting markdowns from 117
- Price quick reference 36
- Price schedule 35
- Price-percentage ladder
 - defined 2
- Price-point ladder
 - defined 2
- Pricing decisions
 - viewing results on worksheets 123
- Pricing groups
 - adding items 150
 - changing names 153
 - creating 148
 - defined 3
 - deleting 154
 - maintaining 148
 - removing items 152
 - setting date exit inventory 145
 - setting exit dates 141
 - setting sell-through percent 145
 - viewing on worksheets 130
- Printing worksheets 170
- Promo indicators 3
- Promotion indicators (see Promo indicators)
- Q**
- Quick reference, common tasks 36
- R**
- Read-only period 35
- Recommendation metric, alerts 59
- Recommended forecast
 - viewing 124
- Recommended Forecast page 125
- Removing
 - items from pricing groups 152
 - items from worksheets 81
 - markdowns 121
 - screens from view 43, 44
- Renaming
 - components 49
- Renaming screens 47
- Renaming tabs 47
- Reordering
 - screens in view 44
 - tabs in view 44
- Reporting
 - available from Merchant Desktop 174
- Reporting screen type 50
- Reports
 - accessing enhanced 183
 - accessing MicroStrategy 184
 - accessing standard 179
 - creating 176
 - data freshness (Users) 183
 - deleting 181
 - described 174
 - email notification 177
 - format 174
 - macros in 179
- Repositioning components 47
- Restore button 33
- Reverting markdowns 122
- Reviewing markdown suggestions 78
- RSS feeds
 - component 54
- S**
- Saving changes
 - worksheets 123
- Schedule
 - decision period 35
 - read-only period 35
- Schedule for Price
 - typical rules 35
- Screens
 - adding to view 43
 - adding to views 44
 - changing colors (see changing skins)
 - composed of 50
 - defined 50
 - layouts and component placement 47

- list of types 50
- removing from view 43, 44
- renaming 47
- reordering 44
- reordering in view 43
- Reporting type 50
- setting home screen 44
- Top/Bottom type 50
- Security warning 15
- Sell-through percent
 - effect of setting high or low 140
 - related to exit inventory units 140
 - setting 145
- Sendback date
 - related to accelerated markdowns 119
 - reverting to global default 122
 - setting 117
- Service Pack 6 for Visual Basic Cabinets 15
- Session timeout message 16, 23
 - login again 16, 23
 - warning 16, 22, 23
- Setting home screen 44
- Skins
 - changing 44
 - changing on view 43
- Starting
 - Merchant Desktop 18
 - Price 18
- Status
 - items 3
 - markdowns 133
 - not recommended 128
 - taken markdowns 133
 - worksheets 83
- Submit access level 26
- Submitted for approval status 85
- Submitting worksheets 134
- System requirements 4

T

- Tabs
 - adding to views 44
 - removing from view 44
 - renaming 47
 - reordering 44
- Take accelerated markdown feature 117
- Take advanced markdown feature 117
- Take markdowns as a group feature 117
- Taken markdown statuses 133
 - changing 121
- Target exit date inventory (see Exit date inventory)
- Target sell-through percent (see Exit date sell-through percent)
- Timeout message
 - login again 16, 23
 - warning 16, 22, 23
- Timeout message, warning 16, 23
- Too much data to download, error message 54
- Top/Bottom screen type 50
- Troubleshooting
 - Price 188

U

- URL, for Price 14
- User status 133

V

- View
 - adding screens 43
 - changing skins 43
 - removing screens 43
 - reordering screens 43
- Viewing reports 184
- View-only access level 26
- Views
 - adding screens 44
 - adding tabs 44
 - changing skins 44
 - removing screens 44

Index

- removing tabs 44
- reordering screens 44
- reordering tabs 44
- setting home screen 44

W

Warning message, session timeout 16, 23

Web address, for Price 14

Web pages

- component 57

Web sites

- component 56

Weekly process for Price 35

Worksheet screen 130

Worksheets

- adding items 81
- approving 135
- creating columns 159
- declining 135
- deleting columns 163
- displaying hidden columns 156

- editing 81
- editing columns 161
- executing 136
- exporting data 169
- filtering by columns 167
- filtering by hierarchy 168
- hiding columns 157
- markdown status column 133
- opening 79
- printing data 170
- removing items 81
- reordering columns 158
- saving changes 123
- sorting data 166
- statuses 83
- submitting 134
- summary metrics 83
- viewing item details 127
- viewing items 130
- viewing pricing groups 130
- viewing results 123
- Worksheet screen 130