

**Oracle® Collaborative Planning**

Implementation and User's Guide

Release 12

**Part No. B31555-01**

September 2006

Oracle Collaborative Planning Implementation and User's Guide, Release 12

Part No. B31555-01

Copyright © 2004, 2006, Oracle. All rights reserved.

Primary Author: Sunanda Chatterjee

Contributing Author: Moshin Lee, Milind Govind Phadke

Contributor: Prasanta Dash, Arup Chatterjee, James Glasmann, Elizabeth Looney, Jiangang (James) Guo, Preetam Dandapani, Michael Hasan, Yvon Tang

The Programs (which include both the software and documentation) contain proprietary information; they are provided under a license agreement containing restrictions on use and disclosure and are also protected by copyright, patent, and other intellectual and industrial property laws. Reverse engineering, disassembly, or decompilation of the Programs, except to the extent required to obtain interoperability with other independently created software or as specified by law, is prohibited.

The information contained in this document is subject to change without notice. If you find any problems in the documentation, please report them to us in writing. This document is not warranted to be error-free. Except as may be expressly permitted in your license agreement for these Programs, no part of these Programs may be reproduced or transmitted in any form or by any means, electronic or mechanical, for any purpose.

If the Programs are delivered to the United States Government or anyone licensing or using the Programs on behalf of the United States Government, the following notice is applicable:

#### U.S. GOVERNMENT RIGHTS

Programs, software, databases, and related documentation and technical data delivered to U.S. Government customers are "commercial computer software" or "commercial technical data" pursuant to the applicable Federal Acquisition Regulation and agency-specific supplemental regulations. As such, use, duplication, disclosure, modification, and adaptation of the Programs, including documentation and technical data, shall be subject to the licensing restrictions set forth in the applicable Oracle license agreement, and, to the extent applicable, the additional rights set forth in FAR 52.227-19, Commercial Computer Software--Restricted Rights (June 1987). Oracle Corporation, 500 Oracle Parkway, Redwood City, CA 94065.

The Programs are not intended for use in any nuclear, aviation, mass transit, medical, or other inherently dangerous applications. It shall be the licensee's responsibility to take all appropriate fail-safe, backup, redundancy and other measures to ensure the safe use of such applications if the Programs are used for such purposes, and we disclaim liability for any damages caused by such use of the Programs.

The Programs may provide links to Web sites and access to content, products, and services from third parties. Oracle is not responsible for the availability of, or any content provided on, third-party Web sites. You bear all risks associated with the use of such content. If you choose to purchase any products or services from a third party, the relationship is directly between you and the third party. Oracle is not responsible for: (a) the quality of third-party products or services; or (b) fulfilling any of the terms of the agreement with the third party, including delivery of products or services and warranty obligations related to purchased products or services. Oracle is not responsible for any loss or damage of any sort that you may incur from dealing with any third party.

Oracle, JD Edwards, PeopleSoft, and Siebel are registered trademarks of Oracle Corporation and/or its affiliates. Other names may be trademarks of their respective owners.

---

# Contents

## Send Us Your Comments

## Preface

## 1 Introduction

Overview.....	1-1
Collaboration Methods.....	1-2
Collaborate with Customers.....	1-3
Collaborate with Suppliers.....	1-3
Multi-tier Collaborations.....	1-4
Oracle iSupplier Portal.....	1-5
Collaborate with Suppliers.....	1-6
Oracle Collaborative Planning Functionality.....	1-6
Time Buckets.....	1-8
Exception Management.....	1-8
Exception Summary and Details.....	1-8
Exception Thresholds.....	1-8
Supply Chain Event Manager.....	1-8
Requests.....	1-9

## 2 Setup

Overview.....	2-1
Deployment Configurations.....	2-2
Single Machine Implementation.....	2-2
Two Machine Implementation.....	2-3
Three Machine Implementation.....	2-3

<b>Setup with Oracle e-Business Suite</b> .....	2-4
Set up Profile Options .....	2-5
Define Customers, Suppliers, and Sites.....	2-7
Define Users and Assign Responsibilities.....	2-8
Set Up Calendar.....	2-16
Set Up Items.....	2-21
Setup Oracle iSupplier Portal.....	2-22
Set Up Buyer Code and Item Category for Advanced Search.....	2-23
OEM User Setup.....	2-23
<b>Standalone Setup</b> .....	2-26
Set Up the Legacy Instance.....	2-26
Set Up Profile Options.....	2-26
Define Customers, Suppliers, and Sites.....	2-29
Define Users and Assign Responsibilities.....	2-29
Set Up Calendar.....	2-30
Set Up Items and Other Entities.....	2-35
<b>Setting Up Multi-Tier Collaboration in Oracle Collaboration Planning</b> .....	2-35
Setup Steps in Oracle Order Management.....	2-35
Setup Steps in Oracle Inventory.....	2-36
Setup Steps in Oracle Purchasing.....	2-36
<b>Loading and Publishing Data</b> .....	2-39
Publish Data Using Oracle Advanced Supply Chain Planning.....	2-42
Publish Data Using Oracle Demand Planning.....	2-43
<b>Run Data Collections</b> .....	2-43
<b>Orders</b> .....	2-44
Create an Order.....	2-44
Add Orders.....	2-45
View Order History.....	2-45
<b>Order Types</b> .....	2-46
Supported Order Types.....	2-46
Renaming Order Types.....	2-49
<b>Assign Planner Codes to Items</b> .....	2-50
<b>Security Rules</b> .....	2-51

### **3 Forecasting**

<b>Overview</b> .....	3-1
<b>The Collaboration Cycle</b> .....	3-3
<b>Forecast Versioning</b> .....	3-4
<b>Collaborate with Customers</b> .....	3-5
Publish Forecasts.....	3-5

Publish Supply Commits.....	3-6
Receive Forecasts in Oracle Demand Planning.....	3-7
Customer Collaboration Automation.....	3-7
<b>Collaborate with Suppliers.....</b>	<b>3-9</b>
Supplier Collaboration Automation.....	3-9
Publish Order Forecasts.....	3-10
Receive Supplier Capacity.....	3-14
Impact of Time Bucketing on Receive Supply Capacity Program.....	3-14
Respond to and Edit Purchase Orders.....	3-14
On-hand Inventory Visibility.....	3-15
Access the Planner Workbench.....	3-16

## 4 Vendor Managed Inventory with Suppliers

<b>Overview.....</b>	<b>4-1</b>
<b>Order Types.....</b>	<b>4-3</b>
<b>User Setup and Process.....</b>	<b>4-4</b>
Create Blanket Purchase Agreements.....	4-4
Defining Parameters for Vendor Managed Inventory with Suppliers.....	4-5
Collect Approved Supplier Lists.....	4-9
Publish Order Forecast from ASCP.....	4-9
Schedule and Run the VMI Replenishment Engine.....	4-10
View Replenishment Orders.....	4-11
Submit Advance Shipment Notices.....	4-11
<b>Monitor and Replenish Inventory.....</b>	<b>4-12</b>
<b>Exceptions.....</b>	<b>4-19</b>
<b>VMI Replenishment Engine.....</b>	<b>4-19</b>
<b>Notifications.....</b>	<b>4-20</b>

## 5 Vendor Managed Inventory with Customers

<b>Overview of Vendor Managed Inventory with Customers.....</b>	<b>5-1</b>
<b>User Setup for VMI with Customers.....</b>	<b>5-2</b>
Setup Steps in Oracle Order Management.....	5-3
Setup Step in Oracle Purchasing.....	5-4
Setup Steps in Oracle Inventory.....	5-5
Setup Step in Oracle Order Management.....	5-7
Setup Step in Oracle Purchasing.....	5-8
Setup Step in Oracle Order Management.....	5-9
<b>The Different Flavors for Customer Facing VMI Process.....</b>	<b>5-9</b>
Order Types used in Unconsigned and Consigned VMI with Customers.....	5-10
Process for Customer-Facing VMI.....	5-11

Initial Steps Common to Unconsigned and Consigned VMI with Customers.....	5-12
Process for Unconsigned VMI with Customers.....	5-13
Process for Consigned VMI with Customers.....	5-24

## 6 Collaborative Inventory Visibility

Overview.....	6-1
Setup.....	6-1
Create Groups.....	6-2
Define Group Members.....	6-2
Define Security Rules.....	6-3
Upload Unallocated On-hand Inventory.....	6-4
Search for Inventory.....	6-5

## 7 Exceptions

Overview.....	7-1
Supply Chain Event Management Engine .....	7-2
View Exceptions.....	7-2
Seeded Exceptions.....	7-2
Late Orders .....	7-3
Material Shortage.....	7-4
Material Excess.....	7-5
Response Required: Response to Trading Partner Required.....	7-7
Response Required: Trading Partner Response Required.....	7-7
Potential Late Orders .....	7-8
Forecast Mismatch.....	7-9
Early Orders.....	7-12
Change Orders.....	7-12
Forecast Accuracy.....	7-13
Performance Measure Below Target.....	7-13
Custom Exceptions.....	7-15
Name the Exception.....	7-16
Define Exception Scope.....	7-16
Define Exception Condition.....	7-17
Define Exception Output Attributes.....	7-17
Define Schedule.....	7-18
Specify Recipients.....	7-18
Save.....	7-19
Edit Custom Exception.....	7-19
Copy Custom Exception.....	7-19
Exception Thresholds.....	7-19

Define Exception Thresholds.....	7-20
Delete Exception Thresholds.....	7-20
<b>Pegging.....</b>	<b>7-21</b>
Enter Pegging Information.....	7-21
Access Pegging Information.....	7-21
View Pegging Information.....	7-22
<b>8 Waterfall Analysis</b>	
<b>Overview.....</b>	<b>8-1</b>
<b>Setup.....</b>	<b>8-2</b>
<b>Upload Customer Forecasts.....</b>	<b>8-2</b>
<b>Search For and Compare Forecasts.....</b>	<b>8-3</b>
<b>9 Horizontal and Advanced Horizontal View</b>	
<b>Overview.....</b>	<b>9-1</b>
<b>Horizontal View.....</b>	<b>9-2</b>
The Search Region.....	9-2
Advanced Search.....	9-3
Preference Sets.....	9-7
Display CTO Data.....	9-9
Edit Order Quantities.....	9-9
Available Columns.....	9-10
<b>Collaborative Planning Time Bucketing.....</b>	<b>9-10</b>
Overview.....	9-10
Benefits of using site-specific calendar for time bucketing.....	9-11
Setup.....	9-11
Creating Time Buckets.....	9-14
Editing Order Quantities in the Horizontal View.....	9-25
Running Totals of Supply and Demand.....	9-27
<b>Advanced Horizontal View.....</b>	<b>9-28</b>
Setup.....	9-28
Create Workbooks.....	9-28
Share Workbooks.....	9-30
View Workbooks.....	9-30
<b>10 Vertical View</b>	
<b>Overview.....</b>	<b>10-1</b>
<b>Export Data from Vertical View.....</b>	<b>10-11</b>
<b>Export Data in Import Format .....</b>	<b>10-11</b>
<b>Display of CTO Data.....</b>	<b>10-16</b>

## 11 Multi-Tier Collaboration in Collaborative Planning

Overview.....	11-1
Oracle Applications Support for Multi-Company Collaborative Planning.....	11-2
Executing Multi-Company Collaborative Planning.....	11-8
Demand Planning and Forecast Collaboration.....	11-8
Supply Chain Planning and Collaboration with Suppliers.....	11-10
Supply Chain Collaboration with Suppliers and Contract Manufacturers.....	11-16

## 12 Workflow

Using Oracle Workflow in Oracle Collaborative Planning.....	12-1
Setting Up Oracle Workflow in Oracle Collaborative Planning.....	12-1
Extending Workflows in Oracle Collaborative Planning.....	12-2
Overview.....	12-2
Customizations.....	12-2
Extending Workflow.....	12-3
Viewing Processes in Oracle Workflow Builder.....	12-4
Seeded Data Files.....	12-5
Seeded Data File mscxewf.wft.....	12-6
Seeded Data File mscxudex.wft.....	12-6
Seeded Data File mscxnet.wft.....	12-6
Seeded Data File mscxvmir.wft.....	12-6
Seeded Data File mscxcfvr.wft.....	12-7
Seeded Data File mscxdprf.wft.....	12-7
Seeded Data File mscxpbof.wft.....	12-7
Seeded Data File mscxpbsc.wft.....	12-8
Seeded Data File mscxrcsc.wft.....	12-8
Seeded Data File mscxssem.wft.....	12-8
Seeded Data File mscxascp.wft.....	12-8
Item Types.....	12-9
Oracle Collaborative Planning VMI Replenishment.....	12-9
MSC: User Define Exception Workflow.....	12-12
Start ASCP Engine.....	12-25
Start SCEM Engine.....	12-25
Publish Order Forecast.....	12-25
Start Receive Supplier Capacity.....	12-26
Publish Supply Commit.....	12-27
Supply/Demand Mismatch.....	12-27
Workflows for Oracle Collaborative Planning.....	12-30
DP Receive Forecast.....	12-31



<b>Workflow Processes Used In Oracle Collaborative Planning</b> .....	12-32
Error Notifications for Excel Import of Forecast/Supply.....	12-33
User Define Exception Workflow.....	12-34
Supply/Demand Mismatch.....	12-35
Oracle Collaborative Planning VMI Replenishment.....	12-37
For Supplier-Facing VMI Replenishment.....	12-37
For Customer-Facing VMI Replenishment.....	12-39
Start ASCP Engine.....	12-41
DP Receive Forecast.....	12-42
Publish Order Forecast.....	12-44
Publish Supply Commit.....	12-45
Start Receive Supplier Capacity.....	12-46
Start SCEM Engine.....	12-47
<b>Functions</b> .....	12-49
Oracle Collaborative Planning VMI Replenishment.....	12-49
For Supplier-Facing VMI Replenishment.....	12-49
For Customer-Facing VMI Replenishment.....	12-51
MSC: User Define Exception Workflow.....	12-55
Start ASCP Engine.....	12-55
Start SCEM Engine.....	12-56
Publish Order Forecast.....	12-56
Start Receive Supplier Capacity.....	12-57
Publish Supply Commit.....	12-57
Supply/Demand Mismatch.....	12-58
Workflows for Oracle Collaborative Planning.....	12-58
DP Receive Forecast.....	12-60
Standard.....	12-60

## **A Profile Options**

Profile Options.....	A-1
----------------------	-----

## **B Troubleshooting**

Loading Data.....	B-1
Vertical View.....	B-3
Vendor Managed Inventory with Suppliers.....	B-3
Vendor Managed Inventory with Customers.....	B-4
Horizontal View.....	B-5
Security Rules.....	B-6
Exceptions.....	B-6
Forecast Comparison.....	B-6

XML Gateway..... B-7

**C XML**

Overview..... C-1  
XML Transactions..... C-1  
    Supply/Demand Load..... C-2  
Set Up XML Gateway..... C-3  
Legacy Integration Loads..... C-3

**D Key Tables**

Key Tables..... D-1

**Glossary**

**Index**

---

# Send Us Your Comments

## Oracle Collaborative Planning Implementation and User's Guide, Release 12

### Part No. B31555-01

Oracle welcomes customers' comments and suggestions on the quality and usefulness of this document. Your feedback is important, and helps us to best meet your needs as a user of our products. For example:

- Are the implementation steps correct and complete?
- Did you understand the context of the procedures?
- Did you find any errors in the information?
- Does the structure of the information help you with your tasks?
- Do you need different information or graphics? If so, where, and in what format?
- Are the examples correct? Do you need more examples?

If you find any errors or have any other suggestions for improvement, then please tell us your name, the name of the company who has licensed our products, the title and part number of the documentation and the chapter, section, and page number (if available).

Note: Before sending us your comments, you might like to check that you have the latest version of the document and if any concerns are already addressed. To do this, access the new Applications Release Online Documentation CD available on Oracle MetaLink and [www.oracle.com](http://www.oracle.com). It contains the most current Documentation Library plus all documents revised or released recently.

Send your comments to us using the electronic mail address: [appsdoc\\_us@oracle.com](mailto:appsdoc_us@oracle.com)

Please give your name, address, electronic mail address, and telephone number (optional).

If you need assistance with Oracle software, then please contact your support representative or Oracle Support Services.

If you require training or instruction in using Oracle software, then please contact your Oracle local office and inquire about our Oracle University offerings. A list of Oracle offices is available on our Web site at [www.oracle.com](http://www.oracle.com).



---

# Preface

## Intended Audience

Welcome to Release 12 of the *Oracle Collaborative Planning Implementation and User's Guide*.

This guide assumes you have a working knowledge of the following:

- The principles and customary practices of your business area.
- Oracle Collaborative Planning

If you have never used Oracle Collaborative Planning, Oracle suggests you attend one or more of the Oracle Collaborative Planning training classes available through Oracle University.

- The Oracle Applications graphical user interface.

To learn more about the Oracle Applications graphical user interface, read the *Oracle Applications User's Guide*.

See Other Information Sources for more information about Oracle Applications product information.

## Documentation Accessibility

Our goal is to make Oracle products, services, and supporting documentation accessible, with good usability, to the disabled community. To that end, our documentation includes features that make information available to users of assistive technology. This documentation is available in HTML format, and contains markup to facilitate access by the disabled community. Standards will continue to evolve over time, and Oracle is actively engaged with other market-leading technology vendors to address technical obstacles so that our documentation can be accessible to all of our customers. For additional information, visit the Oracle Accessibility Program Web site at <http://www.oracle.com/accessibility/>.

## **Accessibility of Code Examples in Documentation**

JAWS, a Windows screen reader, may not always correctly read the code examples in this document. The conventions for writing code require that closing braces should appear on an otherwise empty line; however, JAWS may not always read a line of text that consists solely of a bracket or brace.

## **Accessibility of Links to External Web Sites in Documentation**

This documentation may contain links to Web sites of other companies or organizations that Oracle does not own or control. Oracle neither evaluates nor makes any representations regarding the accessibility of these Web sites.

See Related Information Sources on page xv for more Oracle Applications product information.

## **TTY Access to Oracle Support Services**

Oracle provides dedicated Text Telephone (TTY) access to Oracle Support Services within the United States of America 24 hours a day, seven days a week. For TTY support, call 800.446.2398.

## **Documentation Accessibility**

Our goal is to make Oracle products, services, and supporting documentation accessible, with good usability, to the disabled community. To that end, our documentation includes features that make information available to users of assistive technology. This documentation is available in HTML format, and contains markup to facilitate access by the disabled community. Accessibility standards will continue to evolve over time, and Oracle is actively engaged with other market-leading technology vendors to address technical obstacles so that our documentation can be accessible to all of our customers. For more information, visit the Oracle Accessibility Program Web site at <http://www.oracle.com/accessibility/>.

## **Accessibility of Code Examples in Documentation**

Screen readers may not always correctly read the code examples in this document. The conventions for writing code require that closing braces should appear on an otherwise empty line; however, some screen readers may not always read a line of text that consists solely of a bracket or brace.

## **Accessibility of Links to External Web Sites in Documentation**

This documentation may contain links to Web sites of other companies or organizations that Oracle does not own or control. Oracle neither evaluates nor makes any representations regarding the accessibility of these Web sites.

## Structure

- 1 Introduction
- 2 Setup
- 3 Forecasting
- 4 Vendor Managed Inventory with Suppliers
- 5 Vendor Managed Inventory with Customers
- 6 Collaborative Inventory Visibility
- 7 Exceptions
- 8 Waterfall Analysis
- 9 Horizontal and Advanced Horizontal View
- 10 Vertical View
- 11 Multi-Tier Collaboration in Collaborative Planning
- 12 Workflow
- A Profile Options
- B Troubleshooting
- C XML
- D Key Tables
- Glossary

## Related Information Sources

You can choose from many sources of information, including online documentation, training, and support services, to increase your knowledge and understanding of Oracle Collaborative Planning.

If this guide refers you to other Oracle Applications documentation, use only the Release 12 versions of those guides.

## Integration Repository

The Oracle Integration Repository is a compilation of information about the service endpoints exposed by the Oracle E-Business Suite of applications. It provides a complete catalog of Oracle E-Business Suite's business service interfaces. The tool lets users easily discover and deploy the appropriate business service interface for integration with any system, application, or business partner.

The Oracle Integration Repository is shipped as part of the E-Business Suite. As your instance is patched, the repository is automatically updated with content appropriate for the precise revisions of interfaces in your environment.

## Online Documentation

All Oracle Applications documentation is available online (HTML or PDF).

- **Online Help:** The new features section in the HTML help describes new features in Oracle Applications Release 12. This information is updated for each new release of Oracle Collaborative Planning. The new features section also includes information

about any features that were not yet available when this guide was printed. For example, if your administrator has installed software from a mini-packs an upgrade, this document describes the new features. Online help patches are available on OracleMetaLink.

- **Release 12 Features Matrix:** This document lists new features available by patch and identifies any associated new documentation. The new features matrix document is available on *OracleMetaLink*.
- **Readme File:** Refer to the readme file for patches that you have installed to learn about new documentation or documentation patches that you can download.

## Related User's Guides

Oracle Collaborative Planning shares business and setup information with other Oracle Applications products. Therefore, you may want to refer to other user's guides when you set up and use Oracle Collaborative Planning.

You can read the guides online by choosing Library from the expandable menu on your HTML help window, by reading from the Oracle Applications Document Library CD included in your media pack, or by using a Web browser with a URL that your system administrator provides.

If you require printed guides, you can purchase them from the Oracle Store at <http://oraclestore.oracle.com>.

## Guides Related to All Products

### Oracle Applications User's Guide

This guide explains how to enter data, query, run reports, and navigate using the graphical user interface (GUI) available with this release of Oracle Collaborative Planning (and any other Oracle Applications products). This guide also includes information on setting user profiles, as well as running and reviewing reports and concurrent processes.

You can access this user's guide online by choosing Getting Started with Oracle Applications from any Oracle Applications help file.

## User Guides Related to This Product

### Oracle Advanced Planning Implementation and User's Guide

This guide describes how to use Oracle's planning solution for supply chain planning performance. This guide can be used as a reference when you are implementing Oracle Advanced Supply Chain Planning with Oracle Collaborative Planning.



## **Oracle Inventory User's Guide**

This guide describes how to define items and item information, perform receiving and inventory transactions, maintain cost control, plan items, perform cycle counting and physical inventories, and set up Oracle Inventory.

## **Oracle Order Management User's Guide**

This guide describes how to enter sales orders and returns, copy existing sales orders, schedule orders, release orders, create price lists, and discounts for orders, run processes, and create reports.

## **Oracle Workflow Guide**

This guide explains how to define new workflow business processes as well as customize existing Oracle Applications-embedded workflow processes. You also use this guide to complete the setup steps necessary for any Oracle Applications product that includes workflow-enabled processes.

## **Installation and System Administration**

### **Oracle Applications Concepts**

This guide provides an introduction to the concepts, features, technology stack, architecture, and terminology for Oracle Applications Release 12. It provides a useful first book to read before an installation of Oracle Applications. This guide also introduces the concepts behind Applications-wide features such as Business Intelligence (BIS), languages and character sets, and Self-Service Web Applications.

### **Installing Oracle Applications**

This guide provides instructions for managing the installation of Oracle Applications products. In Oracle Applications Release 12, much of the installation process is handled using Oracle Rapid Install, which minimizes the time to install Oracle Applications, the Oracle9 technology stack, and the Oracle9i Server technology stack by automating many of the required steps. This guide contains instructions for using Oracle Rapid Install and lists the tasks you need to perform to finish your installation. You should use this guide in conjunction with individual product user's guides and implementation guides.

### **Upgrading Oracle Applications**

Refer to this guide if you are upgrading your Oracle Applications Release 10.7 or Release 11i products to Oracle Applications Release 12. This guide describes the upgrade process and lists database and product-specific upgrade tasks. You must be either at Oracle Applications Release 10.7 (NCA, SmartClient, or character mode) or Oracle Applications Release 11i, to upgrade to Oracle Applications Release 12. You

cannot upgrade to Oracle Applications Release 12 directly from releases prior to 10.7.

## **Maintaining Oracle Applications**

Use this guide to help you run the various AD utilities, such as AutoUpgrade, AutoPatch, AD Administration, AD Controller, AD Relink, License Manager, and others. It contains how-to steps, screenshots, and other information that you need to run the AD utilities. This guide also provides information on maintaining the Oracle applications file system and database.

## **Oracle Applications System Administrator's Guide**

This guide provides planning and reference information for the Oracle Applications System Administrator. It contains information on how to define security, customize menus and online help, and manage concurrent processing.

## **Oracle Alert User's Guide**

This guide explains how to define periodic and event alerts to monitor the status of your Oracle Applications data.

## **Oracle Applications Developer's Guide**

This guide contains the coding standards followed by the Oracle Applications development staff. It describes the Oracle Application Object Library components needed to implement the Oracle Applications user interface described in the Oracle Applications User Interface Standards for Forms-Based Products. It also provides information to help you build your custom Oracle Forms Developer 6i forms so that they integrate with Oracle Applications.

## **Oracle Applications User Interface Standards for Forms-Based Products**

This guide contains the user interface (UI) standards followed by the Oracle Applications development staff. It describes the UI for the Oracle Applications products and how to apply this UI to the design of an application built by using Oracle Forms.

## **Other Implementation Documentation**

### **Oracle Applications Product Update Notes**

Use this guide as a reference for upgrading an installation of Oracle Applications. It provides a history of the changes to individual Oracle Applications products between Release 11*i* and Release 12. It includes new features, enhancements, and changes made to database objects, profile options, and seed data for this interval.

### **Multiple Reporting Currencies in Oracle Applications**

If you use the Multiple Reporting Currencies feature to record transactions in more than

one currency, use this manual before implementing Oracle Collaborative Planning. This manual details additional steps and setup considerations for implementing Oracle Collaborative Planning with this feature.

### **Multiple Organizations in Oracle Applications**

This guide describes how to set up and use Oracle Collaborative Planning with Oracle Applications' Multiple Organization support feature, so you can define and support different organization structures when running a single installation of Oracle Collaborative Planning.

### **Oracle Workflow Administrator's Guide**

This guide explains how to complete the setup steps necessary for any Oracle Applications product that includes workflow-enabled processes, as well as how to monitor the progress of runtime workflow processes.

### **Oracle Workflow Developer's Guide**

This guide explains how to define new workflow business processes and customize existing Oracle Applications-embedded workflow processes. It also describes how to define and customize business events and event subscriptions.

### **Oracle Workflow User's Guide**

This guide describes how Oracle Applications users can view and respond to workflow notifications and monitor the progress of their workflow processes.

### **Oracle Workflow API Reference**

This guide describes the APIs provided for developers and administrators to access Oracle Workflow.

### **Oracle Applications Flexfields Guide**

This guide provides flexfields planning, setup and reference information for the Oracle Collaborative Planning implementation team, as well as for users responsible for the ongoing maintenance of Oracle Applications product data. This manual also provides information on creating custom reports on flexfields data.

### **Oracle eTechnical Reference Manuals**

Each eTechnical Reference Manual (eTRM) contains database diagrams and a detailed description of database tables, forms, reports, and programs for a specific Oracle Applications product. This information helps you convert data from your existing applications, integrate Oracle Applications data with non-Oracle applications, and write custom reports for Oracle Applications products. Oracle eTRM is available on Metalink.

## **Oracle Manufacturing APIs and Open Interfaces Manual**

This manual contains up-to-date information about integrating with other Oracle Manufacturing applications and with your other systems. This documentation includes API's and open interfaces found in Oracle Manufacturing.

## **Oracle Order Management Suite APIs and Open Interfaces Manual**

This manual contains up-to-date information about integrating with other Oracle Manufacturing applications and with your other systems. This documentation includes API's and open interfaces found in Oracle Order Management Suite.

## **Oracle Applications Message Reference Manual**

This manual describes all Oracle Applications messages. This manual is available in HTML format on the documentation CD-ROM for Oracle Applications Release 12.

## **Training and Support**

### **Training**

Oracle offers a complete set of training courses to help you and your staff master Oracle Collaborative Planning and reach full productivity quickly. These courses are organized into functional learning paths, so you take only those courses appropriate to your job or area of responsibility.

You have a choice of educational environments. You can attend courses offered by Oracle University at any one of our many Education Centers, you can arrange for our trainers to teach at your facility, or you can use Oracle Learning Network (OLN), Oracle University's online education utility. In addition, Oracle training professionals can tailor standard courses or develop custom courses to meet your needs. For example, you may want to use your organization structure, terminology, and data as examples in a customized training session delivered at your own facility.

### **Support**

From on-site support to central support, our team of experienced professionals provides the help and information you need to keep Oracle Collaborative Planning working for you. This team includes your Technical Representative, Account Manager, and Oracle's large staff of consultants and support specialists with expertise in your business area, managing an Oracle9i server, and your hardware and software environment.

## **Do Not Use Database Tools to Modify Oracle Applications Data**

Oracle *STRONGLY RECOMMENDS* that you never use SQL\*Plus, Oracle Data Browser, database triggers, or any other tool to modify Oracle Applications data unless otherwise instructed.

Oracle provides powerful tools you can use to create, store, change, retrieve, and maintain information in an Oracle database. But if you use Oracle tools such as SQL\*Plus to modify Oracle Applications data, you risk destroying the integrity of your data and you lose the ability to audit changes to your data.

Because Oracle Applications tables are interrelated, any change you make using Oracle Applications can update many tables at once. But when you modify Oracle Applications data using anything other than Oracle Applications, you may change a row in one table without making corresponding changes in related tables. If your tables get out of synchronization with each other, you risk retrieving erroneous information and you risk unpredictable results throughout Oracle Applications.

When you use Oracle Applications to modify your data, Oracle Applications automatically checks that your changes are valid. Oracle Applications also keeps track of who changes information. If you enter information into database tables using database tools, you may store invalid information. You also lose the ability to track who has changed your information because SQL\*Plus and other database tools do not keep a record of changes.

## About Oracle

Oracle develops and markets an integrated line of software products for database management, applications development, decision support, and office automation, as well as Oracle Applications, an integrated suite of more than 160 software modules for financial management, supply chain management, manufacturing, project systems, human resources and customer relationship management.

Oracle products are available for mainframes, minicomputers, personal computers, network computers and personal digital assistants, allowing organizations to integrate different computers, different operating systems, different networks, and even different database management systems, into a single, unified computing and information resource.

Oracle is the world's leading supplier of software for information management, and the world's second largest software company. Oracle offers its database, tools, and applications products, along with related consulting, education, and support services, in over 145 countries around the world.

## Your Feedback

Thank you for using Oracle Collaborative Planning and this user's guide. Oracle values your comments and feedback. At the beginning of this guide is a Reader's Comment Form you can use to explain what you like or dislike about Oracle Collaborative Planning or this user's guide. You can send comments to us at the e-mail address [mfgdoccomments\\_us@oracle.com](mailto:mfgdoccomments_us@oracle.com).

## Do Not Use Database Tools to Modify Oracle Applications Data

Oracle STRONGLY RECOMMENDS that you never use SQL\*Plus, Oracle Data Browser, database triggers, or any other tool to modify Oracle Applications data unless otherwise instructed.

Oracle provides powerful tools you can use to create, store, change, retrieve, and maintain information in an Oracle database. But if you use Oracle tools such as SQL\*Plus to modify Oracle Applications data, you risk destroying the integrity of your data and you lose the ability to audit changes to your data.

Because Oracle Applications tables are interrelated, any change you make using an Oracle Applications form can update many tables at once. But when you modify Oracle Applications data using anything other than Oracle Applications, you may change a row in one table without making corresponding changes in related tables. If your tables get out of synchronization with each other, you risk retrieving erroneous information and you risk unpredictable results throughout Oracle Applications.

When you use Oracle Applications to modify your data, Oracle Applications automatically checks that your changes are valid. Oracle Applications also keeps track of who changes information. If you enter information into database tables using database tools, you may store invalid information. You also lose the ability to track who has changed your information because SQL\*Plus and other database tools do not keep a record of changes.

---

# Introduction

This chapter covers the following topics:

- Overview
- Collaboration Methods
- Collaborate with Customers
- Collaborate with Suppliers
- Multi-tier Collaborations
- Oracle iSupplier Portal
- Oracle Collaborative Planning Functionality
- Time Buckets
- Exception Management
- Requests

## Overview

Oracle Collaborative Planning provides advanced capabilities for communicating, planning, and optimizing supply and demand information for trading partners across the supply chain. Oracle Collaborative Planning enables you to reduce inventory levels, improve visibility across your supply chain, increase the speed of information and materials, and promise delivery more accurately.

The following image depicts how Oracle Collaborative Planning works between you, your customers and your suppliers:

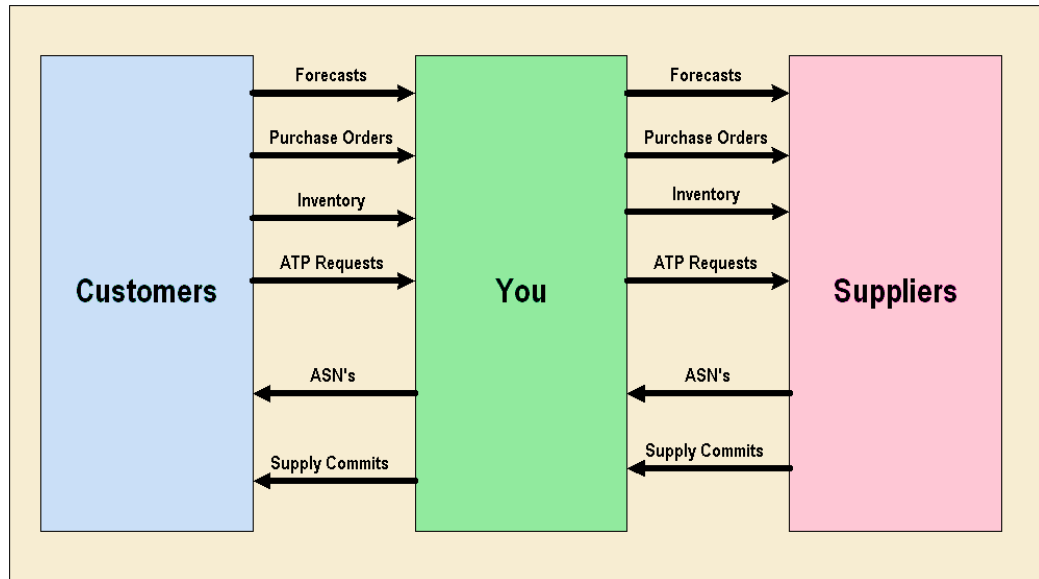

Oracle Collaborative Planning integrates with Oracle Advanced Supply Chain Planning, Oracle Demand Planning, and Oracle iSupplier Portal for a complete supply chain solution. You also can integrate Oracle Collaborative Planning with legacy ERP systems or use it as a standalone product.

Through integration, Oracle Collaborative Planning enables you to:

- Use data collections to acquire setup data from ERP legacy systems (items, customers, suppliers, users, company associations)
- Use data collections to access execution data, such as purchase orders and sales orders
- Publish order forecasts from Oracle Advanced Supply Chain Planning to your suppliers in Oracle Collaborative Planning
- Receive supply commits from Oracle Collaborative Planning to Oracle Advanced Supply Chain Planning
- Publish sales forecasts from Oracle Demand Planning to your customers in Oracle Collaborative Planning

## Collaboration Methods

You can send and receive information into Oracle Collaborative Planning using the publish programs from Oracle Advanced Supply Chain Planning and Oracle Demand Planning, direct entry through the user interface, flat file loads, or XML.



**Note:** You can publish order forecasts and supply commits from Advanced Supply Chain Planning to Collaborative Planning using MPS, MPP, MRP, and DRP plan types.

For more information about direct entry of information and flat file loads, refer to Setup, page 2-1.

For more information about XML transactions in Oracle Collaborative Planning, refer to Appendix C, page C-1.

## Collaborate with Customers

There are two types of collaboration business processes:

- Sales forecast collaboration
- Order forecast collaboration

Sales forecast collaboration is prevalent in the consumer goods industries, where promotions by both retailers and manufacturers have direct impact on end-consumer demand.

Order forecast collaboration is more common in manufacturing environments. Customers provide demand forecasts, and suppliers provide supply commit information based on their ability to meet the demand. Oracle Collaborative Planning enables your customers to publish forecasts in Oracle Collaborative Planning. You can then provide accurate supply commits based on those forecasts.

For more information about collaborating with customers, refer to Forecasting, page 3-1.

## Collaborate with Suppliers

Collaboration with suppliers is similar to that with customers. With supplier collaboration, however, you are in the customer role and the supplier takes on your role. You must provide your suppliers with enough visibility to enable them to be more responsive to your requirements, reduce material shortages, view constraints early, and track performance. Two types of information collaborations are available:

- Sales forecast
- Order forecast

To prescribe the replenishment quantity to your suppliers, you can adopt any one of the following methods:

- **Min-max method:** This method enables you to specify a minimum and maximum inventory quantity to be maintained at your own inventory organization.

- **Reorder point-fixed order quantity method:** This method enables you to order a specific quantity whenever inventory drops below a certain minimum level.
- **Days of supply method:** This method enables you to maintain inventory within the bounds of minimum and maximum days of supply. That is, you can specify the reorder point and reorder quantity in terms of days. When you publish an order forecast, the Vendor Managed Inventory (VMI) replenishment engine calculates and recommends a reorder quantity that translates this time horizon into days of supply.

For more information about collaborating with suppliers, see *Overview of Forecasting*, page 3-1.

## Multi-tier Collaborations

Oracle Collaborative Planning enables you to model any level of complexity in your supply chain and promote a seamless flow of information and materials across your extended supply chain. This enables you to provide visibility of your requirements to all tiers of your supply chain so that you can have visibility of all issues and constraints in your supply chain.

Multi-tier collaborations enable you to:

- Communicate requirements to contract manufacturers and suppliers
- Get visibility to supplier capacity and customer requirements
- Reallocate key components
- Make alternate sourcing decisions

Complete the following steps to establish a multi-tier collaboration:

- Come to consensus on demand with your customer.
- Involve your entire supply chain.
- Communicate the requirements for your contracted assemblies and requirements for critical components to other tiers of the supply chain. This enables you to simultaneously provide visibility into your plans to the entire supply chain.
- Receive commitments from all tiers of the supply chain simultaneously, providing you warn early about disruptions in the flow of material, and the ability to proactively identify contingency plans and alternate strategies.
- Provide accurate commitments to your customers that take into account an up-to-date assessment of your supply chain capabilities.

## Oracle iSupplier Portal

When Oracle iSupplier Portal and Oracle Collaborative Planning are licensed, they can be combined in a unified portal (if they are deployed together in the same database instance). This provides your suppliers with one point of entry for planning and execution data.

The following image depicts how Oracle iSupplier Portal and Oracle Collaborative Planning combine to a unified portal:

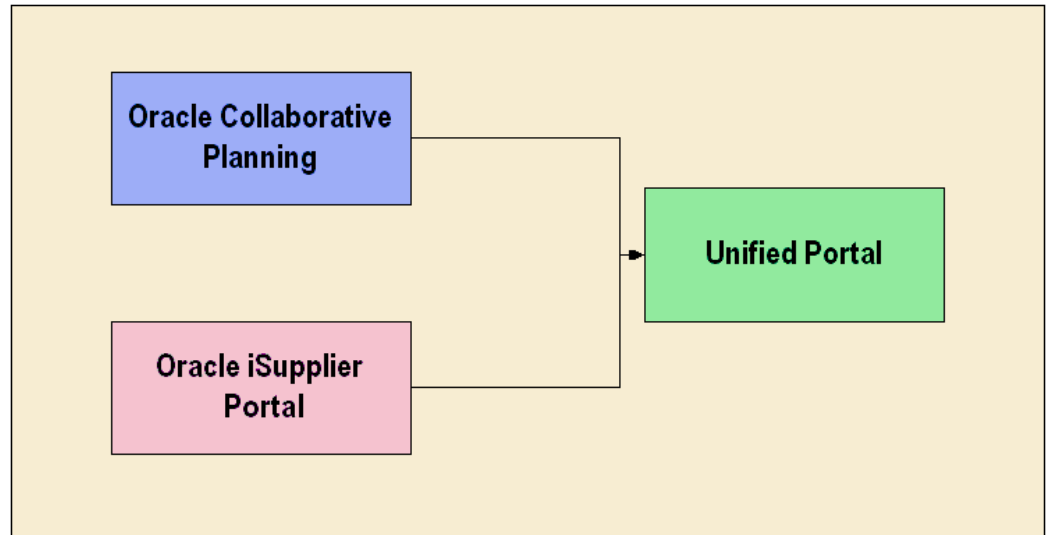

The unified portal of Oracle Collaborative Planning and Oracle iSupplier Portal provides you with several capabilities. The following table lists those capabilities, and which application provides them.

Capability	Application
Orders	Oracle iSupplier Portal
ASN (Advanced Shipment Notices)	Oracle iSupplier Portal
Receipts	Oracle iSupplier Portal
Invoices	Oracle iSupplier Portal
Payments	Oracle iSupplier Portal

<b>Capability</b>	<b>Application</b>
Vendor Managed Inventory with suppliers	Oracle iSupplier Portal and Oracle Collaborative Planning
Suppliers, products, order modifiers, approved supplier lists, sourcing	Oracle iSupplier Portal and Oracle Collaborative Planning
Exceptions	Oracle Collaborative Planning
Forecasts	Oracle Collaborative Planning
Capacity	Oracle Collaborative Planning
Pegging	Oracle Collaborative Planning
Waterfall Analysis	Oracle Collaborative Planning

For more information about how to set up Oracle Collaborative Planning with Oracle iSupplier Portal, refer to Setup, page 2-1.

## Collaborate with Suppliers

The suppliers can respond to purchase orders and initiate purchase order change requests directly through the Oracle iSupplier Portal. When this happens, Oracle Collaborative Planning auto-creates (for the purposes of supply/demand tracking and exception management within Oracle Collaborative Planning) a supplier sales order containing the acknowledgement information. Suppliers can provide their sales order reference information directly through Oracle iSupplier Portal. This not only reduces overhead of maintaining documents in two separate places, but also enables a more streamlined business process. Overview of Forecasting, page 3-1.

## Oracle Collaborative Planning Functionality

Collaborative planning is accomplished using several functionalities. The following table lists and describes the functionalities that facilitate collaboration:

<b>Function</b>	<b>Description</b>
-----------------	--------------------

Function	Description
Collaborative Planning and Forecasting	<p>You can involve your customers in the forecasting process to drive to consensus and improve forecast accuracy. After running your internal planning process, you can communicate the output of your supply chain plan to your suppliers. Their response to forecast information can be included in the planning cycle.</p>
Vendor Managed Inventory (supplier and customer-facing)	<p>Vendor Managed Inventory enables you to automate the replenishment process, lower inventory, improve the performance of your trading partners, and reduce out transactional costs.</p> <p>Vendor Managed Inventory with suppliers enables your suppliers to manage the replenishment process at your site using information provided by you. The replenishment process is integrated with execution systems, with configurable levels of automation.</p> <p>For more information about Vendor Managed Inventory with suppliers, refer to Vendor Managed Inventory with Suppliers, page 4-1.</p> <p>Vendor Managed Inventory with customers enables you to manage inventory at your customer's sites, based on information provided by them. Customers can share relevant replenishment input data, based on which Collaboration Planning creates replenishment plans. The replenishment process is integrated with execution systems, with configurable levels of automation.</p> <p>For more information about Vendor Managed Inventory with customers, refer to Vendor Managed Inventory with Customers, page 5-1.</p>
Oracle Supply Chain Exception Management	<p>Even as the frequency of planning increases, disruptions in between planning runs are still inevitable. Oracle Collaborative Planning enables you to adapt to disruptions in the supply chain by using Supply Chain Exception Management. You can define your own exceptions or use seeded exceptions. Workflow is used to automate notifications and corrective action processes.</p> <p>For more information about exceptions, refer to Exceptions, page 7-1.</p>

Function	Description
Collaborative Inventory Visibility	<p>Collaborative Inventory Visibility enables you to create groups and share inventory among members of those group.</p> <p>For more information about Collaborative Inventory Visibility, refer to Collaborative Inventory Visibility, page 6-1.</p>

## Time Buckets

Oracle Collaborative Planning uses time buckets to represent supply and demand information according to site-specific calendars assigned to different trading partners. You can use time buckets to specify durations for demand and supply information in terms of days, weeks, and months.

## Exception Management

Any mismatches in supply and demand information are flagged using exception messages. You can view each exception message in Oracle Collaborative Planning, or as a workflow notification. You can choose to view only those exceptions that are of interest to you, and rank them according to your preference.

### Exception Summary and Details

The Exceptions Summary window lists the exception types and number of exceptions. From the Summary window you can navigate to the Exception Details window. The Exception Details window displays each exception together with all details pertinent to that exception and navigation into other windows to aid you with the resolution process.

### Exception Thresholds

An administrator can specify the tolerance for each exception type that can lead to an exception. By setting appropriate tolerances, you can avoid exception overloads and ensure that issues are flagged when required.

### Supply Chain Event Manager

To generate exceptions and send notifications you must run the Supply Chain Event Manager. To run this program your username must be assigned to the Advanced Planning System Administrator responsibility. Contact your system administrator if you do not have this responsibility.

Complete the following steps to run the Supply Chain Event Manager:

1. Log in under the Advanced Planning Administrator responsibility.
2. Navigate to Other > Supply Chain Event Manager.
3. Enter a value for each of the parameters.

**Note:** The default value is set to No.

4. Select OK.
5. Select Submit.

## Requests

Whenever you load information into the system using Oracle Advanced Supply Chain Planning, you receive a request ID. You can view the progress of your requests of any information you load in the Oracle Collaborative Planning system. When you view your requests, the system displays whether the load was successful.

1. From the Home window of Oracle Collaborative Planning, select the Admin tab.
2. Select View Requests.
3. In the Requests window select a status and then select Go.
4. To view specific request details, select Details.
5. You can view the following information in the Request Details window:
6. Summary
7. Parameters
8. Notifications
9. Printing
10. Diagnostics





This chapter covers the following topics:

- Overview
- Deployment Configurations
- Setup with Oracle e-Business Suite
- Standalone Setup
- Setting Up Multi-Tier Collaboration in Oracle Collaboration Planning
- Loading and Publishing Data
- Run Data Collections
- Orders
- Order Types
- Assign Planner Codes to Items
- Security Rules

### Overview

Your implementation of Oracle Collaborative Planning depends on the application(s) you integrate with. Depending on the system, if any, you integrate Oracle Collaborative Planning with, you load data using different methods. Consider whether the following apply to your implementation:

- Implementation with Oracle e-Business Suite
- Implementation with Oracle Advanced Planning and Scheduling
- Implementation with Legacy systems
- Standalone setup

The following table depicts the setup steps necessary to implement Oracle Collaborative Planning, depending on your implementation type.

<b>Step</b>	<b>Oracle e-Business Suite or Oracle Advanced Planning and Scheduling</b>	<b>Standalone Setup</b>
Set up Profile Options	Required	Required
Define customers, suppliers, and sites	Required	Required
Define users and assign responsibilities	Required	Required
Set up calendars	Required	Required
Set up items and other entities	Required	Required
Set up Oracle iSupplier portal	Optional	Not applicable

## Deployment Configurations

Begin your setup process by deciding on your deployment hardware configuration. Oracle Collaborative Planning supports one, two and three machine implementations. These different deployment configurations enable planning calculations to be performed on different machines than the machine that performs transactions. This results in better system response.

The following are types of deployment configurations:

- Single Machine Implementation, page 2-2
- Two Machine Implementation, page 2-3
- Three Machine Implementation, page 2-3

### Single Machine Implementation

For small implementations, source and destination can reside on the same machine and in the same instance. The following image illustrates this configuration:

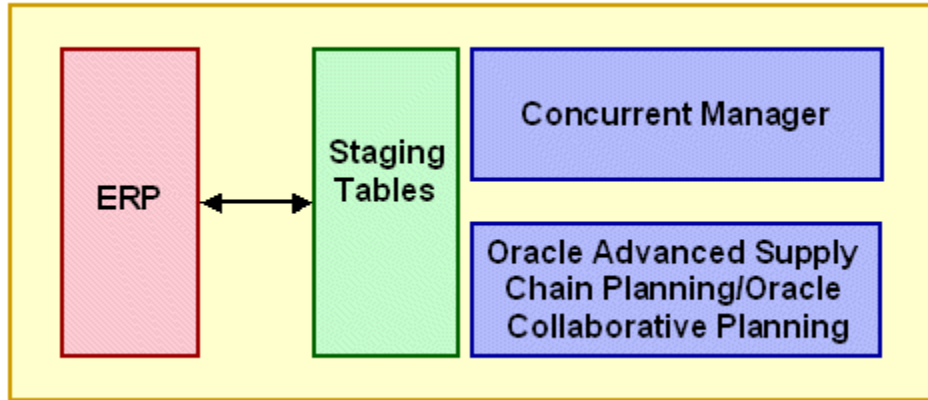

### Two Machine Implementation

For larger implementations various instances can be deployed on separate machines. The following image depicts a two machine implementation:

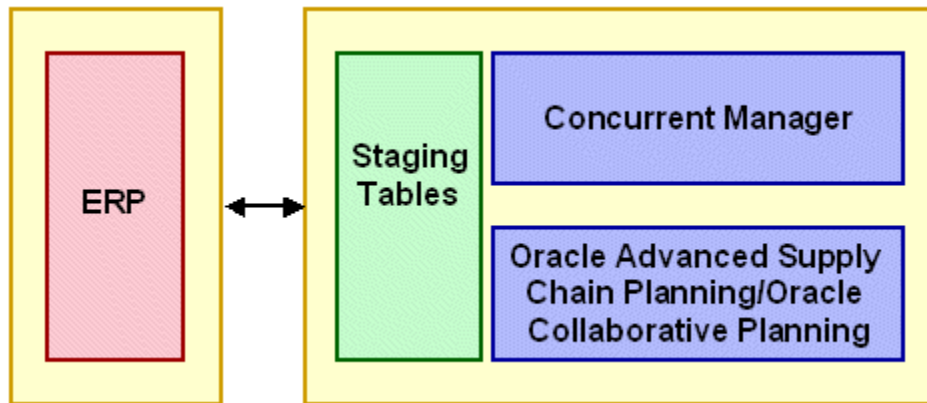

### Three Machine Implementation

A three-machine deployment allows for the manipulation of high-dimensionality, large-scale demand planning data to occur on a machine separate from the planning calculations done on the planning server. The following image depicts this type of implementation:

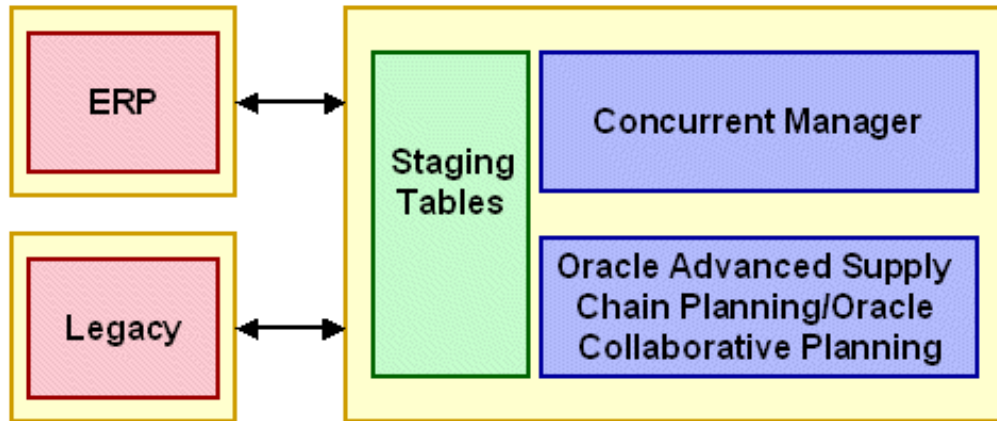

For all deployment configurations, a collection process brings data from the source to the destination instance.

## Setup with Oracle e-Business Suite

The setup for a deployment with the Oracle e-Business Suite or with Oracle Advanced Planning and Scheduling requires the same steps.

1. Set up Profile Options, page 2-5
2. Define Customers, Suppliers, and Sites, page 2-7
3. Define Users and Assign Responsibilities, page 2-8
4. Set Up Calendar, page 2-16
5. Set Up Items, page 2-21
6. Set Up Oracle iSupplier Portal, page 2-22
7. Set Up Buyer Code and Item Category for Advanced Search, page 2-23

When you deploy Oracle Collaborative Planning with Oracle Advanced Supply Chain Planning, or as part of the Oracle e-Business Suite:

- Key entities are set up in source ERP instances
- Oracle Advanced Planning and Scheduling collection programs are used to enable setups in Oracle Collaborative Planning
- Supplies and demands in the source instance are collected to Oracle Collaborative Planning
- Trading partner supplies and demands are uploaded using flat files

## Set up Profile Options

Set profile options to correctly use Oracle Collaborative Planning in your business. For example, if you configure Oracle Collaborative Planning with Oracle iSupplier Portal, you must set the MSC: Configuration profile option to include Oracle Collaborative Planning and Oracle iSupplier Portal.

Complete the following steps to set up profile options:

1. Log in under the System Administrator responsibility.
2. Navigate to Profile > System. The following image depicts this navigational path:

### Navigator - System Administrator

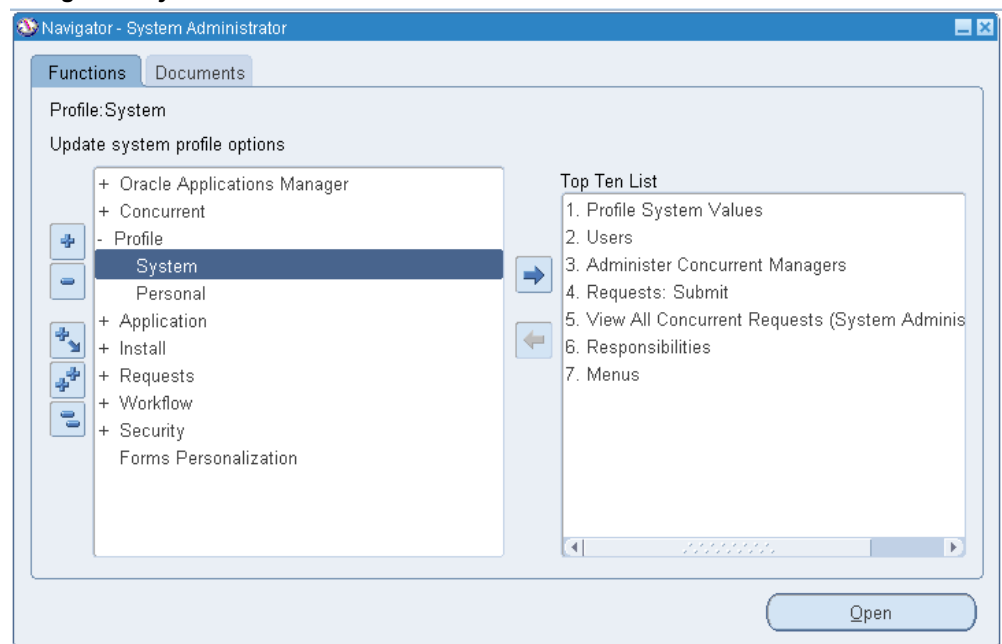

3. In the Find System Profile Values window, select Application. The following image depicts the Find System Profile Values window:

**Find System Profile Values Window**

4. Search and select Oracle Advanced Supply Chain Planning in the Application field.
5. In the Profile field, enter MSC% and select Find.
6. On the System Profile Values window, set the necessary profile options. The following table lists the profile options, their necessary values, and profile option descriptions.

Profile Option	Value	Description
MSC: Configuration:	APS & CP	Indicates that the APS data model is activated.
MSC: Operator Company Name	Your company name	Name issued by the company deploying Oracle Collaborative Planning.
MSC: Vertical View Default Query	Yes	Ensures that the vertical view displays a default set of results.

Profile Option	Value	Description
MSC: VMI Default Query	Yes	Ensures that the VMI screen displays a default set of results.

**Note:** If Oracle Collaborative Planning and Oracle Advanced Supply Chain Planning are installed on a different server than the rest of your Oracle ERP applications, you must set two additional profile options:

**Note:** FND: Debug Log Enables = Blank or No

**Note:** ICX: Session Timeout = Blank

7. Save your work.

For more information about the profile options used in Oracle Collaborative Planning, refer to Profile Options, page A-1.

## Define Customers, Suppliers, and Sites

Create customers, suppliers, and in the source instance, then collect them to Oracle Collaborative Planning. After you set up your information in an Oracle ERP system, the data is collected into Oracle Advanced Supply Chain Planning and Oracle Collaborative Planning.

### Define Customers and Customer Sites

Customers are defined in Oracle Order Management, using the Customers - Standard window. When defining a customer, enter the customer site in the location column. After defining your customers, run a targeted trading partners data collection to collect new customers into Oracle Collaborative Planning.

For more information about defining customers, refer to the *Oracle Order Management Implementation Suite*.

### Define Suppliers and Supplier Sites

Suppliers are defined in Oracle Purchasing using the Supply Base - Suppliers window. When defining a supplier, enter the supplier site in the location column. After defining your suppliers and their sites, run a targeted trading partners data collection to collect new suppliers into Oracle Collaborative Planning.

For more information about defining suppliers, refer to the *Oracle Payables User Guide*.

## Define Users and Assign Responsibilities

The system administrator of the Oracle ERP system sets up new accounts for users. You must specify the contact persons when defining customers in Oracle Order Management or suppliers in Oracle Purchasing. After specifying the contact persons the system administrator defines the user. Provide the following information:

- Username
- Contact Person
- Description

### Define Users

You can define users that belong to your company, your supplier's company, or your customer's company. You must set up supplier users as contacts for supplier sites before they can be registered as users. Customer users must be setup as contacts for customer sites before they can be registered as users. After establishing the users in the Oracle ERP system, run a targeted user company association data collection to collect new users. Select the option to create and enable user company association.

1. Using the System Administrator responsibility, in an Oracle application, navigate to Security > User > Define. The following image depicts this navigational path:
2. In the Users window, enter the username you created in the source instance and assign the user the Supply Chain Collaboration Planner responsibility. The following image depicts the Users window:



### Users Window

Responsibility	Application	Description	Security Group	Effective Dates
				From To

3. A user must be a member of your company or a member of an established customer or supplier in the Oracle ERP system. Customers are maintained in the Oracle Order Management system. You must have certain responsibilities to create a new user. To establish a customer user in Oracle Collaborative Planning, you must complete the following in the Oracle ERP system:
  1. In Oracle Order Management, navigate to Order Management > Customer > Trading Community > Trading Community > Customers > Standard. The following image depicts this navigational path:

**Navigator - Manufacturing and Distribution Manager Window**

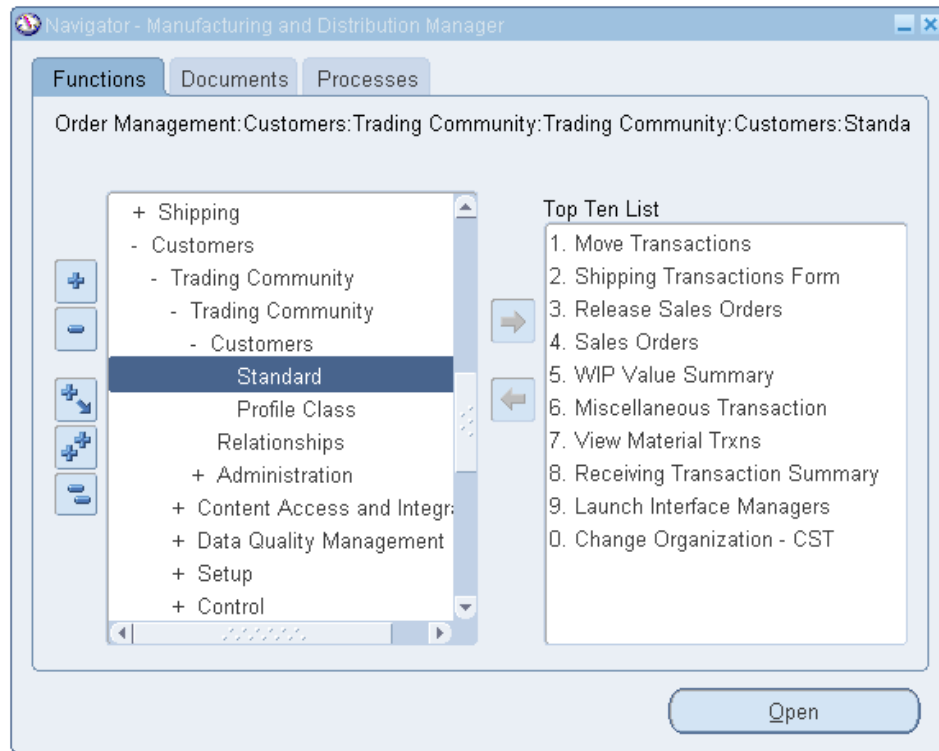

2. In the Customers screen, search for a customer and select Create. The following image depicts the Customers screen:

Customers Screen

ORACLE® Receivables
Home [Logout](#) [Preferences](#) [Diagnostics](#)

Customers

**Customers**

Customer Type Person ▼

---

**Search**

**Simple Search** [Advanced Search](#)

Name	<input type="text" value="Jean Smith"/>	Job Title	<input type="text"/>
Phone Number	<input type="text"/>	E-Mail Address	<input type="text"/>
Registry ID	<input type="text" value="15147"/>	Taxpayer ID	<input type="text"/>
Account Number	<input type="text"/>	Related Organization	<input type="text"/>
Status	<span style="border: 1px solid #ccc; padding: 2px;">Active</span> ▼		
<input type="button" value="Go"/> <input type="button" value="Clear"/>			

Select	Name	Registry ID	Party Type	Address	Country
◉	JEAN SMITH	15147	PERSON	54 SUTTON ST, HEMPSTEAD, NY 11550	United States

**Accounts**

Status Active ▼

Account Number	Account Description	Primary Bill-To Profile Class	Address	Details
No results found.				

- In the Customers screen, enter a customer name and contact information. The following image depicts the Customers screen:

## Customers Screen

The screenshot displays the Oracle Receivables interface. At the top, the Oracle logo and 'Receivables' are visible, along with navigation links for Home, Logout, Preferences, and Diagnostics. The 'Customers' tab is active, and the 'Create Person' form is shown. The form includes a 'Customer Type' dropdown set to 'PERSON'. Below this is the 'Person Information' section, which contains a tip: 'TIP Only a first or last name is required.' The form fields are as follows:

Prefix	Ms.
First Name	Jean
Middle Name	
Last Name	Smith
Suffix	
Taxpayer ID	
Tax Registration Num	
Contact Number	VAT Number. 00141852231823
Job Title Code	
Context Value	
FSCSM_g 1 (150 c)	
FSCSM_g 2 (3 d)	
FSCSM_g 3 (3 c)	
AST_GDE_PartyHeader	

4. Save your work.
5. Change the responsibility to System Administrator and navigate to Security > User > Define.
6. In the Users window enter a user name, description, and contact person.  
Supplier information is maintained in Oracle Purchasing.  
To establish a supplier user in Oracle Collaborative Planning, enter the following in your source instance:
7. In the Oracle Purchasing system, navigate to Purchasing > Supply Base > Suppliers. The following image depicts this navigational path:

**Navigator - Manufacturing and Distribution Manager Window**

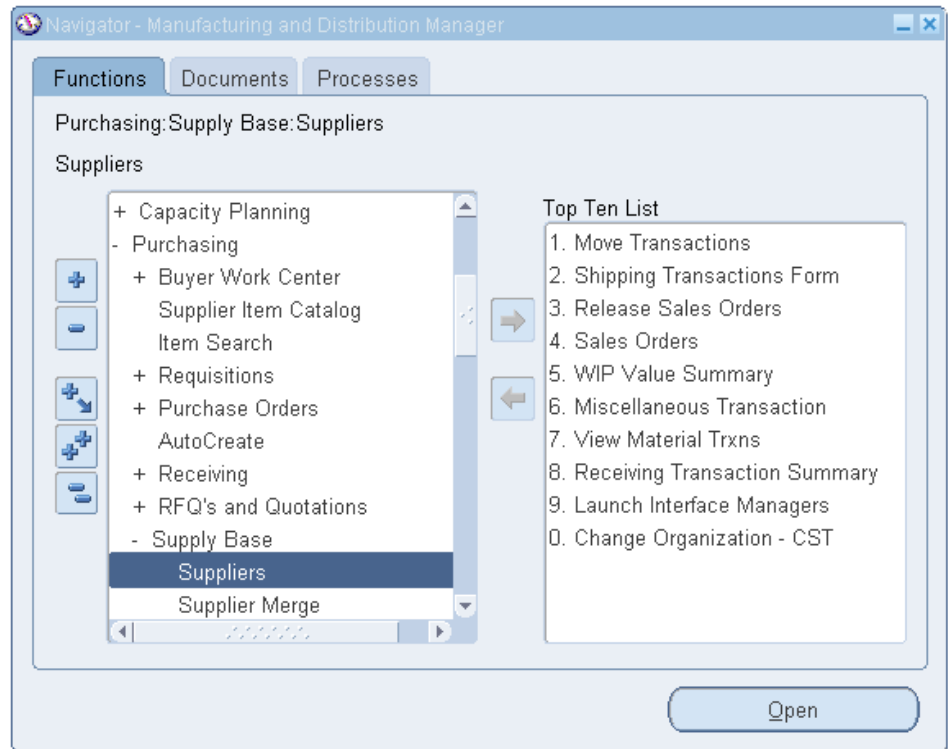

8. In the Suppliers screen, search for Supplier Name and select the supplier site.  
The following image depicts the Suppliers screen:

**Suppliers Screen**

Supplier Name ^	Supplier Number	Parent Supplier Name	Taxpayer ID	Tax Registration Number	DUNS Number	Update
Office Max	5011		43-4564833	39-2329237		

- After you select the supplier site, select Address Book > Contact Directory on the left hand pane and enter information for a contact person. The following image depicts the Contact Directory screen for a supplier site:

**Contact Directory Screen**

First Name	Last Name	Phone Number	Email Address	Has User Account	Status	Update
No results found.						

- Save your work.
- Switch to the System Administrator responsibility and navigate to Security > User > Define.

12. On the Users window, enter a user name, description, and assign the Supply Chain Collaboration Planner responsibility.
  13. Search and select a contact name. Oracle Collaborative Planning links the contact supplier information to the new user.
4. If your implementation of Oracle Collaborative Planning exists on a separate machine from the Oracle ERP system, then customer or supplier users must be established in the Oracle Collaborative Planning system.

To establish a customer or supplier user in Oracle Collaborative Planning, you must complete the following steps:

1. Define a new user by navigating to Security > User > Define. The System Administrator creates new accounts.
2. In the Users window, enter the same username you created in the Oracle ERP system and assign the Supply Chain Collaboration Planner responsibility.
3. Run a targeted data collection to collect company user association from the Oracle ERP system into the Oracle Collaborative Planning system. Set the flag on the Company User Association parameter to enable user company association. For more information on running data collections, see refer to Run Data Collections, page 2-43.
4. Maintain the company site information in the Oracle ERP system and collect data to Oracle Collaborative Planning.
5. Customers and suppliers can post their supplies and demands into the Oracle Collaborative Planning system.

To create users and enable user company association:

6. Switch to the Advanced Supply Chain Planner responsibility. Navigate to Collections > Oracle Systems > Data Collection.
7. In the Planning Data Collections window, select the Parameters field.
8. In the Parameters window, complete the following fields:
9. Instance
10. Purge Previously Collected Data = No
11. Collection Method = Target Refresh
12. User Company Association = Create Users and Enable User Company Association

13. Select OK.
14. Start data collections. After successfully collecting data to the Oracle Collaborative Planning system, new users can log into Oracle Collaborative Planning and view or create new transactions. For more information on running data collections, Run Data Collections, page 2-43.

### Assign Responsibilities

Reserve the Supply Chain Collaboration Administrator responsibility for a system administrator who has responsibility for the whole deployment. The following table lists the different types of users, which responsibilities you can assign to them, and the responsibility description:

Responsibility	Company Users	Supplier Users	Customer Users	Responsibility Description
Supply Chain Collaboration Planner	Yes	Yes	Yes	Provides users access to planner tasks.
Supply Chain Collaboration Manager	Yes	Yes	Yes	Provides users access to planner and administrative tasks.
Supply Chain Collaboration Administrator	Yes	No	No	Provides users access to planner and administrative tasks. The user can create security rules that apply to supplies and demands posted by all companies.

### Set Up Calendar

The calendar in Oracle Collaborative Planning is a 7-0 calendar, where all days are workdays, the week begins on Monday, and the month begins on the first day of the calendar month. Set up the calendar for Oracle Collaborative Planning by running the concurrent program Build Collaborative Planning Calendar.

Complete the following steps to set up the calendar in Oracle Collaborative Planning.

1. Log in using the Advanced Supply Chain Planner responsibility.
2. Navigate to Other > Request. The following image depicts this navigational path:



**Navigator - Advanced Supply Chain Planner Window**

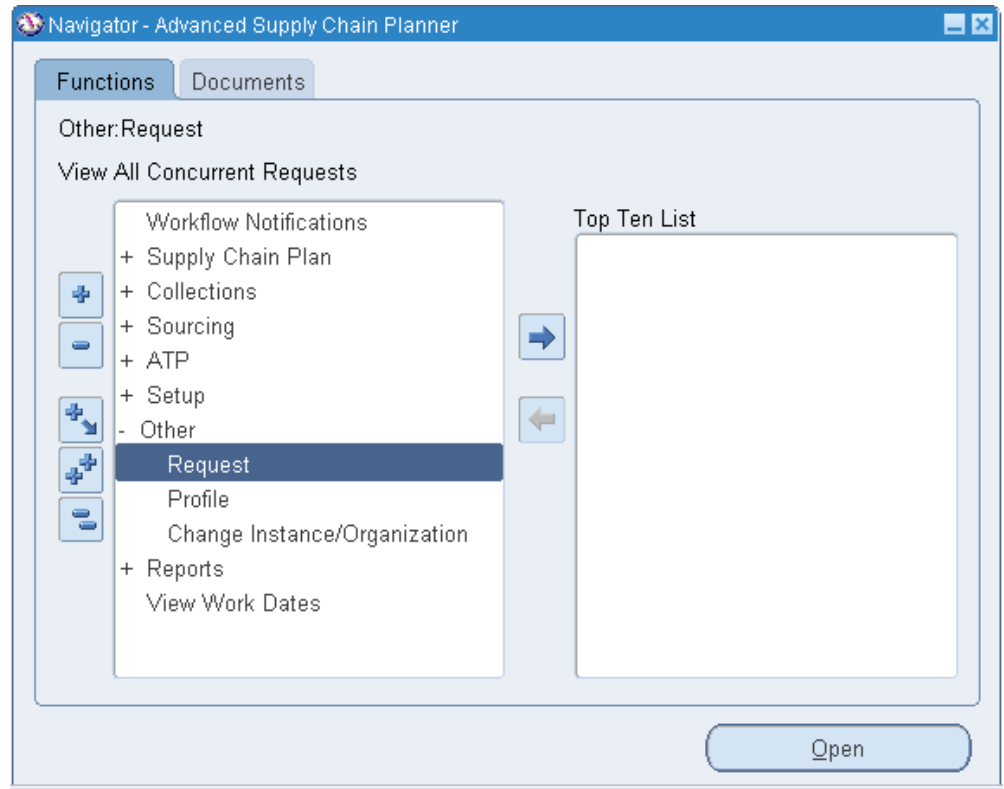

3. In the Find Requests window, select Submit a New Request. The following image depicts the Find Requests window:

### Find Requests Window

The screenshot shows a window titled "Find Requests" with a blue header bar. Below the header, there are four radio button options: "My Completed Requests", "My Requests In Progress", "All My Requests" (which is selected), and "Specific Requests". Under "Specific Requests", there is a group box containing several input fields: "Request ID", "Name", "Date Submitted", "Date Completed", "Status" (a dropdown menu), "Phase" (a dropdown menu), and "Requestor". Below this group box, there is a checkbox labeled "Include Request Set Stages in Query" which is unchecked. Below the checkbox is an "Order By" dropdown menu currently set to "Request ID". Below the dropdown is a text input field labeled "Select the Number of Days to View:" with the number "7" entered. At the bottom of the window, there are three buttons: "Submit a New Request...", "Clear", and "Find".

4. On the Submit a New Request window, select Single Request and select OK. The following image depicts the Submit a New Request window:

**Submit a New Request Window**

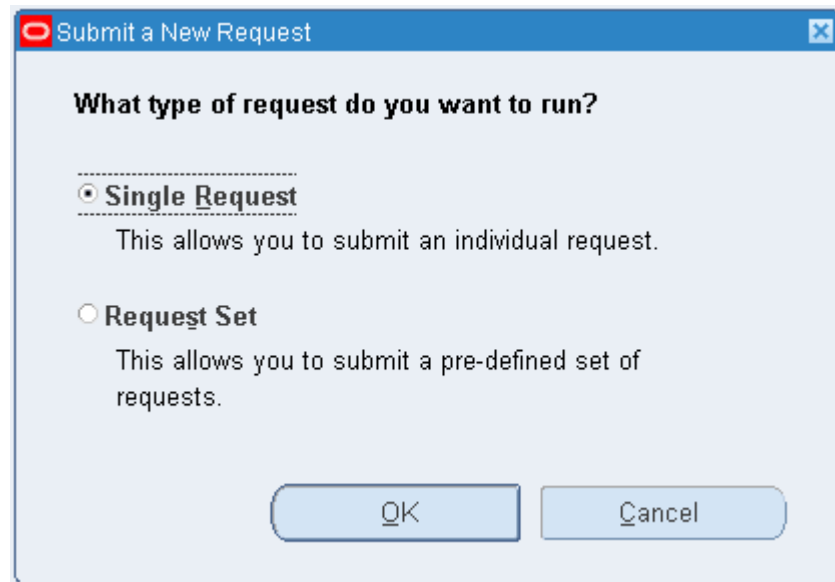

5. In the Submit Request window select Build Collaborative Planning Calendar. The following image depicts the Submit Request window:

### Submit Request Window

The screenshot shows a 'Submit Request' dialog box with the following fields and options:

- Run this Request...**: Includes a 'Copy...' button.
- Name**: Text field containing 'Build Collaborative Planning Calendar'.
- Operating Unit**: Empty text field.
- Parameters**: Empty text field.
- Language**: Text field containing 'American English'. Includes 'Language Settings...' and 'Debug Options' buttons.
- At these Times...**: Includes 'Run the Job' text field with 'As Soon as Possible' and a 'Schedule...' button.
- Upon Completion...**: Includes a checked checkbox for 'Save all Output Files', 'Layout' text field, 'Notify' text field, 'Print to' text field with 'noprint', and an 'Options...' button.
- Buttons**: 'Help (C)', 'Submit', and 'Cancel' buttons are located at the bottom.

6. In the Parameters window, select OK. The following image depicts the Parameters window:

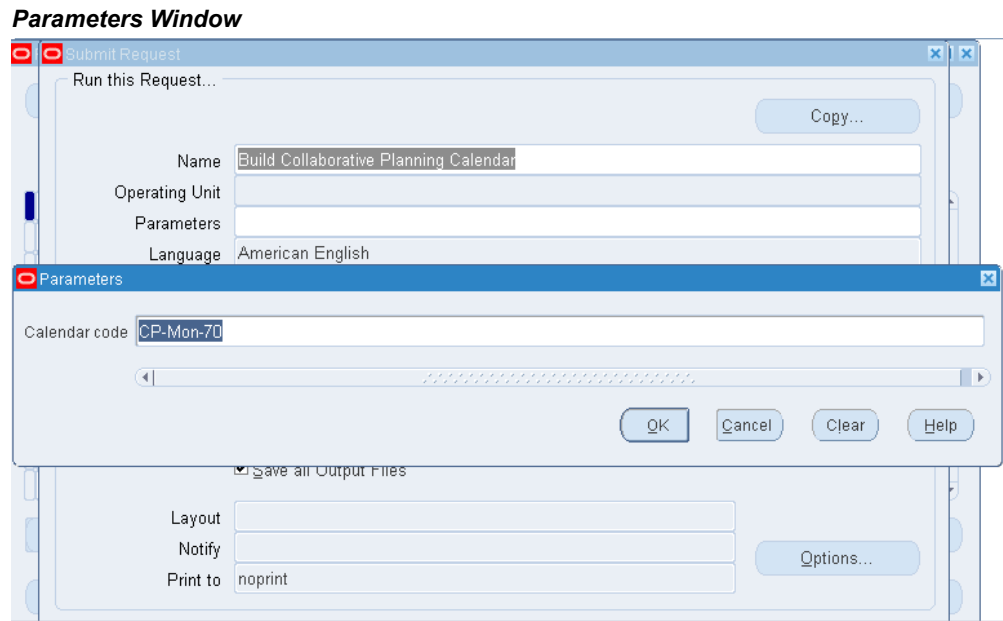

7. In the Submit Request window, select Submit.

## Set Up Items

If you deploy Oracle Collaborative Planning with the Oracle e-Business Suite, you create items in the Oracle ERP system and collect them into the Oracle Collaborative Planning system.

Items are created in Oracle Inventory. Run an items data collection to receive items into Oracle Collaborative Planning. You must run a data collection to collect any new items that may be part of your collaboration with your customers and suppliers.

Complete the following steps to set up items:

1. Log in using the Manufacturing and Distribution Manager responsibility.
2. In the Manufacturing and Distribution Manager window, navigate to Inventory > Items > Master Items.
3. In the Master Item window, enter your item information. For more information about item setup, refer to the *Oracle Inventory User's Guide*. The following image depicts the Master Item window:

## Master Item Window

Organization: V1 Vision Operations

Item: [ ]

Description: [ ]

Display Attributes:  Master  Org  All

Main Inventory Bills of Material Asset Management Costing Purchasing Receiving Physical Attributes

Unit of Measure

Primary: Each

Tracking: Primary

Pricing: Primary

Secondary: [ ]

Defaulting: [ ]

Deviation Factor +: 0 %

Deviation Factor -: 0 %

Conversions

Standard

Item specific

Both

User Item Type: [ ]

Item Status: Active

Long Description

4. Save your work.
5. Run a data collection to load the items into Oracle Advanced Supply Chain Planning and Oracle Collaborative Planning. For more information on running data collections, refer to Run Data Collections, page 2-43.

## Setup Oracle iSupplier Portal

When you deploy Oracle iSupplier Portal and Oracle Collaborative Planning together, your supplier users can access both applications through a combined portal. This is accomplished by assigning supplier users the Supplier Collaboration Full Access responsibility. After creating Supplier Collaboration responsibility, you can then access a combined home page that features the functionality of both Oracle iSupplier Portal and Oracle Collaborative Planning.

To setup Oracle iSupplier Portal and Oracle Collaborative Planning together, you must install Oracle Collaborative Planning on the same instance as your Oracle ERP system. You must have the System Administrator responsibility to assign responsibility to users.

Complete the following steps to set up users for access to Oracle iSupplier Portal and

Oracle Collaborative Planning:

1. Log in under the Supplier User Management responsibility.
2. Navigate to supplier User Management > Register Supplier User.
3. Provide registration details.
4. Save your work.

## Set Up Buyer Code and Item Category for Advanced Search

### Setup in Oracle Inventory

To enable the search by buyer code, you must associate a buyer with an item on the Purchasing tab on the Master Items window or the Organization Items window. For more information about associating a buyer with an item, see *Oracle Inventory User's Guide*.

### Setup in Oracle Advanced Supply Chain Planning

To categorize supply/demand data based on item categories, set up the MSC: Category set for the CP Horizontal View profile option. This profile option indicates a category set that planners might use for queries in the Oracle Collaborative Planning Horizontal View. This profile option restricts queries to specific categories as selected by the planner. For more information about setting this profile option, see *Oracle Advanced Supply Chain Planning Implementation and User's Guide*.

## OEM User Setup

An OEM user is a member of your company that uses Oracle Collaborative Planning. This person will have access to your company data. Complete the following steps to create this type of user.

1. Log in under the System Administrator responsibility.
2. Navigate to Security > Users > Define.
3. Enter a username and assign the Supply Chain Collaboration Planner responsibility. If the user already exists, add the Supply Chain Collaboration Planner responsibility to the user and save your changes. If your implementation of Oracle Collaborative Planning exists on a separate machine from your Oracle ERP system, then you must create the user in the Oracle ERP system first.
4. Switch responsibilities to Advanced Supply Chain Planner > Collections > Oracle Systems > Data Collection
5. To perform a targeted collection, set the parameter value Purge Previously

Collected Data to No. Set all other values to No. Set the value for the User Company Association parameter to Enable User Company Association.

**6.** Select Submit.

You can set up site-level contacts for your trading partners, so that the planning engine generates a notification for the related trading partner after the user publishes a supply or demand statement. This enables the related trading partner to be aware of the change in supply and demand information on time and to perform required actions without unnecessary delay. The notification contains a summary of:

- Items published
- Publisher
- Order type published

The following image depicts a notification to the supplier site contact for an order forecast that was published:



### Notification after Publishing Order Forecast

The screenshot shows the Oracle Collaborative Planning interface. At the top, there is a blue header with the Oracle logo and the text "Collaborative Planning". Below the header, there are navigation links: "Home", "Logout", "Preferences", "Help", "Personalize Page", and "Diagnostics". A secondary navigation bar contains "Home", "Exceptions", "Planning", and "Admin". The main content area displays a notification titled "Standard Purchase Order 72014 has been approved". Below the title are three buttons: "OK", "Reassign", and "Request Information". The notification body includes a link to "Personalize 'Notification Details Function'", followed by "Personalize 'Notification Details Attributes'", and details such as "To Collaborative Planning trading partner role", "Sent 06-Jan-2006 00:00:00", and "ID 1097681". A link "Personalize Region" is also present. The notification lists several item IDs: CM1245, CM3456, CM3532, AS4527, and AS4689. At the bottom, it states "Receive Order Forecast concurrent program has been launched with request id 3261142".

Complete the following steps to set up the site level contacts for your trading partners.

#### Steps in Oracle Purchasing

Set up supplier site-level contacts in the Requisition Preferences window in Oracle Purchasing. For more information about setting up site-level contacts for suppliers, see "Entering Requisition Preferences" in *Oracle Purchasing User's Guide*.

#### Steps in Oracle Order Management

Set up customer level contacts in the Add Customer window in Oracle Order Management.

Note that you cannot create site-level contacts using the Add Customer window. However, customer-level contacts can be used as site level contacts for orders or returns.

For more information about setting up customer-level contacts for, see "Adding Customers using the Add Customer window" in *Oracle Order Management User's Guide*.

**Note:** You cannot notify the site contacts for the related trading

partners if you are using a standalone Collaborative Planning application because you must set up the site contacts in Oracle Purchasing and Oracle Order Management.

## Standalone Setup

### Set Up the Legacy Instance

To set up Oracle Collaborative Planning as a standalone product, you must first set up the legacy instance and then load planning organizations, customers, and suppliers.

Complete the following steps to set up the legacy instance:

1. Apply the legacy integration patch on the concurrent manager node on which you installed Oracle Collaborative Planning. If you have multiple concurrent manager nodes that are not NFS mounted, you must apply this patch on all the nodes. The patch copies all the control files to the \$MSC\_TOP/patch/120/import directory. You must enter the complete path of this directory as a value for the Control Files Directory parameter of the flat file load stage when you run the legacy system data collection.

Use steps 2 through 6 to create a partition for a new instance.

2. Log in using the System Administrator responsibility.
3. Select Requests > Run.
4. Select Single Request and select OK.
5. In the Name field, enter Create APS Partitions and select OK.
6. Enter the number of plan partitions and instance partitions and select OK.
7. Change to the Advanced Planning Administrator responsibility. Select Admin > Instances.

### Set Up Profile Options

Profile options setup for a standalone implementation is the same as for an integrated implementation.

Complete the following steps to set up profile options:

1. Log in under the System Administrator responsibility.
2. Navigate to Profile > System. The following image depicts this navigational path:

### Navigator - System Administrator Window

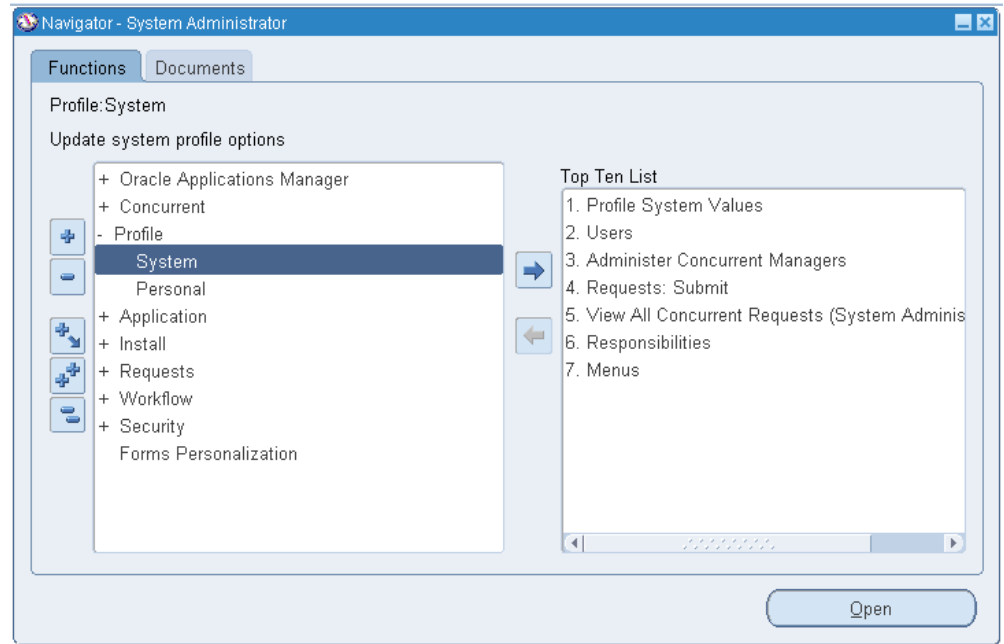

3. In the Find System Profile Values window, select Application. The following image depicts the Find System Profile Values window:

**Find System Profile Values Window**

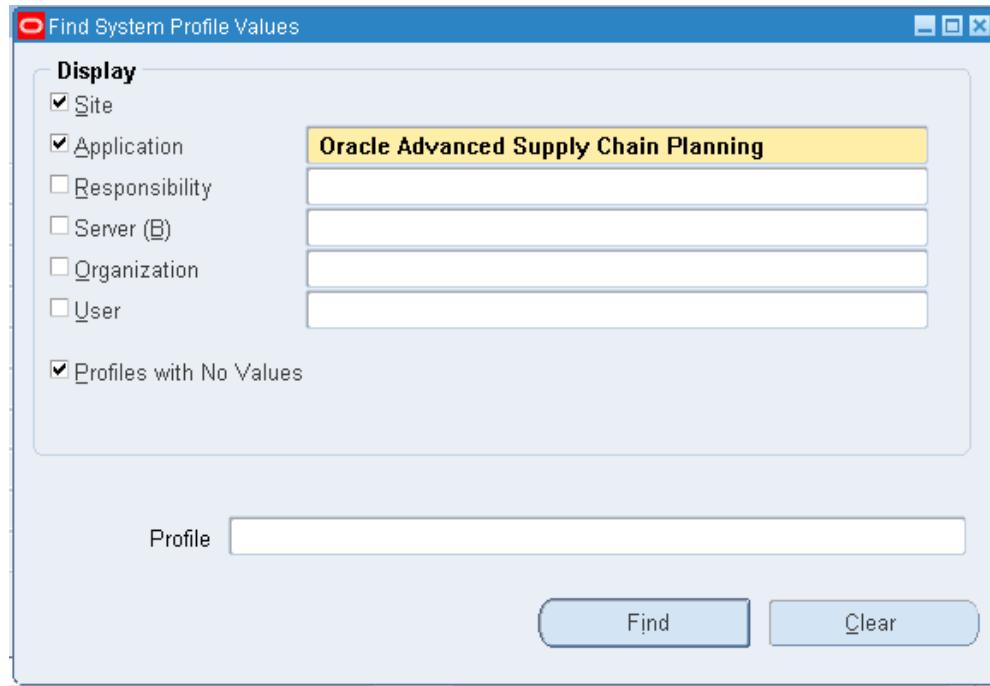

4. Search and select Oracle Advanced Supply Chain Planning in the Application field.
5. Specify the Instance Code for the Legacy Instance and set the Instance Type as Other. Leave the fields From Source to APS and From APS To Source blank. Fill the other fields for the instance as specified in the on-line help.

You can now use the batch load solution. Upload the Calendar data for this instance.

**Note:** The batch upload and legacy instance setup steps can occur parallel to script for data upload creation. The instance code is required to retrieving data files from the scripts.

6. In the Profile field, enter MSC% and select Find.
7. On the System Profile Values window, set the necessary profile options. The following table lists the profile options, their necessary values, and profile option descriptions.

Profile Option	Value	Description
----------------	-------	-------------

Profile Option	Value	Description
MSC: Configuration:	CP	Indicates that collection programs are used.
MSC: Operator Company Name	Your company name	Name issued by the company deploying Oracle Collaborative Planning.
MSC: Vertical View Default Query	Yes	Ensures that the vertical view displays a default set of results.
MSC: VMI Default Query	Yes	Ensures that the VMI screen displays a default set of results.

8. Save your work.

For more information about the profile options used in Oracle Collaborative Planning, refer to Profile Options, page A-1.

## Define Customers, Suppliers, and Sites

For a standalone setup of Oracle Collaborative Planning, customers, suppliers, and sites must be loaded using flat files. Use the flat file *tradingpartner.dat* to load customers, and *tradingpartnersite.dat* to load customer sites. Use the flat file *tradingpartner.dat* to load suppliers, and *tradingpartnersite.dat* to load supplier sites. When defining sites, upload *tradingpartner.dat* and *tradingpartnersite.dat* in a single zip file.

For more information about uploading data into Oracle Collaborative Planning refer to Loading and Publishing Data, page 2-39.

## Define Users and Assign Responsibilities

For a standalone setup of Oracle Collaborative Planning, define users and assign responsibilities through flat file loads.

### Define Users

Upload the *partnercontact.dat* flat file to define contacts for trading partner sites. To set up users, you must provide the following information:

- Username
- Customer or supplier information

For more information about uploading data into Oracle Collaborative Planning, refer to Loading and Publishing Data, page 2-39.

### **Assign Responsibilities**

You can assign the following responsibilities for a standalone setup:

- Supply Chain Collaboration Planner
- Supply Chain Collaboration Manager

The Supply Chain Collaboration Planner responsibility provides users with access to planner tasks. The Supply Chain Collaboration Manager responsibility provides users with access to planner and administrative tasks.

### **Set Up Calendar**

The calendar in Oracle Collaborative Planning is a 7-0 calendar, where all days are workdays, the week begins on Monday, and the month begins on the first day of the calendar month. Set up the calendar for Oracle Collaborative Planning by running the concurrent program Build Collaborative Planning Calendar.

Complete the following steps to set up the calendar in Oracle Collaborative Planning.

1. Log in using the Advanced Supply Chain Planner responsibility.
2. Navigate to Other > Request. The following image depicts this navigational path:

**Navigator - Advanced Supply Chain Planner Window**

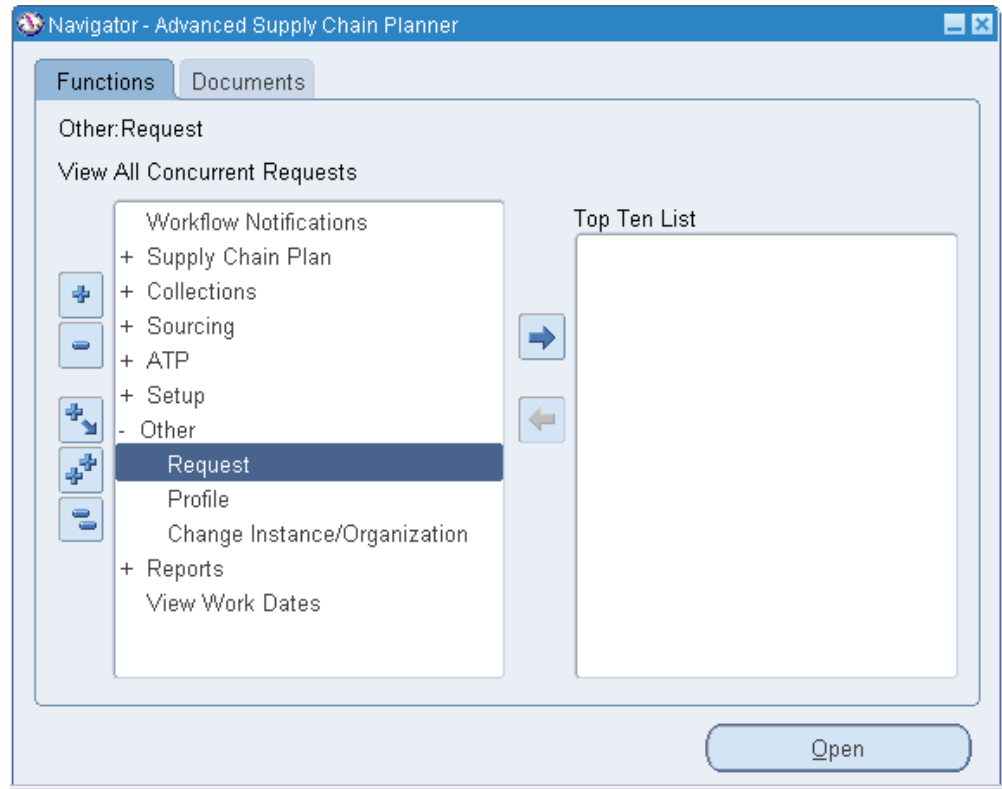

3. In the Find Requests window, select Submit a New Request. The following image depicts the Find Requests window:

### Find Requests Window

The screenshot shows a window titled "Find Requests" with a blue header bar. Below the header, there are four radio button options: "My Completed Requests", "My Requests In Progress", "All My Requests" (which is selected), and "Specific Requests". Under "Specific Requests", there is a group box containing several input fields: "Request ID", "Name", "Date Submitted", "Date Completed", "Status" (a dropdown menu), "Phase" (a dropdown menu), and "Requestor". Below this group box, there is a checkbox labeled "Include Request Set Stages in Query" which is unchecked. Below the checkbox is an "Order By" dropdown menu currently set to "Request ID". Below that is a label "Select the Number of Days to View:" followed by a text input field containing the number "7". At the bottom of the window, there are three buttons: "Submit a New Request...", "Clear", and "Find".

4. In the Submit a New Request window, select Single Request and select OK. The following image depicts the Submit a New Request window:



**Submit a New Request Window**

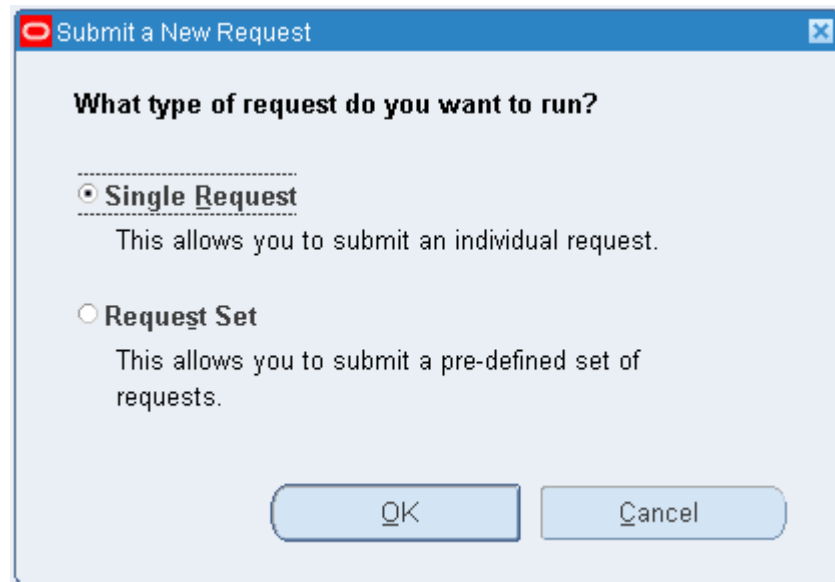

5. In the Submit Request window select Build Collaborative Planning Calendar. The following image depicts the Submit Request window:

### Submit Request Window

The screenshot shows a 'Submit Request' dialog box with the following fields and options:

- Run this Request...**
  - Name: Build Collaborative Planning Calendar
  - Operating Unit: (empty)
  - Parameters: (empty)
  - Language: American English
  - Buttons: Copy..., Language Settings..., Debug Options
- At these Times...**
  - Run the Job: As Soon as Possible
  - Button: Schedule...
- Upon Completion...**
  - Save all Output Files
  - Layout: (empty)
  - Notify: (empty)
  - Print to: noprint
  - Button: Options...
- Bottom Buttons:** Help (H), Submit, Cancel

6. In the Parameters window, select OK. The following image depicts the Parameters window:

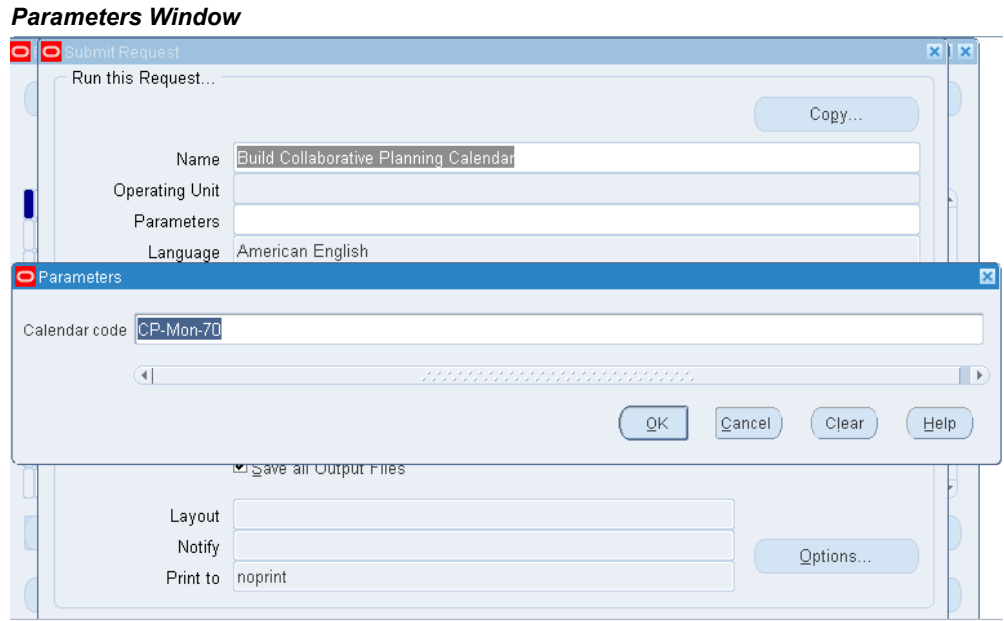

7. In the Submit Request window, select Submit.

## Set Up Items and Other Entities

For a standalone setup of Oracle Collaborative Planning, defining items and other entities is achieved using flat file loads. Upload the *item.dat* flat file to set up your items. Upload the *supplieritems.dat* flat file to cross-reference a supplier item with one of your items. Upload the *customeritems.dat* flat file to cross-reference a customer item with one of your items.

For more information about uploading flat files, refer to *Loading and Publishing Data*, page 2-39.

## Setting Up Multi-Tier Collaboration in Oracle Collaboration Planning

To enable multi-company collaboration for your organization, you must set up the following key elements in Oracle E-Business Suite.

### Setup Steps in Oracle Order Management

#### Register the customer

You can register a customer in Oracle Order Management using Add Customers window that is accessible from the Sales Order Header window. You can define new entities for customers and related entity details (customer details) here. Alternatively,

you can enter appropriate values in the respective fields in the Sales Order Header window and send the existing customer or contact details to the Add Customer window. You can apply the following process to open the Add Customers window:

1. From the Orders, Returns menu in the Order Management Navigator, select Sales Orders. This opens the Sales Orders - [New] window.
2. With your cursor in any field, right-click and select Add Customer from the Customer submenu.

For more information on "Adding customers using the Add Customer window," see *Oracle Order Management User's Guide*.

## Setup Steps in Oracle Inventory

### Set up the internal inventory organizations and define the items

Before defining external inventory organization you need to define one or more internal inventory organizations. These inventory organizations describe distinct entities in your company and act as prerequisites to items and any related transaction. You can assign a unique short code to your inventory organization and use this code to identify the organization with which you want to work. For more information on creating internal inventory organizations see *Oracle Inventory User's Guide*.

After defining the inventory organizations:

- Define item catalog groups to group your items according to certain descriptive elements. An item catalog group consists of descriptive elements to which you assign certain sets of values that can be assigned to an item.
- Define an item template to list a standard set of attribute values that you use to define or update items. When you apply a template to an item, you set the item attribute values to the template attribute values for those attributes that you enable in the template.
- Define items and the attributes associated with them, such as description, lead-time, units of measure, lot control, and so on.

For more information on creating internal inventory organizations, item category groups, item templates, and items, see *Oracle Inventory User's Guide*.

## Setup Steps in Oracle Purchasing

### Create inventory organizations to represent suppliers and supplier sites

Define one or more inventory organizations to describe separate suppliers and supplier sites associated with your organization. To fully reap the benefits of multi-company collaborative planning, additional modeling for contract manufacturers is required. A

contract manufacturer is a special case of a supplier, and it requires special modeling to collaborate at a more detailed level. For more information on defining inventory organizations and associating them with suppliers and supplier sites, see *Oracle Purchasing User's Guide*.

### **Create an external organization to associate with the supplier site representing the contract manufacturer's site**

You can follow either of the two approaches:

1. Create CM inventory organization in Oracle E-Business Suite and associate it with the contract manufacturer.

Follow this approach if any of the following conditions are true:

- Execution transactions such as WIP completions at the CM's site affect financial accounting at the OEM organization.
  - CM maintains transaction and reference data.
2. Create CM inventory organization in Legacy instance on planning server.

Follow this approach if any of the following conditions are true:

- Producing an accurate picture of supply and demand at the CM's site is more important than costing and tracking financial transactions.
- CM is not required to enter transaction data through standard Oracle E-Business Suite interfaces.

Note that, both the CM and supplier must be registered in Purchasing before proceeding with the rest of the setup steps. For more information on associating the contract manufacturer's site to an inventory organization, see "Setup: Associate the contract manufacturer's site to an inventory organization."

### **Associate a supplier site with an inventory organization**

Once you have registered the contract manufacturer and its site in Purchasing and created the inventory organization, you must associate the contract manufacturer's site with the organization. When an inventory organization is designated as a supplier's site, the planning system creates orders which source material from this site as external orders. ASCP treats this inventory organization similar to an internal organization with a few exceptions:

- A planned order sourcing material from this inventory organization may be released from the planner's workbench to create an external requisition to the supplier. The requisition becomes a purchase order when it is approved in Purchasing.
- The planning process will explode the bill of material for an item on a purchase order when the item is sourced from the contract manufacturer's inventory

organization. For this to occur, the "Accept Demands from Unmet PO" parameter of the Create Instance-Org Supplier Association concurrent program (described below) must be set to Yes.

- A sales order posted by the contract manufacturer into its inventory organization can be pegged to a purchase order from the OEM.
- Purchase order supplies for procured materials posted by the contract manufacturer into its inventory organization are firm supplies in the planning system.
- Work orders posted by the contract manufacturer are firm supplies for materials that the contract manufacturer intends to build or presently is producing.

Before associating a supplier site to an inventory organization you must:

1. Define a supplier site.
2. Define an organization of type External.

Complete the following steps to associate a supplier's site with an inventory organization:

1. From the Setup menu in the Inventory Navigator, select Organizations. From the Organizations menu, select Organizations. This opens the Find Organizations window.

#### **The Find Organizations Window**

The screenshot shows a window titled "Find Organization" with the following fields and controls:

- Name: 111-West Region Resources-01
- Type: Business Unit
- Location: Berlin Office
- Organization Classification section:
  - Name: Business Group
  - Enabled (radio button)
  - Disabled (radio button)
  - Either (radio button, selected)
- Buttons: Clear, New (A), Find (B)

2. Find the appropriate inventory organization.
3. In the Organization window, click in the Organization Classifications region to add the Inventory Organization classification.

4. Click the Others button.
5. In the Additional Organization Information dialog box, select Customer/Supplier Association.
6. Enter the supplier and supplier site, and save your changes.

## Loading and Publishing Data

You can load all of your setup data into the system if you are not using Oracle Advanced Supply Chain Planning. If you are using Advanced Supply Chain Planning in conjunction with Oracle Collaborative Planning, set up the majority of your information in the system. You can, however, add files using flat file loads. You can bulk load the following into the Oracle Collaborative Planning:

- Calendar Information
- Calendar Exception Information
- Category Sets
- Company Users
- Customer Items
- Item Categories
- Items
- Planners
- Shift Exceptions
- Shift Times
- Supplier Items
- Supply/Demand Information
- Trading Partners
- Trading Partner Sites
- Unit of Measure
- Workday Patterns

For all collaborative processes and order types, demand and supply data are uploaded

through a flat file. Download this template in the Admin page of Oracle Collaborative Planning.

Oracle Collaborative Planning supports flat file data loads for the following supply/demand order types:

- Historical sales
- Negotiated capacity
- Order Forecast
- Purchase order
- Supply Commit
- Purchase requisition
- Safety stock
- Sales forecast
- Sales order
- Sell through forecast
- Purchase order acknowledgement
- Safety stock
- Projected available balance

During flat file uploads specify sync indicators to identify whether you are deleting or inserting records. The following table lists the available sync indicators and their definitions.

---

<b>Sync Indicator</b>	<b>Definition</b>
D (Delete)	Enables you to delete rows that match the item, publisher, publisher site, supplier, supplier site, order type, order number, release number, line number, end order number, or end order line number.

---



Sync Indicator	Definition
R (Replace)	For a row in the upload file the system searches for all records in Oracle Collaborative Planning that match the item, publisher, publisher site, supplier, supplier site (or customer, customer site for sales orders), order type, order number, release number, line number, end order number, and end order line number and delete them. This is done for each row in the uploaded file, at the end of which the new rows are inserted into Oracle Collaborative Planning.

To upload flat files into Oracle Collaborative Planning, complete the following steps:

1. Access the Oracle Collaborative Planning application.
2. Select the Admin tab.
3. On the Admin page, select Load Setup Data link. The following image depicts the Admin window in Oracle Collaborative Planning.

#### Setup and Administration Window

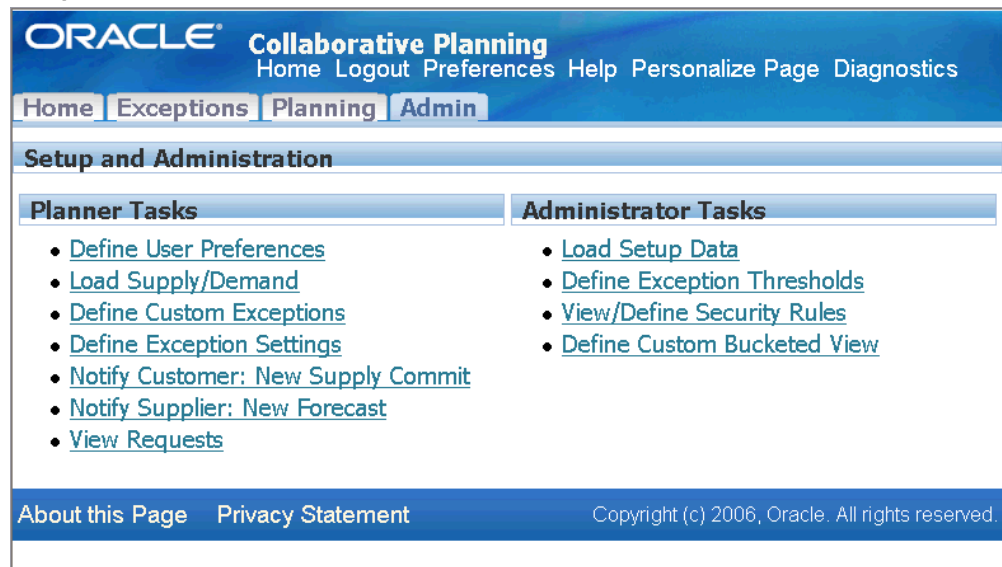

4. Download the template.
5. View the *Readme* document to learn how to fill in the spreadsheet.
6. Complete the spreadsheet.
7. Upload the template on the Load Setup Data page.

**Note:** You must load trading partners (customers and suppliers) before loading company users. Trading partners establish companies, and company users assign specific users to their companies. All companies in Oracle Collaborative Planning must have a trading partner relationship with your company.

## Publish Data Using Oracle Advanced Supply Chain Planning

When Oracle Advanced Supply Chain Planning is installed, you can use with Oracle Collaborative Planning to publish and receive order information. Generate supply information using Oracle Advanced Supply Chain Planning prior to publishing its contents to Oracle Collaborative Planning. Filters enable you to publish information selectively to your trading partners. You can publish order forecasts and supply commits, and receive supplier capacities.

The Publish program honors the planning time bucket specified in the supply chain plan options while publishing or receiving demand and supply information from a supply chain. The Publish program assigns a time bucket of day, week, or month to the data posted to Oracle Collaborative Planning from Oracle Advanced Supply Chain Planning. For more information on time bucketing, see *Horizontal and Advanced Horizontal View: Time Bucketing in Collaborative Planning.*, page 9-10

Complete the following steps to publish or receive demand and supply information:

1. Log in using the Advanced Planning Administrator role.
2. Select Collaboration.
3. Select one of the following:
  - Publish Order Forecast (if you are publishing an order forecast to your suppliers)
  - Publish Supply Commits (if you are publishing a supply commit to your customers)
  - Receive Supplier Capacity (if you are receiving a supplier capacity from your suppliers)
4. In the Parameters window, complete any of the fields and select OK.
5. In the Publish Order Forecast, Publish Supply Commits, or Receive Supplier Capacity window, enter any additional information.
6. Select Submit.

## Publish Data Using Oracle Demand Planning

When Oracle Demand Planning is installed, you can use it with Oracle Collaborative Planning to publish and receive sales forecasts to and from your customers. Generate and commit to forecasts using Oracle Demand Planning prior to publishing its contents to Oracle Collaborative Planning. Filters enable you to publish information selectively to your customers.

Complete the following steps to publish or receive a sales forecast:

1. Log in using the Advanced Planning Administrator role.
2. Select Collaboration.
3. Select one of the following:
  - Publish Forecast to Customer (if you are publishing a forecast)
  - Receive Forecast from Customer (if you are receiving a sales forecast)
4. In the Parameters window, complete any of the fields and select OK.
5. In the Publish Forecast to Customer or Receive Forecast from Customer window, enter any additional information.
6. Select Submit.

## Run Data Collections

To run data collections you must assign yourself the Advanced Supply Chain Planner responsibility. To run data collections, complete the following steps:

1. Change responsibilities to Advanced Supply Chain Planner. Navigate to Collections > Oracle Systems > Data Collections.
2. On the Planning Data Collections window, select the Parameters field.
3. On the Parameters window you must enter information in several fields. The following table identifies these fields and the values you must enter:

Field	Value
Instance	Desired instance
Purge Previously Collected Data	No

Field	Value
Collection Method	Target Refresh
User Company Association	Enable User Company

4. Select OK.
5. Start data collections. After the system loads the data to Oracle Collaborative Planning, the new user can log into Oracle Collaborative Planning and view or create new transactions.

For more information about running data collections, refer to the *Advanced Supply Chain Planning Implementation and User's Guide*.

## Orders

This section discusses orders in Oracle Collaborative Planning. The following topics are discussed:

- Create an Order, page 2-44
- Add Orders, page 2-45
- View Order History, page 2-45

### Create an Order

You can use the following method for posting demand or supply information. This procedure is additional to uploading files. You edit demand or supply information manually using the Enter Order Details page.

1. From the Home page in Oracle Collaborative Planning, select the Planning tab.
2. Select Create Order.
3. In the Enter Order Details page, enter information in the following fields:
  - Orders
  - Item
  - Trading partners

- Dates
  - Shipping
  - Pegging
  - Comments
4. Select Add.

**Note:** To reference field definitions, select Hint.

## Add Orders

In addition to bulk loading order information, you can add an order manually within the system. You can only update or delete existing transactions by loading the *SupplyDemand.dat* flat file. For an order, you can enter the following information:

- Orders
- Item
- Trading partners
- Dates
- Shipping
- Pegging
- Comments

You can access the Enter Order Details page by selecting Create Order from the Planning tab in Oracle Collaborative Planning.

## View Order History

Oracle Collaborative Planning enables you to view versions of an order, make changes as necessary to current orders, and track those changes. You can make changes to any planning (for example, sales or order forecasts) or execution (for example, purchase or sales orders) documents you view in a vertical view. For example, you might need to know what the previous quantity was for a particular order. Oracle Collaborative Planning enables you to view that order information and make any necessary revisions to your order. You changes any of the following parts of an order:

- Quantity

- Receipt date (for an execution document only)
- Revision date information (view only)
- Updated by information (view only)
- Comments

Complete the following steps to view an order history:

1. From the Home page of Oracle Collaborative Planning, select the Planning tab.
2. On the Planning page, select Vertical View.
3. Enter your search criteria and select Search.
4. Choose an order and select View History in that order's row.
5. On the Auditing Details page, view your order.

## Order Types

This section discusses order types used in Oracle Collaborative Planning. The following topics are discussed:

- Supported Order Types, page 2-46
- Renaming Order Types, page 2-49

## Supported Order Types

Oracle Collaborative Planning comes seeded with several different order types. The following table lists these order types and their descriptions.

Order Type	Description
Sales Forecast	Expected future customer shipments. Suppliers can post expected customer future shipments. Quantity and Comments can be edited using vertical view.
Order Forecast	Anticipated future customer orders for a specific item, period, and location. Customers post when supplier should ship the goods. Quantity and Comments can be edited using vertical view.

<b>Order Type</b>	<b>Description</b>
Supply Commit	Anticipated future supplier shipments to customers. Suppliers post when customers should receive the goods. Quantity and Comments can be edited using vertical view.
Historical Sales	Actual customer sales for a specific item, period, and location. Quantity and Comments can be edited using vertical view.
Sell through Forecast	Same as Sales Forecast. Quantity and Comments can be edited using vertical view.
Negotiated Capacity	Supplier capability to produce quantities of an item for particular period and location. Quantity and Comments can be edited using vertical view.
Safety Stock	Supplier inventory quantity at present time or customer inventory quantity at the present time. Quantity and Comments can be edited using vertical view.
Allocated Onhand	Trading partner inventory quantity in stock. Stock is intended for a specific supplier or customer. Quantity and Comments can be edited using vertical view.
Unallocated Onhand	Trading partner's inventory quantity physically in stock that can be designated for any request or order. Quantity and Comments can be edited using vertical view.
Purchase Order	Customer commitment to procure an item from a supplier. Customer can post when the supplier should make shipment. You can edit Quantity, Requested Ship Date, Requested Receipt Date, Original Promise Date, and Comments fields using vertical view.
Purchase Order Acknowledgment	Supplier's acceptance of the customer's purchase order. Also supplier can post when the customer should receive the goods. You can edit Quantity, Ship Date, Receipt Date, and Comments fields using vertical view.
Purchase Requisition	Customer intent to procure an item from the supplier. If purchase request is for a VMI item, the system submits the requisition to an Oracle Purchasing requisition import manager. You can edit Quantity, Requested Ship Date, Requested Receipt Date, Original Promise Date, and Comments fields using vertical view.
Replenishment Order	Used for an order created through by either the customer or supplier VMI to replenish a VMI item. A replenishment order does not appear in the list of values on the manual order entry page.

<b>Order Type</b>	<b>Description</b>
Sales Order	Supplier response to the customer purchase order. The supplier can post when the customer can expect to receive the goods. You can edit Quantity, Ship Date - Promised, Receipt Date - Promised, Requested, and Comments fields using vertical view.
ASN (Advanced Shipment Notice)	Supplier posts when a shipment is coming for the customer. Also supplier can post when the customer should expect the goods. You can edit the Quantity, Ship Date - Actual, Receipt Date - Planned, and Comments fields using vertical view.
Shipment Receipt	Customer's physical acceptance of a shipment. You can edit the Quantity, Delivery Date, and Comments fields in the vertical view.
Work Order	Your suppliers can provide you with visibility into their work in process inventory. Suppliers can upload supplies of order type Work Order and provide quantity, order number, start date, and completion dates.
Purchase Order From Plan	Represents purchase orders that exist in the plan as of the publish process, with receipt date as displayed date. Order type published through the Publish Order Forecast program. Published whenever the program runs. Available for selection in the horizontal view preference set. Available for search using vertical view and horizontal view. Not part of the system default preference set.
Released Planned Order	Represents planned orders released in the Oracle Advanced Supply Chain Planning plan as of the time of publishing. Published only through the Publish Order Forecast program. Is published anytime the program runs. Displays receipt date. Cannot be uploaded manually through UI or through flat file loads. Is not included in the planned order quantity. Available for selection in the horizontal view preference set. Available for search using vertical view and horizontal view. Not part of the system default preference set.
Planned Order	Represents planned orders in Oracle Advanced Supply Chain Planning as of publishing time. Published only through the Publish Order Forecast program. Is published anytime the program runs. Displays receipt date. Cannot be uploaded manually through UI or through flat file loads. Is not included in the planned order quantity. Available for selection in the horizontal view preference set. Available for search using vertical view and horizontal view. Not part of the system default preference set.



Order Type	Description
Safety stock	<p data-bbox="675 310 1377 369">Enables the Publish Safety Stock program to publish the following information for a given time horizon:</p> <ul data-bbox="675 394 1442 1100" style="list-style-type: none"> <li data-bbox="675 394 971 422">• Item (the planned item)</li> <li data-bbox="675 464 824 491">• Publisher</li> <li data-bbox="675 533 867 560">• Publisher site</li> <li data-bbox="675 602 1166 630">• Quantity (the target safety stock quantity)</li> <li data-bbox="675 672 1052 699">• Order type (target safety stock)</li> <li data-bbox="675 741 1192 768">• Actual date (the key date for this order type)</li> <li data-bbox="675 810 1360 837">• Bucket (from the Plan Options form on the Aggregation tab)</li> <li data-bbox="675 879 1318 907">• Filter: The planner can use either of the following filters: <ul data-bbox="727 932 1442 1100" style="list-style-type: none"> <li data-bbox="727 932 1442 991">• Supplier: Publishes safety stock for all planned items for which ASLs exist for the supplier.</li> <li data-bbox="727 1033 1442 1100">• Supplier Site: Publishes safety stock for all planned items for which ASLs exist for the supplier site.</li> </ul> </li> </ul>
Project available balance	<p data-bbox="675 1289 1435 1415">Enables the Publish Safety Stock program to publish the comparison between the projected available balance and the safety stock values in a given bucket. Note that Projected Available Balance is published whenever the Safety Stock is published.</p> <p data-bbox="675 1440 1468 1562">Note that both of these order types are published only by the customer company for the selected item. By using horizon start date, horizon end date, and overwrite options, planners can further limit the time window to be published.</p>

## Renaming Order Types

System Administrators can rename any seeded order type. This is completed at the time of implementation. After an order type is renamed, all users within the system see the renamed order type. Users can load renamed order types and view the data through the

Planning and Exceptions tabs. If any data was entered using an old order type, that data is displayed with the new order type. You can load data for a renamed order type using any of the current loading methods.

**Note:** To rename an order type you must have the Advanced Planning System Administrator responsibility assigned to your username.

Complete the following steps to rename an order type:

1. Access the Oracle Applications System.
2. Log in under the Advanced Planning Administrator responsibility.
3. In the Oracle Applications window, select Admin, then Lookups.
4. In the Oracle Manufacturing Lookups window, place your cursor on the Type field and select the search icon.
5. In the Lookup Types search window, select MSC\_X\_ORDER\_TYPE. Select OK.
6. In the Oracle Manufacturing Lookups window, you see the order types and their descriptions. Select the order type you wish to change and edit the value in the meaning column.
7. Save your changes.

You can return to Oracle Collaborative Planning and view the renamed order type. You must now use the order type's new name to load transactional data or create orders.

## Assign Planner Codes to Items

Exception notifications are sent to the individuals who have been identified as planners for a give item in an exception. The supplier or customer contact is also notified. To assign planners to items, first create a planner in the organization. Next, assign the planner to the item. You can set up planners in an organization as follows:

1. Using the Manufacturing & Distribution responsibility, navigate to Inventory.
2. Navigate to Setup > Planners.
3. Select the organization in which your item exists.
4. Create and save a planner code.
5. Save your work.

Complete the following steps to assign planners to items:

1. Using the Manufacturing & Distribution responsibility, navigate to Inventory.
2. Navigate to Items > Organization Items.
3. Query your item.
4. Navigate to the General Planning tab.
5. Assign a planner in the Planner field.
6. Save your work.

## Security Rules

You can define security rules to grant access of data to other trading partners. You can create, edit, and view security rules. A security rule has three components:

- Objects that identify the set of transactions on which the security rule applies
- Grantee to whom the access is given by the security rule
- Scope in which the security rule is applicable

### Create Security Rules

You can create security rules related to transactions owned by your company. Administrators can create any security rules within the scope of their company.

Complete the following steps to create security rules:

1. Log in to Oracle Collaborative Planning.
2. Select the Admin tab. The following image depicts the Admin tab in Oracle Collaborative Planning:

**Setup and Administration Window**

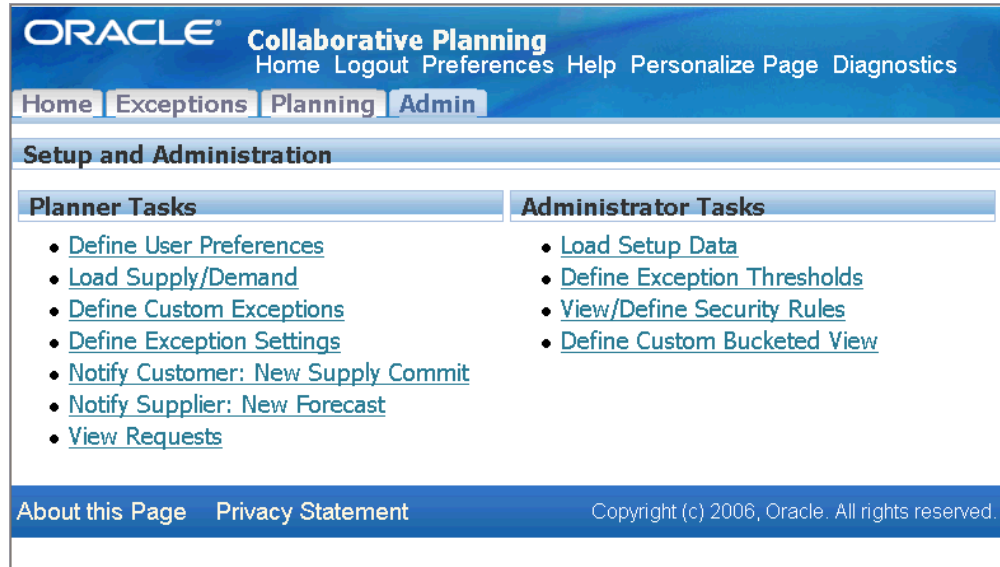

**ORACLE** Collaborative Planning  
Home Logout Preferences Help Personalize Page Diagnostics

Home Exceptions Planning Admin

**Setup and Administration**

Planner Tasks	Administrator Tasks
<ul style="list-style-type: none"><li>• <a href="#">Define User Preferences</a></li><li>• <a href="#">Load Supply/Demand</a></li><li>• <a href="#">Define Custom Exceptions</a></li><li>• <a href="#">Define Exception Settings</a></li><li>• <a href="#">Notify Customer: New Supply Commit</a></li><li>• <a href="#">Notify Supplier: New Forecast</a></li><li>• <a href="#">View Requests</a></li></ul>	<ul style="list-style-type: none"><li>• <a href="#">Load Setup Data</a></li><li>• <a href="#">Define Exception Thresholds</a></li><li>• <a href="#">View/Define Security Rules</a></li><li>• <a href="#">Define Custom Bucketed View</a></li></ul>

About this Page Privacy Statement Copyright (c) 2006, Oracle. All rights reserved.

3. From the Admin tab, select View/Define Security Rules. The following image depicts the View Security Rules window in Oracle Collaborative Planning:

**View Security Rules Window**

**ORACLE Collaborative Planning**  
Home Logout Preferences Help Personalize Page Diagnostics

Home Exceptions **Planning** Admin

**Search**

Personalize "Search"  
Personalize Table Layout: (Mscxviewsecrulessearchheader)  
✓TIP To view security rules, enter search criteria and click Search

Item  Org   
Customer  Supplier   
Order Type  Access Given To

Active Rules

Personalize Header: (Mscxviewsecrulesresultsa)

Personalize "Security Rules Tabular Data"

Order Type	Order Number	Item	Org	Customer Site	Supplier Site	Supplier Access Given To	Ass To
			TST:B1			company	Nort Elec Sup
						document owner	
						trading partner	
Unallocated onhand						company	Visic Corp
Consumption advice						company	Visic Corp

About this Page Privacy Statement Copyright (c) 2006, Oracle. All rights reserved.

4. Select Create New Rule.
5. Enter the required information in the Add Security Rule window. The following fields are required:
  - Access Given By
  - Privilege
  - Access Given To

- Assigned To

The following image depicts the Add Security Rule window:

#### Add Security Rule Window

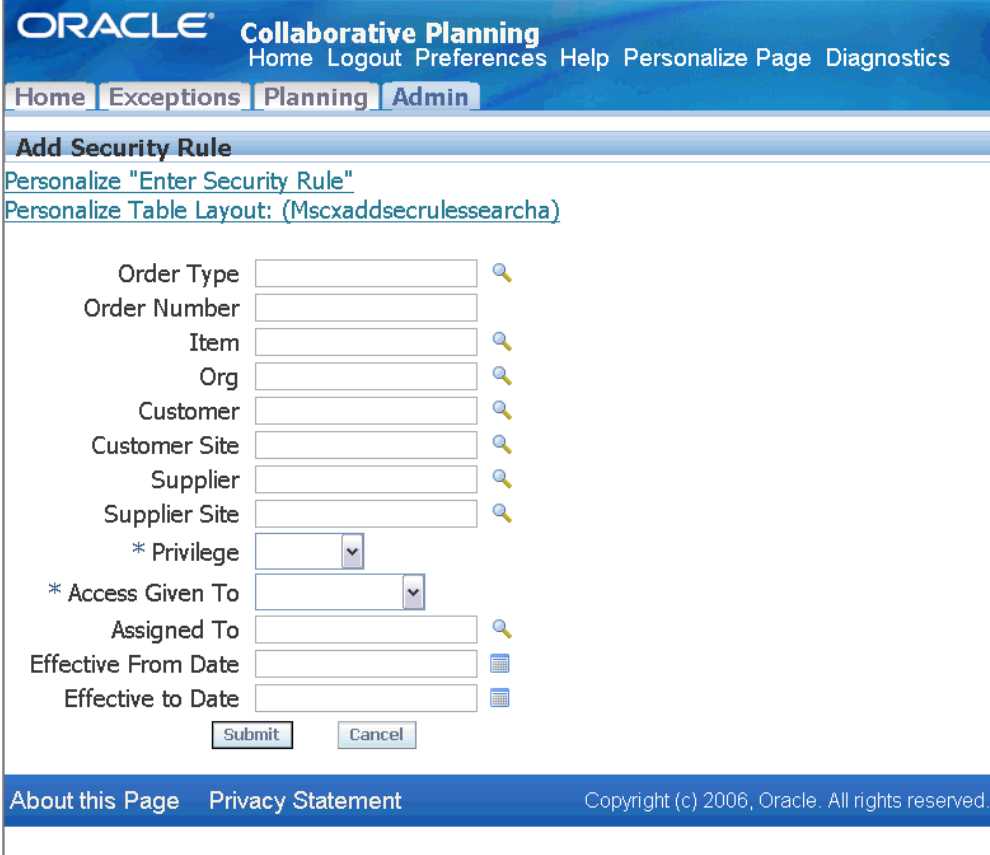

ORACLE Collaborative Planning  
Home Logout Preferences Help Personalize Page Diagnostics

Home Exceptions Planning Admin

**Add Security Rule**

Personalize "Enter Security Rule"  
Personalize Table Layout: (Mscxaddsecrulessearcha)

Order Type  

Order Number

Item  

Org  

Customer  

Customer Site  

Supplier  

Supplier Site  

\* Privilege  

\* Access Given To  

Assigned To  

Effective From Date  

Effective to Date  

About this Page Privacy Statement Copyright (c) 2006, Oracle. All rights reserved.

6. Select Submit.

### Edit Security Rules

You can edit security rules as transactions change with your trading partners. You can edit only those rules for which you have authority. You can enable or disable any of the security rules by editing the effective From Date and the Effective To Date. Administrators can edit all security rules.

Complete the following steps to edit security rules:

1. Select View/Define Security Rules from the Admin window.
2. Enter your search criteria and select Search.
3. Select a security rule you want to edit and select Edit.

4. On the Edit Security Rule window, complete or update the required fields and select Submit. The following fields are required:
  - Access Given By
  - Privilege
  - Access Given To
  - Assigned To
5. Select Submit.

### **Edit Effective Dates**

Complete the following steps to edit effective dates:

1. Select View/Define Security Rules in the Admin window.
2. Enter your search criteria and select Search.
3. Select the security rule you want to edit and edit the following fields:
  - Effective From Date
  - Effective To Date
4. Select Apply Changes.

### **View Security Rules**

You can view security rules to monitor existing rules within the scope of your company. Administrators can view all security rules.

Complete the following steps to view security rules:

1. Select View/Define Security Rules in the Admin window
2. Enter your search criteria and select Search.
3. Review your security rule(s) in the View Security Rules section.





---

## Forecasting

This chapter covers the following topics:

- Overview
- The Collaboration Cycle
- Forecast Versioning
- Collaborate with Customers
- Collaborate with Suppliers

### Overview

There are two types of collaborative business processes associated with forecasting: sales forecast collaboration and order forecast collaboration. Sales forecast collaboration is prevalent in the consumer goods industries, where promotions by both retailers and manufacturers influence consumer demand. The purpose of sales forecast collaboration is to come to a consensus on what end-consumer demand will be. Order forecast collaboration is more universal. Order forecast collaboration occurs when the customer provides a forecast of demand, and the supplier provides its supply commitment indicating its ability to meet that demand.

Customers and suppliers collaborate as trading partners and can post their statements of demand and supply in Oracle Collaborative Planning. This enables them to communicate their needs. A customer can post its order forecast to a supplier who can, in turn, respond with a supply commitment to meet the forecast. When discrepancies occur between supply and demand, Oracle Collaborative Planning computes exceptions and sends notifications identifying issues and expediting resolutions. Oracle Collaborative planning works across trading partners to provide an efficient means to communicate requirements and changes in requirements to resolve issues across the extended supply chain. Better collaboration results in fewer disruptions in the supply chain.

In sales forecast collaboration you exchange a sales forecast with your customers for demand planning purposes. By using Oracle Demand Planning in conjunction with

Oracle Collaborative Planning, you can receive and publish sales forecasts using the Receive Forecast From Customer and Publish Forecast to Customer programs.

<b>Program</b>	<b>Order Type</b>	<b>Capability</b>
Receive Forecast From Customer	Sales Forecast	Receive a sales forecast from Oracle Collaborative Planning into Oracle Demand Planning as a custom data stream.
Publish Forecast to Customer	Sales Forecast	Publish the result of a demand plan as a sales forecast from Oracle Demand Planning into Oracle Collaborative Planning.

In order forecast collaboration, you collaborate with both your customers and suppliers for demand and supply planning purposes. Using Oracle Demand Planning and Oracle Advanced Supply Chain Planning in conjunction with Oracle Collaborative Planning, you can:

- Receive an order forecast from your customer and respond with a supply commit
- Publish an order forecast to your suppliers and receive their supply commits as supplier capacity for supply chain planning

<b>Program</b>	<b>Order Type</b>	<b>Capability</b>
Receive Forecast From Customer	Order Forecast	Receive an order forecast posted by your customer from Oracle Collaborative Planning into Oracle Demand Planning as a custom data stream.
Publish Forecast to Customer	Order Forecast	Publish the result of a supply chain plan as an order forecast from Oracle Advanced Supply Chain Planning to Oracle Collaborative Planning.
Receive Supplier Capacity	Supply Commit	Receive supply commits posted by your suppliers from Oracle Collaborative Planning into Oracle Advanced Supply Chain Planning.

<b>Program</b>	<b>Order Type</b>	<b>Capability</b>
Publish Supply Commit	Supply Commit	Respond to your customer's order forecast with a supply commit from Oracle Advanced Supply Chain Planning to Oracle Collaborative Planning.

To access the programs listed you must have the Advanced Planning Administrator responsibility. You can select the appropriate program from the Collaboration menu option of the Advanced Planning Administrator responsibility.

Using Oracle Collaborative Planning, you can view your supplies or demands in several ways. The following table outlines how you can view your supply and demand:

<b>Viewing Capability</b>	<b>Description</b>
Horizontal View	When you view your plan horizontally, the system assembles your plan data over a period of time. You can also graph your information.
Vertical View	When you view your plan vertically, you filter your search criteria to view plan data. You can view information for an order type, due date, or quantity.
Custom View	You can set up a custom view that suits your business needs.
Vendor Managed Inventory	You can view inventory quantities that your supplier is responsible for or the potential stock out situations at your customers' locations. You can also view current in-transit shipment information. With customer-facing VMI, you can respond to replenishment needs of items at your and your customers' sites quickly while creating requisitions to fulfill those requirements.
Forecast Comparison	You can post forecasts to and from the system. You can also compare versions of forecasts on the system. For more information about forecast comparison, refer to Waterfall Analysis, page 8-1.

## The Collaboration Cycle

Collaboration consists of the following several steps:

- Your customer publishes an order forecast.

- You receive your customer's forecast.
- You publish your forecast to your supplier.
- Your supplier publishes a supply commit based on your forecast.
- You receive your supplier's capacity.
- You run your ASCP plan.
- You publish your supply commits to your customer.

The following image depicts the collaboration cycle:

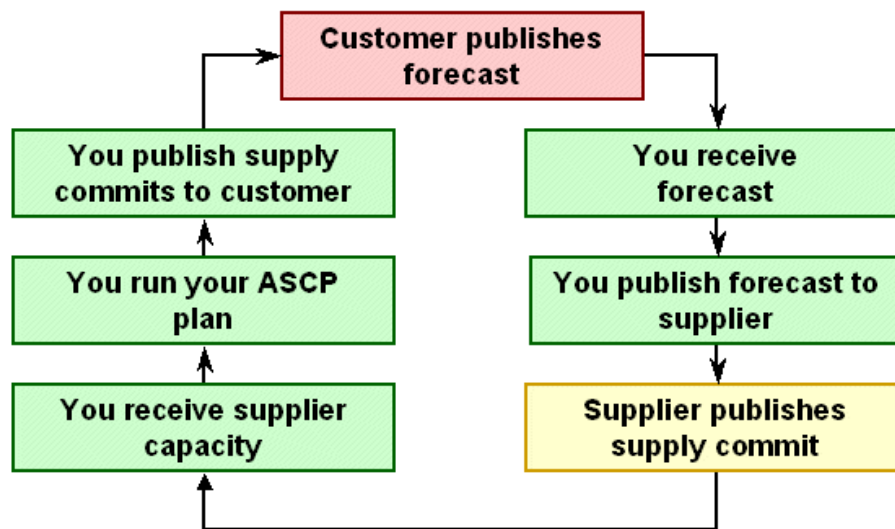

## Forecast Versioning

As a demand planner, you may want to involve your trading partners in your forecasting process to improve forecast accuracy. You run a supply chain plan in Oracle Advanced Supply Chain Planning and publish your planned orders to your suppliers as an order forecast. Suppliers review the order forecast, build their supply chain plans, and post their supply commits to Oracle Collaborative Planning. You can make changes to your forecast and publish it to Oracle Collaborative Planning as a new version. Oracle Collaborative Planning enables you to compare two or more versions of a forecast. To facilitate a collaborative demand planning process, you can do the following:

- Publish forecasts to Oracle Collaborative Planning.
- Share demand data with trading partners.

- Provide designators when publishing forecasts.
- Provide a version when submitting a demand plan.
- Provide start and end dates when publishing plans.
- Use filters when publishing data.
- Perform forecast comparison using two or more streams of data.
- Compare two data streams.

## Collaborate with Customers

This section discusses collaboration with customers. The following topics are addressed:

- Publish Forecasts, page 3-5
- Publish Supply Commits, page 3-6
- Receive Forecasts in Oracle Demand Planning, page 3-7
- Customer Collaboration Automation, page 3-7

## Publish Forecasts

You can publish forecasts from Oracle Demand Planning to your customers using the Publish Forecast to Customer program. Complete the following steps to publish forecasts to your customers:

1. Run the Publish Forecast to Customer program
2. Provide forecast name and scenario as parameters

Your customers must complete the following steps to load forecasts into Oracle Collaborative Planning:

1. Download supplydemand.dat
2. Prepare the template
3. Item = enter a valid item number
4. Order Type = Order forecast
5. Publisher = enter a valid publisher name
6. Publisher Site = enter the publisher site

7. Supplier = enter a valid supplier
8. Supplier Site = enter a valid supplier site
9. Receipt Date = enter a valid date
10. Bucket End Date = enter a valid date
11. Bucket Type = enter a valid type
12. Designator: An optional field that is used to denote the name of the forecast
13. Version: An optional field that is used to denote the version of the forecast
14. Save and upload the flat file

## Publish Supply Commits

When publishing supply commits to your customers, you can embed any supplies that are pegged to customer sales orders. A supply commit statement that includes supplies pegged to sales orders provides your total supply picture for a given time horizon to your customers.

**Note:** Note that the system uses the same planning time buckets for publishing supply commits as it uses for publishing order forecasts from customers to respective suppliers.

If customers only share with you their planned orders (not including requisitions and purchase orders), you would not include any supplies that are pegged to customer sales orders. The Publish Supply Commits process is launched as an SRS concurrent request

You can publish supply commits to your customers by completing the following steps:

1. Run the Publish Supply Commit program
2. Provide plan name and version as parameters

The Oracle's Configure to Order (CTO) solution supports maintaining, planning, and consuming forecasts for ATO model in the source system. While publishing the supply commit to Collaborative Planning from Advanced Supply Chain Planning, the Publish Supply Commit program supports Oracle's Configure to Order (CTO) solution by,

- Aggregating the supplies pegged to demands for base model, and demands for configured items
- Calculating the material availability dates of supplies pegged to demands
- Adding the supply commits for all the configured items under a base model to the

supply commit of the base model

- Adding sales orders for the configured items to the published supply commit based on the planners' selection

## Receive Forecasts in Oracle Demand Planning

To receive customer forecasts in Oracle Demand Planning complete the following steps:

1. Run the Receive Forecast from Customer program. Provide the forecast name as a parameter (Navigation: APS Administrator > Collaboration)
2. Setup your demand plan, using order forecasts from customers as an input parameter (Navigation: DP System Administrator > Demand Plans).
3. Build the demand plan.
4. Demand planners compare customer forecast to internally generated forecast and adjust internal forecast if appropriate.
5. Collect data from demand planners.
6. Upload the Oracle Demand Planning scenario to the planning server.

The following image depicts the steps for receiving forecasts in Oracle Demand Planning:

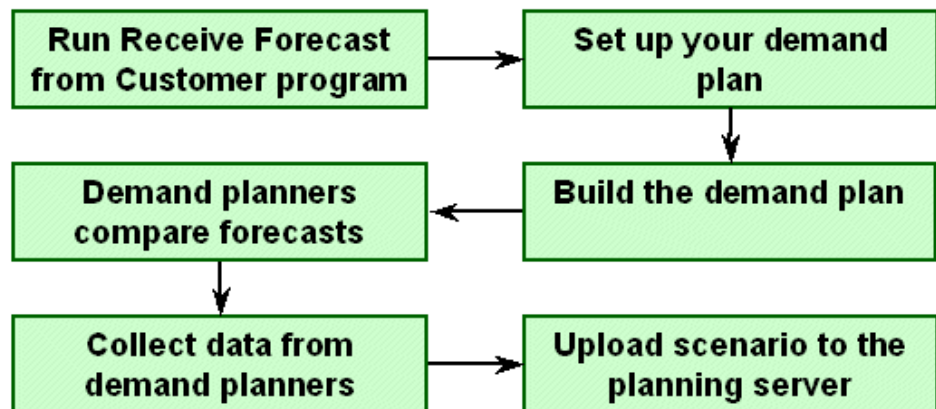

## Customer Collaboration Automation

Oracle Collaborative Planning enables you to automate your customer collaborations. When a customer uploads or enters a forecast into Oracle Collaborative Planning and then selects Send Forecast to Supplier in the Admin tab, the Receive Forecast From

Customer concurrent process automatically runs. This reads the customer forecast into the seeded Oracle Demand Planning data stream Order Forecast From Customers with a forecast name of CP\_ORDER\_FORECAST. Any demand plan that uses Order Forecast From Customers as an input parameter can then be updated with the new customer forecast data via the Download Data From Planning Server batch process. The Quick download option enables the download of just fact data from the selected input parameters.

The capabilities of customer collaboration automation include:

- Customer posts an order forecast to Oracle Collaborative Planning
  - Automatic launch of Supply Chain Event Manager (SCEM) to compute material excess and shortage exceptions and send notifications
- Customer notifies you that a new forecast has been uploaded
  - Trigger to launch receive forecast from customer
- Publish Supply Commit to Customer
  - Option to publish supply commit from ASCP Planner Workbench
  - Automatic launch of SCEM to compute exceptions

Complete the following steps to enable automatic customer collaboration in Oracle Collaborative Planning:

1. Set profile options
2. MSC: SCEM Engine Launch Events
  - None: Do not launch SCEM automatically
  - Load: Automatically start SCEM when an order forecast data load occurs
  - Publish: Automatically start SCEM when a Publish order forecast (from ASCP plan) occurs
  - All: Automatically start SCEM when either a Publish or a data load occurs
3. MSC: Configuration
  - Set to APS & CP
4. Customer posts an order forecast to you, which starts workflow to compute exceptions.
5. Customer notifies you that a new order forecast has been posted



6. Workflow launches Receive Forecast From Customer program
7. Forecast Name defaulted to CP\_ORDER\_FORECAST
8. Publish Supply Commit to Customer from PWB

## Collaborate with Suppliers

This section discusses collaboration with suppliers. The following topics are discussed:

- Supplier Collaboration Automation, page 3-9
- Publish Order Forecasts, page 3-10
- Receive Supplier Capacity, page 3-14
- Impact of Time Bucketing on Receive Supply Capacity Program, page 3-14
- Respond to and Edit Purchase Orders, page 3-14
- On-hand Inventory Visibility, page 3-15
- Access the Planner Workbench, page 3-16

## Supplier Collaboration Automation

Oracle Collaborative Planning enables you to automate your supplier collaboration. When a supplier uploads or enters a forecast into Oracle Collaborative Planning and then selects Send Supply Commit to Customer in the Admin tab, the Receive Supplier Capacity concurrent process automatically runs. This reads the supplier's supply commit into the supplier capacity records on the ASCP planning server. After that, if the profile option MSC: New Supply Commit Auto Plan contains a valid ASCP plan name, that plan is automatically launched.

The capabilities of supplier collaboration automation include:

- Publish Order Forecast to Supplier
  - Option to publish an order forecast from ASCP Planner Workbench
  - Automatic launch of SCEM to compute material excess and shortage exceptions and send notifications
- Supplier posts a Supply Commit to Collaborative Planning
  - Automatic launch of SCEM to compute material excess and shortage exceptions and send notifications

- Supplier Notifies You That a New Supply Commit has been Uploaded
  - Trigger to launch Receive Capacity from Supplier
  - Automatic launch of supply chain plan in constrained mode

Complete the following steps to enable supplier collaboration automation:

1. Set profile options.
2. MSC: SCEM Engine Launch Events
  - None: Do not launch SCEM automatically
  - Load: Automatically start SCEM when an order forecast data load occurs
  - Publish: Automatically start SCEM when a publish order forecast (from ASCP plan) occurs
  - All: Automatically start SCEM when either a publish or a data load occurs
3. MSC: Configuration
  - Set to APS & CP
4. MSC: New Supply Commit Auto Plan
  - Enter a valid plan name

For more information about profile options associated with Oracle Collaborative Planning, refer to Profile Options, page A-1.
5. Post an order forecast to your suppliers from the Planner Workbench. This launches SCEM to compute exceptions.
6. Supplier posts a supply commit; launches SCEM to compute exceptions.
7. Supplier notifies you that a new supply commit has been posted.
8. Trigger to launch Receive Supplier Capacity program.
9. Constrained plan runs automatically.

## Publish Order Forecasts

You can publish forecasts from Oracle Advanced Supply Chain Planning to your suppliers using the Publish Order Forecast program. Complete the following steps:

1. Run the Publish Order Forecast program

## 2. Provide plan name and version as parameters

In addition to publishing planned orders to your suppliers, you can also embed purchase requisitions and/or purchase orders within the order forecast. This order forecast will provide your total demand statement for a given time horizon to your suppliers.

While publishing order forecasts, ASCP also publishes the calculated safety stock and Projected Available Balance (PAB) for an item from an ASCP plan to Collaborative Planning. ASCP calculates a time-phased target safety stock for each item-organization by an ASCP plan or an Inventory Optimization plan. To calculate safety stock requirements by an Inventory Optimization plan, planners can feed its output to an ASCP plan and publish safety stock and projected available balance from the ASCP plan output. Collaborative Planning allows planners to limit the sharing by setting up security rules. The following formula depicts the calculation that ASCP uses to calculate safety stock level:

For time bucket n

$$\text{SafetyStock}_n = \text{SafetyStock}_{n-1} + \text{SafetyStockSupplies}_n - \text{SafetyStockDemands}_n$$

Where  $\text{SafetyStock}_n$  = safety stock on day n

$\text{SafetyStock}_{n-1}$  = safety stock on day n-1

$\text{SafetyStockSupplies}_n$  = safety stock supplies calculated by planning for day n

$\text{SafetyStockDemands}_n$  = safety stock demands calculated by planning for day n

For more information about the calculation of safety stock in ASCP, refer to *Oracle Advanced Supply Chain Planning Implementation and User's Guide*.

After analyzing the safety stock and PAB along with other supplies and demands in ASCP horizontal plan view, planners can determine the items for which the target safety stock can be published to the suppliers. You can publish the safety stock and PAB information to trading partners by running the Publish Safety Stock program from Collaboration menu under Advanced Planning Administrator responsibility.

**Note:** Note that the system uses the same planning time buckets for publishing order forecasts as it uses for publishing supply commits from suppliers to respective customers.

**Caution:** Note that Publish Safety Stock program does not publish the order forecast record, if the start date or the end date is null.

While publishing order forecasts to suppliers, the Publish program honors the planning time bucket specified in the supply chain plan options and assigns a time bucket of day, week, or month to data posted to Collaborative Planning. Primarily, the system applies the receiving calendar of the customer's site to display and compare order forecasts. In the absence of this calendar, the system will apply other site-specific calendars. It will

follow the same convention as the Horizontal View. For more information about determining the site-specific calendar used for comparing forecasts, see Collaborative Planning Time Bucketing , page 9-10.

When two or more customer sites appear together in the order forecast, a conflict may occur because of multiple receiving calendars used by different customer sites. To resolve this conflict, the system uses the default system calendar to display and compare forecasts for two different customer sites. The system also compares supply and demand data for similar time periods for generating Forecast Mismatch exceptions. For more information on Forecast Mismatch exceptions, see, "Exceptions: Forecast Mismatch, page 7-9." The system may convert a lower time bucket into a comparatively higher time bucket to aggregate the supply and demand information of the lower time buckets before comparing the data with the higher time buckets. For example, if the last display day bucket occurs in the middle of a week, the system adds extra days to complete the week. Similarly, if the last display week bucket occurs in the middle of a month, the system adds extra weeks to complete the month.

The publish order forecast transaction selects data from MSC\_SUPPLIES to be sent to suppliers in Oracle Collaborative Planning. This is accomplished by:

- The Publish Order forecast program selects all planned orders sourced from suppliers. The user has the option of including the following order types:
  - Purchase Orders
  - PO in Receiving
  - Purchase Requisitions
  - Intransit Shipments
  - Intransit Receipts
  - Safety stock
  - Projected available balance
- The Publish Order Forecast program then aggregates the planned orders for configured items and base model in an ASCP plan into one order forecast and displays the following:
  - Planned orders for the base model
  - Planned orders for all the configured items, under this base model

Optionally planners can include the following to be displayed in the order forecast:

- Purchase orders for all configured items of the base model

- Purchase requisitions for all configured items of the base model
  - The order forecast displays itemized individual orders (such as purchase orders, planned orders) at each configured item level.
  - During the Publish process, Approved Supplier List (ASL) of the base model is used to determine supplier of the configured items.
 

Always enable the global ASL and not the local ASL to avoid any problem while publishing order forecasts.
  
- The receipt date communicated to Oracle Collaborative Planning must be a valid workday as per the delivery calendar in the ASL for the item/org record being published. Oracle Advanced Supply Chain Planning ensures that the dock date for orders sourced from suppliers is a valid day on the delivery calendar. There are two conditions under which the publish program will apply the delivery calendar logic:
  - ASCP does not provide a dock date
  - The order is firm in the Planner's workbench.

Supply commits should be published after the supplier collaboration cycle; this accounts for constraints imposed by suppliers. Your suppliers must complete the following steps to publish forecasts in Oracle Collaborative Planning:

1. Download *supplydemand.dat*
2. Prepare the template
3. Order Type = Supply commit
4. Item = enter a valid item number
5. Publisher = enter a valid publisher name
6. Publisher Site = enter the publisher site
7. Supplier = enter a valid supplier
8. Supplier Site = enter a valid supplier site
9. Ship Date = enter a valid date
10. Bucket End Date = enter a valid date
11. Bucket Type = enter a valid type

12. Designator: An optional field that is used to denote the name of the supply commit
13. Version: An optional field that is used to denote the version of the supply commit
14. Save and upload the flat file.

## Receive Supplier Capacity

You can receive supplier capacity using the Receive Supplier Capacity program. Complete the following steps:

1. Run the Receive Supplier Capacity program
2. Provide parameters

## Impact of Time Bucketing on Receive Supply Capacity Program

While spreading supplier capacity, the Receive Supplier Capacity program acknowledges the planning time bucket. The program:

- Creates supplier capacity records by item, supplier site, customer site, and calendar date.
- Adheres to the supplier capacity calendar (delivery calendar) to aggregate the supply commit data, which may be posted at the day, week, or month level.
- Selects the default calendar if the supplier capacity calendar does not exist or is not specified in the Approved Supplier List.
- Creates a supplier capacity entry on the next available working day if the publish supply commit action occurs on a nonworking day.
- Spreads the supplier capacity records against the supplier capacity calendar specified for a supplier's site on the Approved Supplier List. Note that the supplier capacity is divided from higher time aggregation to lower time aggregation.

For more information on time bucketing, see Horizontal and Advanced Horizontal View: Time Bucketing in Collaborative Planning, page 9-10.

## Respond to and Edit Purchase Orders

Suppliers can respond to purchase orders and initiate purchase order change requests directly through the Oracle iSupplier Portal. When this happens, Oracle Collaborative Planning auto-creates (for the purposes of supply/demand tracking and exception management within Oracle Collaborative Planning) a supplier sales order containing the acknowledgement information. Suppliers can provide their sales order reference information directly through Oracle iSupplier Portal. This not only reduces overhead of

maintaining documents in two separate places, but also enables a more streamlined business process.

Oracle Advanced Supply Chain Planning refers to the promised date on a purchase order as the dock date. If a promised date is not provided, then the dock date is recognized as the need by date.

If the supplier provides a promised date and any sales order information (sales order and line for each PO shipment), Oracle Collaborative Planning creates a Sales Order order type that is pegged to the purchase order shipment. Suppliers can provide a sales order line number for each purchase order shipment number.

If the sales order number and the sales order line number are not provided by the supplier, Oracle Collaborative Planning creates a sales order with the same number as the purchase order and line number. For example, if the PO # is 1174, line 1, shipment 1, the sales order will be SO1174, line 1.

If the supplier provides the sales order number and the sales order line number through Oracle iSupplier Portal at a later date, all previously existing sales orders that were system created will be deleted for that PO/Line/Shipment. Instead, the new sales order will be created and pegged to the purchase order.

If the supplier later changes the sales order number and line number for the purchase order, line, shipment, then Oracle Collaborative Planning replaces the previous sales order number with the new one. The following table depicts possible supplier responses on a purchase order acknowledgement and what the corresponding sales order would show in Oracle Collaborative Planning:

<b>Supplier Response on Purchase Order Acknowledgement</b>	<b>Sales Order in Oracle Collaborative Planning</b>
Promise Date: Null or Jan 15, 2003	Need By Date: Null or Jan 15, 2003
Sales Order Number: Null or 1125	Order Number: (SO + PO + Line) or 1125
Sales Order Line Number: Null or 001	Line Number: (SO + PO SHIPMENT) or 001

## On-hand Inventory Visibility

You can collect on-hand inventory records from all inventory organizations and view them in Oracle Collaborative Planning. On-hand inventory associated with a supplier and supplier site will be displayed in Oracle Collaborative Planning as allocated on-hand. If the inventory is not identified with a supplier and supplier site, Oracle Collaborative Planning will display the record as unallocated on-hand. If the inventory organization is associated with a supplier, all on-hand records will be displayed as allocated on-hand.

The following image is for reference in example for this section:

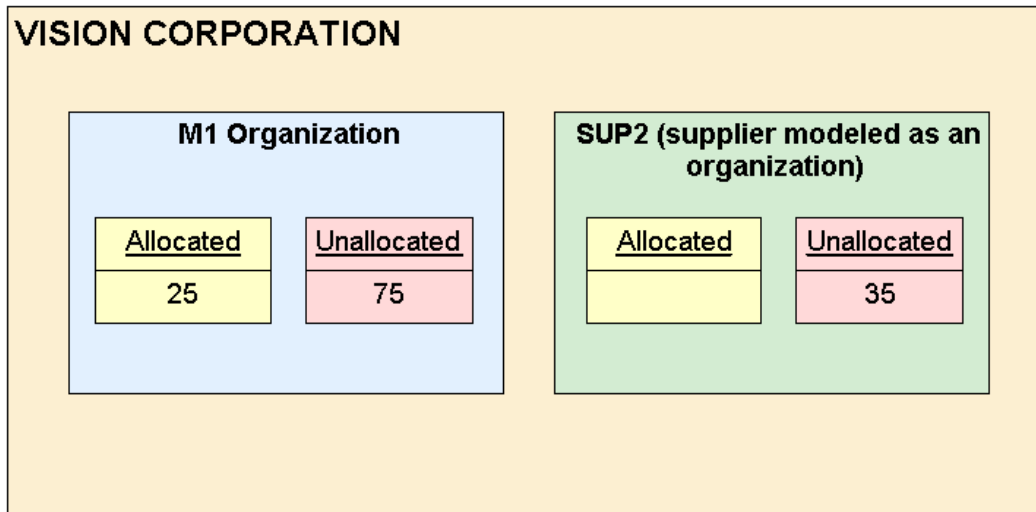

#### Example 1

Let's say that supplier 1 is responsible for replenishing inventory to Vision/M1 (VMI). Oracle Collaborative Planning will collect the allocated onhand and use that quantity (25) in the VMI calculation.

#### Example 2

If we want to display it the unallocated quantity, Oracle Collaborative Planning collects it and displays it as unallocated on-hand and ensures that the VMI engine does not use it in the VMI calculation.

#### Example 3

In this case, supplier SUP2 is modeled as an organization in Vision. SUP2 posts the on-hand inventory in his warehouse into org SUP2 using EDI. It is collected over to Oracle Collaborative Planning and displayed there as Allocated On-hand.

If Vision and SUP2 want to use VMI, then the following must occur:

- Vision will set up a local ASL, with the owning org as M1 and supplier as SUP2, in order to enable VMI.

## Access the Planner Workbench

You can provide your suppliers with view-only access to the Oracle Advanced Supply Chain Planning Planner Workbench through Oracle Collaborative Planning. If you have modeled the supplier as an organization, the supplier will have access to supply/demand information for that organization. If you have not modeled the supplier as an organization, the supplier will have access to the supply/demand information restricted to that supplier.

To access the Planner Workbench from Oracle Collaborative Planning, complete the following steps:



1. Select the Planning tab in Oracle Collaborative Planning. The following image depicts the Planning tab in Oracle Collaborative Planning:

### Planning Tab

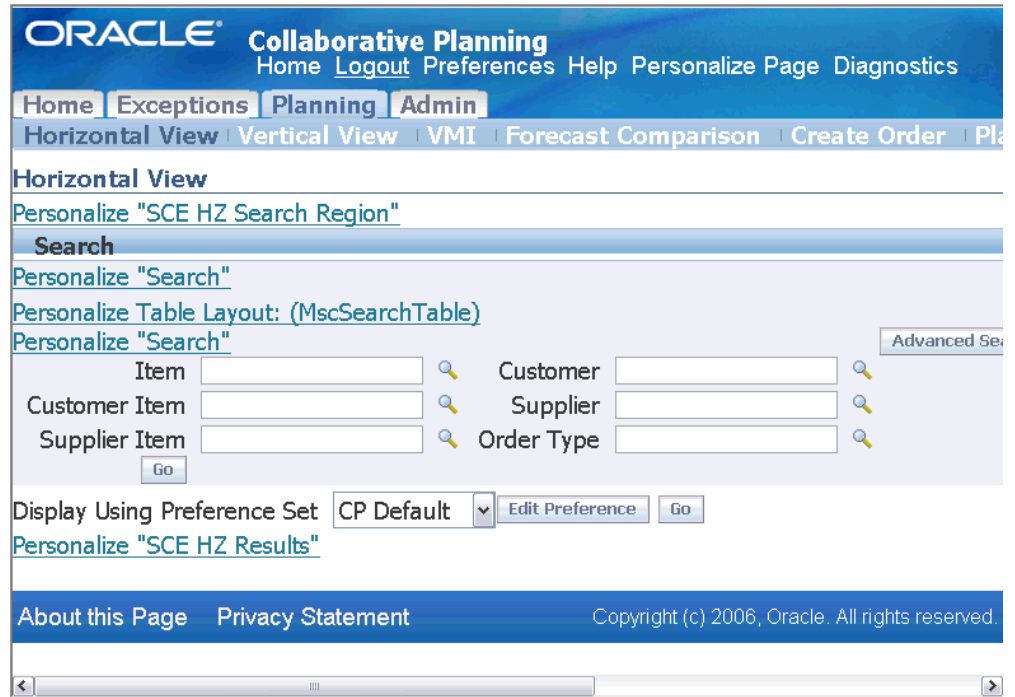

2. Select Planner Workbench.

The Planner Workbench sub-tab is visible only to users who belong to a company that has a supplier role (the supplier can be modeled either as an Org or not as an Org).

The Planner Workbench displays the supplier icon, supplier name, and supplier site name. You can review the plan by supplier organization by clicking the supplier icon on the Planner Workbench.

When you launch the Planner Workbench from the Planning tab, only the plans that meet both the following criteria will display:

- The plans that are marked Production
- The plans for which the supplier is included. Examples of this include:
  - For suppliers modeled as Orgs, their Org should be one of the planned Orgs in the plan
  - For suppliers not modeled as Orgs the Supplier should be included in the Sourcing Rule used by the plan.



---

# Vendor Managed Inventory with Suppliers

This chapter covers the following topics:

- Overview
- Order Types
- User Setup and Process
- Monitor and Replenish Inventory
- Exceptions
- VMI Replenishment Engine
- Notifications

## Overview

Vendor Managed Inventory with suppliers (supplier-facing VMI) enables you to share on-hand, supplies, and forecast information with suppliers, transfer replenishment responsibility to suppliers, and automate replenishment processes.

Oracle Collaborative Planning uses Vendor Managed Inventory with suppliers to automate the replenishment process, lower inventory, improve supplier performance, and drive out non-valued added costs. You can provide suppliers necessary information to manage inventory they provide. Vendor Managed Inventory is integrated with the execution system to enable any desired level of automation in fulfillment.

With supplier-facing VMI, all planning activities can be monitored in the system. You can view the following:

- Forecasts you provided for your suppliers.
- Current onhand inventory quantities for materials shipped by your suppliers.
- Suggested replenishment quantity (calculated in Oracle Collaborative Planning)

when available inventory is below the specified minimum. The suggested replenishment quantity is calculated by taking the difference between the maximum quantity and the available inventory. Available inventory is calculated using the following equation:

$$\text{Allocated onhand} + \text{Requisitions} + \text{Purchase Orders} + \text{ASNs} + \text{Receipts}$$

- Replenishment quantity. Replenishment quantity is the amount of an item that is requested by the user. The default value of this column is less than or equal to the suggested replenishment quantity minus in-process quantity. You can choose to release a quantity less than the suggested replenishment quantity.
- In-process quantity which is the replenishment quantity released since the last VMI engine run. It is set to zero after each VMI engine run.
- Current open quantities on purchase orders and requisitions.
- Current quantities received, but not delivered into inventory.
- Current in-transit shipment information that your VMI supplier is responsible for managing.

You can enable vendor managed inventory through approved supplier lists. With approved suppliers lists, you can:

- Set up local or global approved supplier lists. If you want a supplier site to manage inventory for an item at two or more inventory organizations, each with its own replenishment parameters, you can set up a local approved supplier lists. If the supplier site will manage the item at several inventory organizations, all with the same replenishment parameters, you can set up a global approved supplier list.
- Specify in approved supplier lists an indicator describing the supplier or supplier site responsible for managing your replenishments.
- Select a replenishment method. If you select the Automatic replenishment method, the system will calculate replenishment quantity. If you select the Manual replenishment method, Oracle Collaborative Planning will generate material shortage exception, but will not suggest a replenishment quantity. You must also use manual replenishment processes to order more material.
- Select approval levels. The following table depicts how replenishment orders can be released.

Approval By	Description
-------------	-------------

<b>Approval By</b>	<b>Description</b>
Buyer	Only a user within the customer company releases a replenishment order.
Buyer/supplier	Users from both companies can release a replenishment order.
None	After a replenishment order is created the system automatically releases it.

- Use replenishment points in the form of minimum/maximum reorder planning points.
- Create replenishments or requisitions for your plan.
- Integrate replenishments with your ERP system.

Vendor Managed Inventory with suppliers enables you to initiate replenishments when available inventory falls below minimum levels. You can:

- Send notification to the planner of specific item
- Suggest a replenishment quantity that equals maximum available inventory

## Order Types

Vendor managed inventory uses the following order types:

- ASN (from supplier)
- Requisition (from buyer)
- Purchase Order (from buyer)
- Receipt (from buyer)
- Allocated Onhand (from buyer)
- Order forecast (optional from buyer)

To learn more about the order types supported by Oracle Collaborative Planning, refer to Setup, page 2-1.

## User Setup and Process

The user setup and process for Vendor Managed Inventory with suppliers consists of the following several steps:

1. Create Blanket Purchase Agreements, page 4-4 (performed in Oracle Purchasing).
2. Define Parameters for Vendor Managed Inventory with Suppliers, page 4-5 in approved supplier lists (performed in Oracle Purchasing).
3. Collect Approved Supplier Lists, page 4-9 and available inventory for each item/supplier.
4. Schedule and Run the VMI Replenishment Engine, page 4-10 Schedule and run the VMI replenishment engine.
5. View Replenishment Orders , page 4-11 and start requisition import.
6. Submit Advance Shipment Notices, page 4-11 (performed in Oracle iSupplier Portal).

The following image depicts the user setup flow for Vendor Managed Inventory with suppliers:

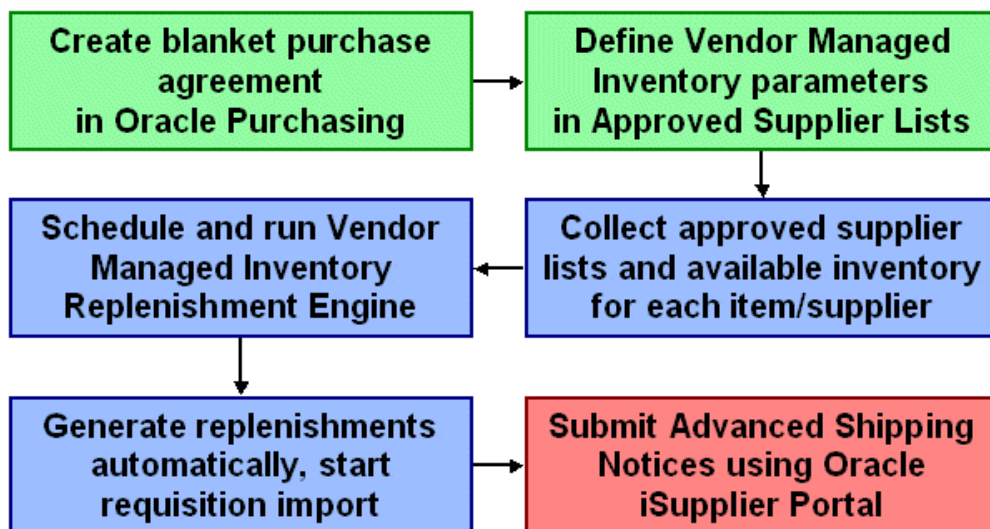

### Create Blanket Purchase Agreements

Blanket purchase agreements are defined in Oracle Purchasing. For more information about setting up blanket purchase agreements, refer to the *Oracle Purchasing User Guide*.

## Defining Parameters for Vendor Managed Inventory with Suppliers

### In Oracle Purchasing

You can define the parameters for supplier-facing VMI in a local or global approved supplier list. You can create approved supplier lists in Oracle Purchasing and use them to:

- Enable an item, supplier, and supplier site for Vendor Managed Inventory.
- Indicate whether Vendor Managed Inventory parameters apply to a specific inventory organization.
- To keep track of the names of the parties responsible for planning certain items or groups of items, define the planner name and assign these planning entities or planners to items.

Use global Approved Supplier Lists (ASLs) when the parameters for supplier-facing VMI apply across all of your organizations.

Complete the following mandatory steps in the Replenishment Control section of the Supplier-Item Attributes window when setting up the parameters for supplier-facing VMI:

## Supplier-Item Attributes Window

The screenshot shows the 'Supplier-Item Attributes (V1)' window with the 'Inventory' tab selected. The 'Order Modifiers' section includes 'Minimum Order Quantity' set to 5 and 'Fixed Lot Multiple' set to 1. The 'VMI Enabled' checkbox is checked. Under 'Replenishment Control', 'Automatic Allowed' is checked, 'Approval' is set to 'Supplier or Buyer', 'Method' is 'Min - Max Quantities', and 'Forecast Horizon (Days)' is 10. The 'UOM' is 'Each', 'Minimum Quantity' is 5, and 'Maximum Quantity' is 15. The 'Consigned from Supplier' checkbox is unchecked. Other fields include 'Billing Cycle (Days)', 'Last Billing Date', 'Consume on Aging', and 'Aging Period (Days)'.

1. Select the VMI Enabled check box to enable an item for Vendor Managed Inventory for a specified supplier and supplier site.
2. Select an option in the Approval list to determine whether the buyer or the seller needs to approve the VMI replenishment. Values are:
  - **None:** The system can release the VMI replenishment automatically.
  - **Buyer:** The Buyer must approve the release of the VMI replenishment. The system sends a notification for a request to release the replenishment quantity to you (the Buyer organization) after creating the VMI replenishment.
  - **Supplier or Buyer:** Either the Buyer or the Supplier has to approve the release of the VMI replenishment. After creating the VMI replenishment, the system sends a notification to you (the Buyer organization) and the supplier site contact requesting to release the replenishment quantity.
3. Select any one of the following replenishment methods from the Method list:
  - Min-Max Quantities
  - Min-Max Days



- Min Qty and Fixed Order Qty
- Min Days and Fixed Order Qty

The following table shows the allowable combinations of replenishment point selection and reorder quantity selection:

Reorder Point Selection	Reorder Quantity Selection		
	Maximum quantity	Fixed order quantity	Maximum days of supply
Minimum Quantity	Yes	Yes	No
Minimum days of supply	No	Yes	Yes

When the VMI replenishment engine calculates the replenishment quantity based on minimum days of supply:

$$\text{Minimum days of supply} = \text{Units of supply} / \text{Average daily usage}$$

When the VMI replenishment engine calculates the replenishment quantity based on the minimum quantity:

The VMI replenishment engine generates a fixed-order quantity of replenishment when the supply drops below the minimum quantity level.

**Note:** This establishes an inventory policy to reorder a prespecified quantity of material when the available supply drops below the reorder point. This reorder point can be stated in terms of both an absolute value and one that is based in terms of days.

The replenishment method that is specified in the ASL also indicates whether approval by the buyer, the buyer or supplier, or no approval at all is required to create a release against the blanket purchase order upon creation of a VMI replenishment recommendation in Collaborative Planning.

4. In the Minimum Days field, provide a horizon for average daily usage calculation to calculate the average daily usage.

**Note:** The average daily usage is calculated over a forecast horizon that is supplied by the customer (OEM). Specify a forecast horizon to use for calculating average daily usage in the Forecast Horizon

(Days) field in the Supplier-Item Attributes window. The order forecast is used to calculate the average daily usage. Note that, when no order forecast data exists, the average daily demand is set to zero, and the system does not create any replenishment.

5. Select the Automatic Allowed check box to specify the behavior of the replenishment engine. The system acts in any of the following ways based on your selection:
  - Automatic allowed:
    - The system calculates the suggested replenishment quantity.
    - The system can release replenishment quantity automatically. Optionally the buyer or the supplier can release the replenishment quantity manually using the VMI screen.
    - The system sends notifications to the item planner and supplier contact after releasing the replenishment quantity.
  - Automatic not allowed:
    - The system does not calculate the replenishment quantity and the buyer or the supplier must determine it.
    - The system generates exceptions when supply is less than the minimum inventory quantity that is specified by the item planner.

For more information about creating approved supplier lists, refer to *Oracle Purchasing User's Guide*.

#### **In Oracle Inventory**

Select the check box for Round Order Quantities in the MPS/MRP Planning Attribute Group in Master Items window to create replenishment orders in whole number quantities.

## Master Item Window

The screenshot shows the 'Master Item (V1)' window with the 'MPS/MRP Planning' tab selected. The window is divided into several sections:

- Organization:** V1 Vision Operations
- Item:** [Empty field]
- Description:** [Empty field]
- Display Attributes:** Radio buttons for Master, Org, and All (All is selected).
- Planning Method:** Not planned
- Forecast Control:** [Empty dropdown]
- Pegging:** None
- Round Order Quantities:**  (checked)
- Exclude From Budget:**  (unchecked)
- Planned Inventory Point:**  (unchecked)
- Exception Set:** [Empty field]
- Shrinkage Rate:** [Empty field]
- Acceptable Early Days:** [Empty field]
- Create Supply:**  (checked)
- Critical Component:**  (unchecked)
- Repetitive Planning:**  (unchecked)
  - Overrun:** [Empty field] %
  - Acceptable Rate +:** [Empty field]
  - Acceptable Rate -:** [Empty field]
- MPS Planning:**
  - Calculate ATP:**  (unchecked)
  - Reduce MPS:** [Empty dropdown]
- Planning Time Fence:** User-Defined
- Demand Time Fence:** [Empty dropdown]
- Release Time Fence:** [Empty dropdown]
- Substitution Window:** [Empty dropdown]
- Days:** 1

**Note:** You must create the supplier user and assign it to the supplier's site contact list if the approval method for the Approved Supplier Lists is selected as Buyer or None.

## Collect Approved Supplier Lists

Collections are scheduled in Oracle Advanced Supply Chain Planning. Schedule collections to retrieve approved supplier lists and supply information.

For more information about scheduling collections, refer to the *Oracle Advanced Planning and Scheduling Implementation and User's Guide*.

## Publish Order Forecast from ASCP

To calculate the inventory quantity based on the minimum number of days, you should provide the supplier with an order forecast by inventory organization, supplier site, or item. This order forecast is then used to calculate the reorder point, the reorder quantity, or both. To provide the order forecast, use the Publish Order Forecast program and publish the order forecast for the VMI planned item from ASCP to Collaborative Planning. For more information about publishing order forecasts, see "Publish Data Using Oracle Advanced Supply Chain Planning, page 2-42".

## Schedule and Run the VMI Replenishment Engine

To schedule the Vendor Managed Inventory Replenishment Engine, provide a Replenishment Time Fence multiplier. A time fence multiplier of 1 (default) denotes that the VMI engine will calculate available inventory over one times the processing lead time of the vendor managed inventory item.

To create the replenishment manually:

1. Run the VMI Replenishment Engine to calculate the average daily demand and to detect whether the available inventory has dropped below the reorder point.
2. To enter the replenishment quantity manually, click the Create Replenishment button on the VMI screen.
3. The VMI Replenishment Engine uses the replenishment quantity to directly create a release against a VMI blanket purchase order in the source.

To create the replenishment automatically:

1. Run the VMI Replenishment Engine with either the buyer's or the supplier's approval.
2. The VMI Replenishment engine:
  1. Detects whether the available supply has dropped below the reorder point.
  2. Generates an exception.
  3. Calculates the average daily demand.
  4. Calculates the replenishment quantity considering supplies within the specified Replenishment Time Fence (RTF) based on days of supply.
  5. Recommends a replenishment quantity (which may be automatically released to ERP or may require buyer or supplier approval, depending on the approval setting in Oracle Purchasing).
3. If approval for the replenishment recommendation is required, the planner or the supplier contact can edit the replenishment quantity from the VMI screen.
4. Click the Release button on the VMI screen to generate a release against a VMI blanket purchase order in the source system.

**Note:** To schedule the VMI replenishment engine, provide a Replenishment Time Fence multiplier. A time fence multiplier of 1 (default) denotes that the VMI engine will calculate available inventory

over one times the processing lead time of the vendor-managed inventory item.

For more information about the VMI replenishment Engine, see "VMI Replenishment Engine".

## View Replenishment Orders

After you schedule and run the VMI Replenishment Engine, you can view replenishments in Oracle Collaborative Planning. The VMI screen provides you with a convenient snapshot to monitor inventory levels and release orders and to access forecast information. You can also navigate to the View Projected Stockout windows from a row in the VMI screen.

The following columns are specific to the VMI screen:

- Replenishment Date. This date appears as the Need By Date on purchase requisitions/purchase orders.
- Suggested Replenishment Quantity.
- Replenishment Quantity.
- In-process quantity.
- In transit Quantity
- VMI Status
- Stockout Chart

For more information about these fields, see Monitor and Replenish Inventory, page 4-12.

## Submit Advance Shipment Notices

A supplier creates an Advanced Shipment Notice (ASN) to communicate that material has shipped. Advance shipment notices are created using Oracle iSupplier Portal. The following information is required:

- Quantity
- Ship Date - Actual
- Receipt Date - Planned
- Comments (optional)

# Monitor and Replenish Inventory

## Monitor Inventory Status

Your suppliers monitor inventory levels using the inventory status screen.

Complete the following steps to access the Inventory Status window in Oracle Collaborative Planning:

1. From the Home page in Oracle Collaborative Planning, select the Planning tab.
2. Under the Planning tab, select VMI. The Inventory Status window displays. The following image depicts the Inventory Status window:

**Inventory Status Window**

**ORACLE Collaborative Planning**  
[Home](#) [Logout](#) [Preferences](#) [Help](#) [Personalize Page](#) [Diagnostics](#)

[Home](#) | [Exceptions](#) | [Planning](#) | [Admin](#)

[Horizontal View](#) | [Vertical View](#) | [VMI](#) | [Forecast Comparison](#) | [Create Order](#) | [Plan](#)

**Vendor Managed Inventory Status**  
[Personalize "VMI search container region"](#)

**Search**

[Personalize "Search"](#)

Item  Customer    
 Customer Item  Supplier    
 Supplier Item  View Quantity in Units

[Personalize Query: \(MscXVmiResultsContainer\)](#)

View ▼

[Personalize "VMI Tabular Data"](#)

Select Item(s):

[Select All](#) | [Select None](#)

Select	Item	Customer	Customer Site	Supplier	Supplier Site	VMI Status	Replenish Date
<input type="checkbox"/>	AS54888	Discount SuperStore	5426	Vision Corporation		Onhand:0 Onorder:0 <div style="border: 1px solid black; width: 100px; height: 10px; margin: 2px;"></div> Min:10 Max:30	
<input type="checkbox"/>	AS65101	Discount SuperStore	5426	Vision Corporation		Onhand:0 Onorder:0 <div style="border: 1px solid black; width: 100px; height: 10px; margin: 2px;"></div> Min:0 Max:0	
<input type="checkbox"/>	AS65102	Discount SuperStore	5426	Vision Corporation		Onhand:0 Onorder:0 <div style="border: 1px solid black; width: 100px; height: 10px; margin: 2px;"></div> Min:0 Max:0	
<input type="checkbox"/>	AS66311	Discount SuperStore	5426	Vision Corporation		Onhand:0 Onorder:0 <div style="border: 1px solid black; width: 100px; height: 10px; margin: 2px;"></div> Min:5 Max:50	
<input type="checkbox"/>	AS66312	Discount SuperStore	5426	Vision Corporation		Onhand:0 Onorder:0 <div style="border: 1px solid black; width: 100px; height: 10px; margin: 2px;"></div> Min:0 Max:0	
<input type="checkbox"/>	AS66313	Discount SuperStore	5426	Vision Corporation		Onhand:5 Onorder:0 <div style="border: 1px solid black; width: 100px; height: 10px; margin: 2px; background-color: red;"></div> Min:10 Max:30	
<input type="checkbox"/>	AS72111	Discount SuperStore	5426	Vision Corporation		Onhand:5 Onorder:0 <div style="border: 1px solid black; width: 100px; height: 10px; margin: 2px; background-color: red;"></div> Min:10 Max:30	
<input type="checkbox"/>	AS92888	Discount SuperStore	5426	Vision Corporation		Onhand:0 Onorder:0 <div style="border: 1px solid black; width: 100px; height: 10px; margin: 2px;"></div> Min:10 Max:30	
<input type="checkbox"/>	CM66224	Vision Corporation	TST:M1	Prouty Industrial Supply	RED WING	Onhand:0 Onorder:0 <div style="border: 1px solid black; width: 100px; height: 10px; margin: 2px;"></div> Min:0 Max:0	
<input type="checkbox"/>	CM66229	Vision Corporation	TST:M1	Prouty Industrial Supply	RED WING	Onhand:0 Onorder:0 <div style="border: 1px solid black; width: 100px; height: 10px; margin: 2px; background-color: #90ee90;"></div> Min:0 Max:1000	

Select Item(s):

[About this Page](#) [Privacy Statement](#) Copyright (c) 2006, Oracle. All rights reserved.

In the Inventory Status window you can view the replenishment information. The following table describes pertinent columns you can view in the Inventory Status window:

Column	Description												
Replenishment Date	Displays the date when replenishment is necessary. The system calculates the replenishment date by adding item processing lead time to the VMI Engine run date. This date appears as the Need By Date on purchase requisitions and purchase orders.												
Suggested Replenishment Quantity	Displays the quantity that Oracle Collaborative Planning recommends for replenishment. For items that are planned in days, this column displays the replenishment quantity in days. For the items that are planned in units, this column displays the replenishment quantity in units. This column is editable under the following circumstances:												
	<table border="1"> <thead> <tr> <th>Item Type</th> <th>Editable</th> </tr> </thead> <tbody> <tr> <td>1. Items that are planned in days</td> <td>Yes</td> </tr> <tr> <td>2. Average daily usage is not zero</td> <td></td> </tr> <tr> <td>1. Items that are planned in days</td> <td>No</td> </tr> <tr> <td>2. Average daily usage is zero</td> <td></td> </tr> <tr> <td>3. Items that are planned in units</td> <td></td> </tr> </tbody> </table>	Item Type	Editable	1. Items that are planned in days	Yes	2. Average daily usage is not zero		1. Items that are planned in days	No	2. Average daily usage is zero		3. Items that are planned in units	
Item Type	Editable												
1. Items that are planned in days	Yes												
2. Average daily usage is not zero													
1. Items that are planned in days	No												
2. Average daily usage is zero													
3. Items that are planned in units													
Replenishment Quantity	Displays the quantity that you want to release. This number must be less than or equal to the suggested replenishment quantity.												
In-process quantity	Displays the quantity that was released for replenishment. This number is set to zero after each replenishment engine run.												
In-Transit Quantity	Displays current in-transit shipment information that your VMI supplier is responsible for managing. For items that are planned in days, this column displays the replenishment quantity in days. For items that are planned in units, this column displays the replenishment quantity in units.												



---

<b>Column</b>	<b>Description</b>
VMI Status	Displays the graphical view of on-hand, in-order, minimum and maximum quantities. The system calculates these quantities based on days if the item is planned in units and vice versa. If Average daily demand is zero, then the graph displays zero for all the quantities.
Stockout Chart	A stockout chart provides a projection of the on-hand balance that is given the present state of supplies, demands, and inventory replenishment parameters. Using this chart, you can foresee inventory problems and make adjustments as required. For min-max planned items (items that are planned using days of minimum and maximum inventory) the stockout report displays the projected stock outs as per the order forecast. The stockout chart enables you to simulate the changes to replenishment parameters. Planners can change the replenishment method, the replenishment quantities, or both using the stockout chart.

---

Complete the following steps to display the Projected Available Balance report for the selected item:

1. Click the Stockout Chart icon in the Stockout Chart column for a specific VMI record in the VMI screen.

The Projected Available Balance report opens in a pop-up window.

## Projected Available Balance Report

**Projected Available Balance for min/max planned items**

[Personalize "Projected Available Balance for min/max planned items"](#)

[Personalize Default Single Column: \(TopRegion\)](#)

Item **AS72111**

Customer **Discount SuperStore**

Customer Site **5426**

Supplier **Vision Corporation**

Supplier Site:

**Projected Available Balance**

Date	Min	Max	Proj. Onhand	Safety Stock
21-Feb-2004	10	30	0	10
23-Feb-2004	10	30	30	10
25-Feb-2004	10	30	29	10
27-Feb-2004	10	30	28	10
29-Feb-2004	10	30	27	10
02-Mar-2004	10	30	26	10
04-Mar-2004	10	30	25	10
06-Mar-2004	10	30	24	10
08-Mar-2004	10	30	23	10
10-Mar-2004	10	30	22	10
12-Mar-2004	10	30	21	10
14-Mar-2004	10	30	20	10
16-Mar-2004	10	30	19	10
18-Mar-2004	10	30	18	10

[Personalize Stack Layout: \(bottom\)](#)

[About this Page](#) [Privacy Statement](#) Copyright (c) 2006, Oracle. All rights reserved.

Note that all the global buttons remain hidden in this window. The Projected Available Balance chart displays the:

- Safety Stock
- Minimum Quantity
- Maximum Quantity
- Projected On-Hand Quantity

The following colors are used to display the various quantities:

- Red: Minimum Quantity
- Green: Maximum Quantity

- Blue: Projected Available balance
- Orange: Safety Stock

**Note:** You can view the Projected Available Balance for only one item at a time belonging to a supplier / supplier site / organization combination.

2. To close the Projected Available Balance report and return to the VMI screen, click OK.

### **Search Inventory by Buyer Code**

You and your trading partners who are related specifically to a particular customer can search information for all transactions under the customer's supervision in one view using the buyer code. Buyer codes also help you to categorize purchase orders and purchase requisitions based on customers' buyer codes and to quickly track an issue that is related to a specific customer.

Complete the following steps to search information based on a buyer code:

1. On the VMI screen, select Advanced Search.

The Inventory Status Advanced Search screen opens.

### The Inventory Status Advanced Search Screen

2. To filter records based on buyer code, in the Add Another list, select Buyer as the new search field and select Add.  
The Buyer Code field is appended.
3. Select the search criteria. For more information about advanced search, see "Horizontal and Advanced Horizontal View: Advanced Search, page 9-3".
4. In the Inventory Status Advanced Search window, select Search. The Collaborative Planning engine filters and displays the purchase orders and purchase requisitions for the buyer code on the VMI screen.

The VMI screen now displays new columns for the buyer code that are used as filtering criteria. Note that the Buyer column displaying the selected buyer code is added only after the user performs a filtration using the advanced search or preference sets based on the buyer code.

You must associate a buyer with an item in Oracle Inventory to search transactions based on buyer code. For more information about setting up this search field, see "Setup: Setting Up Buyer Code and Item Category, page 2-23."

## Replenish Inventory

In Vendor Managed Inventory (VMI) with suppliers, a supplier is responsible for managing inventory replenishment at a customer location. The customer posts onhand

inventory information and the supplier posts in-transit information. This results in available quantity. Available quantity is the sum of the following:

- Onhand inventory
- Open purchase requisitions
- Open purchase orders
- In-transit shipments
- Receipts awaiting delivery

When the available quantity at the customer location is less than a specified minimum (the replenishment trigger point) Oracle Collaborative Planning notifies the customer and supplier. The supplier can then replenish the necessary inventory.

## Exceptions

Inventory shortage and excess exceptions are generated for VMI items only when Manual is the replenishment method (Automatic Allowed is unchecked). You can access the detail information by selecting the Exceptions tab in Oracle Collaborative Planning.

For VMI, material shortage exceptions have two notices:

- VMI item shortage at your site
- VMI item shortage at your customer's site, replenishment required

For VMI, material excess exceptions have two notices:

- VMI item excess at your site
- VMI item excess at your customer's site

These exceptions are generated to assist you in identifying which vendor managed inventory items have material shortages or excess inventory. For more information about exceptions, refer to Exceptions, page 7-1.

## VMI Replenishment Engine

To generate VMI exceptions and send notifications you must run the VMI Replenishment Engine. To run the VMI Replenishment Engine you must have the Advanced Planning System Administrator responsibility assigned to your username.

To schedule the VMI replenishment engine you must provide a replenishment time fence (RTF) multiplier. Supplies that fall within the time period (RTF x multiplier) are considered as available inventory.

To run the VMI replenishment engine, complete the following steps:

1. Log into under the Advanced Planning Administrator responsibility.
2. Navigate to Other > VMI Replenishment Engine.
3. Enter a value for the Replenishment Time Fence multiplier and select OK.

**Note:** The replenishment time fence is the point in time that marks a boundary within which supplies should be considered before triggering replenishments. This boundary is calculated by taking the sum of the processing lead time and the VMI engine run date. This time fence would allow you to specify time horizons of supply for items, which may have very short/long in-transit times.

4. Select Submit.

## Notifications

To view notifications, log onto the system. The main Collaborative Planning Home page displays any outstanding notifications that relate to your vendor managed inventory items. Alternatively, you can select the Exceptions tab to view any relevant exceptions.

**Note:** You must run the VMI Replenishment Engine to generate exceptions and send notifications.

---

# Vendor Managed Inventory with Customers

This chapter covers the following topics:

- Overview of Vendor Managed Inventory with Customers
- User Setup for VMI with Customers
- The Different Flavors for Customer Facing VMI Process

## Overview of Vendor Managed Inventory with Customers

Vendor Managed Inventory (VMI) with Customers (customer-facing VMI) enables you to manage inventory at the business sites of your customers with material ownership transferring to the customer either upon receipt of material or upon consumption of material. Customers can share their on-hand inventory for each item at an individual location, and Collaborative Planning will create replenishment orders based on flexible replenishment rules if material needs to be shipped. This process helps to improve service levels and increase revenues by automating a previously manual and labor-intensive process that required customers to provide individual purchase orders. You can implement this feature to prevent stock outs and increase inventory turns at the customer locations. The traditional method of inventory management at a customer site is highly transaction oriented and provides little visibility into the inventory and demand position at the customer site . It is prone to stock outs, high transactional costs and increased expediting costs. This functionality provides you the following benefits:

1. **Receive sales history from customers in the forecasting process:** You can generate a baseline forecast for the expected sales using the past sales history from the customer. You may collect the past sales history from your customers in electronic format and transfer the same into your forecasting system. The forecasting system then uses the sales history as one of the inputs to create the sales forecast.
2. **Use sales forecast, order forecast, or historical sales to determine replenishment points and quantities:** After receiving a sales forecast or order forecast, you can use it to determine the replenishment points and quantities for customer sites. If you receive the past sales history from the customer, you may also use this history to

calculate the replenishment points and quantities for the customer. You can specify the period over which you want to consider the sales history for the calculation.

3. **Support for multiple replenishment types:** Depending on the item and channel that you are serving, you may replenish the customer in different ways. You may decide to support an inventory policy based either on quantity or days of supply.
4. **Create sales orders based on replenishment orders:** The system typically uses the forecast published by the customer to plan on-hand replenishment quantity and generate replenishment orders. You can create a sales order in your order management system and eventually make a shipment against it after the system has identified the required replenishment at a customer site.

## User Setup for VMI with Customers

The process flow to set up VMI with customers consists of the following steps:

1. Define a customer organization for each customer site
2. Define/Load Customer sites
3. Set up inventory organizations within your enterprise corresponding to the customer sites
4. Define VMI items
5. Set up replenishment controls
6. Set up a blanket sales agreement containing pricing information
7. Create a user for the customer site contact
8. Set sourcing rule
9. Set default shipping organization



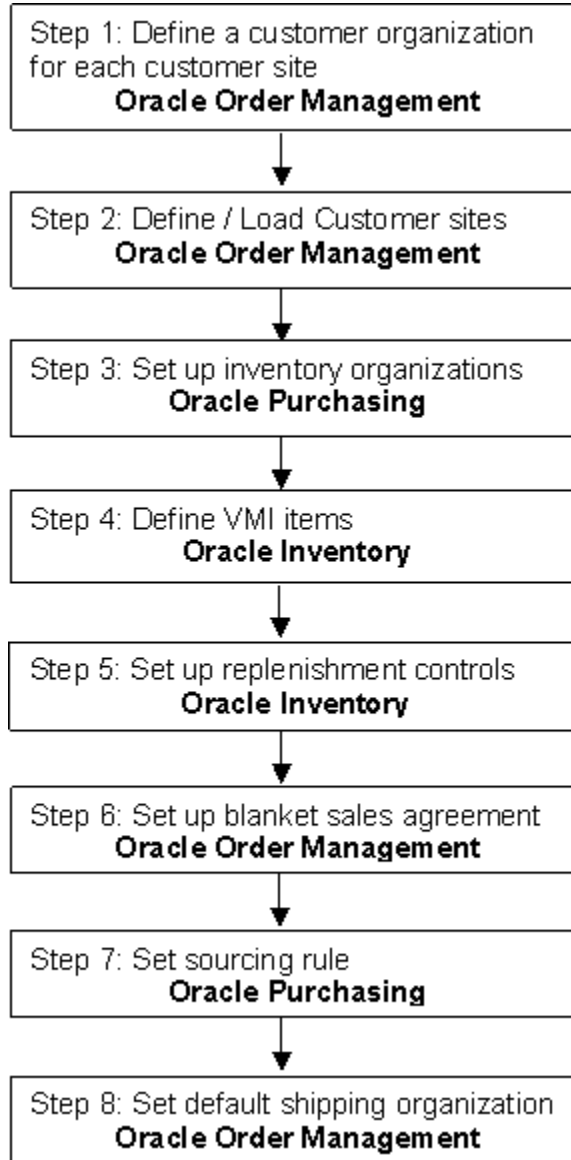

## Setup Steps in Oracle Order Management

### Step 1: Define a customer organization for each customer site

Define your customer with whom you are engaged in a VMI relationship. For more information on adding customer information, see "Add Customers" in *Oracle Order Management User's Guide*.

### Step 2: Define/Load Customer sites

Define a customer site for each of the customer's stores or warehouses at which you will be managing inventory. Specify a customer contact for each site. A default shipping

organization also needs to be specified for this site. For more information on defining customer site, see "Customer Location Overview" in *Oracle Order Management User's Guide*.

### Step 3: Assign a Line Type process while defining a Transaction Type

While defining a transaction type, select Bill Only Line Type process for each transaction type. After each order line booking the Inventory Interface subprocess is invoked within the Bill Only Line Flow. For information on defining a transaction type refer *Oracle Order Management User's Guide*.

## Setup Step in Oracle Purchasing

### Step 4: Set up inventory organizations

Create an external inventory organization to represent each customer's inventory stocking location. You must create inventory organization for each of the customer's stores or warehouses that you will use to manage inventory. Associate the inventory organization to the customer site to be replenished. You must ensure the association of the customer site to the inventory organization. Once the organization has been defined, you will create the VMI item in this organization.

#### The Customer/Supplier Association Window

The screenshot displays two overlapping Oracle application windows. The background window, titled "Organization", contains the following fields: Name (Atlanta Manufacturing), Type (Plant), Dates (From 07-DEC-1997, To [empty]), Location (P1- Atlanta), Internal or External (Internal), Location Address (United States 11 Abernathy Rd. Atlanta GA 30328 Fulton United States 770-394-...), Internal [checkbox], Organization [empty], and Name [empty]. Overlaid on top is a smaller window titled "Additional Organization Information" with a "Customer/Supplier Association" section. This section includes fields for Customer (Atlanta Manufacturing), Customer Site, Supplier, and Supplier Site. At the bottom of the "Additional Organization Information" window are buttons for OK, Cancel, Clear, and Help.

For more information on setting up inventory organizations and associating them to customer sites, see "Setup Checklist" in *Oracle Purchasing User's Guide*.

## Setup Steps in Oracle Inventory

### Step 5: Define VMI items

Define the item in the inventory organization created for the customer site. Provide order modifiers. For more information on defining VMI items see *Defining Items in Oracle Inventory User's Guide*.

### Step 6: Set up replenishment controls

1. **VMI enable the item:** Specify if the item will be VMI enabled in that organization using the general planning tab in the item master.

**The Master Item Window**

The screenshot displays the Oracle Master Item Window for item AS65122, 'Vision Pad - Bronze', in organization V1. The 'General Planning' tab is active, showing the following settings:

- Organization: V1 Vision Operations
- Item: AS65122
- Description: Vision Pad - Bronze
- Inventory Planning Method: Min-Max
- Subcontracting Component: (empty)
- Planner: (empty)
- Make or Buy: Buy
- Min-Max Quantity: Minimum (empty), Maximum (empty)
- Order Quantity: Minimum (empty), Maximum (empty)
- Cost: Order (empty), Carrying (empty) %
- Source Type: (empty)
- Organization: (empty)
- Subinventory: (empty)
- Safety Stock Method: Non-MRP Planned
- Bucket Days: (empty)
- Percent: (empty)
- Order Modifiers: Fixed Order Quantity (empty), Fixed Days Supply (empty), Fixed Lot Multiplier (empty)
- Vendor Managed: Replenishment Point (empty), Order Quantity (empty)

2. **Release Authorization Required flag:** Specify if manual intervention is required to create a sales order.
  1. **Value = None:** Directs the system to create a sales order release to implement the suggested replenishment quantity without any user intervention.
  2. **Value = Supplier:** Direct the system to create a replenishment quantity after the item planner approves the creation of a sales order release. The system notifies

the item planner that his approval is required.

3. **Value = Customer:** Direct the system to create a sales order for the suggested replenishment quantity based on the approval of the customer, for which a notification is sent to the contact user at the customer site. Note that you must select the Consigned check box to enable customer consigned VMI. This is the default value that Collaborative Planning uses.
3. **Replenishment point:** Specify the replenishment point type:
  1. Min-max based on quantity
  2. Min-max based on days of supply
4. **Reorder quantity selection:** Specify how the reorder quantity should be calculated:
  1. Maximum quantity in UOM
  2. Maximum days of supply
  3. Fixed order quantity
5. **Auto-expire ASN:** Specify whether the ASN should expire on the schedule arrival date.
  1. **Value = Yes:** The system does not consider the ASN for the supply calculation.
  2. **Value = No:** The system considers the ASN for supply calculation until a receipt is posted pegged to the ASN.
6. **Select Forecast Type for Average Daily Demand Calculation:** Select one of the following forecast type:
  1. **Order Forecast:** Use an order forecast posted by the customer to calculate the average daily usage.
  2. **Sales Forecast:** Use a sales forecast posted by the planner to calculate the average daily usage.
  3. **Historical Sales:** Use historical sales data posted by the customer to calculate the average daily usage.
7. **Window Days:** Define this horizon in days in the Item screen. The system calculates the average daily demand across all the forecasts, if they exist, for a given customer site. The system assumes that if the customer provides different forecasts to individual supplier sites for the same customer site, the forecasts are global forecasts. The demand is aggregated across the different supplier sites and used in

the average daily usage calculation.

8. **Calendar setups:** You define a calendar in Oracle Bills of Materials. A calendar is used to:
  1. Calculate the release time fence (RTF).
  2. Calculate the number of working days using the forecast horizon.

**Note:** The system uses the receiving calendar at the customer site on a prioritized basis. The manufacturing calendar for the customer organization is used only if the receiving calendar at the customer site is not available. Otherwise, Collaborative Planning uses the default system calendar.

For more information on General Planning tab in the Master Item window, see General Planning Attribute Group in *Oracle Inventory User's Guide*.

## Setup Step in Oracle Order Management

### Step 6: Set up a blanket sales agreement containing pricing information

Set up a blanket sales order for the VMI item. The system creates a sales order release against this sales order when you need to replenish material to a customer site. You may provide the customer purchase order number to refer to the sales order release. Set up a blanket sales agreement for this item. If multiple blanket sales orders exist, Collaborative Planning creates the release against a blanket using the following hierarchy:

1. Use an item-specific blanket if one exists.
2. Use an item category-specific blanket if one exists.
3. Use a customer-specific blanket sales order (this is mandatory for a blanket order).

### The Blanket Sales Agreement Window

Customer: Ace Communications  
 Customer Number: 1925  
 Sales Agreement Number: 1192  
 Sales Agreement Type: BSA with Approvals  
 Contract Template: Vision Operations Blank  
 Activation Date: 11-SEP-2006  
 Expiration Date:   
 Disallow New Releases

Line	Item Context	Item	UOM	Item Description	Activation Date	Expi
1	Internal Item Num:	AS41001	Ea	PDA - PALMATE DATA ASSI	11-SEP-2006	
2	Internal Item Num:	AS54555	Ea	Sentinel Standard Desktop TF	11-SEP-2006	
3	Internal Item Num:	AS54888	Ea	Sentinel Standard Desktop TF	11-SEP-2006	
4	Internal Item Num:	AS33656	Ea	Vision PRO Graphics Update	11-SEP-2006	
5	Internal Item Num:	AS62445	Ea	Envoy Upgrade Pack	11-SEP-2006	

Buttons: Actions, Contract Terms, Price List Setup, Submit Draft

For more information on setting up blanket sales agreements, see *Create a Blanket Sales Agreement* in *Oracle Order Management User's Guide*.

## Setup Step in Oracle Purchasing

### Step 7: Set sourcing rule

Set a sourcing rule to determine the source point for the replenishment material to be shipped. The Order Management system initiates the ATP engine and also determines the shipping organization (warehouse). Specify the assignment set to use in the ATP: Default Assignment Set profile option.

To ensure that ATP is called by Order Management, set the VMI item to be ATP-able.

**Note:** This step is required only if Oracle Global Order Promising determines the Scheduled Ship Date on the Sales Order.

For more information on defining sourcing rules, see the "To default just the supplier and the supplier site:" section in *Oracle Purchasing User's Guide*.

## Setup Step in Oracle Order Management

### Step 8: Set default source shipping organization

Set a default source shipping organization. It is required for both consigned and unconsigned VMI. For more information on defining default shipping organization, see page "Defaulting Rules" in *Oracle Order Management User's Guide*.

Also, in the Inventory Organization for the customer specified earlier, the name of the source shipping organization must be provided in the internal organization field of the "Ship-To" site.

## The Different Flavors for Customer Facing VMI Process

The customer facing VMI process consists of the following flavors:

- Unconsigned VMI with Customers
- Consigned VMI with Customers

The difference between these flavors is essentially based upon the ownership of the materials supplied to the customer site. The following table discusses the basic differences between these flavors.

<b>Unconsigned VMI with Customers</b>	<b>Consigned VMI with Customers</b>
In this flavor, the customer owns the inventory as soon as it is received at the customer site.	In this flavor, the e-Business Suite owner (the company that owns and runs Oracle Collaborative Planning) owns the inventory, even after it has been received at the customer site. Ownership transfers from the e-Business Suite owner to customer only upon consumption of the inventory by the customer at the customer site.

---

**Unconsigned VMI with Customers**

In this flavor, material is shipped from the e-Business Suite owner to customer site using an external sales order. This allows invoicing of the customer by the e-Business Suite owner at that point. This is called "pay-on-receipt".

---

**Consigned VMI with Customers**

In this flavor, material is shipped from the e-Business Suite owner to the customer site using an internal sales order.

After consuming the material, the customer posts a consumption advice transaction to Collaborative Planning.

Collaborative Planning generates a "bill only with inventory consumption" external sales order that transfers the inventory ownership to the customer and permits the e-Business Suite owner to invoice the customer for the consumed inventory.

---

## Order Types used in Unconsigned and Consigned VMI with Customers

The following order types are used in customer-facing VMI (unconsigned and consigned):

---

Order Type	Used by Unconsig ned VMI with Custome rs	Used by Consig ned VMI with Custome rs	Nature and Source
On-hand	Yes	Yes	Collected from the external customer organization
Sales orders	Yes	Yes	<ul style="list-style-type: none"><li>• Internal sales orders to ship material from warehouse to customer site</li><li>• Sales order to move material from external org to customer site</li></ul>
ASN	Yes	Yes	Derived from Shipping
Consumption advice	No	Yes	Posted by customer. Used to create regular sales orders.

---



## **Process for Customer-Facing VMI**

The initial steps for the process for VMI with customer are the same for unconsigned and customer-consigned VMI. For this reason, this section discusses the common steps first, followed by the steps specific for unconsigned VMI with customers and customer-consigned VMI.

### **Initial Steps Common to Unconsigned VMI and Consigned VMI with Customers**

1. Run collections program
2. Customer posts demand information
  - Collect past sales history from customer
  - Receive historical sales into Demand Planning
  - Publish sales forecast or order forecast to Collaborative Planning
3. Customer provides on-hand inventory

### **Process for Unconsigned VMI with Customers**

The process for Unconsigned VMI with Customers consists of the following steps:

1. Run VMI Engine
2. Retrieving ASN to calculate replenishment quantity
3. VMI Engine suggests unconsigned replenishment quantity
4. Send replenishment notifications
5. Create sales orders release
6. Send purchase order release notification
7. Ship materials to customer
8. Customer receives the shipment
9. Customer Updates On-hand

### **Process for Consigned VMI with Customers**

1. Run VMI Engine
2. Create replenishment orders

3. Ship material to customer site
4. Customer receives material
5. Customer posts consumption advice
6. Create sales orders

The following image depicts the workflow for VMI with customers:

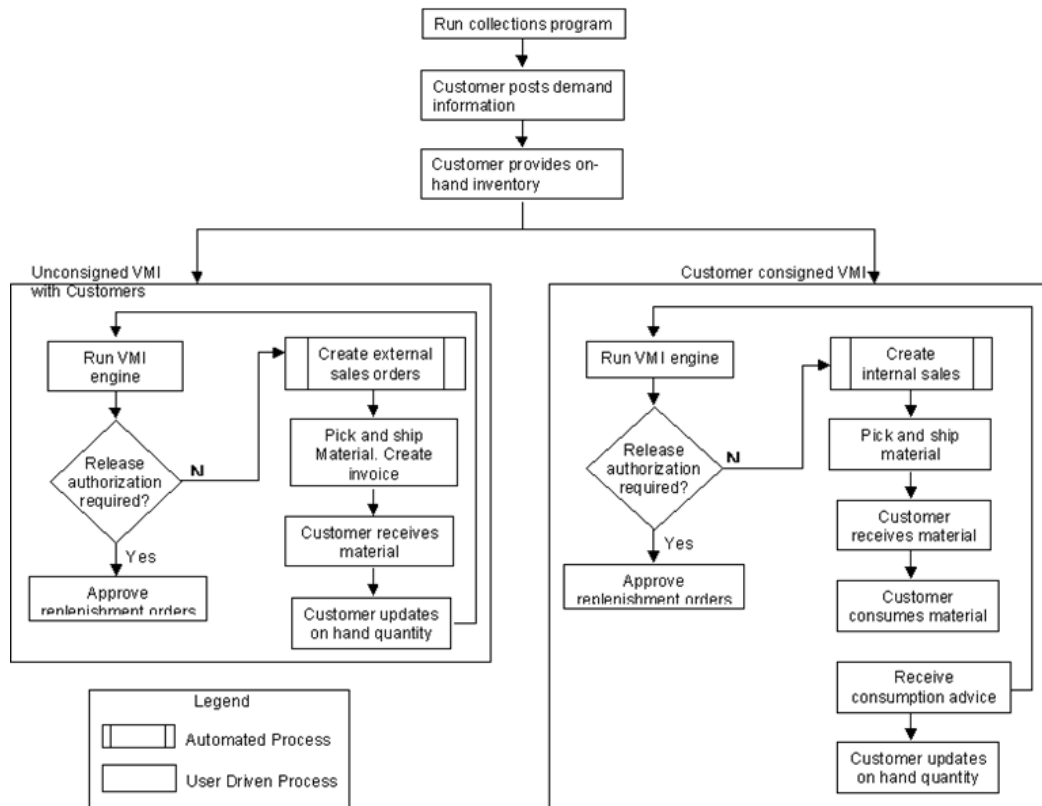

## Initial Steps Common to Unconsigned and Consigned VMI with Customers

### Run the Collections program

Run the collections program to collect items, customers, customer sites, sales order, and ASN information into Collaborative Planning. For customer facing VMI, the system collects outbound ASN information and external sales order from the shipping organization. Use the following navigation path to submit a concurrent request for data collection:

Advanced Planning Administrator Navigator > Collections > Oracle Systems > Standard Collections.

For more information on running Standard Collections program, refer to *Oracle*

### **Collect past sales history from the customer**

Customers provide past sales history using the historical sales order type for each item and customer site. The history may be for a period that is mutually agreed upon and should be useful for generating a sales forecast.

Customers also post sales forecast, order forecast, or historical sales to Collaborative Planning. Each of these options are discussed as follows:

- **Receive historical sales into Demand Planning**

Customers can (optionally) provide you with sales history that you can use in the Demand Planning process. They upload sales history using the order type called historical sales. The system then transfers the sales history to Demand Planning using the Receive Forecast from Customer program. This stream is brought in as a custom stream and used to create the customer sales forecast. The customer is expected to provide a sales history while initiating VMI. Subsequently, the customer will provide daily or weekly Point Of Sales (POS) figures. For more information about receiving forecasts from customers, see *Forecasting: Receive Forecasts in Oracle Demand Planning*, page 3-7.

- **Publish sales forecast or order forecast to Collaborative Planning**

Publish the customer sales forecast created in Demand Planning or (order forecast created through other means) to Collaborative Planning using the Publish Forecast to Customer program. For more information about publishing sales or order forecast to customers, see *Forecasting: Publish Forecasts*, page 3-5.

- **Customer provides on-hand inventory**

Customer provides on-hand inventory at each customer site on a daily or weekly basis directly into Collaborative Planning using XML or into the source using the user interface. If the customer posts the on-hand inventory through the user interface, you should collect the information into Collaborative Planning. Customers can post their on-hand inventory amount using either the unallocated on-hand or allocated on-hand order type. The VMI engine considers the total of all on-hand quantities (allocated and unallocated) for a given customer organization, if both are posted. For more information about uploading and collecting on-hand inventory, see *Forecasting: On hand Inventory Visibility*, page 3-15 and *Collaborative Inventory Visibility: Upload Unallocated On hand Inventory*, page 6-4.

## **Process for Unconsigned VMI with Customers**

### **Run VMI Engine**

1. Submit a concurrent request to VMI Replenishment Engine.

The VMI Replenishment Engine generates the replenishment orders if the added value of the on-hand quantity, open orders, and goods in transit is less than the minimum replenishment quantity or the minimum replenishment days.

To launch the VMI Replenishment Engine,

2. Navigate to Advanced Planning Administrator Navigator window using seeded Advanced Planning Administrator responsibility.
3. Select the VMI Replenishment Engine option from the Other menu. The Parameters window for the VMI Replenishment Engine opens.

#### The Parameters Window for VMI Replenishment Engine

The screenshot displays the 'VMI Replenishment Engine' window with a 'Parameters' dialog box open. The main window contains the following fields: 'Name' (VMI Replenishment Engine), 'Operating Unit', 'Parameters', 'Language' (American English), and 'Print to' (noprint). The 'Parameters' dialog box contains: 'Replenishments from Suppliers' (Yes), 'Replenishment Time Fence Multiplier (>=1)' (1), and 'Replenishments to Customers' (Yes). The dialog box has 'OK', 'Cancel', 'Clear', and 'Help' buttons.

4. Select Yes in the Replenishments to Customers field.
5. To schedule the Vendor Managed Inventory Replenishment Engine, enter an RTF multiplier. A time fence multiplier of 1 (default) denotes that the VMI engine will calculate available inventory over one times the processing lead time of the vendor managed inventory item.
6. Click OK to submit a request to run the concurrent process.

The VMI engine automatically creates the sales orders based on the supplies (on-hand + open requisitions + open internal sales orders + goods in transit) falling within the horizon of system date and the pick to ship lead time for the item. After the sales orders

are created the normal pick release and ship confirm programs run to fulfill the order.

- The calculation of on-hand quantity will be posted using the order types allocated on-hand or unallocated on-hand.
- If both allocated and unallocated on-hand quantities are posted, the engine should consider the total of allocated and unallocated on-hand.
- The sales order quantity used in calculating the replenishment quantity includes past due sales orders.
- If sales orders are posted/collected from multiple shipping organizations for the same customer site, the engine considers the total sales order quantity for calculating the replenishment quantity.
- The internal requisition quantity used in the calculation includes past due requisitions.

#### Retrieving ASN to calculate replenishment quantity

The ASN quantity used is the sum of all open trip stops collected from Order Management. If ASNs are posted using flat files, the ASN quantity is counted until it is consumed by a receipt or expires. The ASN is stored in Oracle Shipping. To consider the ASN quantity, the ASN must be derived by the system in Collaborative Planning. The derivation of the ASN will be as follows:

##### 1. Deriving ASNs when the Auto Expire ASN flag is set to Yes (default)

In this case, the customer does not provide any notification after receiving replenishment from the supplier. Therefore it is assumed that a shipment is received at the customer site close to its planned arrival date.

Order Type	Source	Collection Criteria	Publisher/Subscriber
ASN	Oracle Shipping	Collect in transit delivery lines that reached the customer site on the Planned Arrival Date	<b>Publisher:</b> OEM/Shipping organization  <b>Customer:</b> Customer/ Customer site

##### 2. Deriving ASNs when the Autoexpire ASN flag = No

In this case, the customer does not provide any notification after receiving

replenishment from the supplier. Therefore it is assumed that a shipment has been received at the customer site close to its planned arrival date.

Order Type	Source	Collection Criteria	Publisher/Subscriber
ASN	Oracle Shipping	Collect the shipped delivery lines when the trip stop status is set to Closed	<p><b>Publisher:</b> OEM/Shipping organization</p> <p><b>Customer:</b> Customer/ Customer site</p>

### VMI Engine Behavior

1. The VMI Replenishment Engine plans for all items that are VMI-enabled in customer organizations.
2. The RTF horizon is calculated as: [System Date + (Pre Processing + Processing + Post Processing + Intransit Lead Time) \* Replenishment Time Fence multiplier for customer item.
3. The horizon used for the calculation of average daily demand is determined based on the value entered in the Horizon for Average Daily Usage Calculation field. You can find this field in the Vendor Managed Replenishment Point block on the General Planning tab in the Item Master window.
4. The VMI Replenishment Engine calculates average daily demand for each combination of item, customer, and customer site (including those combinations with no new data). The average daily demand will be added each time the VMI engine runs and will be stored in the MSC\_SYSTEM\_ITEMS table item/customer modeled organization (corresponding to the customer, customer site). For more information on the table MSC\_SYSTEM\_ITEMS, see "Appendix D: Key Tables."
5. The average daily demand for an item/customer/customer site/supplier is calculated using forecast data within a predefined forecast horizon. The customer site must be the modeled customer organization. Note that you must specify the following to calculate the average daily demand collection:
  - The forecast type to be used when calculating average daily demand in the Master Item form. The possible forecast types are order forecast, sales forecast, and historical sales.
  - The forecast horizon for average daily demand calculation in the Master Item form.

6. The VMI engine recalculates the average daily demand at each run even when no transaction data has changed. The average daily demand is calculated based on a horizon starting from the current system date. If the average daily demand has changed since the run of the VMI engine and the replenishment method is based on days of supply, the replenishments is recalculated even if no transaction data has changed.
7. The VMI engine calls a program called Create/Update orders for VMI for creating and updating orders in the source: sales orders, requisitions, and ATP override. You can monitor the status of this program through the View Request screen.
8. The average daily demand is set to zero when forecast data exist in the system (either order forecast, sales forecast, or historical sales).
9. Supplies that fall within the item's time fence will be considered for the supply calculation. If the replenishment point is selected as minimum days of supply, the VMI engine determines the reorder quantity based on the maximum days of supply or the fixed order quantity.
10. If the replenishment point is selected as minimum quantity, the VMI engine should determine the reorder quantity based on maximum days quantity or fixed order quantity
11. Total supply is considered as the sum of ASN, sales order, and on-hand quantity. If total supply drops below the minimum units/days of supply, a sales order is released to increase the supply in the customer site.
12. The total supply and replenishment is created in the item/customer/customer site/supplier (OEM) level unlike the supplier facing VMI where the VMI relationship is defined at an item/customer/customer site/supplier/supplier site level.
13. On-hand quantity can be posted as allocated on-hand or unallocated on-hand. If both order types are posted, the engine considers the total on-hand quantity of these two order types.
14. The VMI Replenishment Engine considers all sales orders and ASNs with receipt dates between the infinite past and the time fence end data.
15. The replenishment quantity is calculated either in units of supply or days of supply, depending on the user setup.
16. The replenishment is calculated by either fixed order quantity method or min-max method, depending on the user setup.
17. Replenishment order is released as sales order with or without authorization by item planner, depending on the user setup.

### VMI Replenishment Engine suggests replenishment quantity

If replenishment is required, the VMI engine will suggest a replenishment quantity based on the reorder quantity selection:

- When the reorder point is selected as minimum quantity/maximum quantity:  
Suggested replenishment quantity = [maximum quantity - (on-hand quantity + sales order quantity + ASN)]
- When the reorder point is selected as minimum quantity/fixed order quantity:  
Suggested replenishment quantity = fixed order quantity
- When the reorder point is selected as minimum days for supply / maximum days for supply:  
Suggested replenishment quantity = [maximum days for supply - (on-hand quantity + sales order quantity + ASN)]
- When the reorder point is selected as minimum days for supply/fixed order quantity:  
Suggested replenishment quantity = fixed order quantity

Before you run the next collection the suggested replenishment quantity will be displayed as the in-process quantity. Your customers can monitor inventory levels using the inventory status screen.

Complete the following steps to access the Inventory Status window in Oracle Collaborative Planning:

1. From the Oracle Collaborative Planning home page , select the Planning tab.
2. Under the Planning tab, select VMI. The Vendor Managed Inventory Status window opens.

The following image depicts the Vendor Managed Inventory Status window:



**The Vendor Managed Inventory Status Window**

**ORACLE Collaborative Planning**  
Home Logout Help Preferences Personalize Page Diagnostics

Home Exceptions Planning Admin  
Horizontal View Vertical View VMI Forecast Comparison Create Order Planner Work

**Vendor Managed Inventory Status**

**Search**

Item  Customer   
Customer Item  Supplier   
Supplier Item  View Quantity in

Go

View  Go Personalize

Select Item(s):

Select All | Select None

Select	Item	Customer	Customer Site	Supplier	Supplier Site	VMI Status	Replenish Date
<input type="checkbox"/>	AS54888	Discount SuperStore	5426	Vision Corporation		Onhand:0 Onorder:0  Min:10 Max:30	
<input type="checkbox"/>	AS66313	Discount SuperStore	5426	Vision Corporation		Onhand:5 Onorder:0  Min:10 Max:30	
<input type="checkbox"/>	AS72111	Discount SuperStore	5426	Vision Corporation		Onhand:5 Onorder:0  Min:10 Max:30	
<input type="checkbox"/>	CM66229	Vision Corporation	TST:M1	Prouty Industrial Supply	RED WING	Onhand:0 Onorder:0  Min:0 Max:1000	

Select Item(s):

Home Exceptions Planning Admin Home Logout Help Preferences Personalize Page Diagnostics  
About this Page Privacy Statement Copyright (c) 2006, Oracle. All rights reserved

In the Vendor Managed Inventory Status window you can view the replenishment information. The following table describes pertinent columns you can view in the Vendor Managed Inventory Status window:

- A row can represent either the supplier-facing VMI or

customer-facing VMI type, as the system does not order the output rows based on the type of VMI. Therefore you must verify the customer and supplier before releasing a quantity.

- Each row in the VMI screen is uniquely identified by item name, customer, customer site and supplier.
- The columns that are not applicable for a certain VMI type remain empty for that VMI type. For example, the Requisition Quantity column for VMI with customers remains empty when the VMI engine runs for suppliers. Similarly, the Sales order Quantity column for VMI with suppliers remains empty when the VMI engine runs for customers.
- For VMI with customers, the system assumes the supplier to be the OEM organization. To link an item to a customer, you should enable it in an organization while setting up the item in the source. This organization is considered to be the modeled organization mapped to a customer site. Since the item is owned by this organization, and it corresponds to a customer site, there is no supplier site for this item.
- The VMI screen shows the "Source Organization" of the item as the supplier site for all rows when the VMI type is selected as customer facing VMI. This organization is defined in the item master form when the item is set up in the source.
- The Release button enables you to release a replenishment order from the VMI screen.

Column Name	Description
Supplier Site	Displays the name of the default shipping organization (Source Organization) for an item.
Replenishment Date	Date when replenishment is necessary. This value is calculated by adding item processing lead-time to the VMI Engine run date. The VMI Engine calculates this date based on the order's due date, depending upon the trading partner responsible for the delivery of materials. The arrival date on the sales order issued by the OEM organization represents the replenishment date.

Column Name	Description
Suggested Replenishment Quantity	Quantity Oracle Collaborative Planning recommends for replenishment. Note that, the quantity displayed in the Replenishment Quantity field is editable.
Replenishment Quantity	Quantity you wish to release. This number must be less than or equal to the suggested replenishment quantity,
In-process quantity	Quantity released for replenishment. This number is set to zero after each replenishment engine run.
Onhand Quantity	This is the sum of allocated and unallocated on-hand inventory quantity posted by the customer/customer site for the displayed item.
View Projected Available Balance	<p>Displays an icon to display the VMI stock-out graph. The graph displays the</p> <ul style="list-style-type: none"> <li>• Minimum and maximum inventory level for the item either in days or in units, based on the item set up</li> <li>• Safety Stock</li> <li>• Projected Available Balance</li> </ul> <p>The forecast horizon specified during the item setup decides the time interval for the stock-out graph.</p>
ASN Quantity (Days)	Displays the ASN quantity divided by the average daily demand.
ASN Quantity	Displays the sum of all open trip stops collected from Order Management.
View Forecast	Displays the View Forecast icon that takes you to the Collaborative Planning Horizontal View and displays the forecast that was used to calculate the average daily demand for this item i.e. Order forecast, Sales forecast or Historical sales.

**Note:** The Create ASN, View Forecast, and Create Order icons are displayed when you select APS&CP for the profile option MSC: Configuration. For more information about this profile option, see

### Send replenishment notifications

Whenever an item shortage or item excess condition is detected, the system sends notifications as follows:

- **Supplier:** The item planner receives an FYI notification for an automatically created release. The planner can approve the creation of the release by reviewing the details of the notification if required.
- **Customer Site contact:** The site contact for the customer's site receives FYI notifications only.

The system generates the following three types of replenishment notifications:

- **Release Authorization Required is set as Supplier:** The notification is addressed to the Item Planner. The notification requests for an approval for generating the replenishment order for the VMI item followed by the replenishment details.
- **Release Authorization Required is set as None:** The notification is addressed to the Item Planner. The notification states that the replenishment order for the specified VMI item has been created followed by the replenishment details.
- **Release Authorization Required is set as Customer:** The notification is addressed to the customer contact. The notification requests for a purchase order for the VMI item followed by the replenishment details.

For more information about the Release Authorization Require flag, see "Step 5: Set up replenishment controls".

If the order date is different than the request date, the system addresses the notification to the Item Planner. The notification states that the scheduled arrival date calculated by ATP for the specified order is different from the requested arrival date. The planner may approve or reject the scheduled arrival date as calculated by ATP.

If the sales order creation process fails, the system addresses the notification to the Item Planner. The notification states that the release process for the replenishment order for VMI item has failed.

**Important:** The following is the process for unconsigned VMI with customers only

### Create sales orders release

If the Release Authorization flag is set to No, the system creates the release against the blanket sales order. The replenishment quantity suggested by the system is used to create a sales order line against the blanket sales order. The following attributes are

passed to the order import program:

- Item
- Customer
- Customer site
- Suggested replenishment quantity
- Scheduled arrival date
- Ship from organization

#### **Send purchase order release notification**

If the release authorization flag is set to Yes, the system does not create sales orders. The item planner receives a notification to approve the suggested replenishment quantity. In this case you must initiate the creation of the sales order in Order Management manually.

#### **Ship materials to customer**

Once you have made the shipment, you should post the ASN to the system. When the order is shipped through Oracle Shipping, the open quantities in the sales order decrease by equivalent amounts. The next collections process reflects the appropriate open quantity on the sales order in Collaborative Planning. The shipped quantity is reflected as an ASN quantity.

The ASN is pegged to the purchase order if the purchase order is available in Collaborative Planning and the purchase order quantity is consumed by the ASN quantity.

#### **Customer receives the shipment**

Once the customer receives the shipment, a record of the receipt is created automatically in his system. In case an ASN exists, it will expire automatically if the auto-expire flag is set to Yes. If the auto-expire flag is set to No, the system considers the ASN to be in-transit until the customer posts a receipt transaction.

#### **Customer Updates On-hand**

After the material reaches the customer's inventory, the allocated or unallocated on-hand quantity is published to Collaborative Planning and the on-hand quantity is updated at the customer site.

Note that the receipt and on-hand transactions should be posted together if the auto-expire flag for ASN is set to No.

## Process for Consigned VMI with Customers

### Run VMI Engine

Submit a concurrent request to the VMI Replenishment Engine. The VMI Replenishment Engine generates the replenishment orders if the added value of the on-hand quantity, open orders, and goods in transit is less than the minimum replenishment quantity or the minimum replenishment days.

The VMI Engine automatically creates the sales orders based on the supplies (on-hand + open requisitions + open internal sales orders + goods in transit) falling within the horizon of system date and the pick to ship lead time for the item. While creating the sales orders, the Collaborative Planning system considers the arrival date as the key date for the sales order. Note that the VMI Engine assumes that the Request Date Type attribute is set to Arrival Date in Order Management if the OEM organization is responsible for managing inventory at customer sites. After the sales orders are created, the normal pick release and ship confirm programs run to fulfill the order.

For consigned items, the VMI engine considers the following:

- **On-hand quantity:** As collected from the external organization
- **Internal requisitions:** As collected from Order Management
- **Internal Sales orders:** As created in Order Management

**Note:** While creating the internal sales orders, the Collaborative Planning system considers the arrival date as the key date for the internal sales order. Note that the VMI Engine assumes that the Request Date Type attribute is set to Arrival Date in Order Management if the OEM organization is responsible for managing inventory at customer sites.

- **In transit:** As collected from Oracle Shipping

Total supply to be made at the customer site is calculated as the sum of on hand quantity, internal requisitions, internal sales orders, and goods in transit. The system uses the internal requisition quantity if internal sales orders have not been created for a given Internal requisition. The system uses the sum of internal sales orders quantity and the quantity of goods in transit if Internal sales orders are already created for a given Internal requisition.

### Create replenishment orders

When the planning engine detects the necessity of material replenishment in the customer site, it automatically creates an internal requisition in Oracle Purchasing by calling the Requisition Import program. After an internal requisition is created in Oracle Purchasing, you should create internal sales orders with the Create Orders concurrent

program.

Note that the internal requisition considers the external inventory organization associated to the customer's organization as the receiving organization. The default shipping organization is treated as the shipping organization. On the other hand the internal sales order considers the external inventory organization associated to the customer's organization as the receiving organization, while the source organization on the internal requisition is treated as the shipping organization.

After an internal requisition is created in Purchasing, the Create Orders program creates internal sales orders

#### **Ship material to customer site**

At this stage of the workflow, you ship the material to the customer site using the internal sales order.

#### **Customer receives material**

Create a receipt to receive the material in the external organization. This increases the on-hand quantity in the external organization.

#### **Customer posts consumption advice**

After receiving the ordered material, the customer posts an activity report to Collaborative Planning using the order type consumption advice. The customer can upload flat files specifying sync indicators to identify whether the customer is deleting or inserting records.

**Important:** Note that any create or update request for the sales order in the source instance will fail if the consumption advice date is earlier than the blanket sales order date.

#### **If the Load process for the consumption advice fails**

If the release process for the consumption advice fails, the system displays the following information pertaining to the consumption advice in the error notification:

- Customer
- Customer Site
- Supplier
- Item
- Actual Date
- Quantity

- Order Number
- Line number
- Release number
- End order number (i.e. Customer PO number)
- End order line number (i.e. Customer PO line number)
- End order release number (i.e. Customer release number)

**Note:** The End order number, End order line number, and End order release number are displayed only if the customer provides the information while loading the consumption advice.

### Customer releases the consumption advice

The user rectifies the erroneous setup information and releases the consumption advice.

Note that if the value for the profile option MSC: Order Number-CA Mandatory for CVMI is set to Yes, the user must enter the order number for the consumption advice. Moreover, the system considers the Order Number, Line Number, Release Number, End Order Number, End Line Number, End Release Number as parts of the deletion key. If the customer does not specify any of these values while entering consumption advice record, then all the records for that Publisher, Publisher Site, Item combination will be deleted.

If the value for the profile option MSC: Order Number-CA Mandatory for CVMI is set to No, the key date for sales orders and ASN is considered as part of deletion key. For more information about profile options, see Appendix A: Profile Options, page A-1.

The system behavior varies in the following way based on the Sync Indicator value and while handling a record for consumption advice:

- While the value of the Sync Indicator is R and the value for the Order Number, Line Number, Release Number, End Order Number, End Order Line Number, or End Order Release Number is same as the old value, the system updates the old consumption advice record.
- While the value of the Sync Indicator is D and the value for the Order Number, Line Number, Release Number, End Order Number, End Order Line Number, or End Order Release Number is same as the old value, the system deletes the old consumption advice record and creates a new record for the new consumption advice.

If the user provides a new value for the Order Number, Line Number, Release Number, End Order Number, End Order Line Number, or End Order Release Number, a new



consumption advice record will be inserted and the old record is not updated.

**System creates sales orders**

If the Load program is successful, the system uses the activity report to create a sales order release against a Blanket Agreement in Order Management. The transaction type for the blanket sales order set up for consigned VMI must be Bill only (consume). The system updates the Order Number, End order number, and End order line number in the sales order. This ensures that material is not shipped but the customer is invoiced and that material is decremented from the external organization. Note that, at this stage the sales order release is only booked and does not require an ATP call.



---

# Collaborative Inventory Visibility

This chapter covers the following topics:

- Overview
- Setup
- Create Groups
- Define Group Members
- Define Security Rules
- Upload Unallocated On-hand Inventory
- Search for Inventory

## Overview

Collaborative Inventory Visibility enables you to share inventory levels at key locations with your strategic trading partners.

With Collaborative Inventory Visibility, you can:

- Create trading partner groups with whom you share inventory levels
- Create security rules that enable member companies to view your inventory levels
- Maintain a supply of unallocated inventory at strategic locations

## Setup

The following steps outline the setup for Collaborative Inventory Visibility:

- Create groups
- Define member companies of groups

- Create security rules
- Upload unallocated on-hand inventory
- Enable customer search for inventory
- Configure descriptive flexfields (this step is optional)

The step to configure the descriptive flexfields is required only when you want to support non-standard columns in an upload file. For more information about descriptive flexfields, refer to the *Oracle Applications AOL Manual*.

## Create Groups

Use *group.dat* to define you group. To create a group, complete the following steps:

1. Navigate to the Load Setup Data window.
2. Select Download templates.
3. Open *group.dat*.
4. Enter the group name.
5. Enter the group type Private (use the type Public only when other companies use the group).
6. Enter the source instance code (your specific instance code).
7. Save the file.
8. Return to the Load Setup Data window and upload *group.dat*.

## Define Group Members

Use *groupcompany.dat* to define group members. To define group members, complete the following steps:

1. Open *groupcompany.dat* from the previously downloaded templates.
2. Enter the group name.
3. Enter the company names.
4. Enter the source instance code (your specific instance code).
5. Save the file.

6. Navigate to the Load Setup Data window and upload groupcompany.dat.

## Define Security Rules

Define security rules that enable group members to view your unallocated on-hand inventory. The following fields are required:

- Access Given By
- Privilege
- Access Given To

Complete the following steps to define security rules:

1. Navigate to Create New Rule window.
2. Enter your company name in the Access Given By field.
3. Enter the order type. For example, if you want group members to view your unallocated on-hand inventory, enter Unallocated On-hand.

Note that you should set up exclusive security rules to share projected available balance and safety stock order types to significant suppliers and customers. In Collaborative Planning safety stock and projected available balance order types are not associated with any customer or supplier company. Therefore, by default these records are not visible to users of any trading partner company.

4. Enter the item number (this step is optional, if you do not enter item number, all items will be considered for the security rule).
5. Select one of the following privileges for your group members:
  - View
  - Update
6. Select one of the following for Access Given To:
  - Company
  - User
  - Responsibility
  - Group
  - Global

7. Enter the Assigned To field.
8. Select effective dates.
9. Select Submit.

You also must define specific security rules to display a graphical comparison of safety stock and PAB on the Horizontal View screen. The comparison is based on the order types Safety Stock and Projected Available Balance. You can drill down to Vertical View to see details of each record. You must also select any of the following display order types for the data to be graphed:

- **Order type: Safety Stock:** Deletes records selectively in Collaborative Planning between the horizon dates and replaces them with the records from the selected plan.
- **Order type: Projected Available Balance:** The Horizontal Views in Collaborative Planning and ASCP display the same values for projected available balance.

Note that the safety stock and projected available balance information that are displayed in the Horizontal View are editable for both the order types.

## Upload Unallocated On-hand Inventory

Complete the following steps to upload unallocated on-hand inventory. You can skip steps 1 and 2 if you have already downloaded the templates.

1. Navigate to the Load Supply/Demand window.
2. Select Download templates.
3. Open supplydemand.dat.
4. Enter the Synch Indicator.
5. Enter the Item Name.
6. Enter the Order Type.

**Note:** For the Unallocated On-hand order type, do not enter customer or supplier name.

7. Enter the Quantity.
8. Enter the UOM.
9. Enter the Publisher Company.

10. Enter the Publisher site.
11. Save your work.
12. Return to the Load Supply/Demand window and upload your file.

## Search for Inventory

Your customers can now search for your inventory using Vertical View. Complete the following steps to search for and find inventory:

1. Navigate to the Vertical View window.
2. Enter information in at least one of the following fields:
3. Item
4. Order Type
5. Select search.
6. Choose an item from the results.

Note that you can search inventories based on the trading party who is responsible to handle them, or based on the item categories to which the inventories belong. Complete the following steps to search information based on a buyer code or item category:

1. On the Vertical View screen, select Advanced Search.  
The Advanced Search window for Vertical View opens.

**The Advanced Search Window for Vertical View**

2. To filter records based on buyer code, in the Add Another list, select Buyer as the new search field and select Add.  
To filter records based on item category, in the Add Another drop-down list, select Category as the new search field, and select Add.
3. The Buyer Code field, the Category field, or both are appended.
4. Select the search criteria. For more information about advanced search, see "Horizontal and Advanced Horizontal View: Advanced Search, page 9-3."
5. In the Advanced Search window, select Search. The Collaborative Planning engine filters and displays the transactions for the buyer, the item category, or both on the Vertical View screen.

The Vertical View screen now displays new columns for the buyer code, the item category, or both that are used as filtering criteria. Note that the Buyer column or the Category column displaying the selected buyer code and item category are added only after the user performs a filtration using the advanced search or preference sets based



on the buyer code, the item category or both.

**Note:** You must associate a buyer with an item in Oracle Inventory to search transactions based on buyer code. For more information about setting up this search field, see "Setup: Setting Up Buyer Code and Item Category for Advanced Search, page 2-23."



---

# Exceptions

This chapter covers the following topics:

- Overview
- Supply Chain Event Management Engine
- View Exceptions
- Seeded Exceptions
- Custom Exceptions
- Exception Thresholds
- Pegging

## Overview

Exceptions are notifications that identify issues that need resolution. Oracle Collaborative Planning generates an exception whenever an actual process does not match the required process. For example, if you and your supplier's forecasts do not match, Oracle Collaborative Planning generates a forecast mismatch exception. Exceptions ensure that the decision-making process remains focused, occurs in a timely manner, and makes the supply chain more responsive.

Oracle Collaborative Planning exceptions are grouped into several categories that correspond to supply chain problems. The categories are:

- Late orders
- Early orders
- Potential late orders
- Material shortage
- Material excess

- Forecast mismatch
- Response required
- Change orders
- Forecast accuracy
- Performance below target

Exception notifications for an item are sent to the supply chain collaboration planner for the item. If no planner is specified for an item, notification is sent to an Administrator. Any planner can view an exception through the Exceptions tab. You can also view counts for a given exception type.

## Supply Chain Event Management Engine

The Supply Chain Event Management engine computes exceptions on a net change basis. Exceptions are computed only for every transaction that has received additional information since the last Supply Chain Event Management Engine run.

The Supply Chain Event Management Engine is a background process which usually runs at a specified frequency. Your Advanced Planning administrator can change this frequency.

## View Exceptions

Complete the following steps to view exceptions in Oracle Collaborative Planning:

1. From the Oracle Collaborative Planning application, select the Exceptions tab.
2. On the Exceptions Summary page, select the exception type you want to view and then select Show Details.
3. You will see the details of the selected exceptions. You can perform a search on this page.

## Seeded Exceptions

Collaborative Planning raises the exceptions related to shipping of materials from the supplier's site to the customer's site based on the key date on the purchase order issued by you or any of your trading partners. The key date is decided based on whether supplier or the customer is responsible for transporting the materials.

- If the supplier is responsible for transportation: Collaborative Planning considers the arrival (receipt date) date as a key date.

- If the customer is responsible for transportation: Collaborative Planning considers the ship date as a key date.

The following are the seeded exception categories for Collaborative Planning:

## Late Orders

Late order exceptions occur when either you or your supplier are late in meeting a required date for an order. For example, if the Need By Date of a purchase order is 07/12/2003 and the system date is 07/22/2003, a late order exception is generated. The following late order exceptions are generated in Oracle Collaborative Planning:

- Late Replenishment to Customer
  - You see this exception as the supplier of an item.
  - This exception is triggered when the receipt date on your sales order is later than the receipt date on the customer's purchase order and the threshold.
- Late Replenishment from Supplier
  - You see this exception as the customer of an item.
  - This exception is triggered when the receipt date on the supplier's sales order is later than the receipt date on your purchase order and the threshold.
  - By selecting this exception, you can navigate to the details of the purchase order that caused the exception (and related sales orders from the suppliers).
- Replenishment to Customer is Past Due
  - You see this exception as the supplier of an item.
  - This exception is triggered when the system date is later than the receipt date on the customer's purchase order adjusted by the threshold.
- Replenishment From Supplier is Past Due
  - You see this exception as the customer of an item.
  - This exception is triggered when the system date is later than the receipt date on your purchase order and threshold.
  - By selecting this exception, you can navigate to the details of the purchase orders that caused the exception.

The details you can view of the purchase orders or sales orders that caused the exception include number of days the order is late by, exception types, order types,

order numbers, release numbers, line numbers, items, quantities, order schedule dates (receipt date for the sales order, receipt date for the purchase order), order creation dates, and threshold days.

## Material Shortage

Material shortage exceptions are discrepancies between your initial demand or supply and the corresponding supply or demand from your trading partner.

Collaborative Planning exception engine enables you to generate Material Shortage exceptions by combining data for a base model and its configured items. The system tracks sales orders, order forecasts, and supply commits for configured items at base model level for exception generation. When the user drills down from the Vertical View through a sales order, the system checks if the item used in the sales order is a standard item or a configured item. If it is a configured item, the system compares aggregate order forecasts, supply commits and sales orders at a base model level and generates an exception if needed.

The following Material Shortage exceptions are generated in Oracle Collaborative Planning:

- Supply Commit is Less Than Customer Order Forecast
  - You see this exception as the supplier of an item.
  - This exception is generated when the order forecast of a customer is more than your supply commit, adjusted to the threshold. The threshold is defined as percentage of order forecast.
- Supplier's Supply Commit is Less Than Order Forecast
  - You see this exception as the customer of an item.
  - This exception is generated when supplier's supply commit is less than your order forecast, adjusted to threshold. Threshold for this exception is defined as percentage of order forecast.
- Short Supply for Customer Purchase Order
  - You see this exception as the supplier of an item.
  - This exception is triggered when the quantity on your sales order is less than the quantity on the customer's purchase order.
  - By selecting this exception, you can navigate to the details of the sales orders that caused the exception (and related purchase orders).
- Short Supply from Supplier for Purchase Order

- You see this exception as the customer of an item.
  - This exception is triggered when the quantity on the supplier's sales order is less than the quantity on your purchase order.
  - By selecting this exception, you can navigate to the details of the purchase orders that caused the exception (and related sales orders).
- VMI Item Shortage at Customer Site, Replenishment Required
    - You can see this exception as the supplier of a VMI item.
    - This exception is generated only for items which are enabled for VMI in the Approved Supplier List (ASL).
    - This exception is generated when the total quantity of on-hand, requisitions, purchase orders, ASN (in-transit), and receipts for the item is less than the minimum quantity set for it.
- VMI Item Shortage at Your Site
    - You can see this exception as the customer of a VMI item.
    - This exception is generated for items those are marked as VMI in the ASL.
    - This exception is generated when the total quantity of On hand, Requisitions, Purchase orders, ASN, Receipts is below the minimum quantity set for the item.

From all these exceptions, you can navigate to the underlying transaction records, and review details.

## Material Excess

Material excess exceptions occur when a quantity demanded is less than a supply provided.

Collaborative Planning exception engine enables you to generate Material Excess exceptions by combining data for a base model and its configured items. The system tracks sales orders, order forecasts, and supply commits for configured items at base model level for exception generation. When the user drills down from the Vertical View through a sales order, the system checks if the item used in the sales order is a standard item or a configured item. If it is a configured item, the system compares aggregate order forecasts, supply commits and sales orders at a base model level and generates an exception if needed.

The following Material Excess exceptions are generated in Oracle Collaborative Planning:

- Supply Commit Exceeds Customer Order Forecast
  - You see this exception as the supplier of an item
  - This exception is generated when supply commit is more than the order forecast, adjusted to the threshold. Threshold in this exception is defined as percentage of order forecast.
- Supplier Supply Commit Exceeds Order Forecast
  - You see this exception as the customer of an item.
  - This exception is generated when supply commit is more than the order forecast, adjusted to the threshold. The threshold in this exception is defined as percentage of order forecast.
- Excess Replenishment for Customer Purchase Order
  - You see this exception as the supplier of an item.
  - This exception is triggered when the item quantity on your sales order is greater than the item quantity on the customer's purchase order, adjusted to threshold.
- Excess replenishment from supplier for purchase order
  - You see this exception as the customer of an item.
  - This exception is triggered when the quantity on the supplier's sales order is more than the quantity on your purchase order, adjusted to threshold.
- VMI Item Excess at the Customer Site
  - You see this exception as the supplier of an item.
  - This exception is generated when supplies for an item, the total of on-hand, requisitions, purchase orders, ASNs, and receipts is greater than the maximum limit set for this item.
- VMI Item Excess at Your Site
  - You see this exception as the customer of an item.
  - This exception is generated when supplies for an item, the total of on-hand, requisitions, purchase orders, ASNs, and receipts, is greater than the maximum limit set for this item.
  - To take resolution action for this exception, you can navigate to the VMI details



screen from exceptions screen.

## **Response Required: Response to Trading Partner Required**

Response to Trading Partner Required exceptions occur when responses to transactions by your trading partners are not posted within an acceptable time limit. Oracle Collaborative Planning generates these exceptions when the appropriate threshold is crossed. In this category, the following exceptions are generated in Oracle Collaborative Planning:

- Response Required for Customer Purchase Order
  - You see this exception as the supplier of an item.
  - This exception is triggered when a sales order does not exist for a purchase order posted by the customer within the threshold number of days.
- Response Required for Supplier Sales Order
  - You see this exception as the customer of an item. The customer receives the sales order from a supplier.
  - This exception is triggered when a purchase order does not exist for a sales order posted by the supplier within a threshold number of days.

## **Response Required: Trading Partner Response Required**

Response to Trading Partner Required exceptions occur when your trading partners do not post responses to your transactions within acceptable time limit. In this category, the following exceptions are generated:

- Supplier Response Required for Purchase Order
  - You see this exception as the customer of an item
  - This exception is triggered when a sales order does not exist for a purchase order posted by you.
- Customer Purchase Order Does Not Exist for Your Sales Order
  - You see this exception as the supplier of an item.
  - This exception is triggered when a purchase order does not exist for a sales order for your supplier.

From the Exceptions Details window you can navigate to view the details of the purchase orders or sales orders that caused the exception.

## Potential Late Orders

Potential Late Order exceptions demonstrate the ability of Oracle Collaborative Planning to process information across multiple supply chain tiers. The evaluation requires Oracle Collaborative Planning to check every possible order against all sales orders, purchase orders, and multiple orders. The following potential late order exceptions are generated in Oracle Collaborative Planning:

- Potential Late Order Due to Upstream Lateness
  - You can view this exception as any trading partner (customer or supplier) of an item.
  - This exception is triggered when a sales order from supplier is late compared to the purchase order anywhere in the pegging tree. For example, PO1 is pegged to SO1, SO1 is pegged to PO2, and PO2 is pegged to SO2. If SO2 is going to be late when compared to PO2, a potential late order is raised for PO1.
  - From this exception, you can navigate to the underlying transactions and its pegging tree to review details and take actions for resolution.
- Purchase Order Compresses Lead Time
  - You can view this exception as the customer of an item.
  - This exception is triggered when the time duration between the receipt date on your purchase order and the creation date of the purchase order is less than the item lead time specified by the supplier.
  - By selecting this link, you can view the details of the purchase orders that caused the exception.
- Customer Purchase Order Compresses Lead Time
  - You see this exception as the supplier of an item.
  - This exception is triggered when the time duration between the receipt date on the customer's purchase order and the creation date of the purchase order is less than the item lead time specified by you.
- Sales Order Requires Lead Time Compression
  - You can view this exception as the supplier of an item.
  - This exception is triggered when the time duration between the ship date on your sales order and the creation date of the sales order is less than the item lead time specified by you.

## Forecast Mismatch

A forecast mismatch exception is a discrepancy between you and your trading partner's forecast. Forecast mismatch exceptions pertain mostly to the horizontal or bucketed view.

Note that the planning engine uses a site-specific calendar to compute exceptions for mismatches in supplies and demands. The start and end dates for the time buckets are determined from the time horizon specified by the planner. Primarily, the planning engine applies the receiving calendar of the customer's site to compute exceptions and buckets supply/demand data and compares them for generating exceptions. In the absence of this calendar, the system applies other site-specific calendars. For more information about determining the site-specific calendar used for comparing forecasts, see "Horizontal View Displays Orders Based on Site-Specific Calendar."

You can plan your operations with varying time buckets and post your data accordingly to the Collaborative Planning system. The system generates exceptions in accordance with the data while referencing a site-specific calendar. The following example describes a situation in which the user enters supply and demand data with multiple bucket types (day, week, month) across a range of time.

The following records are posted to the system:

---

<b>Date</b>	<b>Order type</b>	<b>Quantity</b>	<b>Bucket</b>
3/31/2003	Supply commit	50	Week
4/9/2003	Supply commit	10	Day
4/15/2003	Order forecast	100	Month
4/21/2003	Supply commit	50	Week
4/24/2003	Order forecast	25	Day
5/5/2003	Order forecast	20	Day
5/5/2003	Supply commit	50	Week
5/9/2003	Order forecast	20	Day

---

1. The system first sorts the records and orders them by date against the receiving calendar of the customer's site that receives the material.
2. To find mismatches in supply and demand, the system compares the time buckets

used in the order forecasts published to the suppliers (demand data) with the time buckets used in the supply commits received from the suppliers (supply data).

3. The system then adopts the higher of the two buckets and rolls up the data in the supply/demand statement with the lower time bucket.
4. The Collaborative Planning exception engine then compares the data for both the statements and reports the mismatches.

The following image illustrates this scenario:

**Data Bucketing for Comparison and Exception Computation**

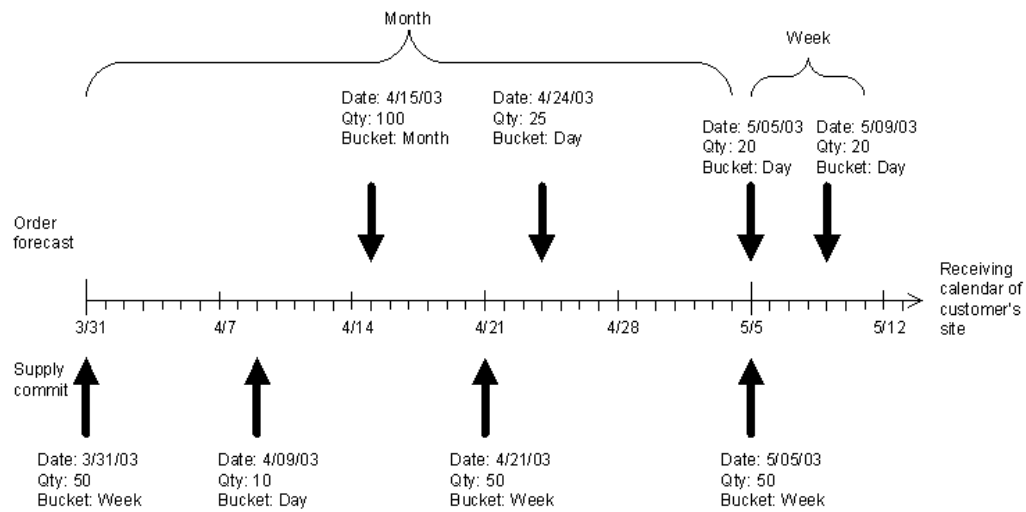

The system generates the following exceptions:

**Supplier Supply Commit is Less Than Order Forecast**

**Exception Details**

Start date	3/31/2003
End date	5/4/2003
Total demand	125

---

**Exception Details**

---

Total supply	110
--------------	-----

---

**Supplier Supply Commit Exceeds Order Forecast**

---

**Exception details**

---

Start date	5/5/2003
End date	5/11/2003
Total demand	40
Total supply	50

---

The following forecast mismatch exceptions are generated in Oracle Collaborative Planning:

- Customer Sales Forecast Exceeds Your Sales Forecast
  - You see this exception as the supplier of an item.
  - This exception is triggered when sales forecast provided by your customer exceeds the sales forecast posted by you, adjusted with threshold, for an item in a bucket.
- Customer Sales Forecast is Less than Your Sales Forecast
  - You see this exception as the supplier of an item.
  - This exception is generated when sales forecast provided by your customer is less than the sales forecast posted by you, adjusted by threshold, for an item in a bucket.
- Supplier Sales Forecast Exceeds Your Sales Forecast
  - You see this exception as the customer for an item.
  - This exception is generated when sales forecast posted by your supplier exceeds the sales forecast posted by you adjusted with threshold for an item in a bucket.

- Supplier Sales Forecast is Less Than Your Sales Forecast
  - You see this exception as the supplier for an item.
  - This exception is generated when sales forecast provided by the supplier is less than the sales forecast provided by you adjusted with threshold, for an item in a bucket.

## Early Orders

Early orders exceptions occur when either your supplier or customer are scheduled to receive a shipment before the intended need-by date. You receive the following early orders exceptions:

- Early Replenishment to Customer
  - You see this exception as the supplier of an item.
  - This exception is triggered when the receipt date on the sales order is earlier than the receipt date on the customer's purchase order, adjusted by the threshold.
- Early Replenishment from Supplier
  - You see this exception as the customer of an item.
  - This exception is triggered when the receipt date on the supplier's sales order is earlier than the receipt date on your purchase order and the threshold set for the exception.

## Change Orders

Change order exceptions let you know that there is a change to your purchase order. You receive the following change order exceptions:

- Customer Purchase Order has been Cancelled
  - You can see this exception as the supplier of an item.
  - This exception is triggered when purchase order placed by the customer to you is cancelled.
- Your Customer's Purchase Order to You is Rescheduled
  - You can see this exception as supplier of an item.
  - This exception is triggered when the receipt date of a purchase order placed to

you is changed.

## Forecast Accuracy

Forecast accuracy exceptions enable you to see whether your forecast is greater than previous or current sales. You receive the following forecast accuracy exceptions in Oracle Collaborative Planning:

- Customer Sales Forecast Exceeds Actual Sales
  - You can see this exception as the supplier of an item.
  - This exception is triggered when the sum of your historical sales forecast provided by customer, increased by the threshold percentage, exceeds actual sales (historical sales) for last three months.
- Sales Forecast Exceeds Actual Sales
  - You can see this exception as the customer of an item.
  - This exception is triggered when your sales forecast, increased by the threshold percentage, exceeds actual sales (historical sales) provided by the supplier for last three months
- Customer Order Forecast Exceeds Actual Orders
  - You can see this exception as the supplier of an item.
  - This exception is triggered when the order forecast provided by customer, increased by the threshold percentage, exceeds total of purchase orders for last three months
- Order Forecast Exceeds Actual Orders
  - You can see this exception as the customer of an item.
  - This exception is triggered when your order forecast, increased by the threshold percentage, exceeds total of purchase orders placed for the item to the supplier for last three months

## Performance Measure Below Target

Performance Measure Below Target exceptions measure performance. Performance is a calculation such as forecast error (forecast minus actual sales divided by the forecast), inventory turns, number of stock-outs, or fill rates. The period over which performance is measured is three months. For example, number of stock-outs is counted over the last

three months. The resultant number is compared to threshold value, and then a notification is sent to a planner. The following Performance Measure Below Target exceptions are available in Oracle Collaborative Planning:

- Customer Forecast Error Exceeds the Threshold
  - You can see this exception as the supplier of an item.
  - This exception is generated when the mean average percentage of error (MAPE) for the forecast in a given period exceeds the acceptable limit set by the threshold. By default, MAPE is calculated over a period of three months. A deviation of actual sales from forecast is considered as an error in the forecast.
- Forecast Error Exceeds the Threshold
  - You can see this exception as the customer of an item.
  - The condition for this exception is same as the Customer Forecast Error Exceeds the Threshold exception; the only difference is that it is visible to the customer of an item.
- You Have Exceeded a Stock Out Threshold
  - You can see this exception as the supplier of an item.
  - A zero on hand quantity is considered as stock out. So when the number of stock outs over last three months exceeds the acceptable limit (set by threshold), this exception is triggered.
- Supplier On-Time Performance is Below Threshold
  - You can see this exception as the customer of an item.
  - If the actual receiving date of a purchase order is on or before the need by date, then the order is considered as on-time. Otherwise it is not on-time. If number of such violations from a supplier for an item exceeds a pre-set acceptable limit (set by threshold), this exception is triggered.
- On-time Delivery Performance is Below Threshold
  - You can see this exception as the supplier of an item.
  - Condition for this exception is the same as condition for Supplier On-Time Performance is Below Threshold exception. The only difference is that this exception is visible to the supplier.
- Inventory Turns for VMI Item Below Threshold



- You can see this exception as the customer of an item.
- Inventory turn is calculated by dividing the actual sales of an item with the average on-hand inventory. Inventory turn is calculated for a period of three months, and if it is less than the acceptable inventory turn limit set by the threshold, then this exception is generated.
- Customer Inventory Turns for VMI Item Below Threshold
  - You can see this exception as the supplier of an item.
  - Condition for this exception is same as the Inventory Turns for VMI Item Below Threshold exception, except that it is visible to the supplier of an item.

## Custom Exceptions

To prevent disruptions in the supply chain you must monitor and identify problems, determine the severity of issues to recognize when action is required, determine the appropriate corrective action, and measure performance to ensure appropriate actions are being taken. Custom exceptions enable you to define conditions that identify potential problems in the supply chain, receive notifications as problems are identified, and control the sensitivity of conditions by associating exception thresholds.

Oracle Collaborative Planning enables you to create business-specific custom exceptions. You can only edit the exceptions you created. When an exception condition is met an exception is generated, and a notification alerts you to the problem.

For custom exception definition, data is represented by three different views such as Company view, Supplier view, and Customer view. Attributes from these views are identified by the corresponding prefixes.

You must complete the following steps to create a custom exception:

- Name the Exception, page 7-16
- Define Exception Scope, page 7-16
- Define Exception Condition, page 7-17
- Define Exception Output Attributes, page 7-17
- Define Schedule, page 7-18
- Specify Recipients, page 7-18
- Save, page 7-19

## Name the Exception

Choose a name by which you will recognize and understand your exception. In this window you also can enter a description of your exception.

## Define Exception Scope

You can limit the scope of a custom exception by entering filtering criteria. By limiting the scope, you are restricting the number of records to be evaluated for the exception condition. Setting proper scope helps improve performance of the exception generation process.

You can limit the scope of the exception by entering the following attributes and dates:

- Limit Supply/Demand Attributes
  - Company and/or Company Site
  - Supplier and/or Supplier Site
  - Customer and/or Customer Site
  - Item and/or Owner Item
  - Supplier Item and/or Customer Item
  - Order Number
  - Order Type Description
  - Release Number
- Limit Supply/Demand Dates
  - Date Type
  - Date Range
  - Rolling Time Period
  - Period to Date

While entering dates, you can use any of the date attributes present in the transaction by selecting suitable date type. You can define the range of dates as date range, rolling time period, or period to date which starts or ends on the current system date.

## Define Exception Condition

This is the heart of the exception definition. Depending on the complexity of the exception definition, you can use Simple or Advanced conditions to model the exception condition.

### Simple Condition

When defining an exception condition, verify that when the condition is true it results in an exception. Select whether to generate the exception when all the conditions are met, or when any of the conditions are met. Define the exception using the following criteria:

- Attribute
- Operator
- Value (from)
- Value (to)

While defining simple condition, you can also specify for this exception whether you want all the conditions required, or any of the conditions required. This is accomplished by selecting one of the following options:

- When all of the conditions are met
- When any of the conditions are met

**Important:** If there is no list of values available for a particular attribute used for the custom exception, the system shows a warning message. In such case, you should ignore this warning message and continue defining the condition.

### Advanced Condition

If the Simple Condition window does not meet your exception definition, use the Advanced Condition definition window. In this window you use SQL to define conditions. In advanced condition, you can define conditions using attributes from three views such as Company, Customer, and Supplier.

## Define Exception Output Attributes

Select the columns to display in your exception output by selecting attributes from the Available Attributes list. There are number of attributes available from all the three views. Carefully select the attributes required for your exception definition.

## Define Schedule

You can schedule your custom exception to run independently or along with standard exceptions. If you decide to run the custom exception independently, then indicate when the system should start and how often it will evaluate the exception condition. Enter the following information:

- Start Date
- Recurrence

If you decide to run it along with standard exceptions, it will be evaluated along with other seeded exceptions (with the frequency of Supply Chain Event Management engine).

## Specify Recipients

In this step, you can perform the following major tasks:

- Configure notification heading
- Specify workflow
- Specify recipient for the notification

### Configure Notification Heading

In this step, you enter the text of the notification heading. You also can select from the output attributes by using tokens. For example, if one of your output attributes is Item Number, and you select this as token in notification header, the token will be substituted with the actual item number when the exception is generated.

### Specify Workflow

By default, custom exceptions are governed by MSC:User Defined Workflow, and the User Defined Exception Workflow process. This workflow and workflow process generates the notification for each custom exception, and sends to the right users. You can customize this workflow, and workflow process, or add a new workflow process under the parent workflow, or add a new workflow to model your resolution procedure. If you have multiple workflows or workflow processes you can select the most appropriate workflow for a particular exception in this screen. For more information about workflows and how they are used in Oracle Collaborative Planning, refer to Workflow, page 12-1.

### Specify Recipients

Recipients can be specified as user, responsibility, item planner, or an e-mail address. For example, if you select recipient type as user, then the list of values for recipient will contain list of users in your instance. If you select item planner, the actual planner for

the item will receive notification when the exception is generated.

You can enter whether to give access to the exception by enabling access to the Oracle Collaborative Planning exceptions window, by sending notification, or both by selecting appropriate check boxes.

## Save

In the final step of custom exception creation you can review all of the setup data for your exception before saving it. After reviewing your exception and correcting any errors, select Submit.

## Edit Custom Exception

Complete the following steps to edit a custom exception:

1. From Oracle Collaborative Planning Home page, select Admin tab
2. Select Define Custom Exceptions from under Planner Tasks.
3. Search for your exception and select Go.
4. Select the exception you want to edit.

## Copy Custom Exception

Complete the following steps to copy a custom exception:

1. From the Custom Definition Search window in Oracle Collaborative Planning, find the exception you want to copy and select Copy.
2. On the Copy Exception page, enter a new exception name and description.
3. Select Submit.
4. If the system copied the exception successfully, select OK.

## Exception Thresholds

An exception threshold is a control limit placed on an exception condition. The administrator user sets thresholds to adjust the sensitivity to a supply or demand problem. For example, a sales order is considered late when the ship date is later than the receipt date on the purchase order. The threshold describes the degree of lateness, so that if the ship date is more than five days past the receipt date the planner is notified of the problem. In this example, the threshold is set at five days or greater.

## Define Exception Thresholds

Complete the following steps to define an exception threshold:

1. From the Home page in Oracle Collaborative Planning select the Admin tab.
2. Select Define Exception Thresholds. You can also access Define Exception Thresholds link from the Oracle Collaborative Planning Home page.
3. On the Define Exception Thresholds page, select an exception you want to edit and select Edit. You can define thresholds for both predefined and custom exceptions.
4. On the Define Exception Threshold Values page, select Add Another Row.
5. Select a value for the Assigned To field.

**Note:** The values in the Assigned To field are in order from least restrictive to the most restrictive. For example, if you select All Item-All Orgs-All Customers, the system assigns the notification to all items for all organizations, for all customers. If you select Item-Org-Customer Site, the system only assigns the notification to a specific item, for a specific organization, for a specific customer site.

6. Select an Item, Organization, Customer, Customer Site, and then enter a Threshold Value.
7. Select Save.

**Note:** If you define multiple thresholds for one exception, where one threshold is a subset of another, Collaborative Planning generates the exception for the more granular threshold.

## Delete Exception Thresholds

Complete the following steps to delete an exception threshold:

1. From the Admin tab in Oracle Collaborative Planning, select Define Exception Thresholds.
2. Select the exception you want to delete and select Edit.
3. Choose the threshold you want to delete and select Delete.
4. On the Warning page, select Yes to delete the threshold or No to return to the

Define Exception Threshold Values window.

## Pegging

Supply and demand orders that are interrelated can be pegged or linked together. The Pegging window enables you to track orders from your customer's purchase order through your supplier's sales order to the supplier shipment and the shipment's receipt at the customer site. By using pegging, you connect supply and demand information through your orders.

### Enter Pegging Information

To link two orders in Oracle Collaborative Planning you must specify the parent or end-order's information. The following list identifies and describes which end order-related details should be specified on the new order:

- End order's order type: Specify purchase order, sales order, order forecast, etc. as appropriate.
- End order number: Enter the end order's order number.
- End order publisher and publisher's site: Enter the publisher of the end order and the publisher's site.
- Line number of the end order: Enter the line number on the end order if applicable.
- End order's release number (if applicable): If the end order has a release, specify it in this field.

**Note:** If the end order line number is not set, Oracle Collaborative Planning assumes that the item in the document is the same as the one being referenced in the end order document. The pegging tree shows all the lines associated with this item in the end order release number.

### Access Pegging Information

Complete the following steps to access the Pegging window:

1. From the Home page of Oracle Collaborative Planning, select the Planning tab.
2. On the Planning page, select Vertical View.

**Note:** You can also access pegging information from the Exceptions

tab, or by selecting an exception notification from the Home page of Oracle Collaborative Planning. Select an exception and then select Pegging to view end order information.

3. Search for your order.
4. Select your order and select the order number.

The Supply Chain Hierarchy describes the order's genealogy, information, and other pertinent information. The system displays such as the schedule impact, receipt date, and quantity. Select the plus icon to view the end order's information.

You can expand or contract the pegging information by selecting Expand All or Collapse All, respectively.

## View Pegging Information

The Pegging window can be used to track orders up and down the pegging tree. For example, a user can peg up to the customer's purchase order to the end manufacturer, and down to the supplier's shipment.

The applicable information is displayed for each order that is in the pegging tree. The orders are automatically pegged to each other based on the end order numbers.

From the pegging window, customers can infer how far their purchase order information has traversed through the supply chain. For example, if there is no supplier sales order displayed, a customer could infer that the supplier has not yet committed to meeting the customer's demand.

Throughout the supply chain, customers can detect any date or quantity mismatches against their purchase orders. They are able to track whether their order shipped on time, whether it arrives by the need-by date, and whether the right quantity shipped.

If the Collaborative Planning owner arranges transportation of material, the system populates the Need By Date column in accordance with the need by date on the purchase order. If the customer arranges transportation of material, the system populates the Ship Date column in accordance with the ship date on the purchase order.



---

# Waterfall Analysis

This chapter covers the following topics:

- Overview
- Setup
- Upload Customer Forecasts
- Search For and Compare Forecasts

## Overview

Waterfall analysis is a graphical and tabular display of successive iterations of a forecast, generated at different points in time for comparison and analysis. You can compare forecast to see how it has changed over time and examine the accuracy of the forecast as it evolved. For example, waterfall analysis allows you to compare and analyze a 6-month forecast generated in consecutive periods or months such as January, February, and March. The following order types can be used in a waterfall analysis: Sales forecast, Order forecast, and Supply commit.

The waterfall analysis capabilities Oracle Collaborative Planning enable you to:

- Retrieve and compare previous forecasts
- Track forecast changes over time

Forecast names can be used to indicate when forecasts were generated or the type of forecast.

Examples of waterfall analysis include the following:

- You want to compare how a customer's sales and order forecasts have changed over time.
- You want to compare how a supplier's supply commits have changed over time.

## Setup

To use waterfall analysis, the following steps must be completed:

1. Your customer publishes a forecast
2. Your customer revises and republishes the forecast with a different name (if your customer republishes with the same name, the old file is overwritten)
3. You navigate to the Forecast comparison page on the Planning tab and search for and select forecasts for comparison
4. You select, tabulate and graph forecasts to identify changes

The following image depicts the steps that must be completed to use waterfall analysis:

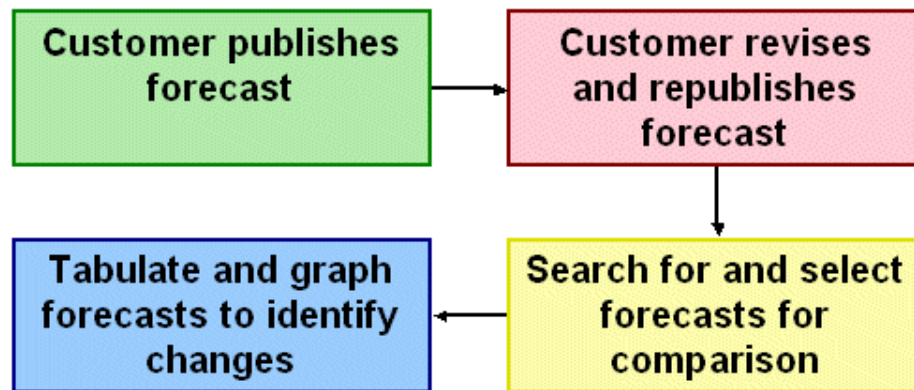

## Upload Customer Forecasts

Your customers can upload forecasts by completing the following steps:

1. Navigate to the Load Supply/Demand page on the Admin tab.
2. Download *supplydemand.dat*
3. Prepare the template
4. Save and upload the flat file
5. Repeat these steps for the second forecast.

## Search For and Compare Forecasts

To retrieve forecasts for comparison navigate to the Forecast Comparison page (Oracle Collaborative Planning Home > Planning tab > Forecast Comparison) and enter any of the following criteria in the Search window:

- Item
- Customer
- Supplier
- From Date
- To Date
- Order Type

Select the forecasts you want to compare from the search results. After selecting Compare Forecast, you can view a graphical comparison of the forecasts you chose.

While comparing the selected forecasts, the Forecast Comparison program honors the planning time buckets and time horizons. The time buckets that appear on the Forecast Comparison page correspond to the time periods defined on the site-specific calendar. For more information on time bucketing, see "Horizontal and Advanced Horizontal View: Time Bucketing in Collaborative Planning, page 9-10."

Note that Oracle Collaborative Planning buckets the forecasts based on the key date populated for the forecasts being compared. The system uses the following conventions to populate the key dates for the forecasts:

- The system considers the arrival (receipt date) date as a key date if the supplier is responsible for shipping the materials specified in a purchase order.
- The system considers the ship date as a key date if the customer is responsible for shipping the materials specified in a purchase order.

Oracle Collaborative Planning enables you to post orders specifying a bucket type. The system stores and aggregates the order quantity based on the bucket type at the daily, weekly, or monthly level. Specifying a bucket type allows you to view supply and demand information for a location time-bucketed in accordance with a location-specific calendar. This calendar is typically the location-specific receiving calendar or, if it is not defined, the location-specific manufacturing calendar. For more information on the effect of time-bucketing while aggregating orders, see "Horizontal and Advanced Horizontal View: Time Bucketing, page 9-10."



---

## Horizontal and Advanced Horizontal View

This chapter covers the following topics:

- Overview
- Horizontal View
- Collaborative Planning Time Bucketing
- Advanced Horizontal View

### Overview

A horizontal view displays planning data over time. With advanced horizontal view, you can select specific items using the search functionality. Advanced horizontal view also enables you to graphically view your supply and demand information.

Advanced Horizontal View enables you to do the following:

- Use Oracle Discoverer to query Oracle Collaborative Planning data
- Customize data display
- Perform user-defined calculations
- Define end-user queries (administrators only)
- View and navigate reports and graphs

Advanced horizontal view enables you to manipulate display data using Oracle Discoverer. You can group and aggregate your planning data in different ways and define custom calculations for supplies and demands. The calculation is created in terms of order types and the sum of the quantities of those order types. After a custom view is created you can edit or delete any portion of your custom view. You must be assigned the Supply Chain Collaboration Administrator responsibility to set up a custom view. Advanced horizontal view enables you to:

- Search over the time horizon to view details or summaries of planning data.
- Search on items for collaboration information.
- Search organizations and sites for collaboration information.

## Horizontal View

The seeded horizontal view enables you to view supply and demand information over time. In order to use the horizontal view, you must create a preference set.

## The Search Region

You can find a customer, supplier, item, or order in the Search region of the Horizontal View screen. Complete the following steps to filter records based on search criteria:

1. From the Home page of Oracle Collaborative Planning, select the Planning tab.
2. On the Planning page, select Horizontal View. Alternatively, you can select Horizontal View under the Planning category in the right-hand list on the Collaborative Planning Home page.
3. In the Search region, enter your search criteria and select Go.

The following example depicts the Search region in the Horizontal View and the search results for the customer item CM11062.

### The Horizontal View Screen

ORACLE Collaborative Planning  
Home Logout Help Preferences Personalize Page Diagnostics

Home Exceptions Planning Admin

Horizontal View Vertical View VMI Forecast Comparison Create Order Planner W

Horizontal View

**Search**

Item  Customer  Advanced

Customer Item CM11062 Supplier

Supplier Item  Order Type

Go

Display Using Preference Set CP Default Edit Preference Go

Save

TIP Find out how to edit the data on this page

Table to display horizontal view search results

Export All

Item	Item Description	Customer (Site)	Supplier (Site)	Order Type	Past Due	04-Sep-2006	11-Sep-2006	18-Sep-2006	25-Sep-2006
CM11062	Mouse Pad	Vision Corporation (TST:M1)	AM Supplier (EDI_SITE)	<a href="#">Purchase order</a>	15.00	0.00	0.00	0.00	0.00
		Vision Corporation (TST:V1)	General Electric (GE)	<a href="#">Purchase order</a>	2.00	0.00	0.00	0.00	0.00
		Vision Corporation (TST:V1)	Gennadiy EDI Supplier (EDI_SITE1)	<a href="#">Purchase order</a>	25.00	0.00	0.00	0.00	0.00

Save

Home Exceptions Planning Admin Home Logout Help Preferences Personalize Page Diagnostics

About this Page Privacy Statement Copyright (c) 2006, Oracle. All rights reserved

## Advanced Search

The Advanced Search facility enables you to search planned objects based on multiple and complex criteria.

Complete the following steps to perform an advanced search on the Horizontal View screen:

1. From the Home page of Oracle Collaborative Planning, select the Planning tab.

2. On the Planning page, select Horizontal View.

Alternatively, you can select Horizontal View under the Planning category in the right-hand list on the Collaborative Planning Home page and select Advanced Search. The following example depicts the :

#### Advanced Search Screen for Horizontal View

The screenshot displays the Oracle Collaborative Planning interface. At the top, there's a navigation bar with 'ORACLE Collaborative Planning' and links for Home, Logout, Help, Preferences, Personalize Page, and Diagnostics. Below this is a secondary navigation bar with 'Home', 'Exceptions', 'Planning', and 'Admin'. The main content area is titled 'Horizontal View' and includes options for 'Vertical View', 'VMI', 'Forecast Comparison', 'Create Order', and 'Planner W'. Two radio buttons are present: 'Show table data when all conditions are met.' (selected) and 'Show table data when any condition is met.'. There are four search criteria rows: 'Item', 'Customer Item', 'Supplier Item', and 'Owner Item'. Each row has a dropdown menu set to 'is' and an adjacent input field with a search icon. Below these is an 'Add Another' section with a dropdown for 'Item' and an 'Add' button. A 'Start Date' field with a calendar icon is located below the criteria. At the bottom right, there are 'Cancel' and 'Search' buttons. The footer contains links for 'Home', 'Exceptions', 'Planning', 'Admin', 'Home', 'Logout', 'Help', 'Preferences', 'Personalize Page', 'Diagnostics', 'About this Page', and 'Privacy Statement', along with a copyright notice: 'Copyright (c) 2006, Oracle. All rights reserved.'

3. In the Advanced Search screen:
  1. To filter the plan data based on all of the search criteria, select the option Search results where each must contain all values entered.
  2. To filter the plan data based on any one of the search criteria, select the option Search results where each must contain any value entered.
  3. Select a specific Item; customer item, supplier item, or owner item from the drop-down lists.
  4. Add a new search field from the Add Another drop-down list if required and select Add. You can now select a search criterion in the added field.

**Note:** Oracle Collaborative Planning enables you to filter and categorize purchase orders and purchase requisitions based on



customers' buyer codes.

To filter records based on buyer codes, select Buyer as a new search field from the drop-down list in the Add Another field on the Advanced Search screen.

5. In the Start Date field, select a start date for time bucketing if required. Note that by default, Collaborative Planning buckets the search results according to your default preference set.

To create a new preference set or edit an existing one, see "Horizontal and Advanced Horizontal View: Preference Sets, page 9-7." For more information about time bucketing, see "Horizontal and Advanced Horizontal View: Time bucketing, page 9-10."

6. Select Search.

The system retrieves the supply/demand information based on the search criteria and displays them on the Horizontal View screen. The following example depicts the Horizontal View screen after you perform an Advanced Search based on the buyer code "Smith, Mr. Jonathan."

**Advanced Search Screen Displaying Search Results**

**ORACLE Collaborative Planning**  
[Home](#) [Logout](#) [Help](#) [Preferences](#) [Personalize Page](#) [Diagnostics](#)

[Home](#) [Exceptions](#) [Planning](#) [Admin](#)

[Horizontal View](#) [Vertical View](#) [VMI](#) [Forecast Comparison](#) [Create Order](#) [Planner Work](#)

**Horizontal View**

**Search**

Item   Customer

Customer Item   Supplier

Supplier Item   Order Type

Display Using Preference Set CP Default

**TIP** Find out how to edit the data on this page [?](#)

Table to display horizontal view search results

Item	Item Description	Customer (Site)	Supplier (Site)	Order Type	Past Due	04-Sep-2006	11-Sep-2006	18-Sep-2006	25-Sep-2006
AS18947	Sentinel Deluxe Desktop	Vision Corporation (TST:M1)	Advanced Network Devices (SANTA CLARA-ERS)	<a href="#">Purchase order</a>	30.00	0.00	0.00	0.00	0.00
		Business World (San Jose (OPS))	Vision Corporation (TST:M1)	<a href="#">Sales order (Ship)</a>	1.00	0.00	0.00	0.00	0.00
AS54888	Sentinel Standard Desktop TPD	Computer Service and Rentals (Chattanooga (OPS))	Vision Corporation (TST:D1)	<a href="#">Sales order (Ship)</a>	10.00	0.00	0.00	0.00	0.00
		Computer Service and Rentals (FO1)	Vision Corporation (TST:D1)	<a href="#">Sales order (Ship)</a>	36.00	0.00	0.00	0.00	0.00
		A. C. Networks (Provo (OPS))	Vision Corporation (TST:M1)	<a href="#">Sales order (Ship)</a>	0.00	0.00	0.00	0.00	0.00
		AB Customer (12524)	Vision Corporation (TST:M1)	<a href="#">Sales order (Ship)</a>	3.00	0.00	0.00	0.00	0.00

[Home](#) [Exceptions](#) [Planning](#) [Admin](#) [Home](#) [Logout](#) [Help](#) [Preferences](#) [Personalize Page](#) [Diagnostics](#)

[About this Page](#) [Privacy Statement](#) Copyright (c) 2006, Oracle. All rights reserved.

**Note:** Though the system can filter and categorize records based on buyer code, it does not display the buyer code while displaying the search results.

Note that you can restrict by category set the search results that you want to query in Oracle Collaborative Planning in the Horizontal View, but the system does not display a column for category. To search transactions based on item category, you must set the profile option MSC: Category set for CP Horizontal View in Advanced Supply Chain Planning. For more information about setting up the profile option, see "Setup: Setting Up Buyer Code and Item Category for Advanced Search, page 2-23."

## Preference Sets

Before you can view your supply and demand information in the horizontal view, you must determine how to display the data. In Oracle Collaborative Planning, you can create or edit a preference set that enables you to view your data in various ways. For example, you can create a preference set to view data horizontally for only purchase orders and replenishments. A preference set enables you to do the following:

- Set aggregation with your company and trading partners
- Display or hide order types
- Arrange order types in the display
- Specify time periods (time horizons) over which data is viewed and time buckets
- Arrange preference sets

**Note:** When Oracle Collaborative Planning passes information to the horizontal view from different pages, the default preference set you create filters that information. For example, if an order type from Vendor Managed Inventory (supplier or customer-facing) doesn't exist in your preference set, then you cannot view that information in the horizontal view.

Complete the following steps to create a preference set:

1. From the Home page in Oracle Collaborative Planning, select the Admin tab.
2. Select Define User Preferences.
3. Select Create New Preference Set.
4. Enter information in the following required fields:

- Preference Set Name
  - Company Aggregation
  - Trading Partner Aggregation
  - Graphing Options
  - Display Buckets
5. Select any order type(s) from the Available Order Types column and select Move or Move All.

**Note:** The Sales Forecast order type can be used as standalone or implicit pair with a trading partner's Sales Forecast. Customers and suppliers can post this order type. You have the option of rendering a response to a trading partner's sales forecast if your trading partner has posted one to you. When the option is enabled, then the horizontal view renders a Sales Forecast row. If the option is disabled, then the horizontal view will not render the Sales Forecast row.

6. In the Selected Order Types column, you can arrange your order types in whatever order you wish. Select an order type and select either the up or down arrows to move the order type within the column.

**Note:** To provide the safety stock and projected available balance to the related trading partners, include Safety stock and Projected available balance order types in the Selected Order Types list.

To view graphical comparison of safety stock and PAB, include the graph Safety Stock/Projected available balance in the Graphing Options list.

7. To set your preference as the default, select the set as the default preference set option. You can make the preference step a public preference set. A public preference set will be available to all users and cannot be made a default preference set.
8. Select Save.

Complete the following steps to edit a preference set:

1. Select a preference set from the Preference Set Details window.
2. Select Go.

3. Edit your preference set.
4. Select Save.

## Display CTO Data

Collaborative Planning Horizontal View supports Configure to Order (CTO) solution from Oracle. You can view and analyze configurations under configurations and source them from anywhere in the supply chain. The Collaborative Planning Horizontal View displays the aggregated summary of the supplies and demands for individual configured items based on their parent base models. It helps you to understand the forecast trend and summary view for every base model. The Horizontal View displays the following for configured items:

1. Aggregated values for the supply and demand data for all configurations. Note that,
  - These values are displayed against their respective base model for actual orders.
  - Actual order includes purchase orders, sales orders, purchase requisitions, planned orders, and released planned orders. Note that, none of the actual order quantities are editable.
2. Order forecast and supply commit based on the base configuration models.
3. Aggregated bucketed data for all the other order types at the standard item level.

The sum of all the configuration quantities of all the configurations displayed in the Vertical View tab is equal to the model quantity displayed in Horizontal View.

## Edit Order Quantities

You can edit order quantities in the horizontal view for orders your company publish. The following order types can be edited in the horizontal view:

- Sales forecast
- Sell through forecast
- Order forecast
- Supply commit
- Negotiated capacity
- Historical sales

If an order forecast is published by a customer to its supplier, the supplier will see a rendered supply commit row (if it has not yet published a supply commit response). The rendered supply commit row is editable, enabling the supplier to acknowledge an order forecast by accepting the values in the supply commit row or by modifying the values and saving changes.

## Available Columns

There are several columns displayed using horizontal view. The following table lists those columns and their descriptions:

Column	Description
Items	Items are set up using Oracle Inventory. For more information about item setup, refer to Setup, page 2-21.
Customer (Sites)	For more information about customer and customer site setup, refer to Setup, page 2-7.
Supplier (Sites)	For more information about supplier and supplier site setup, refer to Setup, page 2-7.
Order Type	For more information about supported order types in Oracle Collaborative Planning, refer to Setup, page 2-46.
Net Forecast	A calculated column that displays when Display Net Forecast and Total Supply Commit is checked.  Net forecast in a bucket = [Order forecast - (PO + Requisitions + ASNs)] in a bucket.
Total Supply Commit	A calculated column that displays when Display Net Forecast and Total Supply Commit is checked. Net forecast in a bucket = [Supply commit + sales orders] in a bucket.

## Collaborative Planning Time Bucketing

### Overview

Trading partners often require a common time structure to exchange order information for collaboration purposes. Therefore, companies require a specific calendar, which ensures that planning periods evenly divide larger time increments into smaller time increments. The Collaborative Planning time bucketing allows planners to display, use, and summarize transaction data according to site-specific calendars assigned to

different trading partners. The site-specific calendar divides weeks evenly into days, months into weeks, and years into months. It uses a 5/4/4 or 4/4/5 week pattern and summarizes data from a weekly level to monthly level. A day always corresponds to a calendar day. Week and month periods always begin on a specified weekday, such as Monday.

## Benefits of using site-specific calendar for time bucketing

This feature helps planners:

1. See supply and demand for a location time-bucketed in accordance with a location-specific calendar. This calendar is typically the location-specific receiving calendar or, if it is not defined, the location-specific manufacturing calendar.
2. Post orders specifying a bucket type. The system stores the order quantity based on the bucket type at the daily, weekly, or monthly level.
3. Spread supply and demand data evenly to a specific time bucket and help planners create a more consistent supply and demand statement.
4. Localize data display in the Horizontal View with calendars specific to the inventory organizations and trading partner sites.
5. Compare supply and demand data for similar time periods and resolve the mismatches efficiently.

## Setup

The following steps outline the setup for Collaborative Planning time bucketing:

1. Create a workday calendar.
2. Assign the workday calendar to trading partners.
3. Select the default system calendar

### Setup in Oracle Bills of Materials (BOM)

Create a workday calendar in the Workday Calendar window. Use the following navigation path to open the Workday Calendar window:

Navigator > Bills Of Materials > Setup > Calendars

### Workday Calendar Window

The screenshot shows a window titled "Workday Calendar" with the following fields and values:

- Name: MFG\_2006
- Description: Manufacturing Calendar from January 2006 to D
- Quarterly Type: 4/4/5 Week Pattern
- Calendar Date Range:
  - From: 01-JAN-2006, Sunday
  - To: 01-JAN-2010, Friday

At the bottom of the window, there are three buttons: "Workday Pattern", "Shifts", and "Dates".

The default system calendar acquires the following attributes from the selected calendar:

- **The start day of a week and month period:** Derived from the start date of the calendar.
- **The quarterly type:** The quarterly type can have the following periodic divisions indicating the number of weeks in the first, second, and third months of a quarter:
  - 4/4/5 week pattern for a quarter
  - 5/4/4 week pattern for a quarter
  - Calendar months in a year
  - 13 periods in a year

For more information on creating workday calendars, see "Creating a Workday Calendar" in Oracle Bills of Material User's Guide.

**Note:** You can also access workday calendars through Oracle Order Management. Use the following navigation path to open the Workday Calendar window: Navigator > Order Management > Setup > Shipping > Calendars > Enter



## Setup in Oracle Order Management

Select the role of the trading partner (Supplier, Customer, Organization, or Carrier) and assign the workday calendar to the trading partner in the Assign Calendars window.

Use the following navigation path to open the Assign Calendars window:

Navigator > Order Management > Setup > Shipping > Calendars > Assign

### Assign Calendars Window

Site Name	Calendar Code	Enabled
BERLIN-E1	CP-Mon-70	<input checked="" type="checkbox"/>
FRANKFURT-E1	Standard	<input checked="" type="checkbox"/>
LONDON-E3	RJ-SCC1	<input checked="" type="checkbox"/>
		<input type="checkbox"/>
		<input type="checkbox"/>

Note that a calendar must be created and defined in the Oracle Bills of Material (BOM) or Oracle Order Management application as a Workday calendar before it can be assigned to a shipper, receiver, or carrier. If the receiving calendar is not defined, the delivery calendar, manufacturing calendar, or the shipping calendar of the supplier site or the supplier organization is used. If none of these calendars is available, Collaborative Planning uses the default system calendar.

For more information on assigning calendars to trading partners, see "Defining Transportation Calendars" in *Oracle Order Management Implementation Manual*.

## Setup in ASCP

Set up profile option MSC: Collaborative Planning Default Calendar to indicate the default system calendar that Oracle Collaborative Planning uses to bucket supply/demand information when multiple customer sites are displayed together.

Select the default system calendar from the list of workday calendars you created earlier

in the E-Business Suite source instance. Note that the Collaborative Planning Horizontal View buckets supply and demand data into days, weeks, and months (periods) according to the receiving calendar of the trading partner who receives the material. For more information on the profile options, see "Appendix A: Profile Options" in *Oracle Advanced Supply Chain Planning Implementation and User's Guide*.

## Creating Time Buckets

The following sections discuss the steps to create time buckets:

### Step 1: Specify a time horizon

You can specify a time horizon to display order information in Horizontal View preference sets. You can specify a single time bucket such as day or a combination of multiple time buckets. For more information on creating preference sets, see "Preference Sets."

### Step 2: Define the first day of the time horizon

The start day of a site-specific week and a site-specific month are always the same. Unlike a manufacturing calendar, the start day on a site-specific calendar does not consider a working day or non-working day specification.

### Step 3: Support time aggregation on orders posted to Oracle Collaborative Planning

The trading partners can post orders specifying a calendar date and a bucket type along with other information through the Sales Orders window. For more information on posting orders, see "Order Entry" in Oracle Order Management User's Guide. Oracle Collaborative Planning groups these order records in the following way by obeying the site-specific calendar of the trading partner:

1. The trading partners specify a time range on orders posted to the system through the Create Order page or by uploading a flat file. For more information on the Create Order page, see "Add to Order and Add To Quote Capability" in *Oracle Order Management User's Guide*.
2. The planning engine determines the start date from the order's key date, such as Ship date and Receipt date.
3. Planners populate the Ship date or the Receipt date based on the order type, and enter an end date while posting the order in the Sales Order window.
  - **Bucket type: Day**  
System creates a record on each day beginning on the start date and ending on the end date.
  - **Bucket type: Week**  
System creates one record for each week on the same weekday (Sunday

through Saturday) across consecutive weeks that include the start date and end date.

- **Bucket type: Month**  
System creates one record for each month on the same day of the month across consecutive months that include the start date and end date.
4. The system stores the order at the daily, weekly, or monthly level, depending on the following bucket types:
- **Time bucket specification: Day**  
System considers the calendar date specified on the order to be its due/availability date.
  - **Time bucket specification: Week**  
System considers the order to be due/available in the week that includes the calendar date specified on the order. Note that the definition of week is derived from the site-specific calendar.
  - **Time bucket specification: Month**  
System considers the order to be due/available in the month that includes the calendar date specified on the order. Note that the definition of month is derived from the site-specific calendar.
5. The system retrieves the number of days between order receipt date and the order end date (based on the bucket type) and then spreads the order quantities equally among these days.
6. The system collects the orders and buckets them based on either the ship date or the receipt date of the order. The rules for bucketing are as follows:
- For transactions between the OEM organization and a supplier, the due date is the receipt date at the OEM organization's dock.
  - For transactions between the OEM organization and a customer, it is the ship date from the OEM organization's dock if the customer controls outbound logistics (for most order types).
  - The receipt date is considered as the due date at the customer's dock if the OEM organization controls outbound logistics.
  - For ASN, Shipment Receipt, Shipment In Receiving order types, the receipt date is always considered as the due date.
  - For Sales forecast and sell-through forecasts, the ship date is always considered

as the due date.

**Note:** Each order type in the e-Business Suite has order date, promise date, need by date, request date, and so on. One of these always has the functional meaning of "Due Date." Depending upon the order transaction specification or the customer's setting, the due date is interpreted as follows:

- The ship date is interpreted as the due date when the material leaves its origin location.
- The receipt date is interpreted as the due date when the material arrives at its destination location.

#### Step 4: Segmenting Data into Time Buckets for Horizontal Display

Depending upon the user's preference set, Collaborative Planning uses the following seven possible combinations to segment supply and demand information into time buckets.

Combination No.	Day	Week	Month
1	1	0	0
2	1	1	0
3	1	1	1
4	1	0	1
5	0	1	0
6	0	1	1
7	0	0	1

#### First bucket displayed is Day

Combinations 1 to 4 have Day as the first time bucket. In this case, the default start date of the Horizontal View is always the system date. For example, if the first bucket is Day and the system date is January 1, 2003, then the first bucket in the Horizontal View begins with 01-January-2003. The system will summarize and display all records that fall on this day in the Horizontal View.

### **First bucket displayed is Week**

Combinations 5 and 6 have Week as the first time bucket. In this case, the start date of the Horizontal View will be the first day of the week, which includes the system date. To find the first day of the week, the system will refer to the site-specific calendar. The site-specific calendar stores the definition of a week and its start day. All records that fall between the first day of the week and the last day of the week will be summarized in the first weekly bucket displayed. For example, if the first bucket is Week, the system date is January 1, 2003, and the week begins on Monday, then the first bucket in the Horizontal View begins with 30-December-2002. The week will end on 05-January-2003.

### **First bucket displayed is Month**

Combination 7 has Month as the first time bucket. In this case, the start date of the Horizontal View will be the first day of the month, which includes the system date. To find the first day of the month, the system will refer to the site-specific calendar. The site-specific calendar stores the definition of a site-specific month and its start day. All records that fall between the first day of the month and the last day of the month will be summarized in the first monthly bucket displayed. For example, if the first bucket is month, the system date is January 1, 2003, and the month begins on Monday, then the first bucket in the Horizontal View begins with 30- December-2002. The month will end on 02-February-2003.

## **Step 5: Transition from a Lower Bucket to a Higher Bucket**

Oracle Collaborative Planning converts a lower time bucket into a comparatively higher time bucket to aggregate the supply and demand information of the lower time buckets, and then compares it with the supply and demand information from higher time buckets. The system conforms to the conventions for time bucket transition described in the following paragraphs.

### **Transition from daily to weekly buckets**

When the system converts the daily buckets into weekly buckets, the last Day bucket may fall on any day of the week. If the last display day bucket falls in the middle of a site-specific week, extra days are added to complete the week until the time bucket reaches the end of the week. After reaching the end of the week displayed in days, the system will begin displaying data in weekly buckets. The system will look at the site-specific calendar to identify the start and end of the site-specific week where the last Day bucket falls. For example, if the display preference is set to show 1 day and 1 week, the system date is 01-January-2003, and the site-specific week/month begins on Monday, then the system will display 5 daily buckets (from 01-January-2003 until 05-January-2003) before it begins the display of the weekly bucket on 06-January-2003.

### **Transition from weekly to monthly buckets**

When the system converts the weekly buckets into monthly buckets, the last week bucket may fall on any week of the month. If the last display week bucket falls in the middle of a site-specific month, extra weeks will be added to complete the month weeks until it reaches the end of the month. After reaching the end of the month displayed in weeks, the system will begin displaying data in monthly buckets. The system will look

at the site-specific calendar to identify the start and end of the site-specific month where the last Week bucket falls. For example, if the display preference is set to show 0 days, 1 week, and 1 month, the system date is 01-January-2003, and the site-specific week/month begins on Monday, then the system will display 5 weekly buckets (from 30-December-2003 until 27-January-2003) before it begins the display of the monthly bucket on 03-February-2003.

### **Transition from daily to monthly buckets**

The system converts the daily buckets into monthly buckets, when the last day bucket falls during the middle of the site-specific month. In such case the system adds extra days until it reaches the end of the month. After reaching the end of the month displayed in days, the system will begin displaying data in monthly buckets. The system looks at the site-specific calendar to identify the start and end of the site-specific month where the last Day bucket falls. For example, if the display preference is set to show 1 day and 1 month, the system date is 01-January-2003, and the site-specific week/month begins on Monday, then the system will display 33 daily buckets (from 01-January-2003 until 02-February-2003) before it begins the display of the monthly bucket on 03-February-2003.

The system can display 36 columns in the Horizontal View. In the previous example, 34 buckets or columns appear in the Horizontal View, and 33 of these are daily buckets. If a user specifies this combination of days and months, the system will run out of available buckets, as the maximum number of buckets displayed is 36. Therefore, it is recommended that you avoid this combination of days and months in your display preferences.

As different customer sites may use different site-specific calendars, the system may find data for two sites with different site-specific definitions while retrieving information based on a query. In this situation, a single customer site displays against the Collaborative Planning default system calendar instead of against the customer site's calendar. The following example explains this situation.

### ***Calendars defined in the system***

	<b>Calendar Type</b>	<b>Quarterly Pattern</b>	<b>Week/Month Start Day</b>
Collaborative Planning system	Default calendar	(4-4-5)	Monday
Customer site 1	Receiving calendar	(5-4-4)	Monday
Customer site 2	Receiving calendar	(4-4-5)	Monday

**Calendar entries**

		<b>Calendar Entries</b>	<b>Start Date</b>	<b>End Date</b>
Collaborative Planning system	Default calendar	Period 1	6-Jan-03	2-Feb-03
Collaborative Planning system	Default calendar	Period 2	3-Feb-03	2-Mar-03
Customer site 1	Receiving calendar	Period 1	30-Dec-02	2-Feb-03
Customer site 1	Receiving calendar	Period 2	3-Feb-03	2-Mar-03
Customer site 2	Receiving calendar	Period 1	6-Jan-03	2-Feb-03
Customer site 2	Receiving calendar	Period 2	3-Feb-03	2-Mar-03

**Supply and demand records in the database**

<b>Record Number</b>	<b>Customer Site</b>	<b>Date</b>	<b>Quantity</b>
Record 1	Customer site 1	6-Jan-03	100
Record 2	Customer site 1	2-Feb-03	100
Record 3	Customer site 2	1-Jan-03	25

We assume that the system date is 7-Jan-03 with the following user preference:

	<b>Days</b>	<b>Weeks</b>	<b>Months</b>
User preference set	0	0	2

The Collaborative Planning Horizontal View retrieves transaction data for a time horizon of two months. It uses the start and end dates of the default system calendar.

The default system calendar periods are as follows:

Calendar Type	Calendar Entries	Start Date	End Date
Default calendar	Period 1	6-Jan-03	2-Feb-03
Default calendar	Period 2	3-Feb-03	2-Mar-03

The Horizontal View retrieves the following records:

Record Number	Customer Site	Date	Quantity
Record 1	Customer site 1	6-Jan-03	100
Record 2	Customer site 1	2-Feb-03	100

The Horizontal View finds only one customer site and tries to render the data against the customer site's receiving calendar, which has start and end dates as follows:

Customer site	Calendar Type	Period	Start Date	End Date
Customer site 1	Receiving calendar	Period 1	30-Dec-02	2-Feb-03
Customer site 1	Receiving calendar	Period 2	3-Feb-03	2-Mar-03

The Horizontal View then uses the start and end dates of the receiving calendar to query and parse the data. Using the start and end dates of the receiving calendar of customer site 1, the Horizontal View then retrieves the following records:

Record Number	Customer site	Date
Record 1	Customer site 1	6-Jan-03
Record 2	Customer site 1	2-Feb-03
Record 3	Customer site 2	1-Jan-03

Since two customer sites exist, the Horizontal View resolves the calendar conflict by selecting the default system calendar to display data, yielding the following information:



Customer site	Date	Quantity
Customer site 1	6-Jan-03	100
	2-Feb-03	100

No data is displayed for customer site 2.

To understand the transition better, consider the following example, which is illustrated by this diagram:

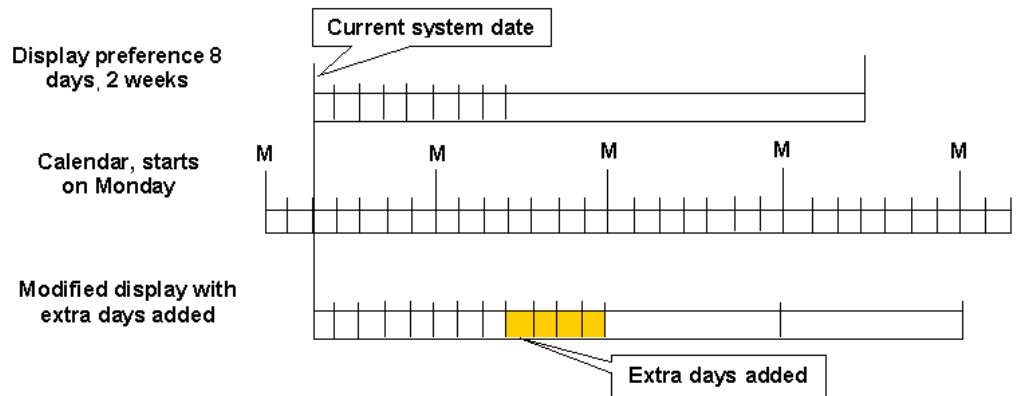

Assume that you have the following time bucketing preferences:

1. Week start day: Monday.
2. Current system date: 31-Jan-2004, Saturday.
3. Your display preference: 8 days, 2 weeks, 0 months.

In this situation, the last day bucket falls on Sunday, 8-Feb-2004. Therefore, the two weekly buckets will start from 9-Feb-2004, and 16-Feb-2004 both on Monday. No adjustment is required in this case.

If you want to look at the same data after two days, when the system date is 2-Feb-2004, Tuesday, the last day bucket will fall on 10-Feb-2004, Tuesday.

The weekly bucket should start from the following day, 11-Feb-2004, or Wednesday. But it is middle of the week. In this case, more day buckets will be added to complete the week and the two weekly buckets will start from 16-Feb-2004, and 23-Feb-2004 (both are Mondays), respectively.

The final bucket pattern in the display will be:

- 2-Feb-2004 (Tuesday) to 10-Feb-2004: Bucket type= Day as per your display preference.

- 11-Feb-2004 (Wednesday) to 15-Feb-2004: Bucket type = Day, extra 4 Day buckets added to complete the week.
- 16-Feb-2004 (Monday) to 29-Feb-2004: Bucket type = Week, as per your display preference.

Similarly, if there is a transition from day to month, (such as in display preference of 8 Days - 0 Weeks - 2 Months), and the last day bucket falls on the middle of the selected calendar's month, extra days will be added to complete the month.

Similarly, for transitioning weekly buckets to monthly buckets, if the last week bucket falls in middle of a month period as defined in the selected calendar, then extra weeks will be added to complete the month. For example, if the end of 4 weeks (in 0day-4week-2month preference set) falls on 21-Mar-2004 and next month starts from 29-Mar-2004, a week will be added till the end of the month, making your display 0day-5week-2months. The following diagram illustrates this example:

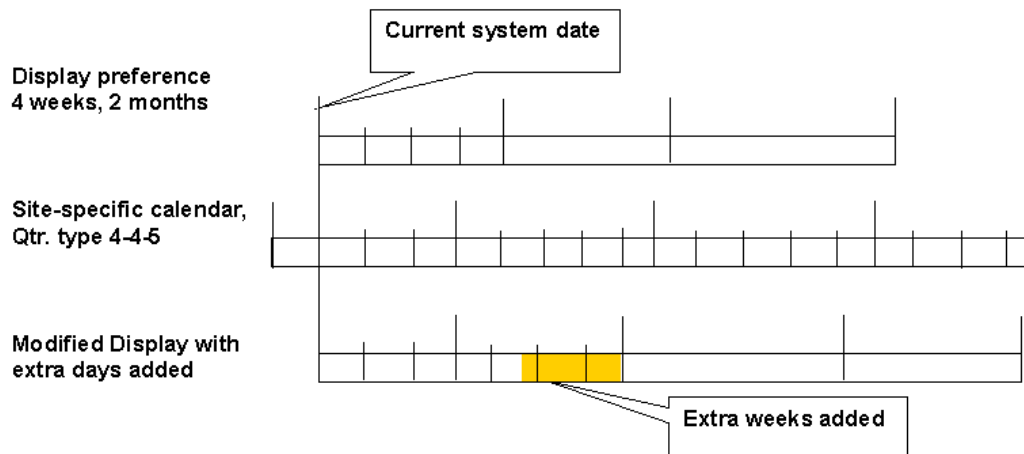

### Step 6: Horizontal View Start Day Adjustment According to the Time Bucket

In Horizontal View, start date of the week and month are derived according to the calendar used. The correct calendar is selected based upon the following calendar hierarchy.

- When the first bucket displayed in the view is specified as Day, the system does not make any adjustments and uses the current system date as the start day in the Horizontal View.
- When the first bucket displayed in the view is specified as Week, the system adjusts the view to the first day of the current week derived from the selected calendar.
- When the first bucket displayed in the view is specified as Month, the system adjusts the view to the first day of the current month derived from the selected calendar.

Consider an example for which you have selected the month to start from 9-Sep-2006 in the selected calendar based upon the quarterly settings. If the order's demand date in a monthly bucket is 14-Sep-2006, it will be adjusted to 5-Sep-2006, instead of 1-Sep-2006. The following image shows how the Start Day is adjusted to the first day of the week and month using the correct calendar:

### Horizontal View Screen

Item	Item Description	Customer (Site)	Supplier (Site)	Order Type	Past Due	Current	18-Sep-2006	25-Sep-2006	02-Oct-2006	09-Oct-2006	16-Oct-2006
03Lot/Serial Controlled	Lot/Serial Controlled	Computer Service and Rentals (Chattanooga (OPS))	Vision Corporation (TST:M1)	Sales order (Ship)	3.00	0.00	0.00	0.00	0.00	0.00	0.00
03iSP Item1	iSP Item 1	Vision Corporation (TST:V1)	Office Supplies, Inc. (OFFICESUPPLIES)	Purchase order	20.00	0.00	0.00	0.00	0.00	0.00	0.00
4101	Malibu's Best Can	Goodway (SEATTLE)	Vision Corporation (TST:PR2)	Sales order (Ship)	4,500.00	0.00	0.00	0.00	0.00	0.00	0.00
		ValueChoice (BOISE)	Vision Corporation (TST:PR2)	Sales order (Ship)	2,500.00	0.00	0.00	0.00	0.00	0.00	0.00

However, for new records, the system populates the ship date or receipt date based on the trading partner responsible for arranging the transport, considers this date as the bucket start date, and uses it for order bucketing.

To convey the date used for order bucketing, the Horizontal View displays the Request Date type (Ship or Arrival) in the order type column after the order type. The following order types are classified based on Request Date type:

- Purchase order
- Sales order
- Order forecast
- Supply commit

Note that this display rule applies only to outbound transactions (transactions between

the owner of Collaborative Planning and the owner's customers). It does not apply to transactions between the owner and the owner's suppliers. Any purchase order issued by the Collaborative Planning owner to its supplier would not have the Ship or Arrival designation. Only purchase orders issued by the customer to the owner of Collaborative Planning and posted to Collaborative Planning by the customer would show the Ship and Arrival designations. For more information about the order bucketing procedure, see "Support time aggregation on orders posted to Oracle Collaborative Planning."

#### **Step 7: Horizontal View Displays Orders Based on Site-Specific Calendar**

The Horizontal View aggregates orders and display data according to a site-specific calendar definition. However, planners may define one or more calendars for different business needs. In addition, a supply/demand statement always involves more than one trading partner. The system may have to select a calendar from multiple calendars representing different trading partners' sites. To select the calendar for the Horizontal View, the Collaborative Planning system uses the following conventions.

##### **When the OEM organization is the customer:**

- The receiving calendar of the OEM's organization is used to display the data.
- The Horizontal View determines the start and end dates of the time buckets based on the calendar entries found on this calendar.
- In the absence of the receiving calendar, the system uses either the manufacturing calendar of the OEM organization or the default system calendar.

##### **When the OEM organization is the supplier:**

- The receiving calendar of the customer's site is used to display the data.
- The Horizontal View determines the start and end dates of the time buckets based on the calendar entries found on the receiving calendar of the customer's site.
- In the absence of this calendar, the system uses the shipping calendar of the supplier's site (OEM's organization), the manufacturing calendar of the supplier's site, or the default system calendar.

##### **When the OEM organization is not involved:**

- The receiving calendar of the customer's site is used to display the data.
- In the absence of this calendar, the system uses the delivery calendar of the supplier's site or the default system calendar.

##### **When two customer sites are displayed together or data are aggregated across customer sites**

When two or more receiving calendars are involved, the system uses the default system calendar to display data.

## Editing Order Quantities in the Horizontal View

Order quantities can be edited in the Horizontal View for specific order types under certain conditions. The following conditions are prerequisite to data editing in the Horizontal View:

- Your company must be the publisher of the data.
- You must select the order type you intend to edit in your preference set.
- The time bucket of the underlying data and the display time bucket must be homogenous (either day or week or month) for the time range you selected for your preference set. For example, data posted at the weekly level may be editable only if the display bucket is set to Week.

The system assigns a time bucket to the data the first time when you edit the order quantity and saves the changes. The time bucket of the data corresponds to the display time bucket that is specified in your preference set. The following example explains the circumstances in which you can edit the order quantities in a Horizontal View: Assume the system date is January 10, 2003. The receiving calendar used to display the data has a 5-4-4 quarterly pattern. Its week and month begin on Monday. The following records are posted to the system for an item, customer site, and supplier site combination:

<b>Date</b>	<b>Order type</b>	<b>Quantity</b>	<b>Bucket</b>
01/11/2003	Order forecast	300	Day
02/03/2003	Order forecast	200	Week
02/08/2003	Order forecast	100	Week
03/26/2003	Order forecast	100	Week

The following diagram shows the four scenarios with varying display preferences and a common set of data posted to the system. Depending upon the start date of the Horizontal View and the display settings in your preference set, you can edit the data. Each scenario represents an independent query initiated from the Horizontal View.

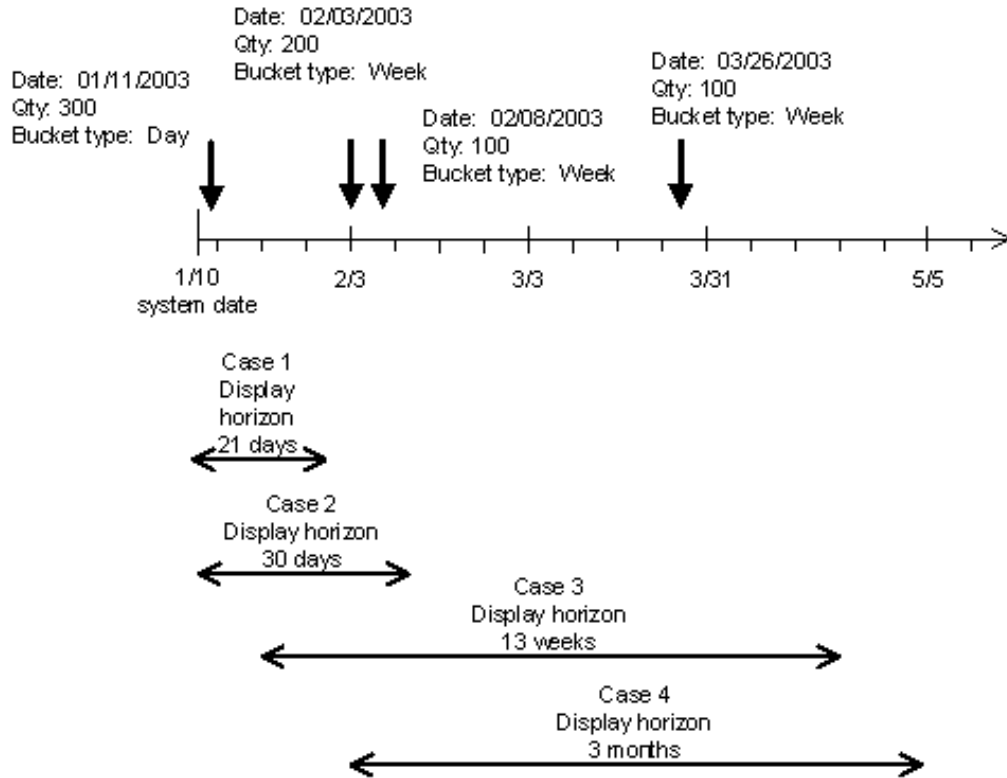

In cases 1 and 3, you can edit data in the Horizontal View. In cases 2 and 4, you cannot edit data. The following table explains the reasons. Note that in all four cases a single time bucket is used to display data either days, weeks, or months.

Case	System date	Start date of Horizontal View	Display buckets	Edit data in Horizontal View?
1	1/10/2003	1/10/2003	14 days	Yes. Data posted at daily level. Display buckets at daily level.
2	1/10/2003	1/10/2003	30 days	No. Data posted at daily and weekly levels. Display buckets at daily level
3	1/10/2003	1/20/2003	13 weeks	Yes. Data posted at weekly level. Display buckets at weekly level.
4	1/10/2003	2/3/2003	3 months	No. Data posted at weekly level. Display buckets at monthly level

In case 3 you can see a quantity of 300 in the weekly bucket beginning on February 3. There are two orders with quantities of 200 and 100 each. If the quantity of 300 is changed to 500 the system will make the following changes after you submit the data:

<b>Date</b>	<b>Order type</b>	<b>Old Quantity</b>	<b>New Quantity</b>	<b>Bucket</b>
02/03/2003	Order forecast	200	200	Week
02/08/2003	Order forecast	100	300	Week
02/03/2003	Total for week	300	500	

The system sorts the records in the buckets in ascending order by quantity. If you edit the quantity in the bucket, the first record or the record with the smallest quantity is adjusted.

If the quantity of 500 is subsequently changed to 100, the system will make the following changes after you submit the data:

<b>Date</b>	<b>Order type</b>	<b>Old Quantity</b>	<b>New Quantity</b>	<b>Bucket</b>
02/03/2003	Order forecast	200	0	Week
02/08/2003	Order forecast	300	100	Week
02/03/2003	Total for week	500	100	

The record with the smallest quantity was decremented until it reached zero. The next record was decremented until the total amount deducted from the weekly quantity came to 400.

## Running Totals of Supply and Demand

You can tailor your horizontal plan preference set to enable the display of running total demand and running total supply rows. When you do so, you must also choose to display the Order Forecast and Supply Commit order types. Company and trading partner aggregation is respected when displaying the running total rows. Row totals are displayed after the last time period in the horizon.

# Advanced Horizontal View

## Setup

To set up advanced horizontal view, your administrator must complete the following steps:

- Create new workbooks and specify report format
- Select and arrange data elements
- Customize the workbooks and define filters and calculations
- Manage and share workbooks with other users

The following image depicts the administrator setup flow for advanced horizontal view.

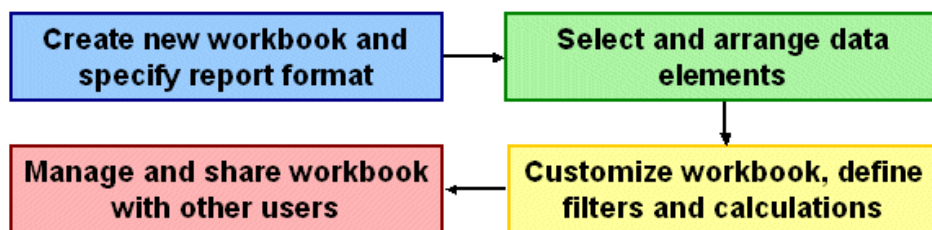

## Create Workbooks

Complete the following steps to create a workbook:

1. From the Home page in Oracle Collaborative Planning, select the Admin tab.
2. In the Admin page, select Define Custom Bucketed View.

**Note:** When you select Custom View, the system launches Oracle Discoverer.

3. In the Workbook Wizard, select Create a new workbook.
4. Select the type of view you want for the workbook.
5. Select the columns to display by choosing from the Available column.



**Note:** You can move an element back to the Available column from the Selected column. After you select an element, you can rearrange elements for your specific business needs.

6. Select Next.
7. Define your query conditions.
8. Select Next.
9. On the Format page, you can format data and your heading as well as editing the heading.
10. Select Next.
11. On the Conditions page, you can create a conditional statement. Select New.

**Note:** Your conditional statement will limit information. Select OK after completing your statement.

12. Select Next.
13. In the Calculations page, you can create a calculation for your condition. To define calculations, enter information in the following fields:
  14. Calculation Name
  15. Show
  16. CalculationRepeat this procedure for every calculation you want in your workbook.
17. Select Next.
18. On the Percentage page, you can create a percentage for your condition.
19. Select Next.
20. On the Totals page, you can summarize the results of your calculations.
21. Select Next.
22. On the Parameters page, you can enter parameters for your conditional statement.
23. Select Finish. The system will now load your new workbook.

## Share Workbooks

Workbooks can be shared with all users, including customers and suppliers. The following information is required to share a workbook:

- Workbook name
- User(s) who will access the workbook

After you create a workbook you can share your workbook. To share your workbook, complete the following steps:

1. With your new workbook open in Oracle Discoverer, navigate to Sharing under Manage Workbooks.
2. Select users who you want to view the workbook.

## View Workbooks

Complete the following steps to view a workbook:

1. From the Home page in Oracle Collaborative Planning, select the Planning tab.
2. Select Custom View.

**Note:** Oracle Discoverer automatically launches when you select Custom View.

3. Select the workbook you want to view.
4. To enter or change parameters for limiting a query over a time horizon, select Options.
5. Enter the following information in the options window:
  - Query governor
  - Worksheets
  - Summary data
  - Fan-trap detection
  - End user layer access
  - Locale selection

6. Select Apply.
7. View the report.



---

## Vertical View

This chapter covers the following topics:

- Overview
- Export Data from Vertical View
- Export Data in Import Format
- Display of CTO Data

### Overview

Collaborative Planning Vertical View enables you to select and view details of a specific item or order. You can filter the plan data based on search criteria for an order type, due date, or quantity. You and your trading partners can search for your inventory using Vertical View or export either demand or supply information.

You can adopt any of the following search facilities to filter plan data in Vertical View:

### The Search Region

You can find an item or order in the Search region of the Vertical View screen. Complete the following steps to search for an item or order:

1. From the Home page of Oracle Collaborative Planning, select the Planning tab.
2. On the Planning page, select Vertical View.

**Note:** Alternatively, you can select Vertical View under the Planning category in the right hand list on the Collaborative Planning Home page.

3. In the Search region, enter your search criteria and select Go.

The following image shows the Search region in the Vertical View and the search

results for an order type of ASN.

**The Search Region in the Vertical View Screen**

**ORACLE Collaborative Planning**  
Home Logout Help Preferences Personalize Page Diagnostics

Home Exceptions **Planning** Admin

Horizontal View | **Vertical View** | VMI | Forecast Comparison | Create Order | Planner Wo

**Vertical View**

**Search**

Item

Customer item

Supplier item

Order Type

Order Number

**Views**

View

Table to display vertical view search results

**Select Object:**

[Select All](#) | [Select None](#)

Select	Item	Base Model	Item Description	Customer	Customer Site	Supplier	Supplier Site	Order Type
<input type="checkbox"/>	SAL-101		Lot Item	Vision Corporation	TST:M1	Office Supplies, Inc.	OFFICESUPPLIES	ASN
<input type="checkbox"/>	SAL-102		Serial @ Receipt	Vision Corporation	TST:M1	Office Supplies, Inc.	OFFICESUPPLIES	ASN
<input type="checkbox"/>	BAP-100		Plain Item	Vision Corporation	TST:M1	Office Supplies, Inc.	OFFICESUPPLIES	ASN
<input type="checkbox"/>	BAP-101		Lot Item	Vision Corporation	TST:M1	Office Supplies, Inc.	OFFICESUPPLIES	ASN
<input type="checkbox"/>	DSR-100		Plain Item	Vision Corporation	TST:M1	Office Supplies, Inc.	OFFICESUPPLIES	ASN
<input type="checkbox"/>	VCH-103		Revision Item	Vision Corporation	TST:M1	Office Supplies, Inc.	OFFICESUPPLIES	ASN

**Advanced Search**

The Advanced Search facility enables you to search planned objects based on multiple and complex criterion.

Complete the following steps to perform an advanced search in the Vertical View screen:

1. From the Home page of Oracle Collaborative Planning, select the Planning tab.
2. On the Planning page, select Vertical View.

**Note:** Alternatively, you can select Vertical View under the Planning category in the right-hand list on the Collaborative Planning Home page.

3. Select Advanced Search.

The following image shows the Advanced Search button in the Vertical View screen:



**The Advanced Search Button in the Vertical View Screen**

The screenshot shows the 'Collaborative Planning' interface. At the top, there are navigation links: Home, Logout, Help, Preferences, Personalize Page, and Diagnostics. Below this, there are tabs for 'Exceptions', 'Planning', and 'Admin'. The 'Vertical View' tab is active, with sub-links for 'VMI', 'Forecast Comparison', 'Create Order', and 'Planner Workbench'. The main search area contains several input fields: 'Item', 'Order Type', 'Customer Item', 'Order Number', and 'Supplier Item'. Each field has a magnifying glass icon. A red circle highlights the 'Advanced Search' button located to the right of the 'Order Type' field. Below the search fields is a 'Go' button. Further down, there are 'Go' and 'Personalize' buttons. A section titled 'Display vertical view search results' contains buttons for 'Exception Details', 'Order Details', and 'Save'. Below this is a 'Select None' link. The main content is a table with the following columns: Item, Base Model, Item Description, Customer, Customer Site, Supplier, Supplier Site, Order Type, and Order Number. The table contains three rows of data, each with a red circle icon in the first column.

Item	Base Model	Item Description	Customer	Customer Site	Supplier	Supplier Site	Order Type	Order Number
-		Lot Item	Vision Corporation	TST:M1	Office Supplies, Inc.	OFFICESUPPLIES	ASN	<a href="#">5350.SALM</a>
-		Serial @ Receipt	Vision Corporation	TST:M1	Office Supplies, Inc.	OFFICESUPPLIES	ASN	<a href="#">5350.SALM</a>
P-		Plain Item	Vision	TST:M1	Office Supplies,	OFFICESUPPLIES	ASN	<a href="#">5275.BAPT</a>

4. In the Advanced Search screen, do the following:
  1. To filter the plan data based on all of the search criteria, select the Search results where each must contain all values entered option.
  2. To filter the plan data based on any one of the search criteria, select the Search results where each must contain any value entered option.
  3. Select a specific Item, Customer Item, Supplier Item, or Owner Item from the lists.
  4. Add a new search field from the Add Another list if required and select Add. You can now select a search criterion in the added field.

5. Select a sort criterion if required. Note that Collaborative Planning displays search results in descending order by default.
6. Select Search.

The following image shows the Advanced Search screen:

**The Advanced Search Screen**

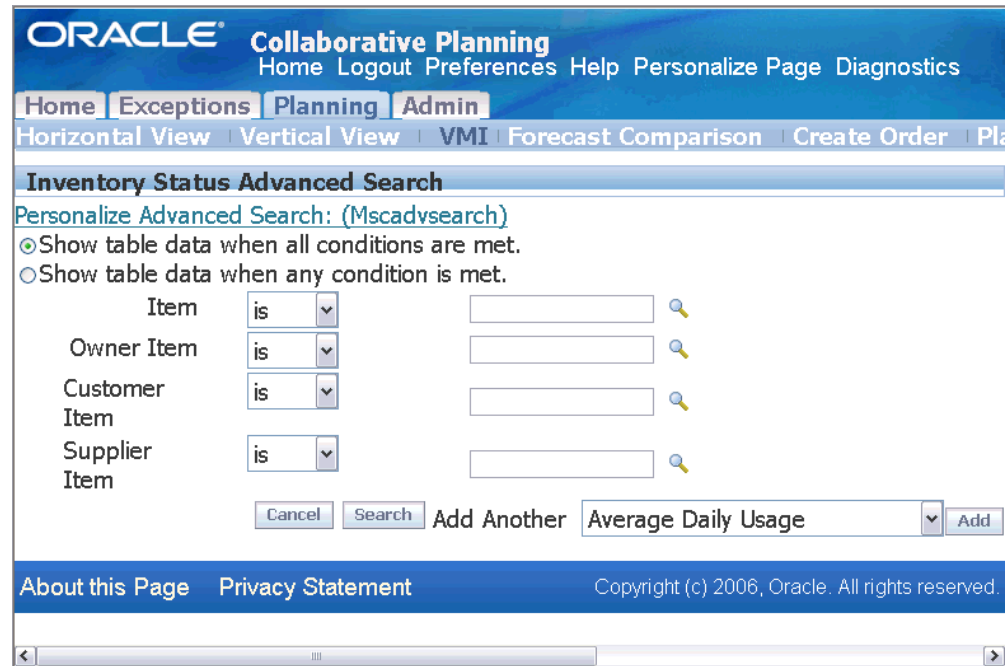

5. The system retrieves the supply and demand information based on the search criteria, and it displays them on the Vertical View screen.

**The Vertical View Screen Displaying the Results of Advanced Search**

The screenshot shows the Oracle Collaborative Planning interface. At the top, there is a navigation bar with 'ORACLE Collaborative Planning' and links for 'Home', 'Logout', 'Help', 'Preferences', 'Personalize Page', and 'Diagnostics'. Below this is a secondary navigation bar with 'Home', 'Exceptions', 'Planning', and 'Admin'. The main content area is titled 'Vertical View' and contains a search section with input fields for 'Item', 'Customer item', 'Supplier item', 'Order Type', and 'Order Number', along with a 'Go' button. Below the search section is a 'Views' section with a 'View' dropdown menu and 'Go' and 'Personalize' buttons. An 'Export All' button is also present. The main content area displays a table of search results with columns for 'Select', 'Item', 'Base Model', 'Item Description', 'Customer', 'Customer Site', 'Supplier', and 'Supplier Site'. Two results are shown for item 'CM11222'. At the bottom of the screen, there is a footer with 'About this Page', 'Privacy Statement', and 'Copyright (c) 2006, Oracle. All rights reserved'.

Select	Item	Base Model	Item Description	Customer	Customer Site	Supplier	Supplier Site
<input type="checkbox"/>	CM11222		Battery - Extended Life	Vision Corporation	TST:V1	GE Plastics	GE PLASTICS
<input type="checkbox"/>	CM11222		Battery - Extended Life	Vision Corporation	TST:E5	Consolidated Supplies	STRASBOURG

**Saving Search Results in a Personalized Folder**

After conducting a search, you can save the results in a personalized view (folder). Complete the following steps to save the search results in a personalized view:

1. From the Home page of Oracle Collaborative Planning, select the Planning tab.
2. On the Planning page, select Vertical View.

**Note:** Alternatively, you can select Vertical View in the Planning

category in the right-hand list on the Collaborative Planning Home page.

3. Filter plan data using the Search region or the Advanced Search facility.
4. In the Vertical View screen, select Personalize. The following image shows the Personalize button in the Vertical View screen:

**The Personalize Button in the Vertical View Screen**

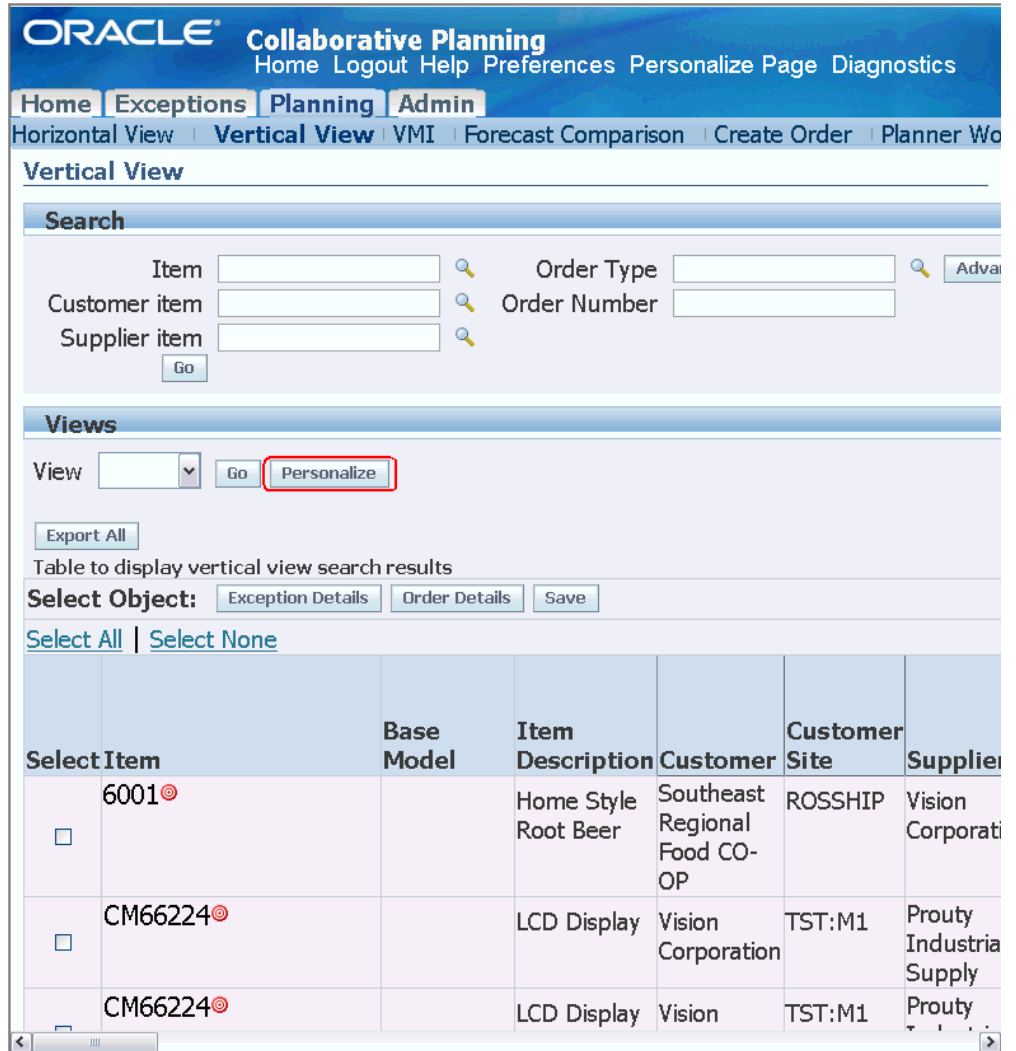

5. In the Personalize Views screen, select the personalized view that you want to save the search results in, and select Apply. The following image shows the Personalize Views screen:

**The Personalize Views Screen**

Below is a list of all pre-configured and/or personalized views applicable to "Table to display vertical view search results" table on the previous screen. Pre-configured views are read only. Duplicate a pre-configured view to see its definition or to create a variation of the same.

Select View:  |

Select View Name	Description	Display View	Default	Update	Delete
<input type="radio"/> Order Forecast View	This view stores the past Order Forecasts	Yes <input type="button" value="v"/>			
<input type="radio"/> Export	Seeded View for Export.	Yes			

- To update the selected personalized views, click the update icon.
- To duplicate the selected existing personalized view, select Duplicate.
- To create a new personalized view, select Create View.

**Note: For Purchase Orders posted by customer:** The system populates:

- The Receipt Date column if the selected request date type for the customer site is Arrival.
- The Ship Date column if the selected request date type for the customer site is Ship.

**For Sales Orders collected from the source system:** The system populates:

- The Receipt Date column if the selected request date type for the customer site is Arrival.
- The Ship Date column if the selected request date type for the customer site is Ship.

For Purchase Orders collected from the source system, the Receipt Date column is populated based on profile option MSC: Purchase Order Dock Date Calculation Preference. Valid values are Promised Date and Need By Date.

## Export Data from Vertical View

Oracle Collaborative Planning enables you to export either demand or supply information. Oracle Collaborative Planning supports export transactions using a tab-delimited flat file through XML.

Trading partners can also export (to .csv text file) safety stock and PAB data along with other supply and demand information from the Vertical View (in Collaborative Planning) to spreadsheets.

Complete the following step to export data from Oracle Collaborative Planning.

1. Access the Oracle Collaborative Planning application.
2. Select the Planning tab.
3. From the Planning window, select Vertical View.
4. Search for and select your specific information (order type, item, customer).
5. Select Export to download a formatted spreadsheet.

You can edit the Ship Date or Receipt Date (whichever one is the key date) and the Quantity columns for the purchase orders and sales orders loaded using flat file upload, XML transactions, and manual order entry programs. However, you cannot edit the key date for the purchase orders and sales orders collected from the source system. Note that only the owner (typically the trading partner who published the document) can edit the key date for a purchase order or sales order.

For more information about XML transactions in Oracle Collaborative Planning, refer to XML, page C-1.

## Export Data in Import Format

Collaborative Planning enables you and your trading partners to export the supply and

demand information from Collaborative Planning in .csv format. You can then open and update the file according to the planned response using Microsoft Excel and upload the updated file in Collaborative Planning using the standard uploading facilities. This feature streamlines the process by which a supplier can respond to a customer's order forecast. The supplier can query the customer's order forecast in the Collaborative Planning Vertical View, then export the records into a .csv-formatted file that can be manipulated in a spreadsheet. In the spreadsheet, the supplier can change all the order types from Order Forecast to Supply Commit, and all the order forecast quantities to the desired supply commit response quantities. The revised spreadsheet can then be loaded into Collaborative Planning as the supplier's supply commit.

You must download the Microsoft Excel template from Collaborative Planning before you can import supply and demand information. Complete the following steps to download the required template:

1. From the Home page in Oracle Collaborative Planning, select the Admin tab.
2. Under the Admin tab, select Load Supply/Demand.
3. On the Load Supply/Demand screen, select Download templates.
4. Run the OATemplate.exe application after saving it to your local disk.  
Optionally, you can run the application directly using the File Download dialog box. The application extracts and saves the OATemplate folder in your local disk.
5. Open ExcelLoad.xlt from the OATemplate folder. Note that you must enable the macros in the template to activate the APS menu.

Perform the following steps to update supply and demand records in .csv format:

1. Query supply and demand records: On the Vertical View screen, query the supply and demand records that you want to export. Use advanced search facility to filter and organize the records. For example, order forecasts published by a specific customer (Buyer).
2. Display the results using the seeded Export view: Oracle Collaborative Planning provides a system-defined data view called Export that arranges the data to be exported in the appropriate column format. The following example depicts the Export view on the Vertical View screen:



**Export View on the Vertical View Screen**

**ORACLE Collaborative Planning**  
Home Logout Help Preferences Personalize Page Diagnostics

Home Exceptions **Planning** Admin

Horizontal View | **Vertical View** | VMI | Forecast Comparison | Create Order | Planner Wo

**Vertical View**

**Search**

Item   Order Type

Customer item   Order Number

Supplier item

**Views**

View **Export**

Table to display vertical view search results

**Select Object:**

[Select All](#) | [Select None](#)

Select	Item	Base Model	Item Description	Customer	Customer Site	Supplier	Supplier Site	Order Type
<input type="checkbox"/>	IMF-COMP4		IMF-COMP4					Unallo onhan
<input type="checkbox"/>	DBI-R12-MFG-P10		DBI-R12-MFG-P10					Unallo onhan
<input type="checkbox"/>	FCA-NWV-2		Standard - With Volume Only					Unallo onhan

Select Export from the list in the View field, and select Go to view the records that are saved in the Export folder.

3. Export the records and save locally:
  1. Select the Export All button on the Vertical View screen.

**The Export All Button on the Vertical View Screen**

The screenshot shows the Oracle Collaborative Planning interface. At the top, there is a navigation bar with 'ORACLE Collaborative Planning' and links for 'Home', 'Logout', 'Help', 'Preferences', 'Personalize Page', and 'Diagnostics'. Below this is a secondary navigation bar with 'Home', 'Exceptions', 'Planning', and 'Admin'. The main content area is titled 'Vertical View' and contains a search section with fields for 'Item', 'Customer item', and 'Supplier item', along with 'Order Type' and 'Order Number' fields. Below the search section is a 'Views' section with a dropdown menu set to 'Export' and buttons for 'Go' and 'Personalize'. The 'Export All' button is highlighted with a red box. Below this is a table to display vertical view search results, with buttons for 'Exception Details', 'Order Details', and 'Save'. The table has columns for 'Select Item', 'Base Model', 'Item Description', 'Customer', 'Customer Site', 'Supplier Site', and 'Order Type'. Three items are listed: IMF-COMP4, DBI-R12-MFG-P10, and FCA-NWV-2. Each item has a checkbox and a red circle icon next to it.

Select	Item	Base Model	Item Description	Customer	Customer Site	Supplier Site	Order Type
<input type="checkbox"/>	IMF-COMP4		IMF-COMP4				Unallo onhan
<input type="checkbox"/>	DBI-R12-MFG-P10		DBI-R12-MFG-P10				Unallo onhan
<input type="checkbox"/>	FCA-NWV-2		Standard - With Volume Only				Unallo onhan

2. Save the export.csv file locally using the File Download dialog box.
  
4. Import the file into Microsoft Excel:
  1. Open the ExcelLoad.xlt template using Microsoft Excel. When prompted, select Enable Macros.
  2. Select the Import From Vertical View option from the APS menu and open the locally saved .csv file. The following example depicts an imported .csv file and the APS menu:

## The export.csv File and the APS Menu

Item	Base Mod	Item Desc	Customer	Cus	LIDM	Advanced	SANTA CL	Purchase	Order Num	Receipt Dt	Ship Date	Actual Dat	Quantity	Serial Nur	UOM	Bu
2	CM76962	Video Cam	Vision Cor	LIDM1	Advanced	SANTA CL	Purchase	1593	12-Mar-01	12-Mar-01			5975	Ea	Da	
3	bj-2494575	bj-2494575	Vision Cor	LIDM1	Advanced	SANTA CL	Purchase	4083	28-Feb-03	28-Feb-03			150	Ea	Da	
4	CM60257	RAM - 128	Vision Cor	LIDM1	Advanced	SANTA CL	Purchase	1577	13-Mar-01	13-Mar-01			517	Ea	Da	
5	CM66326	Plastic Ca	Vision Cor	LIDM1	Advanced	SANTA CL	Purchase	1491	6-Jun-02	6-Jun-02			467	Ea	Da	
6	CM68377	10" Plasm	Vision Cor	LIDM1	Advanced	SANTA CL	Purchase	1585	6-Apr-01	6-Apr-01			2735	Ea	Da	
7	CM94532	Software -	Vision Cor	LIDM3	Advantage	ADVANTA	Purchase	3315	25-Jan-02	25-Jan-02			30	Ea	Da	
8	CM60257	RAM - 128	Vision Cor	LIDM1	Advanced	SANTA CL	Purchase	1577	7-Mar-01	7-Mar-01			517	Ea	Da	
9	CM15138	Monitor - 1	Vision Cor	LIDM3	Advanced	SANTA CL	Purchase	3329	1-Feb-02	1-Feb-02			174	Ea	Da	
10	CM15138	Monitor - 1	Vision Cor	LIDM3	Advanced	SANTA CL	Purchase	3331	1-Feb-02	1-Feb-02			197	Ea	Da	
11	CM15138	Monitor - 1	Vision Cor	LIDM3	Advanced	SANTA CL	Purchase	3332	1-Feb-02	1-Feb-02			159	Ea	Da	
12	CM15140	Monitor - 1	Vision Cor	LIDM3	Advanced	SANTA CL	Purchase	3333	1-Feb-02	1-Feb-02			6	Ea	Da	
13	CM15140	Monitor - 1	Vision Cor	LIDM3	Advanced	SANTA CL	Purchase	3341	1-Feb-02	1-Feb-02			2	Ea	Da	
14	CM93827	ZIP DRIVE	Vision Cor	LIDM3	Advanced	SANTA CL	Purchase	3085	13-Dec-01	13-Dec-01			5	Ea	Da	
15	CM15138	Monitor - 1	Vision Cor	LIDM3	Advanced	SANTA CL	Purchase	3328	1-Feb-02	1-Feb-02			174	Ea	Da	
16	CM15138	Monitor - 1	Vision Cor	LIDM3	Star Gate	STAR GAT	Purchase	816	1-Feb-02	1-Feb-02			174	Ea	Da	
17	CM15138	Monitor - 1	Vision Cor	LIDM3	Star Gate	STAR GAT	Purchase	816	1-Feb-02	1-Feb-02			197	Ea	Da	
18	CM15138	Monitor - 1	Vision Cor	LIDM3	Star Gate	STAR GAT	Purchase	816	1-Feb-02	1-Feb-02			159	Ea	Da	
19	CM15138	Monitor - 1	Vision Cor	LIDM3	Star Gate	STAR GAT	Purchase	3314	25-Jan-02	25-Jan-02			100	Ea	Da	
20	CM15138	Monitor - 1	Vision Cor	LIDM3	Star Gate	STAR GAT	Purchase	816	1-Feb-02	1-Feb-02			174	Ea	Da	
21	CM15140	Monitor - 1	Vision Cor	LIDM3	Star Gate	STAR GAT	Purchase	820	1-Feb-02	1-Feb-02			2	Ea	Da	
22	CM15140	Monitor - 1	Vision Cor	LIDM3	Star Gate	STAR GAT	Purchase	3314	25-Jan-02	25-Jan-02			40	Ea	Da	
23	CM15140	Monitor - 1	Vision Cor	LIDM3	Star Gate	STAR GAT	Purchase	820	1-Feb-02	1-Feb-02			6	Ea	Da	
24	CM32546	Battery - 1	Vision Cor	LIDM3	Star Gate	STAR GAT	Purchase	3314	25-Jan-02	25-Jan-02			500	Ea	Da	
25	CM45098	Slot Cover	Vision Cor	LIDM3	Star Gate	STAR GAT	Purchase	1614	27-Dec-01	27-Dec-01			560	Ea	Da	
26	CM15138	Monitor - 1	Vision Cor	LIDM3	Star Gate	STAR GAT	Purchase	3314	25-Jan-02	25-Jan-02			300	Ea	Da	
27	CM08830	RAM - 256	Vision Cor	LIDM3	Star Gate	STAR GAT	Purchase	3314	25-Jan-02	25-Jan-02			200	Ea	Da	
28	CM08830	RAM - 256	Vision Cor	LIDM3	Star Gate	STAR GAT	Purchase	3314	25-Jan-02	25-Jan-02			25	Ea	Da	
29	CM18759	Keyboard -	Vision Cor	LIDM3	Advantage	ADVANTA	Purchase	3315	25-Jan-02	25-Jan-02			375	Ea	Da	
30	CM13139	Hard Drive -	8 GB				Unallocated onhand					6-Jan-06	463	Ea	Da	
31	CM13375	Manual -	Vision Operating System				Unallocated onhand					6-Jan-06	2223	Ea	Da	

The APS menu provides the following options for importing supply and demand information in the Excelload.xlt template:

- **Import Data File:** If you are loading flat-file data into Collaborative Planning and not modifying data that is exported from Collaborative Planning, you can use this option to open a .dat file for modification. You can also use this option if you need to modify or enter the supply and demand records that are saved in .dat format.
  - **Import From Vertical View:** Use this option to open a .csv file that has been exported from the CP vertical view.
5. Edit the file as necessary: Update or enter the relevant supply and demand records in this file using Microsoft Excel.
  6. Export and save the file: Select the Export Data File option from the APS menu and save export.csv locally in .dat format. Name the file SupplyDemand\*.dat, where \* represents arbitrary user-determined file-name characters (for example, SupplyDemand001.dat).
  7. Upload the file in Collaborative Planning: Upload the file using the Load Supply/Demand facility in Collaborative Planning.

**Note:** The APS menu in the ExcelLoad.xlt template provides an option called User Options, which you can use to select a file delimiter from the File Delimiter drop-down list. The default file delimiter is ~.

Note that you generally do not need to select a delimiter. When Collaborative Planning reads in a .dat file using the load supply and demand command, it looks for data fields to be separated by a ~ character. When you use the Export Data File command in the APS menu, the system transfers the data in the spreadsheet to a text file and inserts ~ after each cell's data.

**Important:** This feature is not supported in Japanese and Chinese environments.

## Display of CTO Data

The CTO support in Collaborative Planning Vertical View enables you to analyze detailed itemized picture of each demand and supply record in the Vertical View. When the planner drills down from a bucketed quantity for a base model (except for order forecast and supply commit), the Vertical View lists all the configurations in that base model. You can:

1. Display supplies and demands on an order-by-order basis.
2. Search all orders for a base model, irrespective of individual configurations, by entering the base model name as a search criterion.
3. Search result displays the base model for each configuration order.
4. Display individual order forecasts at the model level when the user drills down through an order forecast or supply commit for a base model.

Note that, the summed quantity of all order forecasts and/or supply commits is equal to the quantity displayed in Horizontal View.

---

# Multi-Tier Collaboration in Collaborative Planning

This chapter covers the following topics:

- Overview
- Oracle Applications Support for Multi-Company Collaborative Planning
- Executing Multi-Company Collaborative Planning

## Overview

Oracle Collaborative Planning enables you to model any level of complexity in your supply chain and promote a seamless flow of information and materials across your extended supply chain. The Collaborative Planning Horizontal Plan and the ASCP Planner Workbench displays source supplier and sites for modeled organizations (for contract manufacturers and/or key suppliers) while you view plan information by organization. This enables you to provide visibility to all tiers of the supply chain and convey their requirements to all tiers of the supply chain so that you can have visibility of all issues and constraints in your supply chain.

Multi-tier collaborations enable you to:

- Plan across multiple tiers in your supply chain to communicate requirements and changes in requirements efficiently to your contract manufacturers and suppliers including Tier 2 suppliers.
- Gain visibility to Tier supplier capacity and customer requirements.
- Get a greater control over an extended supply chain by communicating not only the requirements for contracted assemblies, but also the requirements for any critical components to other tiers of the supply chain.
- Identify possible disruptions in the flow of material, which in turn helps in identifying contingency plans.

- Automate the coordination of supplies to reduce latency of information across the supply chain.
- Reallocate key components for alternate sourcing decisions.
- Reduce inventory levels by providing visibility to inefficient processes that cause you and your trading partners to carry extra, "just in case" inventory.
- Dynamically provide visibility to constraints as changes occur across the supply chain to manage disruptions and avoid manually expediting orders.
- Collaborate more closely and proactively with customers and suppliers to improve your forecast accuracy.

## Oracle Applications Support for Multi-Company Collaborative Planning

Multi-company collaborative planning addresses a complex business environment with large volumes of data and increased difficulty managing information, communicating requirements, and coordinating processes across multiple tiers in your supply chain and collaborate with your customers, suppliers, and contract manufacturers (CM).

To contend with the complexity and volume of planning data, Oracle APS products incorporate workflow-enabled exceptions to monitor internal processes as well as interactions with first and second tier trading partners. Before exchanging the supply/demand data with your trading partners, you must set the foundation of your multi-company collaborative planning using the Oracle E-Business Suite:

1. Create your customers' site information in Oracle Order Management.
2. Create your suppliers' site information in Oracle Purchasing.
3. Plan your inventory organizations in Oracle Inventory for planned.

The following checklist summarizes the steps that you must follow to implement multi-company collaboration in Oracle Collaborative Planning. It includes setup steps for data that may be shared with other Oracle applications but are required by Oracle Collaborative Planning.

Because some setup steps build upon information that you define in other steps, perform the setup in the order listed.

Step No.	Setup Step	Application	Reference
1	Register the customer	Oracle Order Management	Step 1: Register the customer, <i>Oracle Collaborative Planning Implementation and User's Guide</i>

Step No.	Setup Step	Application	Reference
2	Set up the internal inventory organizations and define the items	Oracle Inventory	Step 2: Set up internal inventory organizations and define items, <i>Oracle Collaborative Planning Implementation and User's Guide</i>
3	Create an external inventory organizations to represent suppliers and supplier sites	Oracle Purchasing	Step 3: Create inventory organizations to represent suppliers/supplier sites, <i>Oracle Collaborative Planning Implementation and User's Guide</i>
4	Associate an external inventory organization with CM	Oracle Purchasing: Manufacturing and Distribution Manager	Step 4: Associate an external inventory organization with CM, <i>Oracle Collaborative Planning Implementation and User's Guide</i>

Oracle Demand Planning (DP), Oracle Advanced Supply Chain Planning (ASCP), and Oracle Collaborative Planning (CP) facilitate collaboration among trading partners and communication across the extended supply chain. All constituents in the supply chain work with a common set of planning and execution information located in Oracle E-Business Suite. You should maintain the reference data in the Oracle E-Business Suite system, and the CM loads its supply and demand information through flat files into the Oracle Enterprise Manager (OEM) organization's supply chain plan. The following flowchart depicts the workflow for multi-company collaboration:

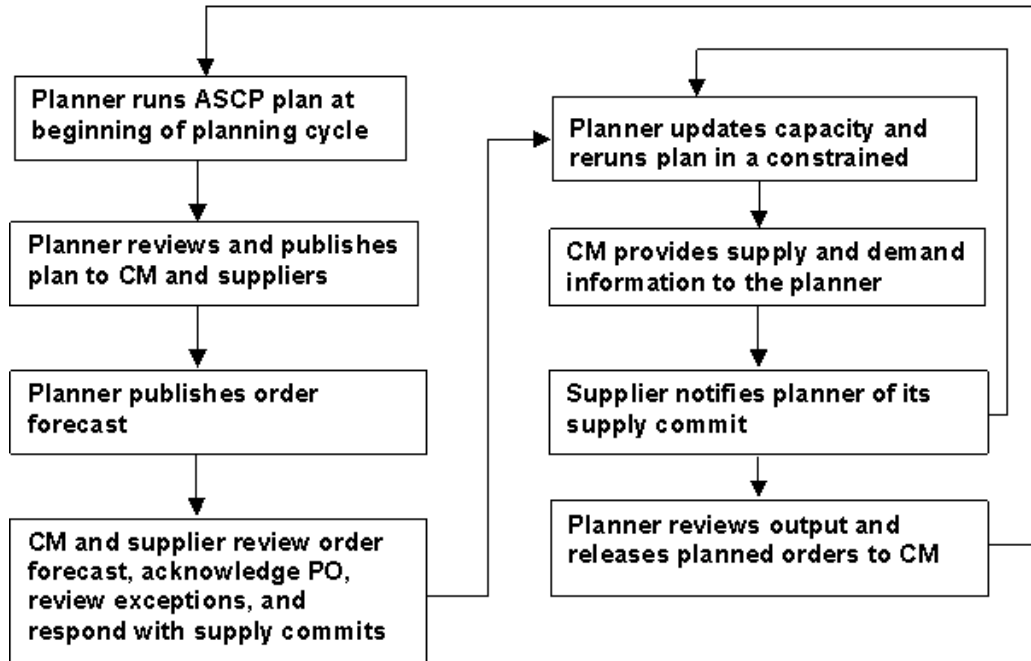

### The Planner Develops a Consensus Demand Plan

The OEM organization collaborates with its customer to develop a consensus demand plan. The planner exchanges an order forecast with customers for products that it produces. The consensus demand plan is the keystone for the related supply chain plan. Note that customer orders and forecasts updated in the demand plan result in new and changed requirements upstream in the supply chain.

### The Planner Collects Data and Develops a Supply Chain Plan

Both customers and the OEM organization forecast sales of the OEM's products. In addition, the OEM books sales orders for product customers intend to buy.

In turn the OEM may source materials internally from various manufacturing sites, which generates internal sales orders, or externally from suppliers. In response, the OEM's manufacturing sites create work orders to satisfy demand, and suppliers may respond with sales orders or by acknowledging the OEM's purchase orders. These orders comprise the present state of supplies and demands in the supply chain. To accurately plan the supply chain, the OEM must represent these supplies and demands in its planning system.

### The Planner Runs ASCP Plan at the Beginning of the Planning Cycle

The planner runs the supply chain plan, creates new planned orders for unfulfilled demands, and considers the existing supplies (such as in-transit shipments, purchase orders, and on-hand supplies) to fulfill these demands. For an unconstrained plan the planner can create supplies as needed to satisfy demands. However, for a constrained



plan the planner must recognize the following constraints:

- Operational constraints at the OEM organization's as well as at the CM's facilities
- Material constraints from the supplier

The results of the supply chain plan depend heavily on the following two sets of information:

- The flow of materials and orders throughout the system governed by the supply chain setup
- The present supply and demand requirements placed on the supply chain

### **The Planner Reviews and Releases Plan to CM**

The planner reviews the plan's results. The enhancement enables the planner to analyze plans by supplier organizations and view supplier and supplier sites for items sourced from the supplier organizations. After completing the review, the planner firms and releases planned orders to the CM organization in order to create purchase orders for the unfulfilled demands. The system then creates requisitions and purchase orders in Oracle Purchasing from the released planned orders.

**Note:** The planner may choose to reschedule and re-release purchase orders and work orders, if required.

### **Publish Order Forecast**

The planner publishes forecast to CM and Tier 2 supplier using the Publish Order Forecast program directly from an ASCP plan. This ensures that any released orders that are not yet converted into purchase orders will be part of the order forecast. The actual orders are not reflected in the planning system until the next data collection.

### **CM and Supplier Review Order Forecast, Acknowledge Purchase Orders, and Post Supply Commit**

The CM and supplier conduct their internal planning separately as follows:

The CM plans its supply chain based on the planner's order forecast and responds to the planner's purchase order with either a sales order or a purchase order acknowledgement. Then the CM communicates its order forecast to the supplier. Note that, the responsibility to release orders to the supplier organization remains solely on the CM organization.

The supplier logs into Oracle Collaborative Planning and reviews the order forecast published by the CM. The supplier organization can create its own supply chain plan independently after accessing the purchase orders created by the CM and planned orders created by ASCP. The planner then receives the supply commit from the supplier into its ASCP plan as supplier capacity.

The planner reviews any potential supply issues due to upstream supply / demand mismatches. Such a situation arises due to insufficient supply response by Tier 2 supplier to contract manufacturer's order. Oracle Collaborative Planning computes exceptions and sends notifications to the OEM and all the related trading partners if an upstream order such as the sales order posted by the supplier adversely affects downstream orders such as sales orders posted by the contract manufacturer and the OEM.

### **The planner updates capacity and reruns plan in a constrained mode**

The planner collects information about supply and demand in its own facilities and reviews exceptions. The CM provides the planner the complete status of supplies and demands for its facility to include in the planner's supply chain plan. Based on these, the planner then updates the on-hand supplies from shipment notices and receipts and completed work orders.

Note that, the planner must gather changes in its supplies and demands, update the existing capacity constraints and rerun the supply chain plan before planning again.

Once the planner refreshes the supply and demand information, the CM should also refresh the supply and demand information for its facility.

**Note:** The CM must supply the planner new and updated sales orders, purchase orders, requisitions to suppliers, shipment notices and receipts, completion notices for work orders, and updated on-hand quantities.

### **Supplier notifies planner**

The supplier notifies the planner of its supply commit, which is used in the planner's supply chain plan.

### **The planner reruns the supply chain plan**

The planner runs the supply chain plan after incorporating supplier's supply commits and CM's supplies and demands. Collaborative Planning creates new planned orders for unfulfilled demand and considers the existing supplies. Note that the system uses supplier's supply commit as a material constraint and the CM's resources as operational or resource constraints.

### **Planner reviews output and releases planned orders to CM**

The planner reviews results of the plan, compares the differences in OEM's order forecast and the supplier's supply commit, and begins the process to resolve any difference. Here the planner may decide to:

- Change or reschedule purchase orders at its facility as well as negotiate with the CM to modify its resource capacity

- Negotiate with the supplier to adjust its supply commits
- Adjust capacity at the OEM's facilities or modify its forecast if it cannot resolve exceptions through negotiation with the CM and supplier

The following figure depicts an example of a supply chain to illustrate multi-company collaborative planning:

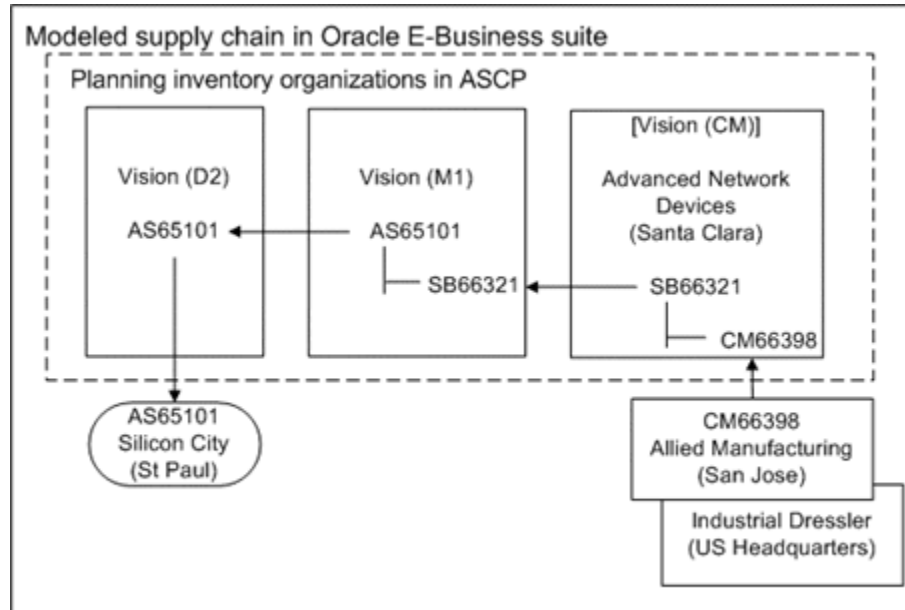

There are five companies and six sites discussed in this example. There are:

- A customer named Silicon City
- A manufacturer (OEM) named Vision Corporation. The OEM has two sites, D2, a warehouse for distribution, and M1, a manufacturing site for final assembly.
- A contract manufacturer named Advanced Network Devices. The CM has one site, Santa Clara, which is modeled as an inventory organization in the OEM's supply chain.

The following table summarizes the companies, company sites, and their roles in the example supply chain:

Role	Company name	Company site name
Customer	Silicon City	Silicon City

<b>Role</b>	<b>Company name</b>	<b>Company site name</b>
Manufacturer (OEM)	Vision Corporation	D2, M1
Contract Manufacturer (CM)	Advanced Network Devices	Santa Clara* (CM)
Supplier	Allied Manufacturing	San Jose
Alternate supplier	Industrial Dressler	US Headquarters

\* The inventory organization, CM, is an alias for the contract manufacturer's site.

### **Flow of material and orders in the example supply chain**

1. The customer, Silicon City, orders the finished good, AS65101, from the OEM's warehouse, D2. Silicon City issues an order forecast to Vision Corporation, and Vision Corporation responds with a supply commit for the item.
2. The OEM, Vision Corporation, manufactures AS65101 at its manufacturing site, M1, and stores the finished goods at D2. It ships the good from its warehouse, D2.
3. The OEM procures a subassembly, SB66321, used in the finished good from the CM, Advanced Network Devices. The OEM issues an order forecast to Advanced Network Devices.
4. Advanced Network Devices responds with a supply commit.
5. The CM produces the subassembly at its manufacturing site, Santa Clara. The same manufacturing site is modeled as an inventory organization (CM) in the OEM's supply chain plan.
6. The CM procures a component, CM66398, used in the subassembly from the supplier, Allied Manufacturing. The OEM organization issues an order forecast to Allied Manufacturing on behalf of the CM.
7. Allied Manufacturing responds with a supply commit.

## **Executing Multi-Company Collaborative Planning**

### **Demand Planning and Forecast Collaboration**

The following sections discuss the steps for demand planning and forecast collaboration with customers:

### Customer prepares a flat file with its order forecast

Silicon City (customer) should first prepare a flat file for its order forecast. The customer can use the Microsoft Excel template ExcelLoad.xlt to create the flat file. The customer can make adjustments to its forecast, maintain successive iterations of its forecast, and manage exceptions with Vision Corporation (OEM). The following figure displays the flat file template to load supplies and demands into Oracle Collaborative Planning:

**Flat File Template To Load Supplies And Demands Into Oracle Collaborative Planning**

Sync Indicator	Item	Customer	Customer Item
R	CM66254	Vision Corporation	ASC
R	CM66259	Vision Corporation	ASC
R	CM66264	Vision Corporation	ASC
R	CM66265	Vision Corporation	ASC
R	CM66266	Vision Corporation	ASC
R	CM66268	Vision Corporation	ASC
R	CM66269	Vision Corporation	ASC
R	CM66254	Vision Corporation	ASC
R	CM66259	Vision Corporation	ASC
R	CM66264	Vision Corporation	ASC
R	CM66265	Vision Corporation	ASC
R	CM66266	Vision Corporation	ASC
R	CM66268	Vision Corporation	ASC
R	CM66269	Vision Corporation	ASC
R	CM13375	Vision Corporation	ASC
R	CM15138	Vision Corporation	ASC
R	CM15140	Vision Corporation	ASC
R	CM18759	Vision Corporation	ASC
R	CM18761	Vision Corporation	ASC
R	CM22473	Vision Corporation	ASC
R	CM25175	Vision Corporation	ASC
R	CM25287	Vision Corporation	ASC
R	CM28287	Vision Corporation	ASC
R	CM30764	Vision Corporation	ASC
R	CM31556	Vision Corporation	ASC
R	CM32546	Vision Corporation	ASC
R	CM35682	Vision Corporation	ASC
R	CM35719	Vision Corporation	ASC
R	CM41684	Vision Corporation	ASC
R	CM42047	Vision Corporation	ASC
R	CM44131	Vision Corporation	ASC
R	CM45098	Vision Corporation	ASC

The customer now should post the flat file for order forecast to Vision Corporation (OEM) through Oracle Collaborative Planning. To upload a flat file the customer should click the Load Supply/Demand link on the Admin tab of Oracle Collaborative Planning page.

### Customer views and edits its order forecast in Oracle Collaborative Planning

Silicon City can now view the data it has posted to the system in Collaborative Planning Horizontal View and compare it with the supply commit posted by Vision Corporation.

OEM views Material Shortage exceptions in Oracle Collaborative Planning.

If the new order forecast exceeds the present supply commit posted by Vision Corporation, the Supply Chain Event Manager generates material shortage exceptions and notifies the planner. The planner can view the details of the exceptions on the Exceptions tab of Oracle Collaborative Planning home page.

### **OEM receives customer's forecast and uses it in its demand planning process**

The planner in Vision Corporation receives the customer's (Silicon City) order forecast and uses it in its demand planning process. The customer's order forecast is received from Oracle Collaborative Planning to the planning server and brought into Oracle Demand Planning as a custom data stream.

### **OEM creates its demand plan and planners review it**

Demand planners review the customer's forecast along with historical demand, booked orders, and forecasts from marketing, sales, finance, and operations. At this step, the demand planners develop a consensus forecast based on intelligence from customers, statistical forecast techniques, and planned product promotions and events. The consensus forecast can be a composite of the different statements of demand from all these sources including the customer's input.

OEM uploads its demand plan scenarios to the planning server for supply chain planning.

After the demand planners complete reviewing and editing the order forecast the Demand Planning Administrator gathers the forecast data and uploads it to the planning server. Once uploaded, the forecast is ready to be used in supply chain planning.

## **Supply Chain Planning and Collaboration with Suppliers**

The following sections discuss the steps for supply chain planning and collaboration with suppliers:

### **CM posts supplies and demands to its inventory organization**

An important element of the planning process is the supplies and demands at the CM's site. To allow the OEM to coordinate supplies across the supply chain, the CM must post its supplies and demands into its inventory organization in the source instance of the E-Business Suite. The data collection program collects supplies and demands from the E-Business Suite onto the APS planning server for both internal and external inventory organizations. The OEM is able to plan the supply chain plan referencing this data and coordinate supplies across its trading partners.

Application Program Interfaces (APIs) allow the CM to post supplies and demands into its inventory organization on the E-Business Suite. The CM should use the following open interfaces:

- **Oracle Inventory:** Using the open interface for transactions, the CM can post material issues and receipts to update on-hand balances.
- **Oracle Purchasing:** The interfaces for open requisitions, purchasing documents, and receiving allow the CM to post purchased supplies and update the supplies over time.

- **Oracle Work in Process:** Through the work order interface, the CM can post planned orders for new discrete jobs, discrete job operations, components, resources, and scheduling details. As scheduled jobs progress towards completion, the CM can post updates to existing discrete jobs.
- **Oracle Order Management:** The interface to process orders allows the contract manufacturer to insert or update a sales order or a sales order line.

#### **OEM pegs supplies and demands between the OEM and CM**

The OEM issues purchase orders in addition to an order forecast to the CM. The CM can respond to the OEM with a sales order and peg the sales order to the OEM's purchase order. This sales order, created in the OEM's E-Business Suite, is a representation of the sales order created in the contract manufacturer's system. The ship-from warehouse on this order is the CM's inventory organization.

The supply chain plan recognizes and respects the link between the purchase and sales orders. To link the orders the CM must specify on the sales order the OEM's purchase order number and purchase order line number in the Customer PO number and Customer PO line number fields respectively.

#### **OEM runs standard data collection**

The planner from Vision Corporation runs a standard data collection to collect setup data and the supplies and demands from the Oracle E-Business Suite to the Oracle Advanced Planning and Scheduling system, where the supply chain plan is generated. The standard data collection collects data posted by the contract manufacturer (in this case, Advanced Network Devices) into its inventory organization. The following figure represents the standard data collection from the Oracle E-Business Suite to the Oracle APS system:

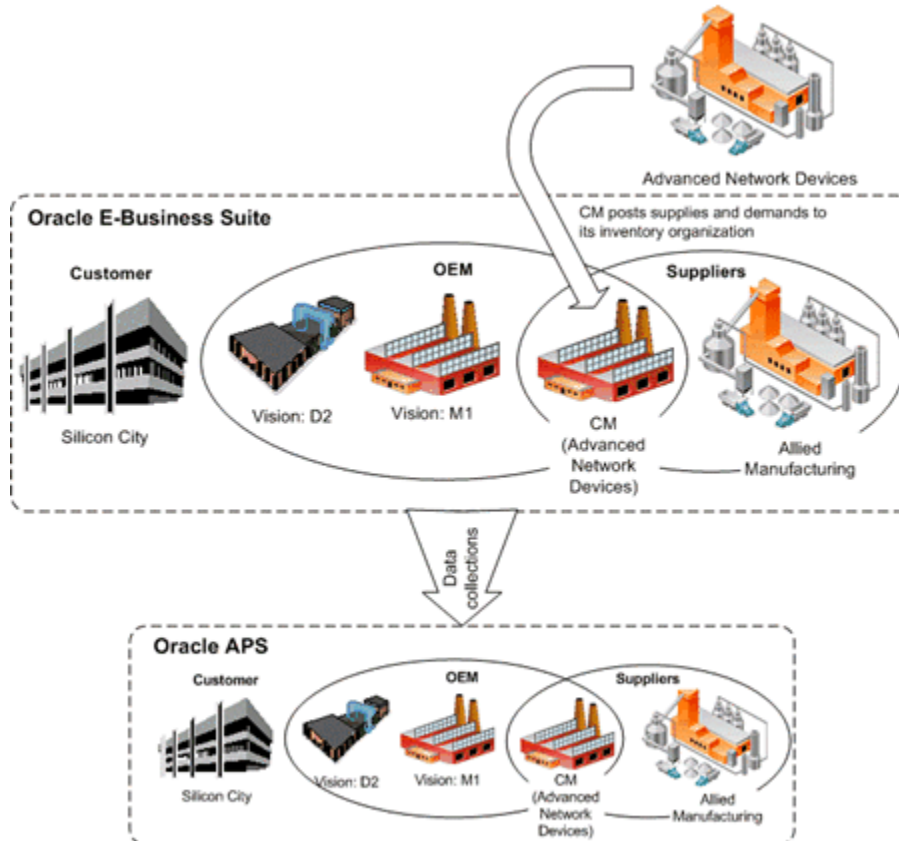

### OEM defines and runs the supply chain plan

After gathering all the necessary information, the planner from Vision Corporation defines and runs the supply chain plan. The supply chain plan can be executed in a number of different modes such as unconstrained, constrained, or optimized and with a range of options.

When the plan is initially run, we presume that the suppliers' material constraints are not yet considered. Successive iterations of the plan will incorporate a dynamic statement of the suppliers' capacity. As demand from customers change, requirements placed on suppliers will change accordingly. In this way the suppliers' response is dynamic and reflects their capacities.

The customer's demand, sales orders, and forecasts drive the supply chain plan. The supply chain plan will consider various sources of supply and recommend planned orders and specific actions to ensure that demands are satisfied. Note that you must include the OEM, CM, and supplier organizations as planned organizations in your supply chain. Sourcing rules will determine the flow of material from suppliers to the manufacturing sites for subassembly and final assembly, and finally to the warehouse. To peg orders between the OEM's and the contract manufacturer's organizations you must select the Include Sales Orders option in the Plan Options window as shown in



the following figure:

**The Plan Options Window**

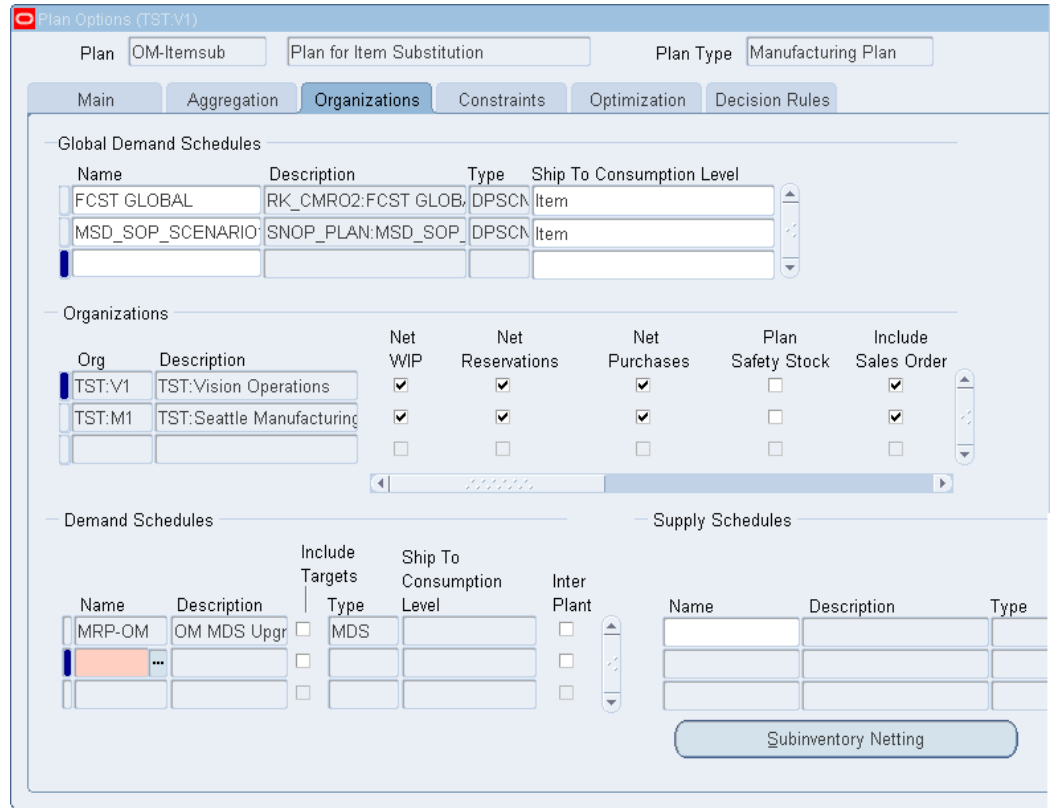

Depending on the planning mode, consider material and resource constraints as well as recommend alternate sources of supply when constraints are exceeded.

Peg purchase orders to the CM with sales orders from the CM, which are posted to the CM's inventory organization.

On the Constraints tab of the Plan Options window, select one from two modes of constrained planning: Enforce Demand Due Dates or Enforce Capacity Constraints as shown in the following figure:

### The Plan Options Window

Plan Options (TST.V1)

Plan: OM-Itemsub Plan for Item Substitution Plan Type: Manufacturing Plan

Main Aggregation Organizations **Constraints** Optimization Decision Rules

Constrained Plan

Enforce Demand Due Dates  Enforce Capacity Constraints

	Days	Weeks	Periods
Start Date	25-OCT-2005	28-NOV-2005	16-JAN-2006
Buckets	30	4	5
Resource Constraints	Yes	Yes	Yes
Supplier Capacity Constraints	Yes	Yes	Yes
Sequence Dependent Setups	No	No	No

Enforce Purchasing Lead-time Constraints

Scheduling

Minutes Bucket Size (in Days)  Demand Lateness Penalty

Hours Bucket Size (in Days)

Days Bucket Size (in Days)

Calculate Resource Requirements

Planned Resources: All Resources

Bottleneck Resource Group:

### Enforce Demand Due Dates (EDD)

An EDD specification ensures that the demand satisfied date of an order is always equal to the demand due date. The order's due date is a hard constraint. When enforcing the demand due date, Oracle Advanced Supply Chain Planning loads sources of supply to their maximum capacity and then employ alternate sources of supply (alternate bills of material and routings, alternate resources, alternate facilities, and alternate suppliers) in order to meet the demand due date of remaining orders. If the use of alternate sources does not suffice, Oracle Advanced Supply Chain Planning begins to overload the primary resources at appropriate times to avoid late orders. In this case, resources are a soft constraint that can be exceeded under special circumstances.

The advantage of this approach is that an order forecast statement to suppliers would represent the OEM's true need (order quantities and due dates). Because Oracle Advanced Supply Chain Planning considers the due dates immovable, it will create planned orders that reflect the exact customers' requirements for order quantities and due dates. The disadvantage of this approach is that the order forecast, while representing the OEM's true need, might cause a bullwhip effect. This occurs if the order forecast contains a spike in demand, which ripples across the supply chain.

### **Enforce Capacity Constraints (ECC)**

An ECC specification respects the material and resource capacities of suppliers and manufacturing facilities. Capacity is considered a hard constraint. Oracle Advanced Supply Chain Planning loads sources of supply up to, but not exceeding their maximum capacity, which may force some orders to be late. In this case the demand satisfied date is greater than the demand due date.

The advantage of an ECC specification is that the OEM maintains the flexibility to consider the capacity constraints of its internal operations and the contract manufacturer's facilities as well as the supplier's capacity. In the short term, an ECC specification acknowledges that capacity is inflexible and therefore it portrays an accurate response to the incoming demand. The disadvantage of an ECC specification is that the OEM cannot provide its suppliers with an order forecast statement that reflects its true need. The order forecast to suppliers is biased by the resource constraints at the OEM and CM. In situations where key resource constraints can be resolved over time, this is an undesirable result.

In a steady-state collaboration with suppliers and a contract manufacturer, the OEM may want to dismiss the previous supplier capacity in the next iteration of its supply chain plan because these supply commits will constrain the OEM's order forecast statement at the next plan run. For example, if the OEM has excess capacity, but is limited by the supplier's material capacity, then an ECC plan will never convey the OEM's true requirements back to the supplier. This happens because Oracle Advanced Supply Chain Planning respects the supplier's capacity prior to computing the OEM's order forecast. Therefore, the order forecast is biased by the supplier's capacity.

The OEM can also consider its capacity and the CM's capacity flexibly through specifying a bottleneck resource group. The OEM should place all key resources at the OEM and at the CM into a bottleneck resource group. Doing this allows the OEM to treat only its key resources and only the key resource of the CM as hard constraints.

### **Sourcing material from and displaying orders in the contract manufacturer's inventory organization**

The contract manufacturer's site, which is modeled as an inventory organization, appears in the navigation tree and the Planner Workbench. The supplier's name and site name distinguish this organization from other inventory organizations in the navigation tree. The Supply/Demand window in the Planner's Workbench contains additional information to indicate that inventory organization belongs to the supplier's site. When materials are sourced from the contract manufacturer's organization, the source supplier and source supplier site fields contain the company's name and the company's site name. When a planner views orders inside the contract manufacturer's organization, two fields, company and company site, contain the company's name and company's site name. The following figure displays the supplier information on Collaborative Planning navigator.

## Supplier Information On Collaborative Planning Navigator

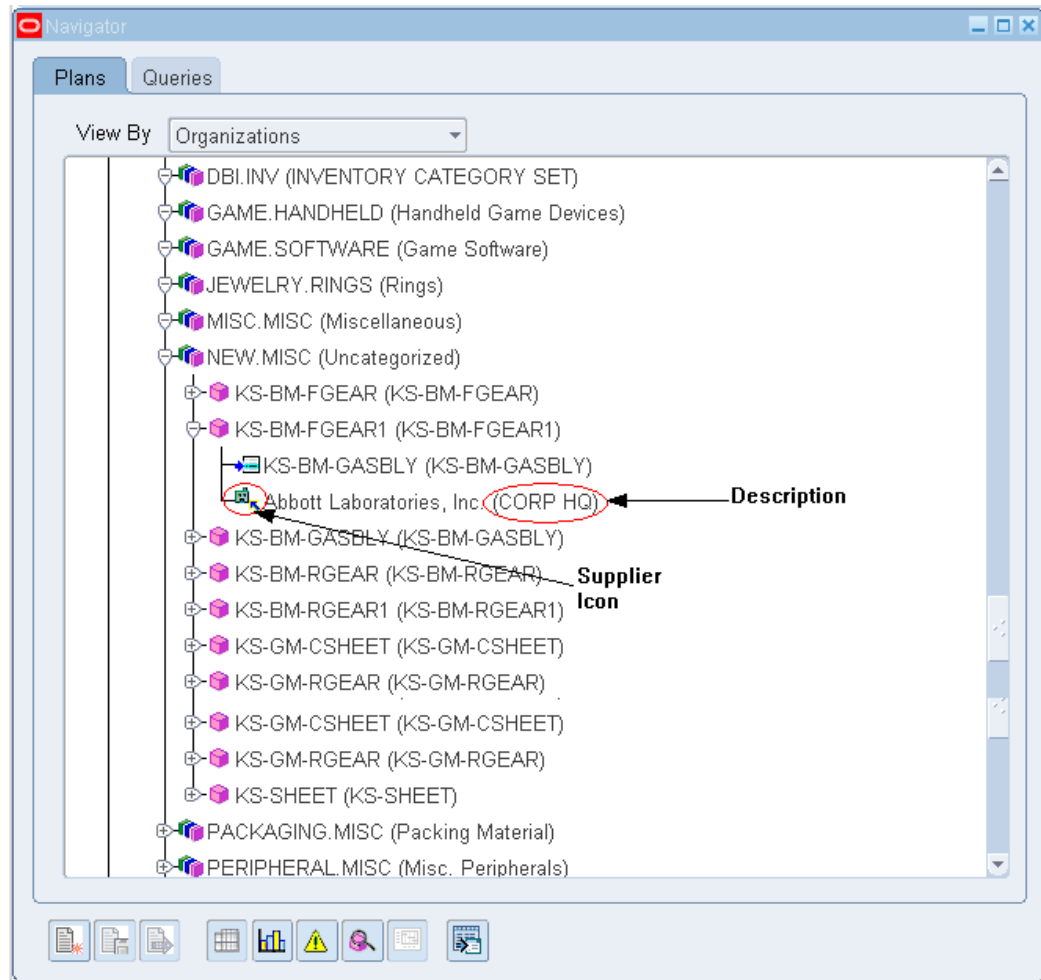

Right-click the supplier name and select the Supply/Demand option to display the information about supplies and demands and shows pegging information.

## Supply Chain Collaboration with Suppliers and Contract Manufacturers

The following sections discuss the steps for supply chain collaboration with suppliers and contract manufacturers:

### Releasing orders from the Planner's Workbench to the contract manufacturer

The OEM can release planned orders in its organization, M1, which source material from the CM. The planned orders are implemented as purchase requisitions. The release process recognizes that the source organization, CM, is the CM's site and creates the external order.

**Publish order forecast to suppliers**

After reviewing and adjusting the results of the supply chain plan, the OEM publishes its order forecast to suppliers. Use the Advanced Planning navigator to submit a request for publishing an order forecast to a selected supplier.

The OEM has the option to include purchase orders and requisitions as part of its order forecast to suppliers. When the purchase orders and requisitions are included in the order forecast along with planned orders, the OEM is communicating the total requirements being placed on the supplier. The OEM expects the supplier to consume the order forecast with actual sales orders to avoid double-counting the orders.

**OEM reviews its order forecast posted to Oracle Collaborative Planning**

The order forecast published from the supply chain plan represents the forecast from the OEM, Vision Corporation, to the contract manufacturer, Advanced Network Devices, and to the supplier, Allied Manufacturing. The OEM has the ability to communicate requirements to its first and second tier suppliers. The following figure displays the OEM organization's view of the order forecast published to the tier-2 supplier.

**Horizontal View Displaying Order Forecast Posted By OEM**

**ORACLE Collaborative Planning**  
 Home Logout Help Preferences Personalize Page Diagnostics

Home Exceptions **Planning** Admin

Horizontal View Vertical View VMI Forecast Comparison Create Order Planner W

**Horizontal View**

**Search**

Item  Customer    
 Customer Item  Supplier   
 Supplier Item  Order Type

Display Using Preference Set

**TIP** Find out how to edit the data on this page [?](#)

Table to display horizontal view search results

Item	Item Description	Customer (Site)	Supplier (Site)	Order Type	Past Due	04-Sep-2006	11-Sep-2006	18-Sep-2006
6802	Honey	Vision Corporation (TST:PR1)	Winters Supply Company (1)	<a href="#">Order forecast</a>	0.00	30	18.75	21.25
6803	Root Beer Flavor Mix	Vision Corporation (TST:PR1)	Winters Supply Company (1)	<a href="#">Order forecast</a>	0.00	6	3.75	4.25
6804	Dry Yeast	Vision Corporation (TST:PR1)	Winters Supply Company (1)	<a href="#">Order forecast</a>	0.00	20	12.5	14.166
6901	Keg	Vision Corporation (TST:PR1)	Winters Supply Company (1)	<a href="#">Order forecast</a>	0.00	48	30	34

**Supplier reviews order forecast and posts its supply commit**

The supplier reviews the order forecast from the OEM organization. The supplier can post its supply commit using a flat file to through Oracle Collaborative Planning. The following figure shows the supplier's views of its supply commit posted to the system. In this case, the supplier is unable to satisfy the OEM organization's requirements. The Supply Chain Event Manager calculates Material Shortage exceptions and notifies contacts at both the OEM organization and the supplier. The following figure shows the

supply commit posted by a supplier.

**Horizontal View Displaying Supply Commit Posted By Supplier**

The screenshot shows the Oracle Collaborative Planning interface. At the top, there are navigation tabs: Home, Exceptions, Planning, and Admin. Below these are sub-tabs: Horizontal View, Vertical View, VMI, Forecast Comparison, Create Order, and Planner Workbench. The main content area is titled 'Horizontal View' and contains a search form with fields for Item, Customer, Customer Item, Supplier, Supplier Item, and Order Type. Below the search form is a 'Display Using Preference Set' dropdown menu set to 'mfg\_default'. A 'TIP' message suggests finding out how to edit the data on this page. Below the tip is a table to display horizontal view search results, with an 'Export All' button. The table has columns for Item, Item Description, Customer (Site), Supplier (Site), Order Type, Past Due, and monthly quantities for 04-Sep-2006, 11-Sep-2006, 18-Sep-2006, and 25-Sep-2006. The table contains three rows of data.

Item	Item Description	Customer (Site)	Supplier (Site)	Order Type	Past Due	04-Sep-2006	11-Sep-2006	18-Sep-2006	25-Sep-2006
AS54888	Sentinel Standard Desktop TPD	Vision Corporation (TST:V1)	Office Supplies, Inc. (OFFICESUPPLIES)	Sales order	31.00	0.00	0.00	0.00	0.00
		Vision Corporation (TST:V1)	Vision Operations (SUPPLIER SITE)	Sales order	10.00	0.00	0.00	0.00	0.00
CLN-STD1	Chemical..	Vision Corporation (TST:V1)	Vision Operations (SUPPLIER SITE)	Sales order	10.00	0.00	0.00	0.00	0.00
CM00045	Super Server Case	Vision Corporation (TST:V1)	Office Supplies, Inc. (OFFICESUPPLIES)	Sales order	107.00	0.00	0.00	0.00	0.00

**OEM receives supplier's supply commit as capacity**

The planner at the OEM organization can receive the supplier's supply commit as capacity and replan its supply chain. In this case the supplier is unable to adjust its capacity, and the OEM must consider its alternatives.

**OEM replans its supply chain and considers alternate suppliers to overcome material constraints**

The OEM accepts the supplier's supply commit as is and chooses to rerun its supply chain plan to see the ramifications. The supply chain plan opts to source material from an alternative supplier. The OEM republishes its order forecast to suppliers after the

second iteration of its supply chain plan.

The OEM organization reviews the supply commit responses from both suppliers and sees that the material constraint is resolved.

**Respond to customers**

After receiving responses from suppliers and CMs and resolving the issues related to the materials to supply, the OEM responds to the end customers with a supply commit.

**Publish supply commit to customers**

The OEM organization can respond to its customers with a supply commit after it has resolved the material constraint with its suppliers.

**OEM reviews its supply commit to customers in Oracle Collaborative Planning**

The OEM organization reviews the response to its customer for the customer's order forecast. This completes the multi-company collaborative planning cycle.



---

## Workflow

This chapter covers the following topics:

- Using Oracle Workflow in Oracle Collaborative Planning
- Setting Up Oracle Workflow in Oracle Collaborative Planning
- Extending Workflows in Oracle Collaborative Planning
- Viewing Processes in Oracle Workflow Builder
- Seeded Data Files
- Item Types
- Workflow Processes Used In Oracle Collaborative Planning
- Functions

### Using Oracle Workflow in Oracle Collaborative Planning

Oracle Workflow manages activities, executes functions, sends notifications, maintains completed activity history, detects errors, and initiates error processes.

This appendix provides details about how Oracle Workflow is used in Oracle Collaborative Planning to best meet your business needs. This appendix also provides detailed information regarding the workflow processes that come seeded with Oracle Collaborative Planning.

For information regarding implementation and setup of Oracle Workflow, refer to the *Oracle Workflow Guide*.

### Setting Up Oracle Workflow in Oracle Collaborative Planning

The *Oracle Workflow Guide* provides a list of setup steps for Oracle Workflow, and explains the setup necessary for all modules. For example, the guide explains that an access level of 100 in Oracle Workflow Builder is necessary. Do not change this access level.

**Warning:** Oracle does not provide support if the access level of 100 is changed.

For more information about extending the seeded Oracle Collaborative Planning workflow processes, refer to.

For more information about setting up Oracle Workflow, refer to the *Oracle Workflow Guide*.

## Extending Workflows in Oracle Collaborative Planning

### Overview

This section provides guidelines for extending the Oracle Collaborative Planning seeded workflow processes to meet your business needs. Oracle supports the extension of workflows. Extensions include using existing seeded subprocesses and functions to build new workflow processes and modifying parameters of a subprocess without changing process logic.

If the Oracle Collaborative Planning seeded workflows do not meet your business processing needs, you can create new flows by using any of the following methods:

- Copy a seeded workflow, change its internal name, display name, and description in the Oracle Workflow Builder. Change the definition as desired.
- Use the seeded flows as examples to create new flows using the seeded functional processes in the Oracle Workflow Builder.
- Use the seeded flows as examples to create new flows using the seeded functional subprocesses and include your own custom activities in the Oracle Workflow Builder.

**Warning:** Oracle provides support only for its seeded activities, processes, and the types of extensions described in this manual. Oracle does not provide support for your custom activities and processes.

### Customizations

A customization changes the logic of the core application. Oracle does not support customizations to seeded workflows. Examples of customizations include:

- Changing the basic logic of a seeded process. Adding or deleting activities from a seeded process alters seeded data. However, you can copy and rename a process and then insert a notification function activity.

- Modifying the integration of Oracle Collaborative Planning with another application.

**Warning:** Customization refers to the modification of the logic of a process or subprocess, and is not supported by Oracle.

## Exceptions

The following exceptions to customization are supported by Oracle:

- You may change the item attribute OM WF Administrator to another responsibility (it defaults as SYSADMIN).
- You may tailor message bodies on seeded messages to meet your business needs.
- You can set the default error process of RETRY\_ONLY on any new functions, processes or flows that you define.

**Note:** The RETRY\_ONLY error process supports retrying only of the activity in an error state. RETRY\_ONLY does not support aborting the flow or skipping the activity in an error state. Do not specify any other error process. Do not leave the error process field empty.

For more information about extending workflows or to learn how to create your own workflows, refer to the *Oracle Workflow Guide*.

## Extending Workflow

When extending existing workflows to meet your business needs, always copy the seeded process and rename both the internal and display names before modifying the workflow. This process ensures that you do not modify seeded data. It also prevents patches containing the .wft files (which contain all the seeded flows and related information) from overriding your modifications.

**Warning:** If you modify any of Oracle's seeded workflow data, your changes are not supported. Any changes to the seeded workflow data are overwritten when a patch containing the *.wft* file is applied.

extending existing workflows to meet your business needs, always copy the seeded process and rename both the internal and display names before modifying the workflow. This process ensures that you do not modify seeded data. It also prevents patches containing the .wft files (which contain all the seeded flows and related information) from overriding your modifications.

extending existing workflows to meet your business needs, always copy the seeded

process and rename both the internal and display names before modifying the workflow. This process ensures that you do not modify seeded data. It also prevents patches containing the.wft files (which contain all the seeded flows and related information) from overriding your modifications.

## Guidelines

When extending workflow processes to meet your business needs, stay within the following guidelines:

- Always specify `RETRY_ONLY` as the default error process for any workflow activity you define.

For more details on creating and extending workflows refer to the *Oracle Workflow Guide*.

## Viewing Processes in Oracle Workflow Builder

From within the Oracle Workflow Builder you can view the different workflow processes discussed in this appendix and their associated functions, messages, subprocesses, notifications, and properties.

To view processes in Oracle Workflow Builder, complete the following steps:

1. Within Oracle Workflow Builder, select Open from the File menu, and connect to the database.
2. Expand the data source, then select the item type branch within that data source.
3. Expand the processes branch within your item type and select a process activity to display the diagram of the process in a Process window.

The following image depicts the Oracle Workflow Builder:

## Oracle Workflow Builder Window

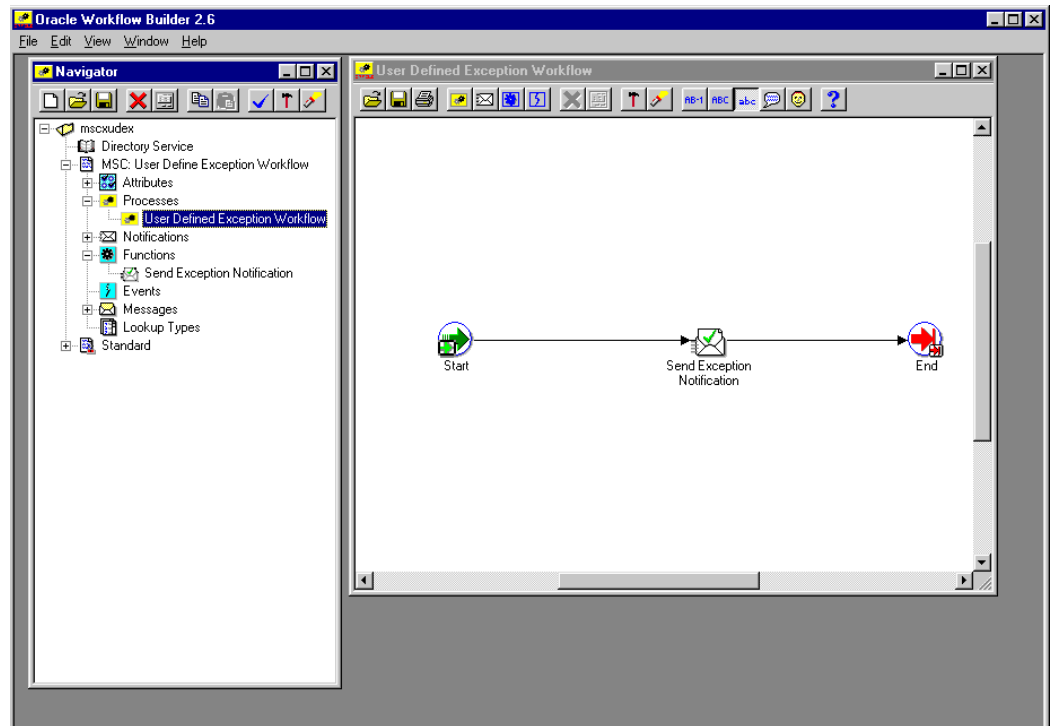

## Seeded Data Files

Each of the Oracle Collaborative Planning seeded workflows and their associated activities are contained in the following seeded data files:

- *mscxewf.wft*
- *mscxudex.wft*
- *mscxnet.wft*
- *mscxvmir.wft*
- *mscxdprf.wft*
- *mscxpbof.wft*
- *mscxpbsc.wft*
- *mscxrcsc.wft*
- *mscxscem.wft*

- *mscxascp.wft*

## Seeded Data File *mscxewf.wft*

### Item Types

The seeded data file *mscxewf.wft* contains the following item type:

- Item types for Oracle Collaborative Planning, page 12-9

### Processes

The seeded data file *mscxewf.wft* contains the following process:

- Error Notifications for Excel Import of Forecast/Supply, page 12-33

## Seeded Data File *mscxudex.wft*

### Item Types

The seeded data file *mscxudex.wft* contains the following item type:

- MSC: User Define Exception Workflow, page 12-12

### Processes

The seeded data file *mscxudex.wft* contains the following process:

- User Define Exception Workflow, page 12-12

## Seeded Data File *mscxnet.wft*

### Item Types

The seeded data file *mscxnet.wft* contains the following item type:

- Supply/Demand Mismatch, page 12-27

### Processes

The seeded data file *mscxnet.wft* contains the following process:

- Supply/Demand Mismatch, page 12-27

## Seeded Data File *mscxvmir.wft*

### Item Types

The seeded data file *mscxvmir.wft* contains the following item type:

- Oracle Collaborative Planning VMI Replenishment, page 12-9

#### Processes

The seeded data file *mscxvmir.wft* contains the following process:

- Oracle Collaborative Planning VMI Replenishment, page 12-9

### Seeded Data File *mscxcfvr.wft*

#### Item Types

The seeded data file *mscxcfvr.wft* contains the following item type: Oracle Collaborative Planning VMI Replenishment Item Type.

#### Processes

The seeded data file *mscxcfvr.wft* contains the following process: Oracle Collaborative Planning VMI Replenishment Process for VMI with Customers.

### Seeded Data File *mscxdprf.wft*

#### Item Types

The seeded data file *mscxdprf.wft* contains the following item type:

- DP Receive Forecast, page 12-31

#### Processes

The seeded data file *mscxdprf.wft* contains the following process:

- DP Receive Forecast, page 12-31

### Seeded Data File *mscxpbof.wft*

#### Item Types

The seeded data file *mscxpbof.wft* contains the following item type:

- Publish Order Forecast, page 12-25

#### Processes

The seeded data file *mscxpbof.wft* contains the following process:

- Publish Order Forecast, page 12-25

## Seeded Data File *mscxpbsc.wft*

### Item Types

The seeded data file *mscxpbsc.wft* contains the following item type:

- Publish Supply Commit, page 12-27

### Processes

The seeded data file *mscxpbsc.wft* contains the following process:

- Publish Supply Commit, page 12-45

## Seeded Data File *mscxrcsc.wft*

### Item Types

The seeded data file *mscxrcsc.wft* contains the following item type:

- Start Receive Supplier Capacity, page 12-26

### Processes

The seeded data file *mscxscem.wft* contains the following process:

- Start Receive Supplier Capacity, page 12-26

## Seeded Data File *mscxscem.wft*

### Item Types

The seeded data file *mscxscem.wft* contains the following item type:

- Start SCEM Engine, page 12-47

### Processes

The seeded data file *mscxscem.wft* contains the following process:

- Start SCEM Engine, page 12-47

## Seeded Data File *mscxascp.wft*

### Item Types

The seeded data file *mscxascp.wft* contains the following item type:

- Start ASCP Engine, page 12-41



## Processes

The seeded data file *mscxascp.wft* contains the following process:

- Start ASCP Engine, page 12-41

## Item Types

The following section discusses the different item types used in Oracle Collaborative Planning seeded workflows. Oracle Collaborative Planning contains the following item types:

- Oracle Collaborative Planning VMI Replenishment, page 12-9
- MSC: User Define Exception Workflow, page 12-12
- Start ASCP Engine, page 12-25
- Start SCEM Engine, page 12-25
- Publish Order Forecast, page 12-25
- Start Receive Supplier Capacity, page 12-26
- Publish Supply Commit, page 12-27
- Supply/Demand Mismatch, page 12-27
- Workflows for Oracle Collaborative Planning, page 12-30
- DP Receive Forecast, page 12-31
- Standard

The different items types are contained in different seeded data workflow files.

To learn more about the Standard item type, refer to the *Oracle Workflow Guide*.

## Oracle Collaborative Planning VMI Replenishment

Currently there is two processes associated with Oracle Collaborative Planning VMI Replenishment:

- Oracle Collaborative Planning VMI Replenishment with Suppliers, page 12-37
- Oracle Collaborative Planning VMI Replenishment with Customers

The Oracle Collaborative Planning VMI Replenishment item type has several attributes associated with it. These attributes reference information in the Oracle Collaborative

Planning application tables. The attributes are used and maintained by function activities and notification activities throughout the process. The following table lists the Oracle Collaborative Planning VMI Replenishment item type attributes:

<b>Display Name</b>	<b>Description</b>	<b>Type</b>	<b>Length/Format/ Lookup Type/Frame Target</b>
Replenish Time Fence	The replenishment time fence multiplier.	Number	None
Auto Release Flag		Number	None
Inventory Item ID	The inventory identification number for the item.	Number	None
Organization ID	The organization identification number for the item.	Number	None
Seller Name	The selling company's name.	Role	None
Buyer Name	The buying company's name.	Role	None
Plan ID	Identification number of your plan.	Number	None
Sr Instance ID	Identification number of the SR Instance.	Number	None
Supplier ID	Identification number for the supplier.	Number	None
Supplier Site ID	Identification number for the supplier site.	Number	None
Allocation Percent	Allocation percent number.	Number	None
Order Quantity	Quantity ordered.	Number	None
Total Allocated Onhand	The total amount of allocated on-hand inventory.	Number	None
Item Name	The name of the item.	Text	None

<b>Display Name</b>	<b>Description</b>	<b>Type</b>	<b>Length/Format/ Lookup Type/Frame Target</b>
Requisition Transaction ID	Identification number of the requisition transaction.	Number	None
SCE Organization ID	Identification number of the SCE organization.	Number	None
SCE Supplier ID	Identification number of the SCE supplier.	Number	None
SCE Supplier Site ID	Identification number of the SCE supplier site.	Number	None
Customer Name	The customer's name.	Text	None
Customer Site Name	The name of the customer site.	Text	None
Supplier Name	The name of the supplier.	Text	None
Supplier Site Name	The name of the supplier site.	Text	None
Replenishment Transaction ID	Identification number of the replenishment.	Number	None
Supplier Item Name	Name of an item provided by the supplier.	Text	None
Customer Item Name	Name of an item provided by the customer.	Text	None
Item Description	A text description of an item.	Text	None
Allocated Onhand Quantity	The amount of allocated on-hand inventory.	Number	None
Minimum MinMax Quantity	The minimum amount of an item required in inventory before replenishment is necessary.	Number	None

<b>Display Name</b>	<b>Description</b>	<b>Type</b>	<b>Length/Format/ Lookup Type/Frame Target</b>
Maximum MinMax Quantity	The maximum amount of inventory that can be held or replenished.	Number	None
Customer UOM Code	The customer's code for units of measure.	Text	None
Supplier UOM Code	The supplier's code for units of measure.	Text	None

## MSC: User Define Exception Workflow

Currently there is one process associated with MSC: User Define Exception Workflow:

- User Defined Exception Workflow, page 12-34

The MSC: User Define Exception Workflow item type has several attributes associated with it. These attributes reference information in the Oracle Collaborative Planning application tables. The attributes are used and maintained by function activities and notification activities throughout the process. The following table lists the MSC: User Define Exception Workflow item type attributes:

<b>Display Name</b>	<b>Description</b>	<b>Type</b>	<b>Length/Format/ Lookup Type/Frame Target</b>
Exception Group	The assigned group for the user-defined exception.	Text	80
Exception Name	The user-assigned name of the exception.	Text	80
Exception Type	The type of the user-defined exception.	Number	None
Exception Detail ID	Identification number of the user-defined exception detail.	Number	None
Transaction ID	Identification number of the transaction.	Number	None

<b>Display Name</b>	<b>Description</b>	<b>Type</b>	<b>Length/Format/Look up Type/Frame Target</b>
Customer Transaction ID	The customer's transaction identification number.	Number	None
Supplier Transaction ID	The supplier's transaction identification number.	Number	None
Details URL	The URL for the exception details.	URL	Full Window
Notification Title	The title assigned to the exception.	Text	2000
Exception Exist	Indicates whether any exceptions exist.	Number	None
Company: Days Early	Days early at the company.	Number	None
Company: Days Late	Days late for the company.	Number	None
Company: Quantity Excess	Quantity excess for the company.	Number	None
Company: Quantity Shortage	Quantity shortage for the company.	Number	None
Customer: End Order Release Number	End order release number for the customer.	Text	240
Customer: Order Number	Customer order number.	Text	240
Company: Average Annual Demand	Average annual demand for the company.	Number	None
Company: Bill Of Lading	The company's bill of lading.	Text	30
Company: Bucket Type	The bucket type for the company.	Text	20
Company: Carrier Code	The carrier code for the company.	Text	30

<b>Display Name</b>	<b>Description</b>	<b>Type</b>	<b>Length/Format/Look up Type/Frame Target</b>
Company: Category	The category for the company.	Text	200
Company: Need By Date	The need by date for the company.	Date	None
Company: Published Date	The published date for the company.	Date	None
Company: Document Owner Site	The document owner site for the company.	Text	40
Company: Receipt Date	The receipt date for the company.	Date	None
Company: Request Date	The request date for the company.	Date	None
Company: Container Quantity	The container quantity for the company.	Number	None
Company: Container Type	The container type for the company.	Text	20
Company: Customer Address	The customer address for the company.	Text	240
Customer: Item Description	The item description for the customer.	Text	240
Company: Customer Item	The customer item for the company.	Text	240
Company: Customer Site	The customer site for the company.	Text	40
Customer: Average Annual Demand	The average annual demand for the customer.	Number	None
Customer: Bill Of Lading Number	The bill of lading number for the customer.	Text	30

<b>Display Name</b>	<b>Description</b>	<b>Type</b>	<b>Length/Format/Look up Type/Frame Target</b>
Customer: Bucket Type	The bucket type for the customer.	Text	10
Customer: Carrier Code	The carrier code for the customer.	Text	30
Customer: Container Quantity	The container quantity for the customer.	Number	None
Customer: Container Type	The container type for the customer.	Text	20
Customer: Designator	The designator for the customer.	Text	100
Customer: End Order Line Number	The end order line number for the customer.	Text	20
Customer: End Order Number	The end order number for the customer.	Text	240
Customer: End Order Publisher Name	The end order publisher name for the customer.	Text	255
Customer: End Order Publisher Site Name	The end order publisher site name for the customer.	Text	30
Customer: Inventory Status	The inventory status for the customer.	Text	20
Customer: Item Category	The item category for the customer.	Text	250
Customer: Line Code	The line code for the customer.	Text	30
Customer: New Schedule Date	The new schedule date for the customer.	Date	None
Company: Order Placement Date	The order placement date for the company.	Date	None

<b>Display Name</b>	<b>Description</b>	<b>Type</b>	<b>Length/Format/Look up Type/Frame Target</b>
Customer: Order Line Number	The order line number for the customer.	Text	20
Company: Originally Promised Date	The original promise date for the company.	Date	None
Customer: Owning Site	The owning site for the customer.	Text	30
Customer: Planner Code	The planner code for the customer.	Text	10
Customer: Planning Group	The planning group for the customer.	Text	30
Customer: Posting Party	The posting party for the customer.	Text	255
Customer: Primary Quantity	The primary quantity for the customer.	Number	None
Customer: Primary UOM	The primary unit of measure for the customer.	Text	3
Customer: Project Number	The project number for the customer.	Text	30
Company: Customer Quantity	The customer quantity for the company.	Number	None
Customer: Receipt Date	The receipt date for the customer.	Date	None
Customer: Order Release Number	The order release number for the customer.	Text	20
Customer: Release Status	The release status for the customer.	Number	None
Customer: Request Date	The request date for the customer.	Date	None



<b>Display Name</b>	<b>Description</b>	<b>Type</b>	<b>Length/Format/Look up Type/Frame Target</b>
Customer: Serial Number	The serial number for the customer.	Text	255
Company: Ship Date	The ship date for the company.	Date	None
Customer: Ship From Address	The ship from address for the customer.	Text	240
Customer: Ship From Party	The ship from party for the customer.	Text	255
Customer: Ship From Party Site	The ship from party site for the customer.	Text	30
Customer: Shipping Method	The shipping method for the customer.	Text	30
Customer: Ship To Address	The ship to address for the customer.	Text	240
Customer: Ship To Party	The ship to party for the customer.	Text	255
Customer: Ship To Party Site	The ship to party site for the customer.	Text	30
Customer: Task Number	The task number for the customer.	Text	30
Customer: Trading Partner UOM Code	The trading partner unit of measure code for the customer.	Text	3
Customer: Tracking Number	The tracking number for the customer.	Text	100
Customer: Unit Number	The unit number for the customer.	Text	30

<b>Display Name</b>	<b>Description</b>	<b>Type</b>	<b>Length/Format/Look up Type/Frame Target</b>
Customer: UOM Code	The unit of measure code for the customer.	Text	3
Customer: Vehicle Number	The vehicle number for the customer.	Text	30
Customer: Document Version	The document version for the customer.	Text	40
Company: Customer	The company's customer.	Text	250
Company: Designator	The company's designator.	Text	100
Company: End Order Line Number	The end order line number for the company.	Text	20
Company: End Order Number	The end order number for the company.	Text	240
Company: End Order Publisher Name	The end order publisher name for the company.	Text	255
Company: End Order Publisher Site Name	The end order publisher site name for the company.	Text	30
Company: End Order Release Number	The end order release number for the company.	Text	20
Company: Inventory Status	The company's inventory status.	Text	20
Company: Item Description	The company's item description.	Text	240
Notification Body	The body text of the notification being sent.	Text	4000
Company: Line Code	The line code for the company.	Text	30

<b>Display Name</b>	<b>Description</b>	<b>Type</b>	<b>Length/Format/Look up Type/Frame Target</b>
Company: Line Number	The line number for the company.	Text	240
Company: Order Number	The order number for the company.	Text	240
Company: Release Number	The release number for the company.	Text	20
Company: Owner Item Description	The owner item description for the company.	Text	240
Company: Owner Item	The owner item for the company.	Text	250
Company: Owning Site Name	The owning site name for the company.	Text	30
Company: Planner Code	The company's planner code.	Text	30
Company: Planning Group	The planning group for the company.	Text	30
Company: Posting Party Name	The company's posting party's name.	Text	255
Company: Project Number	The project number for the company.	Text	30
Company: Publisher Address	The publisher address for the company.	Text	240
Company: Document Owner	The company's document owner.	Text	255
Company: Order Type Desc	The company's order type description.	Text	80
Company: Quantity	The quantity for the company.	Number	None

<b>Display Name</b>	<b>Description</b>	<b>Type</b>	<b>Length/Format/Look up Type/Frame Target</b>
Company: Release Status	The release status for the company.	Number	None
Company: Serial Number	The serial number for the company.	Text	40
Company: Ship From Address	The ship from address for the company.	Text	240
Company: Shipping Party	The shipping part for the company.	Text	255
Company: Ship from party site	The ship from party site for the company.	Text	40
Company: Ship Method	The ship method for the company.	Text	30
Company: Ship To Address	The ship to address for the company.	Text	240
Company: Ship To Party	The ship to party for the company.	Text	255
Company: Ship to Party site	The ship to party site for the company.	Text	40
Supplier: Average Annual Demand	The average annual demand for the supplier.	Number	None
Supplier: Bill Of Lading Number	The bill of lading for the supplier.	Text	30
Supplier: Bucket Type	The bucket type for the supplier.	Text	10
Supplier: Carrier Code	The carrier code for the supplier.	Text	30
Supplier: Item Category	The item category for the supplier.	Text	250

<b>Display Name</b>	<b>Description</b>	<b>Type</b>	<b>Length/Format/Look up Type/Frame Target</b>
Supplier: Container Quantity	The container quantity for the supplier.	Number	None
Supplier: Container Type	The container type for the supplier.	Text	20
Supplier: Designator	The designator for the supplier.	Text	100
Supplier End Order Number	The end order number for the supplier.	Text	240
Supplier: End Order Line Number	The end order line number for the supplier.	Text	20
Supplier: End Order Publisher Name	The end order publisher name for the supplier.	Text	255
Supplier: End Order Publisher Site Name	The end order publisher site name for the supplier.	Text	30
Supplier End Order Release Number	The end order release number for the supplier.	Text	20
Supplier: Full Lead time	The full lead time for the supplier.	Text	20
Supplier: Inventory Status	The inventory status for the supplier.	Text	20
Supplier: Line Code	The line code for the supplier.	Text	30
Supplier: New Schedule Date	The new schedule date for the supplier.	Date	None
Supplier: Order Number	The order number for the supplier.	Text	240
Supplier: Order Line Number	The order line number for the supplier.	Text	20

<b>Display Name</b>	<b>Description</b>	<b>Type</b>	<b>Length/Format/Look up Type/Frame Target</b>
Supplier: Originally Promised Date	The original promise date for the supplier.	Date	None
Supplier: Owning Site Name	The owning site name for the supplier.	Text	30
Supplier: Planner Code	The planner code for the supplier.	Text	10
Supplier: Planing Group	The planning group for the supplier.	Text	30
Supplier: Posting Party	The posting party for the supplier.	Text	255
Supplier: Primary Quantity	The primary quantity for the supplier.	Number	None
Supplier: Primary UOM	The primary unit of measure for the supplier.	Text	3
Supplier: Project Number	The project number for the supplier.	Text	30
Supplier: Supplier Quantity	The supplier quantity for the supplier.	Number	None
Supplier: Receipt Date	The receipt date for the supplier.	Date	None
Supplier: Release Order Number	The release order number for the supplier.	Text	20
Supplier: Release Status	The release status for the supplier.	Number	None
Supplier: Request Date	The request date for the supplier.	Date	None
Supplier: Serial Number	The serial number for the supplier.	Text	255
Supplier: Ship Date	The ship date for the supplier.	Date	None

<b>Display Name</b>	<b>Description</b>	<b>Type</b>	<b>Length/Format/Look up Type/Frame Target</b>
Supplier: Ship From Address	The ship from address for the supplier.	Text	240
Supplier: Ship From Party	The ship from party for the supplier.	Text	255
Supplier: Ship From Party Site	The ship from party site for the supplier.	Text	30
Supplier: Ship Method	The ship method for the supplier.	Text	30
Supplier: Ship To Address	The ship to address for the supplier.	Text	240
Supplier: Ship To Party	The ship to party for the supplier.	Text	255
Supplier: Ship To Party Site	The ship to party site for the supplier.	Text	30
Supplier: Task Number	The task number for the supplier.	Text	30
Supplier: Trading Partner UOM Code	The trading partner unit of measure for the supplier.	Text	3
Supplier: Tracking number	The tracking number for the supplier.	Text	100
Supplier: Unit Number	The unit number for the supplier.	Text	30
Supplier: UOM Code	The unit of measure code for the supplier.	Text	3
Supplier: Vehicle Number	The vehicle number for the supplier.	Text	30
Supplier: Document Version	The document version for the supplier.	Text	40

<b>Display Name</b>	<b>Description</b>	<b>Type</b>	<b>Length/Format/Look up Type/Frame Target</b>
Company: Supplier Address	The supplier address for the company.	Text	240
Supplier: Item Description	The item description for the supplier.	Text	240
Company: Supplier Item	The supplier item for the company.	Text	250
Company: Supplier	The company's supplier.	Text	255
Company: Supplier Site	The company's supplier's site.	Text	30
Company: Task Number	The company's task number.	Text	30
Company: Trading Partner Item Description	The company's trading partner item description.	Text	240
Company: Trading Partner UOM	The company's trading partner unit of measure.	Text	3
Company: Tracking Number	The tracking number for the company.	Text	240
Company: Order Type	The order type for the company.	Number	None
Company: UOM	The unit of measure used by the company.	Text	3
Company: Vehicle Number	The company's vehicle number.	Text	30
Company: Version	The version for the company.	Text	240
Company: Unit Number	The company's unit number.	Text	30



## Start ASCP Engine

This item type manages the Start ASCP Engine workflow process.

Currently there is one process associated with Start ASCP Engine:

- Start ASCP Engine, page 12-41

The Start ASCP Engine item type has one attribute associated with it. This attribute references information in the Oracle Collaborative Planning application tables. The attribute is used and maintained by function activities and notification activities throughout the process. The following table lists the Start ASCP Engine item type attribute:

Display Name	Description	Type	Length/Format/Lookup Type/Frame Target
Constrained Plan Flag	The constrained plan flag number.	Number	None

## Start SCEM Engine

Currently there is one process associated with Start SCEM Engine:

- Start SCEM Engine, page 12-47

The Start SCEM Engine item type has no attributes associated with it.

## Publish Order Forecast

Currently there is one process associated with Publish Order Forecast:

- Publish Order Forecast, page 12-44

The Publish Order Forecast item type has one attribute associated with it. This attribute references information in the Oracle Collaborative Planning application tables. The attribute is used and maintained by function activities and notification activities throughout the process. The following table lists the Publish Order Forecast item type attribute:

Display Name	Description	Type	Length/Format/Lookup Type/Frame Target
--------------	-------------	------	--

Display Name	Description	Type	Length/Format/Loookup Type/Frame Target
Plan ID	The identification number for the plan.	Number	None

## Start Receive Supplier Capacity

Currently there is one process associated with Start Receive Supplier Capacity:

- Start Receive Supplier Capacity, page 12-57

The Start Receive Supplier Capacity item type has several attributes associated with it. These attributes reference information in the Oracle Collaborative Planning application tables. The attributes are used and maintained by function activities and notification activities throughout the process. The following table lists the Start Receive Supplier Capacity item type attributes:

Display Name	Description	Type	Length/Format/Loookup Type/Frame Target
Start Date	The specified start date.	Date	None
End Date	The specified end date.	Date	None
Supplier ID	The identification number for the supplier.	Number	None
Notification to Trading Partner	The notification issued to a trading partner.	Text	None
Trading Partner Name	The name of your trading partner.	Text	None
Notification Recipient Role	The role of the assigned recipient of a notification.	Text	None
Request ID	The identification number of the request.	Number	None

## Publish Supply Commit

Currently there is one process associated with Publish Supply Commit:

- Publish Supply Commit, page 12-45

The Publish Supply Commit item type has one attribute associated with it. This attribute references information in the Oracle Collaborative Planning application tables. The attribute is used and maintained by function activities and notification activities throughout the process. The following table lists the Publish Supply Commit item type attribute:

Display Name	Description	Type	Length/Format/Lookup Type/Frame Target
Plan ID	The identification number of the specified plan.	Number	None

## Supply/Demand Mismatch

Currently there is one process associated with Supply/Demand Mismatch:

- Supply/Demand Mismatch, page 12-35

The Supply/Demand Mismatch item type has several attributes associated with it. These attributes reference information in the Oracle Collaborative Planning application tables. The attributes are used and maintained by function activities and notification activities throughout the process. The following table lists the Supply/Demand Mismatch item type attributes:

Display Name	Description	Type	Length/Format/Lookup Type/Frame Target
Salute	Salute	Text	None
Slogan	Slogan	Text	None
Company ID	The company's identification number.	Number	None
Company Name	The company's name.	Text	None

<b>Display Name</b>	<b>Description</b>	<b>Type</b>	<b>Length/Format/Look up Type/Frame Target</b>
Company Site ID	The identification number of the company site.	Number	None
Company Site Name	The company site name.	Text	None
Supplier ID	The supplier's identification number.	Number	None
Supplier Name	The supplier's name.	Text	None
Supplier Site ID	The supplier site identification number.	Number	None
Supplier Site Name	The name of the supplier site.	Text	None
Supplier Item Name	The supplier's name of the item.	Text	None
Customer ID	The customer's identification number.	Number	None
Customer Name	The customer's name.	Text	None
Customer Site ID	The identification number of the customer site.	Number	None
Customer Site Name	The name of the customer site.	Text	None
Customer Item Name	The customer's name of the item.	Text	None
Item ID	The item identification number.	Number	None
Item Name	The item name.	Text	None
Item Description	The item description.	Text	None
Exception Type	The type assigned to the exception.	Number	None

<b>Display Name</b>	<b>Description</b>	<b>Type</b>	<b>Length/Format/Look up Type/Frame Target</b>
Quantity	The item quantity.	Number	None
Quantity1		Number	None
Quantity2		Number	None
Transaction ID1		Number	None
Transaction ID2		Number	None
Threshold		Number	None
Lead Time	The specified necessary lead time.	Number	None
Item Min Qty	Minimum item quantity	Number	None
Item Max Qty	Maximum item quantity	Number	None
Date1	The actual date	Date	None
Date2		Date	None
Date3		Date	None
Order Creation Date1		Date	None
Order Creation Date2		Date	None
Forward To Username	The planner's username.	Text	100
Notification Message Name	The name of the notification message to be sent.	Text	None
Event Name	The name of the event.	Text	None

<b>Display Name</b>	<b>Description</b>	<b>Type</b>	<b>Length/Format/Look up Type/Frame Target</b>
Item Key	The item key.	Text	None
Exception Description	The description of the exception.	Text	None
Order Number	The order number.	Text	None
Release Number	The release number.	Text	None
Line Number	The line number.	Text	None
End Order Number	The end order number.	Text	None
End Order Release Number	The end order release number.	Text	None
End Order Line Number	The end order line number.	Text	None
Planner	The planner name.	Text	None

## Workflows for Oracle Collaborative Planning

Currently there is one process associated with Workflows for Oracle Collaborative Planning:

- Error Notifications for Excel Import of Forecast/Supply, page 12-33

The Workflows for Oracle Collaborative Planning item type has several attributes associated with it. These attributes reference information in the Oracle Collaborative Planning application tables. The attributes are used and maintained by function activities and notification activities throughout the process. The following table lists the Workflows for Oracle Collaborative Planning item type attributes:

<b>Display Name</b>	<b>Description</b>	<b>Type</b>	<b>Length/Format/Look up Type/Frame Target</b>
Forward to Username	The planner's username.	Text	100

Display Name	Description	Type	Length/Format/Look up Type/Frame Target
Error message	The name used for the error message.	Text	240
Document Creation Date	The date of the document creation.	Date	None
Error list	String containing the errors for the planner.	Text	4000
Transaction type	The transaction type.	Text	100
Plan name	The name of the plan.	Text	240
Number of Planners	Contains the number of planners in an organization.	Number	None
Partner Site ID	The identification number of the partner site.	Number	None
Header ID	Parent header identification number.	Number	None
Number of visits	The number of visits	Number	None
Publisher's organization	The publisher's organization.	Text	255
File to Upload	Name of the file to be uploaded.	Text	80

## DP Receive Forecast

Currently there is one process associated with DP Receive Forecast:

- DP Receive Forecast, page 12-42

The DP Receive Forecast item type has several attributes associated with it. These attributes reference information in the Oracle Collaborative Planning application tables. The attributes are used and maintained by function activities and notification activities throughout the process. The following table lists the DP Receive Forecast item type attributes:

<b>Display Name</b>	<b>Description</b>	<b>Type</b>	<b>Length/Format/Look up Type/Frame Target</b>
Customer ID	The customer identification number.	Number	None
Start Date	The workflow start date.	Date	None
Notification to Trading Partner	The notification text sent to the trading partner.	Text	None
Trading Partner Name	The name of the trading partner	Text	None
Notification Recipient Role	The role of the notification's recipient.	Text	None
Horizon Days	The amount of days on the horizon.	Number	None
Request ID	The request identification number.	Number	None

## Workflow Processes Used In Oracle Collaborative Planning

Oracle Collaborative Planning comes seeded with the following workflow processes:

- Error Notifications for Excel Import of Forecast/Supply, page 12-33
- User Define Exception Workflow, page 12-34
- Supply/Demand Mismatch, page 12-35
- Error Notifications for Excel Import of Forecast/Supply, page 12-33
- Oracle Collaborative Planning VMI Replenishment, page 12-37
- Start ASCP Engine, page 12-41
- DP Receive Forecast, page 12-42
- Publish Order Forecast, page 12-44
- Publish Supply Commit, page 12-45



- Start Receive Supplier Capacity, page 12-46
- Start SCEM Engine, page 12-47

## Error Notifications for Excel Import of Forecast/Supply

This process sends notification when you conduct flat file or XML loads to Oracle Collaborative Planning and when loading a supply/demand flat file or loading an XML file adhering to *000\_sync\_forecast\_001.dtd*.

The Error Notifications for Excel Import of Forecast/Supply process is contained in the Seeded Data File *mscxewf.wft*, page 12-6 and is associated with the Workflows for Oracle Collaborative Planning, page 12-30 item type.

### Summary of the Error Notifications for Excel Import of Forecast/Supply Process

To view the properties of the Error Notifications for Excel Import of Forecast/Supply process, select the process in the navigator tree and then select Properties from the Edit menu. This process is runnable, which indicates that it can be assigned to a transaction type.

The Details property page of the process activity indicates that Error Notifications for Excel Import of Forecast/Supply has an error item type of WFERROR. This item type is associated with the RETRY\_ONLY error process. The purpose of this error handling process is to alert an administrator when an error occurs in a process and prompt the administrator to retry the process in error. This error process is initiated only when an unexpected error with Oracle Workflow is encountered in the process.

When you display the Process window for the Error Notifications for Excel Import of Forecast/Supply, you see that the process consists of 3 unique activities, which comprise the 3 nodes that appear in the workflow diagram. The following diagram depicts the Error Notifications for Excel Import of Forecast/Supply. Each node of this process is numbered for referencing.

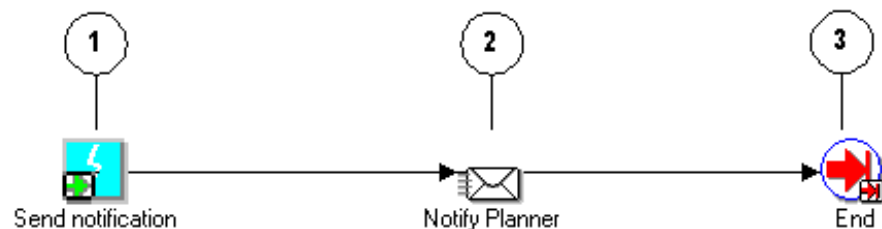

The Error Notifications for Excel Import of Forecast/Supply workflow begins at node 1 with the Send Notification event.

The workflow then proceeds to the Notify Planning notification activity in node 2. After

notification is sent, the process continues on to the End, page 12-60 activity in node 3.

### **Error Notifications for Excel Import of Forecast/Supply Activities**

The following table provides descriptions of each activity in Error Notifications for Excel Import of Forecast/Supply.

For more information about the individual activities, refer to Functions, page 12-49.

<b>Activity</b>	<b>Function</b>	<b>Result Type</b>	<b>Required</b>
End, page 12-60	WF_STANDARD.NOOP	None	Yes

### **User Define Exception Workflow**

In this process, a user-defined custom exception is run and generates a number of results (exceptions). For each generated exception, a notification is sent to the recipient of the exception. The workflow is called for each generated exception. The recipients and subject of the notification can be specified in the Custom Exceptions recipients page.

The User Define Exception Workflow process is contained in the Seeded Data File mscxudex.wft, page 12-6 and is associated with the User Define Exception Workflow, page 12-12 item type.

### **Summary of the User Define Exception Workflow Process**

To view the properties of the User Define Exception Workflow process, select the process in the navigator tree and then select Properties from the Edit menu. This process is runnable.

The Details property page of the process activity indicates that User Define Exception Workflow has an error item type of WFERROR. This item type is associated with the RETRY\_ONLY error process. The purpose of this error handling process is to alert an administrator when an error occurs in a process and prompt the administrator to retry the process in error. This error process is initiated only when an unexpected error with Oracle Workflow is encountered in the process.

When you display the Process window for the User Define Exception Workflow, you see that the process consists of 3 unique activities, which comprise the 3 nodes that appear in the workflow diagram. The following diagram depicts the User Define Exception Workflow. Each node of this process is numbered for referencing.

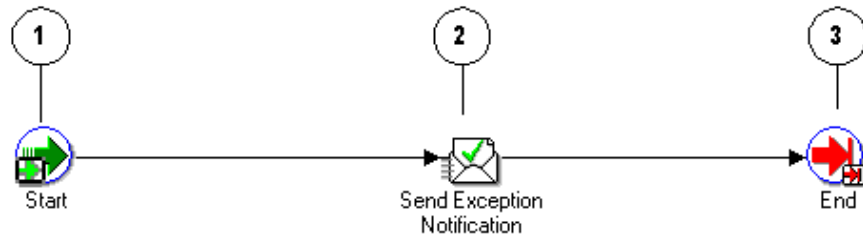

The User Define Exception Workflow workflow begins at node 1 with the Start, page 12-61 activity.

The workflow then proceeds to the Send Exception Notification, page 12-55 activity in node 2. After the activity is complete, the process continues on to the End, page 12-60 activity in node 3.

### User Define Exception Workflow Activities

The following table provides descriptions of each activity in User Define Exception Workflow.

For more information about individual activities, refer to Functions, page 12-49.

Activity	Function	Result Type	Required
Start, page 12-61	WF_STANDARD.NOOP	None	Yes
Send Exception Notification, page 12-55	MSC_X_USER_EXCEP_GEN.SEN D_NTF	None	Yes
End, page 12-60	WF_STANDARD.NOOP	None	Yes

## Supply/Demand Mismatch

This process is the Supply Chain Event Manager Exceptions notification workflow.

The Supply/Demand Mismatch process is contained in the Seeded Data File mscxnet.wft, page 12-6 and is associated with the Supply/Demand Mismatch, page 12-27 item type.

### Summary of the Supply/Demand Mismatch Process

To view the properties of the Supply/Demand Mismatch process, select the process in

the navigator tree and then select Properties from the Edit menu. This process is runnable.

The Details property page of the process activity indicates that Supply/Demand Mismatch has an error item type of WFERROR. This item type is associated with the RETRY\_ONLY error process. The purpose of this error handling process is to alert an administrator when an error occurs in a process and prompt the administrator to retry the process in error. This error process is initiated only when an unexpected error with Oracle Workflow is encountered in the process.

When you display the Process window for the Supply/Demand Mismatch, you see that the process consists of 3 unique activities, which comprise the 3 nodes that appear in the workflow diagram. The following diagram depicts the Supply/Demand Mismatch workflow. Each node of this process is numbered for referencing.

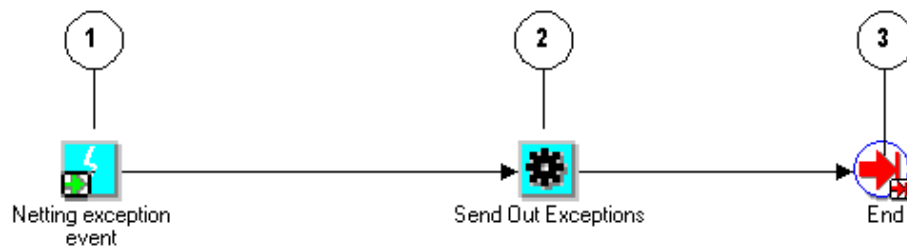

The Supply/Demand Mismatch workflow begins at node 1 with the Netting Exception Event.

The workflow then proceeds to the Send Out Exceptions, page 12-58 activity in node 2. After the activity is complete, the process continues on to the End, page 12-60 activity in node 3.

### Supply/Demand Mismatch Activities

The following table provides descriptions of each activity in Supply/Demand Mismatch.

For more information about individual activities, refer to Functions, page 12-49.

Activity	Function	Result Type	Required
Start, page 12-61	WF_STANDARD.NOOP	None	Yes
Send Out Exceptions, page 12-58	WF_STANDARD.NOTIFY	None	Yes

Activity	Function	Result Type	Required
End, page 12-60	WF_STANDARD.NOOP	None	Yes

## Oracle Collaborative Planning VMI Replenishment

### For Supplier-Facing VMI Replenishment

This process is the workflow for the VMI replenishment engine for supplier-facing VMI replenishment.

The Oracle Collaborative Planning VMI Replenishment process for supplier-facing VMI replenishment is contained in the Seeded Data File mscxvmir.wft, page 12-6 and is associated with the Oracle Collaborative Planning VMI Replenishment, page 12-9 item type.

#### Summary of the Oracle Collaborative Planning VMI Replenishment Process

To view the properties of the Oracle Collaborative Planning VMI Replenishment process, select the process in the navigator tree and then select Properties from the Edit menu. This process is runnable.

The Details property page of the process activity indicates that Oracle Collaborative Planning VMI Replenishment has an error item type of WFERROR. This item type is associated with the RETRY\_ONLY error process. The purpose of this error handling process is to alert an administrator when an error occurs in a process and prompt the administrator to retry the process in error. This error process is initiated only when an unexpected error with Oracle Workflow is encountered in the process.

When you display the Process window for Oracle Collaborative Planning VMI Replenishment, you see that the process consists of 9 unique activities, which comprise the 9 nodes that appear in the workflow diagram. The following diagram depicts the Oracle Collaborative Planning VMI Replenishment. Each node of this process is numbered for referencing.

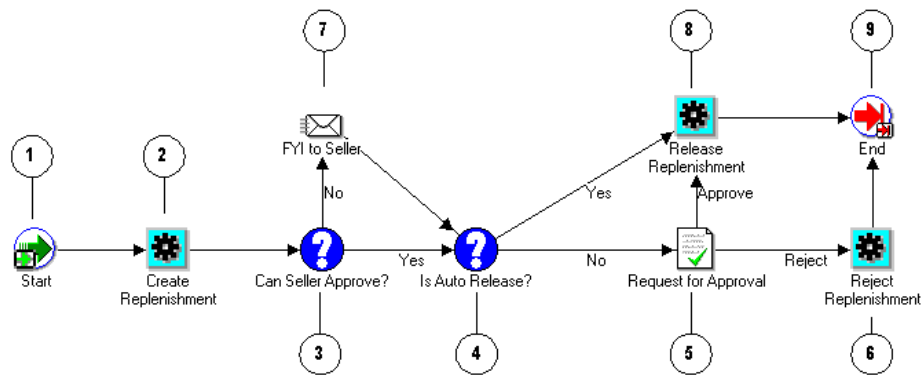

The Oracle Collaborative Planning VMI Replenishment workflow begins at node 1 with the Start, page 12-61 activity.

The workflow then proceeds to the Create Replenishment, page 12-49 activity at node 2. After the activity is complete, the process continues to the Can Seller Approve?, page 12-49 activity at node 3. If there is a Yes result, the process moves to the Is Auto Release?, page 12-50 activity at node 4. If there is a No result, the process moves to the Request for Approval message activity at node 5. If approval is granted, the process moves to Release Replenishment, page 12-51 at node 8, then moves on to the End, page 12-60 activity in node 9. If the request is rejected, the process moves to the Reject Replenishment, page 12-54 at node 6, and then to the End, page 12-60 activity in node 9.

#### Oracle Collaborative Planning VMI Replenishment Activities

The following table provides descriptions of each activity in Oracle Collaborative Planning VMI Replenishment.

For more information about individual activities, refer to Functions, page 12-49.

Activity	Function	Result Type	Required
Start, page 12-61	WF_STANDARD.NOOP	None	Yes
Create Replenishment, page 12-49	MSC_X_REPLENISH.VMI_REPLE NISH	None	Yes
Can Seller Approve?, page 12-49	MSC_X_REPLENISH.IS_SELLER_ APPROVE	Yes/No	Yes
Is Auto Release?, page 12-50	MSC_X_REPLENISH.IS_AUTO_R ELEASE	Yes/No	Yes

Activity	Function	Result Type	Required
Release Replenishment, page 12-51	MSC_X_REPLENISH.VMI_RELEA SE	None	Yes
Reject Replenishment, page 12-54	MSC_X_REPLENISH.VMI_REJEC T	None	Yes
End, page 12-60	WF_STANDARD.NOOP	None	Yes

### For Customer-Facing VMI Replenishment

This process is the workflow for the VMI replenishment engine. The Oracle Collaborative Planning VMI Replenishment process for VMI with customers is contained in the seeded data file mscxcfvr.wft and is associated with the Oracle Collaborative Planning VMI replenishment item types.

The Details property page of the process activity indicates that VMI Replenishment for VMI with customers has an error item type of WFERROR. This item type is associated with the RETRY\_ONLY error process. The purpose of this error handling process is to alert an administrator when an error occurs in a process and prompt the administrator to retry the process that is in error. This error process is initiated only when an unexpected error with Oracle Workflow is encountered in the process. When you display the Process window for Oracle Collaborative Planning VMI Replenishment for VMI with customers, you see that the process consists of nine unique activities, which comprise the eight nodes that appear in the workflow diagram. The following diagram depicts the Oracle Collaborative Planning VMI Replenishment. Each node of this process is numbered for referencing.

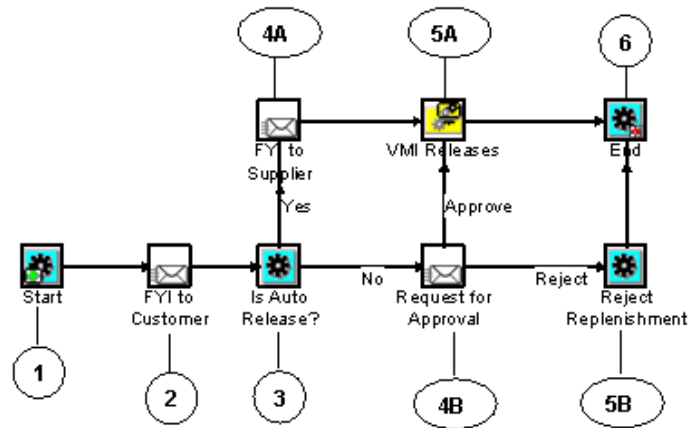

The Oracle Collaborative Planning VMI Replenishment for VMI with customers workflow begins at node 1 with the Start activity. The workflow then proceeds to the Send Notifications to Customers activity at node 2. After the activity is complete, the process continues to the Release Authorization Required? activity at node 3. If this process responds with Yes, the system moves to the Send Notifications to Item Planner activity at node 4. This activity returns an authorization from Item Planner. The process then continues to Release Replenishment activity at node 5. After releasing the VMI replenishment, the process moves on to the End activity at node 8.

If the Release Authorization Required? activity (node 3) responds with No, the process moves to the Request for Approval activity at node 6. If the Item Planner grants the approval, the process moves to Release Replenishment at node 5, then moves on to the End activity in node 8. If the request is rejected, the process moves to the Reject Replenishment at node 7, and then to the End activity in node 8.

**Activities for Oracle Collaborative Planning VMI Replenishment for VMI with Customers**

The following table provides descriptions of each activity in Oracle Collaborative Planning VMI Replenishment. For more information about individual activities, see "Functions."

Activity	Function	Result Type	Required
Start	WF_STANDARD.NOOP	None	Yes



Activity	Function	Result Type	Required
Release Authorization Required?	MSC_X_CUST_FACING_RELEASECREATE_VMI_RELEASE	Yes / No	Yes
Release Replenishment	MSC_X_CVMI_REPLENISH.VMI_RELEASE_API	None	Yes
Reject Replenishment	MSC_X_CVMI_REPLENISH.vmi_reject	None	Yes
End	WF_STANDARD.NOOP	None	Yes

## Start ASCP Engine

This process facilitates the automation of launching an ASCP plan after receiving an order forecast or supply commit from Oracle Collaborative Planning.

The Start ASCP Engine process is contained in the Seeded Data File mscxascp.wft, page 12-8 and is associated with the Start ASCP Engine, page 12-25 item type.

### Summary of the Start ASCP Engine Process

To view the properties of the Start ASCP Engine process, select the process in the navigator tree and then select Properties from the Edit menu. This process is runnable.

The Details property page of the process activity indicates that Start ASCP Engine has an error item type of WFERROR. This item type is associated with the RETRY\_ONLY error process. The purpose of this error handling process is to alert an administrator when an error occurs in a process and prompt the administrator to retry the process in error. This error process is initiated only when an unexpected error with Oracle Workflow is encountered in the process.

When you display the Process window for the Start ASCP Engine, you see that the process consists of 3 unique activities, which comprise the 3 nodes that appear in the workflow diagram. The following diagram depicts the Start ASCP Engine. Each node of this process is numbered for referencing.

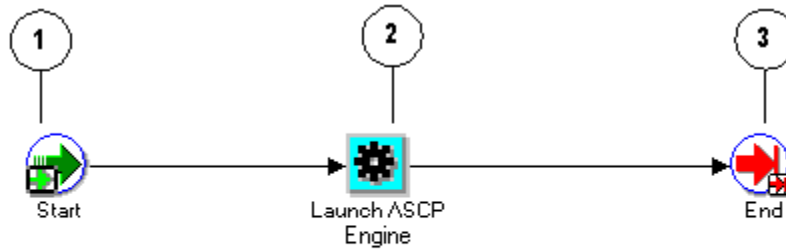

The Start ASCP Engine workflow begins at node 1 with the Start, page 12-61 activity.

The workflow then proceeds to the Launch ASCP Engine, page 12-55 activity in node 2. After the activity is complete, the process continues on to the End, page 12-60 activity in node 3.

### Start ASCP Engine Activities

The following table provides descriptions of each activity in Start ASCP Engine.

For more information about individual activities, refer to Functions, page 12-49.

Activity	Function	Result Type	Required
Start, page 12-61	WF_STANDARD.NOOP	None	Yes
Launch ASCP Engine, page 12-55	MSC_X_CP_FLOW.LAUNCH_ASCP_ENGINE	None	Yes
End, page 12-60	WF_STANDARD.NOOP	None	Yes

### DP Receive Forecast

This process facilitates receiving forecasts from Oracle Demand Planning into Oracle Collaborative Planning.

The DP Receive Forecast process is contained in the Seeded Data File mscxdprf.wft, page 12-7 and is associated with the DP Receive Forecast, page 12-31 item type.

### Summary of the DP Receive Forecast Process

To view the properties of the DP Receive Forecast process, select the process in the navigator tree and then select Properties from the Edit menu. This process is runnable.

The Details property page of the process activity indicates that DP Receive Forecast has

an error item type of WFERROR. This item type is associated with the RETRY\_ONLY error process. The purpose of this error handling process is to alert an administrator when an error occurs in a process and prompt the administrator to retry the process in error. This error process is initiated only when an unexpected error with Oracle Workflow is encountered in the process.

When you display the Process window for the DP Receive Forecast, you see that the process consists of 3 unique activities, which comprise the 3 nodes that appear in the workflow diagram. The following diagram depicts DP Receive Forecast. Each node of this process is numbered for referencing.

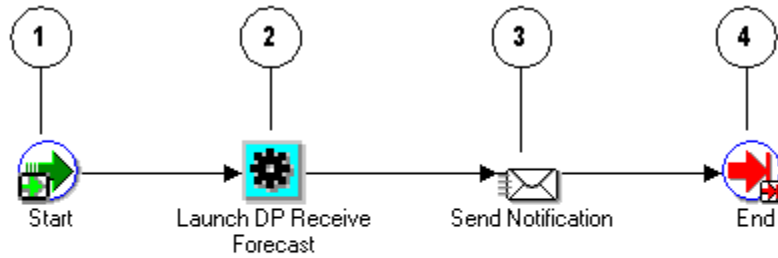

The DP Receive Forecast workflow begins at node 1 with the Start, page 12-61 activity.

The workflow then proceeds to the Launch DP Receive Forecast, page 12-60 activity in node 2. After the activity is complete, notification is sent at node 3. The process then continues on to the End, page 12-60 activity in node 4.

### DP Receive Forecast Activities

The following table provides descriptions of each activity in DP Receive Forecast.

For more information about individual activities, refer to Functions, page 12-49.

Activity	Function	Result Type	Required
Start, page 12-61	WF_STANDARD.NOOP	None	Yes
Launch DP Receive Forecast, page 12-60	MSC_X_CP_FLOW.DP_Receive_Forecast	None	Yes
End, page 12-60	WF_STANDARD.NOOP	None	Yes

## Publish Order Forecast

This process facilitates the automatic launch of the Publish Order Forecast program from Planner Workbench.

The Publish Order Forecast process is contained in the Seeded Data File mscxpbof.wft, page 12-7 and is associated with the Publish Order Forecast, page 12-25 item type.

### Summary of the Publish Order Forecast Process

To view the properties of the Publish Order Forecast process, select the process in the navigator tree and then select Properties from the Edit menu. This process is runnable.

The Details property page of the process activity indicates that Publish Order Forecast has an error item type of WFERROR. This item type is associated with the RETRY\_ONLY error process. The purpose of this error handling process is to alert an administrator when an error occurs in a process and prompt the administrator to retry the process in error. This error process is initiated only when an unexpected error with Oracle Workflow is encountered in the process.

When you display the Process window for the Publish Order Forecast, you see that the process consists of 3 unique activities, which comprise the 3 nodes that appear in the workflow diagram. The following diagram depicts Publish Order Forecast. Each node of this process is numbered for referencing.

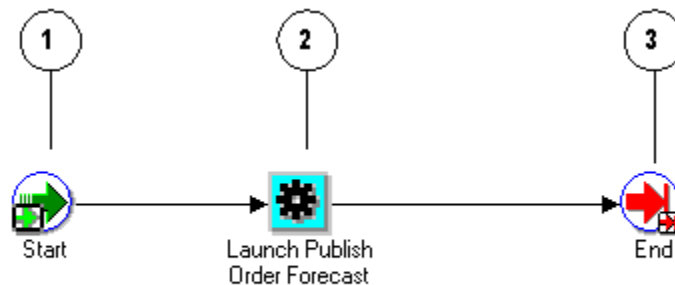

The Publish Order Forecast workflow begins at node 1 with the Start, page 12-61 activity.

The workflow then proceeds to the Launch Publish Order Forecast, page 12-56 activity in node 2. After the activity is complete, the process continues to the End, page 12-60 activity at node 3.

### Publish Order Forecast Activities

The following table provides descriptions of each activity in Publish Order Forecast.

For more information about individual activities, refer to Functions, page 12-49.

Activity	Function	Result Type	Required
Start, page 12-61	WF_STANDARD.NOOP	None	Yes
Launch Publish Order Forecast, page 12-56	MSC_X_CP_FLOW.PUBLISH_ORDE R_FORECAST	None	Yes
End, page 12-60	WF_STANDARD.NOOP	None	Yes

## Publish Supply Commit

This process facilitates the automatic launch of the Publish Supply Commit program from the Planner Workbench.

The Publish Supply Commit process is contained in the Seeded Data File mscxpbsc.wft, page 12-8 and is associated with the Publish Supply Commit, page 12-27 item type.

### Summary of the Publish Supply Commit Process

To view the properties of the Publish Supply Commit process, select the process in the navigator tree and then select Properties from the Edit menu. This process is runnable.

The Details property page of the process activity indicates that Publish Supply Commit has an error item type of WFERROR. This item type is associated with the RETRY\_ONLY error process. The purpose of this error handling process is to alert an administrator when an error occurs in a process and prompt the administrator to retry the process in error. This error process is initiated only when an unexpected error with Oracle Workflow is encountered in the process.

When you display the Process window for the Publish Supply Commit, you see that the process consists of 3 unique activities, which comprise the 3 nodes that appear in the workflow diagram. The following diagram depicts the Publish Supply Commit. Each node of this process is numbered for referencing.

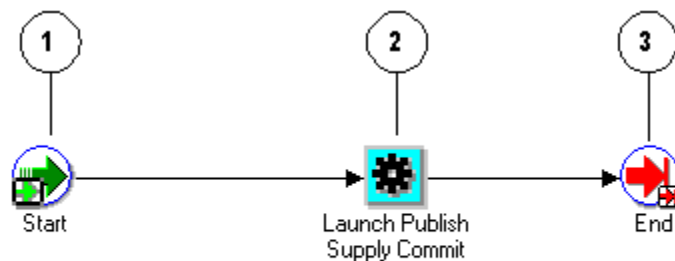

The Publish Supply Commit workflow begins at node 1 with the Start, page 12-61

activity.

The workflow then proceeds to the Send Exception Notification, page 12-55 activity in node 2. After the activity is complete, the process continues on to the End, page 12-60 activity in node 3.

### **Publish Supply Commit Activities**

The following table provides descriptions of each activity in Publish Supply Commit.

For more information about individual activities, refer to Functions, page 12-49.

<b>Activity</b>	<b>Function</b>	<b>Result Type</b>	<b>Required</b>
Start, page 12-61	WF_STANDARD.NOOP	None	Yes
Launch Publish Supply Commit, page 12-57	MSC_X_CP_FLOW.PUBLISH_SUPPLY_COMMITS	None	Yes
End, page 12-60	WF_STANDARD.NOOP	None	Yes

### **Start Receive Supplier Capacity**

This process facilitates the automatic start of the Receive Supplier Capacity program when a supply commit is loaded into Oracle Advanced Supply Chain Planning.

The Start Receive Supplier Capacity process is contained in the Seeded Data File mscxrcsc.wft, page 12-8 and is associated with the Start Receive Supplier Capacity, page 12-26 item type.

#### **Summary of the Start Receive Supplier Capacity Process**

To view the properties of the Start Receive Supplier Capacity process, select the process in the navigator tree and then select Properties from the Edit menu. This process is runnable.

The Details property page of the process activity indicates that Start Receive Supplier Capacity has an error item type of WFERROR. This item type is associated with the RETRY\_ONLY error process. The purpose of this error handling process is to alert an administrator when an error occurs in a process and prompt the administrator to retry the process in error. This error process is initiated only when an unexpected error with Oracle Workflow is encountered in the process.

When you display the Process window for the Start Receive Supplier Capacity, you see that the process consists of 4 unique activities, which comprise the 4 nodes that appear in the workflow diagram. The following diagram depicts the Start Receive Supplier Capacity. Each node of this process is numbered for referencing.

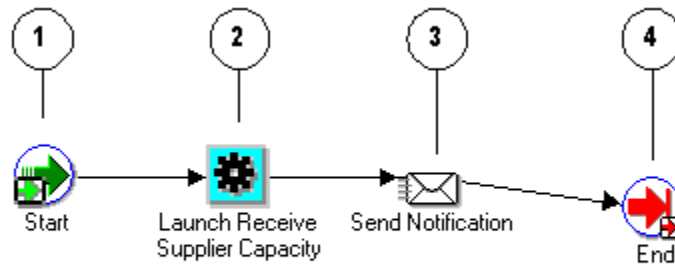

The Start Receive Supplier Capacity workflow begins at node 1 with the Start, page 12-61 activity.

The workflow then proceeds to the Launch Receive Supplier Capacity, page 12-57 activity in node 2. After the activity is complete, notification is sent at node 3. The process continues on to the End, page 12-60 activity in node 4.

### Start Receive Supplier Capacity Activities

The following table provides descriptions of each activity in Start Receive Supplier Capacity.

For more information about individual activities, refer to Functions, page 12-49.

Activity	Function	Result Type	Required
Start, page 12-61	WF_STANDARD.NOOP	None	Yes
Launch Receive Supplier Capacity, page 12-57	MSC_X_CP_FLOW.RECEIVE_SUPPLIER_CAPACITY	None	Yes
End, page 12-60	WF_STANDARD.NOOP	None	Yes

### Start SCEM Engine

This process facilitates the automatic launch of the supply chain event manager when an order forecast or supply commit is loaded into Oracle Collaborative Planning.

The Start SCEM Engine process is contained in the Seeded Data File mscxssem.wft, page 12-8 and is associated with the Start SCEM Engine, page 12-25 item type.

### Summary of the Start SCEM Engine Process

To view the properties of the Start SCEM Engine process, select the process in the

navigator tree and then select Properties from the Edit menu. This process is runnable.

The Details property page of the process activity indicates that Start SCEM Engine has an error item type of WFERROR. This item type is associated with the RETRY\_ONLY error process. The purpose of this error handling process is to alert an administrator when an error occurs in a process and prompt the administrator to retry the process in error. This error process is initiated only when an unexpected error with Oracle Workflow is encountered in the process.

When you display the Process window for the Start SCEM Engine, you see that the process consists of 3 unique activities, which comprise the 3 nodes that appear in the workflow diagram. The following diagram depicts the Start SCEM Engine workflow. Each node of this process is numbered for referencing.

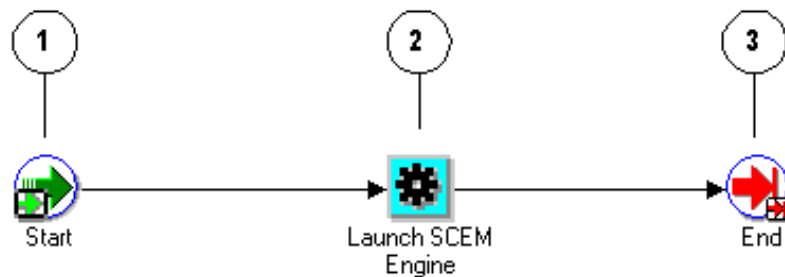

The Start SCEM Engine workflow begins at node 1 with the Start, page 12-61 activity.

The workflow then proceeds to the Launch SCEM Engine, page 12-56 activity in node 2. After the activity is complete, the process continues on to the End, page 12-60 activity in node 3.

### Start SCEM Engine Activities

The following table provides descriptions of each activity in Start SCEM Engine.

For more information about individual activities, refer to Functions, page 12-49.

Activity	Function	Result Type	Required
Start, page 12-61	WF_STANDARD.NOOP	None	Yes



Activity	Function	Result Type	Required
Launch SCEM Engine, page 12-56	MSC_X_CP_FLOW.LAUNCH_SCEM_ENGINE	None	Yes
End, page 12-60	WF_STANDARD.NOOP	None	Yes

## Functions

The following section discusses the functions contained in the workflow processes used by Oracle Collaborative Planning. The functions are discussed according to their associated item types:

### Oracle Collaborative Planning VMI Replenishment

#### For Supplier-Facing VMI Replenishment

##### **Can Seller Approve?**

The Can Seller Approve? activity is a Workflows for Oracle Collaborative Planning activity that determines whether a seller can approve a VMI replenishment.

The Can Seller Approve? activity calls the PL/SQL procedure named `MSC_X_REPLENISH.IS_SELLER_APPROVE`.

The Can Seller Approve? has a result type of Yes/No. The result of this activity will be either Yes or No.

The following image depicts the Can Seller Approve? activity:

##### ***Can Seller Approve? activity***



Can Seller Approve?

The Can Seller Approve? activity is contained in the Seeded Data File `mscxvmir.wft`, page 12-6, and is associated with the Oracle Collaborative Planning VMI Replenishment, page 12-9 item type.

##### **Create Replenishment**

The Create Replenishment activity is a Oracle Collaborative Planning VMI Replenishment activity that creates a VMI replenishment.

The Create Replenishment activity calls the PL/SQL procedure named `MSC_X_REPLENISH.VMI_REPLENISH`.

The following image depicts the Create Replenishment activity:

#### **Create Replenishment activity**



The Create Replenishment activity is contained in the Seeded Data File `mscxvmir.wft`, page 12-6, and is associated with the Oracle Collaborative Planning VMI Replenishment, page 12-9 item type.

#### **Is Auto Release?**

The Is Auto Release? activity is a Oracle Collaborative Planning VMI Replenishment activity that determines whether an VMI replenishment is eligible for auto release.

The Is Auto Release? activity calls the PL/SQL procedure named `MSC_X_REPLENISH.IS_AUTO_RELEASE`.

Is Auto Release? has a result type of Yes/No. The result of this activity will be either Yes or No.

The following image depicts the Is Auto Release? activity:

#### **Auto Release? activity**



The Is Auto Release? activity is contained in the Seeded Data File `mscxvmir.wft`, page 12-6, and is associated with the Oracle Collaborative Planning VMI Replenishment, page 12-9 item type.

#### **Reject Replenishment**

The Reject Replenishment activity is a Oracle Collaborative Planning VMI Replenishment activity that rejects a VMI replenishment request.

The Reject Replenishment activity calls the PL/SQL procedure named `MSC_X_REPLENISH.VMI_REJECT`.

The following image depicts the Reject Replenishment activity:

### ***Reject Replenishment activity***



Reject Replenishment activity is contained in the Seeded Data File mscxvmir.wft, page 12-6, and is associated with the Oracle Collaborative Planning VMI Replenishment, page 12-9 item type.

### **Release Replenishment**

The Release Replenishment activity is a Oracle Collaborative Planning VMI Replenishment activity that releases a VMI replenishment.

The Release Replenishment activity calls the PL/SQL procedure named `MSC_X_REPLENISH.VMI_RELEASE`.

The following image depicts the Release Replenishment activity:

### ***Release Replenishment activity***



The Release Replenishment activity is contained in the Seeded Data File mscxvmir.wft, page 12-6, and is associated with the Oracle Collaborative Planning VMI Replenishment, page 12-9 item type.

## **For Customer-Facing VMI Replenishment**

### **Release Authorization Required?**

The Release Authorization Required? activity is the activity for Oracle Collaborative Planning VMI Replenishment for VMI with a customer that determines whether authorization is required from Item Planner to create a sales order in the source. The Release Authorization Required? activity calls the PL/SQL procedure named `MSC_X_CUST_FACING_RELEASECREATE_VMI_RELEASE`. This procedure has a result type of Yes/No, that is, the result of this activity will be either Yes or No. The following image depicts the Release Authorization Required? activity:



## Is Release Authorization Required?

The Release Authorization Required? activity is contained in the seeded data file mscxcfvr.wft and is associated with the Oracle Collaborative Planning VMI Replenishment Item Type.

### **Release Replenishment**

The Release workflow is a sub-workflow process. It is called from Oracle Collaborative Planning VMI Replenishment for VMI with a customer workflow process. This workflow is called after the item planner approves of the VMI release. In the VMI Release process, the Collaborative Planning system calls an OM API to create a sales order in the ERP source. The replenishment record in MSC\_SUP\_DEM\_ENTRIES table is marked as *released*. For more information about this table, see "Appendix D: Key Tables."

The name of the PL/SQL procedure that is called by this workflow node is VMI\_RELEASE. Inside this procedure, the system starts another Release workflow process. Release workflow will be called for creating:

- Sales order release in Unconsigned case
- Internal requisition in Consigned case
- Sales order release in Consigned case with ATP override when Consumption Advice is loaded in Collaborative Planning
- Sales order Schedule date update in Unconsigned case from ATP override notification.

The workflow process for VMI Release can be invoked in the following ways:

- It can be called by the VMI Replenish workflow process as a sub-process.
- It can be called directly from the consumption advice load program.

When the Automatic Release flag is set to Yes, the VMI main workflow process calls the VMI Release sub-process and automatically release the replenishment. When the Automatic Release flag is set to No, this process can be invoked under the following scenarios:

### **Scenario 1**

When you approve the release from the workflow notification page, the VMI main workflow process is resumed and VMI release sub-process is called automatically.

### **Scenario 2**

When you release the replenishment from the using the Release button in the VMI screen for the first time, the following workflow API is called to resume the VMI main

workflow process, which releases the replenishment:

WF\_NOTIFICATION.RESPOND

From the next release onwards, the following API will be called to start a new VMI release workflow process.

MSC\_X\_CVMI\_REPLENISH.VMI\_RELEASE\_API

### Scenario 3

When you load consumption advice, the system calls the API

MSC\_X\_CVMI\_REPLENISH.VMI\_RELEASE\_API to start the VMI release workflow process.

The following diagram illustrates the VMI Release workflow process:

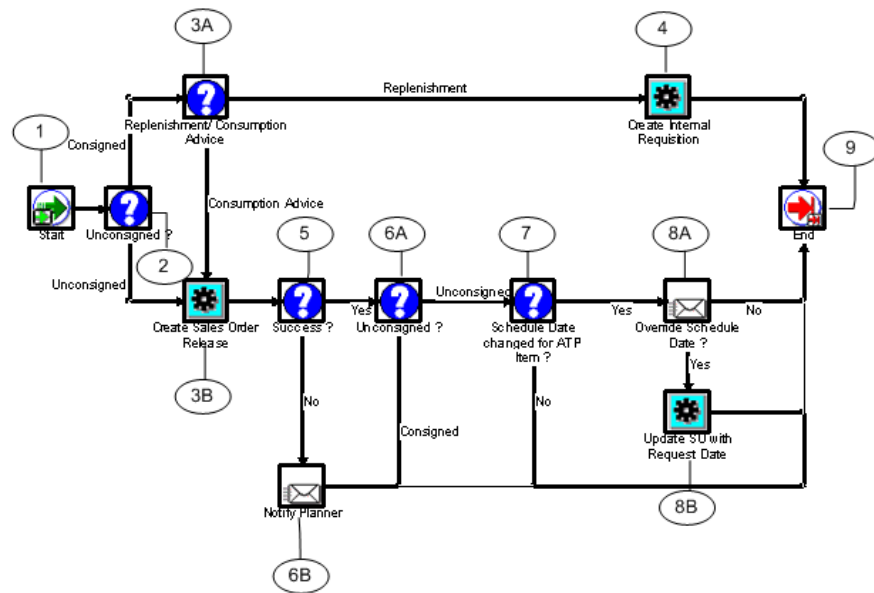

When VMI engine Workflow creates the replenishment, it starts the Release workflow after indicating whether it is handling consigned VMI with customers or customer facing VMI and setting the attributes in workflow accordingly.

The VMI replenishment engine calls the VMI\_CUST\_REPL\_RELEASE procedure and carries out the following steps for customer facing VMI and consigned VMI with customers:

#### For Unconsigned VMI with Customers

For customer facing VMI, the VMI replenishment engine sets the values for Item, Customer, Customer site, Replenish quantity, Source Organization, and Request date and stores the data in the MSC\_SO\_RELEASE\_INTERFACE table.

It then launches the Create Sales Order Release concurrent program in the E-Business

Suite source instance. This program retrieves the appropriate Blanket Agreement number against which the sales order should be released and calls the OM API - OE\_ORDER\_PUB.PROCESS\_ORDER to create the sales order release. For more information about OE\_ORDER\_PUB.PROCESS\_ORDER API, see "Oracle Order Management APIs/Open Interfaces" and "Processing the Sales Order Business Object" in the *Oracle Order Management Open Interfaces, API, & Electronic Messaging Guide*.

The system sends notification to the Item Planner with the result of the call to OM API.

If the program finishes successfully for an ATPable item and ATP Scheduling moves the ship date for the order, the engine sends a notification to the Item Planner for an approval to override the scheduled ship date for the sales order. If the planner chooses to override ATP, the engine launches a concurrent request for the Create Sales Order Release program.

After the sales order is released successfully, the system deletes the record from the MSC\_SO\_RELEASE\_INTERFACE table.

For partial release using the Release button in the VMI screen, the first release invokes the Workflow process, which in turn calls the release procedure with Workflow standard signature. Any release after the first release from the VMI screen directly calls the non-Workflow VMI release API. This partial release rule applies to both the creation of the sales orders and internal requisitions.

#### **For Consigned VMI with Customers**

For consigned VMI with customers, the VMI replenishment engine sets the values for Item, Organization ID for the customer modeled organization, Plan ID, source instance ID, Replenish quantity, Source Organization, and Request date and creates the internal requisition in the customer modeled organization.

#### **Reject Replenishment**

The Reject Replenishment activity is a part of Oracle Collaborative Planning VMI Replenishment for VMI with a customer process. It rejects a VMI replenishment request.

The Reject Replenishment activity calls the PL/SQL procedure named MSC\_X\_CVMI\_REPLENISH.vmi\_reject. The system will not create any sales order in the source if this procedure is called. The replenishment record in the MSC\_SUP\_DEM\_ENTRIES table will be marked as rejected after this procedure is executed.

The following image depicts the Reject Replenishment activity:



#### **Reject Replenishment**

The Reject Replenishment activity is contained in the seeded data file mscxcfvr.wft, and is associated with the Oracle Collaborative Planning VMI Replenishment Item Type.

## MSC: User Define Exception Workflow

### Send Exception Notification

The Send Exception Notification activity is a MSC: User Define Exception activity that sends an exception notification.

The Send Exception Notification activity calls the PL/SQL procedure named `MSC_X_USER_EXCEP_GEN.SEND_NTF`.

The following image depicts the Send Exception Notification activity:

#### *Send Exception Notification activity*



The Send Exception Notification activity is contained in the Seeded Data File `mscxudex.wft`, page 12-6, and is associated with the MSC: User Define Exception Workflow, page 12-12 item type.

## Start ASCP Engine

### Launch ASCP Engine

The Launch ASCP Engine activity is a Start ASCP Engine activity that launches the ASCP Engine.

The Launch ASCP Engine activity calls the PL/SQL procedure named `MSC_X_CP_FLOW.Launch_ASCP_Engine`.

The following image depicts the Launch ASCP Engine activity:

#### *Launch ASCP Engine activity*



The Launch ASCP Engine activity is contained in the Seeded Data File `mscxascp.wft`, page 12-8, and is associated with the Start ASCP Engine, page 12-25 item type.

## Start SCEM Engine

### Launch SCEM Engine

The Launch SCEM Engine activity is a Start SCEM Engine activity that launches the SCEM Engine.

The Launch SCEM Engine activity calls the PL/SQL procedure named `MSC_X_CP_FLOW.Launch_SCEM_Engine`.

The following image depicts the Launch SCEM Engine activity:

#### *Launch SCEM Engine activity*



The Launch SCEM Engine activity is contained in the Seeded Data File `mscxscem.wft`, page 12-8, and is associated with the Start SCEM Engine, page 12-25 item type.

## Publish Order Forecast

### Launch Publish Order Forecast

The Launch Publish Order Forecast activity is a Publish Order Forecast activity that publishes an order forecast.

The Launch Publish Order Forecast activity calls the PL/SQL procedure named `msc_x_cp_flow.publish_order_forecast`.

The following image depicts the Launch Publish Order Forecast activity:

#### *Launch Publish Order Forecast activity*



The Launch Publish Order Forecast activity is contained in the Seeded Data File `mscxpbof.wft`, page 12-7, and is associated with the Publish Order Forecast, page 12-25



item type.

## Start Receive Supplier Capacity

### Launch Receive Supplier Capacity

The Launch Receive Supplier Capacity activity is a Start Receive Supplier Capacity activity that launches the SCEM Engine.

The Launch Receive Supplier Capacity activity calls the PL/SQL procedure named `msc_x_cp_flow.Receive_Supplier_Capacity`.

The following image depicts the Launch Receive Supplier Capacity activity:

#### *Launch Receive Supplier Capacity activity*



The Launch Receive Supplier Capacity activity is contained in the Seeded Data File `mscxrcsc.wft`, page 12-8, and is associated with the Start Receive Supplier Capacity, page 12-26 item type.

## Publish Supply Commit

### Launch Publish Supply Commit

The Launch Publish Supply Commit activity is a Publish Supply Commit activity that publishes a supply commit to Oracle Collaborative Planning.

The Launch Publish Supply Commit activity calls the PL/SQL procedure named `msc_x_cp_flow.publish_supply_commits`.

The following image depicts the Launch Publish Supply Commit activity:

#### *Launch Publish Supply Commit activity*



The Launch Publish Supply Commit activity is contained in the Seeded Data File

msexpbsc.wft, page 12-8, and is associated with the Publish Supply Commit, page 12-27 item type.

## Supply/Demand Mismatch

### Send Out Exceptions

The Send Out Exceptions activity is a Supply/Demand Mismatch activity that sends out exceptions.

The Send Out Exceptions activity calls the PL/SQL procedure named `WF_STANDARD.NOTIFY`.

The following image depicts the Send Out Exceptions activity:

#### *Send Out Exceptions activity*



The Send Out Exceptions activity is contained in the Seeded Data File mscxnet.wft, page 12-6, and is associated with the Supply/Demand Mismatch, page 12-27 item type.

## Workflows for Oracle Collaborative Planning

### Build Error Message

The Build Error Message activity is a Workflows for Oracle Collaborative Planning activity that builds an error message for a planner.

The Build Error Message activity calls the PL/SQL procedure named `MSC_SCE_WF.BUILD_ERR_MSG`.

The following image depicts the Build Error Message activity:



The Build Error Message activity is contained in the Seeded Data File mscxewf.wft,

page 12-6, and is associated with the Workflows for Oracle Collaborative Planning, page 12-30 item type.

## Clean Up

The Clean Up activity is a Workflows for Oracle Collaborative Planning activity that closes all open cursors.

The Clean Up activity calls the PL/SQL procedure named `MSC_SCE_WF.CLOSE_CURSOR`.

The following image depicts the Clean Up activity:

### *Clean Up activity*



Clean up

The Clean Up activity is contained in the Seeded Data File `mscxewf.wft`, page 12-6, and is associated with the Workflows for Oracle Collaborative Planning, page 12-30 item type.

## Determine Planners

The Determine Planners activity is a Workflows for Oracle Collaborative Planning activity that determines the planners corresponding to a party.

The Determine Planners activity calls the PL/SQL procedure named `MSC_SCE_WF.DETERMINE_PLANNERS`.

The following image depicts the Determine Planners activity:

### *Determine Planners activity*



Build Error Message

The Determine Planners activity is contained in the Seeded Data File `mscxewf.wft`, page 12-6, and is associated with the Workflows for Oracle Collaborative Planning, page 12-30 item type.

## DP Receive Forecast

### Launch DP Receive Forecast

The Launch DP Receive Forecast activity is a DP Receive Forecast activity that receives an Oracle Demand Planning forecast into Oracle Collaborative Planning.

The Launch DP Receive Forecast activity calls the PL/SQL procedure named `MSC_X_CP_FLOW.DP_Receive_Forecast`.

The following image depicts the Launch DP Receive Forecast activity:

#### ***Launch DP Receive Forecast activity***



Launch DP Receive  
Forecast

The Launch DP Receive Forecast activity is contained in the Seeded Data File `mscxdprf.wft`, page 12-7, and is associated with the DP Receive Forecast, page 12-31 item type.

## Standard

Oracle Workflow provides some generic activities you can use to control your processes. The activities are associated with the Standard item type but can be used with any process you define. The Standard item type is automatically installed on your Oracle Workflow server. The following are the Standard activities used by Oracle Collaborative Planning. For more information about the Oracle Workflow Standard activities, refer to the *Oracle Workflow Guide*.

### End

The End activity marks the end of a process and does not perform any action. You can use it to return a result for a completed process by specifying a Result Type for the activity. Although it is not necessary, you may include it in your process diagram to visually mark the end of your process as a separate node.

The following image depicts the End activity:

**End activity**



The End activity calls the PL/SQL procedure named `WF_STANDARD.NOOP`.

**Start**

The Start activity marks the start of a process and does not perform any action. Although it is not necessary, you may include it in your process diagram to visually mark the start of a process as a separate node.

The following image depicts the Start activity:

**Start activity**



The Start activity calls the PL/SQL procedure named `WF_STANDARD.NOOP`.



---

## Profile Options

This appendix covers the following topics:

- Profile Options

### Profile Options

The following table lists the profile options used by Oracle Collaborative Planning. Valid values, default values and profile option descriptions are also listed in the table.

Profile Option	Valid Values	Default Value	Description
MSC: CP Debug Level	Debug-Off/ Debug-On/ Debug-High	Debug - High	Controls the level of detail in the concurrent program log messages for Collaborative Planning. Off = no debug messages are generated; On = short debug messages are generated; High = detailed debug messages are generated.
MSC: SCEM Engine Launch Events	None/Load/ Publish/All	All	Launches the Supply Chain Event Manager when data is loaded, published, or both.
MSC: New Supply Commit Auto Plan	A valid ASCP Plan	Null	ASCP plan launched when a supplier provides supply commits to Oracle Collaborative Planning. This should be a constrained plan.

<b>Profile Option</b>	<b>Valid Values</b>	<b>Default Value</b>	<b>Description</b>
MSC: Launch Workflow-Enabled Exception Message Notifications	Yes/No	Yes	Determines if notification messages are sent when an Oracle Collaborative Planning exception is generated.
MSC: New Forecast Auto Plan	A valid ASCP Plan	Null	ASCP plan launched when a customer provided forecast into Oracle Collaborative Planing. This plan should be unconstrained.
MSC: Configuration	APS/APS & CP/CP	APS	Indicates whether Oracle Collaborative Planning is deployed. If it is deployed together with an Oracle ERP instance use APS & CP. If it is standalone use CP.
MSC: Operator Company Name	Your company name	Not Applicable	Provides the name of the company that deployed Collaborative Planning. All subsequent supply and demand records loaded for this company should use this value.
MSC: Vertical View Default Query	Yes/No	Yes	Used by Oracle Collaborative Planning to determine whether default results are displayed for the vertical view.
MSC: VMI Default Query	Yes/No	Yes	Used by Oracle Collaborative Planning to determine whether default results are displayed in the vendor managed inventory window.
MSC: Order Number-CA Mandatory for CVMI	Yes/No	No	Determines whether the order number is mandatory for a consumption advice, while the customer enters the consumption advice record. If the profile option is set to Yes, the user must enter order number for the consumption advice.  If the value for the profile option MSC: Order Number-CA Mandatory for CVMI is set to No, the key date for sales orders and ASN is considered as part of deletion key.



<b>Profile Option</b>	<b>Valid Values</b>	<b>Default Value</b>	<b>Description</b>
MSC: Purchase Order Dock Date Calculation Preference	Promise Date/Need By Date	Promise Date	Determines the date used by planning as the dock date of a purchase order.
MSC: ATP Allocation Method	Demand Priority/User-Defined Allocation Percentage		Enables you to decide which allocation method to use.
MSC: Class Hierarchy	Demand Class		



---

## Troubleshooting

This appendix covers the following topics:

- Loading Data
- Vertical View
- Vendor Managed Inventory with Suppliers
- Vendor Managed Inventory with Customers
- Horizontal View
- Security Rules
- Exceptions
- Forecast Comparison
- XML Gateway

### Loading Data

The following table lists issues you might encounter while loading data and their solutions.

<b>Problem</b>	<b>Solution</b>
You successfully uploaded an order forecast using <i>supplydemand.dat</i> , but you cannot view data in any Oracle Collaborative Planning screens.	Run the Build Collaborative Planning Calendar concurrent program. Without this calendar file, uploads in weekly or monthly buckets fail.

Problem	Solution
<p>You attempted to upload an order forecast using <i>supplydemand.dat</i> but received a Publisher is Not Valid error message.</p>	<p>The system cannot find a match between the value for publisher and valid customer and supplier values. Verify that MSC:Operator Company Name matches the Publisher value. Verify that Customer Name in Oracle Order Management or Supplier Name in Oracle Purchasing matches the Publisher value.</p>
<p>You uploaded <i>supplydemand.dat</i> and received a Publisher Site is Not Valid error message.</p>	<p>The system cannot find an exact match between the publisher site value and a valid inventory organization, customer site, or supplier site. Verify that Customer Site in Oracle Order Management or Supplier Site in Oracle Purchasing matches the value used for publisher site.</p>
<p>You uploaded <i>supplydemand.dat</i> with sync indicator D to delete records. The records still appear in the vertical view.</p>	<p>For each record that you want to delete, you must provide: item, publisher, publisher site, supplier, supplier site (or customer, customer site for sales orders), and order type.</p> <p>For purchase orders, sales orders and ASNs, you must also provide:</p> <ul style="list-style-type: none"> <li>• Order number</li> <li>• Release number</li> <li>• Key date</li> <li>• Line number</li> <li>• End order number</li> <li>• End order line number</li> </ul>
<p>You successfully uploaded <i>supplydemand.dat</i> with allocated onhand records. After uploading <i>serialnumber.dat</i>, you are unable to navigate to the serial number screen in Oracle Collaborative Planning.</p>	<p>Your item must be serial-controlled. Verify that you have set the serial controlled flag to Yes in the item master.</p>

<b>Problem</b>	<b>Solution</b>
Records uploaded using ExcelLoad.xlt does not spread out based on the bucket type and bucket end date.	If the bucket type on the order is Day, the system creates a record for each day beginning on the start date and ending on the end date.

## Vertical View

The following table lists issues you might encounter while using vertical view in Oracle Collaborative Planning. Solutions are also listed in the table.

<b>Problem</b>	<b>Solution</b>
You are unable to update the date or quantity for a record in the vertical view.	You can only update a record in the vertical view if your company is the publisher of the record or if the publisher of the record provides you with update privileges. Update privileges are granted using security rules.
Your customer successfully published an order forecast but you are unable to view any records in Oracle Collaborative Planning.	The system is unable to determine which company's user you are. The system administrator must run collections with the Enable User-Company Association parameter set to Yes.

## Vendor Managed Inventory with Suppliers

The following table lists issues you might encounter while using supplier-facing vendor managed inventory in Oracle Collaborative Planning. Solutions are also listed in the table.

<b>Problem</b>	<b>Solution</b>
----------------	-----------------

<b>Problem</b>	<b>Solution</b>
Purchase order releases were created in Oracle Purchasing for supplier-facing VMI items, but they do not appear on the Vendor Managed Inventory screen.	Only Vendor Managed Inventory-enabled items appear in the Vendor Managed Inventory screen. Verify whether the item is Vendor Managed Inventory- enabled in the Approved Supplier List.  New purchase orders appear only after the collections program runs.
You set up a blanket purchase order for a Vendor Managed Inventory item but no purchase releases are created after you approved replenishments in the Vendor Managed Inventory screen.	You must associate a planner with the Vendor Managed Inventory item. Define planners in Oracle Inventory.

## Vendor Managed Inventory with Customers

The following table lists issues you might encounter while using customer-facing vendor managed inventory in Oracle Collaborative Planning. Solutions are also listed in the table.

<b>Problem</b>	<b>Solution</b>
The demand plan name for the customer-facing VMI did not show up in publish forecast to customer.	Only the plans at the floor level will show up in the plan name while publishing an order forecast to customers.
The create or update request for a consumption advice throws an error.	Set the Default Order Line Type same as the order type used in Assign line flows.
The collected ASN is not displayed on the Collection Workbench, but displayed in Collaborative Planning.	The collected ASN is not displayed on Collection workbench.
Requests for create or update orders for customer-facing VMI throws an error without displaying any workflow error.	The order type used in the consumption advice must be same as the order type associated to the customer site.

<b>Problem</b>	<b>Solution</b>
In-process quantity is not populated when a VMI item is auto released.	When an unconsigned VMI item is auto released, the in-process quantity will be updated only if the sales order release for the item is successful.

## Horizontal View

The following table lists issues you might encounter while using horizontal view in Oracle Collaborative Planning. Solutions are also listed in the table.

<b>Problem</b>	<b>Solution</b>
You set your preferences to display the Planned Supply/Planned Demand graph but are unable to view the graph in the horizontal view.	To view a Purchase Order/Sales Order graph you must include the order types Purchase Order and Sales Order in your preference set.  Select the order forecast and supply commit order types for display.
The Horizontal View displays more records than the value set in the profile option FND: View Object Max Fetch Size.	This happens only when the result set for the search criteria contains more records than the value you have set in the profile option FND: View Object Max Fetch Size. The system also displays a warning message that there are potentially more records in the result set and hence you should modify the search criteria.
Supplier items are not displayed for all suppliers in the Horizontal View.	If a supplier item is associated to more than one suppliers, then the supplier item will be displayed only for the first supplier record.
Customer receiving calendar is not applied in the Horizontal View.	APS is a single language product, which means it can work only in one language at any point of time. Therefore, if you run data collection in multiple languages for the same instance, the receiving calendar for the customers will not be applied in the Horizontal View as expected

## Security Rules

The following table lists issues you might encounter while using security rules in Oracle Collaborative Planning. Solutions are also listed in the table.

Problem	Solution
You defined a group and its member companies. You also created a security rule that gives viewing privileges to members of the group. You are unable to view any records that group members should see in the vertical view.	Your company must be included in a group even if you defined the group and its members. Add your company to the group using <i>groupcompany.dat</i> .

## Exceptions

The following table lists issues you might encounter while using exceptions in Oracle Collaborative Planning. Solutions are also listed in the table.

Problem	Solution
You can view exceptions but are not receiving any notifications.	<ol style="list-style-type: none"><li>1. You must be an item planner or listed as a site contact to receive exception notifications.</li><li>2. Verify in the workflow mailer configuration file that the <code>AUTOCLOSE_FYI</code> parameter is set to No.</li></ol>
Supplier is getting an E-mail notification for the Supplier Supply Commit Exceeds Order Forecast exception. But the OEM organization is not receiving the E-mail notification.	This issue may arise if the same planner creates more than one application usernames. Create different E-mail addresses for different usernames to solve this problem

## Forecast Comparison

The following table lists issues you might encounter while using the forecast comparison program in Oracle Collaborative Planning. Solutions are also listed in the table.



<b>Problem</b>	<b>Solution</b>
Forecast comparison takes more than three minutes to query.	<p>This issue may arise if you have a large amount of data on your source system. Run Purge Collaborative Planning Historical Records program before using the Forecast Comparison program.</p> <p>You can specify any of the following parameters while deleting the history table:</p> <ol style="list-style-type: none"> <li>1. From Date</li> <li>2. To Date</li> <li>3. Order type</li> </ol> <p>Note that if you do not specify any parameter, the history table will be truncated.</p>

## XML Gateway

The following table lists issues you might encounter while using XML Gateway in Oracle Collaborative Planning. Solutions are also listed in the table.

<b>Problem</b>	<b>Solution</b>
The XML Gateway execution engine fails to process XML messages.	<p>Review the error messages of the log file located ECX: Log File Path profile option. Review ECX_OBJECTS and verify that 000_sync_fore-cast_001.dtd is loaded. Review ECX_OBJECTS and verify that a map is loaded.</p>



This appendix covers the following topics:

- Overview
- XML Transactions
- Set Up XML Gateway
- Legacy Integration Loads

## Overview

Oracle Collaborative Planning enables trading partners to establish and maintain an electronic relationship by transmitting order information via XML. Oracle Collaborative Planning is capable of receiving as well as sending XML compliant documents for supply and demand transactions.

Any supply chain participant, with an established trading partner relationship, can post transactions to Oracle Collaborative Planning. Based on the specifications embedded in an XML transaction, Oracle Collaborative Planning can interpret supply and demand order information.

The execution engine is an XML Gateway execution engine interfaces with the Oracle e-Business Suite to retrieve data from, and populate data into, tables

Currently, support through the XML gateway is restricted to inbound transactions; i.e. transactions publishing forecast and supply commit data into Collaboration Planning. Outbound transactions are currently not supported through the XML gateway. For more information about how Collaborative Planning integrates with XML Gateway, refer to *Oracle XML Gateway User Guide*.

## XML Transactions

There are two major ways by which you can populate Oracle Collaborative Planning using XML.

- Supply/Demand load
- Legacy Integration Load

## Supply/Demand Load

Like loading flat file, you can communicate supply demand transactions using XML with Oracle Collaborative Planning. By this, your data is populated directly in Oracle Collaborative Planning. You can also integrate with legacy systems by providing different order types to be used in Collaborative Planning, such as sales forecast, purchase order, sales order, safety stock, projected available balance, order forecast, and supply commit as XML documents into Collaborative Planning.

The DTD (Document Type Definition) used for Supply/Demand XML loads is

- *000\_sync\_forecast\_001.dtd*

Some of the key fields in the Supply/Demand XML load are:

- Order's change status or Sync indicator (R: Replace or Add, D: Delete)
- Order type
- Order number
- Line number
- Customer's name and site
- Supplier's name and site
- Item
- Quantity
- UOM
- Date information (Ship Date, Receipt Date)
- Shipment information (Ship From or Ship To information)
- Version (if applicable)
- Forecast name (if applicable)

For more information about XML, contact your System Administrator or review the DTD. The content of an XML transaction for supply and demand information is similar to flat file loads for supply and demand. You can download the OA Template using Oracle Collaborative Planning. The *supplydemand.dat* flat file can be used as a template

for the content of an XML transaction. For more information about downloading and uploading flat files into Oracle Collaborative Planning, refer to Loading and Publishing Data, page 2-39 in Setup, page 2-1.

## Set Up XML Gateway

Perform the following steps to set up XML Gateway:

- Set up the profile ECX: Log File Path with a valid path. Include this path in the `utl_file_dir` parameter in the `init.ora` file.
- Set up the profile ECX: System Administrator e-mail Address with the e-mail address of the error notification recipient.

## Legacy Integration Loads

Another type of XML transaction available in Oracle Collaborative Planning is called Legacy Integration Loads. The difference between Legacy Integration loads and Supply/Demand loads is that all data loaded through Legacy Integration loads is also available to other Oracle Advanced Planning products such as Oracle Advanced Supply Chain Planning. In Legacy Integration loads data from XML documents are first loaded to interface tables for Oracle Advanced Supply Chain Planning and then the appropriate data is transferred to Oracle Collaborative Planning.

There are separate DTDs used for different entities. Contact your system administrator to find the right DTD for your transaction.

XML Legacy Integration loads are most suitable for synchronizing setup data among instances and among trading partners. Supply/Demand loads are most suitable for communicating supply and demand transactions among trading partners.



---

## Key Tables

This appendix covers the following topics:

- Key Tables

### Key Tables

The following table lists the key tables used in Oracle Collaborative Planning. Their descriptions are also listed.

Table Name	Description
MSC_SUP_DEM_ENTRIES	Stores supplies and demands in Oracle Collaborative Planning. Data is loaded into this table using: <ul style="list-style-type: none"><li>• Flat file loads</li><li>• XML loads</li><li>• Collections from ERP</li><li>• Manually through the user interface</li><li>• Publish processes in Oracle Advanced Supply Chain Planning and Oracle Demand Planning</li></ul>
MSC_COMPANIES	Stores list of companies. The company name in the profile option MSC: Operator Company Name is seeded in this table as Company_ID=1.
MSC_COMPANY_SITES	Stores the list of company sites. Sites may be customer sites, supplier sites, or inventory organizations.

<b>Table Name</b>	<b>Description</b>
MSC_COMPANY_RELATIONSHIPS	Stores the relationships between companies in Oracle Collaborative Planning.
MSC_x_EXCEPTION_DETAILS	Stores the exceptions generated by the Supply Chain Event Manager, Custom Exceptions, and VMI Replenishment Engine.
MSC_SECURITY_RULES	Stores security rules defined in Oracle Collaborative Planning.
MSC_TRADING_PARTNER_MAPS	Stores maps between company and company sites with trading partner and trading partner sites.
MSC_ITEMS	Stores the repository of items.
MSC_SYSTEM_ITEMS	Stores the items for each Organization and Instance combination.
MSC_SUP_DEM_HISTORY	Stores the history of transactions. Whenever data is loaded to MSC_SUP_DEM_ENTRIES, existing records are transferred to the MSC_SUP_DEM_HISTORY for archiving.
MSC_ITEM_SUPPLIERS	Stores relationships between company items and supplier items.
MSC_ITEM_CUSTOMERS	Stores relationships between company items and customer items.



---

# Glossary

## **allocated on hand**

Inventory amount posted by a trading partner indicating the quantity of inventory physically in stock that is intended for the use of the trading partner receiving the communication. The date to be used by the trading partner for this order type is Actual Date. This indicates the physical inventory held by the trading partner for the intended purpose.

## **amount based order**

An order you place, receive, and pay based solely on the amount of service you purchase.

## **anchor date**

The start date of the first repetitive planning period. It introduces consistency into the material plan by stabilizing the repetitive periods as time passes so that a plan run on any of the days during the first planning period does not change daily demand rates.

## **annual carrying cost**

Cost of carrying inventory, defined as a percent of the dollar value of inventory per year.

## **ANSI**

American National Standards Institute which establishes national standards for the United States. The parent organization for X12 and also serves as the North American representative to ISO (International Standards Organization).

## **ANX**

Automotive Network Exchange. A common, global TCP/IP network infrastructure created to meet the data communications needs of the automotive industry. Using ANX, each automotive supplier and OEM needs only a single commercial grade TCP/IP data transport connection to communicate globally with all trading partners. This network meets specific automotive industry requirements for performance, reliability, security and management.

**API**

An application programming interface (API) is a published interface to accomplish a business or scientific function. An API defines a contract to its users by guaranteeing a published interface but hides its implementation details.

**assemble to order (ATO) item**

An item you make in response to a customer order.

**assemble to order (ATO) model**

A configuration you make in response to a customer order that includes optional items.

**assembly**

An item that has a bill of material. You can purchase or manufacture an assembly item.  
**see assemble to order, bill of material.**

**available to promise (ATP)**

Refers to the ability to promise finished goods availability based on a statement of current and planned material supply.

**ATP**

*See available to promise.*

**ATR**

*See available to reserve.*

**ATS**

Authorized To Ship. This term applies to sales order lines eligible to enter the workflow processes which ultimately result in shipment of the product to the customer (such as production, departure planning, picking, and ship/confirm). It distinguishes them from sales order lines which are not eligible for any shipment related processing.

**ATT**

*See available to transact.*

**attachment**

Any document associated with one or more application entities. You can view attachments as you review and maintain an entity. Examples include: operation instructions, purchase order notes, item drawings, or an employee photo.

**attribute**

A basic data element used by Oracle Pricing to control pricing activity. For example, Pricing uses attributes to define the eligibility of a customer order to receive a particular

price or modifier. In Oracle Pricing, individual attributes are obtained from data sources that are called contexts. Pricing attributes may also be used as elements of a pricing formula.

**attribute collection element**

A collection element that represents the outcome of a process. **See collection element types.**

**Attribute / Domain**

An Attribute, as used here, is a Web Applications Dictionary term used to describe the common properties of fields that have same semantics. For example, Customer name attribute can be reused anytime where the name of a customer need to be represented in the system. Syn. Domain. In some part of this document, the term WAD: Attribute is used instead, to avoid confusion with the generic usage of 'Object. Attribute '

**authorization**

The act of marking a notification as approved or not approved. This would release or confirm the Hold on an Order.

**authorization check**

A set of tests on a purchasing document to determine if the document approver has sufficient authority to perform the approval action.

**authorized quantity**

The authorized quantity is how many of an item that can be sent back to the warehouse from the customer. This is the booked quantity.

**AutoAccounting**

A feature used by Oracle Projects to automatically determine the account coding for an accounting transaction based on the project, task, employee, and expenditure information. A feature that lets you determine how the Accounting Flexfields for your revenue, receivable, freight, tax, unbilled receivable and unearned revenue account types are created.

**autocharge**

A method of charging a discrete job or repetitive schedule for the resources consumed at an operation.

**autoimplement**

To implement an ECO's revised item automatically on its effective date by setting the revised item status to **Scheduled** and running the autoimplement manager.

**autoimplement manager**

An Engineering program that automatically implements all ECO revised items with a status of **Scheduled** and whose effective date is less than or equal to the current date.

**AutoInvoice**

A program that imports invoices, credit memos, and on account credits from other systems to Oracle Receivables.

**Automated Clearing House (ACH)**

A nationwide network operated by the Federal Reserve used to connect banks together for the electronic transfer of funds.

**Automatic Modifier**

In Oracle Pricing, a control that allows you to specify that the Pricing Engine apply a modifier automatically to a transaction, assuming that the transactions meets the qualifier eligibility.

**automatic note**

A standard note to which you assign addition rules so it can be applied automatically to orders, returns, order lines, and return lines. **see one time note, standard note.**

**automatic numbering**

A numbering option Purchasing uses to assign numbers to your documents, employees, or suppliers automatically.

**automatic rescheduling**

Rescheduling done by the planning process to automatically change due dates on scheduled receipts when it detects that due dates and need dates are inconsistent.

**automatic sourcing**

A Purchasing feature which allows you to specify for predefined items a list of approved suppliers and to associate source documents for these suppliers. When you create a requisition or purchase order line for the item, Purchasing automatically provides appropriate pricing for the specified quantity based on the top ranked open source document for the supplier with the highest percentage allocation.

**Automotive Address Extras**

Used since Release 11 of Oracle Automotive. The Automotive Address Extras represented ship from/ship to data that was established in Oracle Automotive, and exported to Radley CARaS.

Note that automotive address extras are not used in Release 11*i*. Instead, the ship from/ship to terms window is used to store information critical to Oracle Release

Management.

**autonumber**

A function to automatically default engineering change order (ECO) numbers when you create a new ECO. You can define an autonumber prefix and sequence for all users across all organizations, all users in one organization, one user across all organizations, and one user in one organization.

**autorelease**

To automatically release the next available repetitive schedule upon completion of the current repetitive schedule.

**autoschedule**

You can set up a supplier/site/item to have the schedules built by the concurrent program autoschedule. The schedules are not built by the Scheduler's Workbench.

**available capacity**

The amount of capacity available for a resource or production line.

**available to promise (ATP)**

The quantity of current on hand stock, outstanding receipts and planned production which has not been committed through a reservation or placing demand. In Oracle Inventory, you define the types of supply and demand that should be included in your ATP calculation.

**available to promise quantity**

*See available to promise (ATP).*

**available to promise rule**

A set of Yes/No options for various entities that the user enters in Oracle Inventory. The combination of the various entities are used to define what is considered supply and demand when calculating available to promise quantity.

**Available To Reserve (ATR)**

The quantity of on hand stock available for reservation. It is the current on hand stock less any reserved stock.

**Available To Transact (ATT)**

Quantity on hand less all reservations for the item which may be transferred within or out of inventory.

**average costing**

A costing method which can be used to cost transactions in both *inventory only* and *manufacturing* (inventory and work in process) environments. As you perform transactions, the system uses the transaction price or cost and automatically recalculates the average unit cost of your items.

**average cost variance**

A variance account used to hold amounts generated when on hand inventory quantity is negative and the unit cost of a subsequent receipt is different from the current unit cost.

**backflush operation**

A routing operation where you backflush component items.

**backflush transaction**

A material transaction that automatically issues component items into work in process from inventory when you move or complete the assembly. Also known as post deduct or pull. See *pull transaction*.

**backorder**

An unfulfilled customer order or commitment. Oracle Order Management allows you to create backorders automatically or manually from released order lines. See *Pick Release*.

**backordered lines**

Unfulfilled order line details which have failed to be released at least once by Pick Release or have been backordered by Ship Confirm.

**backward consumption days**

A number of days backwards from the current date used for consuming and loading forecasts. Consumption of a forecast occurs in the current bucket and as far back as the backward consumption days. If the backward consumption days enters another bucket, the forecast also consumes anywhere in that bucket. When loading a forecast, only forecasts of the current date minus the backward consumption days are loaded. Therefore, you can use backward consumption days to load forecasts that are past due.

**backward scheduling**

A scheduling technique where you specify a production end date and Oracle Manufacturing calculates a production start date based on detailed scheduling or repetitive line scheduling.

**balancing entity**

An organization for which you prepare a balance sheet, represented as a balancing segment value in your accounting flexfield. This is the equivalent of a fund in government organizations. Examples include companies, strategic business units, and divisions.

**balancing out**

The process of monitoring and balancing production of a scheduled item as it moves into a later phase in its life cycle. The item's planned change in status may be known up to a year in advance, and is closely monitored during the last few months of the model year by both the customer and supplier.

**balancing segment**

An Accounting Flexfield segment you define so that Oracle General Ledger automatically balances all journal entries for each value of this segment. For example, if your company segment is a balancing segment, Oracle General Ledger ensures that within every journal entry, the total debits to company 01 equal the total credits to company 01. An Accounting Flexfield segment you define so that Oracle Order Management automatically balances all journal entries for each value of this segment. For example, if your fund segment is a balancing segment, Oracle Government General Ledger assures that with every journal entry, the total debits to Fund 01 equals the total credits to Fund 01.

**bankers automated clearing system (BACS)**

The standard format of electronic funds transfer used in the United Kingdom.

**base currency**

*See functional currency.*

**Base Layer**

The generic code independent of a Trading Partner. It consists of PL/SQL program units published as customizable by Oracle Development teams. Trading Partner Layers can be built only on those program units designated by an Oracle Development team as published.

**base model**

The model item from which a configuration item was created.

**Base Price**

The original price for an item obtained from the Price List; the price before any price adjustments are applied. Also known as List Price.

**base unit**

The unit of measure to which you convert all units of measure within one class. The base unit is the smallest or most commonly used unit of measure in the class. For example, millimeter is the base unit in the Length class. You define your base unit of measure when you create your unit class.

**basic ATP**

This term is used to describe the task of performing an ATP check against a given organization.

**batch sources**

A source you define in Oracle Receivables to identify where your invoicing activity originates. The batch source also controls invoice defaults and invoice numbering. Also known as **invoice batch sources**.

**behind**

Quantities were not delivered in time (past due) in context of the customer's anticipated delivery date, or an under shipment occurred. The supplier must control this situation in such a way that he will deliver these quantities as soon as possible. *See: ahead.*

**Benefits**

In Oracle Pricing, modifiers that result in non monetary adjustments to an order. Types of benefits include: Item upgrade, free items, change in payment or shipment terms. **See also Price Adjustments.**

**best discount**

The most advantageous discount for the customer. For example, suppose you have a customer discount of 15% and a item discount of 25% for Product B. If you enter an order line for the customer for Product A, the line is discounted 15%. If you enter an order line for the customer for product B, the line is discounted 25%.

**best price**

The modifier which gives the lowest price or most advantageous price to the customer on the given pricing line will be applied.

**best price**

An alternative method to precedence which is used to determine which modifier should be selected when multiple modifiers in the same exclusivity or incompatibility group are eligible to be applied to the same pricing line within a pricing phase. The modifier which gives the lowest price or most advantageous price to the customer on the given pricing line will be applied. **See also Precedence.**



**bill of distribution**

Specifies a multilevel replenishment network of warehouses, distribution centers, and manufacturing centers (plants).

**bill of lading**

A carrier's contract and receipt of goods transported from one location to another.

**Bill of Material**

A list of component items associated with a parent item and information about how each item relates to the parent item.

**bill of material**

A list of component items associated with a parent item and information about how each item relates to the parent item. Oracle Manufacturing supports standard, model, option class, and planning bills. The item information on a bill depends on the item type and bill type. The most common type of bill is a standard bill of material. A standard bill of material lists the components associated with a product or subassembly. It specifies the required quantity for each component plus other information to control work in process, material planning, and other Oracle Manufacturing functions. Also known as **product structures**.

**bill of resource set**

A group of bills of resources. A bill of resource set can have one or many bills of resources within it.

**bill of resources**

A list of each resource and/or production line required to build an assembly, model, or option.

**branch**

A link between a Trading Partner Layer program unit and a Base Layer program unit.

**bucket days**

The number of workdays within a repetitive planning period.

**bucket type: daily**

Bucket based on a single calendar day.

**bucket type: flexible**

When the customer specifies the start date and end date of the bucket, instead of using standard bucket types of daily, weekly, monthly or quarterly.

**bucket type: monthly**

Bucket based on a calendar month.

**bucket type: quarterly**

Bucket based on calendar quarters (Jan - Mar, Apr - Jun, Jul - Sep, Oct - Dec.)

**bucket type: weekly**

Bucket based on a weekly interval, usually Monday through Sunday.

**bucket patterns**

Bucket patterns can be defined to include daily, weekly, monthly, or quarterly buckets. Bucket patterns are used to bucket quantity requirements on Planning or Shipping Schedules.

**Buckets: Pricing**

A feature in Oracle Pricing that determines how modifier price adjustments are applied to the list price of an item to calculate the selling price. Modifiers use the previous buckets sub total for percentage calculation. Modifiers within the same bucket are Additive i.e. added together, and subtracted from the previous buckets total. The user can create an unlimited amount of buckets to calculate selling price. For example, discounts associated with bucket 0 use list price as their calculation basis. Bucket 1 prices use the subtotal resulting from subtracting bucket 0 discounts from list price as their calculation. Bucket 2 uses the subtotal remaining after subtracting bucket 1 discounts from the bucket 0 subtotal, and so forth.

**budget organization**

An entity, such as a department, division, or activity responsible for entering and maintaining budget data. You define budget organizations for your agency, then assign appropriate accounting flexfields to each budget organization.

**budgetary account**

An account segment value (such as 6110) that is assigned one of the two budgetary account types. You use budgetary accounts to record the movement of funds through the budget process from appropriation to expended appropriation.

**build sequence**

The sequence of jobs within a schedule group. For example, you can use sequences to prioritize all jobs on a specific production line by customer. Similarly, you can use sequences to insure that jobs are built in reverse departure order thus facilitating truck loading. *See schedule group.*

**bulk items**

Component items on a bill of material not usually transacted directly to the job or repetitive schedule. Bulk items are usually charged to the work in process department where the item is consumed.

**bulk requirement**

*See bulk items.*

**business application**

Software that performs a particular business function or group of functions (accounts payable, for example).

**business document**

A document used for conducting business between two trading partners; a purchase order or invoice, for example.

**business group**

An organization which represents the consolidated enterprise, a major division, or an operation company. This entity partitions Human Resources information.

**business object**

An independent item of significance in the business world, such as an order.

**business purpose**

The function a particular customer location serves. For example, you would assign the business purpose of Ship To an address if you ship to that address. If you also send invoices to that address, you could also assign the business purpose Bill To. Bill To and Ship To are the only business purposes recognized in Oracle Order Management. Each customer location must serve at least one function.

**buyer**

Person responsible for placing item resupply orders with suppliers and negotiating supplier contracts.

**buyer/customer and supplier/vendor**

The term supplier and Vendor are used synonymously in discussions about EDI transactions. The term buyer and customer are used synonymously in discussion about EDI transactions. The business entities are the trading partners for the PO Change transaction.

**by product**

Material produced as a residual of a production process. Represented by negative usage

in the bill of material for an assembly.

### **calculate ATP**

An item attribute the planning process uses to decide when to calculate and print available to promise (ATP) for the item on the Planning Detail Report. The planning process calculates ATP using the following formula:  $ATP = Planned\ production - committed\ demand$ .

### **Calculation Engine**

In Oracle Pricing the calculation engine is a part of pricing engine. It returns the price of an item/service.

### **Calculation Formula**

One of the most important tasks of a Kanban planning system is determining the optimal number of Kanban cards. The Kanban planning software takes care of this calculation provided you enter correct values for Kanban size, average daily demand for the Kanban item, and the lead time to replenish one Kanban. We provide a package that you can use to customize the calculation. See the Oracle Manufacturing, Distribution, Sales and Service Open Interfaces Manual. By default, the standard calculation is:  $(C - 1) * S = D * (L + SSD)$  where: C is the number of Kanban cards S is the Kanban size D is the average daily demand L is the lead time (in days) to replenish one Kanban. If you think through the Kanban process, you will see why this formula works best when the demand for the Kanban item is steady. In addition to this basic formula, when the calculation program calculates Kanban size, it takes into account the values for the following order modifiers (specified in the pull sequence), in the following order: Supply Days, Minimum Order Quantity, and Lot Multiplier. For example, suppose you have specified the Minimum Order Quantity for a particular item to be 50. You want the formula to calculate the Kanban size (S), so you enter values for S, D, and L. Even though strictly based on the values you enter for C, D, and L, the formula should yield 40, the actual Kanban size will be 50 because of your order modifier, assuming the Lot Multiplier is a factor of 50.

Note: The program uses order modifiers only when calculating the Kanban size. If you specify the Kanban size and want the program to calculate the number of Kanban cards, the program does not use order modifiers.

### **calendar type**

The period pattern used to define a manufacturing calendar.

### **capable to promise**

CTP (Capable to Promise) refers to the additional ability to determine the availability of component materials and resources to meet unplanned demands.

**capacity modification**

Deviation to available resources for a specific department shift.

**capacity requirements planning**

A time phased plan comparing required capacity to available capacity, based on a material requirements plan and department/resource information. *See routing based capacity and rate based capacity.*

**component demand**

Demand passed down from a parent assembly to a component.

**component item**

An item associated with a parent item on a bill of material.

**compound discounts**

Discounts that are applied on top of already discounted prices. *See buckets, pricing.*

**compression days**

The number of days the planning process suggests you compress the order (in other words, reduce the time between the start date and the due date).

**concurrent manager**

Components of your applications concurrent processing facility that monitor and run time consuming tasks for you without tying up your terminal. Whenever you submit a request, such as running a report, a concurrent manager does the work for you, letting you perform many tasks simultaneously.

**concurrent process**

A task in the process of completing. Each time you submit a task, you create a new concurrent process. A concurrent process runs simultaneously with other concurrent processes (and other activities on your computer) to help you complete multiple tasks at once with no interruptions to your terminal.

**concurrent queue**

A list of concurrent requests awaiting completion by a concurrent manager. Each concurrent manager has a queue of requests waiting in line. If your system administrator sets up simultaneous queuing, your request can wait to run in more than one queue.

**concurrent request**

A request to complete a task for you. You issue a request whenever you submit a task, such as running a report. Once you submit a task, the concurrent manager

automatically takes over for you, completing your request without further involvement from you, or interruption to your work. Concurrent managers process your request according to when you submit the request and the priority you assign to your request. If you do not assign a priority to your request, your application prioritizes the request for you.

**confidence percent**

The degree of confidence in a forecast that the forecasted item becomes actual demand. When loading schedules from a forecast, the confidence percent is multiplied by the forecast quantity to determine the schedule quantity.

**config item**

An item which represents a unique configuration of model (ATO) and its classes and options. A customer will enter his choice of classes and options for a given ATO model. This valid configuration of selected items is represented by a config item. A config item goes through the manufacturing process cycle, and is a shippable item.

**configuration**

A product a customer orders by choosing a base model and a list of options. It can be shipped as individual pieces as a set (kit) or as an assembly (configuration item).

**configuration bill of material**

The bill of material for a configuration item.

**configuration item**

The item that corresponds to a base model and a specific list of options. Bills of Material creates a configuration item for assemble to order models.

**configuration variance**

For Work in Process, this quantity variance is the difference between the standard components required per the standard bill of material and the standard components required per the work in process bill of material. Currently, this variance is included with the material usage variance.

**configurator**

A window that allows you to choose options available for a particular model, thus defining a particular configuration for the model.

**configure to order**

An environment where you enter customer orders by choosing a base model and then selecting options from a list of choices.

**consigned location**

The physical location of inventories that resides on the property of buyers and sellers through a consigned agreement with the manufacturer.

**consigned to (name of consignee)**

Show the exact name of the receiver of the goods, whether an individual person, party, firm or corporation. Note: When tendering a "Collect on Delivery shipment, the letters C.O.D. must be inserted before the name of the consignee.

**consume shortage backward**

An option used to calculate ATP information by using surplus quantity from prior periods to cover a period shortage.

**consume shortage forward**

An option used to calculate ATP information by using surplus quantity from future ATP periods to cover a period shortage.

**contact**

A representative responsible for communication between you and a specific part of your customer's agency. For example, your customer may have a shipping contact person who handles all questions regarding orders sent to that address. The contact's responsibility is the **contact role**.

**contact notifications**

How will we notify given contacts when certain business conditions arise. For example, if a shipment of product to a customer is going to be late, you may wish to notify the account manager that they should call the customer and let them know the problem.

**contact role**

A responsibility you associate to a specific contact. Oracle Automotive provides 'Bill To', 'Ship To', and 'Statements,' but you can enter additional responsibilities.

**container**

The receptacle (box, tank, etc.) in which items to be shipped are placed.

**contest field prompt**

A question or prompt to which a user enters a response, called context field value. When Oracle Applications displays a descriptive flexfield pop up window, it displays your context field prompt after it displays any global segments you have defined. Each descriptive flexfield can have up to one context prompt.

**context**

A data source used by Oracle Pricing to obtain attributes. For example, Oracle Pricing considers the customer order itself to be a context. Various attributes from the order, such as order date, can be used by Pricing to control the selection of a price or modifier. Oracle Pricing does not limit the number of contexts that can be defined. Any single context can supply up to 100 pricing attributes. *See also Dimension.*

**context element**

A collection element associated with a quality collection transaction. Values for context elements are automatically transferred to Oracle Quality as their parent collection transaction are entered.

**context field value**

A response to your context field prompt. Your response is composed of a series of characters and a description. The response and description together provide a unique value for your context prompt, such as 1500, Journal Batch ID, or 2000, Budget Formula Batch ID. The context field value determines which additional descriptive flexfield segments appear.

**context response**

*See context field value.*

**context segment value**

A response to your context sensitive segment. The response is composed of a series of characters and a description. The response and description together provide a unique value for your context sensitive segment, such as Redwood Shores, Oracle Headquarters, or Minneapolis, Merrill Aviation's Hub.

**context sensitive segment**

A descriptive flexfield segment that appears in a second pop up window when you enter a response to your context field prompt. For each context response, you can define multiple context segments, and you control the sequence of the context segments in the second pop up window. Each context sensitive segment typically prompts you for one item of information related to your context response.

**contract**

An agreement between you and a supplier for unspecified goods or services. This agreement may include terms and conditions, committed amount, and an effective and expiration date. You reference contract purchase agreements directly on standard purchase order lines. Purchasing monitors the amount you have spent against contract purchase agreements.



**conversion**

Converts foreign currency transactions to your functional currency. *See foreign currency conversion.*

**conversion formula**

The number that, when multiplied by the quantity of one unit of the source base unit, gives you the quantity of one unit of the destination base units in the interclass conversion. The number is also the conversion between units for standard unit conversion or item specific conversion.

**copy**

An AutoCreate option that lets a buyer designate a specific requisition line as the source of information that Purchasing copies to the purchase order or RFQ line.

**corporate exchange rate**

An exchange rate you can optionally use to perform foreign currency conversion. The corporate exchange rate is usually a standard market rate determined by senior financial management for use throughout the organization.

**cost base**

The grouping of raw costs to which burden costs are applied.

**cost breakdown category**

Breakdown of a project or task budget to categorize costs. You can categorize by expenditure category, expenditure type, job, or expenditure organization.

**cost distribution**

Calculating the cost and determining the cost accounting for an expenditure item.

**cost element**

A classification for the cost of an item. Oracle Manufacturing supports five cost elements: material, material overhead, resource, outside processing, and overhead.

**cost group**

An attribute of a project which allows the system to hold item unit costs at a level below the inventory organization. Within an organization, an item may have more than one cost if it belongs to multiple cost groups. Item costing can be specific to a single project if each project has a distinct cost group, or specific to a group of projects if all projects in that group are assigned to the same cost group.

**Cost of Goods Sold Account**

The general ledger account number affected by receipts, issuances and shipments of an

inventory item. Oracle Order Management allows dynamic creation of this account number for shipments recording using the OE Account Generator item type in Oracle Workflow. *See Account Generator.*

**cost sub element**

A subdivision of cost element. You can define unlimited cost subelements for each cost element.

**cost transaction**

The financial effect of your material, resource, overhead, job, and period example, each material quantity transaction may have several cost accounting entries, and each accounting entry is a cost transaction.

**cost type**

A set of costs for items, activities, resources, outside processing, and overheads. You may have unlimited cost types for each organization, but only one is used to record cost transactions. The Frozen Standard cost type is used for standard costing; the Average Costs type is used for Average costing. Others could be defined for simulation or temporary purposes.

**cost variance**

The difference between the actual and expected cost. Oracle Manufacturing and Payables supports the following cost variances: invoice price, resource rate, and standard cost variances.

**cotermination**

Setting the same end date for all ordered or renewed service programs.

**count point operation**

A default operation to move to and from where you record move and charge resource transactions. Also known as **pay point**.

**credit check**

An Oracle Order Management feature that automatically checks a customer order total against predefined order and total order limits. If an order exceeds the limit, Oracle Order Management places the order on hold for review. *See credit profile class, credit check rule.*

**credit check rule**

A rule that defines the components used to calculate a customer's outstanding credit balance. Components include open receivables, uninvoiced orders, and orders on hold. You can include or exclude components in the equation to derive credit balances consistent with your company's credit policies.

**credit memo**

A document that partially or fully reverses an original invoice amount.

**credit memo reasons**

Standard explanations as to why you credit your customers. *See return reason.*

**credit order type**

This is any header level transaction type that allows for return lines. The type is used to specify defaulting values for this credit order and an associated workflow.

**Critical Attributes**

Optional Matching Attributes should always have a value as turnaround data, regardless of what schedule type is associated with the demand. If this flag is on and the attribute does not have a value, the Demand Processor will issue a warning exception identifying it.

**critical path**

The series of operation start and completion dates and times that result from the detailed scheduling algorithm.

**cross reference**

A user defined link from an item number to another piece of information.

**CRP planner**

A process that may optionally be run as part of the planning process. The CRP planner calculates capacity requirements for resources and production lines using the material requirements calculated by the planning process.

**CSR**

Customer Service Representative

**CUM**

Total received for a supplier site, item, and organization within a CUM Period.

**CUM entity**

The identifier of the customer's business entity applicable for CUM Management when the supplier ships to a particular customer location. This may be the Ship To Location, Deliver To Location or Bill To Location, depending on the CUM Entity Type assigned to the Ship To/Ship From Terms relationship.

**CUM entity type**

The customer's business entity type applicable for CUM Management when the

supplier ships to a particular customer location. The valid CUM Entity Types are: Ship To/Ship From, Bill To/Ship From, Deliver To/Ship From, Ship To/All Ship Froms, Bill To/All Ship Froms, Deliver To/All Ship Froms.

### **CUM key**

The set of attribute values applicable to accumulation of shipments and CUM adjustments of a Customer Item in a Ship To / Ship From relationship. The applicable attributes are determined by the CUM Management Type and CUM Entity selected for the Ship To / Ship From relationship; the applicable values are captured at the time the CUM Key is created.

### **CUM management type**

The style of CUM Management applicable to a customer/supplier relationship. One of six styles of CUM Management may be associated with a customer/supplier relationship: No CUM Management, CUM By Date, CUM By Date/Record Year, CUM By Date/PO, CUM By Purchase Order, CUM Until Manual Reset at Item.

### **CUM period**

A defined period of time during which cumulative shipment, requirement, and resource authorization quantities are calculated, e.g. Record keeping year, Calendar Year, or life of Purchase Order. In the automotive industry, the CUM Period typically coincides with a customer's scheduled plant shutdown for record keeping year tooling changeovers. All ship from locations to the same customer destination will share the same CUM Period.

### **CUM Rule**

The definition of how the CUM is to be calculated for Customer Items under Release Management within a specific Ship To/Ship From relationship. The rule consists of the following components: CUM Management Type, CUM Entity, CUM Start Date, Shipment Inclusion Rule.

### **cumulative discounts**

Discounts whose percentages are summed up before applying the discount are referred to as Cumulative Discounts.

### **cumulative manufacturing lead time**

The total time required to make an item if you had all raw materials in stock but had to make all subassemblies level by level. Bills of Material automatically calculates this value. Purchased items have no cumulative manufacturing lead time.

### **cumulative received quantity**

The total quantity of goods (e.g. shipped or received) during a defined period of time, e.g. Model Year. This can be used by suppliers to represent year to date shipped and by

trading partners as year to date received.

**cumulative total lead time**

The total time required to make an item if no inventory existed and you had to order all the raw materials and make all subassemblies level by level. Bills of Material automatically calculates this value.

**cumulative yield**

Product of the yields at each operation, process, or event on a flow line.

**current aggregate repetitive schedule**

The sum of all current work in process repetitive schedules for an item for all lines for a given period in terms of a daily rate, and a start and end date. Current aggregate repetitive schedules can be firm or partially firm. If all current repetitive schedules for an item are firm, then the current aggregate repetitive schedule for the item is also firm. If some, but not all the current repetitive schedules for an item are firm, then the current repetitive schedule is partially firm.

**current average cost**

The current weighted average cost per unit of an item before a transaction is processed. *See new average cost.*

**current date**

The present system date.

**current on hand quantity**

Total quantity of the item on hand before a transaction is processed.

**current projected on hand**

Quantity on hand projected into the future if scheduled receipts are not rescheduled or cancelled, and new planned orders are not created as per recommendations made by the planning process. Calculated by the planning process as current supply: *(nettable quantity on hand + scheduled receipts) gross requirements*. Note that gross requirements for projected on hand does not include derived demand from planned orders. Note also that the planning process uses current due dates rather than suggested due dates to pass down demand to lower level items. *See projected available balance.*

**customer**

The organization which is in the process of placing an order with the company.

**customer address**

A location where your customer can be reached. A customer may have many addresses. You can also associate business purposes with addresses. Also known as customer

location. *See customer site.*

**customer agreement**

*See agreement.*

**customer agreement type**

*See agreement type.*

**customer bank**

A bank account you define when entering customer information to allow funds to be transferred from these accounts to your remittance bank accounts as payment for goods or services provided. *See remittance bank.*

**customer business purpose**

*See business purpose.*

**customer class**

A method to classify and group your customers. For example, you could group them by their business type, size, or location. You can create an unlimited number of customer classes.

**customer control number**

AIAG term for an external customer's order number for a finished good, e.g. a vehicle, apart from job numbers assigned in the production process.

**customer family agreement**

An agreement for a specific customer, available to any related customer. *see agreement, generic agreement.*

**customer interface**

A program that transfers customer data from foreign systems into Oracle Receivables.

**customer interface tables**

A series of two Oracle Receivables tables from which Customer Interface inserts and updates valid customer data into your customer database.

**customer item**

Allows you to define specific attributes for items per customer class, customer and ship to/bill to location. Demand Tolerance is an example for such an attribute.

**customer/item model**

Allows you to define specific attributes for items per customer class, customer and ship

to/bill to location. The loading order forward/reverse inverted/non inverted is an example of this attribute.

**customer item number**

Item Number used only by a particular customer, and it represents the item's name used in the customer's organization.

**customer item Vs. supplier item**

In Oracle Order Management, the term 'item' refers to the supplier's item. In Oracle Order Management, the term 'customer item' refers to the item as in the customer's application.

**customer item/order item**

In Oracle Order Management the term 'item' refers to the supplier's item. In Oracle Order Management the term 'customer item' is exactly that.

**customer job number**

The number customers assign to jobs on their production line. These numbers are arbitrarily assigned and not sequential.

**customer line number Vs. supplier line number**

The term 'customer line number' represents the line sequence number as defined in the Purchasing application. Once this number or code is assigned to a line in the *Purchase Order*, it should not be changed. The general term 'supplier line number' or Oracle Order Management's 'order line number' represents the line sequence number as defined in the Order Management application. Once this number or code is assigned to a line in the *sales order*, it should not be changed.

**customer location**

*See customer address.*

**customer merge**

A program that merges business purposes and all transactions associated to that business purpose for different sites of the same customer or for unrelated customers.

**customer model serial number**

In the Automotive industry, this is the Vehicle Identification Number (VIN).

**customer phone**

A phone number associated with a customer. You can also assign phone numbers to your contacts.

**customer product**

An entity that identifies a serviceable item or customer product. The customer product identifies not only the product and the customer, but also the product quantity, the product's serial number (if the product is under serial number control and has been assigned a serial number), the location of the product, the various contacts, such as service administration, support, and bill to associated with the product. A customer may have several of the same customer products.

**customer product line number**

A customer (trading partner) may have several production lines at their manufacturing facility. The production line number identifies a specific production line, where goods should be delivered to as per the customers specifications.

**customer production line number**

The identifier for the customer's production line, i.e. the line on which they are building the product. This can affect the delivery and departure if, for example, the customer wants all items for production line A123 to be on the same delivery.

**customer production sequence number**

A customer (trading partner) may have a particular sequence in which items are built into an assembly. For example, the customer may specify that the front axle of a car has a production sequence 45 assigned to it, while the production sequence of the rear axle is 46. *see loading order sequence, planning production sequence number.*

**customer profile**

A method used to categorize customers based on credit information. Oracle Receivables uses credit profiles to assign statement cycles, dunning letter cycles, salespersons, and collectors to your customers. You can also decide whether you want to charge your customers interest. Oracle Order Management uses the order and total order limits when performing credit checking.

**customer profile class**

These allow for grouping of customers with similar credit worthiness, business volume, and payment cycles. For each profile class you can define information such as credit limits, payment terms, statement cycles, invoicing, and discount information. The customer profile class when assigned to a customer provides the default values for this information.

**customer relationship**

An association that exists between customers that allows you to share agreements and bill to and ship to addresses.



**customer site**

A specific area or place, such as a building or a floor on a building, at a customer address. A customer address may have one or more related customer sites.

**customer specification**

*See specification type.*

**customer status**

The Active/Inactive flag you use to deactivate customers with whom you no longer do business. In Oracle Order Management, you can only enter orders, agreements, and returns for active customers, but you can continue to process returns for inactive customers. In Receivables, you can only create invoices for active customers, but you can continue collections activities for inactive customers.

**Customs Invoice**

An electronic or paper document for international shipments similar to a Ship Notice/Manifest, but including additional information to satisfy all customs requirements of the borders through which the shipment must pass, such as the value of the shipment, VAT code and amounts, tariff and duty information, port information, customs broker identification, exporter identification, import license information, and letter of credit information.

**cutoff date**

An indication of the last date to be included in a plan or horizon.

**cycle counting**

An inventory accuracy analysis technique where inventory is counted on a cyclic schedule rather than once a year.

**daily line capacity**

The daily production rate of assemblies on a production line. This is equal to the line speed (in hours) times the line production hours.

**daily quantity**

*See daily rate.*

**daily rate**

The number of completed assemblies a repetitive schedule plans to produce per day. Also known as production rate. *See repetitive rate*

**data group**

Specifies an ORACLE ID (user) and determines to which schema a responsibility's

windows connect.

**database diagram**

A graphic representation of application tables and the relationships among them.

**database view**

Provides access to an underlying database table. You do not need to know how the data is stored to use a database view. There are two types associated with Oracle Quality: the collection plan results and the collection import results database views.

**date**

Attributes are used to communicate date values.

**date effectivity**

Method to control the configuration of an assembly by assigning date ranges for the parent/component relationships. Component selection by MPS and MRP is based upon which components are valid for the date the components are required.

**days off**

The number of consecutive days off a shift has before a day on.

**days on**

The number of consecutive days that a shift works before a day off.

**deal**

A Modifier List type in Oracle Pricing that is a child of the modifier list type Promotion. A Deal is a group of modifiers that share the same header level qualifications and are reported together. A Deal is tied to a Promotion for reporting purposes only.

**decimal precision**

Decimal precision is the number of digits after the decimal point that will be displayed (with rounding).

**default material task**

Task to which project material costs are allocated if no matching rules are found for material task assignment. It is a rule with no material task assignment criteria specified.

**default resource task**

Task to which project resource costs are allocated if no matching rules are found for resource task assignment. It is a rule with no resource task assignment criteria specified.

**defaulting**

Defaulting refers to the supply of a value for a field that has no value.

**defaulting**

Used in Oracle Pricing to identify the supply of a value for an attribute. **See sourcing.**

**defaulting condition**

Defaulting condition is a Boolean condition built as a composite of defaulting criteria attribute validations, which will determine at run time how an object attribute should be defaulted.

**defaulting condition**

Used in Oracle Pricing to refer to the context/dimension name as well as the source system. Each attribute is defaulted differently according to which context is being defaulted.

**defaulting criteria attributes**

Defaulting criteria attributes are object attributes, that you can use to build defaulting conditions.

**defaulting value**

Information Oracle Order Management automatically enters depending on other information you enter.

**delayed service order**

An order for service against existing customer products. The service order is 'delayed' because service is ordered later than the product is ordered.

**delete entity**

An item, bill of material or routing you choose to delete.

**delete group**

A set of items, bills, and routings you choose to delete.

**delete subentity**

A component or operation you choose to delete.

**deletion constraint**

A business rule that restricts the entities you can delete. A deletion constraint is a test that must succeed before an item, bill, or routing can be deleted.

**delivering carrier**

This information should be supplied where shipments may be interlined with other carriers.

**deliver to contact (Ultimate Consignee)**

How will we record or default the name of the person who will ultimately receive the goods. The goods may not be under the responsibility of the Sold From organization when they are delivered. This information may be needed by onward carriers after the sold from organization has fulfilled its obligations to the customer.

**deliver to location**

A location where you deliver goods previously received from a supplier to individual requestors.

**delivery**

Internal delivery of items to requestors within your organization.

**delivery**

A set of order lines to be shipped to a customer's ship to location on a given date in a given vehicle. Multiple deliveries can be grouped into a single departure. A single delivery may include items from different sales orders and may include backorders as well as regular orders.

**delivery assignment**

Defines the relationship of deliveries and child deliveries through consolidations as well as the relationship between delivery details and itself to track containerization of items.

**delivery date**

The date on which the product is to arrive at the Ship To Location. This date is either specified by the customer on a delivery based demand transaction, or calculated by applying in transit lead time to a customer specified Shipment Date.

**delivery detail**

Contains items to be shipped out of a warehouse. This may be a sales order line, an RMA line, a WIP line or a PO line. They can be referred to as deliverables.

**Delivery Instruction (DELINS)**

The Delivery Instruction Message is sent by a buyer to provide information regarding details for both short term delivery instructions and medium to long term requirements for planning purposes according to conditions set out in a contract or order.

**delivery lead time**

Time (in days) it takes for items to reach the customer once it is shipped. It accounts for any non working days in between.

**delivery leg**

A single segment of a delivery. Every delivery consists of at least two legs, when the delivery is picked up and dropped off, but may travel through several intermediate legs.

**delivery line**

A shippable and booked line from the planning pool which has been allocated to a delivery. After allocation, the line is no longer available in the planning pool. After the delivery is closed, the delivery line will also be considered closed.

**Delivery Shipping Notice Outbound (DSNO)**

An Advanced Ship Notice generated by Oracle e Commerce Gateway for a shipped delivery.

**demand**

Current or future product need communicated by the customer to the supplier, via EDI or other means. Sources of demand include Purchase Orders, Planning Schedules, Shipping Schedules, and Sequenced Production schedules.

**demand class**

A classification of demand to allow the master scheduler to track and consume different types of demand. A demand class may represent a particular grouping of customers, such as government and commercial customers. Demand classes may also represent different sources of demand, such as retail, mail order, and wholesale.

**demand history**

Historical inventory issue transactions against an item.

**demand interface**

A data collection point that collects and stores all sales order demand and reservation information.

**demand management**

The function of recognizing and managing all demands for products, to ensure the master scheduler is aware of them. This encompasses forecasting, order entry, order promising (available to promise), branch warehouse requirements, and other sources of demand.

### **Demand Processor**

The Oracle Release Management program that resolves items from an Oracle open interface demand schedule file, validates demand data against Oracle Applications information, then passes the demand into Oracle Order Management to create or replace sales order lines or into Oracle Planning (Oracle Master Scheduling/MRP and Oracle Supply Chain Planning) to create or replace forecasts.

### **demand schedule**

A planning, shipping, or sequenced production schedule received by a supplier from a customer, usually in an EDI file format.

### **Demand Time Fence**

Item attribute used to determine a future time inside which the planning process ignores forecast demand and only considers sales order demand when calculating gross requirements for an item. Use this attribute to identify a time fence inside which you wish to build to sales order demand only to reduce the risk of carrying excess inventory. A value of **Cumulative manufacturing lead time** means Master Scheduling/MRP calculates the demand time fence for the item as the plan date (or the next workday if the plan is generated on a non workday) plus the cumulative manufacturing lead time for the item. A value of **Cumulative total lead time** means Master Scheduling/MRP calculates the demand time fence for the item as the plan date (or the next workday if the plan is generated on a non workday) plus the total manufacturing lead time for the item. A value of **Total lead time** means Master Scheduling/MRP calculates the demand time fence for the item as the plan date (or the next workday if the plan is generated on a non workday) plus the total lead time for the item. A value of **User defined time fence** means Master Scheduling/MRP calculates the demand time fence for the item as the plan date (or the next workday if the plan is generated on a non workday) plus the value you enter for Planning Time Fence Days for the item.

### **Demand Time Fence Days**

Item attribute used when you set the Planning Time Fence attribute to **User defined time fence**. Master Scheduling/MRP calculates the demand time fence for the item as the plan date (or the next workday if the plan is generated on a non workday) plus the value you enter here.

### **department**

An area within your organization that consists of one or more people, machines, or suppliers. You can also assign and update resources to a department.

### **department class**

A group of departments.

**departure**

A set of order lines that will be shipped in a specific vehicle on a given date/time. The departure may include multiple deliveries if items being shipped are destined for different customers or customer ship to locations.

**departure order**

The order of jobs within a schedule group. Jobs are normally sequenced within a schedule group in the order that they must be loaded onto the truck for shipment. **see schedule group and build sequence.**

**departure planned lines**

Scheduled delivery lines that have been planned for a specific departure.

**departure planning**

The process of planning the necessary vehicles and grouping the scheduled shipments that will be included in a given departure. Planning the departure requires consideration of vehicle load capacities, container capacities and, in the case of 866 (sequenced) transactions, the loading order required to satisfy the customer's specified unload order.

**departure planning mandatory**

A flag that indicates whether a scheduled shipment line must be departure planned before it can be pick released. The value of this flag is set for the customer/item. Also known as **planning mandatory.**

**departure planning pool**

All of the scheduled shipment lines available to be departure planned. These include scheduled shipment lines that have not been shipped and are not currently part of a planned departure. Also known as **planning pool.**

**Departure Planning Workbench (DPW)**

Related windows that manage departures and deliveries. These integrated windows are presented to the user as a workbench.

**dependencies**

Dependencies, as used here, means that cached values in the database, identified by table and column, are related to one or more other values, also identified by table and column. The dependency of the latter values to the former causes the latter values to be set to Missing if the former value is changed. Cascading Dependencies result when there are values dependent on one or more of the values changed to Missing, and they in turn are also made to be Missing.

**dependent demand**

Demand for an item that is directly related to or derived from the demand for other items. See *independent demand*.

**deposit**

A monetary amount charged to a customer, but returnable to a customer at a later date. For example security deposit on a container, or a deposit awaiting contract signature.

**descriptive flexfield**

A feature used to collect information unique to your business. You determine the additional information you need and descriptive flexfield lets you customize your application to your needs without additional programming.

**destination base unit**

The unit of measure to which you are converting when you define interclass conversions. Your destination base unit is the base unit of a unit class.

**destination city**

The city or unincorporated community name is important as freight charges are based on the actual destination of the shipment.

**destination county**

Some states have more than one city, town, or community with the same name. It is necessary to pinpoint the actual destination in these cases by indicating the county in which the destination is located.

**destination forecast**

The forecast you load into when copying a forecast into another forecast.

**destination organization**

An inventory organization that receives item shipments from a given organization.

**destination street**

The destination street name and number are very important. The consignee is extremely difficult to locate without the exact and proper street address to which the shipment is to be delivered. Therefore to avoid additional delivery charges and possible delays, it is imperative that this information be furnished.

**destination zip**

The zip is required to determine the exact location of the shipping point. Zip codes are the basis for many carriers freight charges. Presented to the user as a workbench.



**detail container**

Inner container that is enclosed within the master container. *See master container.*

**detailed message action**

A message representing one exception. Oracle Alert inserts the exception values into the text of the message.

**detailed scheduling**

A method of scheduling production that considers minute to minute resource availability information as well as exact resource requirements from routings.

**dimension sourcing**

Provides the rules for finding attribute values that have been defined in qualifier and pricing dimensions. For a given transaction, the Pricing Engine must receive all the values of the attributes defined in the qualifier and pricing dimensions (contexts) in order to determine which prices and/or benefits the transaction is qualified for. *See context.*

**direct receipt**

The receipt of an item directly to its final destination (either directly to the person who requested the item or directly to the final inventory location). It differs from a standard receipt in that it is received into a receiving location and delivered in one transaction, rather than received and delivered in two separate transactions.

**disable date**

A date when an Oracle Manufacturing function is no longer available for use. For example, this could be the date on which a bill of material component or routing operation is no longer active, or the date a forecast or master schedule is no longer valid.

**discount amount**

This is the difference between the list price and the selling price for the item. If the discount was specified as an "amount" discount, then this value will not change even if the price list changes. For example, if Item A's list price is \$10, and we have a 20% discount, then the discount amount is \$2. If we then change price lists, and Item A will cost \$20 on the new price list, the discount amount for that same 20% discount now becomes \$4. If however, the discount was not a percentage and was an "amount" discount of \$2, then whether the list price for the associated price list is \$10, \$20, or \$5, the discount amount will always be \$2.

**discount percent**

This is the selling price/list price (multiplied by 100 to make it a percentage). If the discount was specified as a "percent" discount, then this value will not change even if

the price list changes. For example, if Item A's list price is \$10, and we have a 20% discount, then the discount amount is \$2. If we then change price lists, and Item A will cost \$20 on the new price list, the discount amount for that same 20% discount now becomes \$4, but the percentage is still 20%. If however, the discount was not a percentage and was an "amount" discount of \$2, then whether the list price for the associated price list is \$10, \$20, or \$5, the discount amount will always be \$2. In that case, the percentage would be different for every price list.

### **discounts**

Is a Modifier type in Oracle Pricing that creates Pricing Adjustments which allows Pricing Engine to extend a reduced price for an order, specific line item, or group of lines.

### **discrete job**

A production order for the manufacture of a specific (discrete) quantity of an assembly, using specific materials and resources, in a limited time. A discrete job collects the costs of production and allows you to report those costs including variances by job. Also known as **work order** or **assembly order**.

### **discrete job**

Discrete jobs are used to manufacture assemblies using specific materials and resources within a start and end date. (Also known as work order or assembly order).

### **discrete manufacturing**

A manufacturing environment where you build assemblies in discrete jobs or batches. Different from a repetitive production environment where you build assemblies on production or assembly lines at a daily rate.

### **dispatch report**

A report that prioritizes planned production work based on operation schedule dates and times.

### **disposition**

Directions that describe how to dispose of inventory affected by an ECO. Engineering uses ECO disposition for informational purposes only.

### **distribution account**

An account where you record material, material overhead, resource, outside processing, and overhead charges incurred by a discrete job or repetitive assembly. In a standard costing system, this is where you record your standard costs.

### **distribution list**

A predefined list of electronic mail IDs that you can use rather than entering individual

mail IDs (To, Cc, and Bcc) when defining mail message alert actions in Oracle Quality.

**distribution resource planning (DRP)**

Application of replenishment inventory calculations to assist in planning of key resources contained in a distribution system, such as sourcing and transport. DRP is an extension of distribution requirements planning, which applies MRP logic to inventory replenishment at branch warehouses.

**dock date**

The date you expect to receive a purchase order.

**document**

Any document that furnishes information to support a business object or an action on the business object. Examples include: a purchase order document, an invoice document, a word processing file listing receiving instructions, CAD files citing an item's specifications, or video instructions of an assembly operation.

**document category**

Document category is a document attribute that is used to control where a document can be viewed or maintained. Oracle Applications will seed some document categories to correspond with previous functionality. You can maintain document categories and the functions which can use them as necessary

**document reference**

A message that precisely identifies the document or part of document you want to describe using standard or one time notes.

**document sets**

A grouping of shipping documents you can run from the Confirm Shipments window.

**Down time**

Time when a resource is scheduled for operation but is not producing for reasons such as maintenance, repair, or setup.

**drop shipment**

A method of fulfilling sales orders by selling products without handling, stocking, or delivering them. The selling company buys a product from a supplier and has the supplier ship the product directly to customers.

**dropship item**

An item which is going to be sourced externally from the vendor directly to our customer.

**DRP**

See *distribution resource planning*.

**DSNO**

Transaction code assigned to outbound electronic Departure Based Ship Notice/Manifest transaction in the Oracle e Commerce Gateway, based on information processed through the Oracle Departure Planning application.

**Dual Card Kanban**

A demand pull signal that uses a "move" and "produce" communication method. Generally, "move" cards are collected and when the "produce" lot size is reached, the "produce" card is used to create the replenishment. This procedure is generally used when a minimum order quantity is required as a result of long set up times or economic order cost.

**due date**

The date when scheduled receipts are currently expected to be received into inventory and become available for use.

**dunning letters**

A letter you send to your customers to inform them of past due debit items. Oracle Receivables lets you specify the text and format of each letter. You can choose to include unapplied and on account payments.

**duplicate**

An exception Oracle Alert located for the same action set during a previous alert check. Oracle Alert does not consider a detail action to contain a duplicate exception until Oracle Alert sends the final action level to a specific action set, and then locates the same exception for the same action set again. For example, if on Monday Oracle Alert notifies a buyer that a supplier shipment is overdue, then on Tuesday Oracle Alert finds the shipment is still overdue, you can choose whether Oracle Alert should re notify the buyer or suppress the message.

**dynamic distribution**

You can use output variables to represent electronic mail IDs. When you define mail message alert actions in Oracle Quality, the message is sent to all defined mail IDs.

**dynamic insertion**

Automatically creates new accounting flexfield combinations as you enter them. If you do not use dynamic insertion, you create new accounting flexfield combinations with a separate window.

**dynamic lead time offsetting**

A scheduling method that quickly estimates the start date of an order, operation, or resource. Dynamic lead time offsetting schedules using the organization workday calendar.

**dynamically defined serial number**

Creating and assigning serial numbers as you need them, instead of creating serial numbers before their assignment.

**EDI**

*See Electronic Data Interchange (EDI).*

**EDIFACT**

Electronic Data Interchange for Administration, Commerce, and Trade is the current acronym for standards developed within Working Party 4. *See WP4.*

**effective date**

Date when an Oracle Manufacturing function is available for use. For example, this could be the date a bill of material component or routing operation becomes effective, or the date you anticipate revised item changes become part of a bill of material and can no longer be controlled by an ECO.

**effectivity**

Effectivity is used to control the addition or removal of a component or an operation from a bill of material or an assembly process. Effectivity control may be managed by model/unit number (also known as serial number effectivity) or by date.

**effective dates**

Start date and end date that a price, discount, surcharge, deal, promotion, or change is active.

**efficiency**

A productivity measure that focuses on actual performance against a standard. Expressed in a percentage figure, it is calculated by dividing actual resource time charged to a task by the standard resource requirements for the same task.

**efficiency variance**

A quantity variance defined as the difference between the amount of a resource (typically in hours) required at standard and the actual amount used to manufacture an assembly.

**elapsed time**

The clock time between start and completion. For example, if the build time of a resource is 10 hours, but you only schedule 5 hours of work a day, the elapsed time is 29 hours.

**electronic commerce**

Conducting business via an electronic medium. This includes methods of exchanging business information electronically, such as Electronic Data Interchange (EDI), FAX, email, and eforms.

**Electronic Data Interchange (EDI)**

Exchanging business documents electronically between trading partners. EDI subscribes to standard formats for conducting these electronic transactions as stated by various standards.

**electronic funds transfer**

A method of payment in which your bank transfers funds electronically from your bank account into another bank account. In Oracle Payables, funds are transferred from your account into that of a supplier. This information is sent to the bank in a file.

**elemental variance**

A work in process variance between the standard of an assembly and the actual charges to a standard job or repetitive schedule distributed by cost element.

**employee supervisor hierarchy**

An approval routing structure based on employee/supervisor relationships. *See position hierarchy.*

**encumbrance**

*See purchase order encumbrance.*

**encumbrance type**

An encumbrance category that allows you to track your expenditures according to your purchase approval process and better control your planned expenditures. You can set up separate encumbrance types for each stage in your purchasing cycle to track your spending at each level. Examples of encumbrance types are commitments (requisition encumbrances) and obligations (purchase order encumbrances).

**end assembly pegging**

A Pegging item attribute option the planning process uses to decide when to calculate and print end assemblies for the item on the Planning Detail Report. Even if you do not select this option, you can still calculate and view end assemblies for the item online.

**end date**

Signifies the last date a particular quantity should be forecast on a forecast entry. From the forecast date until the end date, the same quantity is forecast for each day, week or period that falls between that time frame. An entry without an end date is scheduled for the forecast date only.

**end item**

Any item that can be ordered or sold. *See finished good and product.*

**end item unit number**

End Item Unit Number, sometimes abbreviated as Unit Number, uniquely identifies which bill of material to be used for building a specific Model/Unit Number Effectivity controlled item.

**engineer to order**

An environment where customers order unique configurations for which engineering must define and release custom bills for material and routings. Oracle Manufacturing does not provide special support for this environment beyond the support it provides for assemble to order manufacturing.

**engineering change order (ECO)**

A record of revisions to one or more items usually released by engineering.

**engineering change order department**

A group of users that use the engineering change order system. You assign users to an ECO department to control access to your ECOs.

**engineering change order reason**

The purpose of an ECO.

**engineering change order status**

A classification you can use to track and control an ECO's life cycle. ECO statuses include: **Open, Hold, Release, Schedule, Implement, and Cancelled.**

**engineering change order type**

An ECO field that identifies the originating ECO department and the items you can include on an ECO (manufacturing or engineering).

**engineering item**

A prototype part, material, subassembly, assembly, or product you have not yet released to production. You can order, stock, and build engineering items.

**entity**

A data object that holds information for an application.

**Evaluated Receipts Settlement (ERS)**

A Payment on Receipt system, a process whereby Trading Partners generate payment obligation transactions in their accounts payable system upon receipt of a shipment of goods, eliminating the need for invoices or invoice transactions. This system combines information from the electronic Advance Shipment Notice (ASN), the receipt, and the purchase order. It ensures accurate and timely data processing. Also known as Self Billing.

**event alert**

An alert that runs when a specific event occurs that you define. For example, you can define an event alert to immediately send a message to the buyer if an item is rejected on inspection.

**events**

An event is an identifiable point in time among a set of related activities. Graphically, an event can be represented by two approaches: (1) in activity on node networks, it is represented by a node; (2) in activity on arc networks, the event is represented by the arc. In flow manufacturing, events are the lowest level of activities in a flow routing. Resources are assigned to events. Events can be grouped into processes and operations.

**exception**

An occurrence of the specified condition found during an alert check. For example, an alert testing for invoices on hold may find five invoices on hold, or none. Each invoice on hold is an exception.

**exception message**

A message received indicating a situation that meets your predefined exception set for an item, such as *Items that are overcommitted*, *Items with excess inventory*, and *Orders to be rescheduled out*.

**exception reporting**

An integrated system of alerts and action sets that focuses attention on time sensitive or critical information, shortens your reaction time, and provides faster exception distribution. Exception reporting communicates information by either electronic mail messages or paper reports.

**exchange rate**

A rate that represents the amount of one currency you can exchange for another at some point in time. Oracle Applications use the daily, periodic, and historical exchange rates you maintain to perform foreign currency conversion, re evaluation, and translation.



You can enter and maintain daily exchange rates for Oracle Automotive to use to perform foreign currency conversion. Oracle Automotive multiplies the exchange rate times the foreign currency to calculate **functional currency**.

**exchange rate type**

A specification of the source of an exchange rate. For example, a user exchange rate or a corporate exchange rate. See *corporate exchange rate*, *spot exchange rate*.

**Exchange Rate Variance (ERV)**

The difference between the exchange rate for a foreign currency invoice and its matched purchase order.

**exclusivity**

A feature in Oracle Pricing that determines if an order qualifies for multiple modifiers on an order, and if one of the modifiers is exclusive, then only the exclusive modifier is applied.

**expected receipts report**

A printed report of all expected receipts for a time period and location you specify.

**expenditure**

A group of expenditure items incurred by an employee or organization for an expenditure period. Typical expenditures include Timecards and Expense Reports.

**expenditure category**

An implementation defined grouping of expenditure types by type of cost.

**expenditure organization**

For timecards and expense reports, the organization to which the incurring employee is assigned, unless overridden by organization overrides. For usage, supplier invoices, and purchasing commitments, the incurring organization entered on the expenditure.

**expenditure type**

An implementation-defined classification of cost that you assign to each expenditure item. Expenditure types are grouped into cost groups (expenditure categories) and revenue groups (revenue categories). Expenditure types include: IPV, ERV, Tax, Freight, and Miscellaneous.

**expenditure type class**

An additional classification for expenditure types indicating how Oracle Projects processes the expenditure types. Oracle Projects predefines five valid expenditure type classes: Straight Time, Overtime, Expense Reports, Usages, and Supplier Invoices. For example, if you run the Distribute Labor Costs process, Oracle Projects will calculate the

cost of all expenditure items assigned to the Straight Time expenditure type class. Formerly known as **system linkage**.

**expense item**

Anything you make, purchase, or sell including components, subassemblies, finished products, or supplies and that does not carry a cost. Also known as a non asset item.

**expense subinventory**

Subdivision of an organization, representing either a physical area or a logical grouping of items, such as a storeroom where no value exists but the quantities may be tracked.

**explode**

An AutoCreate option that lets a buyer split a single requisition line for an item into one or more requisition lines for different items. Use this option to expand a requisition line for an item that your company purchases in component parts.

**exploder**

The first of the three processes that comprise the planning process under the standard planning engine. The exploder explodes through all bills of material and calculates a low level code for each item. The low level codes are used by the planner to ensure that net requirements for a component are not calculated until all gross requirements from parent items have first been calculated. The exploder runs before the snapshot and planner. Under the memory based planning engine, the memory based snapshot performs exploder functions.

**export paper**

A document required by governmental agencies that provides information on goods shipped out of or into a country.

**export licenses**

A government license to supply certain products to certain countries that would otherwise be restricted.

**express delivery**

An option that lets you deliver the entire quantity of a receipt without entering quantities for each shipment or distribution.

**express receipt**

A site option that lets you receive an entire purchase order or blanket purchase agreement release with one keystroke.

**express requisitions**

To create requisitions quickly from predefined requisition templates. You only need to

provide an accounting flexfield and quantities to create a requisition for commonly purchased items.

**extended line amount**

Oracle Order Management prints the extended order line amount for each order line.

**extended price**

The extended price is the cost of the line. This is computed by multiplying the selling price per unit by the number of units ordered on that line. Thus, if two of item A cost \$10.00 each, the extended price is \$20.00 for the line.

**extensible order contacts model**

How will we specify contacts for the order for any purpose relevant to your business.

**external forecast**

This is the forecast that is created based on the customers transmitted "forecasted" demand for a specific time horizon. The transmission of this forecast is predominantly via EDI. In Release Management any forecast information that is interfaced to MRP by the Demand Processor is considered external forecast.

**external system**

Any application outside of the Oracle environment.

**factor list**

In Oracle Pricing Formulas, factor lists may be linked to multiple pricing attributes or range of these attributes. For example, a glass with thickness between 0.1 to 0.3 mm will have a factor of 3 and a glass with thickness between 0.4 to 0.8 mm will have a factor of 5. The choice of factors from the factor list is made by the Pricing engine at the time the formula is computed. *See formula.*

**FAS**

Final Assembly Schedule. A discrete job created from a custom configuration or a standard configure to order item and linked to a sales order.

**FBO**

Feature Based Ordering (FBO), also known as Feature Based Releasing (FBR) and Attribute Based Releasing (ABR), is a business process of ordering and releasing product by specifying a feature or group of features rather than the traditional upper level identifier or item number.

**FBR**

Feature Based Releasing. This is an alternate acronym for FBO or ABR, used by Ford and others.

**Feeder Line**

A production line designed to feed sub assemblies to a line producing higher level assemblies.

**Feeder Line Synchronization**

A concurrent process that allows you to synchronize sub assembly flow schedules sequence with the parent assembly line flow schedule sequence.

**feeder program**

A custom program you write to transfer your transaction information from an original system into Oracle Application interface tables. The type of feeder program you write depends on the environment from which you are importing data.

**FIFO costing**

Costing method where it is assumed that items that were received earliest are transacted first.

**final assembly order**

A discrete job created from a configuration or an assemble to order item and linked to a sales order. Also known as final assembly schedule.

**final close**

A purchase order control you can assign to prevent modifications to or actions against completed documents, lines, and shipments by final closing them. Final closed documents are not accessible in the corresponding entry windows, and you cannot perform the following actions against final closed entities: receive, transfer, inspect, deliver, correct receipt quantities, invoice, return to supplier, or return to receiving.

**financial EDI**

The exchange of machine readable financial documents between a corporation and its financial institution. The exchange includes both collections and disbursements in the form of credit and debit transfers, related bank balance, banking transactions, and account analysis.

**finished good**

Any item subject to a customer order or forecast. *see product.*

**firm**

A purchase order control. When you firm an order, Master Scheduling/MRP uses the firm date to create a time fence within which it does not suggest new planned purchase orders, cancellations, or reschedule in actions. It continues to suggest reschedule out actions for orders within the time fence. If several shipments with different promised or

need by dates reference the same item, Master Scheduling/MRP sets the time fence at the latest of all scheduled dates.

**firm demand**

Inbound demand that Oracle Release Management passes as Authorized To Ship (ATS) to a sales order in Oracle Order Management.

**firm fence**

An optional Release Management setup feature which defines a range of days either from the beginning of the demand schedule horizon or following the optional frozen fence. The firm fence instructs the Demand Processor to override the demand status on the schedule with a Firm status when updating the sales order lines.

**firm flag**

Denotes a job that cannot be modified by the planning or rescheduling process. *See Oracle Master Planning/MRP User's Guide or Oracle Supply Chain Planning User's Guide.*

**firm planned order**

An MRP planned order that is firmed using the Planner Workbench. This allows the planner to firm portions of the material plan without creating discrete jobs or purchase requisitions. Unlike a firm order, a MRP firm planned order does not create a natural time fence for an item.

**firm scheduled receipt**

A replenishment order that is not modified by any planning process. It may be a purchase order, discrete job, or repetitive schedule. An order is firm planned so that the planner can control the material requirements plan.

**first unit completion date**

The date and time you plan to complete production of the first assembly on a repetitive schedule. This date equals the first unit start date plus the lead time.

**first unit start date**

The date and time you plan to begin production of the first assembly on a repetitive schedule. This date equates to the start of your lead time.

**Fixed Days Supply**

An item attribute the planning process uses to modify the size and timing of planned order quantities for the item. The planning process suggests planned order quantities that cover net requirements for the period defined by the value you enter here. The planning process suggests one planned order for each period. Use this attribute, for example, to reduce the number of planned orders the planning process would

otherwise generate for a discretely planned component of a repetitively planned item.

**fixed lead time**

The portion of the time required to make an assembly independent of order quantity, such as time for setup or teardown.

**Fixed Lot Size Multiplier**

An item attribute the planning process uses to modify the size of planned order quantities or repetitive daily rates for the item. For discretely planned items, when net requirements fall short of the fixed lot size multiplier quantity, the planning process suggests a single order for the fixed lot size multiplier quantity. When net requirements for the item exceed the fixed lot size multiplier quantity, the planning process suggests a single order with an order quantity that is a multiple of the fixed lot size multiplier quantity. For repetitively planned items, when average daily demand for a repetitive planning period falls short of the fixed lot size multiplier quantity, the planning process suggests a repetitive daily rate equal to the fixed lot size multiplier quantity. When average daily demand for a repetitive planning period exceeds the fixed lot size multiplier quantity, the planning process suggests a repetitive daily rate that is a multiple of the fixed lot size multiplier quantity.

**fixed order quantity**

An item attribute the planning process uses to modify the size of planned order quantities or repetitive daily rates for the item. When net requirements fall short of the fixed order quantity, the planning process suggests the fixed order quantity. When net requirements for the item exceed the fixed order quantity, the planning process suggests multiple orders for the fixed order quantity. For discretely planned items, use this attribute to define a fixed production or purchasing quantity for the item. For repetitively planned items, use this attribute to define a fixed production rate for the item. For example, if your suppliers can only supply the item in full truckload quantities, enter the full truckload quantity as the fixed order quantity for the item.

**fixed price discount**

A discount that fixes the final selling price of the item so it is not affected by changes to the list price of the item. It is a method of implementing discounts to the list price where the final price is contractually fixed regardless of changes to the list price, as is the case with GSA prices. For example, if Item A has a list price of \$100, a fixed price discount specifying a selling price of \$90 results in a selling price of \$90 even if the list price later increases to \$110.

**flexfield**

A field made up of segments. Each segment has a name you assign and a set of valid values. **seedescriptive flexfield and key flexfield.**

**flexfield segment**

One of the parts of your key flexfield, separated from the other parts by a symbol you choose (such as -, /, or \). Each segment typically represents a cost center, company, item family, or color code.

**flexible tolerance fences**

Shown as the percent increase or decrease over daily production rate available from a given supplier for a set amount of time.

**flow charging**

A repetitive transaction method where you charge material, move, resource, and overhead transactions to a specific assembly on a line rather than a specific repetitive schedule. *See repetitive allocation.*

**flow line**

The physical location where you manufacture a flow assembly, usually associated with a routing(s). You can build many different assemblies on the same line at the same time. Also known as assembly line or flow shop.

**flow manufacturing**

Manufacturing philosophy utilizing production lines and schedules instead of work orders to drive production. Mixed models are grouped into families and produced on lines balanced to the takt time.

**flow routing**

A sequence of manufacturing events that you perform to manufacture an assembly. In the flow routing, these events can be grouped in processes and balanced operations. A routing consists of an item, a series of events, processes and/or operations, a operation sequences, operation effective dates, and a flow routing network. You can also perform operation time, yield and total product cycle time calculations in the flow routing.

**Flow Routings and Sequence of Events**

Flow Routings define the production process of an assembly on the production line. You can use Flow Routings to define the processes and the sequence of events within each process. You can specify the setup, run, and move times for each event by associating the required resources.

**flow routing network**

A process map of your processes and operations where you specify the primary path, alternate paths, feeder lines and rework loops within your flow line.

**flow schedule**

A schedule for your flow line that represents the volume and mix of products to be produced. Scheduling can be done based on customer orders and scheduling rules, with an objective of matching the customer orders as closely as possible while establishing an achievable pace and consistent flow of products through the flow line. Schedules DO NOT produce work orders.

**flow workstation**

The assigned location on a flow line where a worker performs the job. It could be a machine or a workbench.

**FOB**

*See freight on board.*

**focus forecasting**

A simulation based forecasting process that looks at past inventory activity patterns to determine the best simulation for predicting future demand.

**folder**

A flexible entry and display window in which you can choose the fields you want to see and where each appears in the window.

**forecast**

An estimate of future demand on inventory items. A forecast contains information on the original and current forecast quantities (before and after consumption), the confidence factor, and any specific customer information. You can assign any number of inventory items to the forecast and use the same item in multiple forecasts. For each inventory item you specify any number of forecast entries.

**historical sales**

Used by a customer to communicate to supplier the actual sales for a given item, location, and period combination. The date that used by the customer is the Actual Date, as an indication of when the sale actual took place.

**forecast all**

For a Planning Schedule. This indicates that schedule forecast requirements include Unimplemented Planned Orders, Approved Requisitions, and Approved Supply Agreement Releases.

**forecast consumption**

The process of subtracting demand generated by sales orders from forecasted demand thereby preventing demand being counted twice in the planning period.



**Forecast Control**

An item attribute used to determine the types of demand you place for the item. Master Scheduling/MRP uses the option you choose here to guide the behavior of the key processes involved in two level master scheduling: forecast explosion, forecast consumption, planning, production relief, and shipment relief. This attribute is only appropriate for items that are models, option classes, options, or mandatory components of models and option classes. A value of **Consume** means you forecast demand for the item directly, rather than exploding forecast demand to the item using the forecast explosion process. A value of **Consume and derive** means you forecast demand for the item directly, or you explode forecast demand to the item using the forecast explosion process, or you use a combination of both methods to forecast demand for the item. A value of **None** means you place sales order demand but do not forecast demand for the item.

**forecast date**

The date for a forecast entry for an item. A forecast for an item has a forecast date and an associated quantity.

**forecast demand**

A part of your total demand that comes from forecasts, not actual sales orders.

**forecast end date**

A forecast end date implies that until that date, the same quantity is scheduled for each day, week, or period that falls between the forecast date and the end date. A forecast date with no forecast end date is the quantity for that particular day, week, or period, depending on the bucket size.

**forecast end item**

The parent item for components that receive exploded forecasts during forecast explosion. Used to identify the highest level planning or model item from which forecasts for a component can be exploded.

**forecast entry**

A forecast for an inventory item stated by a date, an optional rate end date, and quantity.

**forecast explosion**

Explosion of the forecast for planning and model bills of material. The forecasted demand for the planning or model bill is passed down to create forecasted demand for its components. You can choose to explode the forecast when loading a forecast.

**forecast fence (OM)**

An optional Release Management setup feature which defines a range of days from the

beginning of the demand schedule horizon or following the optional Frozen and firm fences. The Forecast Fence instructs the Demand Processor to override the demand status on the schedule with a Forecast status when updating the sales order lines.

**forecast fence (MRP)**

An optional Release Management setup feature which defines a range of days from the beginning of the demand schedule horizon or following the optional Frozen, Firm, and OM Forecast Fences. The MRP Forecast Fence instructs the Demand Processor to override the demand status on the schedule with a Forecast status and update MRP Planning rather than the sales order. When the demand is scheduled to be shipped later than the ending day of MRP Forecast Fence, the demand is not updated to MRP Planning.

**forecast level**

The level at which a forecast is defined. Also, the level at which to consume a forecast. Example forecast levels include items, customers, customer bill to, and customer ship to locations.

**forecast load**

The process of copying one or more source forecasts into a single destination forecast. When copying forecasts, you can choose to overwrite all or a subset of existing entries in the destination forecast, specify whether to explode the source forecast, and specify whether to consume the source forecast. You can choose to modify the source forecast by a modification percent, or roll the source forecast forward or backward by a specified number of carry forward days. You can also load compiled statistical and focus forecasts from Inventory, and you can use the forecast interface table to load forecasts into Master Scheduling/MRP from external sources.

**forecast only**

For a Planning Schedule, indicates that the schedule forecast requirements include Unimplemented Planned Orders and Approved Requisitions.

**forecast set**

A group of complementing forecasts. For each forecast set, you specify a forecast level, consumption use, update time fence days, outlier update percents, disable date, default time bucket and demand class. A forecast set can have one or many forecasts within it.

**foreign currency**

A currency you define for your set of books for recording and conducting accounting transactions in a currency other than your functional currency. When you enter and pay an invoice in a foreign currency, Oracle Automotive automatically converts the foreign currency into your functional currency based on the exchange rate you define. *See exchange rate, functional currency.*

**FORMs**

References to Application forms which can be used to either view additional information about the work item, or perform the activity requested by the notification. The Notification Viewer will allow the responder to launch these forms.

**formula**

A mathematical formula used in Oracle Pricing to define item pricing or modifier adjustments. You create a pricing formula by combining pricing components and assigning a value to the components.

**forward**

An action you take to send a document to another employee without attempting to approve it yourself.

**forward consumption days**

A number of days forward from the current date used for consuming and loading forecasts. Consumption of a forecast occurs in the current bucket and as far forward as the forward consumption days. If the forward consumption days enters another bucket, the forecast consumes anywhere in that bucket, as well.

**forward scheduling**

A scheduling technique where you specify a production start date and Oracle Manufacturing calculates a production end date using either detailed scheduling or repetitive line scheduling.

**four way matching**

Purchasing performs four way matching to verify that purchase order, receipt, inspection and invoice quantities match within tolerance.

**freeze**

You can freeze a purchase order after printing. By freezing a purchase order, you prevent anyone from adding new lines or changing the purchase order. You can continue to receive goods and be billed on already existing purchase order lines. The ability to continue receiving against the purchase order is the difference between freezing and cancelling.

**Freight and Special Charges**

Freight and special charges can be entered with the original order. The functionality of Freight and Special Charges for Order Management is not yet finalized. The layout of this report should eventually include display of the Freight and Special Charges.

**freight on board(FOB)**

The point or location where the ownership title of goods is transferred from the seller to the buyer.

**freight carrier**

A commercial company used to send item shipments from one address to another.

**freight charges**

A shipment related charge added during ship confirmation and billed to your customer.

**freight terms**

An agreement indicating who pays the freight costs of an order and when they are to be paid. Freight terms do not affect accounting freight charges.

**from city**

The city or unincorporated community name is important as freight charges are based on the actual origin of the shipment.

**from street**

A street name and number are necessary as some companies have more than one shipping location in the same city, town or community. The actual pick up point is essential for tracing purposes.

**from zip**

The zip is required to determine the exact location of the shipping point. Zip codes are the basis for many carriers freight charges.

**frozen**

Term to describe the independence of the Archive data from the standing data.

**frozen costs**

Costs currently in use for an operation, process, or item including resources, material and overhead charges. Under standard costing, you use the frozen costs for your cost transactions.

**frozen fence**

An optional Release Management setup feature which defines a range of days from the beginning of the demand schedule horizon. The frozen fence instructs the Demand Processor to leave existing sales order demand intact if the schedule indicates changes to demand within this time.

**fulfilled quantity**

In the Order Management schema, the accepted quantity was the number of items received from the customer on a given line that are approved to issue credit for. In Order Management, the accepted quantity is referred to as the fulfilled quantity.

**fulfillment**

Fulfilled sales order lines have successfully completed all Workflow processing activities up to the point of becoming eligible for invoicing.

**fulfillment method**

Fulfillment method is an activity which will be considered as a prerequisite before a line or a group of lines can be fulfilled. The fulfillment method must be associated with one and only one work flow activity. In this document fulfillment method and fulfillment activity have been used in the same context. If no fulfillment activity has been set in a flow for a line which is not part of any fulfillment set or PTO/KIT, the line will not wait at the fulfillment.

**fulfillment set**

Items in a fulfillment set will be available for scheduling and shipping only when all the items are available and ready to be scheduled/shipped. Fulfillment sets can be complete only, or partially allowed but in proportions. ATO model, and a PTO Ship model Complete will be in a fulfillment set.

**function**

A PL/SQL stored procedure referenced by an Oracle Workflow function activity that can enforce business rules, perform automated tasks within an application, or retrieve application information. The stored procedure accepts standard arguments and returns a completion result. **see function activity.**

**function activity**

An automated Oracle Workflow unit of work that is defined by a PL/SQL stored procedure. *See function.*

**functional acknowledgment**

The acknowledgment to indicate the results of the syntactical analysis of electronically encoded documents. Applies to a functional group and can include detail.

**functional currency**

Currency you use to record transactions and maintain your accounting information. The functional currency is generally the currency used to perform most of your company's business transactions. You determine the functional currency for the set of books you use in your organization. Also called **base currency.**

**funds available**

The difference between your budget, less encumbrances of all types and actual expenditures.

**funds checking**

The process of certifying funds available. You can check funds when you enter a requisition, purchase order, or invoice. You can check funds when you enter actual, budget, or encumbrance journals. When you check funds, the transaction amount is compared with your funds available, and you are notified whether funds are available for your transaction. Checking funds does not reserve funds for your transaction.

**funds reservation**

The creation of requisition, purchase order, or invoice encumbrance journal entries. Purchasing immediately updates your funds available balances and creates an encumbrance journal entry in which you can post in your general ledger. This is also the process of reserving funds available. You can reserve funds when you enter actual, budget, or encumbrance journals. When you reserve funds, the amount of your transaction is compared with your funds available and you are notified online whether funds are available.

**general ledger transfer**

The process of creating a postable batch for the general ledger from summarized inventory/work in process activity for a given period. Using Journal Import in General Ledger, you can create a postable batch in your general ledger. After running Journal Import, you can post your journal using the General Ledger posting process.

**General Services Administration**

*See GSA.*

**generic agreement**

An agreement without a specified customer, so it is available to all customers. *see agreement, customer family agreement.*

**goods**

The value before tax is calculated. The value on which tax is calculated.

**goods or services.**

This document also lists any tax, freight charges, and payment term.

**GRN (Goods Received Note)**

Goods Received Note. Synonym for receipt or material receipt.

**gross requirements**

The total of independent and dependent demand for an item before the netting of on hand inventory and scheduled receipts.

**gross weight**

The weight of the fully loaded vehicle, container, or item, including packed items and packaging material.

**Group API**

An API intended for use by other Oracle Application modules that have been authorized by the owning module. This form of API is less strict in its controls as compared to the Public API.

**group number**

The group no. for conditions that should together evaluate to TRUE (AND conditions).

**GSA(General Services Administration)**

GSA (General Services Administration): a customer classification that indicates the customer is a U.S. government customer. For products on the GSA price list, a fixed price must be used, defined on the GSA contract. The items contained on the GSA price list cannot be sold to commercial customers for the same or less price than the government price. In other terms, the price offered to the government must be the minimum in the market.

**GSA Discounts**

Discounts that can be specifically defined for giving the lowest selling price to some or all of the GSA customers.

A customer classification that indicates the customer is a U.S. government customer and pricing for products on the GSA price sheet should reflect the fixed pricing of the GSA contract. Whenever a product is on the GSA price sheet, it cannot be sold to commercial customers for the same or less price than the government customer.

**guarantee**

A contractual obligation to purchase a specified amount of goods or services over a predefined period of time.

**hard reservation**

Sales order demand that you *firm* by reserving selected inventory for the purposes of material planning, available to promise calculations, and customer service issues.

**hazard class**

A category of hazardous materials. Most hazardous materials belong to only one hazard

class. Some materials belong to more than one hazard class and some materials do not belong to any. If a material belongs to more than one hazard class, you should list these classes in a specific order.

**hidden collection plan**

A collection plan that consists entirely of context elements. Data collection for these collection plans occurs in the background and requires no user intervention.

**hierarchical levels**

The nesting of information within an electronic Ship Notice/Manifest. Each hierarchical level is identified with its own unique sequence number and, if nested, the sequence number of its parent hierarchical level.

**hierarchical structure**

Defines the actual layout of different hierarchical levels indicating the nesting of information in an electronic Ship Notice/Manifest transaction.

**hit/miss tolerance**

A limit you define for the difference between the on hand quantity and the actual cycle count quantity. You express positive and negative hit/miss tolerances as percentages of the on hand quantity.

**hold**

A feature that prevents an order or order line from progressing through the order cycle. You can place a hold on any order or order line.

**hold criteria**

A criterion used to place a hold on an order or order line. A hold criteria can include customers, customer sites, orders, and items.

**hold source**

An instruction for Order Management to place a hold on all orders or lines that meet criteria you specify. Create a hold source when you want to put all current and future orders for a particular customer or for a particular item on automatic hold. Order Management gives you the power to release holds for specific orders or order lines, while still maintaining the hold source. Oracle Order Management holds all new and existing orders for the customer or item in your hold source until you remove the hold source.

**hold type**

Indicates the kind of hold you place on an order or order line.



**immediate dispatch**

Used in conjunction with department or resource job filter criteria. Includes jobs where there is quantity in an operation assigned to the selected department or resource.

**implement**

To make an ECO active so that no further changes can be made to that ECO. Usually, the day you implement an ECO is also the effective date for component changes. After that date, you must make further changes through a new ECO or directly to the bill.

**implementation date**

The date a component becomes part of a bill of material and is no longer controlled through an ECO. Implementation date does not necessarily equal the effective date.

**Inbound/Outbound Lines**

In the Order Management schema, lines on a header are either ALL outbound; meaning sales order lines, in which material on the header is leaving the warehouse to go to a customer, or they are ALL inbound; meaning return lines, in which material on the header is arriving at the warehouse to be credited back to the customer. In Order Management, headers can be 'RETURN' (all inbound), 'ORDER' (all outbound), or 'MIXED' (both inbound and outbound lines).

**Inbound Purchase Order**

Inbound Purchase Order refers to the action of receiving purchasing information from customers and creating valid sales orders within Oracle Order Management.

**incident**

An entry logged in Oracle Service to record a customer's request for product service. You can log a different incident for each issue a customer reports including questions about products, problems using the products, requests for preventive maintenance, and requests for service contract renewals.

**included item**

A standard mandatory component in a bill, indicating that it ships (if shippable) whenever its parent item is shipped. Included items are components of models, kits, and option classes.

**Incompatibility**

A feature in Oracle Pricing that allows you to define groups of modifiers where the modifiers in a group are incompatible with each other. Modifiers in the same incompatibility group may not be used together on the same transaction. *See Precedence.*

**Industry Attributes**

Elements specific to an individual industry. An example of an industry attribute for the automotive industry would be the model year.

**independent demand**

Demand for an item unrelated to the demand for other items.

**initialization**

Defines cycle count classes and items, based on an already existing ABC compile.

**INO**

Transaction code assigned to outbound electronic Invoice transaction in the Oracle e Commerce Gateway, based on information processed through the Oracle AutoInvoice application.

**inspection**

A procedure you perform to ensure that items received conform to your quality standards. You can use inspections to prevent payment for goods and services that fail to meet your quality standards.

**Installation or Installation**

Detail Information about where your customers install product.

**Installed Base**

A collective noun to describe the sum total of all products that a company has responsibility to provide service for at customer sites.

**intangible item**

A non physical item sold to your customers such as consulting services or a warranty. Intangible items are non shippable and do not appear on pick slips and pack slips. *See shippable item.*

**inter organization transfer**

Transfer of items from one inventory organization to another You can have freight charges and transfer credits associated with inter organization transfer. You can choose to ship items directly or have them go through intransit inventory.

**interclass conversion**

The conversion formula you define between base units from the different unit classes.

**intercompany invoice**

An automatically generated statement that eliminates intercompany profit. This

transaction may occur between organizations in the same or different legal entities.

**intermediate ship to**

The delivery point for a shipment prior to an ultimate destination.

**internal forecast**

The forecast information created by the planners. It differs from the external forecast which is fed into MRP by transmissions from the customer.

**internal item number**

The internal representation of Item's Name within your organization.

**internal order**

A sales order in the Order Management system that is generated from an internal requisition in the Purchasing system and loaded into OM through Order Import.

**internal requisition**

A requisition in the Purchasing system that will directly result in the generation of a sales order in the Order Management system through the Order Import process in OM.

**internal sales order**

A request within your company for goods or services. An internal sales order originates from an employee or from another process as a requisition, such as inventory or manufacturing, and becomes an internal sales order when the information is transferred from Purchasing to Order Management. Also known as **internal requisition** or **purchase requisition**.

**intransit inventory**

Items being shipped from one inventory organization to another. While items are intransit you can view and update arrival date, freight charges, and so on.

**intraoperation steps**

The particular phases within an operation. There are five intraoperation steps in Work in Process: Queue, Run, To Move, Reject, and Scrap.

**inventory allocation**

The act of assigning on hand inventory to specific orders.

**inventory controls**

Parameter settings that control how Inventory functions.

**inventory item**

Items you stock in inventory. You control inventory for inventory items by quantity and value. Typically, the inventory item remains an asset until you consume it. You recognize the cost of an inventory item as an expense when you consume it or sell it. You generally value the inventory for an item by multiplying the item standard cost by the quantity on hand.

**inventory organization**

An organization that tracks inventory transactions and balances, and/or that manufactures or distributes products.

**inventory parameters**

The set of controls, default options, and default account numbers that determine how Inventory functions.

**inventory transaction**

A record of material movement. The basic information for a transaction includes the item number, the quantity moved, the transaction amount, the accounting flexfields, and the date. *See material transaction.*

**invoice**

A document you create in Oracle Receivables that lists amounts owed for the purchases of goods or services. This document may list any tax and freight charges.

A summarized list of charges, including payment terms, invoice item information, and other information that is sent to a customer for payment.

**invoice amount**

Oracle Order Management prints the invoice amount for each order listed on this report.

**invoice batch**

A group of invoices you enter together to ensure accurate invoice entry. Invoices within the same batch share the same batch source and batch name. Receivables displays any differences between the control and actual counts and amounts. An invoice batch can contain invoices in different currencies.

A Payables feature that allows you to enter multiple invoices together in a group. You enter the batch count, or number of invoices in the batch, and the total batch amount, which is the sum of the invoice amounts in the batch, for each batch of invoices you create. You can also optionally enter batch defaults for each invoice in a batch. When you enable you batch control system option, Multiple Organization in Oracle Applications automatically creates invoice batches for Payables expense reports, prepayments, and recurring invoices, and all standard invoices.

**invoice charges**

Includes Invoice Price Variance (IPV), Exchange Rate Variance (ERV), Freight, Tax, and Miscellaneous Charges. Since Release 11i the invoice charges are transferred from Oracle Payables to Oracle Projects for each project using the invoice charge transfer process.

**invoice item**

Oracle Order Management prints the name or/and description of the item on the invoice, depending on your selection for the Item Display parameter.

**invoice price variance**

The difference between the purchase order price for an item and the actual invoice price multiplied by the quantity invoiced. Payables records this variance after matching the invoice to the purchase order. Typically, the price variance is small since the price the supplier charges you for an item should be the one you negotiated on your purchase order. Upon invoice approval, Oracle Payable automatically records Invoice Price Variance to invoice price variance account.

**invoice set**

A invoice set is a group of order lines, linked by a common number, that you want the full quantity to invoice together. Thus, one invoice will contain amounts owed for the purchase of items put in one invoice set. ATO model, and a PTO Ship model Complete will be in a invoice set. Invoice sets can be complete only, or partially allowed but in proportion.

**invoice to contact**

How will we record or default the name of the person to whom the invoice will be sent. This is the person that the Accounts Receivable clerk will contact in the event of invoicing or collection queries.

**invoice value**

The total outstanding order value that needs to be invoiced.

**invoicing rules**

Rules that Oracle Receivables uses to determine when you bill your invoices. You can bill In Advance or In Arrears.

**issue transaction**

A material transaction to issue component items from inventory to work in process.

**item**

Anything you make, purchase, or sell, including components, subassemblies, finished

products, or supplies. Oracle Manufacturing also uses items to represent planning items that you can forecast, standard lines that you can include on invoices, and option classes you can use to group options in model and option class bills.

### **item (item type, key)**

Item identifies a specific process, document, or transaction that is managed by the workflow system. A row in the Items table is simply a proxy for the actual application item that is being workflow managed, it does not redundantly store application data in workflow tables. A workflow item is identified by its item type (e.g. "ORDER") and a "key" which is generated by the application based on a unique key of the real item (e.g. key "1003").

### **item activity status**

Item Activity Status stores the runtime status, completion results, etc. for each activity an item encounters as a process is run (e.g. item type: "ORDER" key: "1003", PA#103 ("LEGAL\_REVIEW"), state: "COMPLETE", result: "REJECTED"). Other runtime attributes such as the begin/end time for each activity and the user and notification id for outstanding notifications is also stored here. This table only contains state for active items. State information for closed items is moved to a history table.

### **item attribute control level**

To maintain item attributes at the item master attribute level or the organization specific level by defining item attribute control consistent with your company policies. For example, if your company determines serial number control at headquarters regardless of where items are used, you define and maintain serial number attribute control at the item master level. If each organization maintains serial number control locally, they maintain those attributes at the organization specific level.

### **item attribute value (item type, key, attribute name)**

An Item Attribute Value is an instance of an Item Attribute that is associated with a particular workflow item. For example, the 'TOTAL' attribute associate with the 'ORDER' item type would have a value row in this table for the specific instance of item '1003'. Using the Workflow API, Item Attribute Values can be looked up and set by any activity in the process, as well as by the external workflow managed application. Item attribute values are used to substitute runtime values into Message tokens when notifications are sent from Workflow.

### **item attributes**

Specific characteristics of an item, such as order cost, item status, revision control, COGS account, etc.

### **item based resource**

A resource whose usage quantity is the amount required per assembly unit you make.

**item category**

*See category.*

**Item/Entity Relationship**

The collection of key attributes defined by the customer which cause Planning or Shipping Schedule details to be processed together as a group. If the customer manages CUMs, it is usually the collection of key attributes on which the cumulative quantity is based. An Item/Entity consists of a unique combination of: Customer Item Number, Address entities deemed relevant to the customer, Other customer specific identifiers which separate items on a schedule, such as Purchase Order, Record Keeping Year, or Item Revision.

**item flexfield**

A feature that lets you define the structure of your item identifier according to your business requirements. You can define up to twenty segments for your item.

**item groups**

A group of related products that can be added to one or more price lists.

**item master level attribute**

An item attribute you control at the item master level as opposed to controlling at the organization level.

**item routing**

A sequence of manufacturing operations that you perform to manufacture an assembly. A routing consists of an item, a series of operations, an operation sequence, and operation effective dates. Edits to an Item Routing do not automatically update a job routing.

**master production schedule (MPS)**

The anticipated build schedule in terms of rates or discrete quantities, and dates.

**master schedule**

The name referring to either a master production schedule or a master demand schedule. *See master demand schedule and master production schedule.*

**master schedule load**

The process of copying one or more source forecasts, master schedules, or sales orders into a single destination master schedule. When copying forecasts, you can choose to include all or a subset of sales orders, specify whether to consider demand time fence, and specify whether to consume the source forecast during the load. You can also specify update options to control consumption of the source forecast during the load.

When copying master schedules, you can choose to modify the source master schedule by a specified number of carry forward days. When loading sales orders, you can choose to load all or a subset of sales orders, and you can specify whether to consider the demand time fence during the load. You can use the master schedule interface table to load master schedules from external sources.

**matching attributes**

Data elements used by Oracle Release Management's Demand Processor to compare new demand lines on inbound demand schedules to existing demand lines on Sales Orders for the purpose of demand reconciliation, to prevent unwarranted duplication of demand.

**material constrained plan**

In this plan, all material constraints that can be specified in the form of a supply schedule from manufacturing plants or by statements of vendor capacity from vendors are considered. When material availability is not a concern, resource availability constraints are used only to generate exceptions arising due to over utilization or under utilization of resources.

**material and resource constrained plan**

In this plan, you can generate a plan that respects material, resource, and transportation constraints. However, no plan objectives are considered.

**multi source**

An AutoCreate option that lets a buyer distribute the quantity of a single requisition line to several suppliers whenever the buyer wants to purchase the requisition line item from more than one supplier.

**multiple installations**

Refers to installing subledger products (AP, AR, PO, OE) multiple times. This is no longer necessary under a Multi Org implementation.

**multiple sets of books**

A General Ledger concept for having separate entities for which chart of accounts, calendar, or functional currency differs.

**NAFTA**

North American Free Trade Association.

**name of carrier**

It is important that the name of the carrier issuing the bill of lading be shown in this space to identify the second party to the bill of lading provisions. It also identifies the carrier who becomes responsible for the shipment and assumes responsibility.



### **National Automated Clearing House Association**

The NACHA is a non profit organization responsible for developing and maintaining the rules and guidelines for using the ACH network.

### **NATS**

Not Authorized To Ship. This term applies to sales order lines which are forecast status only, not eligible to enter any workflow processes which ultimately result in shipment of the product to the customer, such as production, departure planning, picking, and ship/confirm. This distinguishes them from sales order lines which are eligible for all shipment related processing (ATS).

### **Need by Date**

The date in the purchase order system that indicates when the item needs to be received in order for it to be of value to the requestor.

### **need by date**

The need by date for the end item is the demand date. The need by dates for the dependent demands are calculated based on the lead time offsets that are associated to the Items and routings used.

- If a constrained plan is run, the planning process will use the planned orders and actual routings for scheduling to derive the suggested due date.
- If an unconstrained plan is run, the suggested due date will simply be the same as the need by date.

Therefore, any differences between the lead time offsets (need by date) and actual manufacturing time (suggested due date) created by the planning process, will show up in the form of multiple exception messages.

### **negotiated capacity**

Used by a supplier to communicate to a customer the capability to produce a quantity of a certain item at a given location and time period. This capacity may be negotiated as part of a contract and is for visibility purposes. The date that the supplier uses in the document is the Ship Date to convey when the goods can ship to the customer's receiving location.

### **negative requirement**

A requirement supplied to a discrete job or repetitive schedule instead of being consumed by it. Negative requirements can be created to support by products or other reusable components.

### **nervousness**

Characteristic exhibited by MRP systems where minor changes to plans at higher bill of

material levels, for example at the master production schedule level, cause significant changes to plans at lower levels.

**net change simulation**

Process used to make changes to supply and demand and re plan them.

**net planning percent**

Percent of product that passes through a process or line operation. It equals the sum of the product of the network percentages at each operation along each path multiplied by 1 + the rework percent.

**net requirements**

Derived demand due to applying total supply (on hand inventory, scheduled receipts, and safety stock quantities) against total demand (gross requirements and reservations). Net requirements, lot sized and offset for lead time, become planned orders. Typically used for rework, prototype, and disassembly.

**net weight**

Weight of the contained load. Commonly calculated as GROSS TARE, this includes the weight of any packing materials (paper, cardboard separators, Styrofoam peanuts, etc.).

**nettable control**

An Oracle Manufacturing function that lets you specify whether the MRP planning process considers the requirements of the job or schedule in its netting calculations.

**network routing**

Network routings in Oracle Shop Floor Management comprise a collection of operations which include primary paths and alternate paths. You are able to define a separate routing for each item, at each sector. When you create routings in the Routings window, you define all possible paths.

**new average cost**

Cost of an item after a transaction that affects the average cost is processed. *See current average cost.*

**new on hand quantity**

The quantity on hand immediately after the transaction is performed and saved. Equal to current on hand quantity plus total quantity. *See current on hand quantity, total quantity.*

**node**

An instance of an activity in an Oracle Workflow process diagram as shown in the Process window of Oracle Workflow Builder. *See process.*

**non live**

Term to describe orders that are no longer subject to change.

**non quota sales credit**

*Seenon revenue sales credit*

**non replenishable kanban**

A non replenishable Kanban is used to replenish a Kanban location once. This card is used typically for custom products, one time customer orders or sudden spikes in demand.

**non revenue sales credit**

Sales credit you assign to your salespeople not associated to your invoice lines. This is sales credit given in excess of your revenue sales credit. *See revenue sales credit.*

**Non Revenue Sales Credits Sales**

Credit assigned to salespeople that is not associated to invoice lines. This is sales credit given in excess of your revenue sales credit and is not usually applied to a salesperson's quota.

**non standard asset job**

A type of non standard job carried as an asset during the life of the job.

**non standard discrete job**

A type of discrete job that controls material and resources and collects costs for a wide variety of miscellaneous manufacturing activities. These activities can include rework, field service repair, upgrade, disassembly, maintenance, engineering prototypes, and other projects. Non standard jobs do not earn material overhead upon assembly completion.

**non standard expense job**

A type of non standard job expensed at the close of each accounting period. Typical expense jobs include maintenance and repair.

**note name**

A name that uniquely identifies a standard or one time note. You use note names to locate a note you want to use or copy on a document.

**Not authorized to ship**

Demand that is planned to be ready on the date scheduled but not sent to the customers until some authorizing event occurs like Receipt of funds where prepayment has been requested. Credit approval for credit held orders. Customer Demand signal for Just In

Time deliveries.

### **Notification**

Activities are completed by some external entity (e.g. human). These activities have a "notification function" which is run to signal the external entity of its need to perform a task. Human notifications are associated with a Message defined in the Notification system. All notification activities may have a "time out" limit within which the activity must be performed. Process Definitions are also modeled as activities, which can then be referenced by other processes. The network of activities and transitions that define the process are maintained by in the Process Activities and Activity Transitions tables.

### **Notification Attributes**

(notification id, attribute name) For every notification, there will be a list of Notification Attributes, which hold the runtime value for each of the message attributes. These values are used to substitute subject and body tokens, and to hold user responses.

### **Notifications**

(notification id) Notifications are instances of messages which were actually sent to some role. The row as status flags to record the state of the notification, as well as date fields for when the notification was sent, due, and responded to. A new row is created in the Notifications table each time a message is sent to a role. The row persists even after the notification has been responded too, until a purge operation moves to closed notifications to an archive.

### **NUMBER**

attributes are used to communicate number values.

### **numeric number type**

An option for numbering documents, employees, and suppliers where assigned numbers contain only numbers.

### **object**

A region in Order Entry such as order, line, or shipment schedule. You can provide Security Rules for objects. *See attribute, defaulting rules, processing constraints.*

### **object / data object**

An object, as used here, is a Web Applications Dictionary term which corresponds to a database view. In some part of this document, the term data object or WAD: Object is used instead, to avoid confusion with the object technology term "Object".

### **object attribute / data object**

Attribute An object attribute, as used here, is a Web Applications Dictionary term used to describe an attribute that is associated with a data object (view). In simpler terms, it

corresponds to a column in a database View. In some part of this document, the term Data Object Attribute is used as a synonym to object attribute, in order to avoid confusion with the object technology term "Object Attribute".

**occurrence**

An individual quality result. For example, a measurement that falls in or out of a specified tolerance. Occurrences can be charted using Oracle Quality.

**offset percent**

An operation resource field that holds the percent of total manufacturing lead time required for previous operations. For example, if all operations require a total of ten hours to perform and the offset percent for a resource is 40%, then the resource is used four hours after the start of the first operation.

**offsetting account**

The source or opposite side of an accounting entry. For example, when you charge resources in Work in Process you debit a resource to your work in process resource valuation account; the offset account is the credit to the resource absorption account.

**omit**

An AutoCreate option that lets a buyer prevent Purchasing from including certain displayed requisition lines when creating a purchase order or RFQ. If you omit a requisition line, Purchasing returns it to the available pool of requisition lines.

**on account**

Payments where you intentionally apply all or part of the payment amount to a customer without reference to a debit item. On account examples include prepayments and deposits.

**on account credits**

Credits you assign to your customer's account that are not related to a specific invoice. You can create on account credits in the Transaction window or through AutoInvoice.

**on hand quantity**

The physical quantity of an item existing in inventory.

**on hold job/schedule**

A job or repetitive schedule not accepting further activity and is therefore untransactable.

**one time item**

An item you want to order but do not want to maintain in the Items window. You define a one time item when you create a requisition or purchase order. You can report

or query on a one time item by specifying the corresponding item class.

**one time note**

A unique message you can attach to an order, return, order line, or return line to convey important information.

**open**

An open purchase order exists if the purchase order has any lines that have not been fully invoiced and are not cancelled. If you require receipt for items you order, an open purchase order exists if any lines have not been fully received and fully invoiced and are not cancelled.

**open interface**

A Manufacturing function that lets you import or export data from other systems through an open interface. An example is a bar code reader device accumulating data you later import into your manufacturing system for further processing.

**open requirement**

A WIP material requirement you have not yet transacted to a discrete job or repetitive schedule. It equates to the component quantity required less any quantity issued.

**operating script action**

An operating system script invoked by action rule processing in Oracle Quality.

**operating unit**

An organization that partitions data for subledger products (AP, AR, PO, OE). It is roughly equivalent to a single pre Multi Org installation.

**operation**

A step in a manufacturing process where you perform work on, add value to, and consume department resources for an assembly.

**operation code**

A label that identifies a standard operation.

**operation completion pull transaction**

A material transaction where you backflush components from inventory to work in process as you complete the operation where the component is consumed. *See backflush transaction.*

**operation completion transaction**

A move transaction from one operation to the next where you have completed building

the assembly at that operation. In this process, you can also charge resources and overheads and backflush component items.

**operation data store (ODS)**

It represents all the tables that acts as destination for the collected data from each of the data sources (both Oracle Applications or legacy systems). This acts as the input for the snapshot portion of the planning process.

**operation instructions**

Directions that describe how to perform an operation.

**operation offset**

Elapsed days from the start of your first operation until the beginning of your current operation.

**operation overlap scheduling**

A scheduling technique that allows you to schedule resource activities in the prior and next operations to overlap with the current operation.

**operation sequence**

A number that orders operations in a routing relative to each other.

**operation time**

In discrete manufacturing, operation time is the total of setup and run time for a specific task. In flow manufacturing, operation times includes the machine time, labor time, and elapsed time for events, processes, and line operations on your flow routing.

**operation yield**

The percent of material that passes through an operation, process or event on a flow line without being scrapped.

**operational cycle time**

*Seetake Tim.*

**Operational Method Sheet Support**

Operational Method sheets (OMS) are documents that describe the operation to be performed for an assembly. The information in the OMS often includes graphical representation of the process, material needed, and detailed work instructions. You can use attachments in Oracle Flow Manufacturing to attach OMS's to Line Operations in the Flow Routing.

**optimized plan**

In this plan, you can generate an optimized and executable plan based on plan objectives as well as material, resource, and transportation constraints.

**order forecast**

Used by a customer to communicate to the supplier the anticipated future orders for a given item, period, and location from the supplier. The date that the customer uses in the document is the Receipt Date to convey when he expects to receive the goods. Alternately, the customer can provide a Ship Date that conveys when he wants the supplier to make the shipment. When only a Ship Date is provided, Oracle Collaborative Planning will derive a Receipt Date from the in transit lead time. In the absence of a lead time, the Receipt Date is the same as the ship Date.

**overload capacity**

Number of resource units that are required but already committed.

**overrun percentage**

An item attribute the planning process uses to decide when to suggest new daily rates for the item. The planning process only suggests a new daily rate for the item if the current daily rate exceeds the suggested daily rate by more than the acceptable overrun amount. This attribute lets you reduce nervousness and eliminate minor rate change recommendations when it is more economical to carry excess inventory for a short time than it is to administer the rate change. This attribute applies to repetitively planned items only. The related attribute for discretely planned items is Acceptable Early Days. *See acceptable early days.*

**overwrite option**

Option to overwrite existing orders on an MRP plan or an MPS plan during the planning process. Without overwriting, you can keep your existing smoothed entries as well as add new ones. By overwriting, you erase the existing entries and add new one according to the current demand. The overwrite option is used with the append option. *See append option.*

**pack slip**

An external shipping document that accompanies a shipment itemizing in detail the contents of that shipment.

Package level tags can appear anywhere after a "CREATE OR REPLACE" statement and before any uncommented package contents, including variables, program units, etc. For example,

```
--<TPA_LAYER=layer name>
```

indicates that the package belongs to the specified Trading Partner Layer.



**packing instructions**

Notes that print on the pack slip. These instructions are for external shipping personnel. For example, you might wish to warn your carriers of a fragile shipment or your customer's receiving hours.

**parameter**

A variable used to restrict information in a report, or determine the form of a report. For example, you may want to limit your report to the current month, or display information by supplier number instead of supplier name.

**parent transaction**

A transaction entered in an Oracle Manufacturing product that invokes quality data collection.

**Pareto's law**

Vilfredo Pareto's theory that a small percentage of a group accounts for the largest fraction of the impact for the group. For example, 90% of your inventory value may be attributed to 5% of your inventory items.

**passing result**

A passing result signals successful completion of an order cycle approval action. Once an order or order line has achieved an approval action passing result, it no longer appears on the approval window. *see approval action, order cycle.*

**past due order**

An order that has not been completed on or before the date scheduled. It is also called delinquent order or late order.

**past due requirements**

Past due requirements include Release requirements that fall before the schedule horizon start date.

**payback demand**

Temporary material transfer when on project borrows demand from another project.

**payback supply**

Temporary material transfer when one project lends supply to another project.

**payment batch**

A group of invoices selected for automatic payment processing via Oracle Payables AutoSelect function.

**payment document**

Medium used to instruct a bank to disburse funds to the account of a site location or supplier.

**payment terms**

The due date and discount date for payment of an invoice. For example, the payment term '2% 10, Net 30' lets a customer take a two percent discount if payment is received within 10 days, with the balance due within 30 days of the invoice date.

**pegging**

The capability to identify for a given item the sources of its gross requirements and/or allocations. Pegging can be thought of as active where-used information.

**pending**

A status where a process or transaction is waiting to be completed.

**pending costs**

The future cost of an item, resource, activity, or overhead. Not used by cost transactions. *See frozen costs.*

**percent of capacity**

The required hours divided by the available hours for any given department, resource, and shift combination.

**period**

*See accounting period*

**period expense**

An expense you record in the period it occurs. An expense is typically a debit.

**period-based costing**

A method of collecting and reporting costs by period rather than by some other method such as by discrete jobs. Used primarily in costing repetitive schedules and non-standard expense discrete jobs.

**periodic alert**

An alert that checks your database for the presence of a specific condition according to a schedule you define.

**permanent transfers**

*See project transfers.*

**Phantom**

It is an item or a component which is never stocked and is used as a part in building the final item. A phantom may further be made up of phantoms.

**phantom assembly**

An assembly Work in Process explodes through when it creates the bill of material for a job or schedule. A particular assembly can be a phantom assembly on one bill and a subassembly on another.

**physical inventory**

A periodic reconciliation of item counts with system on-hand quantities.

**physical tags**

A tool for recording the on-hand quantity for a specific item in a specific location. A tag is most commonly a slip of paper posted at the item's location.

**pick list**

A report that lists all component requirements sorted by supply type for a particular discrete job, repetitive schedule or production line.

**pick release**

An order cycle action to notify warehouse personnel that orders are ready for picking.

**pick release batch**

*See picking batch.*

**pick release rule**

A user-defined set of criteria to define what order lines should be selected during pick release.

**pick release sequence rule**

The rule for pick release that decides the order in which eligible order line details request item reservations from Oracle Inventory.

**pick slip**

Internal shipping document pickers use to locate items to ship for an order. If you use standard pick slips, each order will have its own pick slip within each picking batch. If you use the consolidated pick slip, the pick slip contains all orders released in that picking batch.

**pick slip grouping rule**

Criterion for grouping together various types of pick slips. The rule dictates how the

Pick Slip Report program groups released lines into different pick slips.

**pick to order**

A configure to order environment where the options and included items in a model appear on pick slips and order pickers gather the options when they ship the order. Alternative to manufacturing the parent item on a work order and then shipping it. Pick to order is also an item attribute that you can apply to standard, model, and option class items.

**pick to order (PTO) item**

A predefined configuration order pickers gather as separately finished included items just before they ship the order. *See kit.*

**pick to order (PTO) model**

An item with an associated bill of material with optional and included items. At order entry, the configurator is used to choose the optional items to include for the order. The order picker gets a detailed list of the chosen options and included items to gather as separately finished items just before the order is shipped.

**picking**

The process of withdrawing items from inventory to be shipped to a customer.

**picking header**

Internal implementation of picking header that identifies distinct combinations of Pick Release criteria (Warehouse, Sales Order, Shipping Priority, Freight Carrier, Ship To, Backorder) in the previous product design. Picking Headers will be generated internally at Pick Release to ensure compatibility with the View Orders. However, when a delivery is closed in the Ship Confirm window, Picking Headers will be updated internally again to ensure all picking lines of a Picking Header are associated with the same delivery. The reason to maintain Picking Headers at Ship Confirm again is for the compatibility of the Update Shipment program. Update Shipment will process all Picking Headers associated with a delivery.

**picking line**

An instruction to pick a specific quantity of a specific item for a specific order. Each pick slip contains one or more picking lines, depending on the number of distinct items released on the pick slip.

**picking rule**

A user defined set of criteria to define the priorities Order Management uses when picking items out of finished goods inventory to ship to a customer. Picking rules are defined in Oracle Inventory.

**pipe**

Allows sessions in the same database instance to communicate with each other. Pipes are asynchronous, allowing multiple read and write access to the same pipe.

**plan horizon**

The span of time from the current date to a future date that material plans are generated. Planning horizon must cover at least the cumulative purchasing and manufacturing lead times, and is usually quite a bit longer.

**planned order**

A suggested quantity, release date, and due date that satisfies net item requirements. MRP owns planned orders, and may change or delete the orders during subsequent MRP processing if conditions change. MRP explodes planned orders at one level into gross requirements for components at the next lower level (dependent demand). Planned orders along with existing discrete jobs also serve as input to capacity requirements planning, describing the total capacity requirements throughout the planning horizon.

**planned order**

A suggested quantity, release date, and due date that satisfies net item requirements.

**planned purchase order**

A type of purchase order you issue before you order actual delivery of goods and services for specific dates and locations. You normally enter a planned purchase order to specify items you want to order and when you want delivery of the items. You later enter a shipment release against the planned purchase order when you actually want to order the items.

**planner**

Person responsible for deciding the time and quantity of a resupply order for an item.

**planner**

One of the processes that comprise the planning process, performed by the memory based planner. The planner uses the low level codes calculated by the exploder, together with the supply and demand information gathered by the snapshot, and calculates net material requirements for every planned item associated with the master schedule used to drive the planning process.

**planner delete worker**

An independent concurrent process, launched by the memory based planner, that removes previous plan output from the tables. It runs only when the memory based planner runs without the snapshot.

### **Planner Workbench**

You can use the Planner Workbench to act on recommendations generated by the planning process for a plan. You can implement planned orders as discrete jobs or purchase requisitions, maintain planned orders, reschedule scheduled receipts, and implement repetitive schedules. You can choose all suggestions from an MRP plan, or only those that meet a certain criteria.

### **planning bill of material**

A bill of material for a planning item that contains a list of items and planning percentages. You can use a planning bill to facilitate master scheduling and/or material planning. The total output of a planning bill of material is not limited to 100% (it can exceed this number by any amount).

### **planning data store (PDS)**

It represents all the tables within Oracle ASCP which encompass those in the ODS and other output tables from planning. When we refer to PDS based ATP, we mean ATP based on planning output.

### **Planning Time Fence Days**

An item attribute Master Scheduling/MRP uses when you set the Planning Time fence attribute to **User defined time fence**. Master Scheduling/MRP calculates the planning time fence for the item as the plan date (or the next workday if the plan is generated on a non workday) plus the value you enter here.

### **PO**

*See purchase order.*

### **PO Change Request Vs. Sales Order**

The term 'sales order' refers to the sales order data as stored in the base Oracle Order Entry tables. The term 'PO Change Request' or 'PO Change Request process' refers to the pending sales order data as stored and processed in this new change order process. Accepted PO Change Request result in an updated Sales Order in the base Oracle Order Management tables. There may be more than one pending change order request in the process for a given purchase order.

### **PO move resource**

An outside resource that is automatically charged upon receipt of a purchase order. PO move resources also automatically initiate shop floor move transactions upon receipt.

### **PO receipt resource**

An outside resource that is automatically charged upon receipt of a purchase order.

**Point of Use (POU)**

Inventory located at a specific operation on a flow line where it will be used. Material is pulled from these locations via a Kanban signal. These locations are in turn, supplied from either raw material stores or ideally, directly from the supplier.

**pooled location**

The destination in which several shipments are delivered and then grouped together to form a larger shipment.

**pooled ship to**

The delivery point for consolidated shipments, gathered from multiple locations, that will be shipped to an intermediate and/or ultimate ship to location.

**position**

A specific function within a job category. Examples of typical positions associated with the Vice President job include: Vice President of Manufacturing, Vice President of Engineering, and Vice President of Sales. *See job.*

**position hierarchy**

A structure of positions used to define management line reporting and control access to employee information.

**postprocessing lead time**

The time required to receive a purchased item into inventory from the initial supplier receipt, such as the time required to deliver an order from the receiving dock to its final destination.

**pre approved**

A document that has been approved by someone with final approval authority, but then forwarded to yet another approver for additional approval; or a document that has been authorized for approval but for which funds have not yet been reserved (if your organization uses encumbrance). A document with a status of Pre Approved does not show up as supply until its status changes to Approved.

**precedence**

Used by Oracle Pricing to resolve Incompatibility. Precedence controls the priority of modifiers and price lists. If a customer qualifies for multiple modifiers that are incompatible with each other, precedence determines the discount that the customer is eligible for based on the precedence level of the modifier. **See also incompatibility.**

**predefined serial number**

To define an alphanumeric prefix and a beginning number for your serial numbers

before you assign them to items. Predefined serial numbers are validated during receiving and shipping transactions.

**preprocessing lead time**

The time required to place a purchase order or create a discrete job or repetitive schedule that you must add to purchasing or manufacturing lead time to determine total lead time. If you define this time for a repetitive item, the planning process ignores it.

**prerequisite**

A combination of a specific order cycle action and an associated result that must occur before an order progresses to its next action in an order cycle. *See cycle action, order cycle, passing result.*

**previous level costs**

The material, material overhead, outside processing, resource and overhead costs of the components used in the manufacture of an assembly.

**price adjustment**

The difference between the list price of an item and its actual selling price. Price adjustments can have a positive or negative impact on the list price. Price adjustments that lower the list price are also commonly known as discounts. Price adjustments can be for an order line or the entire order.

**price adjustments**

In Oracle Pricing, modifiers that result in monetary adjustments to an order. Types of benefits include: discount in %, amount or new price, discounts on other items, surcharges. *See benefits.*

**price breaks**

Discounts for buying large quantities or values of a particular item of a particular UOM, item category or any enabled pricing attribute.

**price breaks**

A quantity delimiters to which are associated prices or discounts by range of quantity and amount. These breaks may occur at either the line item level or at the total order level and associated with a item/ item group.

**price break line**

Supplier pricing information for an item or purchasing category on a quotation. The price you enter on a price break line depends on the quantity you order from your supplier. Usually, suppliers provide you with price break line structures to indicate the price you would pay for an item depending on the quantity you order. Generally, the



more you order, the less expensive your unit price. Also, depending on the quantity you order, a supplier may provide you with different purchase conditions, such as advantageous payment or freight terms when you buy in large quantities.

**price list**

A list containing the base selling price per unit for a group of items, item categories or service offered. All prices in a price list are for the same currency.

**pricing components**

Combinations of pricing parameters you use when defining pricing rules. Pricing components can be made up of one or multiple pricing parameters.

**pricing contracts**

Used to setup a contract with associated contract lines which specifies the items that customer will purchase. Using the contract lines users will be able to setup items , their price, effective dates and price breaks for that item. Users will be able to have multiple versions of the contract and contract lines with different effective dates.

**pricing date**

In Oracle Pricing, the date according to which selling price will be calculated. Pricing Date can be Order Date, Ship Date or sysdate.

**pricing event**

A point in the process flow of a Pricing Line, e.g. Order, Contract etc. at which a call is made to the Pricing Engine to fully or partially price the Order or Contract. A pricing event is analogous to a Workflow event . Ex : Booking Order , Reprice Order, Shipping Order etc.

**pricing information**

Information that pricing calculation is based on such as pricing date, price list and unit price.

**pricing parameters**

A parameter you use to create components to be used in a pricing rule. Valid pricing parameters include segments of your item flexfield or Pricing Attributes descriptive flexfield.

**Pricing Phase**

A user defined control that can be applied to Price Lists, Discount Lists, Promotions, Deals, etc. In Oracle Pricing, the Pricing Engine looks at the phase when deciding which lists should be considered in a Pricing Event. *See Pricing Event.*

**pricing request structure**

In Oracle Pricing the Pricing Request Structure is the parameter information that is passed to the Pricing Engine for calculating the final price which is inclusive of all the modifiers that the customer is eligible for.

**pricing rule**

A mathematical formula used to define item pricing. You create a pricing rule by combining pricing components and assigning a value to the components. Oracle Order Management automatically creates list prices based on formulas you define. *See pricing components.*

**primary and secondary locations**

Primary sites are the key locations required by the Oracle application to associate the transaction to the customer site, supplier site, or other business entity that is key to identify the trading partner (owner) of the transaction. All other locations in the transaction are considered to be secondary location sites, such as a bill to location for a purchase order. Some secondary locations are not likely to be found in the transaction from the trading partner.

**primary bill of material**

A list of the components you most frequently use to build a product. The primary bill is the default bill for rolling up costs, defining a job, and calculating cumulative item lead times. Master Scheduling/MRP uses this bill to plan your material.

**primary customer information**

Address and contact information for your customer's headquarters or principal place of business. Primary addresses and contacts can provide defaults during order entry. *See standard value.*

**primary line**

*See lead timeline.*

**primary role**

Your customer contact's principle business function according to your company's terminology. For example, people in your company may refer to accounting responsibilities such as Controller or Receivables Supervisor.

**primary routing**

A list of the operations you most frequently perform to build a product. The primary routing is the default routing for defining a job and calculating manufacturing lead times.

**primary salesperson**

The salesperson that receives 100% of the sales credits when you first enter your order invoice or commitment.

**primary unit of measure**

The stocking unit of measure for an item in a particular organization.

**prime cost**

A cost which is charged directly to a work in process job or subinventory. Any labor or non labor resource or material is a prime cost; overheads are not.

**priority**

*See line priority.*

**private API**

An API intended to be used by the owning module only, giving maximum flexibility to other calling APIs. Calling APIs / program units are able to control execution of logic based on type of operation being performed.

**private label**

Where a supplier agrees to supply a customer with product labeled as the customers product. The customer is generally a retailer.

**process**

A set of Oracle Workflow activities that need to be performed to accomplish a business goal. *see Account Generator, process activity, process definition.*

**Process**

1) A planned series of actions or operations (e.g. mechanical, electrical, chemical, inspection, test) that advances a material or procedure from one stage of completion to another. 2) A planned and controlled treatment that subjects materials or procedures to the influence of one or more types of energy ( e.g. human, mechanical, electrical, chemical, thermal) for the time required to bring about the desired reactions or results. In flow manufacturing, processes are very generic activities on a flow routing that often consist of several events that are performed in a specific sequence. They are specific to a line and are often defined during the as is analysis on a flow line.

**process activity**

An Oracle Workflow process modeled as an activity so that it can be referenced by other processes; also known as a subprocess. *See process.*

**process activity (diagram icons)**

A Process Activity represents an Activity that is referenced by a process. Each row specifies the usage of an activity as the child of a process (e.g. process: 'ORDER\_FLOW', and child activity: 'LEGAL\_REVIEW'). These instances are marked with machine generated ID's to uniquely identify multiple instances of the same activity in the same process (e.g. AND or OR activities). Rows in this table map directly to icons that appear in a process diagram, thus the rows also store the X/Y coordinates of the icon in the process diagram. Each process has one or more special 'Start' activities that identify activities which may start the process.

**Process Activity Transition**

(diagram arrow) Process Activity Transitions define the relationship between the completion of one process activity and the activation of another. Each row represents a transition ("arrow") from a process activity that completes with a particular result, to another process activity that is now becoming active. (e.g. PA#102 ("LEGAL\_REVIEW") with result "REJECTED" transitions to PA#214 ("TERMINATE")).

**process definition**

An Oracle Workflow process as defined in the Oracle Workflow Builder. *See process.*

**process item type**

Workflow processes can be for different process item Types. A header flow will have a workflow process item type 'OEOH' and a line flow will have a workflow process item type 'OEOL'. Process Item Types enable high level grouping of Workflow Processes.

**Process Manufacturing**

Manufacturing processes that produce products (such as liquids, fibers, powders, or gases) which exhibit process characteristics (such as grade, potency, etc.) typified by the difficulty of planning and controlling yield quantity and quality variances.

**process network**

You can use Flow Routings to represent the network processes on your production line. This network can include alternate processes, rework loops and feeder lines. You can assign yields and planning percentages for each of these processes to determine the optimal number of resource requirements.

**process volume**

In the Oracle Mixed Model Map, the quantity of an assembly that must pass through an operation or process to achieve the line demand volume. It equals the (demand times \* average planning percent \* boost %)/average reverse cumulative yield.

**processes and events**

Processes are very generic activities (in other words painting) that often comprise of

multiple events (in other words prepare the surface, polish the surface, paint the surface) which are performed in a specific sequence. Events are the actual physical tasks performed on the line. You can define standard processes and standard events that are used consistently across product families and production lines.

### **processing constraints**

Constraints to making changes to data on an entity that has effected downstream activities that are difficult or costly to undo. For example, changing options on an ATO order where the Item has already been built.

### **Processing Constraints Framework**

A generic facility that will enable you to define processing constraints for application entities and attributes(database objects and columns) and the set of APIs that will enable to you to query the existence of any constraint against the operation you wish to perform on that entity or it's attributes. *See **processing constraints**.*

### **processing days**

*See **repetitive processing days**.*

### **processing lead time**

The time required to procure or manufacture an item. For manufactured assemblies, processing lead time equals the manufacturing lead time.

### **processing status**

The processing state of a row (record) in an open interface table. Common statuses include, but are not restricted to, Pending, Running, and Error. *See **repetitive processing days**.*

### **product**

A finished item that you sell. *See **finished good**.*

### **product configuration**

*See **configuration**.*

### **product family**

A group of products with similar characteristics, often used in production planning. Flow product families often have similar product synchronization.

### **product pricing attributes**

In Oracle Pricing, these define the products referenced in a deal, discount, promotion, or price list.

**product structure**

*See production line*

The physical location where you manufacture a repetitive assembly, usually associated with a routing. You can build many different assemblies on the same line at the same time. Also known as assembly line.

**product synchronization (Sync)**

Process of defining events, processes, and operations and assigning them to a flow routing in a specific sequence in which they are performed.

**productivity**

An overall measure of the ability to produce a good or a service. It is the actual output of production compared to the actual input of resources. Productivity is a relative measure across time or against common entities (labor, capital, etc.).

**products and parts**

Products and parts are similar to items defined in Oracle Manufacturing. The item type attribute can be used to identify different types of items (for example, finished goods, spare parts, and so on).

**production line**

The physical location where you manufacture a repetitive assembly, usually associated with a routing. You can build many different assemblies on the same line at the same time. Also known as assembly line.

**production lines**

Production Lines are manufacturing work areas where you manufacture families of products. Oracle Flow Manufacturing lets you manage flow production activities by production line. You can use Flow Routings to define the production process of assemblies. You can also use the Mixed Model Map to calculate the line takt time.

**production lineset**

The units committed and sequenced to build in production for a specific number days at a customer's manufacturing facility.

**production rate**

Hourly rate of assemblies manufactured on a production line.

*See line speed.*

**production relief**

The process of relieving the master production schedule when a discrete job is created.

This decrements the build schedule to represent an actual statement of supply.

### **Production Sequence Schedule (PSQI)**

An EDI document (866/CALDEL/SYNCRO & SYNPAAC) used to request the order in which shipments of goods arrive, or to specify the order in which the goods are to be unloaded from the conveyance method, or both. This specifies the sequence in which the goods are to enter the materials handling process, or are to be consumed in the production process, or both. Dates are always discrete, never "bucketed".

### **profile option**

A set of changeable options that affect the way your applications run. In general, profile options can be set at one or more of the following levels: site, application, responsibility, and user.

### **proforma invoice**

A detailed quotation prepared as to resemble the actual Receivables invoice likely to result if the quotation is successful, which shows the buyer what the seller is willing to do, as well as his or her expectations including (but not limited to): Terms of Payment, Terms of Delivery/Terms of Sale, Price of Goods, Quantity of Goods, Freight and Special Charges. The Proforma Invoice has no accounting and no Open Receivable.

### **Program Unit**

Any packaged PL/SQL procedure or function.

Program unit level tags must appear immediately after keyword 'IS'.

TPS Program Unit: --<TPA\_TPS>

### **project**

A unit of work broken down into one or more tasks, for which you specify revenue and billing methods, invoice formats, a managing organization, and project manager and bill rates schedules. You can charge costs to a project, as well as generate and maintain revenue, invoice, unbilled receivable and unearned revenue information for a project.

### **project blanket release**

An actual order of goods and services with a project and task reference against a blanket purchase agreement.

### **project drop shipment**

A process of having the supplier provide the items directly to your customer for a project or task. The sales order is linked to a project and task. The purchase requisition is linked to the same project and task. The procurement cost is collected on Oracle Projects.

**project flow schedule**

Flow schedule with project and task references.

**project inventory**

Any and all items and costs in both project subinventories and project work in process jobs. Inventory owned by a project or task. You can segregate inventory by project using project locators.

**project job**

A standard or non standard WIP job with a project reference. The valuation accounts associated with this type of job will be project work in process. Any balance remaining in such a job when it is closed will be reported as a variance.

**project kiosk**

Kiosk to view information related to a project for manufacturing and/or project costing activities. The manufacturing information viewed could be, WIP jobs, line schedules, procurement activities, manufacturing plans and so on. Project costing information such as expenditures, commitments can be also viewed here.

**project locator**

A locator with a project or project and task reference. *See common locator.*

**project locator**

A locator with project and task segment values. A project locator is a logical partition of a physical location by project and task.

**project manufacturing**

The type of project that uses Projects with Manufacturing to track the costs of a manufacturing related project against a project budget.

**Project Manufacturing**

A type of manufacturing environment where production requirements are driven by large projects. You can plan, schedule, process, and cost against a specific project or a group of projects. If Oracle Project Manufacturing is installed and the Project References Enabled and Project Control Level parameters are set in the Organization Parameters window in Oracle Inventory, you can assign project and, if required, task references to sales orders, planned orders, jobs, requisitions, purchase orders, and other entities within Oracle Manufacturing. If the Project Cost Collection Enabled parameter is also set, you can collect and transfer manufacturing cost to Oracle Projects.

**Project Manufacturing Costing**

A series of features in Project Manufacturing designed to support manufacturing



costing in a project manufacturing environment. Project Manufacturing Costing allows you to track item cost by project or a group of projects, and transfer project related manufacturing transaction costs to Oracle Projects.

**project manufacturing organization**

A new organization classification added since Release 11*i*. Allows the organization to be setup for Project manufacturing activities. Also see project manufacturing.

**project move orders**

Manage project material movement between subinventories by creating (manually or automatically), approving, and transacting material(project) move orders.

**Project MRP**

A series of features in Project Manufacturing designed to support manufacturing planning processes in a project manufacturing environment. Project MRP allows you to segment all sources of supply and demand by project and task. This allows the planning process to net and plan supply by project and task.

**project purchase order**

A purchase order with a project and task reference.

**project requisition**

A requisition with a project and task reference.

**project sales order**

A sales order with a project and task reference.

**project subinventory**

A subinventory with a project reference into which terms can be delivered and out of which items can be issued and transferred.

**project task**

A subdivision of Project Work. Each project can have a set of top level tasks and a hierarchy of subtasks below each top level task. You can charge costs to tasks at the lowest level only. *See Work Breakdown Structure.*

**project transfers**

Transfer of material between projects where the cost is moved with the material and there is no repayment required.

**project work order less completion**

A WIP transaction that you can complete assemblies for a project and task without

referencing a job or repetitive schedule. Project work order less completion automatically backflushes all operation pull, assembly pull, and push components from project locators for hard pegged components and from common locators for non hard pegged components.

**projected available balance (PAB)**

Quantity on hand projected into the future if scheduled receipts are rescheduled or cancelled, and new planned orders are created as per recommendations made by the planning process. Calculated by the planning process as current and planned supply (nettable quantity on hand + scheduled receipts + planned orders) minus demand (gross requirements). If PAB is zero or negative, then it is a stock out situation. Note that gross requirements for projected available includes derived demand from planned orders. Note also that the planning process uses suggested due dates rather than current due dates to pass down demand to lower level items. *See current projected on hand.*

**projected on hand**

The total quantity on hand plus the total scheduled receipts plus the total planned orders.

**resource offset percent**

An operation resource field that represents, as a percent of the processing lead time for an item, the item when a resource is required on a routing. For example, if the processing lead time for an item is 10 days, and the resource is required on the fourth day, then the resource offset percent is 30%. Capacity uses resource offset percent to calculate setback days during the bill of resource load process.

**resource requirement**

A resource and quantity needed to build an assembly on a job or repetitive schedule. Discrete job and repetitive schedule resource requirements are created based on the resource requirements specified on the assembly's routing. Resource transactions fulfill resource requirements.

**resource roll up**

Rolls up all required resources for a end assembly based on the routing and bill of material structure.

**resource sequence**

The number that indicates the order of a resource in an operation relative to other resources.

**resource set**

A grouping of bills of resources.

**resource transaction**

A transaction where you automatically or manually charge resource costs to a discrete job or repetitive schedule.

**resource units**

The number of units of a resource available for this resource at this operation.

**resource units applied**

A quantity you charge to a job or repetitive schedule for work performed by a resource. The quantity is expressed in the unit of measure of the resource. For example, if the unit of measure of a resource is hours and the resource works 10 hours, you apply 10 resource units to the job or repetitive schedule.

**resource UOM item**

A purchasing item associated with an outside resource that you purchase using the resource's unit of measure.

**responsibility**

Determines the data, windows, menus, reports, and concurrent programs you can access in Oracle Applications. It is linked directly to a data group. Several users can share the same responsibility, and a single user can have multiple responsibilities.

**result**

See *action result*.

**result code**

In Oracle Workflow, the internal name of a result value, as defined by the result type. See **result type**, **result value**.

**result type**

In Oracle Workflow, the name of the lookup type that contains an activity's possible result values. See *result code*, *result value*.

**result value**

In Oracle Workflow, the value returned by a completed activity, such as *Approved*. See *result code*, *result type*.

**Retroactive Billing**

A pricing system which can extend to shipped products. Pricing is based on customer purchase order modifications, for example, changes in commodity prices or expected production volume. The difference between the price originally billed when the product shipped and the new applicable price is calculated and applied to applicable shipped

quantities. The customer is billed (or credited) for the adjustment.

**return**

In Purchasing, an AutoCreate option that lets a buyer return a requisition line and all other unpurchased requisition lines on the same requisition to the requisition preparer. In Order Management, it is the opposite of a sales order. It involves receipt of goods previously sold to a customer, credit to a customer, and possibly replacement with an identical or similar product.

**return days**

Return days are the number of days since a return is entered before it is accepted. This is calculated as the accepted date - ordered date (Note accepted = fulfilled).

**return from scrap transaction**

This transaction is used for returning scrapped assemblies. In this document Return from Scrap transaction will mean CFM return from scrap.

**Return of Material Goods (RMG)**

*See Return Material Authorization.*

**return material authorization (RMA)**

Permission for a customer to return items. Receivables allows you to authorize the return of your sales orders as well as sales made by other dealers or suppliers, as long as the items are part of your item master and price list.

**return reason**

Justification for a return of a specific product. Many companies have standard reasons that are assigned to returns to be used to analyze the quantity and types of returns. *See credit memo reasons.*

**return to supplier**

A transaction that allows you to return to the supplier items from a fully or partially received purchase order and receive credit for them.

**revenue recognition**

The schedule for which revenue for a particular transaction is recorded in your general ledger.

**revenue sales credit**

Sales credit you assign to your salespeople that is based on your invoice lines. The total percentage of all revenue sales credit must be equal to 100% of your invoice lines amount. Also known as *quota sales credits*. *See non revenue sales credit, sales credit.*

**reverse cumulative yield**

Product of the yields at each operation, process, or event on a flow line starting with the last operation, process, or event.

**reversing transaction**

A transaction that reverses a previously processed material, move, resource, or overhead transaction.

**revised component**

Component changes to an assembly that is a revised item on an ECO.

**revised item**

Any item you change on an engineering change order. Revised items may be purchased items, subassemblies, finished goods.

**revised item status**

A classification you can use to track and control a revised item's life cycle. Revised item statuses include **Open, Released, Scheduled, Hold, Implemented, and Cancelled**.

**revision**

A particular version of an item, bill of material, or routing.

**revision control**

An inventory control option that tracks inventory by item revision and forces you to specify a revision for each material transaction.

**revision quantity control**

A condition placed on an item that ensures that you always identify an item by its number and its revision. Certain items require tighter controls than other. For instance, you may want to control the quantities you have in inventory for an item by revision. For another item, you may just want to know the quantities you have on hand across all revisions. You keep track of inventory quantities by revision when an item is under revision quantity control. You keep track of inventory quantities by item when an item is not under revision quantity control.

**RFQ**

*See request for quotation.*

**RMA**

*See Return Material Authorization.*

**RMG (Return of Material Goods)**

*See Return Material Authorization.*

**roll flow schedules**

An Oracle Manufacturing technique where you can copy the flow schedules you did not complete into the next available day or take over completions and subtract the total from the quantities of future schedule.

**roll forward**

An Oracle Manufacturing technique where you can automatically take the material you over issued to a particular repetitive schedule and move it forward into the next available repetitive schedule.

**rough cut capacity planning**

The process of converting the master schedule into capacity needs for key resources. *See routing based capacity and rate based capacity.*

**rough cut planner**

The routine that automatically calculates required resources for rough cut capacity planning (done when running a report or inquiry).

**rounding control**

An item attribute the planning process uses to decide whether to use decimal or whole number values when calculating planned order quantities or repetitive rates for the item. A value of **Do not round order quantities** the planning process uses and displays decimal values when calculating planned order quantities and suggested repetitive rates for the item. A value of **Round order quantities** means the planning process rounds decimal values up to the next whole number when calculating planned order quantities and suggested daily rates for the item. Planned order quantities and suggested daily rates are always rounded up, never down. The planning process carries any excess quantities and rates forward into subsequent periods as additional supply.

**route**

An ordered sequence of Lane Segments, from point of Origin to point of Ultimate Destination for a shipment. The sum of all of the lane segments, i.e.: where "A" to "B" and "B" to "C" are lane segments, the route will be "A" to "C".

**route sheet**

A report that provides full routing, operation, resource, and material requirement details for jobs and repetitive schedules. Typically used to know how, when, where, and who builds an assembly. Also known as traveler.

**routing**

A sequence of manufacturing operations that you perform to manufacture an assembly. A routing consists of an item, a series of operations, an operation sequence, and operation effective dates.

**routing network**

Routing network defines the flow of work from one line operation to the next. It also specifies which path in the routing is an alternate or rework path. Routing networks, line operations, and events are the only entities considered in WIP.

**routing revision**

A specific version of a routing that specifies the operations that are active for a date range.

**routing based capacity**

Capacity planning at the resource level. Required capacity, available capacity, and capacity utilization are calculated for individual resources assigned to operations on routings. Required and available capacity are stated in terms of hours per resource per week.

**run**

An intraoperation step where you move assemblies that you are working on at an operation.

**safety stock**

Quantity of stock planned to have in inventory to protect against fluctuations in demand and/or supply.

**sales forecast**

A projection of future sales for a given item, period and location, the sales forecast order type is used by customers to communicate what they expect to sell. Alternately, it can be used by a supplier to communicate to the customer what the supplier projects the customer to ship in the future. This sales forecast order type will be useful for the sales forecast collaboration in the CPFR business process. In both cases, the date that will be provided in the document will be the Ship Date to convey the expected date that the goods will be shipped to a customer.

**Safety Stock**

A quantity of stock that is planned to be in inventory to protect against fluctuations in demand or supply. In the context of scheduling, safety stock is defined as the additional inventory that is planned as a protection against forecast errors and short term changes in the order backlog. Oracle APS helps manufacturers to determine the amount of safety stock to hold at each inventory carrying location in their supply chain.

**Safety Stock (item attribute)**

An item attribute the planning process uses to decide whether to use fixed or dynamically calculated safety stock quantities when planning material requirements for the item. A value of **MRP planned percent** means the planning process plans to safety stock quantities it calculates dynamically as a user defined percentage of the average gross requirements for a user defined number of days. The user defined percentage is defined by the value you enter for the Safety Stock Percent attribute for the item. For discretely planned items, the user defined number of days is defined by the value you enter for the Safety Stock Bucket Days attribute for the item. For repetitively planned items, the planning process uses the repetitive planning period rather than Safety Stock Bucket Days. These safety stock quantities are dynamic in that they vary as a function of the average gross requirements calculated by the planning process for the item. A value of **Non MRP planned** means the planning process plans to safety stock quantities calculated and maintained in Inventory. These safety stock quantities are fixed in that the Snapshot loads them from Inventory before the planning process and they do not vary unless they are recalculated in Inventory.

**Safety Stock Bucket Days**

An item attribute the planning process uses when you set the Safety Stock attribute for the item to **MRP planned percent**. The planning process dynamically calculates safety stock quantities for the item by multiplying the average gross requirements for the item, over the time period defined by the value you enter for Safety Stock Bucket Days, by the value you enter for Safety Stock Percent.

**Safety Stock Percent**

An item attribute the planning process uses when you set the Safety Stock attribute for the item to **MRP planned percent**. The planning process dynamically calculates safety stock quantities for the item by multiplying the average gross requirements for the item, over the time period defined by the value you enter for Safety Stock Bucket Days, by the value you enter for Safety Stock Percent.

**safety stock quantity**

The quantity suggested by MRP as additional supply needed for safety stock. This quantity can change according to an effective date set in Inventory.

**sales channel**

A term that indicates the method used to generate a sales order, such as Telemarketing or Direct Marketing. You can use this attribute of an order to classify orders for reporting purposes.

**sales credit**

Credits that you assign to your salespeople when you enter orders, invoices and commitments. Credits can be either quota or non quota and can be used in determining



commissions. *See non revenue sales credit, revenue sales credit.*

### **sales order**

In this document a sales order by default means an ATO sales order.

### **sales tax**

A tax collected by a tax authority on the purchase of goods and services based on the destination of the supply of goods or services. You can set up your Sales Tax Location Flexfield structure to determine your sales tax rates and to validate your customer addresses. For example, in the United States, sales tax is usually calculated by adding the tax rates assigned to the shipping state, county, city.

### **sales tax structure**

The collection of taxing bodies that you will use to determine your tax authority. 'State.County.City' is an example of a Sales Tax Structure. Oracle Automotive adds together the tax rates for all of these components to determine a customer's total tax liability for an order.

### **salesperson**

A person responsible for the sale of products or services. Salespeople are associated with orders, returns, invoices, commitments, and customers. You can also assign sales credits to your salespeople.

### **Salesperson**

The salesperson parameter in both reports is based upon a query of the default salesperson stored on the header for each order. Although the header level salesperson may not have actually received credit for any of the lines in the order, due to line level overrides, our parameter is based upon the header information. Further, the Discount Summary report displays this header level salesperson on the report. If a user needs to truly check for salesperson level information, they should run the Salesperson Order Summary Report.

### **Salesperson and Ship to Country**

Order Management prints the salesperson name and the Ship to Country if the line and the header level information differs from each other. If it is the same, than this information is not printed at the line level.

### **schedule**

A transaction containing current or future product demand, communicated by the customer to the supplier via EDI or other means. Types of schedules include Planning, Shipping, and Sequenced Production schedules.

**schedule and shipments**

The EDI Standards refer to dates and quantities to be shipped below the item level to be 'Schedule' data (found on SCH Schedule segments). To Oracle Order Entry this data is 'Shipment' Data.

**schedule arrival date**

The date returned by the system on which your customer can receive the products.

**schedule date**

The date for a master schedule entry for an item. A schedule for an item has a schedule date and an associated quantity. For Order Management, it is considered the date the order line should be ready to ship, the date communicated from Order Management to Inventory as the required date any time you reserve or place demand for an order line.

**schedule end date**

For repetitive items, defines the end of the repetitive rate for a master schedule.

**schedule entry**

A schedule for an inventory item. For discrete items, stated by a date and quantity. For repetitive items, stated by a date, schedule end date, and quantity.

**schedule group**

An identifier used to group jobs for scheduling and releasing purposes. For example, you might group together all jobs that must be completed on a specific date and are being built on the same production line. Jobs within a schedule group can be sequenced. *See build sequence.*

**schedule horizon**

Consists of the dates enclosed by the Horizon Start Date and the Horizon End Date. In a customer demand schedule, demand requirements and resource authorizations will be dated on or within this date range.

**schedule item**

A specific Customer Item on a demand schedule associated with a specific set of business entities and important CUM related qualifiers. Demand and other information is grouped by the customer within Schedule Item.

**schedule item number**

The number assigned to all demand, authorizations, shipment/receipt information, and other information related to the Schedule Item. This number is not applicable to sequences schedules.

**schedule purpose code**

Criteria used by the Release Management Demand Processor to interpret demand for each item on a schedule within the horizon date range.

**scheduled ship date**

The date on which the product is scheduled to depart from the Ship From Location.

**schedule smoothing**

The manual process of entering quantities and dates on the master production schedule that represent a level production policy.

**scheduled flow schedule**

These are flow schedules that are created by planning with a specific scheduled completion date.

**scheduled receipt**

A discrete job, repetitive schedule, non standard job, purchase requisition, or purchase order. It is treated as part of available supply during the netting process. Schedule receipt dates and/or quantities are not altered automatically by the MRP system.

**sell through forecast**

*Seesales forecast.*

**single level variance**

A work in process variance that is the difference between the standard cost of an assembly and the actual charges to a standard jobs or repetitive schedules distributed by structure level. This variance looks at the assembly cost for the resource and overhead standard cost at the top level and compares them to the actual resource and overhead costs charged to the standard job or repetitive schedule. All other costs material, material overhead, outside processing, resource and overhead costs from lower level assemblies are included in the material usage variance calculation.

**site use**

*Seebusiness purpose.*

**snapshot**

The only phase under the memory based planning engine. The snapshot takes a snapshot or picture of supply and demand information at a particular point in time. The snapshot gathers all the information about current supply and demand that is required by the planner to calculate net material requirements, including on hand inventory quantities and scheduled receipts. Under the memory based planning engine, explosion and planning occur in the snapshot phase.

**snapshot delete worker**

An independent concurrent process launched by the snapshot monitor that deletes planning data from the previous planning run.

**snapshot monitor**

A process, launched by the memory based snapshot, that coordinates all the processes related to the memory based planning engine.

**snapshot task**

A task performed by the snapshot or a snapshot worker during the planning process.

**snapshot worker**

A group of independent concurrent processes controlled by the snapshot monitor that brings information into flat files. This information comes from Work in Process, Bill of Materials, on hand quantities, purchase orders, firm planned orders, routings, and Work in Process job resource requirements.

**soft pegging**

A pegging item attribute value. You can peg supply to demand for items with soft pegging.

**soft reservation**

The planning process considers sales order demand soft reservation.

**Sold to Contact**

(Placed by) How will we record or default the name of the person that placed the order. This is the person that the Customer service representative will contact at the Customer Site in the event of Ordering queries.

**source base unit**

The unit of measure from which you are converting when you define your interclass conversions. You define the destination base unit in terms of the source base unit. Your source base unit is the base unit of a unit class.

**source forecast**

When loading a forecast into another forecast, the source forecast is the forecast you load from.

**Source Transaction System**

The source application that populates the pricing tables with information using the Pricing API's. These include: Ex : Order Management, iMarketing , Trade Management , Contracts, etc.

**sourcing**

Used in Oracle Pricing to refer to the supply of a value for an attribute. *Seedefaulting and dimension sourcing.*

**sourcing**

The action of identifying a purchasing source or supplier for goods or services. To identify the best sources for your purchases, you can create RFQs that you send to your suppliers, enter quotations from your supplier, and evaluate these quotations for each item you purchase.

**sourcing externally**

When a customer orders an item, we ship it from one of our warehouses. This is known as sourced internally. But we ask our vendor to ship to the customer directly, we say the item is sourced externally.

**sourcing rule**

Specifies how to replenish items in an organization, such as purchased items in plants.

You can also use sourcing rules to override sourcing that is specified in the bill of distribution assigned to an item.

**sourcing rule assignment**

*Seeassignment hierarchy.*

**spare part**

A synonym for service part. It is an inventory item used without modification to replace an original part during the performance of maintenance or repair to a serviceable item or product.

**specification**

Describes the requirements of a product in Oracle Quality. You can define specifications for the key characteristics of the products you produce.

**specification element**

A collection element copied or assigned to a specification.

**specification limits**

Numeric values used to specify an acceptable range of values for a quality element. Consists of a target value, and upper and lower control limit, and an upper and lower reasonableness limit.

**specification subtype**

A user defined subclassification of the standard specification types: customer, vendor, or an item/item category. For example a customer specification can be assigned a specification subtype that indicates the customer's plant location.

**specification type**

A classification for specifications. Specifications can be specific to a customer, vendor, or an item/item category.

**split amount**

A dollar amount that determines the number of invoices over and under this amount, as well as the total amounts remaining. For example, your company generates invoices that are either \$300 or \$500. You choose \$400 as your split amount so that you can review how much of your open receivables are comprised of your \$300 business and how much corresponds to your \$500 business. The split amount appears in the Collection Effectiveness Indicators Report.

**spot exchange rate**

A daily exchange rate you use to perform foreign currency conversion. The spot exchange rate is usually a quoted market rate that applies to the immediate delivery of one currency for another.

**SPSI**

Transaction code assigned to inbound electronic Planning Schedule with Release Capability transaction in the Oracle e Commerce Gateway. Data from this transaction feeds into Oracle Release Management Demand Processor.

**SQL validation statement**

A statement written in SQL to customize action details.

**SQL script action**

An SQL script invoked by action rule processing in Oracle Quality.

**SSSI**

Transaction code assigned to inbound electronic Shipping Schedule transaction in the Oracle e Commerce Gateway. Data from this transaction feeds into Oracle Release Management Demand Processor.

**standard actions**

Order Management provides a selection of predefined actions, called standard actions. Use these actions, along with those you define yourself, to create your customized order cycles. *See cycle action, order cycle.*

**standard bill of material**

A bill of material for a standard item, such as a manufactured product or assembly.

**standard component**

A mandatory component used to assemble an ATO (assemble to order) item or configuration.

**standard comments**

Standard text you can assign to discrete jobs or repetitive schedules. Special instructions or details specific to a particular job or circumstance.

**standard costing**

A costing method where a predetermined standard cost is used for charging material, resource, overhead, period close, job close, and cost update transactions and valuing inventory. Any deviation in actual costs from the predetermined standard is recorded as a variance.

**standard discrete job**

A type of discrete job that controls material and resources for standard production assemblies.

**standard item**

Any item that can have a bill or be a component on a bill except planning items, option classes, or models. Standard items include purchased items, subassemblies, and finished products.

**standard note**

A routine message you can predefine and automatically or manually attach to orders, returns, order lines, and return lines to convey important information. See *one time note*, *automatic note*.

**standard note**

A long note you define for Oracle Manufacturing and can later reference on as many documents as you want.

**standard operation**

A commonly used operation you can define as a template for use in defining future routing operations.

**standard planning engine**

A planning engine that drives the planning process. This planning engine consists of three phases, each of which follows a strict sequence: the exploder, the snapshot, and

the planner. These phases are followed by two optional phases: CRP planner, and maintain repetitive planning periods. *See memory based planning engine, planning process.*

**standard purchase order**

A type of purchase order you issue when you order delivery of goods or services for specific dates and locations for your company. Each standard purchase order line can have multiple shipments and you can distribute the quantity of each shipment across multiple accounts. *See purchase order.*

**standard rate**

The frozen standard unit cost for a resource.

**standard receipt**

A receipt routing in which shipments are received into a receiving location and then delivered in a separate transaction. Standard receipts can be inspected or transferred before delivery.

**standard unit conversion**

The conversion formula you define between different units from the same unit class. You define your own standard conversion.

**standard unit cost**

The unit cost you may use to cost all material and resource transactions in your inventory and work in process system. This cost represents the expected cost for a component or assembly for a specified interval of time. The basis for standard cost may be the cost history, purchase order history, or predicted changes in future costs.

**standard value**

The default value Order Entry automatically places in an attribute to improve the efficiency and accuracy with which you enter an order. The standard value for an attribute is frequently based on other values in the order. *See attribute, default value, object, standard value rule set.*

**standing data**

Data that is generally independent, not subject to frequent changes, consumption or transactions, i.e., customer data, item data, address data.

**status**

*See customer status.*

**start date**

The date you plan to begin production of assemblies in a discrete job.



**statistical forecasting**

A mathematical analysis of past transaction history, last forecast quantities, and/or information specified by the user to determine expected demand.

**status check**

A set of tests Purchasing performs on a purchasing document to ensure it is in a valid state before performing an approval action.

**stop**

A point along the route a trip makes to its final destination. This point may also have some activity associated with it. The activity might include picking up a new delivery, dropping off a delivery or both. In Pick Release, stop is a release criteria for releasing items that have initial pick up locations corresponding to the specified stop, or location.

**subassembly**

An assembly used as a component in a higher level assembly.

**subinventory**

Subdivision of an organization, representing either a physical area or a logical grouping of items, such as a storeroom or receiving dock.

**sublot**

A subdivision of a lot which may be used when an entire lot is more than would be used or produced at any one time, but grouping of the material into a single lot is still desired. This maintains the integrity of the overall lot, but allows it to be consumed in manageable pieces.

**submission check**

A set of tests on a purchasing document to ensure it is ready to be submitted for approval processing.

**submit**

To send a document to another employee without attempting to approve or reserve funds for it yourself.

**substitute item**

An item that can be used in place of a component. Master Scheduling/MRP suggests substitutes items on some reports.

**substitute receipt**

An option that lets you receive predefined acceptable substitutes for any item.

**suggested aggregate repetitive schedule**

The optimal repetitive schedule suggested by MRP to satisfy a given master schedule. The optimal schedule represents aggregated production for all lines and considers the constraints of planning periods, item lead time, firm schedules, time fence control, acceptable rate changes and overrun amounts.

**suggested dock date**

The date you expect to receive an order (to arrive on the receiving dock) as suggested by the planning process.

**suggested due date**

The date when scheduled receipts are expected to be received into inventory and become available for use as suggested by the planning process.

The need by date for the end item is the demand date. The need by dates for the dependent demands are calculated based on the lead time offsets that are associated to the Items and routings used.

- If a constrained plan is run, the planning process will use the planned orders and actual routings for scheduling to derive the suggested due date.
- If an unconstrained plan is run, the suggested due date will simply be the same as the need by date.

Therefore, any differences between the lead time offsets (need by date) and actual manufacturing time (suggested due date) created by the planning process, will show up in the form of multiple exception messages.

**suggested order date**

The date that the planning process suggests an order for goods or services is entered. The earliest order date allowed is today and no compression days are allowed.

**suggested repetitive schedule**

The schedule for an individual production line for a specific item that is derived from the Suggested aggregate schedule. MRP divides the suggested aggregate schedule for a specific line and item based on the production line attributes: priority, minimum and maximum rates.

**suggested start date**

The date you or your suppliers expect to start to manufacture the order as suggested by the planning process.

**summary**

Data at master (header) level representing similar information contained in more than

sources at the detail level.

### **summary message action**

A message representing one or more exceptions. The message may include introductory and closing paragraphs separated by the exceptions listed in a columnar report format.

### **supply chain ATP**

This term is used to describe the task of performing an ATP check against multiple sourcing organizations for a given customer request.

### **Supply commit**

Used by a suppliers communicate to customers anticipated future shipments. The date the supplier uses in the document is the Ship Date to convey when he expects to ship the goods to the receiving location. Alternately, the supplier can provide only a Receipt Date that conveys when he expects the customer to receive the goods. When only a Receipt Date is provided, Oracle Collaborative Planning will derive a Ship Date from the intransit lead time. In the absence of a lead time, the Receipt Date is the same as the Ship Date.

### **supply chain planning**

The development and maintenance of multi organizational distribution and manufacturing plans across a global supply chain.

### **supply chain sourcing rules**

A set of rules that define the supplier priority rank and percentage split for the ship to organization's planning requirements or the ship from organization's demand routing.

### **supplier**

Provider of goods or services.

### **supplier flex fences**

Specifies capacity tolerance percentages that vary over time for each source. This allows you to represent the ability of your supplier to flex capacity upwards based on the amount of advanced notice you provide.

### **supplier product number**

The number your supplier assigns to an item. You and your supplier can have different item naming conventions. You can identify the item with one number (Item) while your supplier identifies this item using another number (Supplier Product Number). Using and referencing supplier product numbers helps you speed up your purchasing cycle. By referencing a number your supplier knows, you can help your suppliers understand your purchase orders and RFQs better.

**supplier purchasing hold**

A hold condition you place on a supplier to prevent new purchasing activity on the supplier. You cannot approve purchase orders for suppliers you placed on hold.

**supplier quotation list**

A list of suppliers who can provide goods or services you need. You often define a supplier quotation list for an item or class of items. You can use a supplier quotation list to generate multiple copies of a RFQ automatically and to manage supplier responses.

**supplier requirement**

*Seesupplier sourced component.*

**supplier sourced component**

A component item on a bill of material supplied to work in process directly by a supplier.

**supplier specification**

The customer specified material requirements for a product or service.

**supply**

A quantity of materials available for use. Supply is replenished in response to demand or anticipated demand.

**supply agreement blanket purchase order**

A type of purchase order you issue before you request actual delivery of goods or services. You normally create a blanket purchase agreement to document a long term supplier agreement. A blanket purchase agreement may contain an effective date and an expiration date, a committed amount, or quantity. You use a blanket purchase agreement as a tool for specifying agreed prices and delivery dates for goods and services before actually ordering them. Blanket agreement in Oracle Purchasing with the Supply Agreement flag set on the Blanket Agreement header. Only Supply Agreement Releases are picked up by Supplier Scheduling.

**supply locator**

The specific location, such as shelves or containers, within a supply subinventory that you use as the default locator in a material transaction.

**supply release agreements**

Release shipments against a Blanket Supply Agreement.

**supply reserved**

A schedule status showing that Oracle Work in Process (WIP) has recognized the

demand for an item or configuration and opened a work order to supply the demand. Once the work order is complete and the finished product is received in inventory, WIP transfers a reservation for the finished product to the sales order. The schedule status for the order line or order line detail is then changed to be Reserved.

### **supply subinventory**

The subinventory you use as a primary source of supply to meet a specific material requirement in a discrete job or repetitive schedule. In Release 9, this is the backflush subinventory for pull material or the primary issue subinventory for push material.

### **supply type**

A bill of material component field that controls issue transactions from inventory to work in process. Supply types supported by Work in Process include: **Push, Assembly pull, Operation pull, Bulk, Supplier, Phantom, and Based on bill.**

### **system items flexfield**

A flexfield that allows you to define the structure of your item identifier according to your business requirements. You can choose the number and order of segments (such as product and product line), the length of each segment, and much more. You can define up to twenty segments for your item. Also known as **Item Flexfield.**

### **system linkage**

An obsolete term. *See expenditure type class.*

### **Table of Denial Orders**

A government restriction on exports of certain products to certain countries and organizations.

### **TAG**

Truck Advisory Group. An association of heavy truck and off road vehicle manufacturers, suppliers, carriers, and value added networks.

### **takt time**

Operation cycle time the rate at which products need to be manufactured on the line. Aids in establishing the daily rate for the production line.  $\text{takt Time} = \frac{\text{effective resource hours available per day}}{\text{Average daily demand}}$ .

### **tare weight**

The weight of an item, excluding packaging or included items.

### **task**

A subdivision of project work. Each project can have a set of top level tasks and a hierarchy of subtasks below each top level task. **See work breakdown structure.**

**task kiosk**

Kiosk to view manufacturing information related to a project task. The manufacturing information viewed could be WIP jobs, line schedules, procurement activities, manufacturing plans and so on.

**tax amount**

Tax which will be calculated based upon the extended selling price and freight charges.

**tax authority**

A governmental entity that collects taxes on goods and services purchased by a customer from a supplier. In some countries, there are many authorities (e.g. state, local and federal governments in the U.S.), while in others there may be only one. Each authority may charge a different tax rate. You can define a unique tax name for each tax authority. If you have only one tax authority, you can define a unique tax name for each tax rate that it charges. A governmental entity that collects taxes on goods and services purchased by a customer from a supplier. In some countries, there are many authorities (e.g. state, local and federal governments in the U.S.), while in others there may be only one. Each authority may charge a different tax rate. Within Oracle Automotive tax authority consists of all components of your tax structure. For example: (California.San Mateo.Redwood Shores) for (State.County.City) Oracle Automotive adds together the tax rates for all of these locations to determine a customer's total tax liability order invoice.

**tax codes**

Codes to which you assign sales tax or value added tax rates. Oracle Receivables lets you choose state codes as the tax code when you define sales tax rates for the United States.

**tax condition**

A feature that allows you to define and evaluate one or more conditional lines. After execution, each tax condition may have one or more actions based on how each transaction against the condition validates.

**tax engine**

A collection of programs, user defined system parameters, and hierarchical flows used by Order Entry and Receivables to calculate tax.

**tax exclusive**

Indicates that tax is not included in the line amount for this item.

**tax exempt**

A customer, business purpose, or item free from tax charges.

**tax group**

A tax group that allows you to build a schedule of multiple conditional taxes.

**tax inclusive**

Indicates that the line amount for an item includes the tax for this item.

**tax location**

A specific tax location within your tax authority. For example 'Redwood Shores' is a tax location in the Tax Authority (California.San Mateo.Redwood Shores).

**tare weight**

The weight of an item, excluding packaging or included items.

**target value**

A number which indicates the desired result of a given quality characteristic. Can also be used to denote the expected average of values for a quality characteristic.

**teardown time**

The time required to clean up or restore a machine or work center after operation.

**temporary transfers**

*See borrow payback*

**territory**

A feature that lets you categorize your customers or salespeople. For example, you can group your customers by geographic region or industry type.

**territory flexfield**

A key flexfield you can use to categorize customers and salespersons.

**this level costs**

The cost or value added at the current level of an assembly. Resource, outside processing and overhead costs are examples of this level costs. Material is always a previous level cost.

**three way matching**

Purchasing performs three way matching to verify the purchase order, receipt, and invoice information match within tolerance.

**time aggregation**

You can post orders to the system specifying an item, order type, due date, bucket type,

customer site, and supplier site. You can specify the order quantity at the daily, weekly, or monthly level depending upon the bucket type. The system treats an order quantity based on the bucket type in the following way:

- **Time bucket specification: Day**

When you specify the time bucket as Day, during posting the order quantity is considered as due or available on the calendar date specified on the order.

- **Time bucket specification: Week**

When you specify the time bucket as Week, during posting the order order quantity is considered as due or available for the week that includes the calendar date specified on the order. Note that each week has a start date and an end date, and each is derived from the site specific calendar.

- **Time bucket specification: Month**

When you specify the time bucket as Month, during posting the order quantity is considered as due or available for the month that includes the calendar date specified on the order. A month always has a start date and an end date, and it is derived from the site specific calendar.

### **time bucket**

A unit of time used for defining and consuming forecasts. A bucket can be one day, one week, or one period.

### **unallocated onhand**

Posted by a trading partner to communicate to another the quantity of inventory physically in stock that is intended for the use all trading partners who receive such communication. The date that used by the trading partner for this order type is Actual Date to indicate the physical inventory being held by the trading partner for the intended purpose.

### **time fence**

A policy or guideline established to note where various restrictions or changes in operating procedures take place. The planning process cannot create or reschedule orders within the planning time fence. This gives the planner the ability to stabilize the plan and thereby minimizing the nervousness of the system.

### **time phased requirements**

Requirements for resources where the need dates are offset by the lead time for those resources.

### **time phased safety stock requirement**

Time phased safety stock requirement is calculated using user supplied information on



variable demand forecast and supplier lead times. ASCP and IO generate an optimal time phased safety stock plan to protect the OEM against demand and supply fluctuations.

**to move**

An intraoperation step where assemblies can either be completed to a subinventory or wait to be moved to another operation.

**total credits/adjustments**

Oracle Order Management prints the (Originally Due Amount - Balance Due Remaining) for each order listed on this report.

**total lead time**

An item's fixed lead time plus the variable lead time multiplied by the order quantity. For lead time calculations, Bills of Material sets the order quantity to the item's standard or lead time lot size. The planning process uses the total lead time for an item in its scheduling logic to calculate order start dates from order due dates.

**Total Product Cycle Time (TPCT)**

The total time along the longest path of your flow routing. Calculated by taking the sum of the elapsed times along the longest primary path on the routing network.

**total quantity accepted**

The total number of accepted items for the receipt line.

**total requisition limit**

The maximum amount you authorize an employee to approve for a specific requisition.

**TPA metadata file**

Contains information extracted from the TPA repository about TPA enabled program units and layers built on top of them. This file is used to ship the TPA registry, or repository, and merge layers at the customer site. This file must be shipped with any patch that contains TPA enabled program units.

**TPA package**

The package containing TPA program units. This package is always generated from the TPA repository.

**TPA program unit**

The mirror program unit for a public program unit. For every public program unit, Oracle developers will designate a TPA program unit. TPA program units are generated by the architecture to insulate generic code from custom code. All calls to customizable generic code and custom code are made through the TPA program unit.

**TPA repository**

The registry which stores data required for the functioning of the Trading Partner Architecture. It includes information about public program units, TPA program units, TPS program units and complete definition of the layers including the Oracle Base Layer.

**TPA tag**

One line hyphen comments which appear at the beginning of a new line and provide information about customizable program units within Oracle code. The syntax for a TPA tag is:

```
--<tag name=tag value>
```

For example, a label is specified as follows,

```
--<TPA_LABEL=label>
```

**trading partner**

Any company that sends and receives documents via EDI.

**Trading Partner Architecture (TPA)**

The framework that supports PL/SQL based layer development and deployment.

**trading partner flexfield**

Descriptive flexfields reserved on several base tables for capturing additional attributes applicable to specific trading partners. They are provided for most of the base tables in Oracle Release Management, Shipping and Order Management.

**trading partner layer**

The trading partner specific code created to replace Base Layer code. The layer consists of a set of PL/SQL program units that perform trading partner specific processing or validations in place of the generic code provided by Oracle Development.

Layer Providers develop this code and populate the Trading Partner Layers by importing the trading partner specific code into the TPA repository. In this way, Layer Providers can develop Trading Partner Layers composed of trading partner specific code for various trading partners.

**Trading Partner Selector (TPS)**

A program unit which accepts context information for the business transaction and derives trading partner entities being processed in the current transaction instance.

All TPS Program units must have the following five output (OUT/IN OUT) arguments:

**trailer number**

This number is used to track full truckload shipments.

**transaction**

Type Order and Lines can be grouped together loosely as certain Transaction Types. Accordingly, a transaction type can be used to default attributes/controls for an order or a line. Transaction Type Code determines whether the transaction type is an Order Transaction Type or a Line Transaction Type.

**transaction batch source**

A source you define in Oracle Receivables to identify where your invoicing activity originates. The batch source also controls invoice defaults and invoice numbering.

**transaction cost**

The cost per unit at which the transaction quantity is valued.

**transaction date**

The date you enter and Oracle Manufacturing maintains for any manufacturing transaction. The date must fall within an open accounting period and be greater than the release date for transactions on a discrete job or repetitive schedule.

**transaction interface**

An open interface table through which you can import transactions. *See open interface.*

**transaction manager**

A concurrent program that controls your manufacturing transactions.

**transaction quantity**

The quantity of a transaction.

**transaction set**

A complete business document such as an invoice, a purchase order, or a remittance advice. Synonym for document or message.

**transaction set line item area**

The line item area encompasses the actual business transaction set and includes information, such as quantities, descriptions, and prices.

**transaction set summary area**

The summary area contains control information and other data that relate to the total transaction.

**transaction type**

A feature that allows you to specify default values for orders and order lines including the customer, the ship to location, and internal or external orders.

**transaction type code**

Transaction type code determines whether the transaction type is an Order Transaction Type or a Line Transaction Type.

**transaction worker**

An independent concurrent process launched by a transaction manager to validate and process your manufacturing transactions.

**transition**

In Oracle Workflow, the relationship that defines the completion of one activity and the activation of another activity within a process. In a process diagram, the arrow drawn between two activities represents a transition. *See activity, Workflow Engine.*

**transportation network**

The organized substructure which defines the path and means of transportation between points of origin and points of ultimate destination. Includes Routes, Lanes, Zones, Locations.

**traveler**

*See route sheet.*

**triangulation**

A triangle that is created when three partners are involved in a drop shipment transaction.

**trip**

An instance of a specific Freight Carrier departing from a particular location containing deliveries. The carrier may make other stops on its way from the starting point to its final destination. These stops may be for picking up or dropping off deliveries.

**trip planning stop**

The process of planning the necessary vehicles and grouping the scheduled shipments that will be included in a given trip. Planning the trip requires consideration of vehicle load capacities, container capacities and, in certain cases, the loading order for the customer's specified unload order.

**trip stop**

A location at which the trip is due for a pick up or drop off.

**trip stops**

Represents a point along the route a trip makes to its final destination. This point may also have some activity associated with it. The activity might include picking up a new delivery, dropping off a delivery or both.

**two level master scheduling**

A technique that facilitates the forecast explosion of product groupings into related master production schedules. The top level MPS is usually defined for a product line, family or end product while the second level is defined for key options and components.

**two way matching**

Purchasing performs two way matching to verify that purchase order and invoice information match within tolerance.

**ultimate ship to location**

The final destination of a shipment.

**UN number**

An identifier for a hazardous material. Each Identification number has a description. Identification numbers are not unique. For instance, the same UN Number may correspond to 2 closely related but different types of materials.

**unconstrained plan**

In this plan, the system performs traditional MRP type planning and assumes infinite material availability and resource capacity. Statements of material availability and resource capacity are used to generate exceptions. Demand priorities are included during the planning run to determine the appropriate pegging relationships between supply and demand.



---

# Index

## A

---

access level setup, 12-1  
activities  
    End, 12-60  
    Start, 12-61  
activity overview, 12-58  
Admin window  
    image, 2-41  
advanced exception conditions, 7-17  
advanced horizontal view, 9-1  
    overview, 9-1  
    setup, 9-28  
    sharing workbooks, 9-30  
    viewing workbooks, 9-30  
advance shipment notices, 4-11  
approved supplier lists, 4-9  
assign responsibilities, 2-16, 2-29, 2-30  
automation  
    customer collaboration, 3-7  
available responsibilities, 2-16

## B

---

blanket purchase agreements, 4-4  
Budgetary account, Glossary-10  
Build Error Message, 12-58  
    function overview, 12-58  
    image, 12-58  
    PL/SQL procedure, 12-58

## C

---

calendar, 2-30

    description, 2-16  
    setup, 2-16, 2-30  
    setup navigational path, 2-16  
    setup procedure, 2-16  
    standalone setup, 2-30  
calendar setup, 2-16, 2-30  
    Find Requests window, 2-31  
    Find Requests window image, 2-17  
    Parameters window, 2-20, 2-34  
    standalone, 2-30  
    Submit a New Request window, 2-18  
    Submit Request window, 2-19, 2-33  
calendar setup navigational path, 2-16  
calendar setup procedure, 2-16  
capacity  
    receiving, 3-14  
change orders exceptions, 7-12  
    Customer Purchase Order has been Cancelled,  
    7-12  
    Your Customer's Purchase Order to You is  
    Rescheduled, 7-12  
collaborate with customers  
    introduction, 1-3  
    publish forecasts, 3-5  
    publish supply commits, 3-6  
    receive forecasts, 3-7  
collaborate with suppliers  
    automated, 3-9  
    introduction, 1-3  
    on-hand inventory visibility, 3-15  
    receive supplier capacity, 3-14  
collaboration  
    image, 1-1

- with suppliers, 3-9
- collaboration business processes, 1-3
- collaboration cycle
  - image, 3-3
  - overview, 3-3
  - steps in, 3-3
- collaboration methods, 1-2
- collaboration with customers
  - types of business processes collaboration, 1-3
- collaborative inventory visibility, 6-1
  - creating groups, 6-2
  - define group members, 6-2
  - defining security rules, 6-3
  - features, 6-1
  - groups, 6-2
  - overview, 6-1
  - searching for inventory, 6-5
  - security rules, 6-3
  - setup, 6-1
  - unallocated on-hand inventory, 6-4
  - uploading inventory, 6-4
- collaborative planning
  - image, 1-1
- Collaborative Planning Time Bucketing, 9-10
  - benefits, 9-11
  - creating time buckets, 9-14
  - editing order quantities, 9-25
  - overview, 9-10
  - setup, 9-11
- comparing forecasts, 8-3
- Configure to Order (CTO) solution from Oracle
  - display CTO data, 9-9
- Contact Directory screen
  - image, 2-14
- customer collaboration
  - automated, 3-7
  - publish forecasts, 3-5
- customer collaboration automation, 3-7
  - capabilities, 3-8
  - overview, 3-7
- customer-facing VMI
  - executing, 5-12
    - consigned VMI with customers, 5-24
    - unconsigned VMI with customers, 5-13
  - user setup, 5-2
- Customer-facing VMI
  - overview, 5-1

- customer forecasts
  - uploading, 8-2
- customers
  - define, 2-7, 2-7
- customer sites
  - define, 2-7
- Customers screen
  - image, 2-11
- Customers - Summary screen
  - image, 2-10
- custom exceptions, 7-15
  - advanced conditions, 7-17
  - configuring notification headings, 7-18
  - copying, 7-19
  - creating, 7-15
  - creation steps, 7-15
  - defining conditions, 7-17
  - defining exception condition, 7-17
  - defining output attributes, 7-17
  - defining schedules, 7-18
  - defining scope, 7-16
  - describing, 7-16
  - editing, 7-19
  - naming, 7-16
  - overview, 7-15
  - saving, 7-19
  - schedules, 7-18
  - simple conditions, 7-17
  - specifying recipients, 7-18
  - specifying workflows, 7-18
  - workflow, 7-18

## D

---

- data, 2-39
  - loading, 2-39
  - publishing, 2-39
  - run collections, 2-43
  - troubleshooting, B-1
- data collections, 2-43
  - running, 2-43
- define customers, 2-29
  - standalone setup, 2-29
- define customer sites, 2-29
  - standalone setup, 2-29
- define group members, 6-2
- define sites, 2-29



- standalone setup, 2-29
- define suppliers, 2-29
  - standalone setup, 2-29
- define supplier sites, 2-29
  - standalone setup, 2-29
- define users, 2-29
  - Contact Directory screen image, 2-14
  - Customers screen image, 2-11
  - Customers-Summary screen image, 2-10
  - standalone setup, 2-29
  - Suppliers screen image, 2-13
- defining exception conditions, 7-17
- defining exception output attributes, 7-17
- defining exception scope, 7-16
- defining exception thresholds, 7-20
- defining schedules, 7-18
- defining security rules, 6-3
- demand
  - running totals, 9-27
  - viewing, 3-3
- deployment configurations, 2-2
  - single machine implementation, 2-2, 2-2
  - three machine implementation
    - image, 2-3
  - two machine implementation
    - image, 2-3

## **E**

---

- early order exceptions
  - Early Replenishment to Customer, 7-12
- early orders, 7-12
- early orders exceptions, 7-12
  - Early Replenishment from Supplier, 7-12
- End
  - image, 12-60
  - overview, 12-60
  - PL/SQL procedure, 12-61
- exception categories, 7-1
- exception recipients, 7-18
- exceptions, 4-19, 7-1, 7-7
  - accessing pegging information, 7-21
  - categories, 7-1
  - change orders, 7-12
  - Customer Forecast Error Exceeds the Threshold, 7-14
  - Customer Inventory Turns for VMI Item

- Below Threshold, 7-15
- Customer Order Forecast Exceeds Actual Orders, 7-13
- Customer Purchase Order Compresses Lead Time, 7-8
- Customer Purchase Order Does Not Exist for Your Sales Order, 7-7
- Customer Purchase Order has been Cancelled, 7-12
- Customer Sales Forecast Exceeds Actual Sales, 7-13
- Customer Sales Forecast Exceeds Your Sales Forecast, 7-11
- Customer Sales Forecast is Less than Your Sales Forecast, 7-11
- custom exceptions, 7-15
- defined, 7-1
- early orders, 7-12
- Early Replenishment from Supplier, 7-12
- Early Replenishment to Customer, 7-12
- entering pegging information, 7-21
- exception thresholds, 7-20
- Excess Replenishment for Customer Purchase Order, 7-6
- Excess Replenishment from Supplier for Purchase Order, 7-6
- forecast accuracy, 7-13
- Forecast Error Exceeds the Threshold, 7-14
- forecast mismatch, 7-9
- Inventory Turns for VMI Item Below Threshold, 7-14
- Late Replenishment from Supplier, 7-3
- Late Replenishment to Customer, 7-3
- material excess, 7-5
- On-time Delivery Performance is Below Threshold, 7-14
- Order Forecast Exceeds Actual Orders, 7-13
- overview, 7-1
- pegging, 7-21
- performance measure below target, 7-13
- Potential Late Order Due to Upstream Lateness, 7-8
- potential late orders, 7-8
- Purchase Order Compresses Lead Time, 7-8
- Replenishment From Supplier is Past Due, 7-3
- Replenishment to Customer is Past Due, 7-3
- Response to Trading Partner Required, 7-7, 7-7

- Sales Forecast Exceeds Actual Sales, 7-13
- Sales Order Requires Lead Time Compression, 7-8
- seeded, 7-2, 7-12
  - change orders, 7-12
  - forecast accuracy, 7-13
  - forecast mismatch, 7-9
  - late orders, 7-3
  - material shortage, 7-4
  - performance measure below target, 7-13
  - potential late orders, 7-8
  - Trading Partner Response Required, 7-7
- Short Supply for Customer Purchase Order, 7-4
- Short Supply from Supplier for Purchase Order, 7-4
- Supplier On-Time Performance is Below Threshold, 7-14
- Supplier Response Required for Purchase Order, 7-7
- Supplier Sales Forecast Exceeds Your Sales Forecast, 7-11
- Supplier Sales Forecast is Less Than Your Sales Forecast, 7-12
- Supplier Supply Commit Exceeds Order Forecast, 7-6
- Supplier's Supply Commit is Less Than Order Forecast, 7-4
- Supply Chain Event Management Engine, 7-2
- Supply Commit Exceeds Customer Order Forecast, 7-6
- Supply Commit is Less Than Customer Order Forecast, 7-4
- Trading Partner Response Required, 7-7
- troubleshooting, B-6
- vendor managed inventory, 4-19
- viewing, 7-2
- viewing pegging information, 7-22
- VMI Item Excess at the Customer Site, 7-6
- VMI Item Excess at Your Site, 7-6
- VMI Item Shortage at Customer Site, Replenishment Required, 7-5
- VMI Item Shortage at Your Site, 7-5
- You Have Exceeded a Stock Out Threshold, 7-14
- Your Customer's Purchase Order to You is Rescheduled, 7-12

- exception scope
  - defining, 7-16
- exception thresholds, 7-19
  - defining, 7-20
  - deleting, 7-20
  - overview, 7-19
- exporting data, 10-11

## F

---

- Find Requests window
  - image, 2-31
- Find System Profile Values window
  - image, 2-5, 2-27
- flat files, 2-41
  - uploading, 2-41
- forecast accuracy exceptions, 7-13
  - Customer Order Forecast Exceeds Actual Orders, 7-13
  - Customer Sales Forecast Exceeds Actual Sales, 7-13
  - Order Forecast Exceeds Actual Orders, 7-13
  - Sales Forecast Exceeds Actual Sales, 7-13
- forecast comparison
  - troubleshooting, B-6
- forecasting
  - orders, 3-1
  - overview, 3-1
  - programs, 3-2
  - publishing and receiving, 3-2
  - sales, 3-1
  - types of, 3-1
- forecast mismatch exceptions, 7-9
  - Customer Sales Forecast Exceeds Your Sales Forecast, 7-11
  - Customer Sales Forecast is Less than Your Sales Forecast, 7-11
  - Supplier Sales Forecast Exceeds Your Sales Forecast, 7-11
  - Supplier Sales Forecast is Less Than Your Sales Forecast, 7-12
- forecast versioning, 3-4
  - overview, 3-4
  - setup, 3-4
- function activities
  - End, 12-60
  - Start, 12-61

functions, 12-49  
Funds checking, Glossary-54  
Funds reservation, Glossary-54

## **G**

---

generating replenishments, 4-11  
groups, 6-2

- collaborative inventory visibility, 6-2
- creating, 6-2
- define members, 6-2
- defining, 6-2

## **H**

---

horizontal view

- advanced, 9-1
- advanced search, 9-3
- available columns, 9-10
- editing order quantities, 9-9
- overview, 9-2
- preference sets, 9-7
- search region, 9-2

Horizontal view

- display CTO data, 9-9

## **I**

---

implementation

- single machine, 2-2
- standalone, 2-26
- three machine, 2-3
- two machine, 2-3
- with Oracle Advanced Supply Chain Planning
  - benefits of, 1-2
- with other Oracle Applications, 1-2
  - benefits of, 1-2

implementation types, 2-1  
integration

- with other Oracle Applications, 1-2

inventory

- on-hand visibility, 3-15
- replenishing, 4-18
- searching for, 6-5

inventory searches, 6-5  
Inventory Status window, 4-14  
items, 2-21

- setup, 2-21

setup procedure, 2-21  
standalone setup, 2-35

items setup

- Master Item window, 2-21

item types

- Standard, 12-9
- workflow, 12-9

## **K**

---

key tables, D-1

## **L**

---

legacy instance

- setup, 2-26

legacy integration loads, C-3  
loading

- data, 2-39

loading data, 2-39

- sync indicators, 2-40

loading flat files

- image, 2-41

## **M**

---

Master Item window image, 2-21  
material excess exceptions, 7-5

- Excess Replenishment for Customer Purchase Order, 7-6
- Excess Replenishment from Supplier for Purchase Order, 7-6
- Supplier Supply Commit Exceeds Order Forecast, 7-6
- Supply Commit Exceeds Customer Order Forecast, 7-6
- VMI Item Excess at the Customer Site, 7-6
- VMI Item Excess at Your Site, 7-6

material shortage exceptions, 7-4

- Short Supply for Customer Purchase Order, 7-4
- Short Supply from Supplier for Purchase Order, 7-4
- Supplier's Supply Commit is Less Than Order Forecast, 7-4
- Supply Commit is Less Than Customer Order Forecast, 7-4
- VMI Item Shortage at Customer Site,

- Replenishment Required, 7-5
- VMI Item Shortage at Your Site, 7-5
- modifying seeded data
  - extending workflow
    - modifying seeded data, 12-3
- vendor managed inventory
  - inventory
    - monitoring inventory status, 4-12
- multi company collaboration
  - executing, 11-8
    - Demand Planning and forecast collaboration, 11-8
    - supply chain planning and collaboration with suppliers, 11-10
  - Oracle applications support, 11-2
  - overview, 11-1
- multi-company collaboration
  - supply chain collaboration with suppliers and contract manufacturers, 11-16
- multi-tier collaborations, 1-4
  - capabilities of, 1-4
  - establishing, 1-4

## **N**

---

- naming custom exceptions, 7-16
- notification headings, 7-18
- notifications, 4-20
  - vendor managed inventory, 4-20

## **O**

---

- on-hand inventory
  - collaborative inventory visibility, 6-4
  - unallocated, 6-4
- on-hand inventory visibility, 3-15
- Oracle Advanced Planning and Scheduling
  - setup with Oracle Collaborative Planning, 2-4
- Oracle Advanced Supply Chain Planning
  - integration with Oracle Collaborative Planning, 1-2
  - publishing data using, 2-42
- Oracle Collaborative Planning
  - collaboration methods, 1-2
  - deployment configurations, 2-2
  - functionalities, 1-6
  - implementation types, 2-1
  - integration with Oracle Advanced Supply

- Chain Planning, 1-2
  - integration with Oracle Demand Planning, 1-2
  - integration with Oracle iSupplier Portal, 1-2
  - item types
    - Standard, 12-9
  - key tables, D-1
  - loading data, 2-39
  - orders, 2-44
  - overview, 1-1
  - processes used in, 12-32
  - profile options, A-1
  - publishing data, 2-39
  - setup, 2-1
    - define users, 2-8
  - setup with Oracle Advanced Planning and Scheduling, 2-2, 2-4
  - setup with Oracle e-Business Suite, 2-2, 2-4
  - standalone setup, 2-2
  - workflow
    - functions, 12-49
  - workflows
    - customizations, 12-2
    - exceptions, 12-3
    - overview, 12-2
    - workflows used in, 12-32
- Oracle Collaborative Planning setup
  - calendar, 2-16
  - define customers, 2-7
  - define customer sites, 2-7
  - define suppliers, 2-7
  - define supplier sites, 2-7
  - items, 2-21
  - loading data, 2-39
  - Oracle iSupplier Portal, 2-22
  - orders, 2-44
  - publishing data, 2-39
- Oracle Demand Planning
  - integration with Oracle Collaborative Planning, 1-2
  - publishing data using, 2-43
  - receiving forecasts in, 3-7
- Oracle e-Business Suite
  - setup with Oracle Collaborative Planning, 2-4
- Oracle iSupplier Portal
  - integration diagram, 1-5
  - integration with Oracle Collaborative Planning, 1-2, 1-5, 2-22

- setup, 2-22
- Oracle Workflow Builder
  - viewing processes in, 12-4
- order forecast collaboration, 1-3, 3-2
- order forecasting, 3-1
- order forecasts
  - publish, 3-10
- order quantities, 9-9
  - editing, 9-9
- orders, 2-44
- order types
  - vendor managed inventory, 4-3
- output attributes
  - defining, 7-17

## **P**

---

- parameters
  - vendor managed inventory, 4-5
- Parameters window
  - calendar setup, 2-20
  - image, 2-20, 2-34
- pegging, 7-21
  - accessing information, 7-21
  - entering information, 7-21
  - exceptions, 7-21
  - viewing information, 7-22
- pegging information, 7-21
- performance measure below target exceptions, 7-13
  - Customer Forecast Error Exceeds the Threshold, 7-14
  - Customer Inventory Turns for VMI Item Below Threshold, 7-15
  - Forecast Error Exceeds the Threshold, 7-14
  - Inventory Turns for VMI Item Below Threshold, 7-14
  - On-time Delivery Performance is Below Threshold, 7-14
  - Supplier On-Time Performance is Below Threshold, 7-14
  - You Have Exceeded a Stock Out Threshold, 7-14
- potential late order exceptions
  - Customer Purchase Order Compresses Lead Time, 7-8
- potential late orders, 7-8

- potential late orders exceptions, 7-8
  - Potential Late Order Due to Upstream Lateness, 7-8
  - Purchase Order Compresses Lead Time, 7-8
  - Sales Order Requires Lead Time Compression, 7-8
- preference sets, 9-7
  - demand running totals, 9-27
  - supply running totals, 9-27
- processes
  - viewing in Oracle Workflow Builder, 12-4
  - workflow, 12-32
- profile options, A-1
  - available, A-1
  - descriptions, 2-28
  - list, 2-6
  - setup, 2-5
  - standalone setup, 2-26
  - used in Oracle Collaborative Planning, A-1
- publish forecasts
  - collaborate with customers, 3-5
  - customer collaboration, 3-5
- publishing
  - data, 2-39
  - using Oracle Advanced Supply Chain Planning, 2-42
  - using Oracle Demand Planning, 2-43
- publishing data, 2-39
- publishing forecasts
  - programs, 3-2
- publish order forecast
  - from ASCP, 4-9
- publish order forecasts
  - supplier collaboration, 3-10
- publish supply commits
  - collaborate with customers, 3-6
  - customer collaboration, 3-6
- purchase agreements, 4-4
- purchase orders
  - editing, 3-14
  - responding to, 3-14

## **R**

---

- receive forecasts
  - in Oracle Demand Planning, 3-7
- receive supplier capacity, 3-14

- recipients
  - specifying exception recipients, 7-18
- releasing replenishment orders, 4-2
- replenishing inventory, 4-18
- replenishment orders, 4-2
- replenishments
  - generating, 4-11
- requests, 1-9
  - viewing, 1-9
- Reservations
  - hard, Glossary-55
- Response to Trading Partner Required
  - seeded exceptions
    - Response to Trading Partner Required, 7-7
- Response to Trading Partner Required
  - exceptions
    - Response Required for Customer Purchase Order, 7-7
    - Response Required for Supplier Sales Order, 7-7
- responsibilities, 2-16
  - definitions, 2-16
  - possible assignments, 2-16
- running data collections, 2-43

## S

---

- sales forecast collaboration, 1-3, 3-1
- sales forecasting, 3-1
- SCEM Engine, 7-2
- searching for forecasts, 8-3
- searching for inventory, 6-5
- security rules, 6-3
  - defining, 6-3
- seeded data file mscxascp.wft, 12-8
- seeded data file mscxdprf.wft, 12-7
- seeded data file mscxewf.wft, 12-6
- seeded data file mscxmir.wft, 12-6
- seeded data file mscxnet.wft, 12-6
- seeded data file mscxpbpf.wft, 12-7
- seeded data file mscxpbsc.wft, 12-8
- seeded data file mscxrcsc.wft, 12-8
- seeded data file mscxscem.wft, 12-8
- seeded data file mscxudex.wft, 12-6
- seeded data files, 12-5
- seeded exceptions, 7-2, 7-8

- change orders, 7-12
- early orders, 7-12
- forecast accuracy, 7-13
- forecast mismatch, 7-9
- performance measure below target, 7-13
  - Trading Partner Response Required, 7-7
- setting up multi-tier collaboration, 2-35
- setup
  - access level, 12-1
  - define users, 2-8
  - overview, 2-1
  - with Oracle Advanced Planning and Scheduling, 2-4
  - with Oracle e-Business Suite, 2-4
- Set Up Buyer Code and Item Category for Advanced Search
  - setup, 2-23
- set up collaborative inventory visibility, 6-1
- setup items
  - standalone setup, 2-35
- setup legacy instance, 2-26
- setup profile options, 2-5
- setup steps, 2-2
- setup with Oracle Advanced Planning and Scheduling, 2-2, 2-4
  - assign responsibilities, 2-16
  - define customers, 2-7
  - define customer sites, 2-7
  - define suppliers, 2-7
  - define supplier sites, 2-7
  - define users, 2-8
  - items, 2-21
  - Oracle iSupplier Portal, 2-22
  - profile options, 2-5
  - Set Up Buyer Code and Item Category for Advanced Search, 2-23
  - setup with Oracle e-Business Suite, 2-2, 2-4
    - assign responsibilities, 2-16
    - define customers, 2-7
    - define sites, 2-7
    - define suppliers, 2-7
    - define users, 2-8
    - items, 2-21
    - Oracle iSupplier Portal, 2-22
    - profile options, 2-5
    - Set Up Buyer Code and Item Category for Advanced Search, 2-23

- sharing workbooks, 9-30
- simple exception conditions, 7-17
- single machine implementation, 2-2
  - image, 2-2
- sites
  - define, 2-7
- specifying exception recipients, 7-18
- standalone setup, 2-2, 2-29
  - assign responsibilities, 2-29
  - define customers, 2-29
  - define customer sites, 2-29
  - define sites, 2-29
  - define supplier, 2-29
  - define supplier sites, 2-29
  - define users, 2-29
- Find System Profile Values window, 2-27
- items, 2-35
- legacy instance setup, 2-26
- other entities, 2-35
- Parameters window, 2-34
- profile options, 2-26, 2-28
- Submit a New Request window, 2-32
- Submit Request window, 2-33
- Start
  - image, 12-61
  - overview, 12-61
  - PL/SQL procedure, 12-61
- Submit a New Request window
  - image, 2-18, 2-32
- Submit Request window
  - image, 2-19, 2-33
- submitting advance shipment notices, 4-11
- supplier collaboration, 3-9
  - automation, 3-9
  - edit purchase orders, 3-14
  - on-hand inventory visibility, 3-15
  - publish order forecasts, 3-10
  - purchase orders, 3-14
  - receive supplier capacity, 3-14
  - respond to purchase orders, 3-14
- supplier collaboration automation, 3-9
  - overview, 3-9
- suppliers
  - approved supplier lists, 4-9
  - collaboration with, 3-9
  - define, 2-7, 2-7
- supplier sites

- define, 2-7
- Suppliers screen
  - image, 2-13
- supply
  - running totals, 9-27
  - viewing, 3-3
- Supply Chain Event Management Engine, 7-2
- supply chain event manager, 1-9
  - setup steps, 1-9
- sync indicators, 2-40

## T

---

- tables, D-1
- three machine implementation
  - image, 2-3
- time bucketing impact on Receive Supply Capacity program, 3-14
- time buckets, 1-8
- trading partner response required exceptions
  - Customer Purchase Order Does Not Exist for Your Sales Order, 7-7
  - Supplier Response Required for Purchase Order, 7-7
- troubleshooting
  - exceptions, B-6
  - forecast comparison, B-6
  - horizontal view, B-5
  - loading data, B-1
  - security rules, B-6
  - vendor managed inventory with customers, B-4
  - vendor managed inventory with suppliers, B-3
  - vertical view, B-3
  - XML Gateway, B-7
- two machine implementation
  - image, 2-3

## U

---

- unallocated on-hand inventory, 6-4
  - uploading, 6-4
- upload customer forecasts, 8-2
- users
  - define, 2-8
- Users window
  - image, 2-8

## V

---

- valid responsibilities, 2-16
- vendor managed inventory
  - advance shipment notices, 4-11
  - approved supplier lists, 4-9
  - ASN, 4-11
  - blanket purchase agreements, 4-4
  - capabilities, 4-1
  - collecting approved supplier lists, 4-9
  - exceptions, 4-19
  - generate replenishments, 4-11
  - notifications, 4-20
  - order types, 4-3
  - overview, 4-1
  - parameters, 4-5
  - process, 4-4
  - purchase agreements, 4-4
  - releasing replenishment orders, 4-2
  - replenish inventory, 4-18
  - replenishment engine, 4-10
  - replenishment orders, 4-2
  - submitting advance shipment notices, 4-11
  - user setup, 4-4
  - VMI Replenishment Engine, 4-19
- vertical view
  - display CTO data, 10-16
  - export data in import format, 10-11
  - exporting, 10-11
  - overview, 10-1
- viewing exceptions, 7-2
- viewing requests, 1-9
- VMI
  - overview, 4-1
  - replenishment engine, 4-10
- VMI Replenishment engine, 4-10
- VMI Replenishment Engine, 4-19

## W

---

- waterfall analysis, 8-1
  - comparing forecasts, 8-3
  - definition, 8-1
  - overview, 8-1
  - searching for forecasts, 8-3
  - setup, 8-2
  - uploading customer forecasts, 8-2

- workbooks
  - sharing, 9-30
  - viewing, 9-30
- workflow
  - custom exceptions, 7-18
  - extending
    - seeded workflow data, 12-3
  - extending in Oracle Collaborating Planning, 12-2
  - functions, 12-49
  - item types, 12-9
    - DP Receive Forecast, 12-31
    - Oracle Collaborative Planning VMI Replenishment, 12-9
    - Publish Order Forecast, 12-25
    - Publish Supply Commit, 12-27
    - Start ASCP Engine, 12-25
    - Start Receive Supplier Capacity, 12-26
    - Start SCEM Engine, 12-25
    - Supply/Demand Mismatch, 12-27
    - User Define Exception Workflow, 12-12
    - Workflows for Oracle Collaborative Planning, 12-30
  - processes, 12-32
    - DP Receive Forecast, 12-42
    - Error Notifications for Excel Import of Forecast/Supply, 12-33
    - Oracle Collaborative Planning VMI Replenishment, 12-37
    - Publish Order Forecast, 12-44
    - Publish Supply Commit, 12-45
    - Start ASCP Engine, 12-41
    - Start Receive Supplier Capacity, 12-46
    - Start SCEM Engine, 12-47
    - Supply/Demand Mismatch, 12-35
    - User Define Exception Workflow, 12-34
  - seeded data files, 12-5
  - viewing in Oracle Workflow Builder, 12-4
- workflow functions, 12-49
  - Build Error Message, 12-58
  - Clean Up, 12-59
  - Create Replenishment, 12-49
  - Determine Planners, 12-59
  - Is Auto Release?, 12-50
  - Launch ASCP Engine, 12-55
  - Launch DP Receive Forecast, 12-60
  - Launch Publish Order Forecast, 12-56



Launch Publish Supply Commit, 12-57  
Launch Receive Supplier Capacity, 12-57  
Launch SCEM Engine, 12-56  
Reject Replenishment, 12-50  
Release Replenishment, 12-51  
Send Exception Notification, 12-55  
Send Out Exceptions, 12-58

## **X**

---

XML, C-1  
  legacy integration loads, C-3  
  loading supply/demand, C-2  
  overview, C-1  
  setup XML Gateway, C-3  
  transactions, C-1  
XML Gateway  
  troubleshooting, B-7

