



Application Guide for Siebel eBilling Manager (Consumer Edition)

Version 5.1
Date Published: 2.28.2006

Copyright © 2005, 2006, Oracle and/or its affiliates
All rights reserved

The Programs (which include both the software and documentation) contain proprietary information; they are provided under a license agreement containing restrictions on use and disclosure and are also protected by copyright, patent, and other intellectual and industrial property laws. Reverse engineering, disassembly, or decompilation of the Programs, except to the extent required to obtain interoperability with other independently created software or as specified by law, is prohibited.

The information contained in this document is subject to change without notice. If you find any problems in the documentation, please report them to us in writing. This document is not warranted to be error-free. Except as may be expressly permitted in your license agreement for these Programs, no part of these Programs may be reproduced or transmitted in any form or by any means, electronic or mechanical, for any purpose.

PRODUCT MODULES AND OPTIONS. This guide contains descriptions of modules that are optional and for which you may not have purchased a license. Siebel's Sample Database also includes data related to these optional modules. As a result, your software implementation may differ from descriptions in this guide. To find out more about the modules your organization has purchased, see your corporate purchasing agent or your Siebel sales representative.

If the Programs are delivered to the United States Government or anyone licensing or using the Programs on behalf of the United States Government, the following notice is applicable:

U.S. GOVERNMENT RIGHTS. Programs, software, databases, and related documentation and technical data delivered to U.S. Government customers are "commercial computer software" or "commercial technical data" pursuant to the applicable Federal Acquisition Regulation and agency-specific supplemental regulations. As such, use, duplication, disclosure, modification, and adaptation of the Programs, including documentation and technical data, shall be subject to the licensing restrictions set forth in the applicable Oracle license agreement, and, to the extent applicable, the additional rights set forth in FAR 52.227-19, Commercial Computer Software--Restricted Rights (June 1987). Oracle USA, Inc., 500 Oracle Parkway, Redwood City, CA 94065.

The Programs are not intended for use in any nuclear, aviation, mass transit, medical, or other inherently dangerous applications. It shall be the licensee's responsibility to take all appropriate fail-safe, backup, redundancy and other measures to ensure the safe use of such applications if the Programs are used for such purposes, and we disclaim liability for any damages caused by such use of the Programs.

Oracle, JD Edwards, PeopleSoft, and Siebel are registered trademarks of Oracle Corporation and/or its affiliates. Other names may be trademarks of their respective owners.

The Programs may provide links to Web sites and access to content, products, and services from third parties. Oracle is not responsible for the availability of, or any content provided on, third-party Web sites. You bear all risks associated with the use of such content. If you choose to purchase any products or services from a third party, the relationship is directly between you and the third party. Oracle is not responsible for: (a) the quality of third-party products or services; or (b) fulfilling any of the terms of the agreement with the third party, including delivery of products or services and warranty obligations related to purchased products or services. Oracle is not responsible for any loss or damage of any sort that you may incur from dealing with any third party.

Contents

1 Overview

- 1.1 Siebel Customer Self-Service 5
- 1.2 Siebel Billing Manager 5
- 1.3 Key Benefits of Billing Manager 15
- 1.4 Siebel Self-Service Suite 20
- 1.5 Conclusion 22

2 Business Processes and Application Logic

- 2.1 Business Processes and Application Logic 23
- 2.2 System Context Diagram 24
- 2.3 Navigation Flow Diagram 25
- 2.4 Menu Navigation Diagram 26
- 2.5 Billing Manager UI Site Map 26
- 2.6 Users 27

3 Site Webflows

- 3.1 About Site Webflows 29
- 3.2 Catalog of Application Logic 30
- 3.3 Functionality Overview 31
- 3.4 Enrollment and Authentication Use Cases 33
- 3.5 General User Interface 40
- 3.5 Statement Presentment Use Cases 44
- 3.6 Payment Use Cases 57
- 3.7 Analytics Use Cases 73
- 3.8 Profile Management Use Cases 76

3.9 Customer Service Representative (CSR) 85

4 System Use Cases

4.1 Enrollment and Profile Use Cases 103

4.2 Payment System Use Cases 105

4.3 E-Mail Notifications 106

5 External Interfaces

Overview of Integration Points 111

Data Files 112

ACH Files 112

A/R Files 112

New Standards and Best Practices 113

1

Overview

1.1 Siebel Customer Self-Service

Siebel is the world's leading provider of customer Self-Service and e-billing software and services. Its solutions help service providers increase customer loyalty while reducing the overall cost to serve their customers. Service providers use the software to move customer service interactions from expensive paper and call center-based channels to lower-cost and more responsive self-service and assisted care channels like the web, e-mail and IVR.

Siebel software has been deployed in some of the most challenging business and technical environments in the world and has proven to be the industry's most scalable and reliable solution. The applications have been continuously developed and refined to deliver the most comprehensive self-service functionality available. As a result, Siebel customers consistently gain the highest adoption and ROI – typically 5-10 times higher than companies using in-house or competing packaged solutions.

Self-Service for Consumers and Businesses

Many billing and customer care processes today are expensive, inefficient and unsatisfactory for both communication service providers (CSP's) and their customers. With Siebel's customer Self-Service and e-billing solutions, providers empower their business and consumer customers to serve themselves and address all of their account and service-related activities online, instead of going through a call center, account rep, or retail outlet. For end customers, this makes doing business with a service provider more convenient, more efficient, and more satisfying. For service providers, it means improved competitive differentiation, significantly reduced customer care costs, increased customer loyalty and streamlined billing/payment processing.

Contact centers provide the key to unlocking the potential business benefits of customer Self-Service. Contact center statistics show that 60-80 percent of customer service issues relate to a customer's account. For this reason, Siebel customer Self-Service solutions provide direct access to detailed account information, and interface with complementary front-and back-office systems to provide access to a variety of account-related services.

1.2 Siebel Billing Manager

Billing Manager Features

Siebel Billing Manager is the leading electronic bill presentment and payment (EBPP) solution for service providers.

Billing Manager provides the mission-critical application platform required for securely managing customer account information such as bills, statements, and other data. With Billing Manager, service providers can provide business and consumer customers with highly personalized online account information and self-service capabilities that can be served across multiple channels (Web, PDF, IVR, hand-held devices and e-mail). It serves as the foundation for managing recurring customer relationships.

Billing Manager is specifically designed for organizations with large numbers of customers, high data volumes and extensive integration with systems and business processes across the enterprise. With its sophisticated data access layer, platform services, and data stores, Billing Manager is uniquely capable of powering the most complex EBPP and Customer Self-Service solutions.

Realizing that consumer and business customers have very different service needs, Billing Manager is available in a consumer edition and business edition with specific features and functionality designed for each user base.

The core capabilities of the Billing Manager application editions are detailed below.

Billing Manager Consumer Edition

Billing Manager Consumer Edition Overview

The screenshot displays the Billing Manager Consumer Edition interface. At the top, there are navigation tabs: **My Account**, **Statements**, **Payments**, and **Self-Service**. Below these, a sub-menu includes **Overview**, **Hierarchy**, **Personal**, **Company**, and **Set Position**. The **Overview** section shows the user's name as Anne Green and the company as CellTec. It also displays the hierarchy name as Billing Accounts and the position name as Billing Accounts. A **Download** button is visible.

The main content area is divided into two columns. The left column, titled **Business Structures**, features a filter dropdown set to **Service Agreement** and a search box. Below this is a tree view of departments: **Administration**, **Client Services**, **Research and Development**, **Sales and Marketing (2/2)**, **Marketing**, and **Sales**. The right column, titled **Sales**, also has a filter dropdown set to **Service Agreement** and a search box. It displays a table of sales records with columns for account number, amount, and status.

Account Number	Amount	Status
06122165		Last Statement
318-743-4734	\$-2.23	Unbilled
369-484-8934	\$36.49	Unbilled
369-948-3843	\$36.49	Unbilled
382-215-2803	\$36.94	Unbilled
382-473-4937	\$12.37	Unbilled
397-894-2100	\$56.29	Unbilled
397-894-2101	\$34.78	Unbilled

At the bottom of the sales list, it indicates "8 (of 8) records returned." On the right side of the page, there is a sidebar with **CellTec** statistics (Business Structures: 3, Billing Accounts: 24, Service Agreements: 76), **User Information** for Anne Green (Username: agreen, Password: masked, Role: Administrator), and **Quick Links** for [View Last Statement](#) and [FAQs](#).

Billing Manager Consumer Edition is focused on the self-service needs of a large consumer base. The core features of the application are described below.

Customer Account Dashboard

Bills or statement data is dynamically presented within the application dashboard. Once properly authenticated, users can easily and conveniently navigate and view their billing statements, account summaries and call details.

Electronic Bill Presentment and Consolidation

Consumer customers can access their bills or invoices online, including historical bills stored for as many years as the service provider prefers. Each monthly bill, for a single service or consolidated for multiple services, is presented in dynamic fashion using HTML and can include up-to-date account information such as current balance, bill details, unbilled-usage, last payment received, last payment date, etc. Customers can sort table columns, filter and drill-down into the call detail to further validate charges.

Electronic Bill Payment and Posting

Customers have the complete flexibility to control how and when payments are made. Payment is set up via bank and/or other credit accounts within Billing Manager to execute instant payments or to schedule future automatic payments. Customers have the ability to view the status and record of previously made payments. Billing Manager also provides an accounts-receivable settlement file for the service provider with the following information: payment amount, payment date, statement number, account number, payment account, payment type (one-time/recurring) and return status (yes or no with corresponding negative amount). Users can change their payment options and user preferences within the application. They can also establish multiple payment methods and payment notification preferences, make one-time payments, automate recurring payments, and set payment thresholds and reminders.

User Profile Management and Notifications

User information and settings are presented and modified within the application. Users may update their profile information, correct personal data, and manage password or notification options, email addresses, and other personal preferences.

Customer profiles may be updated on a real-time basis at anytime while the customer is properly authenticated. Profile information such as the customer's preference for account notifications can be set. Billing Manager manages and sends e-mail and SMS messages concerning individual accounts or transaction events. A variety of conditions or circumstances can trigger email notifications. Service providers may wish to enable some common notifications:

- Current corporate statements are available
- Payment reminders
- Payment confirmations
- Payment rejections
- Threshold exceeded on recurring payments
- Credit card expiration pending

Users may establish multiple notification or alert options and modify their settings at any time.

Three-Tier Disputes

Users can contest a service charge, call or surcharge within the application. Billing Manager provides a flexible system for handling both invoice and transaction level disputes. The application manages individual transaction disputes, dispute reason codes, account annotations, dispute capture and submission to back-end systems for reconciliation. This lets users view statements and dispute account information at the summary level, service level, or call detail directly through the interface. This feature may be configured based on the provider's business requirements or back-office integration needs.

Unbilled Data Presentment

Unbilled account charges can be viewed online prior to bill cycle closing within the application. Users can view their charges as well as analyze to-date spending for the current billing period.

Personal Address Book (PAB)

Using Billing Manager, customers can create a list of phone numbers and assign name pairs allowing them to view call detail with meaningful names exchanged for frequently called numbers. With this feature, users can associate bill detail with more familiar, meaningful identifiers. Once entered in the PAB, names may be toggled on to replace corresponding numbers on the bill, making online account management easier, more convenient and more valuable for users.

B2C Reporting

Specific reports come with the application whereby users may view summaries, analyze charts, and access their complete statement history using built-in reporting features. Furthermore, users may also drill-down through account information, bill or statement data within the application. Specifically, they can page through call details, sort across pages, sub-total and filter account information viewing dynamic reports.

Print Friendly Views, PDFs and Downloads

Users may access print friendly views, request a dynamic PDF of their statement, or select to download a dataset. These features are all available for key application views. Billing Manager's versioned, disk-efficient and high performance bill archiving feature along with its print-friendly views makes generating hard-copy reprints simple and efficient.

Customer Service Representative (CSR) Views

Billing Manager also provides a lightweight solution for customer service management. CSRs can also “impersonate” the user to facilitating the efficient servicing of online accounts. For example, representatives may have roles that provide application access to execute payments, reset passwords or simply search accounts to view the customer statement. The application may also be extended for complete case management with Siebel Call Center Application, providing additional case creation, routing and tracking, status views of cases, escalation workflows and queuing. Cases can either be completely automated without agent intervention based on predetermined business rules, or routed appropriately to engage an agent for resolution.

Multi-DDN

The application enables multiple DDN support. The application supports multiple billing feed formats from the same or different billing systems which is critical when multiple billing systems are involved or multiple billing formats are required to support multiple products (wireless, wire line, DSL).

Internationalization

Internationalization support in Billing Manager application allows the application to be translated into multiple languages. Taking advantage of Java’s inherent support for internationalization, the process involves localizing resource strings/messages to resource bundles corresponding to desired language(s). Localization is performed by simply adding locale-specific components, such as translated text, data describing locale-specific behavior, fonts, and input methods.

Billing Manager Business Edition

Billing Manager Business Edition Dashboard

The screenshot displays the 'Billing Manager Business Edition' dashboard for a user named Anne Green. The interface includes a navigation bar with tabs for 'My Account', 'Statements', 'Payments', and 'Self-Service'. The 'Overview' tab is active, showing account details for 'CellTec' and 'Billing Accounts: 03286008'. A sidebar on the left lists various billing accounts, and a main panel shows a table of 'Last Invoiced Balance' for several wireless numbers. A right-hand panel provides user information, including the username 'agreen' and role 'Administrator'.

Wireless Number	Last Invoiced Balance	Last Statement
03286008	\$1,635.61	Last Statement
415-807-8462	\$24.71	Unbilled
415-725-8926	\$38.17	Unbilled
415-783-8162	\$41.37	Unbilled
415-896-1438	\$37.91	Unbilled
415-412-7251	\$38.10	Unbilled

Billing Manager Business Edition is focused on the self-service needs of an enterprise customer base. The core features of the application are described below.

Corporate Account Dashboard

Account information, bills or statement data is dynamically presented within the application by the business billing structure. Once properly authenticated, managers, administrators and users may view consolidated account summaries, sub-accounts, individual statements or all call details based on their access permissions for the billing structure.

Hierarchical Billing and Business Structures

Billing structures are presented within the application as account hierarchies. Managers or administrators may search, view and update their billing structure by assigning other attributes to hierarchy nodes, such as, meaningful names or device IDs, etc. Users are assigned within the billing structure, defining navigation within the account and sub-accounts of billing data. Administrator assignment in the billing structure may provide access to the entire enterprise or limit a single user to viewing their individual statement only. By creating separate business structures within the application, users may maintain multiple hierarchies of their own. Billing structures and user created business structures offer different views of account information for segmentation, payment, analysis and reporting.

Large Hierarchies

For customers with large numbers of accounts or service agreements, the foundation application UI has been enhanced to eliminate latency and make the UI more practical to navigate. The service provider can configure various thresholds above which the user will receive a message that not all records have been displayed and the user will need to filter the displayed records. Filters have been added throughout the application so that the user can narrow the scope of records being displayed on their screen. Additionally a number of system configurable thresholds have been implemented within the application. These include:

- Display Threshold Hierarchy Tree
- Display List Threshold
- Retrieval Threshold
- Dropdown Threshold
- Large Enterprise User

Further information on these thresholds can be found in the developer documentation for this product.

Electronic Bill Presentment and Consolidation

Business customers can access their bills or invoices online including historical bills stored for as many years as the service provider prefers. Each billing period, for a single service or consolidated for multiple services, is presented in dynamic fashion using HTML and can include up-to-date account information such as current balance, bill details, last payment received, last payment date, etc. Furthermore, accounts can be consolidated across disparate system using either full data consolidation via an external data store or summary consolidation by dynamically linking the accounts. Customers can sort table columns, filter and drill-down into the call detail to further validate charges.

Cross Invoice/Sub-Invoice Payment

Payment options and enterprise preferences can be presented and modified within Billing Manager. Administrators can establish multiple payment methods and payment notification preferences, make one-time payments, schedule automated recurring payments, and set payment thresholds and reminders. Administrators may also make a single payment across multiple invoices, defining the payment allocation, even allocating payment to sub-invoice charges. Administrators have the complete flexibility to control how and when payments are made. Payment is set-up via bank and/or other credit accounts within Billing Manager to execute instant payments or to schedule future automatic payments. Administrators also have the ability to view the status and record of previously made payments. Billing Manager integration provides an accounts receivable settlement file to the service provider with the following information: payment amount, payment date, statement number, account number, payment account, payment type (one-time/recurring) and return status (yes or no with corresponding negative amount).

User Roles and Permissions

User roles and permissions can also be presented and modified within the application. Administrators may update user role or access, establishing view only permissions, accounts receivable roles, managerial access, etc. This feature may be configured based on the provider business requirements or back-office integration needs.

Corporate and User Profile Management and Notifications

Corporate profiles are managed by designated administrators, whereas users may update their own profile information, correct personal data, and manage password or notification options, email addresses, and other personal preferences.

Corporate and user profiles may be updated on a real-time basis at anytime while properly authenticated. Profile information such as the corporate contact preferences for account notifications can be set. Billing Manager manages and sends e-mail messages concerning accounts or transaction events. Notifications may be aggregated for account and sub-accounts events and limited to administrator or managerial roles. A variety of conditions or circumstances can trigger email notifications, so service providers may wish to enable some common notifications:

- Current corporate statements are available
- Payment reminders
- Payment confirmations
- Payment rejections
- Threshold exceeded on recurring payments
- Credit card expiration pending

Corporate administrators and users may establish multiple notification or alert options and modify their settings at any time.

Unbilled Data Presentment

With Billing Manager, managers, administrators and users may view unbilled account charges prior to bill cycle closing. All users may view their charges and analyze to-date spending for the current billing period. This feature may be configured based on the provider business requirements or back-office integration needs.

Corporate and Personal Address Book

Administrators may create a global list of phone numbers and assigned name pairs within the application for their accounts. Individual users may also create and maintain a personal address of their own. Users may implement both address books and then view call detail with meaningful names exchanged for frequently called numbers.

Advanced Reporting

Specific reports come with the application whereby users may view summaries, analyze charts, and access their complete statement history using built-in reporting features. Additional business reports are also provided whereby administrators may view a set library of summarized call cost reports and charts. These “roll-up” reports provide for broad analysis of account activity for corporate managers. Furthermore, managers, administrators and users may drill-down through account information, bill or statement data within the application interface. Users can page through call details, sort across pages, sub-total and filter account information viewing dynamic reports. More complex reporting can be performed with Siebel Billing Analytics including extensive call, cost, cost-center, and variance reporting.

Print Friendly, PDFs and Downloads

Users may access print friendly views, request a dynamic PDF of their invoice, or select to download a dataset. Managers and administrators have greater access to account summary PDFs and datasets for the accounts they supervise. Billing Manager’s versioned, disk-efficient and high-performance bill archiving feature along with its print-friendly views make generating hardcopy reprints quick and easy.

Customer Service

CSRs may create corporate administrators for an organization, thereby enrolling a corporate account and establishing designated internal administrators. Service representatives and corporate administrators may create, manage and search the business organizations and accounts under their supervision. The designated administrators accessing corporate billing statements use Billing Manager’s on-line Self-Service application features to manage their own organization and users.

Multi-DDN

The application enables multiple DDN support. The application supports multiple billing feed formats from the same or different billing systems which is critical when multiple billing systems are involved or multiple billing formats are required to support multiple products (wireless, wire line, DSL).

Internationalization

Internationalization support in Billing Manager application allows the application to be translated into multiple languages. Taking advantage of Java’s inherent support for internationalization, the process involves localizing resource strings/messages to resource bundles corresponding to desired language(s). Localization is performed by simply adding locale-specific components, such as translated text, data describing locale-specific behavior, fonts, and input methods.

Billing Manager Edition Comparisons

Feature Comparisons of Billing Manager Editions	B2C	B2B
Bill Presentment	X	X
Unbilled Data Presentment	X	X
Service-Level Consolidation	X	X
Account-Level Consolidation/Linking		X
Hierarchical Navigation		X
Bill Payment	X	X
Cross and Sub-Invoice Payment		X
Notifications	X	X
Consumer (Simple) Reporting	X	X
Advanced Reporting		X
CSR Access	X	X
User Profile Management	X	X
Roles Based Access Control		X
Personal Address Book	X	X
Corporate Address Book		X
CSM Connector	X	X
CBA Connector		X

1.3 Key Benefits of Billing Manager

By combining comprehensive online account management functionality with the world's most scalable and reliable e-billing platform, Billing Manager enables service providers to gain outstanding adoption and ROI typically 5-10 times higher than companies using in-house, customer or competing packaged solutions. Some of the primary benefits Billing Manager enables include:

Business Benefits

Call Center Deflection

By enabling customers to serve themselves online, Billing Manager moves expensive call center interactions (globally these costs translate to \$5-\$10 USD per consumer interaction; \$10-\$30 USD per business customer interaction) to the web site where costs run at less than \$1 USD per interaction.

Reduced Paper, Printing and Postage Costs

In countries where paper turn-off is a legal option, providers are saving enormous printing, post-age, reprint and logistical costs. Even when rules do apply, to guarantee postage revenues, paper may be reduced for reprints services and logistical savings realized.

Streamlined Payment Processing

Online payments are proven to reduce payment time as well as errors associated with them. In addition, it is less expensive for the service provider to process an electronic payment when compared to all the manual handling required to process a paper-based payment. Online payment eliminates lockbox fees, minimizes exception processing, and replaces the costly and time-consuming procedure of processing paper checks.

Case Example	
Total customer base	19,700,000
× Online adoption	12%
× Pct paying	30%
× Savings per payment	\$0.14
× Payments per year	12
= Annual Savings	\$1,191,456

Some recent metrics:

- Adoption: 5%-60%
- Percentage paying: 30%-85%
- Savings per transaction: \$0.11 - \$1.08 USD

Given these numbers, an attractive ROI can be rapidly achieved.

Improved Days Sales Outstanding (DSO)

By making statements easier to access and read, speeding approval cycles and automating disputes, Billing Manager reduces the time it takes for customers to pay their bills. This improves cash flow and reduces DSO.

Increased Customer Satisfaction (Reduce Churn)

By providing the option for 24/7/365 online service, service providers make it more convenient and more satisfying for their customers. Although somewhat more difficult to measure, increased customer satisfaction may ultimately be the most critical differentiator. This is particularly true in the B2B world of electronic invoice presentment and payment (EIPP). As evidenced by an independent AMR Research report, “The ROI exercise that generally launches EIPP projects cites process automation and cash flow as key benefits, but the biggest appeal of electronic billing, as it is used today, is its account management and customer support functionality. In reference to calls we conducted, Siebel users remarked that the main benefit of implementing EIPP is the dramatic improvement in customer service they can provide. In some cases, where the supplier took the extra step of helping customers incorporate EIPP into A/P workflows, satisfaction went through the roof. Reduction in DSO and paper-based billing costs – the quantifiable benefits of EIPP – paled as suppliers basked in the warm glow of happy customers.” In today’s economy of high customer acquisition costs, providing a robust online account management and electronic payment experience is critical to doing business and keeping your existing customers satisfied.

Application Benefits

Billing Manager is a packaged enterprise software application with support, training, and regularly scheduled product enhancements and upgrades. Standard deployments are predictable and deliver “quick wins” for the service provider.

Modularity

Billing Manager may be deployed and additional Self-Service for applications added to the deployment, all using the complementary Siebel platform services.

Open Standards Based

Billing Manager is built on a Java 2 Enterprise Edition (J2EE™) architecture making it highly scalable and flexible. Based on leading Java standards like Enterprise Java Beans™ (EJB™), Java Server Pages™ (JSP™), and Java Servlet application programming interfaces (APIs), users of Billing Manager can leverage all the sophisticated application management tools, enterprise-class performance, scalability, portability, and easy extensibility this environment provides. The Siebel applications presentation layer use struts and tiles standards and may be easily “re-skinned” for branding, internationalization, or customized look and feel.

Proven Scalability

Billing Manager has a linearly scalable architecture that supports millions of complex accounts and thousands of concurrent users. Its flexible data access layer provides for truly massive scalability in a way no competing architecture can claim. In fact, data volumes do not impact the real-time performance of the core Siebel solution at all. This means organizations can retrieve, process, and archive tens of millions of accounts, but only need to scale the application server tier to handle the growing user adoption. These services scale linearly, meaning the platform can easily be extended to accommodate growth in volumes, users, or additional application services. Independent scalability reports from Sun Microsystems and IBM that demonstrate this power can be provided upon request.

Ease of Deployment

The off line authoring components of the Siebel Self-Service Suite visual development environment provide menus and wizards that dramatically reduce the time required to configure and deploy Billing Manager. Simulation capability is built-in allowing developers to test designs prior to deploying an application. Early testing lowers risks and costly late changes. Through the intuitive, easy-to-use graphical development environment, users can analyze the data sources, define the essential data, map the account data to presentation templates, and define business rules for one-to-one marketing and customer service messaging. Designers can create any aspect of account presentation for the Web or other delivery devices.

Unmatched Data Access Flexibility

Siebel provides a flexible Business Services Layer (BSL) that can leverage a wide variety of data sources for account information/Tariff analysis. Extensible APIs provide a full suite of integration services for robust comprehensive functionality. Simply stated, Billing Manager transforms account data for Internet consumption. But Billing Manager is not a simple data translation application: it re-purposes available account data, dynamically retrieving only the information required for the new presentation media.

Simple Integration

Billing Manager preserves investment in and extends capabilities of existing infrastructure through enterprise wide integration. The Siebel design environment allows designers to develop and integrate custom features with existing system processes into the Customer Self-Service solution. Integration of custom functionality or external legacy systems can be accomplished quickly and easily using standard tools and technologies. Siebel Self-Service Architecture and Platform Services APIs are Java-based with XML-interfaces detailed in the Billing Manager Software Developer's Kit (SDK). Integration is straightforward for linking existing enrollment and authentication systems, payment processing, online dispute processes, order management processes, accounts receivable systems, customer service and CRM systems, middleware infrastructure, and third-party operational tools.

Operational Oversight

The Command Center console provides a single production management browser application for the Siebel Self-Service Suite including scheduling of services, statement and account application configuration, customer statement notification configuration, auditing and event logging with general system administration and reporting.

Proven Performance

Billing Manager delivers superior performance without regard to data volumes or user loads.

Multiple Communication Channels

Billing Manager supports a multi-channel deployment paradigm for data delivery via, HTML, XML, IVR, PDF, Email, SMS and devices.

Personalization

Any Billing Manager application view (or the entire template itself) can be replaced or modified based on business logic. By leveraging the account information contained in the data stream, Billing Manager can present highly personalized and dynamic views of a customer's account. Designers define logical expressions based on actual account data that will modify the presentation to the customer. This means that all account data can be used as variables in the dynamic of the rendered account view. The mapping of data elements to logical expressions is encapsulated in an XML file used at run-time.

Architecture Benefits

Reduced Storage Requirements

Competing approaches generally only offer transforming and storing statement data as XML or as normalized rows and columns in a database. The XML tags, which need to be stored as part of the data file, can increase file sizes by 30-40% in most cases. Siebel solution may store data in native file formats, and convert it to delivery formats (including XML) only on-demand. This dramatically reduces storage requirements. Data compression may also be optionally provided to further reduce storage by a ratio of greater than 3:1.

A Tunable Application

Billing information is the corner stone of any Customer Self Service solution, it is the data held within the bill that affects the bottom line of a customer's business or a consumer's likelihood to delay payment or switch providers. Billing Manager manages arriving bill data, processes it for storage, and archives the statement files into an extensible statement repository. A data store of account tables are also maintained in a relational database along with user management information, disputes pertaining to the statement files, and logging and tracking information. This data store may be "dialed down" using a lightweight metadata index to dynamically access statements, or "dialed up" creating a content repository of billing data. Billing Manager offers this option of loading meter detail or account summary information into a content repository for sophisticated customer reporting and analysis. The Billing Manager application and platform is therefore "tunable," providing a flexible approach to managing account-based communications for multi-channel delivery.

Reduced Database Licensing Requirements

Siebel data store generally comprises only 3% of the size of the raw statement data. Competing architectures, on the other hand, require a massive database deployment as the full content of each statement is stored as database rows. Database licensing implications can therefore add a significant cost load to competing solutions.

Enhanced Performance and Memory Management

Siebel utilizes dynamic data extraction and transformation for presentation of statement data. In addition, individual statements are decomposed into "views" such as summary, detail, sub-accounts, etc. Only the view being requested by the user is extracted and transformed. By carefully tuning view size, the developer retains complete control over the application's real time performance profile.

Improved Reliability and Data Quality

Competing architectures require batch data transformation to convert data formats. Any time data transformation occurs, there is a risk of user or system error where data will be "left on the cutting room floor," improperly truncated, or generally mis-mapped. Since transformation occurs in large-scale batch jobs, error recovery is very expensive. In the case of error, all of the errant data needs to be identified and purged from the database, the source data needs to be recreated, transformation rules corrected, and the batch jobs rerun. If the batch cycle is long, the correction may be impossible if several days have passed before the error was detected. Siebel utilizes "dynamic data transformation" whereby data is transformed on the fly by dynamically applying extraction and presentation rules. As such, if an error should occur, the rules can be fixed and re-published on the fly without having to rerun the batch process or drop data.

Reduced Batch Cycle

Siebel batch cycle consists of scanning and indexing arriving batch files. Depending on the file format, the batch process typically runs at 7.5 GB of source data per hour. The process may even be configured to run parallel across server clusters for greater throughput. Competing architectures are simply not able to achieve this load time, leading to consumption of additional system resources and higher stakes for error recovery.

Robust Version Management

Siebel realizes the frequency with which businesses change: new products are introduced, statements are redesigned, and old products are discontinued. As such, Siebel makes extensive use of a template-based architecture and provides robust capabilities for versioning templates. Essentially, rules for transforming and presenting data are versioned by date and stored with the source files they correspond to. As such, if a new service offering or bill format is introduced, a developer need only publish new templates which accommodate the changes and need not worry about affecting historical statements. Competing approaches to changing fixed relational database schemas are far more complicated to manage. These advantages translate in to a lower total cost of ownership, which offers returns every day that the system is in production.

1.4 Siebel Self-Service Suite

The Siebel Self-Service Suite is a set of packaged software solutions that enable service providers to realize the full benefits of customer Self-Service and e-Billing.

The suite includes a rich set of applications and functionality that give providers a complete multi-channel customer-self service capability. The suite includes packaged solutions for:

- e-Billing and Payment
- Service Management
- Reporting and Analytics
- Rate Plan Advice

Siebel solutions are packaged applications with sophisticated out-of-the-box capabilities. They can be tailored to meet specific customer requirements and business concerns, while establishing a solid platform for future business development.

The Siebel Self-Services Suite

Siebel Multi-Channel Customer Self-Service offerings include the following applications:

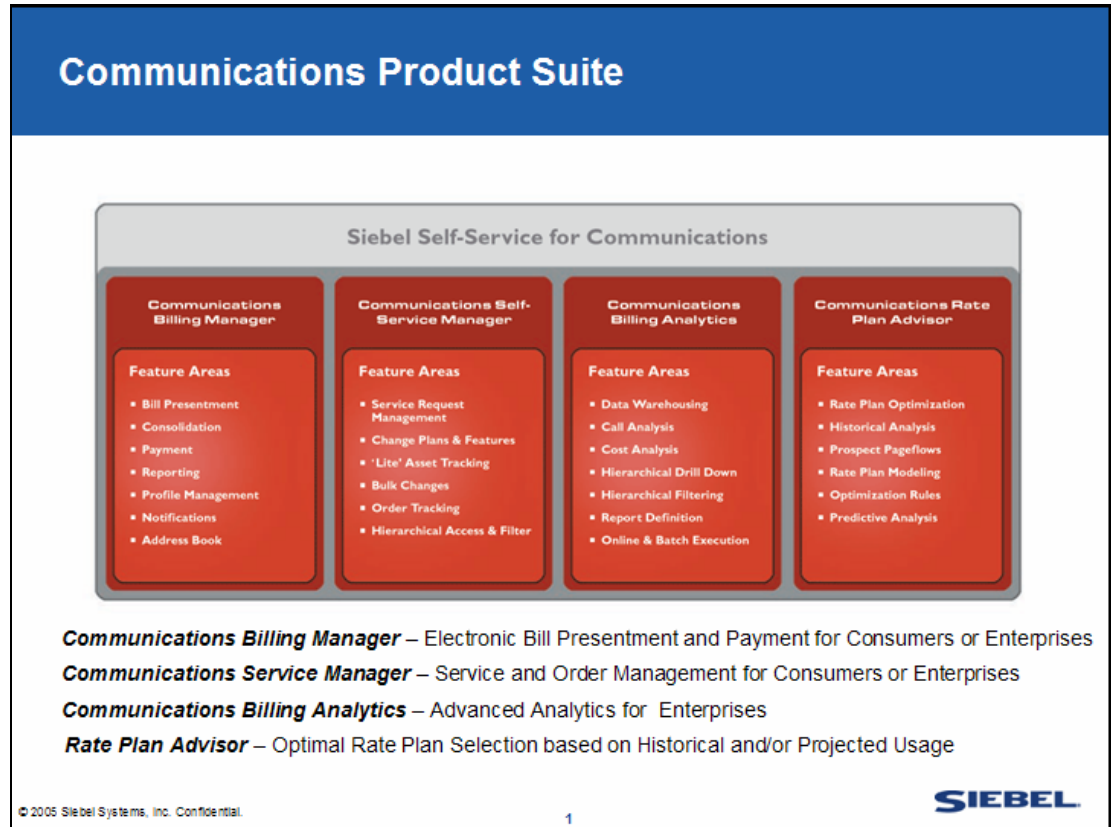

Billing Manager – Business and Consumer Editions

Siebel Billing Manager is a complete e-billing application for service providers that gives business and consumer customers valuable and convenient access to their bills along with the ability to easily make online payments.

Service Manager

Siebel Service Manager enables business and consumer customers of service providers to manage every aspect of their service relationship online. From a single convenient interface, customers can easily activate and manage subscriptions, order new products and services, and report and resolve problems. Business customers are able to complete these activities for individual employees, as well as company departments and divisions, across the entire organization.

Billing Analytics

Billing Analytics is a reporting solution for business customers that empowers both individual employees and business managers to analyze and understand their costs and usage by investigating and identifying trends and patterns across multiple views of their own unique organization.

Rate Plan Advisor

Siebel Rate Plan Advisor is a web-based application that recommends the ideal rate plan for service subscribers in real-time. Individual consumers as well as large businesses can analyze their actual historical voice/mobile/data usage, find the best-fit rate plans, and compare the features offered by those plans. With its intuitive wizard user interface, RPA quickly guides end-customers or customer service representatives through the entire analysis process. In addition, a service provider's customer care and marketing groups can also use RPA to identify pre-churn subscribers, simulate new rate plans, and run predictive analytics.

1.5 Conclusion

Siebel Billing Manager is the proven software platform for scalable, high-performance Self-Service and e-billing applications that enable organizations to manage account relationships with business and consumer customers online. Billing Manager application solutions:

- Reduce support and processing costs
- Improve operational effectiveness
- Increase customer satisfaction
- Enhance marketing effectiveness

Billing Manager's out-of-the-box consumer and business applications for data access, online account composition, analytics, one-to-one messaging, and business hierarchy dramatically decrease time to market for deploying Self-Service solutions. Developed on J2EE technology, the Billing Manager platform is flexible, extensible, and easy to manage, and is the proven platform for online consumer and business applications.

Billing Manager leverages available data from transactional systems to dramatically reduce the costs associated with producing, delivering, and paying account communications, while simultaneously transforming accounts into dynamic, interactive self-service and marketing tools.

Billing Manager goes far beyond bill presentment solutions providing packaged applications with many e-billing features, including online account and statement composition, payment, business logic, one-to-one marketing, hierarchy, customer service access, and service messaging with application management.

Billing Manager's EJB platform architecture has been proven scalable in production and through independent testing. This is a key differentiator in comparing packaged solutions.

Finally, because of Billing Manager's flexibility and methodology, time to market with a Siebel Self-Service Suite solution is extremely rapid, stable, and scalable resulting in a total cost of ownership lower than competing or home grown solutions.

2

Business Processes and Application Logic

2.1 Business Processes and Application Logic

The objective of the B2C application is to provide online account management and customer self service for the provider's consumer customers.

The main features of Billing Manager – Consumer are:

- **Statements** – Consumers can view summary and detailed statements on accounts, devices, and usage.
- **Payments** – Consumers can set up payment accounts for recurring and one-time payments, which historical payment activity for a configurable period of time.
- **User Profile Management** – Users can manage personal profiles and address books, user names and passwords, and notifications.
- **CSR Management** – Siebel's standalone application for CSR management lets customer representatives search accounts and impersonate company users.
- **Analytics** – You create reports with standard account, device and usage reporting functionality. Advanced reporting and report creation is available in a separate application (Siebel Analytics Manager).

Details about individual use cases for the various tasks that users perform as part of these functional areas appear in the next chapter.

2.2 System Context Diagram

The following diagram shows the main Billing Manager application functions in the context of the entire system:

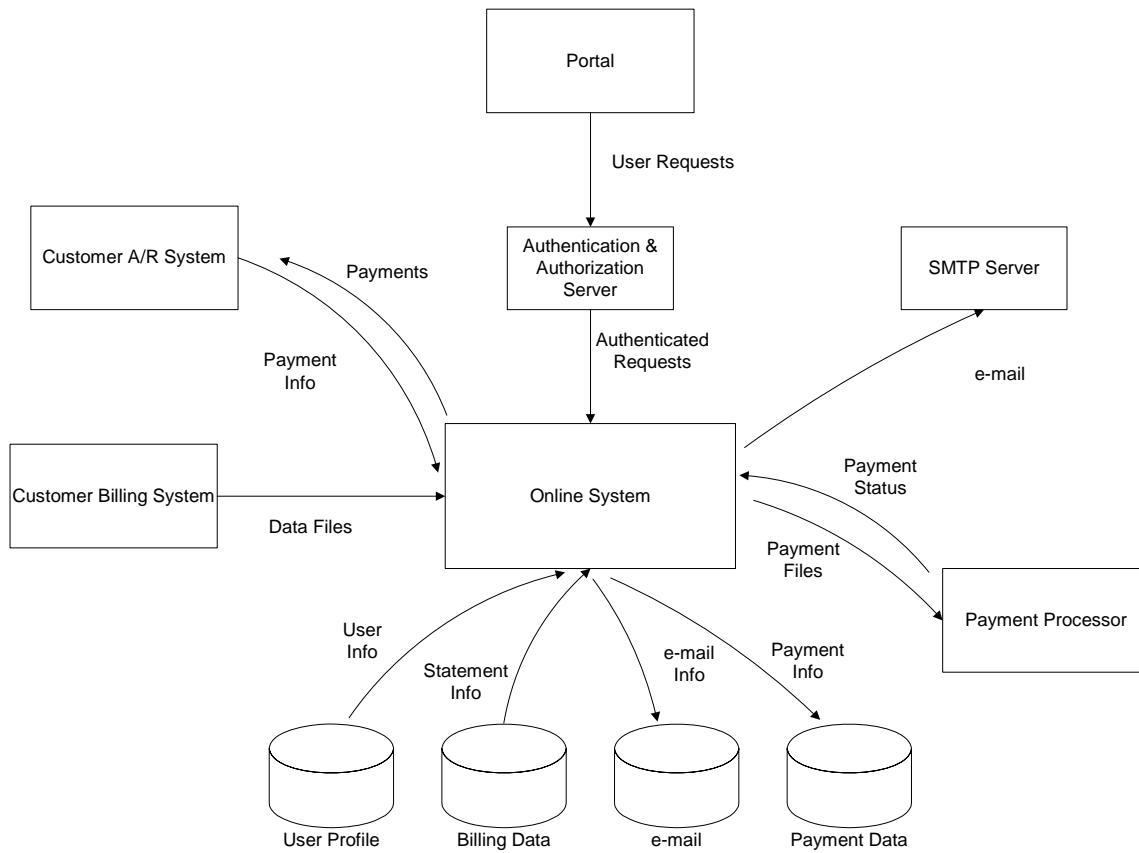

2.3 Navigation Flow Diagram

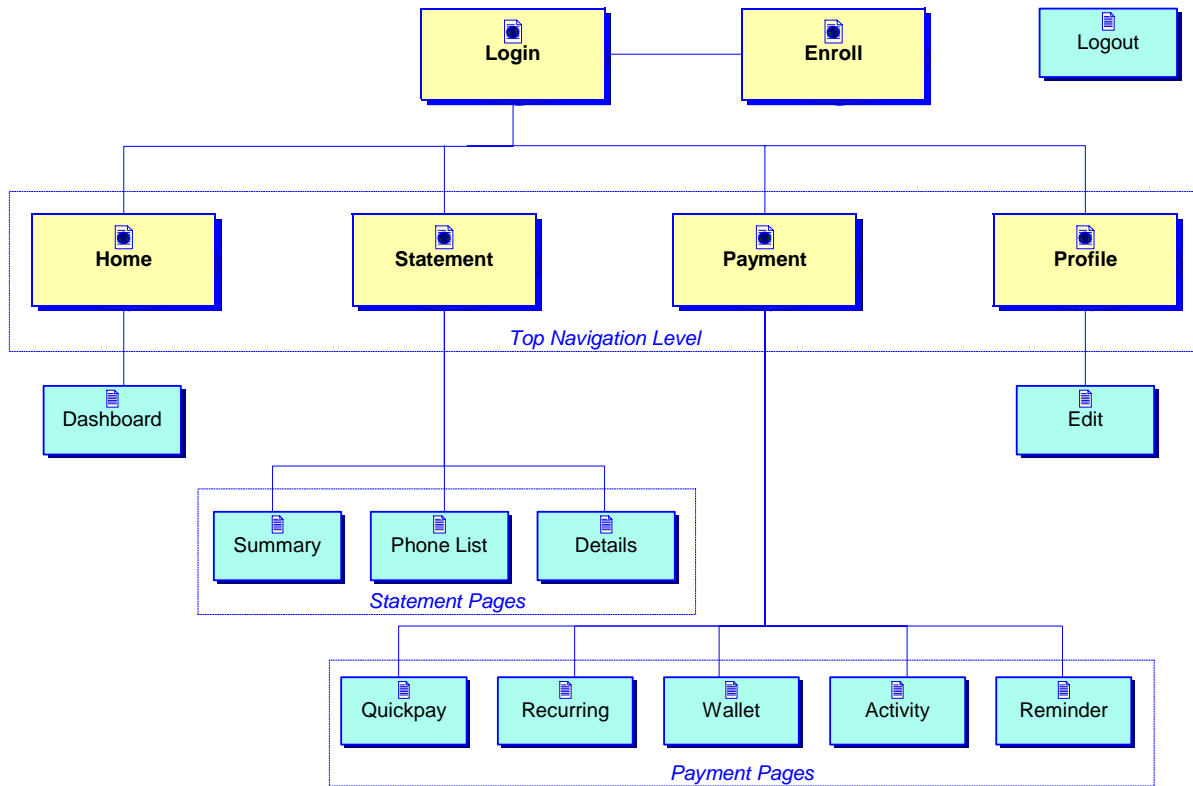

The Billing Manager uses a simple hierarchical navigation. The Navigation Flow diagram, above, shows the top levels of navigation, which are implemented using a horizontal navigation bar with tabs for the top navigation level and sub-tabs for the next level of navigation.

2.4 Menu Navigation Diagram

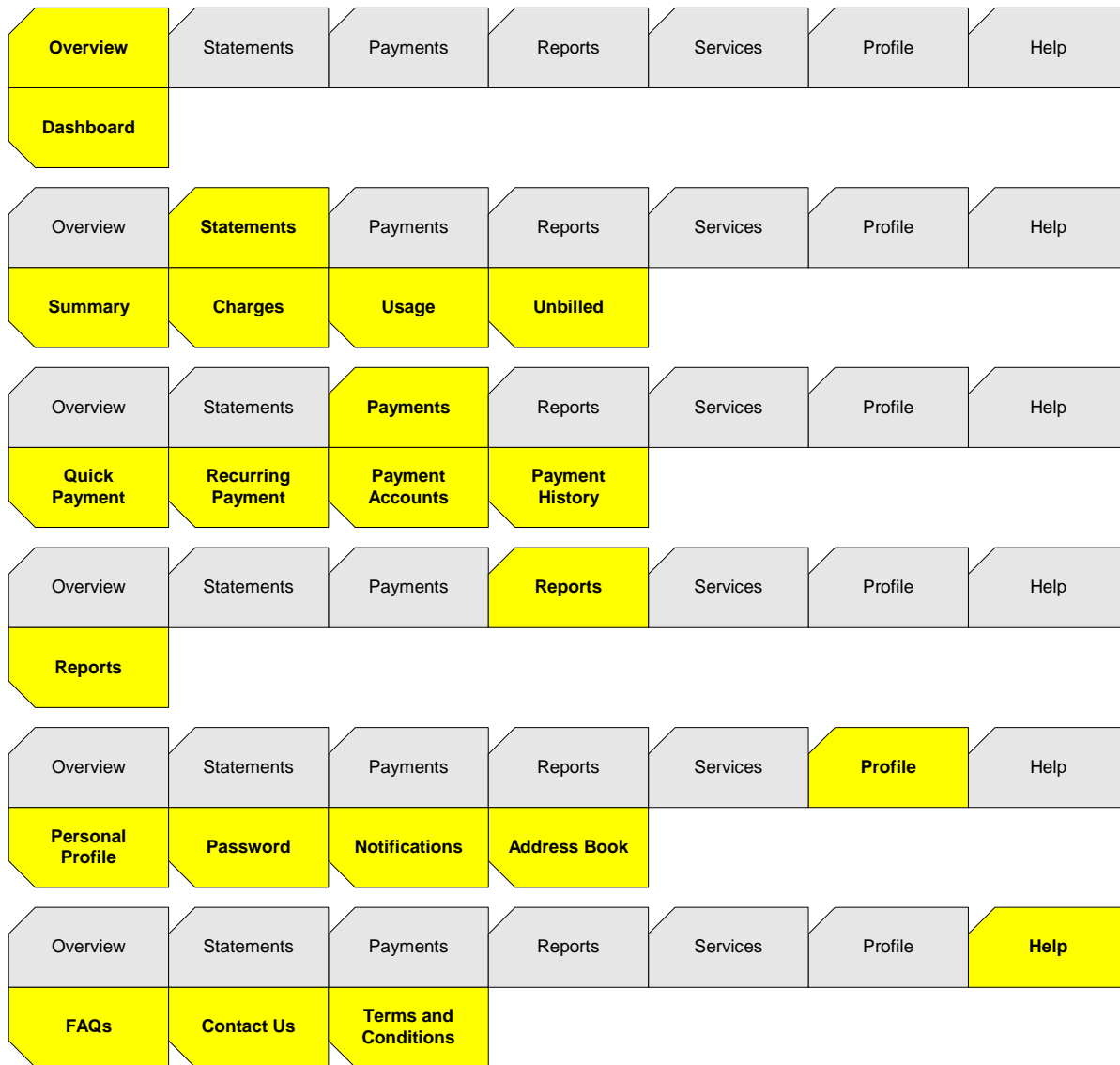

2.5 Billing Manager UI Site Map

The following diagram shows the overall structure of the user interface (UI) for a Billing Manager application:

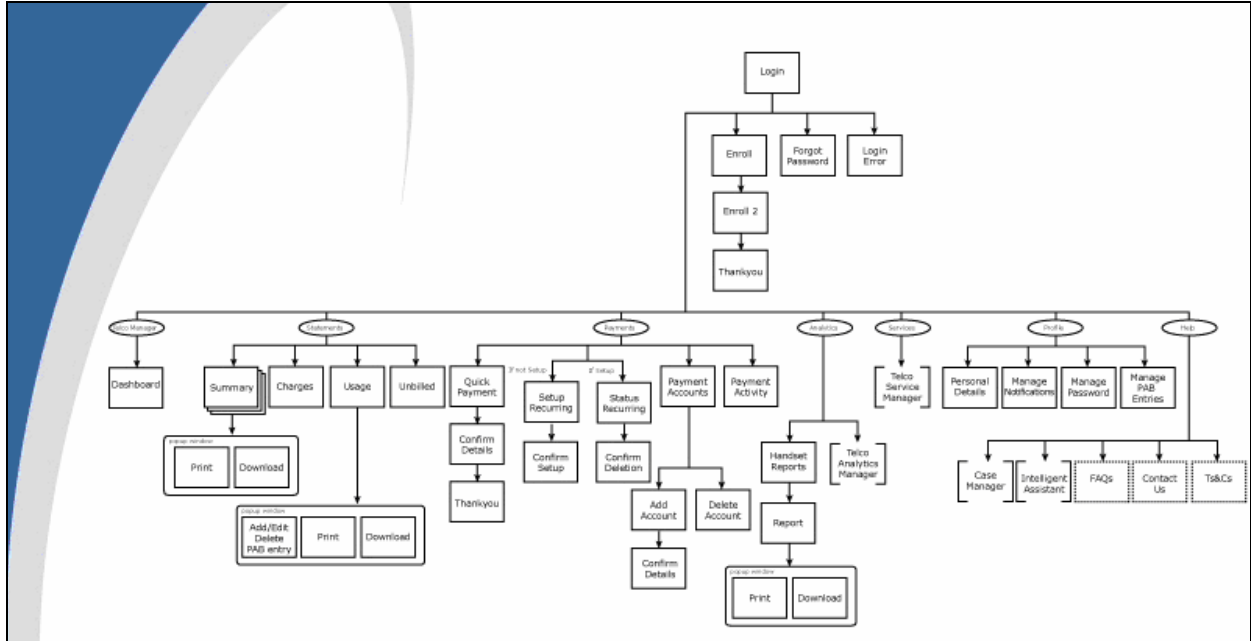

Site Map Legend:

[] Additional parts of Siebel Applications Solution

[] Content provided by the Client Company

2.6 Users

Generally, a few different people use the Billing Manager functionality:

USER	NOTES
Consumer User	A consumer customer that uses the B2C application to manage, view reports, print, edit, add, delete account(s) and telecommunications devices.
CSR Administrator	Internal Customer Service Representative Administrator that has all associated privileges, including managing internal users.
CSR	This user is the company's internal Customer Service Representative that assists the consumer customers with overall account and device management.

3 Site Webflows

3.1 About Site Webflows

The site webflows in this chapter describe the essential interaction between the user and the system. The system is based on Billing Manager and a customizable set of screens. The User Interface (UI) consists of a set of screens and navigation elements with interfaces (APIs) to Billing Manager platform functions, which provide access to statement and payment information. The user presentation is driven by a set of HTML templates (Tiles). The navigation and control is driven through a standard Java framework (Struts).

Each use case specifies a set of activities performed by a user, or other type of actor, to complete a task. Use cases describe the flow of contingent actions the user takes.

There may be many possible paths through a site webflow:

- **The Main Path** – This describes the successful completion of the use case without encountering any exceptional conditions.
- **Alternate Paths** – These describe one or more related paths through the use case (for example, add, edit and delete) that are considered not part of the common flow of the use-case.

A use case may also interact with external systems, which are systems that are outside the boundary of the Billing Manager implementation.

3.2 Catalog of Application Logic

This diagram shows how the use cases relate and tie back to the overall application logic and navigation.

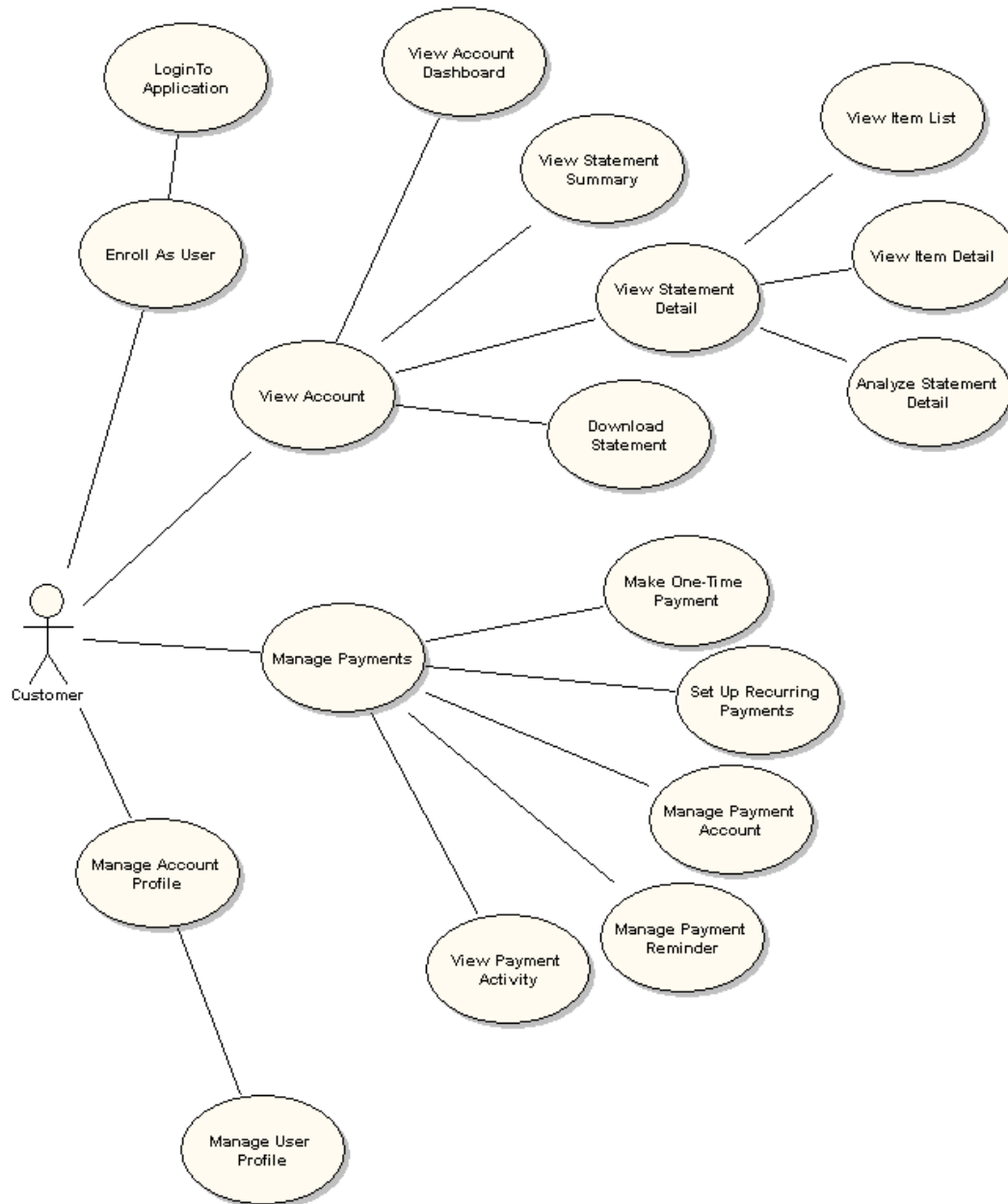

3.3 Functionality Overview

The following table provides a complete list of the web flows that specify the functionality and site navigation of the application:

REQUIREMENT CATEGORY	DESCRIPTION	USE CASES
General User Interface	General interface features used in the application.	Multiple DDN Change Language
Enrollment & Authentication	Enroll users and manage the login user session. The <i>Log In To Application</i> use cases is a pre-condition for all customer use cases.	Log In To Application Log Out Of Application Enroll As User Forgot Password
Statement Presentment	Functions related to presenting and accessing the customer's statements.	View Dashboard View Statement Summary View Device Charges View Usage Details for Device View Unbilled Activity for Device Print Current View Print Invoice Download Account Data
Payment	Handle user payments.	Quick Payment Setup Recurring Payment Manage Payment Accounts View Payment History
Analytics	Summarize data in a variety of reports.	View Device Reports Download Report
Profile Management	Manage user account and profile information. Send e-mail notifications as appropriate to customer.	Manage Personal Profile Manage Password Manage Notifications Manage Personal Address Book (PAB)
Customer Service	Customer Service Application that enables critical account management access and capabilities to customer service representatives.	Manage Internal Users Add Internal Users Edit Internal User Profile Search for Account

Site Webflows

REQUIREMENT CATEGORY	DESCRIPTION	USE CASES
		Search for User Impersonate User
System	Tasks required to administer the application.	Self-Enrollment Secure Access Framework (SAF) Roles Management Process Recurring Payments Email Notifications

3.4 Enrollment and Authentication Use Cases

The enrollment and authentication use cases cover the business requirements for allowing customers to access the system.

This section describes the following use cases that allow consumers to:

- **Login to Application** – Access the system as an authenticated user.
- **Logout of Application** – End user session.
- **Enroll as User** – Provide user profile information and user credentials.
- **Forgot Password** – Lets user reset their password.

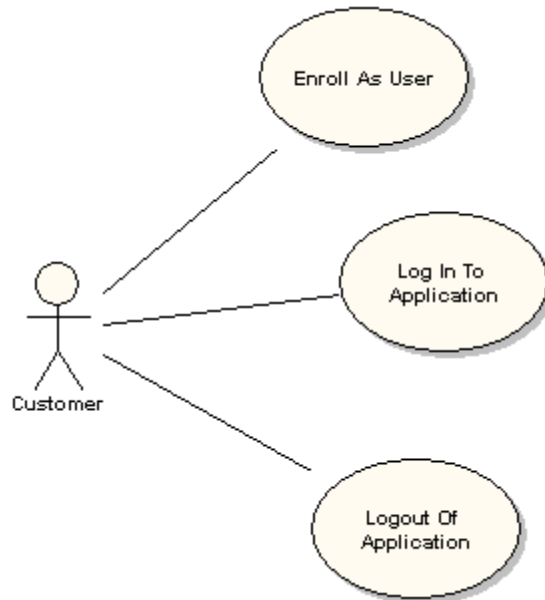

Login to Application

Name:	Login To Application
Brief Description:	Consumer user logs in to the application.
Primary Actor:	Consumer user
Trigger:	User navigates to the login page
Main Path:	<ol style="list-style-type: none"> 1. This use case begins when a user navigates to the login page. 2. System displays Login page displaying a form for entering user name and password.

	<ol style="list-style-type: none"> 3. User enters login information. 4. User submits data. 5. System validates data. 6. System displays the Account Dashboard page. 7. Use case ends.
Alternate Paths:	<p>[A1] System determines that customer credentials are invalid:</p> <ol style="list-style-type: none"> 1. System displays a message “Login incorrect: Please try again” <p>[A2] User selects forgot password</p> <ol style="list-style-type: none"> 1. Forgot Password use case initiated <p>[A3] User selects Enroll Now User</p> <ol style="list-style-type: none"> 1. System invokes Enroll As User use case
Standard Features:	<ol style="list-style-type: none"> 1. Authentication of User Name and Password 2. Forgot Password link 3. Enroll Now link
Configuration Points:	<ol style="list-style-type: none"> 1. Messaging instructions around the login form. 2. CBM ships with a default enrollment and authentication model for user management. This framework for user management may be configured via a plug-in to use available systems for authentication and other user information. 3. The system can be configured to force users to change their password at first login. 4. Additional fields can be added to the profile management page based on client requirements.
Notes:	<p>Default implementation stores the enrollment information within the billing manager application.</p>

Login
Please use the login area to login to your account.

Login to your Account

User Name:

Password:

[Forgot your password? Click Here.](#)

if you are a new user, [Enroll Now](#)

SIEBEL

Log Out of Application

Name:	Log Out of Application
Brief Description:	Consumer user logs out.
Primary Actor:	Consumer user
Trigger:	User invokes the logout operation from the navigation menu
Main Path:	<ol style="list-style-type: none"> 1. This use case begins when the user invokes the logout operation from the navigation menu. 2. System ends the user's session 3. System displays a logout message and prompts the user to login to the application.
Alternate Paths:	<p>[A1] User is inactive on the site for 15 minutes</p> <ol style="list-style-type: none"> 1. System ends session
Standard Features:	<ol style="list-style-type: none"> 1. Session timeout. 2. Customer logs out 3. Login Again link
Configuration Points:	<ol style="list-style-type: none"> 1. Timeout period is configurable.

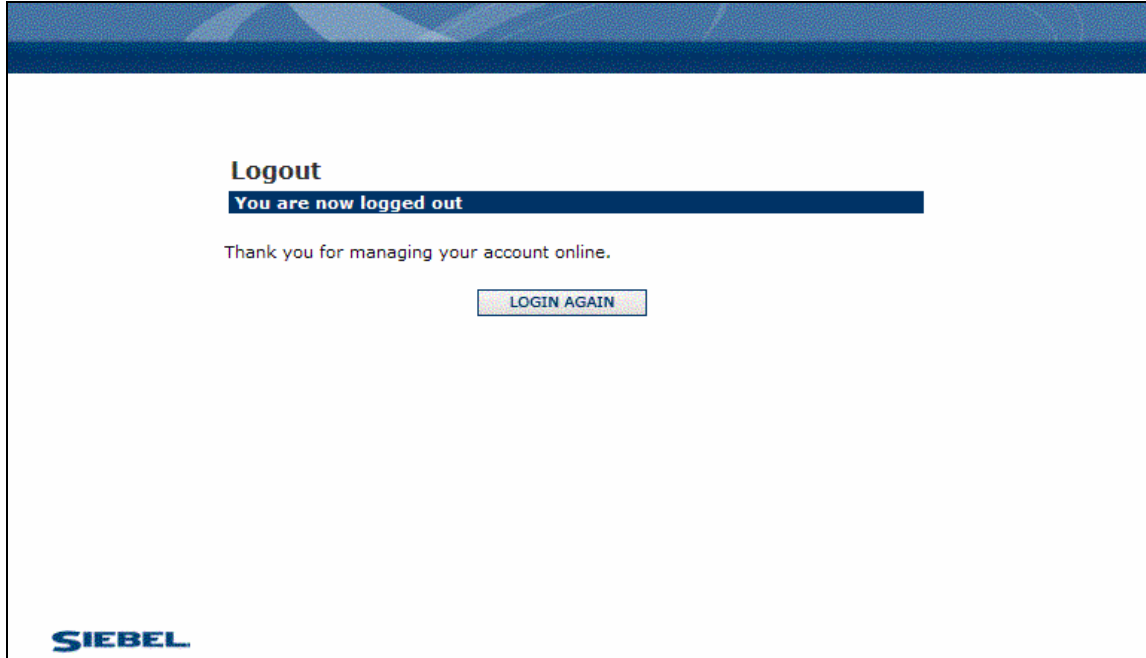

Enroll as User

Name:	Enroll As User
Brief Description:	Consumer user enrolls for online account access.
Primary Actor:	Consumer user
Trigger:	User clicks on the Enroll Now link in login page
Main Path:	<ol style="list-style-type: none"> 1. This use case begins when a User invokes the Enroll Now operation. 2. System displays enrollment screen requesting user to provide the following information: <ol style="list-style-type: none"> a). User ID b). First Name c). Middle Initials (optional) d). Last Name e). Account f). Validation Code (optional) g). Date of Birth (optional) h). Email ID i). Street address j). City k). State/province (optional if country NOT US or Canada) l). Zip or postal code

	<ul style="list-style-type: none"> m). Country n). Home Telephone (optional) o). Business Telephone (optional) p). Security Question (optional) q). Security Answer (optional) r). Password s). Re-type Password <ol style="list-style-type: none"> 3. User provides enrollment information. 4. User submits form data. 5. System validates the enrollment information via a Validation Code field from the billing data. 6. System displays an enrollment confirmation. 7. System Generates an enrollment welcome email to the email address on record.
<p>Alternate Paths:</p>	<p>[A1] Username already exists.</p> <ol style="list-style-type: none"> 1. System displays a message informing the User that the selected Username already exists. <p>[A2] Invalid entry</p> <ol style="list-style-type: none"> 1. System displays message informing the user of the problem and allows them to correct it. <p>[A3] User does not provide required information</p> <ol style="list-style-type: none"> 1. System displays a user-friendly error message. <p>[A4] Email Confirmation</p> <ol style="list-style-type: none"> 1. After validating the enrollment is correct, the system sends an email to the user who was just enrolled. <p>[A5] System cannot complete enrollment:</p> <ol style="list-style-type: none"> 1. System displays a user friendly error message.
<p>Standard Features:</p>	<ol style="list-style-type: none"> 1. Form validation of enrollment fields 2. Password confirmation 3. Required fields
<p>Configuration Points:</p>	<ol style="list-style-type: none"> 1. The system can be configured to force a user to change their password at first login. 2. Additional fields can be added to the profile management page based on client requirements. <ul style="list-style-type: none"> a). Password confirmation b). Required fields c). Form validation of enrollment fields d). Additional enrollment fields e). Field validation f). Secret question options <p>e-Billing Manager ships with a default enrollment and authentication model</p>

	for user management. This framework for user management may be configured via a plug-in to use available systems for authentication and other user information.
Notes:	<ol style="list-style-type: none"> 1. Default implementation stores the enrollment information within the billing manager application. 2. Sample validation and error message screen shots provided.

Enroll
If you are a new user, please enroll

Complete the following form and click Enroll Now.

*** required fields**

* User ID

* First Name

Middle Initial

* Last Name

* Account

Validation Code

Date of Birth / / (mm/dd/yyyy)

* Email ID

* Street Address

* City

State

* Zip Code

* Country

Home Telephone (eg: 508-616-8747)

Business Telephone (eg: 508-616-8747)

Security Question

Security Answer

* Password

* Re-type Password

ENROLL NOW

Forgot Password

Name:	Forget Password
Brief Description:	Consumer user forgets password and systems presents a password reminder.
Primary Actor:	Consumer user
Trigger:	User selects Forgot Password link in login page
Main Path:	<ol style="list-style-type: none"> 1. This use case begins when a User has forgotten their password and selects "Forgot Password" functionality. 2. System displays a page requesting the user to enter their username. 3. User provides username and submits. 4. System confirms the username exists. 5. System displays page requesting the user to answer the secret question associated with the username. 6. User answers the secret question and submits 7. System validates the secret question answer to be correct and displays Password Reset page containing: <ol style="list-style-type: none"> a). New password b). New password confirmation 8. User provides new password and submits 9. System records new password and logs user in.
Alternate Paths:	<p>[A1] Username does not exist</p> <ol style="list-style-type: none"> 1. System displays error message stating the username is not correct. <p>[A2] System is unable to validate the secret question</p> <ol style="list-style-type: none"> 1. System displays error message stating the username is not correct. 2. System displays error message stating "This is not the answer we have on file, please try again" 3. User is given a system defined number of times to answer correctly
Standard Features:	<ol style="list-style-type: none"> 1. User Name with secret question is standard. 2. Form validation 3. Cancel action
Configuration Points:	It is expected that authentication and validation may be provided via plug-in to external systems. Fields used in this scenario are configurable based on security guidelines of the client.

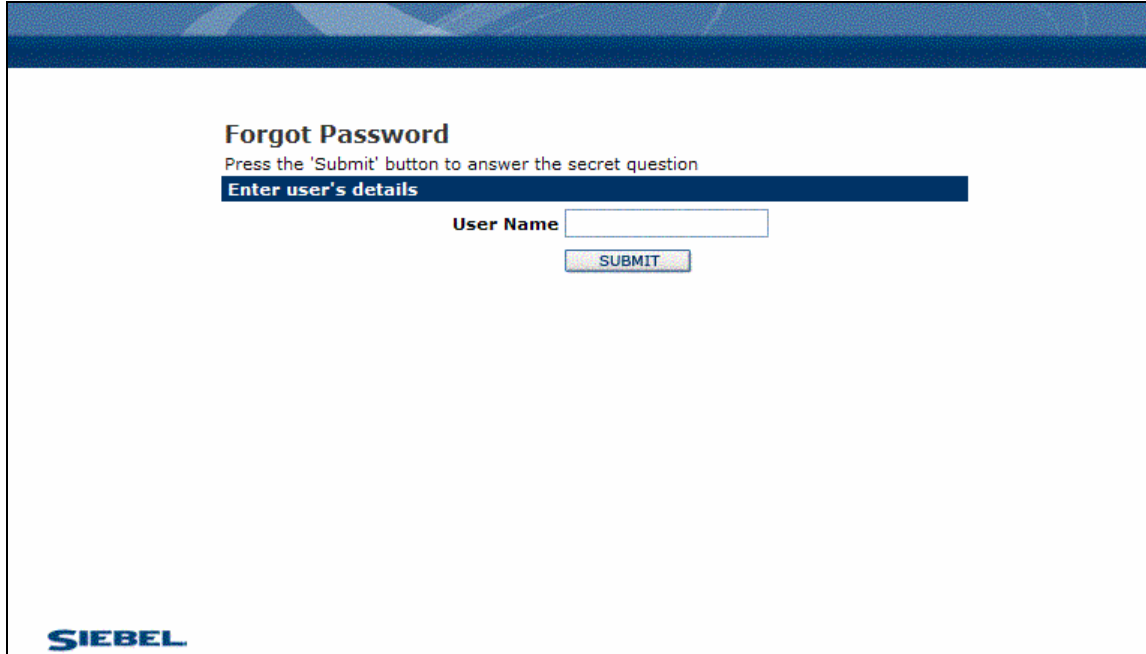

3.5 General User Interface

Some functions appear on many pages throughout the Billing Manager application.

The following use cases detail common functionality applied to one or more pages:

- Multiple DDN (1110)
- Change Language (1111)

Multiple DDN (1110)

Name:	Multiple DDN support
Brief Description:	<p>This generalized use case describes how a Self-Service implementation can utilize billing data that comes from different file feeds of different format. By enhancing the capability for any UI screen to reference an abstract DDN which is translated into a realized DDN based on some lookup specific to the client implementation, a single view can be used to display similar data from different feeds (different billing systems) or even to display different data from different feeds (e.g. wireline vs. wireless).</p> <p>Any screen that utilizes a DDN is impacted by this new approach to referencing DDNs. The following screens can utilize this new functionality to pull data from different files with different formats.</p> <ol style="list-style-type: none"> i. All Statement Screens ii. All Report Screens iii. One-Time Payment Screens <p>If more than one account is listed on this screen, multiple DDN</p>

	<p>functionality can be used to pull the amount due for each account from different files with different formats and DDNs.</p> <p>iv. Payment Jobs</p> <p>All the payment jobs that need to access accounts' due dates and amounts due have the ability to reference an abstract DDN which is translated into a realized DDN.</p>
Actor:	System
Main Path:	<p>There are two mutually exclusive techniques that can be implemented by a service provider to utilize multiple DDN functionality. The main path describes Account Level Stream Mapping and [A1] describes the other Customer Level technique.</p> <p>Account Level Stream Mapping is used for customers with several data streams; each formatted differently, each from a different billing system. In this case a customer specific algorithm determines the data stream that contains a particular account. The algorithm is usually either:</p> <ol style="list-style-type: none"> 1. A database lookup from account number to stream indicator, or 2. An algorithm that parses an account number to find the appropriate stream. (e.g. any account starting with "xyz" utilizes the wireline summary DDN)
Alternate Paths:	<p>[A1] Customer Level Stream Mapping</p> <p>In some cases, all the accounts associated with a particular customer will be contained in a single bill stream. In this case, some customer specific algorithm determines the data stream associated with all the accounts for that particular customer. The algorithm is usually based upon:</p> <ol style="list-style-type: none"> a). A database lookup, or b). Geographic data (like zip code) <p>[A2] Default DDN</p> <p>If the database lookup or parsing algorithm does not identify a specific DDN, the default DDN for the implementation is used.</p> <p>[A3] User Accessing Multiple Accounts</p> <p>If the UI is structured so that an individual user can select from multiple accounts, than each account selected could reference a different DDN.</p>
Exception Path:	None
Standard Features:	None
Configuration Points:	None

Business Rules:	CBM should provide a mechanism to map an account to a DDN through either lookup or algorithm.
Notes:	In order to both test and demonstrate this functionality, the foundation application data source should be updated to have multiple DDN. Configure multiple DDNs in the Command Center and the config file to use either account level or customer level mapping.

Change Language (1111)

Name:	Change Language
Brief Description:	CBM application with internationalization support
Actor:	User
Pre-Condition:	It is required that the server as well as the client browser supports the language.
Main Path:	<ol style="list-style-type: none"> 1. The application allows the user to select the user's language preferences using the following options: <ol style="list-style-type: none"> a. User selects to change language through the application. b. Use language or locale preferences available in the web browser. [A1] 2. User selects change language hyperlink. 3. System displays a pop-up box with the list of supported languages in a dropdown. 4. User selects their preference from the list of supported languages and submits. 5. System refreshes and displays the application in the selected language. 6. The subsequent pages of the application will be displayed in the language until the user logs out. 7. Use case ends.
Alternate Paths:	<p>[A1] Default to browser Setting</p> <ol style="list-style-type: none"> 1. When a user logs into the Self-Service application, the language preference set in the user's browser dictates which language the application displays. 2. Browsers let the user create a list of languages as part of their preferences. 3. User selects their preferences from the supported language or locale preferences available in the web browser. 4. If the language set in the browser is not supported in the Self-Service application, the Self-Service default language is used (default to us_EN (US English)).

Exception Path:	None
Standard Features:	None
Configuration Points:	None
Business Rules:	Based on the user language preference, application looks up for the resource bundle with key/value pairs
Notes:	Internationalization support and changes applies to all the use cases listed in CBM 4.5.3 RTM and PRD.

User is presented with a page in English:

Login - en
Please use the login area to login to your account. - en

Login to your Account - en

User Name - en:

Password - en:

[Forgot your password? Click Here. - en](#)

if you are a new user, - en [Enroll Now - en](#)

Equivalent page in Spanish:

Login - es
Please use the login area to login to your account. - es

Login to your Account - es

User Name - es:

Password - es:

[Forgot your password? Click Here. - es](#)

if you are a new user, - es [Enroll Now - es](#)

Window allowing user to choose a language:

Select your lanugage - en

Language - en

English
French
Spanish

Click here to close this window - en

3.5 Statement Presentment Use Cases

The statement presentment features lets users to view their account summary and detail information, including:

- **View Dashboard** – Consumer User views the dashboard containing a high-level account overview.
- **View Statement Summary** – Consumer User views the summary of a statement.
- **View Charges for Device** – User views summary charges for a device.
- **View Usage Details** – User views the detail associated with a single device.
- **View Unbilled Activity for Device** – User views activity that has been generated since their most recent billing statement.
- **Print Current View** - User prints the current view.
- **Print Invoice** - User downloads the PDF of the selected bill.
- **Download Account Data** - User downloads account data.

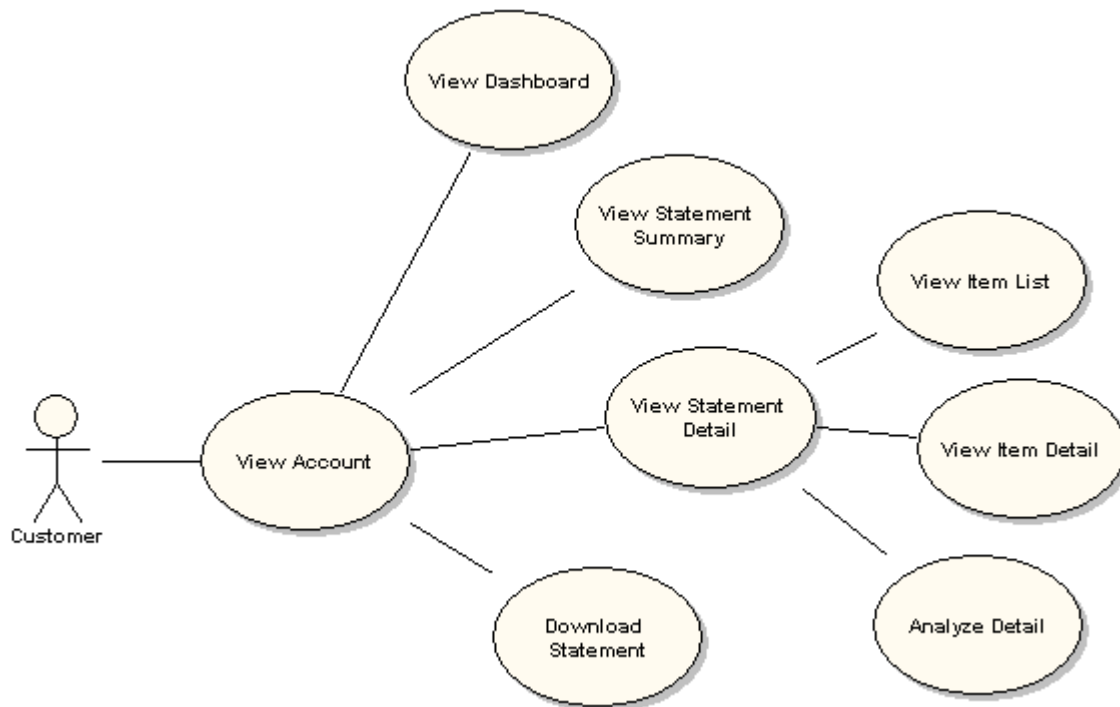

View Dashboard

Name:	View Dashboard
Brief Description:	Consumer user views the dashboard containing a high-level account overview.
Primary Actor:	Consumer user
Trigger:	<ol style="list-style-type: none"> 1. This is the landing page displayed to the user after logging in 2. This screen is displayed when the user selects the "Overview" menu selection
Main Path:	<ol style="list-style-type: none"> 1. This use case begins when the User invokes the dashboard operation. 2. System displays the Dashboard Screen including an overview and summary of account information. 3. The user selects to view the statement. 4. System displays the Statement Summary screen for the most recent statement date. 5. The user can select to look at any of the displayed items on the account overview page of the dashboard.
Alternate Paths:	<p>[A1] User selects to view Payments.</p> <ol style="list-style-type: none"> 1. System displays the Payment History page for the most recent payment activity. <p>[A2] User selects to view Analytics.</p> <ol style="list-style-type: none"> 1. System displays the list of available reports to the user <p>[A3] User can also select any of the available tabs.</p> <p>[A4] User selects the Edit Profile operation</p> <ol style="list-style-type: none"> 1. System displays the Personal Profile page.
Standard Features:	<ol style="list-style-type: none"> 1. The following components are dashboard modules for Billing Manager: <ol style="list-style-type: none"> a). Account Information Summary b). Payment Information Summary c). User Profile d). User Reports Summary
Configuration Points:	<ol style="list-style-type: none"> 1. Graph format is a configurable parameter. 2. Account number may be displayed on dashboard user bar. 3. Additional edocs' products may be integrated and presented on the dashboard.
Notes:	Payment is optional and not all deployments require it, however the training sample included with the product does demonstrate its use.

Dashboard
 User: Hillary Bremer Account: 80011008

Account Overview [View Statement](#)

Statement Breakdown

Summary device charges 05/04/04

Monthly Service Charges	49.98
Usage Charges	1.29
Other Charges	0.10
Taxes	4.46
Total Current Charges	55.83

Payment due by 06/26/04

Payments [View Payments](#)

Last 2 bill totals

Payment by ACH payment at lockbox posted on May 28, 2004

Previous Balance	57.24
Payment Posted	-57.24
Adjustments	0.00
Past Due Balance Payable Immediately	0.00

Analytics [View Analytics](#)

Minutes Breakdown

Weekdays	584
Weeknights and Weekends	174
Mobile to Mobile	55
Total Minutes	813

View Statement Summary

Name:	View Statement Summary
Brief Description:	Consumer user views the summary of an account.
Primary Actor:	Consumer user
Trigger:	This screen is displayed when the User selects 'Statement' menu
Main Path:	<ol style="list-style-type: none"> 1. This use case begins when the User views the Statement Summary and invokes the View Statement operation. 2. System displays Statement Summary Screen with summary information for the most recent statement.
Alternate Paths:	<p>[A1] User selects an alternate billing date.</p> <ol style="list-style-type: none"> 1. System displays the Statement Summary page for the selected

	<p>billing date.</p> <p>[A2] User selects to view Analytics.</p> <ol style="list-style-type: none"> 1. System displays the list of available reports to the user <p>[A3] User selects the Edit Profile operation</p> <ol style="list-style-type: none"> 1. System displays the Personal Profile page.
Standard Features:	<ol style="list-style-type: none"> 1. Print Invoice (PDF) 2. Download Statement (PDF, CSV, XML)
Configuration Points:	<ol style="list-style-type: none"> 1. The format of the statement will be configurable based on the client's billing format.
Notes:	<p>Service consolidation is configurable using multiple data sources, but is not currently demonstrated by the foundation application sample data set.</p>

[Overview](#)
[Statements](#)
[Payments](#)
[Analytics](#)
[Profile](#)
[Services](#)
[Help](#)

Account Summary

[Device Summary](#)
[Device Usage](#)
[Unbilled Activity](#)

Download: PDF

Acct Summary

User: Hillary Bremer Account: 80011008

Account Summary		Profile				
Please Select Statement Date: 05/04/04 <input type="button" value="SUBMIT"/>		User: Hillary Bremer				
		Email: hillary@CellTec.com				
		Address: 293 Turnpike Rd, Westborough				
Statement summary costs		Analytics				
Monthly Service Charges	49.98	View Minutes Breakdown 				
Usage Charges	1.29					
Other Charges	0.10					
Taxes	4.46					
Total Current Charges	55.83					
Previous payments		Weekdays 584				
Previous Balance	57.24	Weeknights and Weekends 174				
Payment by ACH payment at lockbox posted on May 28, 2004	-57.24	Mobile to Mobile 55				
Total Balance	\$0.00	Total Minutes 813				
Summary device charges						
Wireless Number	Monthly Service	Usage	Adjustments	Taxes	Other	Total
407-113-5451	9.99	0.00	1.73	0.97	0.00	12.69
407-062-0806	39.99	1.29	-1.63	3.49	0.00	43.14
Total	49.98	1.29	0.10	4.46	0.00	55.83

View Charges for Device

Name:	View Charges for Device
Brief Description:	Consumer user views summary charges for a device.
Primary Actor:	Consumer user
Trigger:	This screen is displayed when the User selects 'Statement\Charges' menu
Main Path:	<ol style="list-style-type: none"> 1. This use case begins when the User navigates to the charges menu. 2. System displays charges data for a specific device number.
Alternate Paths:	<p>[A1] User selects to view device specific charges.</p> <ol style="list-style-type: none"> 1. System invokes View Device Usage Details use case. <p>[A2] User selects an alternate billing date.</p> <ol style="list-style-type: none"> 1. System redisplay the Device Charges page for the selected billing date. <p>[A3] User has more than one device and chooses to view another device.</p> <ol style="list-style-type: none"> 1. System redisplay the Charges page for the selected device.
Standard Features:	<ol style="list-style-type: none"> 1. Print Friendly 2. Download Statement(PDF, CSV, XML)
Configuration Points:	<ol style="list-style-type: none"> 1. The format of the Device Charges will be configurable based on the client's billing format.
Notes:	<p><i>Customer Customization option:</i> If Dispute capability is deployed, this screen changes to provide a Dispute selection option that enables checkbox selection for individual device charges.</p> <p>Device Summary as a heading should be configurable</p>

Download: PDF

Device Summary

User: Hillary Bremer Account: 80011008

Account Summary | **Device Summary** | Device Usage | Unbilled Activity

Charges for Device Number

Number: 407-113-5451 Statement Date: 05/04/04

Summary for 407-113-5451

Total Charges For: 407-113-5451 \$12.69

Rate Plan

	Period	Prorated Charge	Monthly Charge	Total Charge
Basic Plan	05/04-06/03		9.99	9.99

Includes:
 CALL FORWARDING N/C
 CALL HOLD
 CALL WAITING N/C
 CALLER ID N/C
 CLID PER CALL BLOCK
 THREE PARTY CALL N/C

Usage Charge Details

Total Usage Charges \$0.00

Optional Services

	Period	Prorated Charge	Monthly Charge	Total Charge
VOICE MAIL ALERT	05/04-06/03		0.00	0.00
NATIONWIDE TOLL FREE	05/04-06/03		0.00	0.00
LONG DISTANCE ACCESS	05/04-06/03		0.00	0.00
NETWORK ACCESS	05/04-06/03		0.00	0.00
OFF-NETWORK ROAM	05/04-06/03		0.00	0.00
WIRELESS VOICEMAIL - BASIC N/C	05/04-06/03		0.00	0.00

Credits, Adjustments & Other Charges

FED UNIVERSAL SVC CHARGE				0.26
911 MONTHLY				0.80
REGULATORY COST RECOVERY FEE				0.56
TELCOM RELAY SERVICE SURCHARGE				0.11
Total Other Charges				\$1.73

Taxes

FEDERAL EXCISE TAX				0.33
STATE TELECOM SALES TAX				0.64
Total Taxes				\$0.97

Profile [edit](#)

User: Hillary Bremer
 Email: hillary@CellTec.com
 Address: 293 Turnpike Rd, Westborough

Analytics [View](#)

Minutes Breakdown

Weekdays	584
Weeknights and Weekends	174
Mobile to Mobile	55
Total Minutes	813



View Usage Details

Name:	View Usage Details
Brief Description:	Consumer user views the usage detail associated with a single device.
Primary Actor:	Consumer user
Trigger:	This screen is displayed when the user selects 'Statement \ Usage Details' menu option.
Main Path:	<ol style="list-style-type: none"> 1. This use case begins when the user selects the view call detail operation for a specific account. 2. System displays the Statement Detail information for the selected account and call detail category.
Alternate Paths:	<p>[A1] Customer selects an alternate billing date.</p> <ol style="list-style-type: none"> 1. System displays the Statement Detail page for the selected billing date. <p>[A2] User has access to more than one device and chooses to view another device.</p> <ol style="list-style-type: none"> 1. System redisplay the Usage Details page for the selected device. <p>[A3] Manage PAB entry</p> <p>User manages contact information for a specific device number.</p> <ol style="list-style-type: none"> 1. User clicks on the alias name or phone number displayed. 2. System displays an entry form that is pre-populated with the existing PAB entry. 3. User edits the information and selects update action. 4. System stores the new entry and displays the updated list.
Standard Features:	<ol style="list-style-type: none"> 1. Download (PDF, CSV, XML) 2. Paging/Sorting 3. Personal Address Book 4. Printer Friendly
Configuration Points:	<ol style="list-style-type: none"> 1. The number, type, and ordering of call detail columns. 2. Initial sort order for each column (ascending or descending). 3. Graph type
Notes:	If Dispute capability is deployed, this screen changes to provide a Dispute selection option that enables checkbox selection for individual line item detail charges.

Download: PDF

Device Usage

User: Hillary Bremer Account: 80011008

Charges for Device Number

Number: 407-113-5451 Statement Date: 05/04/04

[Address Book Off](#)

1 | 2 | 3

Details for 407-113-5451

Date, Time	Number Called	Rate Period	Min	Total Charge
05/04, 11:42AM	704-576-7051	Weekdays	9	0.00
05/05, 02:06PM	704-921-4700	Weekdays	7	0.00
05/05, 02:13PM	704-921-4700	Weekdays	8	0.00
05/05, 05:45PM	314-878-3501	Weekdays	13	0.00
05/05, 07:25PM	704-843-0847	Weekdays	3	0.00
05/07, 03:28PM	704-921-4700	Weekdays	12	0.00
05/07, 04:33PM	704-921-4700	Weekdays	2	0.00
05/08, 09:47AM	704-847-3211	Weeknights and Weekends	1	0.00
05/09, 06:01PM	314-878-3501	Weeknights and Weekends	18	0.00
05/09, 08:44PM	405-478-5957	Weeknights and Weekends	9	0.00
05/10, 04:34PM	704-921-4700	Weekdays	2	0.00
05/10, 04:38PM	704-921-4700	Weekdays	2	0.00
05/10, 06:31PM	407-062-0806	Weekdays	1	0.00
05/12, 12:02PM	828-612-2701	Weekdays	1	0.00
05/12, 05:48PM	407-062-0806	Weekdays	2	0.00
05/14, 01:34PM	704-921-4700	Weekdays	6	0.00
05/16, 12:20PM	704-847-3211	Weeknights and Weekends	1	0.00
05/16, 12:21PM	704-576-7051	Weeknights and Weekends	6	0.00
05/16, 08:43PM	314-805-1131	Weeknights and Weekends	16	0.00
05/16, 09:14PM	405-478-5957	Weeknights and Weekends	37	0.00
05/18, 12:58PM	704-847-3211	Weekdays	6	0.00
05/18, 01:04PM	704-847-3211	Weekdays	19	0.00
05/18, 02:55PM	704-847-3211	Weekdays	1	0.00
05/19, 01:59PM	860-404-0541	Weekdays	2	0.00
05/21, 04:14PM	407-062-0806	Weekdays	4	0.00
05/21, 06:55PM	407-062-0806	Weekdays	1	0.00
Totals			362	0.00

Profile [edit](#)

User: Hillary Bremer
 Email: hillary@CellTec.com
 Address: 293 Turnpike Rd, Westborough

Analytics [View](#)

Minutes Breakdown

Weekdays	584
Weeknights and Weekends	174
Mobile to Mobile	55
Total Minutes	813

1 | 2 | 3

Rate Code: EDC3/Basic Extra



View Unbilled Activity for Device

Name:	View Unbilled Activity for Device
Brief Description:	User views activity that has been generated since their most recent billing statement.
Primary Actor	Consumer user
Trigger:	User selects the “Statements” \ “Unbilled” menu options
Main Path:	<ol style="list-style-type: none"> 1. This use case begins when user selects the View Unbilled Activity operation. 2. System displays the Unbilled Activity page including the following information: <ol style="list-style-type: none"> a). Summary of Unbilled Activity b). Detail generated since the most recent billing statement.
Alternate Paths:	<p>[A1] User has access to more than one sub-account and selects to view a different device.</p> <ol style="list-style-type: none"> 1. System redisplay the Unbilled Activity page. <p>[A2] System is unable to retrieve Unbilled Activity</p> <ol style="list-style-type: none"> 1. System will display a message informing the user that the unbilled data is unavailable at this time. <p>[A3] Manage PAB entry</p> <p>User manages contact information for a specific device number.</p> <ol style="list-style-type: none"> 1. User clicks on the alias name or phone number displayed. 2. System displays an entry form that is pre-populated with the existing PAB entry. 3. User edits the information and selects update action. 4. System stores the new entry and displays the updated list.
Standard Features:	<ol style="list-style-type: none"> 1. Download (CSV, XML) 2. Personal Address Book 3. Printer Friendly 4. Paging/Sorting
Configuration Points:	<ol style="list-style-type: none"> 1. The number, type, and ordering of call detail columns. 2. Initial sort order for each column.
Notes:	<p>All data on this page is generated and provided by the billing system in real-time.</p> <p>Tip: Use account number 10756456 to view unbilled activity data.</p>

Unbilled Activities
 User: Hillary Bremer Account: 80011008
 Download: CSV GO Printer Friendly

Wireless Number: 407-113-5451 GO

Search For Device Number
 Search for Device Number: SUBMIT
[Address Book ON/OFF](#)

Minutes used since last statement
 Peak minutes 45
 Weekend minutes 0
Total minutes 45

Call details

Date, Time	Called Number	Destination	Type	Duration
1900-01-01 10:03	123-458-1111	Natick, MA	Unrated	45

Profile [edit](#)
 User: Hillary Bremer
 Email: hillary@CellTec.com
 Address: 293 Turnpike Rd, Westborough

Analytics [View](#)
Minutes Breakdown

Weekdays	584
Weeknights and Weekends	174
Mobile to Mobile	55
Total Minutes	813

SIEBEL

Print Current View

Name:	Print Current View
Brief Description:	User prints the current view.
Primary Actor:	Consumer user
Main Path:	<ol style="list-style-type: none"> 1. This use case begins when the User selects the Printer-Friendly operation on a given screen. 2. System opens a new window and displays a printer friendly version of the current view. 3. System displays a print dialog box to the User. 4. User selects the print settings in the print dialog and submits the print request. 5. User closes the printer friendly version and returns to the application.
Alternate Paths:	<p>[A1] User closes the printer friendly view and returns to the original view</p> <ol style="list-style-type: none"> 1. System does not send anything to the printer and leaves the user viewing the application. <p>[A2] User closes the print dialog</p>

	1. System does not send anything to the printer and leaves the user viewing the printer friendly page.
Standard Features:	<ol style="list-style-type: none"> 1. The following screens will have the Print Friendly option: <ol style="list-style-type: none"> a). All Reports b). Invoice Summary c). Call Details d). Payment Activity e). All Payment Confirmation Screens
Notes:	<ol style="list-style-type: none"> 1. Printer Friendly pages will not have any of the navigation information. 2. The page that is sent to the printer will be in grayscale.

Print Close			
Device Summary Detail for Account: 80011008 as of 05/04/04 for the Device Number : 407-113-5451			
Summary for 407-113-5451			
Total Charges For: 407-113-5451			\$12.69
Rate Plan			
	Period	Prorated Monthly Charge	Total Charge
Basic Plan	05/04-06/03	9.99	9.99
Includes:			
CALL FORWARDING N/C			
CALL HOLD			
CALL WAITING N/C			
CALLER ID N/C			
CLID PER CALL BLOCK			
THREE PARTY CALL N/C			
Usage Charge Details			
Total Usage Charges			\$0.00
Optional Services			
	Period	Prorated Monthly Charge	Total Charge
VOICE MAIL ALERT	05/04-06/03	0.00	0.00
NATIONWIDE TOLL FREE	05/04-06/03	0.00	0.00
LONG DISTANCE ACCESS	05/04-06/03	0.00	0.00
NETWORK ACCESS	05/04-06/03	0.00	0.00
OFF-NETWORK ROAM	05/04-06/03	0.00	0.00
WIRELESS VOICEMAIL - BASIC N/C	05/04-06/03	0.00	0.00
Credits, Adjustments & Other Charges			
FED UNIVERSAL SVC CHARGE			0.26
911 MONTHLY			0.80
REGULATORY COST RECOVERY FEE			0.56
TELCOM RELAY SERVICE SURCHARGE			0.11
Total Other Charges			\$1.73
Taxes			
FEDERAL EXCISE TAX			0.33
STATE TELECOM SALES TAX			0.64
Total Taxes			\$0.97

Print Invoice

Name:	Print Invoice
Brief Description:	Consumer User prints a selected invoice.
Primary Actor:	Consumer User
Trigger:	User selects the “download PDF” action on any screen where PDF is available.
Main Path:	<ol style="list-style-type: none"> 1. This use case begins when the User selects the Print Invoice operation from the navigation menu. 2. System opens a new window and displays a PDF version of the selected invoice. 3. User saves or prints the invoice using Adobe Acrobat functionality.
Alternate Paths:	<p>[A1] User closes the PDF version of the invoice</p> <ol style="list-style-type: none"> 1. System shows the original web application to the user.
Standard Features:	<ol style="list-style-type: none"> 1. The following screens will have the PDF option: <ol style="list-style-type: none"> a). Invoice b). Tax Invoice (if applicable)
Configuration Points:	<ol style="list-style-type: none"> 1. PDF is dynamically generated at web time upon request. 2. Additional PDF requirements are supported, such as: <ol style="list-style-type: none"> a). Batch generation b). Email attachments c). AFP to PDF transform d). HTML to PDF transform e). Digital Signatures 3. PDF output requires configuration based on application deployment requirements
Notes:	<ol style="list-style-type: none"> 1. The PDF can be saved or printed via the Adobe Acrobat interface and will not have any of the navigation information specific to the web application. 2. For business users this would only be invoice summary and not the entire invoice on the fly. Generating an entire business invoice would have performance issues and may need to be created in batch if necessary. 3. PDF size threshold is dependent on customer data and is often decided based on client data sample and proposed architecture

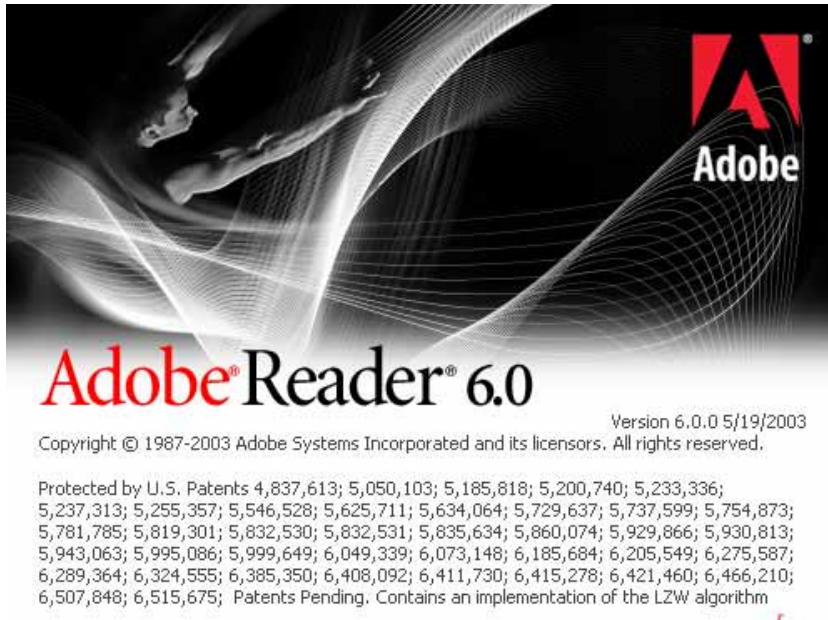

Download Account Data

Name:	Download Account Data
Brief Description:	A Consumer user downloads account data.
Primary Actor:	Consumer user
Trigger:	User selects the “download” action on any screen where download is available.
Main Path:	<ol style="list-style-type: none"> 1. This use case begins when User downloads account data and selects the download function. 2. System requests user to select data type. 3. User selects the appropriate data type. 4. User confirms selection. 5. Systems display the standard File Save or Open dialog box. 6. User enters file name and folder to save file. 7. Records displayed on the screen are saved to the specified file 8. Use case ends.
Alternate Paths:	None
Standard Features:	<ol style="list-style-type: none"> 1. XML data format 2. CSV data format 3. Dynamic PDF

	4. Cancel action
Configuration Points	<ol style="list-style-type: none"> 1. Generation of other formats using XSL 2. Columns of data to be downloaded
Notes:	<ol style="list-style-type: none"> 1. Downloads are available within: <ol style="list-style-type: none"> a). All Reports b). Call Detail c). Unbilled Detail d). Account Summary

The screenshot shows the Siebel Account Summary page for user Hillary Bremer, account 80011008. The page includes a navigation bar with tabs for Overview, Statements, Payments, Analytics, Profile, Services, and Help. The main content area displays account summary details, a table of statement summary costs, and a minutes breakdown pie chart. A 'File Download' dialog box is overlaid on the page, showing file information for 'download.csv' and asking the user to open or save the file.

Account Summary
 User: Hillary Bremer Account: 80011008
 Please Select Statement Date: 05/04/04 [SUBMIT]

Statement summary costs

Monthly Service Charges	49.98					
Usage Charges	39.99	1.29	-1.63	3.49	0.00	43.14
Other Charges						
Taxes						
Total Current	49.98	1.29	0.10	4.46	0.00	55.83

Minutes Breakdown

Weekdays	584
Weeknights and Weekends	174
Mobile to Mobile	55
Total Minutes	813

File Download
 Some files can harm your computer. If the file information below looks suspicious, or you do not fully trust the source, do not open or save this file.
 File name: download.csv
 File type: Microsoft Office Excel Comma Separated Values Fil
 From: tmbuild
 Would you like to open the file or save it to your computer?
 [Open] [Save] [Cancel] [More Info]
 Always ask before opening this type of file

3.6 Payment Use Cases

The payment features provide the business requirements for allowing customers to pay charges from their statements. These user-level use cases specify the functionality required to satisfy these requirements in such a way that Billing Manager can be configured, rules defined, screens developed, and any custom code developed to fulfill the use cases.

This section describes the following functionality:

- **Quick Payment** – Consumer user makes a one-time quick payment.
- **Set Up Recurring Payments** – Consumer user configures rules to pay charges automatically on a monthly basis.
- **Manage Payment Accounts** – Consumer user can set up and manage multiple payment accounts for use in account/statement payments.
- **View Payment History** – Consumer user views their payment activity.

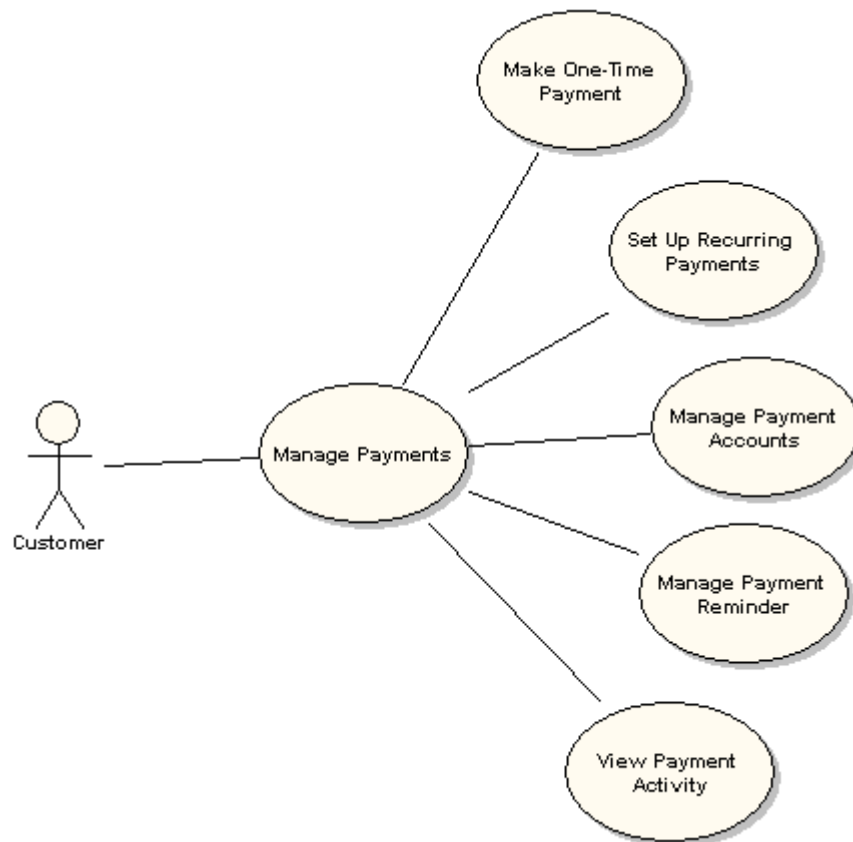

Quick Payment

Name:	Quick Payment
Brief Description:	Consumer User completes an online payment
Primary Actor:	Consumer User
Trigger:	User selects the “Payments” \ “Quick Payment” menu options
Main Path:	<ol style="list-style-type: none"> 1. This use case begins when a User selects the Quick Payment operation. 2. System displays Quick Payment screen, which allows the user to provide

	<p>the following information:</p> <ol style="list-style-type: none"> 1. The Payment Account: (defaults to a single Account) <ol style="list-style-type: none"> a). Account used in previous payment (enrolled payment account) b). Link to add New Payment Account [A2] 2. Payment Amount <ol style="list-style-type: none"> a). Total Amount due or. Amount to Pay (defaults to Total Amount Due) b). Specified amount, entered by user 3. The Payment Date 4. email Notification option(<i>Note:</i> This option notifies user for one-time (quick) instant payments made using credit cards and bank accounts) <ol style="list-style-type: none"> 3. User makes payment selections using an enrolled payment method and submits. 4. System displays confirmation requesting the user to confirm the payment details along with appropriate terms and conditions (if applicable). 5. User confirms payment data. 6. System processes payment. 7. System validates the request and displays a <i>Payment Confirmation</i> screen with the message in the form “You have scheduled a payment in the amount of <amount> from account <Account Alias> on <date>. Your confirmation number for this transaction is <confirm#>”
<p>Alternate Path:</p>	<p>[A1] User enters invalid information</p> <ol style="list-style-type: none"> 1. System prompts the User to review the information and does not accept the transaction. <p>[A2] User has not enrolled a payment method for Payment</p> <ol style="list-style-type: none"> 1. User selects New Payment Account link 2. System sends user to Payment Account screen for enrollment. <p>[A3] User has setup a previous recurring payment</p> <ol style="list-style-type: none"> 1. User is presented with a message warning them of a possible double payment and allows the user to cancel <p>[A4] System determines one or more pieces of information is/are invalid.</p> <ol style="list-style-type: none"> 1. System displays Quick Payment page with appropriate error messages. The user can correct the errors.
<p>Standard Features:</p>	<ol style="list-style-type: none"> 1. Date validation 2. Data and account validation
<p>Configuration Points:</p>	<ol style="list-style-type: none"> 1. The system can display any payable billing entity based on the client’s permission to process payments accordingly. 2. If a user does not have payment privileges for an account, the user is not able to select an account to pay.
<p>Notes:</p>	<ol style="list-style-type: none"> 1. The effective date will be calculated based on the system date assuming that the payment should be completed by a specific time in the day in order

- for it to be processed that day and effective on the next day.
- 2. System checks if One Time Payment is scheduled during a Recurring Payment window. If a Recurring Payment is scheduled, the system should warn the user that a Recurring Payment is scheduled on date X and that by confirming payment on this screen a double payment could be made.
- 3. Payment processing is assumed to occur only on business days.

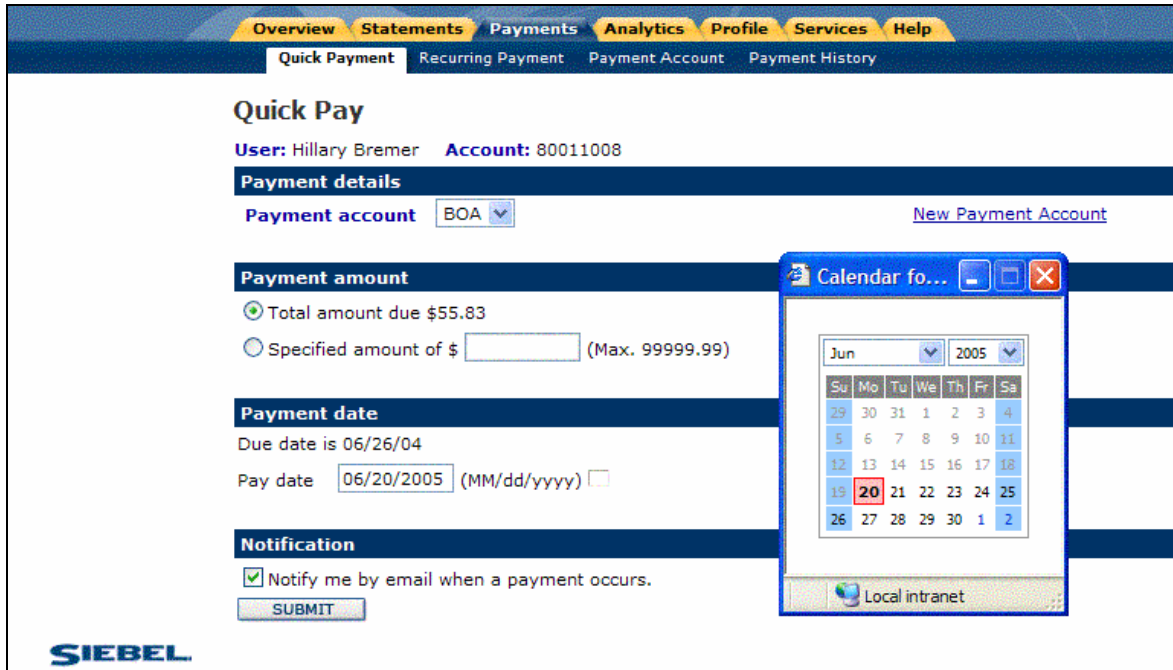

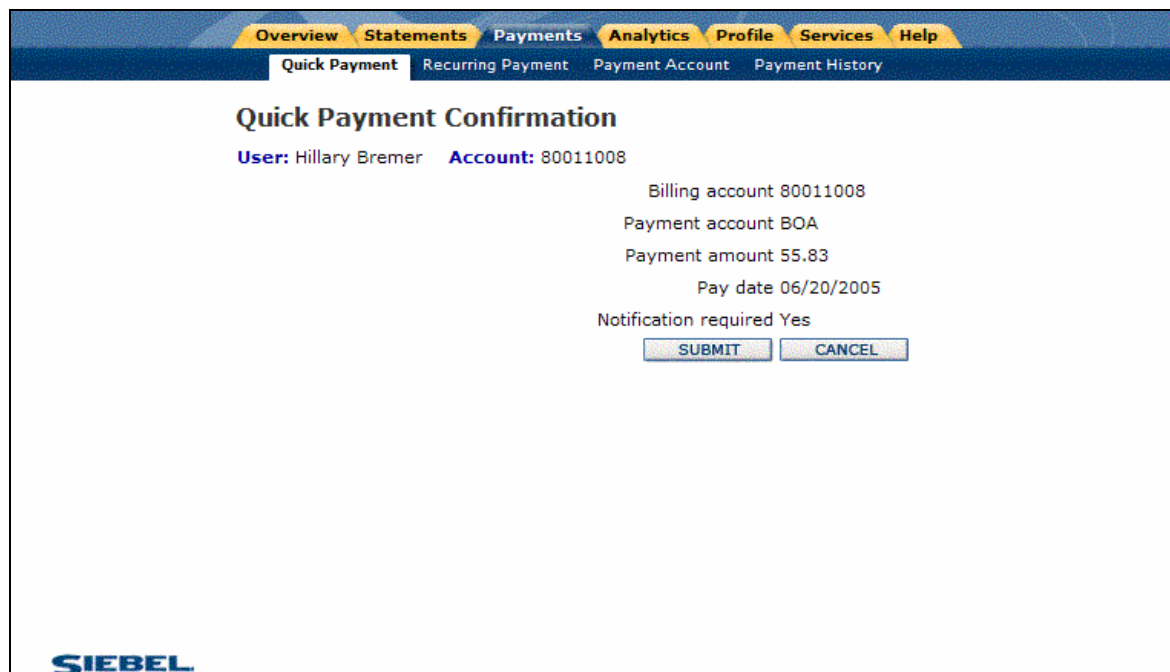

Set Up Recurring Payment

Name:	Setup Recurring Payment
Brief Description:	Consumer User intends to pay charges automatically on a monthly basis.
Primary Actor:	Consumer User
Trigger:	User selects the "Payments" \ "Recurring Payment" menu options
Main Path:	<ol style="list-style-type: none"> 1. This use case begins when the User selects the recurring payment operation from the navigation menu. 2. System displays the recurring payment form to the User. 3. User selects an established payment account. <ol style="list-style-type: none"> a. Payment Account (defaults to a single Account), b. Select Pay Amount Options <ol style="list-style-type: none"> i. Total Amount Due ii. Total Amount Within Threshold (user enters threshold amount and receives a notification if amount due exceeds threshold) iii. Fixed Amount (user enters a fixed amount) c. Payment Transfer Date User selects on an option below and enters a value for X <ol style="list-style-type: none"> i. X business days before due date ii. On the X day of every month

	<p>d. Effective Period</p> <p>User defined the effective duration of the recurring payment, defining a value for X where specified.</p> <ul style="list-style-type: none"> i). Until Canceled ii). For X payments iii). Until date X (text box and popup calendar) <p>e. eMail Notification option (Note: System notifies 1)when user enrolls into the automatic bill payment program and 2) when a payment is scheduled by the recurring payment job)</p> <ol style="list-style-type: none"> 4. User selects 'Submit' action. 5. System displays a confirmation page requesting the user to confirm the recurring payment. 6. User makes their selections and submits. 7. System validates information and stores the recurring payment and adds recurring payment to list of scheduled recurring payments. 8. System displays the recurring payment rules page, if successful, and provides the User with a confirmation message.
<p>Alternate Paths:</p>	<p>[A1] User has an existing recurring payment set up.</p> <ol style="list-style-type: none"> 1. System displays the recurring payment rules page allowing the user to edit the existing payment account, change to a new payment account, or cancel the existing recurring payment. <p>[A2] User selects to use a new credit card or bank account and submits.</p> <ol style="list-style-type: none"> 1. System displays the Payment Account page, allowing user to enter the new account information. <p>[A3] User navigates to another page before submitting</p> <ol style="list-style-type: none"> 1. System does not record the payment set-up. <p>[A4] User enters invalid information</p> <ol style="list-style-type: none"> 1. System prompts the user to review the information and does not accept the transaction. <p>[A5] User enters a recurring payment that conflicts with an earlier scheduled recurring payment.</p> <ol style="list-style-type: none"> 1. System displays a notification that a conflict exists with the new payment and a scheduled recurring payment and notifies the user that if the payment is scheduled, a double payment could occur. <p>[A6] User selects Cancel or Remove action.</p> <ol style="list-style-type: none"> 1. System resets the recurring payment data, refreshes the screen and displays default values to the user.
<p>Standard Features:</p>	<ol style="list-style-type: none"> 1. Multiple payment accounts. 2. Payment Amount Options: <ul style="list-style-type: none"> a. Total Amount Due b. Total Amount Within Threshold c. Fixed Amount

	<p>3. Payment Date</p> <ul style="list-style-type: none"> a. X number of days before due date b. X day of the month <p>4. Recurring Payment Duration</p> <ul style="list-style-type: none"> c. Until cancelled d. X number of payments e. Until X Date <p>Email notification of payment event</p>
<p>Configuration Points:</p>	<p>Recurring payment options may be suppressed or read-only.</p>
<p>Notes:</p>	<p>Once the user has configured a recurring payment, a return to this page will show the recurring payment the user set up along with the ability to edit or cancel the recurring payments.</p> <p>If a recurring payment has been schedule on an account and is conflicted with a newly set up recurring payment, the system will display a warning message and allow the user to correct/delete recurring payment conflict.</p>

Overview Statement Payments Reports Profile Services Help

Quick Payment **Recurring Payment** Payment Account Payment History

Recurring Payment
 User: Hillary Bremer Account: 80011008

Setup Recurring Payments
 From Payment Account BOA

Amount

- Total amount
- Total amount with a threshold of \$ 50.00
 (you will be notified by e-mail if amount exceeds desired threshold)
- Fixed Amount of \$ 0.0

Transfer Date
Transfer Date

- 10 business days before due date
- On the 1 of every month

Effective Period

- Until Cancelled
- For 0 payments
- Until Date 04/19/2005 MM/dd/yyyy

Notification

- Notify by e-mail when a payment occurs

SUBMIT <REMOVE

Calendar - ...
 Apr 2005

Su	Mo	Tu	We	Th	Fr	Sa
27	28	29	30	31	1	2
3	4	5	6	7	8	9
10	11	12	13	14	15	16
17	18	19	20	21	22	23
24	25	26	27	28	29	30

 Local intranet

Recurring Payment Summary

Recurring Payment Screen

Name:	Setup Recurring Payment
Brief Description:	Consumer user intends to pay charges automatically on a monthly basis.
Primary Actor:	Consumer user
Trigger:	User selects the "Payments" \ "Recurring Payment" menu options
Main Path:	<ol style="list-style-type: none"> 1. This use case begins when the User selects the recurring payment operation from the navigation menu. 2. System displays the recurring payment form to the User. 3. User selects an established payment account. <ol style="list-style-type: none"> a) Payment Account (defaults to a single Account), b) Select Pay Amount Options <ol style="list-style-type: none"> i. Total Amount Due ii. Total Amount Within Threshold (user enters threshold amount and receives a notification if amount due exceeds threshold) iii. Fixed Amount (user enters a fixed amount) c) Payment Transfer Date <p>User selects on an option below and enters a value for X</p>

	<ul style="list-style-type: none"> iv. X business days before due date v. On the X day of every month <p>d) Effective Period</p> <p>User defined the effective duration of the recurring payment, defining a value for X where specified.</p> <ul style="list-style-type: none"> iv). Until Canceled v). For X payments vi). Until date X (text box and popup calendar) <p>e) eMail Notification option</p> <ol style="list-style-type: none"> 4. User selects 'Submit' action. 5. System displays a confirmation page requesting the user to confirm the recurring payment. 6. User makes their selections and submits. 7. System validates information and stores the recurring payment and adds recurring payment to list of scheduled recurring payments. <p>System displays the recurring payment rules page, if successful, and provides the User with a confirmation message.</p>
<p>Alternate Paths:</p>	<p>[A1] User has an existing recurring payment set up.</p> <ol style="list-style-type: none"> 1. System displays the recurring payment rules page allowing the user to edit the existing payment account, change to a new payment account, or cancel the existing recurring payment. <p>[A2] User selects to use a new credit card or bank account and submits.</p> <ol style="list-style-type: none"> 1. System displays the Payment Account page, allowing user to enter the new account information. <p>[A3] User navigates to another page before submitting</p> <ol style="list-style-type: none"> 1. System does not record the payment set-up. <p>[A4] User enters invalid information</p> <ol style="list-style-type: none"> 1. System prompts the user to review the information and does not accept the transaction. <p>[A5] User enters a recurring payment that conflicts with an earlier scheduled recurring payment.</p> <ol style="list-style-type: none"> 1. System displays a notification that a conflict exists with the new payment and a scheduled recurring payment and notifies the user that if the payment is scheduled, a double payment could occur. <p>[A6] User selects Cancel or Remove action.</p> <ol style="list-style-type: none"> 1. System resets the recurring payment data, refreshes the screen and displays default values to the user.
<p>Standard Features:</p>	<ol style="list-style-type: none"> 1. Multiple payment accounts. 2. Payment Amount Options: <ul style="list-style-type: none"> a. Total Amount Due b. Total Amount Within Threshold c. Fixed Amount

	<p>3. Payment Date</p> <ul style="list-style-type: none"> f. X number of days before due date g. X day of the month <p>4. Recurring Payment Duration</p> <ul style="list-style-type: none"> h. Until cancelled i. X number of payments j. Until X Date <p>Email notification of payment event</p>
<p>Configuration Points:</p>	<p>Recurring payment options may be suppressed or read-only.</p>
<p>Notes:</p>	<p>Once the user has configured a recurring payment, a return to this page will show the recurring payment the user set up along with the ability to edit or cancel the recurring payments.</p> <p>If a recurring payment has been schedule on an account and is conflicted with a newly set up recurring payment, the system will display a warning message and allow the user to correct/delete recurring payment conflict.</p>

[Overview](#) [Statements](#) [Payments](#) [Analytics](#) [Profile](#) [Services](#) [Help](#)

Quick Payment Recurring Payment Payment Account Payment History

The Recurring Payment was set up successfully.

Recurring Payment

User: Hillary Bremer **Account:** 80011008

Recurring Payment Information			
Payment Account	AmountType	Pay Interval	Effective Period
BOA	Total Amount Due	7 days before due	Until Cancelled
			<input type="button" value="EDIT"/> <input type="button" value="DELETE"/>

Manage Payment Accounts

Name:	Manage Payment Accounts
Brief Description:	Consumer user adds, edits or deletes payment account information
Primary Actor:	Consumer user
Triggers:	<ol style="list-style-type: none"> 1. User selects Payment Accounts menu option 2. User selects "New Payment Account" action from the "Quick Payment" screen
Main Path:	<p>(Main path describes adding a credit card account. Alternate paths address other types of accounts)</p> <ol style="list-style-type: none"> 1. This use case begins when the user selects the Payment Accounts operation from the navigation menu. 2. System displays a list of existing payment accounts and the ability to add/edit/delete those accounts. 3. User selects to add a credit card account. [A1-A3] 4. System displays the form to add a credit card account that contains the following fields. <ol style="list-style-type: none"> a). Account Nickname b). Account Number c). Account Name d). Card Type e). Expiration Date f). Card Verification Code g). Street Address (Line 1) h). Street Address (Line 2) i). City j). State/Region or Province k). Zip/Postal Code l). Country 5. User enters the information and submits the form. 6. System validates the information as being correct and updates the list of payment accounts. 7. Use case ends.
Alternate Paths:	<p>[A1] New bank account.</p> <ol style="list-style-type: none"> 1. System displays screen to add a bank account that contains the following information. <ol style="list-style-type: none"> a). Account Nickname b). Bank Name c). Account Number

	<ul style="list-style-type: none"> d). Routing Transit Number e). Diagram of a check identifying the location of the bank account and routing number. <ol style="list-style-type: none"> 2. User enters the information and submits the form. 3. System validates the information as being correct and updates the list of payment accounts. <p>[A2] Edit account.</p> <ol style="list-style-type: none"> 1. System displays the edit account screen containing credit card or bank account editable fields showing the current information for the specified account. 2. User enters the information and saves the form. 3. System validates the information as being correct and updates the list of payment accounts. <p>[A3] Delete account link.</p> <ol style="list-style-type: none"> 1. System displays a confirmation screen to ensure the user wants to delete the account. 2. System deletes the account and redisplay the screen. 3. Any recurring payments using the deleted payment account will be deleted. <p>[A4] System is unable to validate the information.</p> <ol style="list-style-type: none"> 1. System displays error message to user informing them of the specific issue.
<p>Standard Features:</p>	<ol style="list-style-type: none"> 1. Add, Edit, Delete Bank or Credit Card Accounts 2. Form validation
<p>Configuration Points:</p>	<ol style="list-style-type: none"> 1. Additional payment methods can be configured via the payment cartridge framework.
<p>Notes:</p>	<ol style="list-style-type: none"> 1. If a user deletes a payment account the recurring payments that have been setup to use that account are deleted. 2. When a payment fails, system sends out a payment failure notification.

[Overview](#)
[Statements](#)
[Payments](#)
[Analytics](#)
[Profile](#)
[Services](#)
[Help](#)

[Quick Payment](#)
[Recurring Payment](#)
[Payment Account](#)
[Payment History](#)

Payment Account

User: Hillary Bremer Account: 80011008

Current payment accounts

Description	Bank name	Account no.	Actions
You have not entered an account!			

Credit card account details

[ADD ACCOUNT](#)

Bank account details

[ADD ACCOUNT](#)



Add New Bank Account

[Overview](#)
[Statements](#)
[Payments](#)
[Analytics](#)
[Profile](#)
[Services](#)
[Help](#)

[Quick Payment](#)
[Recurring Payment](#)
[Payment Account](#)
[Payment History](#)

Payment Account

User: Hillary Bremer Account: 80011008

Nick name

Account name

Account no.

Routing transit

Memo

⑆0⑆9⑆3009⑆⑆ 001409⑆431⑆ 143⑆

Routing number Account number



Add Credit Card Account

Payment Account
 User: Hillary Bremer Account: 80011008

Nick name

Account no.

Account name

Account type

Expiration date format MM/yyyy

Expiration date

CVV code

Street

City

State

Zip code

Country

SIEBEL

Visa or Mastercard
3-digit CVV/CVC2 Code

12345 111

View Payment History

Name:	View Payment History
Brief Description:	Consumer User views a list of all payments activity for a configurable time period.
Primary Actor:	Consumer user
Trigger:	User selects the "Payments" \ "Payment History" menu options
Main Path:	<ol style="list-style-type: none"> 1. This use case begins when the user wants to view payment activity and selects the Payment History operation. 2. System displays Payment Activity Screen that shows the scheduled one-time and recurring payments and historic payment information including the current status. 3. Use case ends
Alternate Path:	<p>[A1] User selects an Action (edit or cancel) on a scheduled recurring payment</p> <ol style="list-style-type: none"> 1. Edit - System displays the recurring payment page <ol style="list-style-type: none"> a). System takes user to Recurring Payment page

	<ul style="list-style-type: none"> b). User updates recurring payment information and submits (information is pre-populated in form). c). System validates edited recurring payment details and requests confirmation d). System displays edited recurring payment details on Recurring Payments page <p>2. Cancel - System displays a delete pop-up and requests confirmation</p> <ul style="list-style-type: none"> a). User confirms or cancels the delete action b). System displays delete confirmation pop-up or cancels delete action and the Recurring Payments page is redisplayed. <p>[A2] User invokes the cancel operation on a one-time scheduled payment.</p> <ul style="list-style-type: none"> 1. System requests user to confirm and informs them that this operation will cancel the scheduled payment they have selected. <p>[A3] User invokes the edit operation on a one-time scheduled payment</p> <ul style="list-style-type: none"> 1. System displays the payment details with the editable fields. 2. User edits the information and submits the form.
<p>Standard Features:</p>	<ul style="list-style-type: none"> 1. Cancel action 2. Paging 3. Sorting
<p>Configuration Points:</p>	<ul style="list-style-type: none"> 1. Number of month's history presented. 2. Initial sort order for each column (ascending or descending). 3. Automatic payments can be set up for all invoice types, including statements. 4. Normally, CSR users (regardless of role) do not setup automatic recurring payments by default. 5. There is no "Due Date" for an invoice or a statement. Therefore the Due Date will be calculated as <ul style="list-style-type: none"> a. Invoice Date + Payment Terms.
<p>Notes</p>	<ul style="list-style-type: none"> 1. A recurring payment is a schedule of payments to be made. Once system processes the recurring payments they become scheduled payments and appear in the payment activity screen until they come due to be paid. 2. Here are the possible status values for recurring payments made using the check (account) payment method: <ul style="list-style-type: none"> Scheduled - System runs the payment job to pick all recurring payments set up. Processed - System changes the state when check has been processed. Paid - System changes the state when the check is cleared and not returned.

Cancelled - System changes the state when user cancels the payment
Failed - System changes state when a check failed to process due to an internal system error.
Returned - When a check is returned from ACH

3. Here are the possible status values for recurring payments made using credit card:

Scheduled - System runs the payment job to pick all recurring payments set up.
Failed authorize - System changes the state when the credit card payment information is incorrect.
Settled - System changes the state when the credit card payment has been authorized.
Cancelled - System changes the state when user cancels the payment.
Failed - System changes state when a credit card payment failed due to an internal system error or network problem.

4. There can be only one automatic payment per payer. Changing a scheduled payment may be done but there may be a lock-out window to prevent contention when payments are processing, there is no ability to skip an automated payment by using this feature.

Overview Statements Payments Analytics Profile Services Help

Quick Payment Recurring Payment Payment Account **Payment History**

Payment Activity

User: Hillary Bremer Account: 80011008

Reference Number	Pay Date	Amount	Source	Status	Action
1115065439011	05/12/2005	15.00	①	scheduled	edit - cancel
1115065081085	05/02/2005	55.83	①	settled	

SIEBEL

3.7 Analytics Use Cases

Billing Manager lets you create the following report:

- **View Device Report** – Consumer user views various device level reports
- **Download Report** – Consumer user can download report data

View Device Report

Name:	View Device Report
Brief Description:	Consumer User views a report within their account.
Primary Actor:	Consumer User
Main Path:	<ol style="list-style-type: none"> 1. This use case begins when the User selects a report to view. 2. System displays the report. 3. User changes the statement date. 4. System redisplay the previously selected report for the newly selected statement date. 5. User selects a different report. 6. System redisplay the selected report for the previously selected statement date.
Alternate Path:	<p>[A2] User has access to multiple devices and selects a different device. (Default model supports 1 account to 1 device.)</p> <ol style="list-style-type: none"> 1. System redisplay the previously selected report for the newly selected device. <p>[A2] There is no report data available for the selected report/statement date.</p> <ol style="list-style-type: none"> 1. System displays a message stating that there is no data available. <p>[A3] Report: 'Minutes by Rate Period' report</p> <p>[A4] Report: 'Charges by Rate Period' report</p> <p>[A5] Report: 'Minutes by Called Number' report</p> <p>[A6] Report: 'Calls by Rate Period' report</p> <p>[A7] Report: 'Charges by Destination' report</p> <p>[A8] Report: 'Top 10 most Expensive Calls' report</p> <p>[A9] Report: 'Charges by Called Number' report</p> <p>[A10] Report: 'Calls by Called Number' report</p> <p>[A11] Report: 'Calls by Destination' report</p> <p>[A12] Report: 'Minutes by Destination' report</p>

	[A13] Report: 'Top 10 longest call'
Standard Features:	<ol style="list-style-type: none"> 1. Download options (CSV, XML) 2. Print Friendly 3. Cancel action
Configuration Points:	<ol style="list-style-type: none"> 1. Default support for one account to one device 2. Graph type 3. Initial sort order for each column (ascending or descending).
Notes:	<ol style="list-style-type: none"> 1. Reports are based on available customer data: <ol style="list-style-type: none"> a). Reports are dynamic and use XSLt for processing data. b). Graphs are customized based on data and a variety of graph types are supported. 3. Device level reports include: <ol style="list-style-type: none"> a). Minutes by Rate Period b). Charges by Rate Period c). Minutes by Called Number d). Calls by Rate Period e). Charges by Destination f). Top 10 Most Expensive Calls g). Charges by Called Number h). Calls by Called Number i). Calls by Destination j). Minutes by Destination k). Top 10 Longest Calls <p>If more information is desired there are supplemental spreadsheets listing the required fields and screen examples</p>

Overview Statement Payments Reports Profile Services Help

Reports

Download: CSV GO Printer Friendly

Device Reports

User: Hillary Bremer Account: 80011008

Select Report Type

Statement Date: 05/04/04

Device Number: 407-113-5451 Report: Minutes by Rate Period SUBMIT

SIEBEL

Rate Period	Minutes
Weekdays	244
Weeknights and Weekends	118
Total	362

Download Report

Name:	Download Account Data
Brief Description:	A Consumer User downloads account data
Primary Actor:	Consumer User
Main Path:	The main path is the same as Download Account Data use case.
Alternate Paths:	a. None
Standard Features:	1. XML data format 2. CSV data format 3. PDF view
Configuration Points:	Generation of other formats using XSL Columns of data to be downloaded

	PDF views are configured and presented dynamically
Notes:	<p>Downloads are available within:</p> <ol style="list-style-type: none"> All reports Charges detail Unbilled detail Account Summary

The screenshot shows the Siebel Account Summary page for user Hillary Bremer (Account: 80011008). The page includes navigation tabs (Overview, Statements, Payments, Analytics, Profile, Services, Help) and sub-tabs (Account Summary, Device Summary, Device Usage, Unbilled Activity). A 'Download' dropdown is set to 'CSV'. A 'File Download' dialog box is open, displaying file information: 'download.csv', 'Microsoft Office Excel Comma Separated Values File', and 'From: tmbuild'. The dialog asks 'Would you like to open the file or save it to your computer?' with buttons for 'Open', 'Save', 'Cancel', and 'More Info'. A checkbox 'Always ask before opening this type of file' is checked. The background page shows a table of statement summary costs and a 'Minutes Breakdown' pie chart.

Category	Amount
Monthly Service Charges	49.98
Usage Charges	39.99
Other Charges	1.29
Taxes	-1.63
Total Current	89.73

Category	Minutes	Percentage
Weekdays	584	72%
Weeknights and Weekends	174	21%
Mobile to Mobile	55	7%
Total Minutes	813	

3.8 Profile Management Use Cases

The profile management functionality allows users to set up and manage personal profile, configure and manage monthly e-mail reminders, update their address book, and change their password

This section describes the following use cases:

- **Manage Personal Profile** – Consumer user can update/edit their user profile.
- **Manage Password** – Consumer user can manage their password.

- **Manage Notifications** – Consumer user can manage the notifications associated with their account.
- **Manage Personal Address Book** – Consumer user can manage their personal address book.

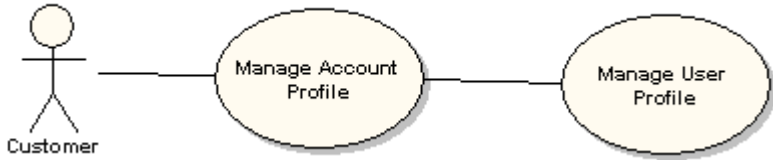

Manage Personal Profile

Name:	Manage Personal Profile
Brief Description:	Consumer user modifies personal profile information.
Primary Actor:	Consumer user
Trigger:	User selects "Profile \ Personal Profile" menu option
Main Path:	<ol style="list-style-type: none"> 1. This use case begins when the User selects the profile operation from the navigation menu. 2. System displays a page containing the current profile information in read only format. 3. User selects 'Edit User' profile hyperlink 4. System displays page with profile information that may be edited. <ol style="list-style-type: none"> a). User ID b). First Name c). Middle Initials d). Last Name e). Account f). Validation Code g). Password h). Date of Birth i). Email ID j). Street Address k). City l). State m). Zip Code n). Country

	<ul style="list-style-type: none"> o). Home Telephone p). Business Telephone <ol style="list-style-type: none"> 5. User edits the profile information and submits form. 6. System validates profile information and displays the updated profile screen to the user.
Alternate Paths:	<p>[A1] User enters invalid profile information:</p> <ol style="list-style-type: none"> 2. System redisplay the page with the appropriate error message so that customer can correct the information.
Standard Features:	<ol style="list-style-type: none"> 1. The following fields have configurable form validation: <ul style="list-style-type: none"> a. Email b. Zip/Postal Code
Configuration Parameters:	<ol style="list-style-type: none"> 2. Additional fields can be added to the profile management page based on client requirements. 3. The application supports this feature in its own data model, but it is expected that integration to an external system may be required via a plug-in to a third party system or LDAP repository.
Notes:	<ol style="list-style-type: none"> 1. The Personal Profile collects basic information pertaining to the user. Email addresses are collected in the Notifications portion of the application. 2. Should display the following to match enroll page: <ul style="list-style-type: none"> a). Street address b). City c). State/province (optional if country NOT US or Canada) d). Zip or postal code e). Country

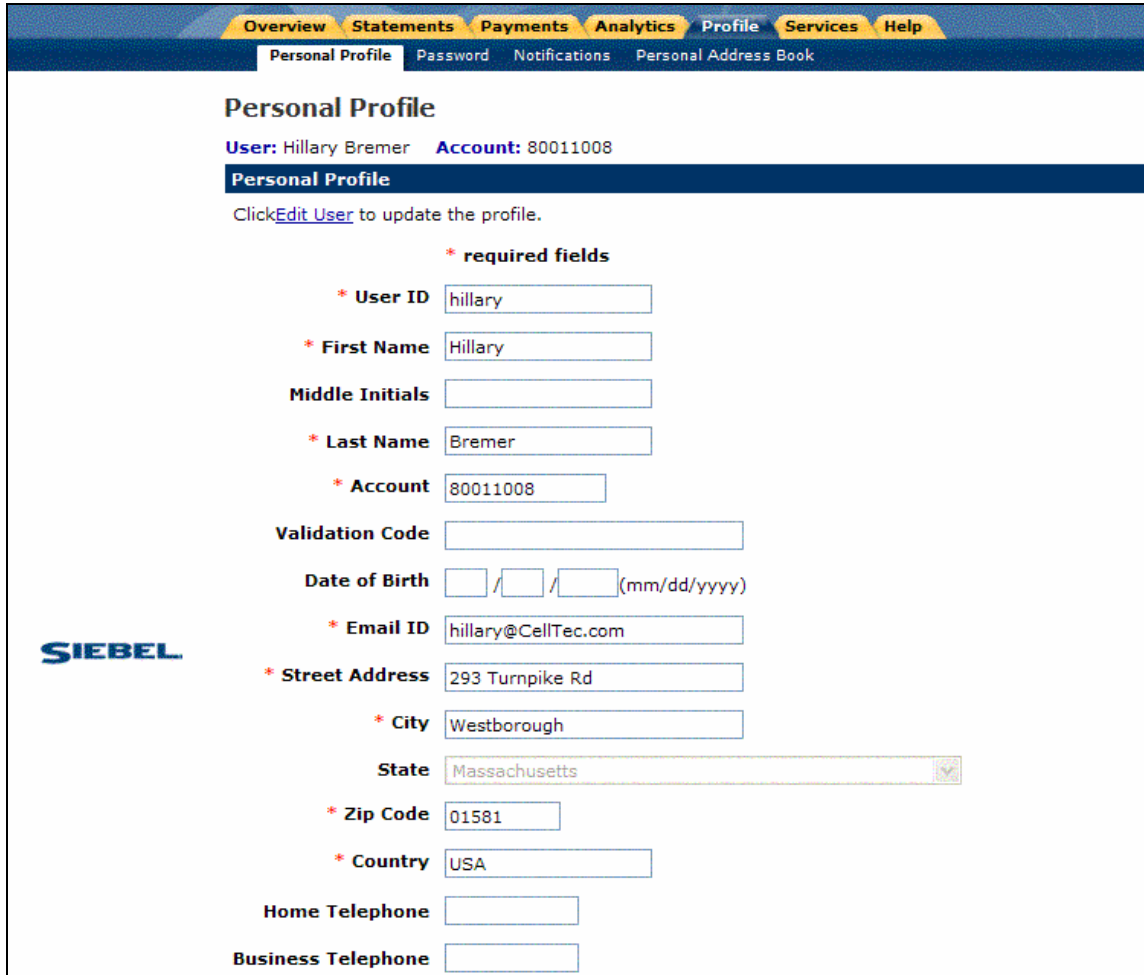

The screenshot shows the Siebel Personal Profile page. At the top, there is a navigation bar with tabs for Overview, Statements, Payments, Analytics, Profile, Services, and Help. Below this, a sub-navigation bar includes Personal Profile, Password, Notifications, and Personal Address Book. The main heading is "Personal Profile".

User: Hillary Bremer Account: 80011008

Personal Profile

Click [Edit User](#) to update the profile.

*** required fields**

- * User ID:
- * First Name:
- Middle Initials:
- * Last Name:
- * Account:
- Validation Code:
- Date of Birth: / / (mm/dd/yyyy)
- * Email ID:
- * Street Address:
- * City:
- State:
- * Zip Code:
- * Country:
- Home Telephone:
- Business Telephone:

The Siebel logo is visible on the left side of the form.

Manage Password

Name:	Manage Password
Brief Description:	Consumer user updates their password.
Primary Actor:	Consumer user
Trigger:	User selects "Profile" \ "Password" menu option
Main Path:	<ol style="list-style-type: none"> 1. This use case begins when the User wishes to change their password and invokes the change password operation from the navigation menu. 2. User enters in their existing password. 3. User enters in the desired password. 4. User re-enters in the desired password. 5. User submits the password change.

	<ol style="list-style-type: none"> System confirms to the user that the password has been changed. System stores updated password.
Alternate Paths:	<p>[A1] Current password is not valid.</p> <ol style="list-style-type: none"> System error message stating that the password does not match the one on record. <p>[A2] New passwords do not match security standards.</p> <ol style="list-style-type: none"> System responds with a message stating that the new passwords do not meet the required security standards. <p>[A3] New passwords do not match each other.</p> <ol style="list-style-type: none"> System responds with a message stating that the new passwords do not match each other.
Standard Features:	<ol style="list-style-type: none"> Form validation The application supports this feature in its own data model, but it is expected that deployments will require integration via a plug-in to an external third party system. Cancel action.
Configuration Points:	<ol style="list-style-type: none"> The default password parameters for the product are configurable. <ol style="list-style-type: none"> 4-12 characters, alpha-numeric

Manage Notifications

Name:	Manage Notifications
Brief Description:	Consumer User configures a notification to be sent at a regular interval
Primary Actor:	Consumer User
Trigger:	User selects "Profile" \ "Notifications" menu option
Main Path:	<ol style="list-style-type: none"> 1. This use case begins when a user selects the notification option in the profile tab. 2. System displays form that lists possible notifications. Checked notifications have been previously activated. Grayed checked/unchecked notifications are not editable. Unchecked notifications can be activated. <i>Note:</i> Each notification is tracked as a separate alternate path. <ul style="list-style-type: none"> <u>Account Event</u> <ol style="list-style-type: none"> a. New statement is available b. Payment Due date in 'X' days <u>Payment Event</u> (The following options notifies user only about scheduled payments) <ol style="list-style-type: none"> a. A payment posts to my account b. A payment fails <u>Credit Card Event</u> <ol style="list-style-type: none"> a. Credit Card Expiration remainder 3. User selects the notification and the applicable parameters 4. User selects notification to be active 5. User selects submit action. 6. System stores the notification information and a confirmation message is displayed.
Alternate Paths:	<p>[A1] Enter alternative email addresses for a notification.</p> <p>User may add additional email address to be included for notification and alerts.</p> <ol style="list-style-type: none"> 1. Select the add email address action. 2. System displays a page to enter email address. 3. User enters an email address and selects submit action. 4. System validates the email address. 5. User is returned to the notification page with the new email address displayed under the list of email addresses. <p>[A2] User sets notification to be inactive.</p> <ol style="list-style-type: none"> 1. System stores the information so that the notification is inactive and no notification will be sent

	<p>[A3] User edits or deletes additional email addresses.</p> <ol style="list-style-type: none"> 1. System updates additional email addresses for deletions or changes <p>[A4] SMS Notification</p> <ol style="list-style-type: none"> 1. Same as main path, except the user has the option to select an SMS notification option in addition to an email notification option. <p>[A5] Statement Notification: New statement available</p> <p>[A6] Statement Notification: Payment Due date in X days</p> <p>[A7] Payment Notification: A payment posts to my account</p> <p>[A8] Payment Notification: A payment fail</p> <p>[A9] Payment Notification: Credit Card expiration remainder</p>
<p>Standard Features:</p>	<p>Email Validation</p>
<p>Configuration Points:</p>	<ol style="list-style-type: none"> 1. Giving the user the ability to shut off email notification if they have shut off paper is configurable and a disclaimer can be produced. 2. SMS messages are configured based on SMS gateway integration for messaging requests.
<p>Notes:</p>	<ol style="list-style-type: none"> 1. Should be able to configure page options based on handset. Example some handsets do not have SMS capability 2. The primary focus to correct Command Center jobs to support a clean job infrastructure for email jobs serving Bill ready notifications and payment notifications. Many customers do NOT deploy payment features, so having separate jobs for these is a benefit. <p>3. Email Templates</p> <p>The following email template is used to notify the user on payment confirmation.</p> <p>From: admin@edocs.com Sent: 25 August 2004 04:45 PM To: <xsl:value-of select="user"/> Subject: Recurring Payment Confirmation</p> <p>Dear <xsl:value-of select="user"/>,</p> <p>This email is to confirm that you have been enrolled into the Automatic Bill Payment program for your online Account <xsl:value-of select="actnum"/>.</p> <p>Amount: <xsl:value-of select="amount"/></p> <p>The first automatic bill payment will take place after your next billing cycle.</p> <p>You will receive a payment confirmation email when the payment has been submitted.</p>

You may also continue to make other payments on your account using the Quick Payment option on the Payments Menu.

Thank you for using automatic bill payment.

Please continue visiting <<http://localhost:7001/tbm>>

This is an automatically generated email. Please do not reply to this email address.

Manage Personal Address Book

Name:	Manage Personal Address Book (PAB)
Brief Description:	Consumer user manages all their personal address book entries.
Primary Actor:	Consumer user
Trigger:	User selects "Profile" \ " Address Book" menu option
Main Path:	<ol style="list-style-type: none"> 1. System displays the user's complete PAB with the following fields. <ol style="list-style-type: none"> a). Alias (Required, no character validation)

	<ul style="list-style-type: none"> b). Name (Optional no character validation) c). Number (Required) <p>Manage PAB Entry with:</p> <ul style="list-style-type: none"> a). Edit function b). Delete function <ol style="list-style-type: none"> 2. User selects the add operation. [A1-A3] 3. System displays an entry form. 4. User enters the information and submits the form. 5. System stores the new entry. 6. System displays the updated PAB list.
<p>Alternate Paths:</p>	<p>[A1] Edit PAB entry</p> <ol style="list-style-type: none"> 1. System displays an entry form that is pre-populated with the existing PAB entry. 2. User edits the information and submits the form. 3. System stores the new entry. 4. System displays the updated PAB list. <p>[A2] Delete PAB entry</p> <ol style="list-style-type: none"> 1. System displays a page requesting user to confirm the delete operation. 2. User confirms. 3. System deletes entry from the User's PAB <p>[A3] Search PAB entry</p> <ol style="list-style-type: none"> 1. User enters the search criteria and selects 'Search' option. 2. System displays all matching search results to the user.
<p>Standard Features:</p>	<ol style="list-style-type: none"> 1. Personal Address Book entries contain the following fields <ul style="list-style-type: none"> a). Friendly Name/Alias b). Name 2. The name will be substituted for the device number when displaying details.
<p>Configuration Points:</p>	<ol style="list-style-type: none"> 1. Additional fields can be added to the application based on client requirements.
<p>Notes:</p>	<ol style="list-style-type: none"> 1. The name will be substituted for the device number when displaying details. 2. System defaults to one account - one device model.

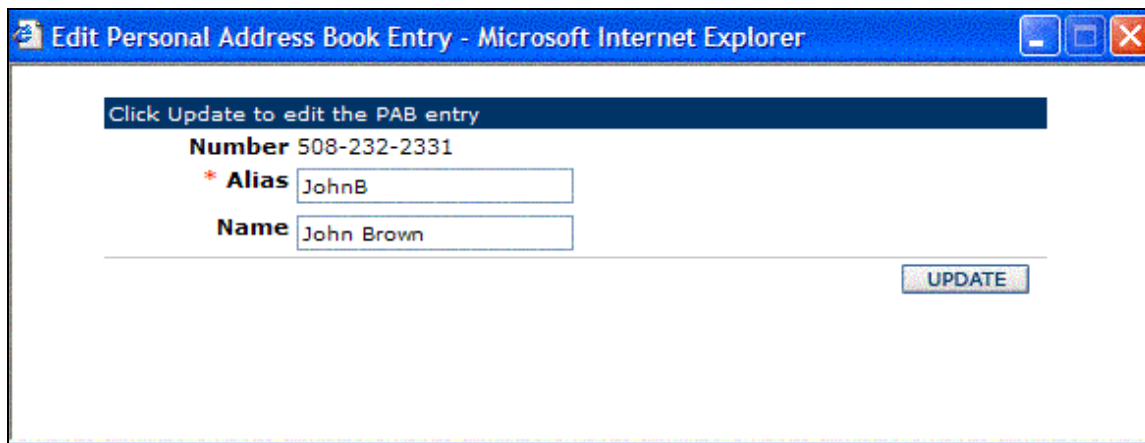
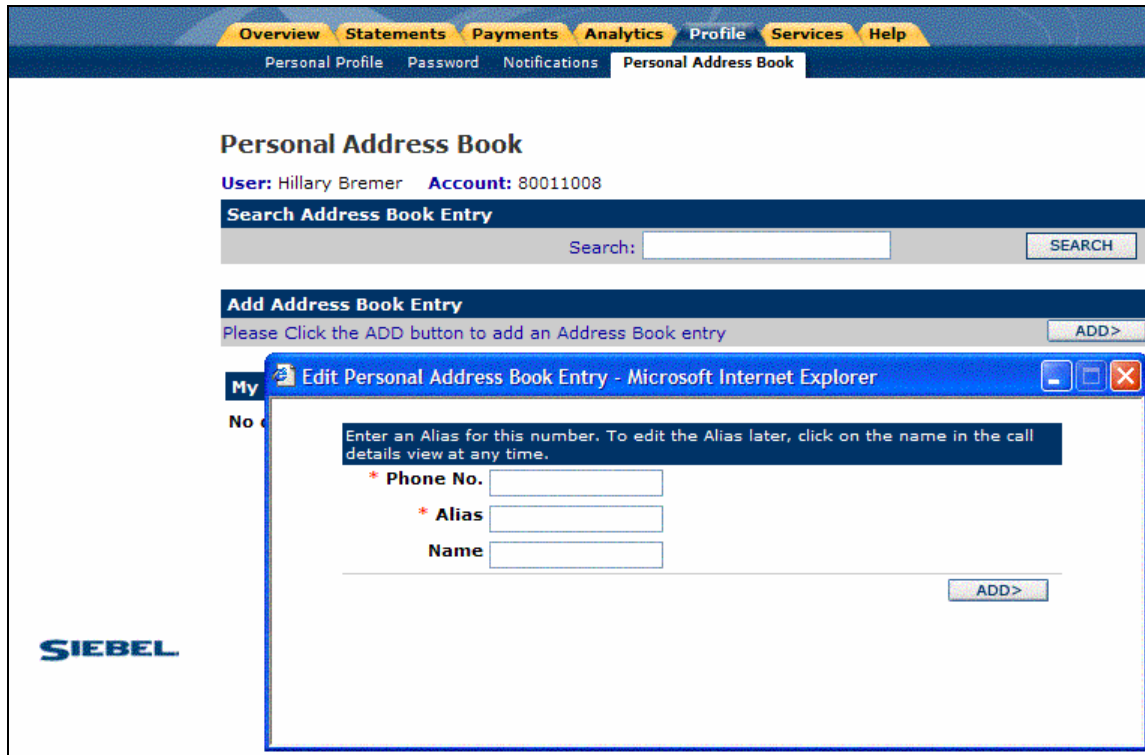

3.9 Customer Service Representative (CSR)

The customer service use cases allow the provider to effectively manage consumer users. The customer service use case section covers the following use cases:

- **Manage Internal Users** –Provider can manage their consumer users.
- **Add internal Users** – A CSR administrator adds other CSRs.

- **Edit Internal User Profile** – A CSR (internal user) can edit their profile.
- **Search for Account** – Provider can search for consumer accounts and invoke the impersonate user feature.
- **Search for User** – A CSR can find a consumer user.
- **Impersonate User** – Provider can impersonate consumer users.

Manage Internal Users

Manage Internal Users

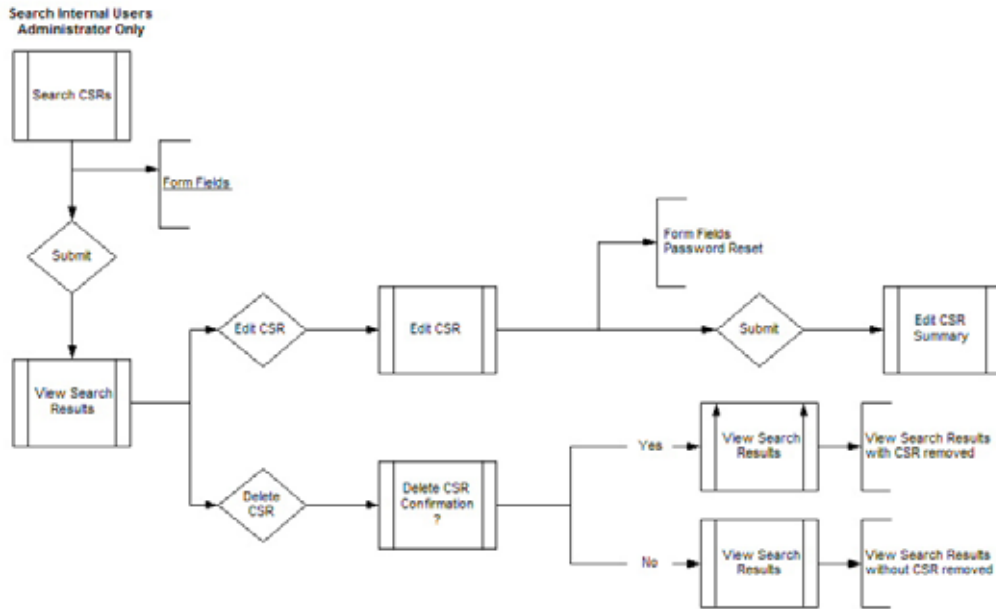

Manage Internal Users - Cont'd

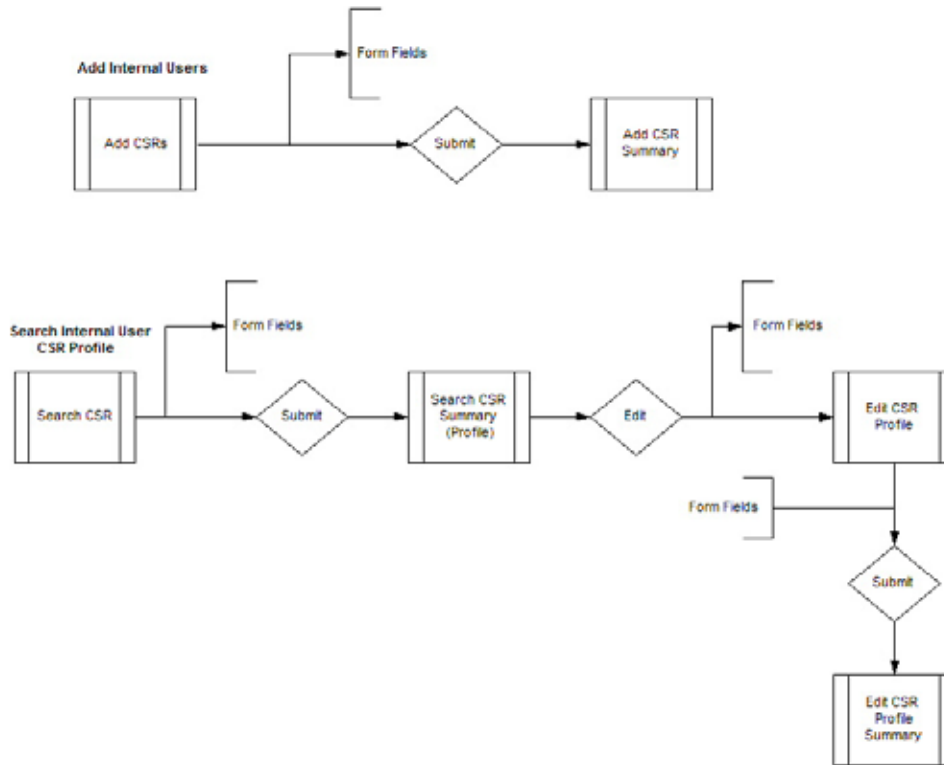

Name:	Manage Internal Users
Brief Description:	A Customer service representative administrator, adds, deletes, or modifies other CSRs, so that they can access the application.
Actor:	CSR Administrator
Trigger:	Successful login into CSR application. CSR Admin clicks on the Manage CSR tab.
Main Path:	<ol style="list-style-type: none"> 1. This use case begins when an administrator CSR logs in to the application and invokes the Search for users operation. 2. System displays search screen with the following attributes: <ol style="list-style-type: none"> a). CSR ID b). First Name c). Last Name 3. User enters the search criteria and submits the form 4. System displays search result with the list of internal user accounts to the administrator. [A1]

	<p>User has option to:</p> <ol style="list-style-type: none"> a). Edit CSR User [A2] b). Delete CSR User [A3] <ol style="list-style-type: none"> 5. User selects an appropriate option 6. System links to appropriate page based on option selected. 7. Use case ends.
<p>Alternate Paths:</p>	<p>[A1] There are no matching accounts found for the given criteria.</p> <ol style="list-style-type: none"> 1. System displays a message stating that there are no matching results. <p>[A2] Edit CSR Details.</p> <p>CSR Admin selects user from the list and invokes the Edit User option.</p> <ol style="list-style-type: none"> 1. System displays Edit User page including: <ol style="list-style-type: none"> a). First name b). Last name c). CSR ID d). Password e). Password confirmation f). Email Address g). Role h). Status (Active/Inactive) 2. User updates fields and submits the form. 3. System validates the information and updates the profile for the selected user. [A4] 4. System displays the updated list of internal users to the administrator. <p>[A3] CSR Admin selects the Delete operation:</p> <ol style="list-style-type: none"> 1. System displays a confirmation page with the following information: <ol style="list-style-type: none"> a). Name b). Role 2. User confirms the operation. 3. System validates the request and logs details of inactivated user and disables the user's access. 4. System displays the updated list of Internal Users <p>[A4] System is unable to validate information</p> <ol style="list-style-type: none"> 1. System prompts the user to review the information and does not accept the transaction.
<p>Configuration:</p>	<p>None</p>
<p>Notes:</p>	<ol style="list-style-type: none"> 1. Only Administrator CSRs have the ability to manage other CSR users 2. Search use "exact match" logic, meaning all records are returned with fields that exactly match the values entered in the search criteria. "*"

can be added to the end of any value to change it to "starts with" match logic

Search CSR

Accounts **Manage CSR**

Search CSRs Add CSRs Profile

Profile

Search CSR Profile

Please input search criteria.

User ID:

First Name:

Last Name:

Copyright © 2005 Siebel Systems, Inc. All rights reserved.

Search Results

Accounts **Manage CSR**

Search CSRs Add CSRs Profile

Profile

Search CSR Profile

CSR Search Results

CSR Users	CSR Details
john smith	Edit Delete

Copyright © 2005 Siebel Systems, Inc. All rights reserved.

Edit CSR Profile

Accounts **Manage CSR**

Search CSRs Add CSRs Profile

Profile

Edit CSR Profile
Please edit CSR profile information.
*indicates required field.

*First Name: john

*Last Name: smith

*User ID: John_Smith

*Password:

*Confirm Password:

*Email Address: john.smith@docscs.com

*Role: CSR

*Status: Active

SUBMIT

SIEBEL Copyright © 2005 Siebel Systems, Inc. All rights reserved.

Edit CSR Profile – Confirmation Summary

Accounts **Manage CSR**

Search CSRs Add CSRs Profile

Profile

Search CSR Profile
Your profile has been edited successfully.

First Name: john

Last Name: smith

User ID: John_Smith

Password:

Confirm Password:

Email Address: john.smith@docscs.com

Role: CSR

Status: Active

SIEBEL Copyright © 2005 Siebel Systems, Inc. All rights reserved.

Add Internal Users

Name:	Add Internal Users (CSR)
-------	--------------------------

Brief Description:	A Customer Service Representative Administrator adds other CSRs.
Actor:	Customer Service Representative Administrator (CSR Admin)
Trigger:	The CSR clicks on the Manage CSR tab and Select Add CSR
Main Path:	<ol style="list-style-type: none"> 1. This use case begins when an administrator CSR chooses to Add Internal Users. 2. User selects the Add function for a chosen CSR user and enters the user's details. <ol style="list-style-type: none"> a. First Name b. Last Name c. User ID d. Email Address e. Role f. Password (4 - 14 characters) g. Confirm Password 3. Admin Internal User enters information and submits the form. 4. System validates the information and displays the summary confirmation for successfully adding a user. 5. Use case ends.
Alternate Paths:	<p>[A1] System is unable to validate information</p> <ol style="list-style-type: none"> 1. System prompts the user to review the information and does not accept the transaction.
Standard Features:	Form Validation
Configuration Points:	<ol style="list-style-type: none"> 1. The fields that are displayed on this screen are configurable based on client requirements. 2. CSRs are added and normally immediately active, but this can be configured to be part of an enrollment process for CSRs themselves.
Notes:	<ol style="list-style-type: none"> 1. Only Administrator CSR's have the ability to manage other CSR users. 2. Regular CSR Users will have access to the profile tab, but will only have access to their own profile so that they can update their information. This is a request from the business. 3. Username and password will have same limits as end users.

Accounts **Manage CSR**
 Search CSRs **Add CSRs** Profile

Add CSRs

Add Internal Users

Please input user information.
 *indicates required field.

*First Name:

*Last Name:

*User ID:

*Email Address:

Role:

*New Password: (4 - 14 characters)

*Confirm Password:

SIEBEL Copyright © 2005 Siebel Systems, Inc. All rights reserved.

Edit Internal User Profile

Name:	Edit Internal Users Profile
Brief Description:	A Customer Service Representative edits its own CSR profile.
Actor:	Admin CSR
Trigger:	The CSR must Click on the Manage CSR tab and Profile
Main Path:	<ol style="list-style-type: none"> 1. This use case begins when a CSR chooses to modify their own profile 2. User selects the edit function for their profile. 3. Administrator CSR chooses to edit the selected details. <ol style="list-style-type: none"> a). First name b). Last name c). User ID d). Password e). email f). Role g). Status (Active/Inactive) 4. Internal User enters information and submits the form. 5. System validates the information and displays the updated profile of Internal User to the user.
Alternate Paths:	None

Standard Features:	Form Validation
Configuration Points:	<ol style="list-style-type: none"> 1. The fields that are displayed on this screen are configurable based on client requirements. 2. The user can only edit its own user profile.
Notes:	None

Accounts Manage CSR
 Search CSRs Add CSRs Profile

Profile

Edit Profile
 Please edit your profile information.
 *indicates required field.

*First Name:

*Last Name:

*User ID:

*Password:

*Confirm Password:

*Email Address:

*Role:

*Status:

SIEBEL
 Copyright © 2005 Siebel Systems, Inc. All rights reserved.

Search for Account

Name:	Search for an Account
Brief Description:	Customer Service Representative searches for an account.
Primary Actor:	Customer Service Representative (CSR), CSR Admin
Trigger:	The CSR must Click on the Accounts and Search Accounts
Main Path:	<ol style="list-style-type: none"> 1. This use case begins when a Customer Service Representative wishes to find a user or account in order to view the account details. 2. System displays search screen with the following attributes: <ol style="list-style-type: none"> a. First Name b. Last Name c. User ID d. Account Number

	<p>e. Email Address</p> <ol style="list-style-type: none"> User enters criteria and submits the form. System displays a list of all matching accounts with links for the most recent statement for viewing. Use case ends.
Alternate Paths:	<p>[A1] User clicks “Impersonate” link in search results.</p> <ol style="list-style-type: none"> System invokes Impersonate User use case. <p>[A2] There are no matching accounts found for the given criteria.</p> <ol style="list-style-type: none"> System displays a message stating that there are no matching results.
Standard Features:	<ol style="list-style-type: none"> Partial entry plus wildcard * is possible for all fields options Form Validation Paging
Configuration Points:	<ol style="list-style-type: none"> The search form that is used by the CSR may be configured based on enrollment information. Required fields must be configured.
Notes	None

Accounts Manage CSR

Search Accounts

Search Accounts

Search Accounts

User First Name:

User Last Name:

User ID:

Account Number:

Email address:

SEARCH

Copyright © 2005 Siebel Systems, Inc. All rights reserved.

SIEBEL

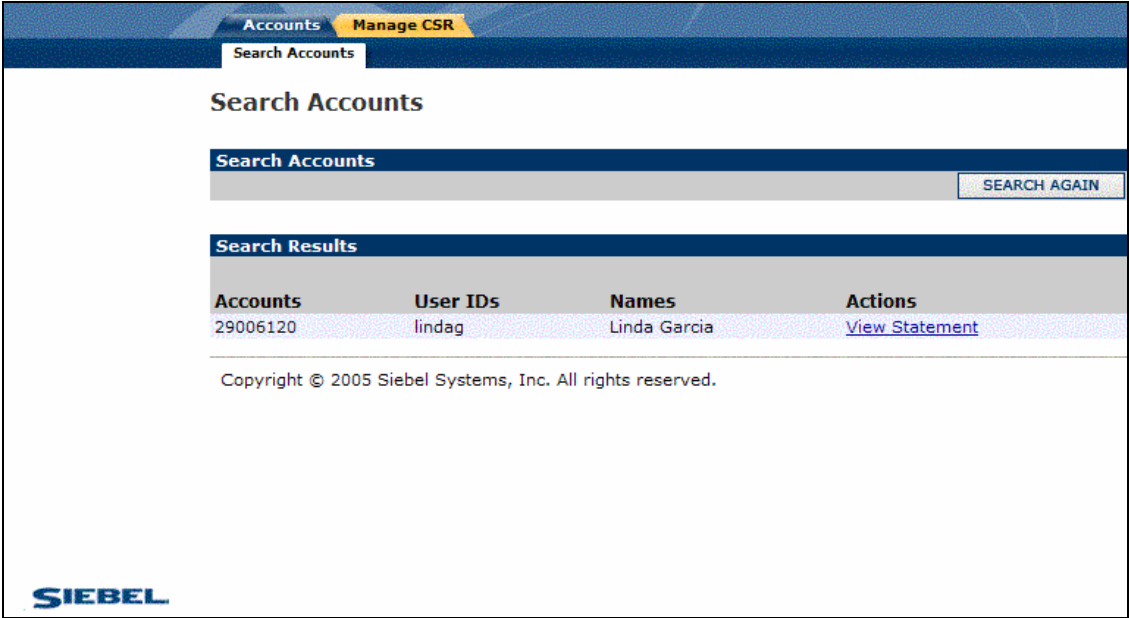

Search for Users

Search for Users:

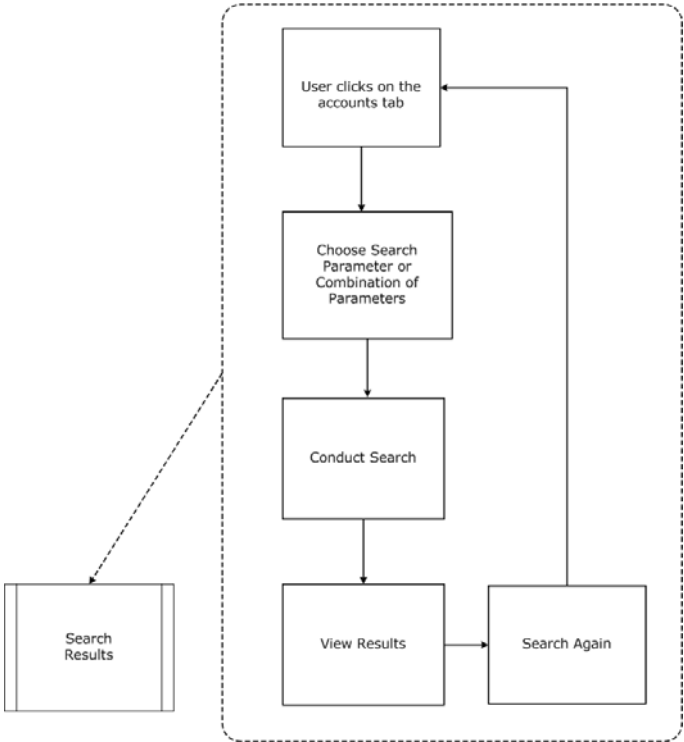

Name:	Search for Users
Brief Description:	CSR enters search criteria to locate users that they can impersonate.

Actor:	CSR, CSR Administrator
Trigger:	Successful login into CSR application (default page) or user clicks on the Search for User sub tab of the Search Tab from any other page.
Preconditions:	Login
Main Path:	<ol style="list-style-type: none"> 1. This use case begins when a Customer Service Representative selects search criteria from the Search Accounts screen. 2. System displays search screen with the following attributes: <ol style="list-style-type: none"> a. User First Name b. User Last Name c. User ID d. Wireless Number e. Account Number f. Email 3. User enters the search criteria and submits the form. 4. System displays search results screen of all users matching search criteria, <ol style="list-style-type: none"> a. User ID, Names b. Action: Edit/Delete [A2] and Impersonate [A1] 5. Use case ends.
Alternate Path:	<p>[A1] User clicks “Impersonate” link in search results.</p> <ol style="list-style-type: none"> 1. System invokes the Impersonate User use case. <p>[A2] CSR User selects Edit/Delete action.</p> <ol style="list-style-type: none"> 1. User selects edit action, system displays user edit profile screen with the following attributes: <ol style="list-style-type: none"> a. First Name b. Last Name c. User Name d. Password e. Confirm Password f. Email Address g. Role: {Administrator, User} h. Secret Question i. Secret Answer j. Status : {Active, Inactive} 2. CSR User changes the status to ‘Active’ and selects submit action. 3. System activates the user and allows CSR user to impersonate. <p>[A2] Retrieval Threshold Exceeded</p>

	<p>If the user views a list of accounts and the {Retrieval Threshold} is exceeded, only the threshold limit is displayed and the user receives the following warning message:</p> <p>“Display threshold exceeded. Only x of y records displayed.</p>																		
<p>Standard Features:</p>	<p>Form Validation Paging (UC 0040)</p>																		
<p>Configuration:</p>	<table border="1"> <thead> <tr> <th data-bbox="529 575 797 611">Screen</th> <th data-bbox="797 575 1084 611">Field</th> <th data-bbox="1084 575 1357 611">Validation</th> </tr> </thead> <tbody> <tr> <td data-bbox="529 625 797 661">Search Screen</td> <td data-bbox="797 625 1084 730">User First Name</td> <td data-bbox="1084 625 1357 730">Only characters and numbers and spaces allowed.</td> </tr> <tr> <td data-bbox="529 730 797 835"></td> <td data-bbox="797 730 1084 835">User Last Name</td> <td data-bbox="1084 730 1357 835">Only characters and numbers and spaces allowed.</td> </tr> <tr> <td data-bbox="529 835 797 940"></td> <td data-bbox="797 835 1084 940">User ID</td> <td data-bbox="1084 835 1357 940">Only characters and numbers allowed.</td> </tr> <tr> <td data-bbox="529 940 797 1045"></td> <td data-bbox="797 940 1084 1045">Wireless Number</td> <td data-bbox="1084 940 1357 1045">Only Numbers, spaces, and dashes.</td> </tr> <tr> <td data-bbox="529 1045 797 1079"></td> <td data-bbox="797 1045 1084 1079">Account Number</td> <td data-bbox="1084 1045 1357 1079">Only Numbers spaces, and dashes.</td> </tr> </tbody> </table>	Screen	Field	Validation	Search Screen	User First Name	Only characters and numbers and spaces allowed.		User Last Name	Only characters and numbers and spaces allowed.		User ID	Only characters and numbers allowed.		Wireless Number	Only Numbers, spaces, and dashes.		Account Number	Only Numbers spaces, and dashes.
Screen	Field	Validation																	
Search Screen	User First Name	Only characters and numbers and spaces allowed.																	
	User Last Name	Only characters and numbers and spaces allowed.																	
	User ID	Only characters and numbers allowed.																	
	Wireless Number	Only Numbers, spaces, and dashes.																	
	Account Number	Only Numbers spaces, and dashes.																	
<p>Notes:</p>	<ol style="list-style-type: none"> <li data-bbox="529 1100 1357 1163">1. System should display users(userid) associated at account level and subscription level in the search results page. <li data-bbox="529 1163 1357 1211">2. Paging is implemented for organization with large hierarchies 																		

Search User Accounts Screen:

Accounts Manage Org Manage CSR

Search Users

Search Users

Search Users

Please input search criteria.

First Name:

Last Name:

User ID:

Wireless Number:

Account Number:

Email address:

SEARCH

Copyright © 2005 Siebel Systems, Inc. All rights reserved.

Search Result Screen:

The screenshot shows the Siebel Search Users interface. At the top, there are navigation tabs for 'Accounts', 'Manage Org', and 'Manage CSR'. Below these is a 'Search Users' tab and a search input field with a 'SEARCH AGAIN' button. The main content area is titled 'Search Results' and contains a table with the following data:

User IDs	Names	Profiles	Actions
edocsadmin	John doei	Edit Delete	Impersonate
agreen	Anne Green	Edit Delete	Impersonate
dahughes	David Hughes	Edit Delete	Impersonate
dahughes1	David Hughes	Edit Delete	Impersonate
importer	Data Importer	Edit Delete	Impersonate
aryan1234	Aryan Karlos	Edit Delete	Impersonate
tanya123	Tanya Louis	Edit Delete	Impersonate
user123	user name	Edit Delete	Impersonate
admin0	Alert Steward	Edit Delete	Impersonate
test123	test test	Edit Delete	Impersonate
user_test	user test	Edit Delete	Impersonate
test_a	testa testa	Edit Delete	Impersonate
csr_test	testsa testtest	Edit Delete	Impersonate
SWilson	Samuel Wilson	Edit Delete	Impersonate
Samuel1234	Samuel Wilson	Edit Delete	Impersonate

The Siebel logo is visible on the left side of the screen. At the bottom, there is a copyright notice: 'Copyright © 2005 Siebel Systems, Inc. All rights reserved.'

Edit User Details:

Accounts **Manage Org** **Manage CSR**

Search Users

Search Users

Edit User Details

Please edit user profile details below.
*indicates required field.

*First Name:

*Last Name:

*User Name:

*Password:

*Confirm Password:

*Email Address:

*Role: ▼

*Status: ▼

Secret Question

Secret Answer

SIEBEL

Copyright © 2005 Siebel Systems, Inc. All rights reserved.

Impersonate User

Name:	Impersonate User
Brief Description:	A Customer service representative impersonates a user or views a specific account.
Primary Actor:	Customer service representative
Trigger:	User clicks "View Statement" link in search results
Main Path:	<ol style="list-style-type: none"> 1. This use case begins when a Customer Service Representative selects a user and invokes the impersonate operation. 2. System displays the initial page for the selected user, while maintaining the existing CSR navigation menu. 3. The CSR navigates through the application as an end user. 4. CSR exits the impersonated user. 5. System ends impersonation session for the selected user and returns the CSR to the search screen.
Alternate Paths:	None

Standard Features:	None
Configuration Points:	None
Notes:	<ol style="list-style-type: none">1. A CSR inherits the same rights and privileges as the user they are impersonating.2. Actions taken by a CSR will be tracked based separately than those actions taken by the individual users.

Accounts Manage CSR

Search Accounts

Impersonate

Logout | Contact Us | Change Language

Overview Statement Payments Reports Profile Services Help

Dashboard

Dashboard

User: Linda Garcia Account: 29006120

Account Overview [View Statement](#)

Statement Breakdown

Latest statement from 05/04/04

Monthly Service Charges	33.98
Usage Charges	291.15
Other Charges	9.30
Taxes	29.69
Total Current Charges	364.12

Payment due by 06/03/04

Payments [View Payments](#)

Last 2 Bill Totals

Payment by ACH payment at lockbox posted on May 22, 2004

Previous Balance	97.81
Payment Posted	-97.81
Adjustments	0.00
Past Due Balance Payable Immediately	0.00

Analytics [View Analytics](#)

Minutes Breakdown

Weekdays	885
Weeknights and Weekends	283
Total Minutes	1168

Profile [edit](#)

User: Linda Garcia
 Email: linda@CellTec.com
 Address: 293 Turnpike Rd, Westborough

Copyright © 2005 Siebel Systems, Inc. All rights reserved.

4 System Use Cases

4.1 Enrollment and Profile Use Cases

The following use cases describe functionality for enrollment:

- **User Self-Enrollment** – Actor enrolls into application without help from a CSR.
- **SAF Secure Access Framework Use Cases** – Default framework for user roles.

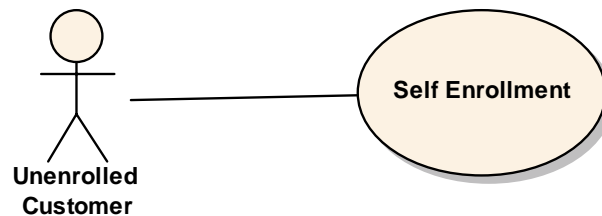

Self-Enrollment

Name:	User Self Enrollment
Brief Description:	User self-enrolls.
Primary Actor:	User type: Un-enrolled user.
Main Path:	<ol style="list-style-type: none"> 1. System determines the user has not previously enrolled into the e-bill application and displays a <i>self-enrollment page</i>. 2. User enters enrolment information, see Use Case 3.2.1.3 3. User submits the request. 4. System validates the request and displays <i>Enrollment Confirmation</i> screen with the message of the form “You are enrolling (...) ...”. 5. User clicks the “Confirm” button. 6. System displays a “Thank you” page of the form “You have successfully enrolled (...)...”. 7. System stores the user’s enrollment information and updates the user profile with enrolment information. 8. System stores the users default role of Customer Viewer. 9. System displays the e-bill start page the Overview or Dashboard View of his or her account.

Alternate Paths:	<p>[A1] User did not enter required or invalid data.</p> <ol style="list-style-type: none"> 1. System displays the Enrollment page with an error message indicating the data in question. <p>[A2] User wants to enroll for payment processing</p> <ol style="list-style-type: none"> 1. User must enroll successfully and also self –enroll for payment separately. See Payment Section.
Assumptions:	<ol style="list-style-type: none"> 1. The user is enrolled into application.
Notes:	<ol style="list-style-type: none"> 1. Enrollment is provided as an out of the box (OOTB) sample with the application. It is expected to be customized for deployment.

SAF Secure Access Framework Use Cases

Name:	Secure Access Framework
Brief Description:	Default roles provided with the SAF framework.
Primary Actor:	User of type: enrolled user.
Main Path:	<ol style="list-style-type: none"> 1. System stores the user’s enrollment information and updates the user profile including a set of default roles. <ol style="list-style-type: none"> a. Payer – Not used, but may be for some deployments b. User – Full access except CSR c. Super Admin – Full CSR access d. CSR – Full CSR access without the ability to create new CSRs 2. System stores the users default role of Customer Viewer. 3. System displays the e-bill start page the Overview or Dashboard View of his or her account.
Alternate Paths:	<p>[A1] User did not enter required or invalid data.</p> <ol style="list-style-type: none"> 1. System displays the Enrollment page with an error message indicating the data in question. <p>[A2] User wants to enroll for payment processing.</p> <ol style="list-style-type: none"> 1. User must enroll successfully and also self –enroll for payment separately. See Payment Section.
Assumptions:	The user is enrolled into application.
Notes:	Enrollment is provided as an out of the box (OOTB) sample with the application. It is expected to be customized for deployment.

4.2 Payment System Use Cases

Process Recurring Payment

Name:	Process Recurring Payments
Brief Description:	<p>System schedules a recurring payment based on recurring payment instructions setup by the User.</p> <p>A recurring payment instruction gets created by a user in the recurring payment screen. Scheduled recurring payment gets created before a payment is due.</p>
Actor(s):	System
Main Path:	<ol style="list-style-type: none"> 1. System retrieves a list of all billing accounts that have a recurring payment instructions that dictate their payment should be made within x days of the current date (x is configurable by service provider). 2. System verifies information is valid. 3. System generates a payment file containing scheduled payments for all billing accounts with recurring payment instructions. [A2] <p>Note: This scheduled payment is separate from the recurring payment instruction associated with the billing account. Scheduled payments can be edited from the payment activity screen before they come due to be paid. Editing a scheduled recurring payment does not change the recurring payment instruction associated with the billing account. Also, if a scheduled recurring payment already exists, editing the recurring payment instruction associated with the billing account will not affect the existing scheduled payments, only the creation of new scheduled payments.</p> <ol style="list-style-type: none"> 4. System triggers payment notification email event. 5. Scheduled payments should now display in the payment activity screen. 6. Use case ends.

Alternate Paths:	<p>[A1] System is unable to process recurring payments:</p> <ol style="list-style-type: none"> 1. System records the fault 2. System alerts the system administrator via a job failure in the Command Center. 3. System places the scheduling job on hold. <p>[A2] Payment amount exceeds specified payment threshold:</p> <ol style="list-style-type: none"> 1. System processes the recurring payments for those accounts that have exceeded a threshold limit by paying the threshold amount, 2. System sends a threshold exceeded email message to customer that the amount due exceeded the threshold amount. 3. System generates the payment file containing all valid recurring payments.
Standard Features	Email notification for processed and failed payments
Notes:	This created scheduled payment is separate from the recurring payment instruction associated with the billing account. Scheduled payments can be edited from the payment activity screen before they come due to be paid. Editing a scheduled recurring payment does not change the recurring payment instruction associated with the billing account. However, if a scheduled recurring payment already exists, editing the recurring payment instruction associated with the billing account will also apply the same edits to any scheduled recurring payments that have not yet been paid.
Configuration Notes:	The service provider can configure how many days before a payment due date that a recurring payment is scheduled.

4.3 E-Mail Notifications

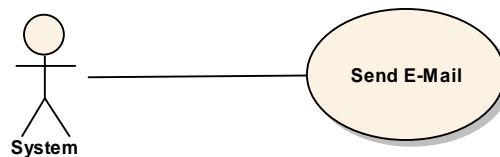

Name:	Send system email notification
Brief Description:	System sends email to notify User of a system event
Actor(s):	System
Trigger(s):	System detects an event that should result in an email to the User.

<p>Main Path:</p>	<ol style="list-style-type: none"> 1. This use case begins when a system notification event has occurred. [A1] <ol style="list-style-type: none"> 1. System generates email message based on one of the following triggering events: [A2-A14] <p><u>Statement</u> (one consolidated notification for all billing accounts for which the user has access.)</p> <ul style="list-style-type: none"> - Bill Ready Notification - Payment Due date in 5 days <p><u>Payment Account</u> (one consolidated notification for any payment account or billing account for which you have access)</p> <ul style="list-style-type: none"> - Completed One Time Payment - Create/Edit Recurring Payment - Recurring Payment Threshold Exceeded - Scheduled Payment Paid - ACH Payment Returned - Credit Card Payment Failed - Credit Card Expiration Notice <p><u>Service Manager</u> (one consolidated notification for any service agreement to which you have access to create a service request)</p> <ul style="list-style-type: none"> - Failed Service Request - Daily Summary (summary of all submitted, completed, and failed service requests for the day) <p><u>Other</u></p> <ul style="list-style-type: none"> - Batch Report Ready - Enrollment Confirmation 2. System generates list of email accounts that will receive email. 3. System generates a file that has the appropriate information. [A16] 4. System transfers the file to a location specified in the configuration of the file creation job. 5. The appropriate server processes and generates email file. [A17] 6. The server places the file in a location that is specified in the configuration of the email notification job. 7. System processes the file to generate email. [A18] 8. System sends email message to SMTP server. [A19] 9. Use Case ends.
<p>Alternate Paths:</p>	<p>[A1]System is unable to start job notification</p> <ol style="list-style-type: none"> 1. System updates the status of the job to "Failed". <p>[A2]Bill Ready Notification (Account & User Level)</p> <ol style="list-style-type: none"> 1. Bill cycle is completed for billing accounts 2. System creates Bill Ready email <p>[A3]Completed One Time Payment (User Level)</p>

	<ol style="list-style-type: none"> 1. One Time Payment is completed 2. System creates One Time Payment Completed email <p>[A4]Recurring Payment Scheduled (User Level)</p> <ol style="list-style-type: none"> 1. A recurring payment is scheduled 2. System creates Recurring Payment Scheduled email <p>[A5]Recurring Payment Threshold Exceeded (User Level)</p> <ol style="list-style-type: none"> 1. The recurring payment threshold is exceeded 2. System creates a Recurring Payment Threshold Exceeded email <p>[A6]Schedule Payment Paid (User Level)</p> <ol style="list-style-type: none"> 1. A scheduled payment has been paid 2. System creates a Scheduled Payment Paid email <p>[A7]ACH Payment Returned</p> <ol style="list-style-type: none"> 1. System creates a payment failure notification. <p>[A8]Credit Card Payment Failed</p> <ol style="list-style-type: none"> 1. System creates a payment failure notification. <p>[A9]Credit Card Expiration Notice (User Level)</p> <ol style="list-style-type: none"> 1. The credit card expiration date has expired 2. System creates a Credit Card Expiration Notice <p>[A10] Setup Recurring Payment Rules (User Level)</p> <ol style="list-style-type: none"> 1. The recurring payment rules are setup 2. System creates a Setup Recurring Payment Rules Notice <p>[A11] Modify Recurring Payment Rules (User Level)</p> <ol style="list-style-type: none"> 1. The recurring payment rules are modified 2. System creates a Recurring Payment Rules Modified Notice <p>[A12] Enrollment Confirmation</p> <ol style="list-style-type: none"> 1. User is successfully enrolled. 2. System creates an Enrollment Confirmation Notice. <p>[A13] Quick Payment Notification</p> <ol style="list-style-type: none"> 1. System creates a Quick Payment Notification when a one-time payment is submitted. <p>[A14] Quick Payment Failure Notification</p> <ol style="list-style-type: none"> 1. A problem occurred during one-time Quick Payment transaction 2. System creates a Quick Payment Failure notification <p>[A15] Payment Due Reminder (Payment Due in X days)</p> <ol style="list-style-type: none"> 1. System allows user to set up a reminder to remind the user to pay bills periodically. 2. System checks if any payment has been scheduled for the account before due date. 3. System creates a Payment Reminder Notification. <p>[A16] System is unable to generate the file</p> <ol style="list-style-type: none"> 1. System updates the status of the job to "Failed". 2. System logs the error and specific error code. <p>[A17] The server is unable to generate the file</p> <ol style="list-style-type: none"> 1. System updates the status of the job to "Failed". 2. System logs the error and specific error code. <p>[A18] System is unable to process the file to generate email</p> <ol style="list-style-type: none"> 1. System updates the status of the job to "Failed". 2. System logs the error and specific error code. <p>[A19] Email server is unavailable</p> <ol style="list-style-type: none"> 1. System updates the status of the job to "Failed". 2. System logs the error and specific error code.
Configuration	<ol style="list-style-type: none"> 1. Email notification will be sent to payment user's email account only. (If a admin user checks payment notification, the admin user receives

<p>Points:</p>	<p>notifications for all accounts to which the user has access in a consolidated email)</p> <ol style="list-style-type: none"> 2. If payment is performed on a consolidated basis, email notification will be consolidated (all confirmations for payment in one email) based on all payments made within the day. 3. After adding or removing accounts to/from an organization, an email notification will be sent to the administrator(s) for the organization. This notification will be triggered off of the confirmation screen when accounts have been successfully added/removed.
<p>Notes:</p>	<p>None</p>

5 External Interfaces

Overview of Integration Points

The following diagram illustrates the Billing Manager's extensible, multi-channel architecture:

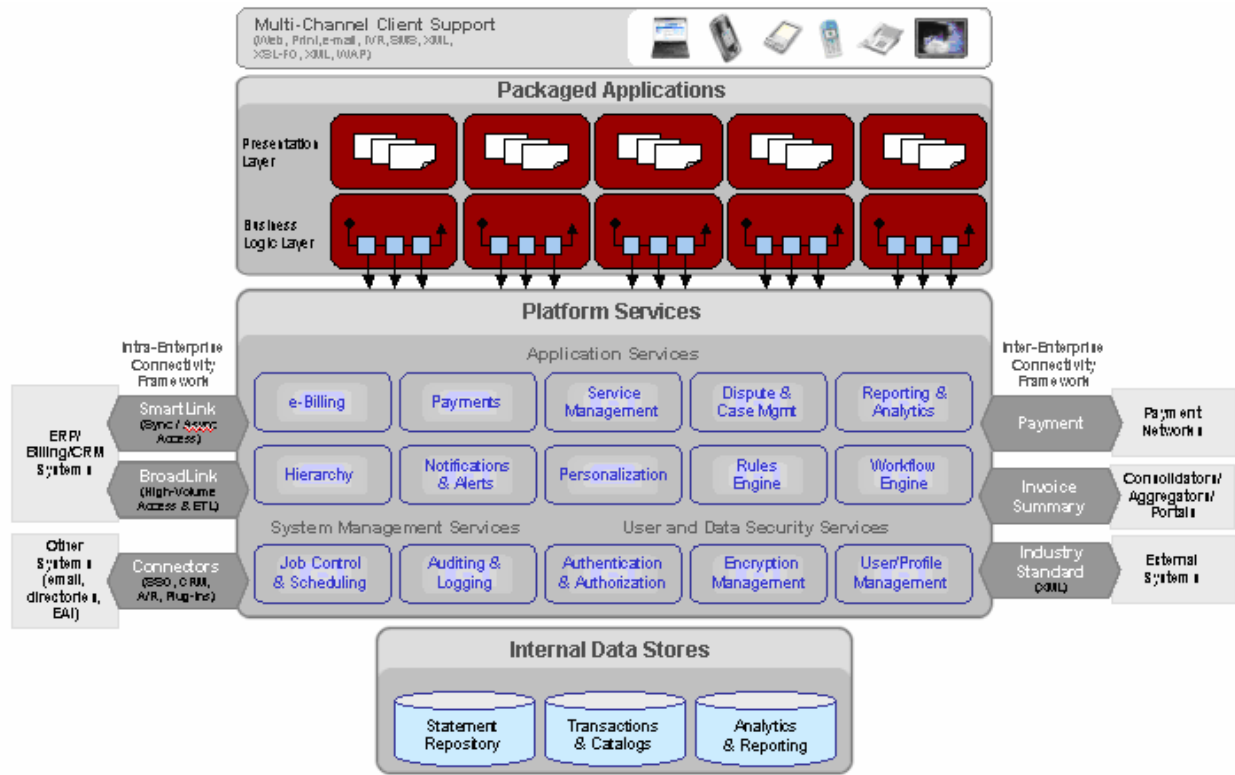

The external interfaces are shown eXtensible Multi-channel Architecture (XMA) diagram, above.

These components are customized through the configuration and generation of lower level components within a J2EE infrastructure, including JSP pages, HTML templates, JavaBeans, Struts action classes, Tiles, and Java-based batch processes.

The integration points, as shown in the System Context Diagram in Chapter 2, consist of:

- **Billing data files** – Generated by the billing system following the monthly billing cycle and transferred into an input directory on the IFS system.
- **Daily billing data files** – Generated by the A/R system on a daily basis to provide daily updates to customer accounts.
- **Payment data** – Generated by the system by a scheduled process and transferred to the payment processor.
- **Payment status data** – Generated by the payment processor and returned to the system.
- **A/R payments data** – Generated by the A/R system on processing customer payments.
- **A/R payments reconciliation file** – Generated by the system by a scheduled process and transferred to the A/R system.

Data Files

The Billing Manager application can receive billing data in a variety of formats. The Siebel application can take print composition formats, raw billing table extracts and other well-structured legacy formats. This data is loaded into the Siebel application using a batch scheduling process that is configurable based on specified business rules.

ACH Files

Billing Manager provides connections to payment networks. Real-time and batch interfaces to ACH, Credit Card, and proprietary networks using a cartridge based approach yields complete payment flexibility.

A/R Files

Billing Manager integrates with your existing infrastructure, updating accounts receivable systems with remittance information, and supports reconciliation processes. Billing Manager includes XML-based API's for integration into backend systems.

New Standards and Best Practices

Java 2 Enterprise Edition (J2EE) has become a standard platform for developing enterprise-class web-based solutions. It is well-suited for internet-based applications because it provides many of the underlying services such as the Java Servlet API (for servicing HTTP requests), EJB (for transaction processing), and Java Message Service (for messaging) among others.

J2EE is a more mature and robust technology and is complex. Internet application developers would fail to realize the many benefits promised by J2EE (such as reusability, extensibility, flexibility, scalability etc.) without having a solid understanding of the corresponding technology, and more importantly, a viable application framework upon which the solution is developed.

Siebel Billing Manager Architecture is the foundation upon which applications may exploit the J2EE design and development best practices.

One of the guiding principles for the Billing Manager Architecture for web-based application is Jakarta Struts. Its architecture and its application to the Siebel suite of products are based on the MVC design pattern. It is a framework by which integrators may deploy web-based application at record speed, with greater re-usability and extensibility, better quality, and better performance.

References

Here are several sources of additional information on the technologies used in the Billing Manager framework:

- The Jakarta Struts web site: <http://jakarta.apache.org/struts/>
- An article on using Struts1.1 features:
<http://www.onjava.com/pub/a/onjava/2002/10/30/jakarta.html?page=1>
- The book *Programming Jakarta Struts* by Chuck Cavaness
- An article explaining the synchronizer token concept:
<http://www.javaworld.com/javaworld/jvatips/jw-jvatip136.html>
- Four-part tutorial on Tiles:
http://www.onjava.com/pub/a/onjava/excerpt/progjakstruts_14/index1.html
http://www.onjava.com/pub/a/onjava/excerpt/progjakstruts_14/index2.html
http://www.onjava.com/pub/a/onjava/excerpt/progjakstruts_14/index3.html
http://www.onjava.com/pub/a/onjava/excerpt/progjakstruts_14/index4.html
- Log4j Web Site: <http://jakarta.apache.org/log4j/docs/index.html>
- Core J2EE Patterns: *Best Practices and Design Strategies* by Deepak Alur, John Crupi, Dan Malks

Background

Many web-based applications today, especially those based on J2EE, can be described in terms of their tiers. The application's functionality is separated across these tiers, to provide separation of responsibility and to promote reusability, maintainability, improved scalability and many other benefits.

A brief overview of the J2EE architecture with its multi-tiered components gives the reader a basic understanding of the technology and also describes how the struts components map onto the J2EE application framework.

The J2EE Platform

The J2EE platform provides a component-based approach to implement a multi-tiered software architecture. The components that make up the architecture are executed in run-time environment called containers. Containers are used to provide infrastructure-type services such as memory management, transaction management, security etc. In a web-based environment, the majority of the software resides in two containers, the Web container and the EJB container, running inside of the application server.

The J2EE components are divided into 3 tiers as shown below:

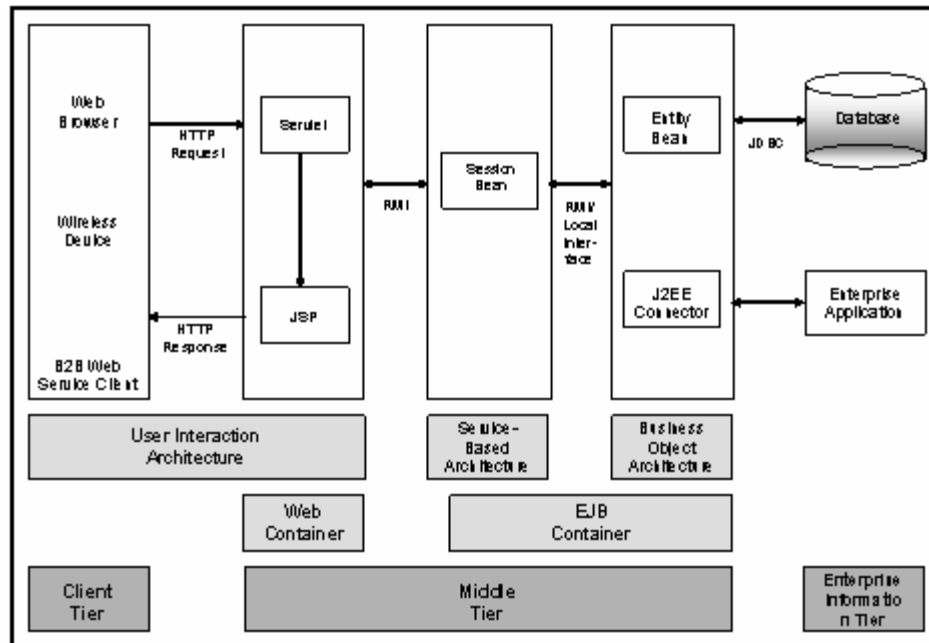

The function of the Web container is to process client requests and generate responses, while the function of the EJB container is to implement the business logic of the application.

The Model-View-Controller Approach

The Model 2 architecture is based on the Model-View-Controller design pattern. MVC is the cornerstone of web-based application development best practices. The patterns are defined as follows:

- **View:** The screen presented to the users
- **Controller:** The component that controls the flow and processing of user actions
- **Model:** The application business logic components

The figure below shows a complete picture of how objects in the MVC framework are mapped to the J2EE architecture:

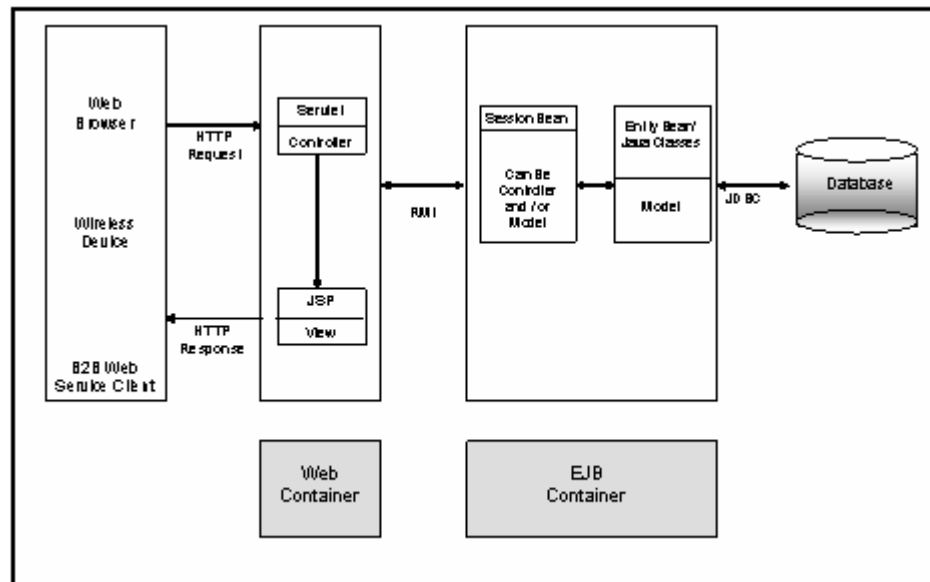

It is important to note that MVC is only a software pattern and does not restrict where components live within the architecture. There are a number of variations of how the MVC pattern can be applied to web-based applications. As can be seen in the figure above, the Controller component can have different functions on the different tiers. A controller component in the Web tier can be used for processing HTTP requests such as form submissions and navigation links. Controller components on the EJB tier can control the flow of the application functionality.

Figure below shows one variation of the MVC pattern in a web-based application:

External Interfaces

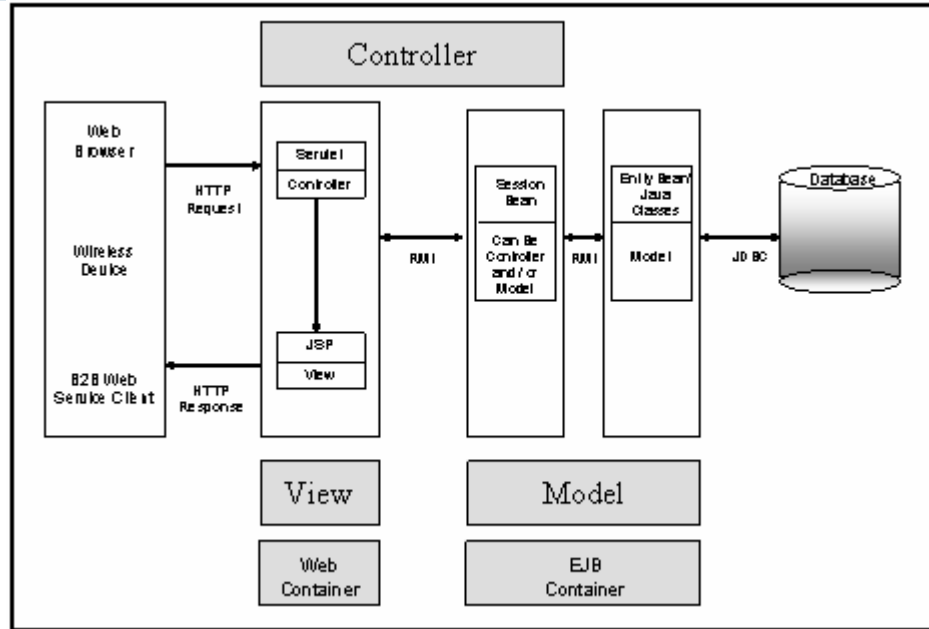

The Billing Manager framework enables speedy deployment of web applications using the Siebel product line. Billing Manager has been developed using the Jakarta Struts and Tiles frameworks.