

**Oracle® Retail Merchandising**

Batch Schedule

Release 15.0.3

F19068-01

May 2019

Copyright © 2019, Oracle. All rights reserved.

Primary Author: Nathan Young

This software and related documentation are provided under a license agreement containing restrictions on use and disclosure and are protected by intellectual property laws. Except as expressly permitted in your license agreement or allowed by law, you may not use, copy, reproduce, translate, broadcast, modify, license, transmit, distribute, exhibit, perform, publish, or display any part, in any form, or by any means. Reverse engineering, disassembly, or decompilation of this software, unless required by law for interoperability, is prohibited.

The information contained herein is subject to change without notice and is not warranted to be error-free. If you find any errors, please report them to us in writing.

If this is software or related documentation that is delivered to the U.S. Government or anyone licensing it on behalf of the U.S. Government, then the following notice is applicable:

U.S. GOVERNMENT END USERS: Oracle programs, including any operating system, integrated software, any programs installed on the hardware, and/or documentation, delivered to U.S. Government end users are "commercial computer software" pursuant to the applicable Federal Acquisition Regulation and agency-specific supplemental regulations. As such, use, duplication, disclosure, modification, and adaptation of the programs, including any operating system, integrated software, any programs installed on the hardware, and/or documentation, shall be subject to license terms and license restrictions applicable to the programs. No other rights are granted to the U.S. Government.

This software or hardware is developed for general use in a variety of information management applications. It is not developed or intended for use in any inherently dangerous applications, including applications that may create a risk of personal injury. If you use this software or hardware in dangerous applications, then you shall be responsible to take all appropriate fail-safe, backup, redundancy, and other measures to ensure its safe use. Oracle Corporation and its affiliates disclaim any liability for any damages caused by use of this software or hardware in dangerous applications.

Oracle and Java are registered trademarks of Oracle and/or its affiliates. Other names may be trademarks of their respective owners.

Intel and Intel Xeon are trademarks or registered trademarks of Intel Corporation. All SPARC trademarks are used under license and are trademarks or registered trademarks of SPARC International, Inc. AMD, Opteron, the AMD logo, and the AMD Opteron logo are trademarks or registered trademarks of Advanced Micro Devices. UNIX is a registered trademark of The Open Group.

This software or hardware and documentation may provide access to or information about content, products, and services from third parties. Oracle Corporation and its affiliates are not responsible for and expressly disclaim all warranties of any kind with respect to third-party content, products, and services unless otherwise set forth in an applicable agreement between you and Oracle. Oracle Corporation and its affiliates will not be responsible for any loss, costs, or damages incurred due to your access to or use of third-party content, products, or services, except as set forth in an applicable agreement between you and Oracle.

## Value-Added Reseller (VAR) Language

### Oracle Retail VAR Applications

The following restrictions and provisions only apply to the programs referred to in this section and licensed to you. You acknowledge that the programs may contain third party software (VAR applications) licensed to Oracle. Depending upon your product and its version number, the VAR applications may include:

(i) the **MicroStrategy** Components developed and licensed by MicroStrategy Services Corporation (MicroStrategy) of McLean, Virginia to Oracle and imbedded in the MicroStrategy for Oracle Retail Data Warehouse and MicroStrategy for Oracle Retail Planning & Optimization applications.

(ii) the **Wavelink** component developed and licensed by Wavelink Corporation (Wavelink) of Kirkland, Washington, to Oracle and imbedded in Oracle Retail Mobile Store Inventory Management.

(iii) the software component known as **Access Via**™ licensed by Access Via of Seattle, Washington, and imbedded in Oracle Retail Signs and Oracle Retail Labels and Tags.

(iv) the software component known as **Adobe Flex**™ licensed by Adobe Systems Incorporated of San Jose, California, and imbedded in Oracle Retail Promotion Planning & Optimization application.

You acknowledge and confirm that Oracle grants you use of only the object code of the VAR Applications. Oracle will not deliver source code to the VAR Applications to you. Notwithstanding any other term or condition of the agreement and this ordering document, you shall not cause or permit alteration of any VAR Applications. For purposes of this section, "alteration" refers to all alterations, translations, upgrades, enhancements, customizations or modifications of all or any portion of the VAR Applications including all reconfigurations, reassembly or reverse assembly, re-engineering or reverse engineering and recompilations or reverse compilations of the VAR Applications or any derivatives of the VAR Applications. You acknowledge that it shall be a breach of the agreement to utilize the relationship, and/or confidential information of the VAR Applications for purposes of competitive discovery.

The VAR Applications contain trade secrets of Oracle and Oracle's licensors and Customer shall not attempt, cause, or permit the alteration, decompilation, reverse engineering, disassembly or other reduction of the VAR Applications to a human perceivable form. Oracle reserves the right to replace, with functional equivalent software, any of the VAR Applications in future releases of the applicable program.



---

---

# Contents

<b>Send Us Your Comments</b> .....	<b>vii</b>
<b>Preface</b> .....	<b>ix</b>
Audience .....	ix
Related Documents.....	ix
Customer Support.....	ix
Review Patch Documentation.....	x
Improved Process for Oracle Retail Documentation Corrections .....	x
Oracle Retail Documentation on the Oracle Technology Network.....	x
Conventions.....	x
<b>1 Introduction to Merchandising Batch Processing</b> .....	<b>1</b>
Batch Processing.....	1
Types of Batch Programs .....	1
Batch Window .....	2
Batch Schedule and Phases.....	2
Merchandising Batch Schedule.....	2
Program List .....	3
RMS, ReIM, RTM Section .....	4
prepost Program .....	5
Modifications to the Batch Schedule .....	6
<b>2 Program List</b> .....	<b>7</b>
<b>3 Interface Diagrams for RMS and RPAS</b> .....	<b>35</b>
RMS Pre/Post Extract Diagrams .....	36
RMS Foundation Data Extract Diagrams .....	37
RMS Fact Data Extract Diagrams.....	39
RPAS-RMS Fact Load Diagram .....	40
<b>4 Interface Diagrams for RMS and MFP</b> .....	<b>41</b>
RMS Pre/Post Extract Diagrams .....	42
RMS Foundation Data Extract Diagrams .....	43
RMS Fact Data Extract Diagrams.....	45
<b>5 Interface Diagrams for RMS and AIP</b> .....	<b>47</b>
RMS Pre/Post Extract Diagrams .....	49
RMS Foundation Data Extract Diagrams .....	50
<b>6 Interface Diagrams for Allocation, AP and SPO</b> .....	<b>55</b>



---

---

# Send Us Your Comments

Oracle Retail Merchandising Batch Schedule, Release 15.0.3

Oracle welcomes customers' comments and suggestions on the quality and usefulness of this document.

Your feedback is important, and helps us to best meet your needs as a user of our products. For example:

- Are the implementation steps correct and complete?
- Did you understand the context of the procedures?
- Did you find any errors in the information?
- Does the structure of the information help you with your tasks?
- Do you need different information or graphics? If so, where, and in what format?
- Are the examples correct? Do you need more examples?

If you find any errors or have any other suggestions for improvement, then please tell us your name, the name of the company who has licensed our products, the title and part number of the documentation and the chapter, section, and page number (if available).

---

**Note:** Before sending us your comments, you might like to check that you have the latest version of the document and if any concerns are already addressed. To do this, access the new Applications Release Online Documentation CD available on My Oracle Support and [www.oracle.com](http://www.oracle.com). It contains the most current Documentation Library plus all documents revised or released recently.

---

Send your comments to us using the electronic mail address: [retail-doc\\_us@oracle.com](mailto:retail-doc_us@oracle.com)

Please give your name, address, electronic mail address, and telephone number (optional).

If you need assistance with Oracle software, then please contact your support representative or Oracle Support Services.

If you require training or instruction in using Oracle software, then please contact your Oracle local office and inquire about our Oracle University offerings. A list of Oracle offices is available on our Web site at [www.oracle.com](http://www.oracle.com).





---

---

# Preface

This batch schedule document details the integrated cyclical processing schedules for the Oracle Retail Merchandising applications:

- Oracle Retail Merchandising System (RMS)
- Oracle Retail Invoice Matching (ReIM)
- Oracle Retail Price Management (RPM)
- Oracle Retail Sales Audit (ReSA)
- Oracle Retail Trade Management (RTM)
- Oracle Retail Allocation

This guide describes the periodic and ad hoc phases of batch processing, as well as pre- and post-processing dependencies.

## Audience

The audiences for this guide are as follows:

- Systems analysts and system operations personnel who need information about Merchandising processes, internally or in relation to systems across the enterprise
- Integrators and implementation staff who have the overall responsibility for implementing the Merchandising applications in their enterprise

## Related Documents

For more information, see the following documents for the Oracle Retail Merchandising products:

- *Oracle Retail Invoice Matching Operations Guide*
- *Oracle Retail Merchandising System Operations Guide*
- *Oracle Retail Price Management Operations Guide*
- *Oracle Retail Sales Audit Operations Guide*

## Customer Support

To contact Oracle Customer Support, access My Oracle Support at the following URL:

<https://support.oracle.com>

When contacting Customer Support, please provide the following:

- Product version and program/module name
- Functional and technical description of the problem (include business impact)
- Detailed step-by-step instructions to re-create
- Exact error message received
- Screen shots of each step you take

## Review Patch Documentation

When you install the application for the first time, you install either a base release (for example, 15.0) or a later patch release (for example, 15.0.3). If you are installing the base release or additional patch releases, read the documentation for all releases that have occurred since the base release before you begin installation. Documentation for patch releases can contain critical information related to the base release, as well as information about code changes since the base release.

## Improved Process for Oracle Retail Documentation Corrections

To more quickly address critical corrections to Oracle Retail documentation content, Oracle Retail documentation may be republished whenever a critical correction is needed. For critical corrections, the republication of an Oracle Retail document may at times **not** be attached to a numbered software release; instead, the Oracle Retail document will simply be replaced on the Oracle Technology Network Web site, or, in the case of Data Models, to the applicable My Oracle Support Documentation container where they reside.

This process will prevent delays in making critical corrections available to customers. For the customer, it means that before you begin installation, you must verify that you have the most recent version of the Oracle Retail documentation set. Oracle Retail documentation is available on the Oracle Technology Network at the following URL:

<http://www.oracle.com/technetwork/documentation/oracle-retail-100266.html>

An updated version of the applicable Oracle Retail document is indicated by Oracle part number, as well as print date (month and year). An updated version uses the same part number, with a higher-numbered suffix. For example, part number E123456-02 is an updated version of a document with part number E123456-01.

If a more recent version of a document is available, that version supersedes all previous versions.

## Oracle Retail Documentation on the Oracle Technology Network

Documentation is packaged with each Oracle Retail product release. Oracle Retail product documentation is also available on the following Web site:

<http://www.oracle.com/technetwork/documentation/oracle-retail-100266.html>

(Data Model documents are not available through Oracle Technology Network. These documents are packaged with released code, or you can obtain them through My Oracle Support.)

## Conventions

**Navigate:** This is a navigate statement. It tells you how to get to the start of the procedure and ends with a screen shot of the starting point and the statement “the Window Name window opens.”

This is a code sample

It is used to display examples of code

---

---

# Introduction to Merchandising Batch Processing

This chapter is a brief introduction to Oracle Retail batch processing. It defines basic terms and concepts, describes batch processing phases, and explains how to interpret the batch schedule program list.

## Batch Processing

Batch processing is the execution of a group of batch programs (jobs). The results are returned without user intervention. Batch programs are commonly used for the following reasons:

- To process large volumes of transaction data
- To interface with external systems
- To perform internal maintenance

Batch programs can process very large quantities of data quickly and efficiently. Batch programs can perform some updates that could be performed through online transactions, but much more quickly and with less impact on system performance. Batch processing is usually scheduled for times when systems are idle or least busy.

Batch programs can be run automatically using batch scheduler software. The batch scheduler allows batch jobs to be set up in a specific order, with restrictions attached to any program as needed. If an error occurs with a batch program, an administrator must correct the error and manually rerun the batch program that failed.

## Types of Batch Programs

Oracle Retail batch programs are of several types:

- Upload programs bring data from external systems into the Oracle Retail database. For example, the sales upload program uploads daily transactions that occur at the point of sale (POS) for processing by the Oracle Retail Management System (RMS).
- Download programs extract data from RMS and format it so it can be used by external systems. For example, the posdnld program extracts new and changed information about an item/location for downloading to the point of sale.
- System maintenance programs perform tasks such as updating the system date. For example, the dtesys program increments the system date at the end of each batch cycle.
- Functional maintenance programs process data specific to a functional area. For example, the mrt.pc program creates individual transfers for an approved Mass Return Transfer.

## Batch Window

Because of the impact on production systems, it is not always possible to run batch programs during business hours; however, there is a window of opportunity during each day or night when online systems are not being used. This time frame is the *batch window*. For example, a retailer with stores throughout the continental U.S. might require its online systems to be available from 8 AM Eastern Standard Time, when its East Coast offices open, until 9 PM Pacific Standard Time, when its West Coast stores close. This allows an eight-hour batch window for processing all batch jobs.

## Batch Schedule and Phases

Order is critical when running batch programs. Some tasks need to be performed before others. A batch schedule ensures that every time batch processing is performed, the correct tasks are performed in the proper order.

The batch schedule is a program list with batch phases and pre/post dependencies for each batch job. For each individual user, the schedule is a suggested starting point for the installation. Some programs are specific to products that may not be installed, so these programs may not be used at all.

The total batch schedule is divided into phases. Each phase must be completed before the next phase can begin. Within a phase, there may also be programs that depend on the completion of another program within that phase, so programs within each phase may need to be run in a particular order.

## Merchandising Batch Schedule

The integrated Merchandising batch schedule combines the batch schedules of all Merchandising applications into a single schedule program list. The batch program list (later in this document) shows the batch dependencies among the Merchandising applications.

The integrated Merchandising batch schedule combines the batch modules for the following applications:

- Oracle Retail Merchandising System (RMS)
- Oracle Retail Trade Management (RTM)
- Oracle Retail Sales Audit (ReSA)
- Oracle Retail Invoice Matching (ReIM)
- Oracle Retail Price Management (RPM)
- Oracle Retail Allocation

## Program List

The columns of the program list provide details about each batch program, as follows:

Column	Description
Program name	Name of the program or script
Functional area	Functional area of the application for which the batch program is run
Threaded	Whether the program is threaded (Y/N)
Driver	Program driver
Phase	Phase during which the program is run
Pre-dependency	Programs that must be completed before the program can be run
Post-dependency	Programs that must be run after the program completes successfully
Timing	How often the program is run (for example, daily, weekly, monthly, ad hoc)
Restart/Recovery	Whether the program uses restart/recovery (R=Yes, N=No)
Run Parameters for Program	Command syntax to run the program

For example, the following shows the information in the program list about an RMS phase 3 program named dealday:

Program Name	dealday
Functional Area	Deals
Threaded	Y
Driver	Location
Phase	3
Pre-dependency	dealinc, dealfinc, prepost dealday pre
Post-dependency	prepost dealday post, salmnth
Timing	Monthly
Restart/Recovery	R
Usage	dealday userid/passwd

The program list is grouped in the following order:

- RMS, RTM, and ReSA programs
- RPM programs
- ReIM programs
- Allocation programs
- RMS extracts for Retail Predictive Application Server (RPAS)

The extracts for RPAS are programs that are part of the RMS application.

## RMS, ReIM, RTM Section

The first section diagrams the RMS, ReIM, and RTM programs and their dependencies. This section is further divided into phases 0 through 8, ad hoc, and date set batch.

Each phase must be completed before the next phase can begin. Also, a phase may contain programs that depend on other programs within the phase. Programs within each phase may need to run in a particular sequence.

The following are brief descriptions of the Merchandising batch processing phases. Depending on your implementation, some programs and phases may not apply.

<sup>^</sup>Note - Ad hoc processes are not strictly constrained to one phase of the batch cycle.

Ad hoc jobs may be run multiple times per day in parallel with other operations.

Ad hoc jobs can have dependencies on specific jobs in phases. In these cases, it is presumed that if a transaction misses the current run of the ad hoc job, it will be picked up by the next run.

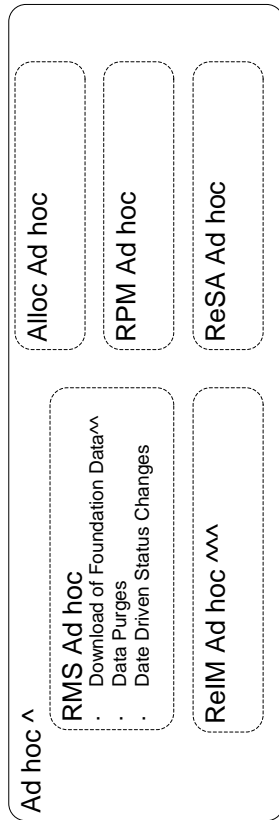

### Integrated Merch Batch Cycle Phase Overview

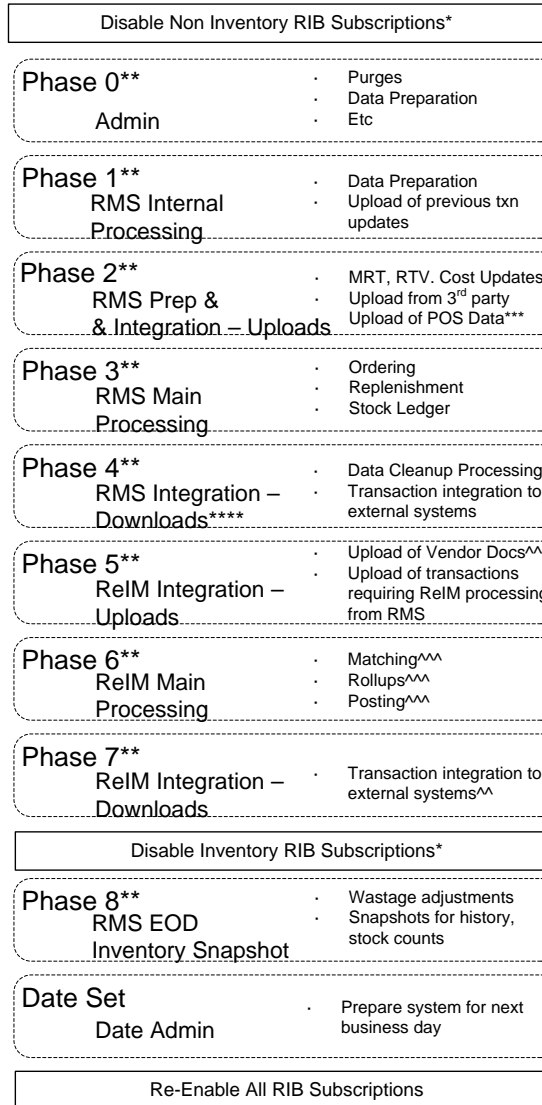

\* Note - See 24x7 Inventory Availability whitepaper in the Merchandising Functional Library (Doc ID: 1585843.1). for more information about which subscriptions are inventory vs non inventory.

\*\* Note - All jobs that belong to a phase must finish before any jobs in the next phase begin.

\*\*\*Note - POS data can be uploaded throughout the day via trickle polling.

If the client does not trickle poll, this is the main POS upload slot.

If the client does trickle poll, sales trickled in after this point may or may not affect inventory related processing like replenishment, depending on when the transactions trickle in. It is assumed that if trickle polling, the vast majority of daily sales have been loaded at this point, resulting in reasonable calculated results.

^^Note - Integration of foundation data can occur ad hoc, but integration of transactions occurs after the RMS batch processes that create transactions

^^^ Note - Most ReIM jobs can be run both ad hoc and in their scheduled phases.

ReIM jobs should be run at a minimum in these scheduled phase positions. Running in these positions ensures that all order, receipt and invoice information from the day is considered.

But some can also be run ad hoc. Running ad hoc during the day or prior to these positions may match/post/etc many documents prior to the batch cycle.

## Abbreviations

In the diagram, abbreviations in parentheses that follow program names have the following meanings:

Abbreviation	Meaning
(perl)	The module is a Perl script.
(FIF)	The module is related to the Financials application.
(sqlldr)	There is a sqlloader process to load/ftp the output files.
(rebuild all)	There is a rebuild process inside the application.
(IM)	The module is related to Invoice Matching but owned by RMS.
(RMS)	The module belongs to RMS.
<b>(RMS)</b>	(Bold type) The RMS module is executed externally to that phase.
(ReSA)	The module belongs to ReSA.
<b>(ReSA)</b>	(Bold type) The ReSA module is executed externally to that phase.
(ReIM)	The module belongs to ReIM.
(RTM)	The module belongs to RTM.
(Weekly)	The module is executed weekly.
(Monthly)	The module is executed monthly.
(Forms Auditing)	This is an online forms auditing process related to ReSA.

## prepost Program

The prepost program facilitates multi-threading by allowing general system administration functions (such as table deletions or mass updates) to be completed after all threads of a particular program have been processed. The prepost program must be run before, after, or both before and after, programs that require specific processing to run or complete successfully.

In the batch schedule program list, the prepost program is indicated by “pre” and “post” entries, as in the following examples.

## Modifications to the Batch Schedule

The integrated Merchandising batch schedule shows the dependencies for all the programs that *could* be run by a retailer. Based on many factors, there will always be some programs that a retailer does not run. Determining which programs, or groups of programs, are not required is a job that should be performed at implementation time.

One major factor involves the applications that the retailer has purchased and wants to install:

- For example, a retailer may have purchased RMS, but not ReIM; in this case, the ReIM programs would not be run.
- Another example is that a retailer may not want to use some functionality within an application. Perhaps a retailer purchased RMS but did not purchase the MFP application. In this case, the retailer may not want to run the programs that extract RMS data to be used later by the MFP application.

These major configuration choices also affect whether some programs are used:

- Whether the Retail Integration Bus (RIB) is used  
For more information about configuring the RIB for Merchandising applications, see “Configuring RPM without the RIB” in the “Backend System Administration and Configuration” chapter of the *Oracle Retail Price Management Operations Guide*.
- Whether full-featured or simplified RTM is used  
For more information about configuring simplified RTM, see the “Oracle Retail Trade Management Batch” chapter in Volume 1 of the *Oracle Retail Merchandising System Operations Guide*.
- Whether 24x7 processing is used



## RMS,RTM Program Dependency and Scheduling Details

Catalog ID	Job Name	Functional Area	Type	Phase	Program Pre-dependency	Program Post-dependency	Dependency/Run Notes	Frequency	Run Parameters for Programs
RMS175	allocbt.ksh	Inventory	Business Processing	ad hoc	N/A	N/A	Can be scheduled multiple times daily. Should be run after RPM price change, clearance and promotion processing	daily	allocbt.ksh [-p <# parallel threads>] <connect> <# parallel threads> is the number of threads to run in parallel. The default is the value on RESTART_CONTROL.NUM_THREADS.
RMS120	ang_prcqtydnld.ksh	Item Maintenance	Integration	ad hoc	RPM	N/A		Daily	
RMS119	ang_proddnld.ksh	Item Maintenance	Integration	ad hoc	dlyprg.pc	N/A		Daily	
RMS162	ang_saplgen.ksh	Foundation Data	Integration	ad hoc	N/A	N/A		Daily	
RMS121	ang_stdnld.ksh	Foundation Data	Integration	ad hoc	N/A	N/A		Daily	
RMS180	async_job_status_retry_cleanup.ksh	Administration	Admin	ad hoc	N/A	N/A	N/A	As needed	async_queue_cleanup.ksh [-t <# days>] <connect> async_job_status_retry_cleanup.ksh <-t #hours> <connect> <-t #hours> represents how old the entries to be cleaned up. Suggested is 72 hours old.
RMS181	async_queue_cleanup.ksh	Administration	Admin	4	N/A	N/A	N/A	As needed	
RMS182	auditprg	Administration	Admin	ad hoc	N/A	N/A	N/A	As needed	auditprg /@Batch_Alias_Name
RMS183	auditsys	Administration	Admin	ad hoc	N/A	N/A	N/A	As needed	auditsys /@Batch_Alias_Name
RMS184	batch_alloctsfupd.ksh	Foundation Data	Business Processing	2	batch_compeffupd.ksh	prepost batch_costcompupd post	The following scripts can be executed in parallel: <input type="checkbox"/> batch_alloctsfupd.ksh <input type="checkbox"/> batch_depchrgupd.ksh <input type="checkbox"/> batch_expprofupd.ksh <input type="checkbox"/> batch_itmcostcompupd.ksh <input type="checkbox"/> batch_ordcostcompupd.ksh  The pre-post job batch_costcompupd post should be run after all 5 complete.  Must be run before the following scripts: <input type="checkbox"/> batch_alloctsfupd.ksh <input type="checkbox"/> batch_expprofupd.ksh <input type="checkbox"/> batch_itmcostcompupd.ksh <input type="checkbox"/> batch_ordcostcompupd.ksh <input type="checkbox"/> batch_depchrgupd.ksh	daily	batch_alloctsfupd.ksh [-p <# parallel threads>] <connect> <# parallel threads> is the number of threads to run in parallel. The default is the value on RESTART_CONTROL.NUM_THREADS.
RMS185	batch_compeffupd.ksh	Foundation Data	Business Processing	2	NA	batch_alloctsfupd.ksh batch_expprofupd.ksh batch_itmcostcompupd.ksh batch_ordcostcompupd.ksh batch_depchrgupd.ksh		daily	batch_compeffupd.ksh <connect>

									The following scripts can be executed in parallel: <input type="checkbox"/> batch_allocsfupd.ksh <input type="checkbox"/> batch_depchrgupd.ksh <input type="checkbox"/> batch_expprofupd.ksh <input type="checkbox"/> batch_itmcostcompupd.ksh <input type="checkbox"/> batch_ordcostcompupd.ksh	
RMS186	batch_depchrgupd.ksh	Foundation Data	Business Processing	2	batch_compeffupd.ksh	prepost batch_costcompupd post		The pre-post job batch_costcompupd post should be run after all 5 complete.	daily	batch_depchrgupd.ksh <connect>
RMS187	batch_ditinsrt.ksh	Deals	Business Processing	1	N/A	orddsct		Run either batch_ditinsrt.ksh or ditinsrt.pc. See detailed program documents for more information The following scripts can be executed in parallel: <input type="checkbox"/> batch_allocsfupd.ksh <input type="checkbox"/> batch_depchrgupd.ksh <input type="checkbox"/> batch_expprofupd.ksh <input type="checkbox"/> batch_itmcostcompupd.ksh <input type="checkbox"/> batch_ordcostcompupd.ksh	daily	
RMS188	batch_expprofupd.ksh	Foundation Data	Business Processing	2	batch_compeffupd.ksh	prepost batch_costcompupd post		The pre-post job batch_costcompupd post should be run after all 5 complete.	daily	batch_expprofupd.ksh <connect> batch_itmcostcompupd.ksh [-p <# parallel threads>] <connect> <# parallel threads> is the number of threads to run in parallel.
RMS189	batch_itmcostcompupd.ksh	Foundation Data	Business Processing	2	batch_compeffupd.ksh	prepost batch_costcompupd post		If none of the Cost Component Updates batch are to be run then, prepost batch_costcompupd post.	daily	The default is the value on RESTART_CONTROL.NUM_THREADS.
					batch_compeffupd.ksh prepost batch_ordcostcompupd pre	prepost batch_ordcostcompupd post		The following scripts can be executed in parallel: <input type="checkbox"/> batch_allocsfupd.ksh <input type="checkbox"/> batch_depchrgupd.ksh <input type="checkbox"/> batch_expprofupd.ksh <input type="checkbox"/> batch_itmcostcompupd.ksh <input type="checkbox"/> batch_ordcostcompupd.ksh		
RMS190	batch_ordcostcompupd.ksh	Foundation Data	Business Processing	2	prepost batch_ordcostcompupd pre	prepost batch_costcompupd post		The pre-post job batch_costcompupd post should be run after all 5 complete.	daily	ch_ordcostcompupd.ksh [-p <# parallel threads>] <connect> <# parallel threads> is the number of threads to run in parallel. The default is the value on RESTART_CONTROL.NUM_THREADS.
RMS19	batch_orpos_extract.ksh	Integration - Oracle Retail POS Suite	Integration	4	RPM - RPMtoORPOSPublishExport.sh rplatup repladj	prepost batch_orpos_extract post		If RPM pricing info is reqd then run after extraction script 'RPMtoORPOSPublishExport.sh' Run either batch_reqext.ksh or reqext.pc. See detailed program documents for more information	daily	batch_orpos_extract.ksh /@Batch_Alias_Name [-p <no. of threads>] [DIR - location where extracts are to be generated]
RMS192	batch_reqext.ksh	Replenishment	Admin	3	prepost reqext pre	prepost reqext post rplext.ksh			daily	batch_reqext.ksh /@Batch_Alias_Name partition_position
RMS193	batch_rfmcurrconv.ksh	Foundation Data	Admin	ad hoc	NA	NA			daily	batch_rfmcurrconv.ksh <connect>

								This batch should be run only for Global Tax (GTAX) configuration.	
RMS194	batch_rplapprvgtax	Replenishment	Business Processing	3	rplapprv	N/A		This program should run directly after the replenishment rplapprv program. It is important that this program runs before any other process affects the generated orders.	daily batch_rplapprvgtax.ksh [-p <# parallel threads>] <connect> <# parallel threads> is the number of threads to run in parallel. The default is the value on RESTART_CONTROL.NUM_THREADS.
RMS53	cednld	Oracle Retail Trade Management	Integration	2	N/A	N/A		This batch needs to be scheduled to run when the rtm_simplified_ind in SYSTEM_OPTIONS table is set to 'Y'.	daily cednld /@Batch_Alias_Name broker file_name
RMS198	cmpprg	Competitive Pricing	Admin	ad hoc	N/A	N/A			daily cmpprg /@Batch_Alias_Name
RMS61	cmpupld	Competitive Pricing	Integration	ad hoc	N/A	RPM Batch		All RPM batch modules should run after this job All Replenishment modules should run after this program (and all replenishment is later than phase 0)	daily cmpupld /@Batch_Alias_Name input_file reject_file
RMS200	cntrmain	Contracts	Admin	0	N/A	N/A		This module only needs to be scheduled if the client uses contracting.	daily cntrmain /@Batch_Alias_Name
RMS201	cntrordb	Contracts	Business Processing	3	rpladj	prepost cntrordb post		This module only needs to be scheduled if the client uses contracting. This module only needs to be scheduled if the client uses contracting.	daily cntrordb /@Batch_Alias_Name
RMS202	cntrprss	Contracts	Business Processing	3	rplext	rplbld		This module only needs to be scheduled if the client uses contracting.	daily cntrprss /@Batch_Alias_Name
RMS203	costeventprg.pc	Future Cost	Admin	0	N/A	N/A			daily costeventprg /@Batch_Alias_Name
RMS204	cremhierdly	Foundation Data	Business Processing	4	N/A	reclsdly			daily cremhierdly /@Batch_Alias_Name
RMS205	customer_order_purge.ksh	Purchase Orders	Admin	ad hoc	tsfprg ordprg	N/A			monthly customer_order_purge.ksh /@Batch_Alias_Name
					salstage prepost dealact_nor pre prepost dealact_po_pre prepost dealact_sales pre			Must be run daily after SALSTAGE.PC. Otherwise data will be lost and income cannot be calculated retrospectively.	
RMS206	dealact	Deals	Business Processing	3		N/A			daily dealact /@Batch_Alias_Name
RMS207	dealcls	Deals	Admin	4	N/A	prepost dealcls post			daily dealcls /@Batch_Alias_Name
RMS208	dealday	Deals	Business Processing	3	dealinc prepost dealday pre	prepost dealday post		salmnth is a post dependency (noted in the preposr post job) Dealinc should run before this job. Noted as a predependency of the related prepost pre job.	monthly dealday /@Batch_Alias_Name
RMS209	dealfct	Deals	Business Processing	3	prepost dealfct pre	prepost dealfct post			daily dealfct /@Batch_Alias_Name [Y/N - EOM processing ind]
RMS65	dealfinc	Integration - General Ledger	Integration	3	dealact dealact	dealfct dealfct salmth			weekly/ as needed dealfinc /@Batch_Alias_Name dealinc /@Batch_Alias_Name [Y/N -EOM processing ind]
RMS211	dealinc	Deals	Business Processing	3	prepost dealinc pre	salmth		salmnth is a post dependency at EOM	monthly dealinc /@Batch_Alias_Name
RMS212	dealprg	Deals	Admin	ad hoc	N/A	N/A			monthly dealprg /@Batch_Alias_Name
RMS42	dealupld	Deals	Integration	0	N/A	N/A		(SQL*Load the output file)	daily dealupld /@Batch_Alias_Name input_file reject_file
RMS214	dfrtbld	Foundation Data	Business Processing	8	uploadsales_all.ksh				daily dfrtbld /@Batch_Alias_Name outfile
RMS215	discotbapply	Deals	Business Processing	4	orddsct	N/A			daily discotbapply /@Batch_Alias_Name

RMS216	distropcpub	Transfers, Allocations, and RTV	Integration	4	RPM - PriceEventExecutionBatch	N/A	Predependency is an RPM batch process	daily	distropcpub /@Batch_Alias_Name
RMS217	ditinsrt	Deals Administration	Business Processing Admin	1	N/A	orddsct	Run either batch_ditinsrt.ksh or ditinsrt.pc. See detailed program documents for more information	daily	ditinsrt /@Batch_Alias_Name (P or S)
RMS218	dlyprg			0	N/A	prepost dlyprg post wfordcls wfretcls		daily	dlyprg /@Batch_Alias_Name
RMS219	docclose	Transfers, Allocations, and RTV	Business Processing	ad hoc	prepost docclose pre tsfclose	prepost tsfprg pre ordprg		daily	docclose /@Batch_Alias_Name
RMS220	dtesys	Administration	Admin	date_set	sastdycr			daily	dtesys /@Batch_Alias_Name [indate--YYYYMMDD format]
RMS221	dummyctn	Transfers, Allocations, and RTV	Business Processing	ad hoc	N/A	N/A		daily	dummyctn /@Batch_Alias_Name edidladd /@Batch_Alias_Name ediadd_output
RMS44	edidladd	Foundation Data	Integration	ad hoc	N/A	N/A		As needed	ediadd_catalog
RMS45	edidlcon	Contracts	Integration	4	N/A	N/A		daily	edidlcon /@Batch_Alias_Name edidlcon_outfile
RMS127	edidlinv	Invoice Matching	Integration	4	N/A	N/A		Daily	edidlinv /@Batch_Alias_Name output_filename
RMS46	edidlord	Purchase Orders	Integration	4	ordrev	N/A		daily	edidlord /@Batch_Alias_Name filename
RMS47	edidlprd	Inventory	Integration	8	prepost edidlprd pre	prepost edidlprd post		daily	edidlprd /@Batch_Alias_Name filename
RMS48	ediupack	Purchase Orders	Integration	1	N/A	N/A		daily	ediupack /@Batch_Alias_Name data_file reject_file
RMS49	ediupadd	Foundation Data	Integration	2	N/A	prepost ediupadd post		As needed	ediupadd /@Batch_Alias_Name input_file reject_file
RMS50	ediupavl	Contracts	Integration	1	N/A	N/A	This module only needs to be scheduled if the client uses contracting. This batch should run after all cost component scripts and their corresponding prepost jobs have finished execution: • batch_allctsfupd.ksh • batch_deptchrgupd.ksh • batch_expprofupd.ksh • batch_itemcostcompupd.ksh • batch_ordcostcompupd.ksh • Prepost batch_costcompupd post	daily	ediupavl /@Batch_Alias_Name input_file reject_file
RMS222	elcexcpgrg	Foundation Data	Admin	2	Prepost batch_costcompupd post	N/A		daily	elcexcpgrg /@Batch_Alias_Name ./export_diffgrp.ksh \$UP <mode>
	export_diffgrp.ksh	Foundation Data	Integration	ad hoc	N/A	N/A		daily	Note: mode - either 'full' or 'delta' ./export_diffs.ksh \$UP <mode>
	export_diffs.ksh	Foundation Data	Integration	ad hoc	N/A	N/A	This batch will only extract items wherein the Item hdr details are already extracted (through export_itemmaster.ksh).	daily	Note: mode - either 'full' or 'delta' ./export_itemloc.ksh \$UP <mode> <thread indicator> <# of parallel threads> <location>
	export_itemloc.ksh	Foundation Data	Integration	ad hoc	export_itemmaster.ksh	N/A		daily	Notes: mode - either 'full' or 'delta' thread indicator - either 'Y' or 'N'. Indicates if user will provide a thread number. # of parallel threads - number of threads to run in parallel if thread indicator is 'Y'. It should be a number between 1-20, Optional location - a specific location number to create a flat file for, Optional

	export_itemmaster.ksh	Foundation Data	Integration	ad hoc	N/A	N/A		daily	<p>./export_itemmaster.ksh \$SUP &lt;mode&gt; &lt;thread indicator&gt; &lt;# of parallel threads&gt; &lt;store&gt;</p> <p>Notes:  mode - either 'full' or 'delta'  thread indicator - either 'Y' or 'N'. Indicates if user will provide a thread number.  # of parallel threads - number of threads to run in parallel if thread indicator is 'Y'. It should be a number between 1-20, Optional  store - a specific store number to create a location level file for. This is optional and only valid for a full extract.</p>
	export_itemvat.ksh	Foundation Data	Integration	ad hoc	export_itemmaster.ksh	N/A		daily	<p>./export_itemvat.ksh \$SUP &lt;mode&gt; &lt;thread indicator&gt; &lt;# of parallel threads&gt; &lt;store&gt;</p> <p>Notes:  mode - either 'full' or 'delta'  thread indicator - either 'Y' or 'N'. Indicates if user will provide a thread number.  # of parallel threads - number of threads to run in parallel if thread indicator is 'Y'. It should be a number between 1-20, Optional  store - a specific store number to create a location level file for. This is optional and only valid for a full extract.</p>
	export_merchhier.ksh	Foundation Data	Integration	ad hoc	N/A	N/A		daily	<p>./export_merchhier.ksh \$SUP &lt;mode&gt;</p> <p>Note:  mode - either 'full' or 'delta'</p>
	export_orghier.ksh	Foundation Data	Integration	ad hoc	N/A	N/A		daily	<p>./export_orghier.ksh \$SUP &lt;mode&gt;</p> <p>Note:  mode - either 'full' or 'delta'</p>
	export_relitem.ksh	Foundation Data	Integration	ad hoc	export_itemmaster.ksh	N/A		daily	<p>./export_relitem.ksh \$SUP &lt;mode&gt; &lt;thread indicator&gt; &lt;# of parallel threads&gt; &lt;store&gt;</p> <p>Notes:  mode - either 'full' or 'delta'  thread indicator - either 'Y' or 'N'. Indicates if user will provide a thread number.  # of parallel threads - number of threads to run in parallel if thread indicator is 'Y'. It should be a number between 1-20, Optional  store - a specific store number to create a location level file for. This is optional and only valid for a full extract.</p>
	export_stg_purge.ksh	Foundation Data	Integration		N/A	N/A		weekly	
	export_stores.ksh	Foundation Data	Integration	ad hoc	N/A	N/A		daily	<p>./export_stores.ksh \$SUP &lt;mode&gt;</p> <p>Note:  mode - either 'full' or 'delta'</p>
	export_vat.ksh	Foundation Data	Integration	ad hoc	N/A	N/A		daily	<p>./export_vat.ksh \$SUP &lt;mode&gt;</p> <p>Note:  mode - either 'full' or 'delta'</p>
RMS223	fcexec	Future Cost	Business Processing	2	fcthreadexec prepost fcexec pre	N/A		daily	<p>fcexec /@Batch_Alias_Name</p> <p>This program only needs to be scheduled if the client uploads franchise cost information from an external system.</p>
RMS224	fcosttmplprocess.ksh	Franchise Management	Business Processing	ad hoc	fcosttmplupld.ksh	N/A		daily	
RMS225	fcosttmplpurge.ksh	Franchise Management	Admin	ad hoc	N/A	N/A		daily	
RMS125	fcosttmplupld.ksh	Franchise Management	Integration	ad hoc	N/A	fcosttmplupld.ksh		daily	
RMS227	fcstprg	Integration - Planning	Admin	ad hoc	prepost fcstprg pre	prepost fcstprg post		daily	fcstprg /@Batch_Alias_Name domain

RMS228	fcstrbld	Integration - Planning	Business Processing	3	N/A	prepost fcstrbld post	weekly	fcstrbld /@Batch_Alias_Name
RMS229	fcstrbld_sbc	Integration - Planning	Business Processing	3	prepost fcstrbld post	N/A	weekly	fcstrbld_sbc /@Batch_Alias_Name
RMS230	fcthreadexec	Future Cost Integration - General Ledger	Business Processing	2	batch_itmcostcompupd.ksh salstage	prepost fcexec pre	Daily	fcthreadexec /@Batch_Alias_Name
RMS66	fifglnd1	Integration - General Ledger	Integration	3		salapnd	daily	fifglnd1 /@Batch_Alias_Name
RMS67	fifglnd2	Integration - General Ledger	Integration	3	salstage	salapnd	daily	fifglnd2 /@Batch_Alias_Name
RMS68	fifglnd3	Integration - General Ledger	Integration	3	salmth	N/A	monthly	fifglnd3 /@Batch_Alias_Name
RMS15	ftmednld	Integration - Planning	Integration	ad hoc	N/A	N/A	daily	ftmednld /@Batch_Alias_Name
RMS43	gcupld	Foundation Data	Integration	ad hoc	N/A	N/A	As needed	gcupld <username/password@environment> <infile>
RMS237	genpreiss	Purchase Orders	Admin	ad hoc	N/A	N/A	As needed	<outfile> genpreiss /@Batch_Alias_Name
RMS133	gradupld	Integration - Planning	Integration	ad hoc	N/A	N/A	As needed	gradupld /@Batch_Alias_Name input_file rej_file
RMS239	hstbld	Sales History	Business Processing	8	salesprocess.ksh	hstbld_diff	weekly	hstbld /@Batch_Alias_Name level(weekly)
RMS239	hstbld	Sales History	Business Processing	8	salesprocess.ksh prepost hstbld pre (for rebuild all)	prepost hstbld post (for rebuild all)	As needed	hstbld /@Batch_Alias_Name level(rebuild)
RMS240	hstbld_diff	Sales History	Business Processing	8	hstbld	N/A	weekly	hstbld_diff /@Batch_Alias_Name
								Normal weekly run. Dependencies vary depending on if it is a normal weekly or upon request run. Upon request run. Dependencies vary depending on if it is a normal weekly or upon request run. Can additionally be run upon request
								Must run after complete monthly sales have been updated by Sales Upload program.  Also, should be re-run on demand when a sales rolup request has been given for a given dept, class and subclass.
								This program may be run in parallel with hstbld since they both read from HIST_REBUILD_MASK. The table HIST_REBUILD_MASK table must not be truncated by associated prepost post jobs before both programs finish running.
RMS241	hstbldmth	Sales History	Business Processing	8	hstbld	prepost hstbldmth post	Monthly	hstbldmth /@Batch_Alias_Name level(monthly/rebuild)
RMS242	hstbldmth_diff	Sales History	Business Processing	8	hstbld_diff		Monthly	hstbldmth_diff /@Batch_Alias_Name
								Must be run only at EOM date The program should be run on the last day of the month. refeodinventory.ksh must run successfully prior to execution to ensure that ITEM_LOC_SOH_EOD is up-to-date.
RMS158	hstmthupd	Sales History	Business Processing	8	refeodinventory.ksh	hstmthupd.ctl	Monthly	hstmthupd /@Batch_Alias_Name (out_file)
RMS244	hstprg	Sales History	Admin	ad hoc	N/A	N/A	Monthly	hstprg /@Batch_Alias_Name
RMS245	hstprg_diff	Sales History	Admin	ad hoc	N/A	N/A	Monthly	hstprg_diff /@Batch_Alias_Name
								Should be run after hstbld_diff.pc.

RMS159	hstwkupd	Sales History	Business Processing	8	refeodinventory.ksh	hstwkupd.ctl		Weekly	hstwkupd /@Batch_Alias_Name (out_file)
RMS247	hts_240_to_2400	Oracle Retail Trade Management	Integration	ad hoc	N/A	htsupld		As needed	
RMS41	htsupld	Oracle Retail Trade Management	Integration	ad hoc	hts240_to_2400 ushts2rms prepost htsupld pre ibexpl replext	N/A		As needed	htsupld /@Batch_Alias_Name input_file reject_file country_id ; perl hts_240_to_2400 inputfile outputfile ; perl ushts2rms inputfile outputfile rejectfile
RMS249	ibcalc	Replenishment	Business Processing	3	prepost ibcalc pre	rplbld		Daily	ibcalc /@Batch_Alias_Name
RMS250	ibexpl	Replenishment	Processing	3	rplext	ibcalc		Daily	ibexpl /@Batch_Alias_Name
RMS251	invaprg	Inventory	Admin	ad hoc	N/A	N/A		monthly	invaprg /@Batch_Alias_Name
RMS252	invclshp	Invoice Matching	Admin	2	N/A	N/A		Daily	invclshp /@Batch_Alias_Name
RMS253	invprg	Invoice Matching	Admin	ad hoc	ordprg	N/A		monthly	invprg /@Batch_Alias_Name
RMS57	lcadnld	Oracle Retail Trade Management	Integration	4	N/A	lcmt700		daily	lcadnld /@Batch_Alias_Name output_file
RMS199	ld_iindfiles.ksh	Item Maintenance	Integration	ad hoc	N/A	N/A		daily	N/A
RMS255	lclrbld	Foundation Data	Business Processing	ad hoc	N/A	N/A		daily	lclrbld /@Batch_Alias_Name
RMS56	lcmdnld	Oracle Retail Trade Management	Integration	4	N/A	lcmt707		daily	lcmdnld /@Batch_Alias_Name output_file.
RMS136	lcmt700	Oracle Retail Trade Management	Integration	4	lcadnld	N/A		daily	
RMS137	lcmt707	Oracle Retail Trade Management	Integration	4	lcmdnld	N/A		daily	
RMS138	lcmt730	Oracle Retail Trade Management	Integration	2	N/A	lcupld		daily	LCMT730 should run prior to Letter of Credit upload program (lcupld.pc).  This script does not need to be scheduled when the rtm_simplified_ind in SYSTEM_OPTIONS table is set to 'Y'.

refeodinventory.ksh must run successfully prior to execution to ensure that ITEM\_LOC\_SOH\_EOD is up-to-date.

When import\_ind from SYSTEM\_OPTIONS table is 'Y', then this batch program needs to be scheduled.

Hts240\_to\_2400 and Ushts2rms are file transformation perl scripts used to create the appropriate upload files  
This program only needs to be scheduled if the client uses Investment Buy functionality.

The program should run after ordprg.pc  
This batch does not need to be scheduled to run when the rtm\_simplified\_ind in SYSTEM\_OPTIONS table is set to 'Y'.

This batch does not need to be scheduled when the rtm\_simplified\_ind in SYSTEM\_OPTIONS table is set to 'Y'.

LCMT730 should run prior to Letter of Credit upload program (lcupld.pc).

This script does not need to be scheduled when the rtm\_simplified\_ind in SYSTEM\_OPTIONS table is set to 'Y'.

								LCMT798 should be run prior to the Letter of Credit charges and drawings upload program (LCUP798.PC).		
								This script does not need to be scheduled when the rtm_simplified_ind in SYSTEM_OPTIONS table is set to 'Y'.		
RMS139	lcmt798	Oracle Retail Trade Management	Integration	2	N/A	lcup798.pc		Should be run after the lcmt798 Perl script	daily	
								This batch does not need to be scheduled when the rtm_simplified_ind in SYSTEM_OPTIONS table is set to 'Y'.		
RMS54	lcup798	Oracle Retail Trade Management	Integration	2	lcmt798	N/A			daily	lcup798 /@Batch_Alias_Name input_file rej_file
								This batch does not need to be scheduled when the rtm_simplified_ind in SYSTEM_OPTIONS table is set to 'Y'.		
RMS55	lcupld	Oracle Retail Trade Management	Integration	2	lcmt730	N/A			daily	lcupld /@Batch_Alias_Name input_file rej_file
RMS150	lifstkup	Stock Count Transfers, Allocations, and RTV	Integration	1	WMS job (inv_bal_upload.sh)	stockcountupload.ksh stockcountprocess.ksh			daily	lifstkup /@Batch_Alias_Name input_file output_file
RMS273	mrt	Transfers, Allocations, and RTV	Business Processing	2	N/A	mrtrtv			daily	mrt /@Batch_Alias_Name
RMS274	mrtprg	Transfers, Allocations, and RTV	Admin	ad hoc	N/A	N/A			daily	mrtprg /@Batch_Alias_Name
RMS275	mrtrtv	Transfers, Allocations, and RTV	Business Processing	2	mrt	mrtupd			daily	mrtrtv /@Batch_Alias_Name
RMS276	mrtupd	Transfers, Allocations, and RTV	Admin	2	mrtrtv	N/A			daily	mrtupd /@Batch_Alias_Name
RMS277	nwppurge	Stock Ledger	Admin	ad hoc	N/A	N/A		Only required in specific markets (e.g. Germany)	Annually	nwppurge /@Batch_Alias_Name
RMS278	nwpyearend	Stock Ledger	Business Processing	8	refeodinventory.ksh	N/A		run on last day of year in specific markets (e.g. Germany)	Annually	nwpyearend /@Batch_Alias_Name
RMS128	onictext	Integration - Planning	Integration	4	onordext	onorddnld			weekly	onictext /@Batch_Alias_Name datefile
RMS12	onorddnld	Integration - Planning	Integration	4	onordext.pc, onictext.pc	N/A			daily	onorddnld /@Batch_Alias_Name
RMS129	onordext	Integration - Planning	Integration	4	prepost onordext pre	onictext			daily	onordext /@Batch_Alias_Name datefile
RMS282	ordautcl	Purchase Orders	Admin	ad hoc	N/A	N/A			daily	ordautcl /@Batch_Alias_Name
RMS283	orddsct	Purchase Orders	Business Processing	4	ditinsrt sccext reclsdly	discofbapply dealcls			daily	orddsct /@Batch_Alias_Name ordinvupld /@Batch_Alias_Name input_file reject_file lock_file
RMS113	ordinvupld	Inventory	Integration	2	saordinvexp	N/A			daily	
RMS285	ordprg	Purchase Orders	Admin	ad hoc	N/A	wftrnprg			monthly	ordprg /@Batch_Alias_Name
RMS286	ordrev	Purchase Orders	Admin	4	orddsct	edidlord otbdnld otbdsal otbdlord			daily	ordrev /@Batch_Alias_Name
RMS287	ordupd	Purchase Orders	Business Processing	4	sccext	otbdlord		After RPM pricing change extraction batch	daily	ordupd /@Batch_Alias_Name



RMS13	otbdlord	Open To Buy	Integration	4		N/A	Phase 4 scheduling ensures appropriate stock ledger processing (saldly and salweek) is complete before this job runs.	daily	otbdlord /@Batch_Alias_Name output_file
RMS16	otbdlsal	Stock Ledger	Integration	4	ordupd, salweek	N/A	This program must be run after ORDUPD (order upload.) It also must be run after SALWEEK for the week just ended. This program and OTBDNLD can run anytime after SALWEEK, but SALDLY cannot run between OTBDNLD, OTBDLSAL and OTBDLORD.	Weekly	otbdlsal /@Batch_Alias_Name output_file
RMS130 RMS291	otbdnld otbprg	Open To Buy Open To Buy	Integration Admin	4 ad hoc	N/A	N/A N/A	Phase 4 scheduling ensures appropriate stock ledger processing (saldly and salweek) is complete before this job runs	weekly monthly	otbdnld /@Batch_Alias_Name output_file otbprg /@Batch_Alias_Name
RMS131	otbupfwd	Open To Buy	Integration	ad hoc	N/A	N/A	Optional – This interface only needs to be scheduled if forward budget limits will be used and are provided by a 3rd party OTB planning system.	daily	/@Batch_Alias_Name input_file reject_file
RMS132	otbupld	Open To Buy	Integration	ad hoc	N/A	N/A	Optional - this interface only needs to be scheduled if OTB is interfaced into RMS from RPAS or another 3rd party planning system	daily	otbupld /@Batch_Alias_Name input_file reject_file
RMS69	poscdnld	Integration - 3rd Party POS	Integration	4	posdnld	prepost poscdnld post	Optional - This program (and it's related prepost function poscdnld_post() ) should only be scheduled if RMS is used to master: • Accepted tenders/location • POS Button Definitions, including but not limited to layout, button text, button colors, etc • Coupon definitions and relationships to items • Restrictions on product sales, including but not limited to minimum age of purchaser, time/days when product cannot be sold, tenders that cannot be used to purchase the product, etc.	daily	poscdnld /@Batch_Alias_Name outputfile
RMS70	posdnld	Integration - 3rd Party POS	Integration	4	N/A	prepost posdnld post		daily	posdnld /@Batch_Alias_Name output_filename
RMS147	posgpdld	Integration - 3rd Party POS	Integration	ad hoc	N/A	N/A		daily	posgpdld /@Batch_Alias_Name output_file
RMS148	posrefresh	Integration - 3rd Party POS	Integration	ad hoc	N/A	N/A		As needed	posrefresh /@Batch_Alias_Name output_file store
RMS298	prchstprg.pc	Foundation Data	Admin	ad hoc	N/A	N/A	Recommend this is run prior to phase 3 to improve phase 3 performance	daily	prchstprg /@Batch_Alias_Name
RMS159	pre_rmse_aip.ksh	Integration - AIP	Integration	ad hoc	N/A	N/A	This program should be scheduled early in the ad hoc cycle. It must be run before all other extracts for AIP.	daily	N/A

RMS160	pre_rmse_rpas.ksh	Integration - Planning	Integration	ad hoc	N/A	N/A	N/A	daily	N/A
RMS302	reclsdly	Foundation Data	Business Processing	4	cremhierdly prepost reclsdly pre	prepost reclsdly post		daily	reclsdly /@Batch_Alias_Name process_mode
RMS303	refeodinventory	Inventory	Processing	8	wasteadj.pc	prepost edidlprd pre		daily	refeodinventory.ksh /@Batch_Alias_Name
RMS304	refmv110entity	Foundation Data	Admin	ad hoc	N/A	N/A		As needed	refmv110entity /@Batch_Alias_Name
RMS305	refmvlocprimaddr	Foundation Data	Admin	ad hoc	N/A	N/A		As needed	refmvlocprimaddr /@Batch_Alias_Name
RMS306	repl_wf_order_sync.ksh	Replenishment	business Processing	3	rplapprv	N/A		daily	repl_wf_order_sync.ksh /@Batch_Alias_Name
RMS307	repladj	Replenishment	business Processing	3	rplatupd	reqext rplext		daily	repladj /@Batch_Alias_Name
RMS308	reproq.ksh	Replenishment	business Processing	3	prepost reproq pre rplatupd, rilmaint, and repladj	N/A		daily	reproq.ksh /@Batch_Alias_Name <last run of day> <restart_ind>
RMS309	replsizeprofile	Replenishment	Business Processing	ad hoc	prepost replsizeprofile pre	rplatupd	replsizeprofile only needs to be scheduled if size profiles are used in replenishment	Daily	replsizeprofile /@Batch_Alias_Name Y/N. (Y/N indicator indicates if allocations is installed or not)
RMS310	reqext	Replenishment	business Processing	3	rplatupd repladj prepost reqext pre sccext	prepost reqext post rplext	Run either batch_reqext.ksh or reqext.pc. See detailed program documents for more information	daily	reqext /@Batch_Alias_Name partition_position
RMS311	rilmaint	Replenishment	business Processing	3	rplatupd prepost rilmaint pre	prepost rilmaint post		daily	rilmaint username/password
RMS20	rmse_aip_alloc_in_well.ksh	Integration - AIP	Integration	4	pre_rmse_aip.ksh, onordext	N/A	All RMS inventory jobs should complete before this extract is performed.	daily	N/A
RMS27	rmse_aip_banded_item.ksh	Integration - AIP	Integration	ad hoc	pre_rmse_aip.ksh, dlyprg	N/A tsfprg ordprg		daily	N/A
RMS21	rmse_aip_cl_po.ksh	Integration - AIP	Integration	ad hoc	pre_rmse_aip.ksh			daily	N/A
RMS28	rmse_aip_future_delivery_alloc.ksh	Integration - AIP	Integration	4	pre_rmse_aip.ksh, onordext	N/A	All RMS inventory jobs should complete before this extract is performed.	daily	N/A
RMS22	rmse_aip_future_delivery_order.ksh	Integration - AIP	Integration	4	pre_rmse_aip.ksh, onordext	N/A	All RMS inventory jobs should complete before this extract is performed.	daily	N/A
RMS29	rmse_aip_future_delivery_tsfs.ksh	Integration - AIP	Integration	4	pre_rmse_aip.ksh, onordext	N/A	All RMS inventory jobs should complete before this extract is performed.	daily	N/A
RMS23	rmse_aip_item_loc_traits.ksh	Integration - AIP	Integration	ad hoc	dlyprg	N/A		daily	N/A
RMS30	rmse_aip_item_master.ksh	Integration - AIP	Integration	4	pre_rmse_aip.ksh reclsdly	N/A		daily	N/A
RMS24	rmse_aip_item_retail.ksh	Integration - AIP	Integration	ad hoc	pre_rmse_aip.ksh dlyprg	N/A		daily	N/A
RMS31	rmse_aip_item_sale.ksh	Integration - AIP	Integration	ad hoc	pre_rmse_aip.ksh sitmain	N/A		daily	N/A
RMS25	rmse_aip_item_supp_country.ksh	Integration - AIP	Integration	ad hoc	pre_rmse_aip.ksh dlyprg, sitmain	N/A		daily	N/A
RMS32	rmse_aip_merchier.ksh	Integration - AIP	Integration	ad hoc	pre_rmse_aip.ksh dlyprg	N/A		daily	N/A
RMS26	rmse_aip_orghier.ksh	Integration - AIP	Integration	ad hoc	pre_rmse_aip.ksh dlyprg	N/A		daily	N/A
RMS33	rmse_aip_rec_qty.ksh	Integration - AIP	Integration	4	pre_rmse_aip.ksh, onordext	N/A	All RMS inventory jobs should complete before this extract is performed.	daily	N/A

RMS40	rmse_aip_store.ksh	Integration - AIP	Integration	ad hoc	pre_rmse_aip.ksh dlyprg	N/A		daily	N/A
RMS38	rmse_aip_substitute_items.ksh	Integration - AIP	Integration	ad hoc	pre_rmse_aip.ksh	N/A		daily	N/A
RMS37	rmse_aip_suppliers.ksh	Integration - AIP	Integration	ad hoc	pre_rmse_aip.ksh	N/A		daily	N/A
RMS36	rmse_aip_tsf_in_well.ksh	Integration - AIP	Integration	4	pre_rmse_aip.ksh, onordex	N/A	All RMS inventory jobs should complete before this extract is performed.	daily	N/A
RMS35	rmse_aip_wh.ksh	Integration - AIP	Integration	ad hoc	pre_rmse_aip.ksh dlyprg	N/A		daily	N/A rmse_mfp_inventory.ksh I or W
RMS106	rmse_mfp_inventory.ksh	Integration - Planning	Integration	4	pre_rmse_rpas.ksh		All RMS inventory jobs should complete before this extract is performed.	Weekly	Note: I - 'Initial load W-'Weekly load
RMS107	rmse_mfp_onorder.ksh	Integration - Planning	Integration	4	pre_rmse_rpas.ksh		All RMS inventory jobs should complete before this extract is performed.	Weekly	rmse_mfp_onorder.ksh <no of weeks>
							Optional – If a client uses this wrapper script, no extraction for RPAS will be performed until the most restrictive sub script dependencies allow it. This wrapper script must be scheduled after a phase 8 dependency.		
							This may mean a delay in getting any information to RPAS so its processing cycle can begin.		
							If this script is NOT used, it is possible to get some data to RPAS earlier in the total batch cycle. This may have an impact on when AIP is able to begin it's batch processing.		
RMS149	rmse_rpas.ksh	Integration - Planning	Integration	8	pre_rmse_rpas.ksh	N/A		daily	N/A
RMS01	rmse_rpas_attributes.ksh	Integration - Planning	Integration	ad hoc	pre_rmse_rpas.ksh	N/A		daily	N/A
RMS08	rmse_rdf_daily_sales.ksh	Integration - Planning	Integration	4	saldly pre_rmse_rpas.ksh	N/A		daily	N/A
RMS06	rmse_rpas_domain.ksh	Integration - Planning	Integration	ad hoc	N/A	N/A		daily	N/A
RMS05	rmse_rpas_item_master.ksh	Integration - Planning	Integration	4	sitmain recisdly dlyprg pre_rmse_rpas.ksh	N/A		daily	N/A
RMS10	rmse_rpas_merchhier.ksh	Integration - Planning	Integration	ad hoc	dlyprg pre_rmse_rpas.ksh	N/A		daily	N/A
RMS04	rmse_rpas_orghier.ksh	Integration - Planning	Integration	ad hoc	dlyprg pre_rmse_rpas.ksh	N/A		daily	N/A
RMS07	rmse_rpas_stock_on_hand.ksh	Integration - Planning	Integration	4	stkdy dlyprg	N/A		daily	N/A
RMS02	rmse_rpas_store.ksh	Integration - Planning	Integration	ad hoc	pre_rmse_rpas.ksh	N/A		daily	N/A
RMS11	rmse_rpas_suppliers.ksh	Integration - Planning	Integration	ad hoc	pre_rmse_rpas.ksh	N/A		daily	N/A
RMS09	rmse_rdf_weekly_sales.ksh	Integration - Planning	Integration	8	hstwkupd salweek pre_rmse_rpas.ksh	N/A		Weekly	N/A
RMS03	rmse_rpas_wh.ksh	Integration - Planning	Integration	ad hoc	dlyprg pre_rmse_rpas.ksh	N/A		daily	N/A

RMS39	rmse_store_cur_inventory.ksh	Integration - AIP	Integration	4	pre_rmse_aip.ksh, onordex	N/A	All RMS inventory jobs should complete before this extract is performed.	daily	D - single -threaded delta extract F - multi-threaded full extract if ITEM_LOC is partitioned; single-threaded full extract if ITEM_LOC is not partitioned
RMS34	rmse_wh_cur_inventory.ksh	Integration - AIP	Integration	4	pre_rmse_aip.ksh, onordex	N/A	All RMS inventory jobs should complete before this extract is performed.	daily	D - single -threaded delta extract F - multi-threaded full extract if ITEM_LOC is partitioned; single-threaded full extract if ITEM_LOC is not partitioned
RMS134	rmsl_rpas_forecast.ksh	Integration - Planning	Integration	ad hoc		N/A	The runtime parameter determines whether daily forecast or weekly forecast data is being loaded.	daily	rmsl_rpas_forecast.ksh daily or weekly
					pre_rmse_rpas.ksh rmse_rpas.ksh rmse_rpas_attributes.ksh rmse_rpas_daily_sales.ksh rmse_rpas_domain.ksh rmse_rpas_item_master.ksh rmse_rpas_merchhier.ksh rmse_rpas_orghier.ksh rmse_rpas_stock_on_hand.ksh rmse_rpas_store.ksh rmse_rpas_suppliers.ksh rmse_rpas_wh.ksh rmsl_rpas_forecast.ksh rmse_rpas_merchhier.ksh rmse_rpas_item_master.ksh rmse_rpas_orghier.ksh rmse_rpas_store.ksh rmse_rpas_wh.ksh		After all daily RPAS Integration RETL scripts are run.		
RMS161	rmsl_rpas_update_retl_date.ksh	Integration - Planning	Integration	4		N/A	Note that it should run after the inventory related extracts in Phase 4.	daily	rmsl_rpas_update_retal_date.ksh CLOSED_ORDER or RECEIVED_QTY
RMS300	rplapprv	Replenishment	business Processing	3	supcnstr prepost rplapprv pre	batch_rplapprvgtax	batch_rplapprvgtax is only required post processing in GTAX environments	daily	rplapprv /@Batch_Alias_Name rplathistprg /@Batch_Alias_Name (This batch may be run only if repl_attr_hist_retention_weeks in system_options table is set)
RMS312	rplathistprg	Replenishment	Admin	ad hoc	N/A	N/A		Weekly	
RMS313	rplatupd	Replenishment	business Processing	3	prepost rplatupd pre	repladj rplext reqext		daily	rplatupd /@Batch_Alias_Name
RMS314	rplbld	Replenishment	business Processing	3	ibcalc rplext cntrprss supsplit	supcnstr	cntroordb and cntrprss are dependencies if contracting is used. They are not dependencies of the client does not use contracting. Ibcalc and Ibexpl are only dependencies if the client uses investment buying functionality.	daily	rplbld username/password
RMS315	rplext	Replenishment	business Processing	3	prepost rpl pre rplatupd rilmaint repladj reqext	prepost rplext post supsplit cntrprss ibexpl ibcalc		daily	rplext /@Batch_Alias_Name dept
RMS316	rplprg	Replenishment	Admin	ad hoc	N/A	N/A		daily	rplprg /@Batch_Alias_Name
RMS317	rplprg_month	Replenishment	Admin	ad hoc	N/A	N/A		monthly	rplprg_month /@Batch_Alias_Name
RMS318	rplsplnt	Replenishment	business Processing	3	supcnstr	rplapprv		daily	rplsplnt /@Batch_Alias_Name rpmovavg /@Batch_Alias_Name business_date(YYYYMMDD) store(optional)
RMS319	rpmovavg	Sales History Transfers, Allocations, and RTV	Business Processing	3	salstage	N/A		daily	
RMS320	rtvprg	Admin	Admin	ad hoc	N/A	N/A		monthly	rtvprg /@Batch_Alias_Name

RMS335	salapnd	Stock Ledger		3	salstage fifgldn1 fifgldn2	N/A		daily	salapnd /@Batch_Alias_Name
RMS336	saldly	Stock Ledger	business Processing	3	salstage	N/A	salweek (on end of week day)	daily	saldly /@Batch_Alias_Name
RMS337	saleoh	Stock Ledger	business Processing	3	prepost saleoh pre	N/A		half yearly	saleoh /@Batch_Alias_Name ./salesgenrej.ksh \$UP <input file> <process id> **need manual intervention to figure get the input file and process id from the sales upload staging table.
RMS338	salesgenrej.ksh	Sales Posting	Admin	2	salesprocess.ksh	N/A		daily	Must be run in at least phase 2. Can also be run ad hoc to trickle poll sales.
RMS151	salesprocess.ksh	Sales Posting	business Processing	2	uploadsales.ksh	salesgenrej.ksh salesuploadarch		daily	Must be run in at least phase 2. Can also be run ad hoc to trickle poll sales. ./salesprocess.ksh \$UP
RMS340	salesuploadarch.ksh	Sales Posting	Admin	2	salesprocess	N/A		daily	./salesuploadarch.ksh \$UP
RMS342	salmaint	Stock Ledger	Admin	ad hoc	N/A	N/A		half yearly	salmaint /@Batch_Alias_Name pre_or_post
RMS343	salmth	Stock Ledger	business Processing	3	salweek	prepost salmth post		monthly	salmth /@Batch_Alias_Name
RMS344	salprg	Stock Ledger	Admin	ad hoc	N/A	N/A		daily	salprg /@Batch_Alias_Name
						saldly salapnd salweek dealact rpmovavg fifgldn1 fifgldn2			
RMS345	salstage	Stock Ledger	business Processing	3	salesprocess.ksh			daily	salstage /@Batch_Alias_Name
RMS346	salweek	Stock Ledger	Business Processing	3	prepost salweek pre	prepost salweek post		weekly	salweek /@Batch_Alias_Name
RMS355	sccext	Cost Change	Processing	3	N/A	prepost sccext post		daily	sccext /@Batch_Alias_Name
RMS356	schedprg	Foundation Data	Admin	ad hoc	N/A	N/A		monthly	schedprg /@Batch_Alias_Name
RMS357	sitmain	Item Maintenance	Business Processing	ad hoc	lclrbld	N/A		daily	sitmain /@Batch_Alias_Name
RMS115	soutdnld	Integration - Planning	Integration business	4	N/A	N/A		daily	Processing that updates the stock levels should be completed before running this program. soutdnld /@Batch_Alias_Name
RMS359	stkdlly	Stock Count	Processing	3	stkvar	salweek		daily	stkdlly /@Batch_Alias_Name
RMS360	stkprg	Stock Count	Admin	ad hoc	N/A	prepost stkprg post		monthly	stkprg /@Batch_Alias_Name
RMS361	stkschedxpld	Stock Count	Business Processing	0	N/A	stkxpld		daily	stkschedxpld /@Batch_Alias_Name
RMS362	stkupd	Stock Count	business Processing	8	prepost stkupd pre stkxpld			daily	stkupd /@Batch_Alias_Name
RMS363	stkvar	Stock Count	business Processing	1	N/A	N/A		daily	stkvar /@Batch_Alias_Name [ report_file_name ]
RMS364	stkxpld	Stock Count	business Processing	8	stkschedxpld wasteadj	stkupd		daily	Should have some dependency on weekly processes. stkxpld /@Batch_Alias_Name
RMS17	stlgdnld	Stock Ledger	Integration business	4	stkschedxpld wasteadj	N/A		weekly	Normal weekly run is phase 4. Additionally, can be run ad hoc for historic data stlgdnld /@Batch_Alias_Name input_file
RMS366	stockcountprocess.ksh	Stock Count	Processing	1	lifstkup	N/A		daily	stockcountprocess.ksh /@Batch_Alias_Name
RMS153	stockcountupload.ksh	Stock Count	Integration Business	1	lifstkup	N/A		daily	stockcountupload.ksh /@Batch_Alias_Name input_file <reject_file>
RMS368	supcnstr	Purchase Orders	Processing Business	3	rplbld	rplsplit		daily	supcnstr /@Batch_Alias_Name
RMS369	supmth	Foundation Data	Processing	3	N/A	prepost supmth post		monthly	supmth /@Batch_Alias_Name
RMS370	supsplit	Replenishment	business Processing	3	rplext prepost supsplit pre	cntrprss.pc		daily	supsplit /@Batch_Alias_Name

RMS371	tamperctn	Transfers, Allocations, and RTV	business Processing	ad hoc	N/A	N/A	This batch program only needs to be scheduled if the store_pack_comp_rcv_ind system parameter is 'Y'. Optional - This program only needs to be run is the client uses RMS Global Tax (GTAX) functionality.	daily	tamperctn /@Batch_Alias_Name
RMS124	taxdnl	Integration - 3rd Party POS Administration	Integration Admin	ad hoc	N/A	N/A	Optional - This program only needs to be run is the client uses RMS Sales and Use Tax (SALES) functionality.	As needed	taxdnl /@Batch_Alias_Name output_filename
RMS373	taxevntprg			ad hoc	N/A	N/A		daily	taxevntprg /@Batch_Alias_Name no_of_days
RMS59	tcktdnl	Foundation Data	Integration	ad hoc	N/A	N/A		daily	tcktdnl /@Batch_Alias_Name filename print_online_ind days_in_advance [location]
RMS116	tifposdn	Integration - 3rd Party POS	Integration	4	txrposdn	prepost tifposdn post		daily	tifposdn /@Batch_Alias_Name output_file
RMS376	trandatload	Stock Ledger	Integration Business	3	N/A	trandataprocess	N/A	daily	trandatload.ksh /@Batch_Alias_Name <file load indicator> <input file>
RMS377	trandataprocess	Stock Ledger	Processing	3	trandatload	salstage	N/A	daily	trandataprocess.ksh /@Batch_Alias_Name <num threads>
RMS140	tranupld	Oracle Retail Trade Management	Integration	ad hoc	N/A	N/A	This batch does not need to be scheduled when the rtm_simplified_ind in SYSTEM_OPTIONS table is set to 'Y'.	daily	tranupld /@Batch_Alias_Name infile
RMS379	tsfclose	Allocations, and RTV	Admin	ad hoc	N/A	prepost docclose pre		daily	tsfclose /@Batch_Alias_Name
RMS380	tsfprg	Transfers, Allocations, and RTV	Admin	ad hoc	prepost tsfprg pre	prepost tsfprg post		daily	tsfprg /@Batch_Alias_Name
RMS152	txrposdn	Integration - 3rd Party POS	Integration	4	N/A	tifposdn		daily	txrposdn /@Batch_Alias_Name
RMS58	txrtupld	Foundation Data	Integration	4	N/A	N/A		daily	txrtupld username/password input_file reject_file
RMS157	uploadsales_all.ksh	Sales Posting	Integration Business	2	saexprms	salesprocess.ksh	uploadsales_all.ksh and uploadsales.ksh perform the same function. uploadsales_all.ksh wraps uploadsales to simplify the process of running uploadsales.ksh for groups of POSU files.	daily	./uploadsales_all.ksh \$UP<optional directory parameter>
RMS384	vatdixpl	Item Maintenance	Processing	0	N/A	prepost vatdixpl post	Must be run in at least phase 2. Can also be run ad hoc to trickle poll sales.  saexprms.pc is one method of creating the POSU file that is uploaded by this job. Clients may also choose to produce an RTLOG directly from their POS data. If clients directly produce a POSU file, saexprms.pc is not a predependency	daily	vatdixpl /@Batch_Alias_Name

RMS122	vendinvc	Deals	Integration	3	prepost vendinvc pre	prepost vendinvc post	Dealact is a predependency, noted as preprocessing of related prepost pre job.	daily	vendinvc /@Batch_Alias_Name
RMS123	vendinvf	Deals	Integration	3	prepost vendinvf pre	prepost vendinvf post	salweek is a post dependency at EOW samth is a dependency at EOM. These are both noted as post dependencies of the related prepost job.	daily	vendinvf /@Batch_Alias_Name
RMS387	vrplbld	Purchase Orders	business Processing	1	ediupack	prepost vrplbld post	salstage is a predependency, noted as preprocessing of related prepost pre job.	daily	vrplbld /@Batch_Alias_Name
RMS388	wasteadj	Inventory Franchise Management	business Processing	8	N/A fcexec	refeodinventory stkxpld stkupd	This program should be scheduled to run prior to the stock count and stock ledger batch to ensure that the stock adjustment taken during the current day is credited to the appropriate day.	daily	wasteadj /@Batch_Alias_Name
RMS389	wf_apply_supp_cc.ksh	Franchise Management	business Processing	ad hoc	sccext	N/A		daily	wf_apply_supp_cc.ksh /@Batch_Alias_Name
RMS155	wfbillex.ksh	Franchise Management	Integration	ad hoc	N/A	N/A		daily	wfbillex.ksh /@Batch_Alias_Name
RMS391	wfordcls	Franchise Management	Admin	ad hoc	docclose wfordcls	wfordprg		daily	wfordcls /@Batch_Alias_Name
RMS392	wfordprg	Franchise Management	Admin	ad hoc	wfrtnprg	N/A		monthly	wfordprg /@Batch_Alias_Name
RMS60	wfordupld.ksh	Franchise Management	Integration	ad hoc	N/A prepost wfordupld pre	N/A		daily	wfordupld.ksh /@Batch_Alias_Name input_file_directory output_file_directory number_of_threads
RMS394	wfretcls	Franchise Management	Admin	ad hoc	docclose	wfrtnprg		daily	wfretcls /@Batch_Alias_Name
RMS154	wfretupld.ksh	Franchise Management	Integration	ad hoc	N/A prepost wfretupld pre	N/A		daily	wfretupld.ksh /@Batch_Alias_Name input_file_directory output_file_directory number_of_threads
RMS396	wfrtnprg	Franchise Management	Admin	ad hoc	ordprg tsfprg	wfordprg		monthly	wfrtnprg /@Batch_Alias_Name
RMS156	wfslsupld.ksh	Franchise Management	Integration Business Processing	ad hoc	N/A	N/A		daily	wfslsupld.ksh / @Batch_Alias_Name process_mode input_file
RMS398	whstrasg	Foundation Data	Processing	3	rplapprv	prepost whstrasg post		daily	whstrasg /@Batch_Alias_Name
RMS399	ushts2rms	Oracle Retail Trade Management	Admin	ad hoc	N/A	htsupld		As needed	
RMS400	prepost rpl pre	Replenishment	Admin	3		rplex		daily	
RMS401	prepost salweek post	Stock Ledger	Admin	3	salweek	salmth	salmth is a post dependency when the end of week also falls at the end of month.	weekly	
RMS402	prepost salmth post	Stock Ledger	Admin	3	salmth	prepost saleoh pre	saleoh jobs are a post dependency when the end of month also falls at the end of half.	monthly	
RMS403	prepost rplapprv pre	Replenishment	Admin	3		rplapprv		daily	
RMS404	prepost rplatupd pre	Replenishment	Admin	3	replsizeprofile	rplatupd		daily	
RMS405	prepost rplatupd post	Replenishment	Admin	3	rplatupd			daily	

RMS406	prepost rilmaint pre	Replenishment	Admin	3			rilmaint	daily	
RMS407	prepost rilmaint post	Replenishment	Admin	3	rilmaint		repladj	daily	
RMS408	prepost supmth post	Foundation Data	Admin	3				monthly	
RMS409	prepost sccext post	Cost Change	Admin	3	sccext			daily	
RMS410	prepost hstbld pre	Sales History	Admin	8	N/A		hstbld	As needed	This prepost job is only required when the hstbld program is run in rebuild mode.
RMS411	prepost hstbld post	Sales History Integration - 3rd	Admin	8	hstbld			As needed	This prepost job is only required when the hstbld program is run in rebuild mode.
RMS412	prepost posdnld post	Party POS	Admin	ad hoc	posdnld			daily	
RMS413	prepost edidlprd post	Inventory	Admin	8	edidlprd			daily	
RMS414	prepost edidlprd pre	Inventory	Admin	8	refeodinventory		edidlprd	daily	
RMS415	prepost fcstrbld post	Integration - Planning	Admin	3	fcstrbld			weekly	
RMS416	prepost vrplbld post	Purchase Orders	Admin	1				daily	
RMS417	prepost cntrordb post	Contracts Integration -	Admin	3	cntrordb		N/A	daily	This module only needs to be scheduled if the client uses contracting.
RMS418	prepost fsadnld post	Planning	Admin	4			prepost fsadnld post	daily	N/A
RMS419	prepost btchcycl pre	Administration	Admin	0				daily	This job must complete before any real processing begins
RMS420	prepost whstrasg post	Foundation Data	Admin	3				daily	
RMS421	prepost poscdnld post	Integration - 3rd Party POS	Admin	4	poccdnld			daily	Optional - This pre post function (and it's related program poscdnld) should only be run if RMS is used to master a vatriety of POS tender and restriction data. See the poscdnld for more information.
RMS422	prepost tifposdn post	Integration - 3rd Party POS	Admin	4	tifposdn			daily	Optional - This pre post function (and it's related program poscdnld) should only be run if the client uses RMS Sales and Use Tax (SALES) functionality.
RMS423	prepost htstupld pre	Oracle Retail Trade Management	Admin	ad hoc			htstupld.pc	As needed	
RMS424	prepost onordext pre	Integration - Planning	Admin	4	N/A		onordext	daily	
RMS425	prepost rclsdly pre	Foundation Data	Admin	4	N/A		rclsdly	daily	
RMS426	prepost rclsdly post	Foundation Data	Admin	4	rclsdly		N/A	daily	This program only needs to be scheduled if the client uses Investment Buy functionality.
RMS427	prepost ibcalc pre	Replenishment	Admin	3			ibcalc	daily	
RMS428	prepost fcstprg pre	Integration - Planning	Admin	ad hoc			fcstprg	daily	
RMS429	prepost fcstprg post	Integration - Planning	Admin	ad hoc	fcstprg			daily	
RMS430	prepost reqext pre	Replenishment	Admin	3			reqext	daily	
RMS431	prepost reqext post	Replenishment	Admin	3	reqext			daily	
RMS432	prepost stkupd pre	Stock Count	Admin	8			stkupd	daily	
RMS433	prepost reproq pre	Replenishment	Admin	3			reproq.ksh	daily	
RMS434	prepost rplext post	Replenishment	Admin	3	rplext			daily	
RMS436	prepost vatdlxpl post	Foundation Data	Admin	0	vatdlxpl			daily	
RMS438	prepost saleoh pre	Stock Ledger	Admin	3	prepost salmth post		saleoh	half yearly	



RMS ID	Job Name	Module	User	Frequency	Script	Script	Script	Frequency
					dealfct			
					dealinc			
					vendinvc			
				3	vendinvf			
					saldly			
					stkdlly			
RMS440	prepost salweek pre	Stock Ledger	Admin		salapnd	salweek		weekly
RMS441	prepost dealinc pre	Deals	Admin	3		dealinc		monthly
RMS442	prepost dealday pre	Deals	Admin	3		dealday		monthly
RMS443	prepost dealday post	Deals	Admin	3	dealday	salmth		monthly
RMS444	prepost dealact_nor pre	Deals	Admin	3	salstage	dealact		Daily
RMS445	prepost dealact_po pre	Deals	Admin	3	salstage	dealact		Daily
RMS446	prepost dealact_sales pre	Deals	Admin	3	salstage	dealact		Daily
RMS447	prepost dealfct pre	Deals	Admin	3	dealinc	dealfct		daily
RMS448	prepost dealcls post	Deals	Admin	4	dealcls			daily
RMS449	prepost hstbldmth post	Sales History	Admin	8	hstbldmth			Monthly
RMS450	prepost vendinvc pre	Deals	Admin	3	dealact			
RMS451	prepost vendinvf pre	Deals	Admin	3	salstage(if daily)	vendinvc		daily
RMS452	prepost vendinvc post	Deals	Admin	3	salstage	vendinvf		daily
RMS453	prepost vendinvf post	Deals	Admin	3	vendinvc	salweek		daily
		Transfers,			vendinvf	salmth		daily
		Allocations, and				salweek		
RMS454	prepost docclose pre	RTV	Admin	ad hoc		docclose		daily
RMS455	prepost stkprg post	Stock Count	Admin	ad hoc	stkprg			monthly
RMS456	prepost wfordupld pre	Franchise	Admin	ad hoc	N/A	wfordupld.ksh		daily
RMS457	prepost wfretupld pre	Management	Admin	ad hoc	N/A	wfretupld.ksh		daily
RMS458	prepost replsizeprofile pre	Replenishment	Admin	ad hoc		replsizeprofile		daily
RMS459	prepost supsplit pre	Replenishment	Admin	3		supsplit	replsizeprofile only needs to be scheduled if size profiles are used in replenishment	daily
RMS460	prepost batch_orpos_extract post	Integration - Oracle Retail POS Suite	Admin	4	orposcustsegdnld			daily
RMS461	prepost batch_ordcostcompupd pre	Foundation Data	Admin	2	N/A	batch_ordcostcompupd.ksh		daily
RMS462	prepost batch_ordcostcompupd post	Foundation Data	Admin	2	batch_ordcostcompupd.ksh	N/A		daily
							The following scripts can be executed in parallel:	
							<input type="checkbox"/> batch_alloctsfupd.ksh	
							<input type="checkbox"/> batch_depchrgupd.ksh	
							<input type="checkbox"/> batch_expprofupd.ksh	
							<input type="checkbox"/> batch_itmcostcompupd.ksh	
							<input type="checkbox"/> batch_ordcostcompupd.ksh	
							The pre-post job batch_costcompupd post should be run after all 5 complete.	
RMS463	prepost batch_costcompupd post	Foundation Data	Admin	2				daily
RMS464	prepost ediupadd post	Foundation Data	Admin	2	ediupadd	N/A		As needed
RMS465	prepost dlyprg post	Administration	Admin	0	dlyprg			daily
RMS466	prepost tsfprg pre	Transfers, Allocations, and RTV	Admin	ad hoc	N/A	tsfprg		daily
RMS467	prepost tsfprg post	Transfers, Allocations, and RTV	Admin	ad hoc	tsfprg	wftrnprg		daily

RMS468	prepost fcexec pre	Future Cost	Admin	2	fcthreadexec	fcexec	Daily
RMS469	prepost start_batch pre	Administration	Admin	0			daily
RMS470	prepost end_batch post	Administration	Admin	date_set			daily
							<p>This job sets the batch running ind to Y. This prevents access to some portions of the UI to ensure data integrity.</p> <p>This job sets the batch running ind to N. This prevents access to some portions of the UI to ensure data integrity.</p> <p>uploadsales_all.ksh and uploadsales.ksh perform the same function.</p> <p>uploadsales_all.ksh wraps uploadsales to simplify the process of running uploadsales.ksh for groups of POSU files.</p> <p>Must be run in at least phase 2. Can also be run ad hoc to trickle poll sales.</p> <p>saexprms.pc is one method of creating the POSU file that is uploaded by this job. Clients may also choose to produce an RTLOG directly from their POS data. If clients directly produce a POSU file, saexprms.pc is not a predependency</p>
RMS112	uploadsales.ksh	Sales Posting	Integration	2	saexprms	salesprocess.ksh	daily
RMS117	cfastgload.ksh	CFAS	Integration	ad hoc			As Needed
RMS126	fcustomerupload.ksh	Franchise Management	Integration	ad hoc	N/A		daily
RMS141	orposcouponitemdnld	Integration - Oracle Retail POS Suite	Integration	4			daily
RMS142	orposcouponpricednld	Integration - Oracle Retail POS Suite	Integration	4			daily
RMS143	orpositemsdnld	Integration - Oracle Retail POS Suite	Integration	4			daily
RMS144	orposmerchdnld	Integration - Oracle Retail POS Suite	Integration	4			daily
RMS145	orposcustsegdnld	Integration - Oracle Retail POS Suite	Integration	4		prepost batch_orpos_extract post	daily
RMS146	orposstorednld	Integration - Oracle Retail POS Suite	Integration	4			daily

Optional – If a client uses this wrapper script, no extraction for AIP will be performed until the most restrictive sub script dependencies allow it. This wrapper script must be scheduled after ad hoc after most processes in phase 4.

This may mean a delay in getting any information to AIP so its processing cycle can begin.

If this script is NOT used, it is possible to get some data to AIP earlier in the total batch cycle. This may have an impact on when AIP is able to begin its batch processing.

RMS118	rmse_aip_batch.ksh	Integration - AIP	Integration	ad hoc						daily	
RMS471	cfagen.ksh	CFAS	Admin	ad hoc						As needed	
RMS472	cfamigrate.ksh	CFAS	Admin	ad hoc						As needed	
RMS473	loadods.ksh	Administration	Admin	ad hoc						As needed	
RMS474	iindbatch.ksh	Item Maintenance	Integration	ad hoc	N/A		N/A			daily	Database connection, Input File Name, Template Name,
RMS475	TBD (Pending Addition of New Item Loc perf fix)	Item Maintenance	Business Processing	TBD	TBD		TBD			TBD	
RMS476	ccprg.pc	Cost Change	Admin	ad hoc						Monthly	
RMS477	hstwkupd.ctl	Sales History	Admin	8	hstwkupd		N/A		Run SQL*Loader using the control file hstwkupd.ctl to load data from the output file written by hstwkupd.pc for non-existent records on ITEM_LOC_HIST.	weekly	
RMS488	prepost btchcycl post	Administration	Admin	date_set					This should be the last job in the batch cycle.	daily	
RMS341	salesuploadpurge.ksh	Sales Posting	Admin	ad hoc	N/A		N/A		Must be run in at least phase 2. Can also be run ad hoc to trickle poll sales.	daily	./salesuploadpurge.ksh \$UP <retention period> ./salesgenrej.ksh \$UP <input file> <process id> **need manual intervention to figure get the input file and process id from the sales upload staging table.
RMS338	salesgenrej.ksh	Sales Posting	Admin	ad hoc	salesprocess.ksh		N/A		Must be run in at least phase 2. Can also be run ad hoc to trickle poll sales.	daily	
RMS151	salesprocess.ksh	Sales Posting	Business Processing	ad hoc	uploadsales.ksh		salesgenrej.ksh salesuploadarch		Must be run in at least phase 2. Can also be run ad hoc to trickle poll sales.	daily	./salesprocess.ksh \$UP
RMS340	salesuploadarch.ksh	Sales Posting	Admin	ad hoc	salesprocess		N/A		Must be run in at least phase 2. Can also be run ad hoc to trickle poll sales.	daily	./salesuploadarch.ksh \$UP

RMS157	uploadsales_all.ksh	Sales Posting	Integration	ad hoc	saexprms	salesprocess.ksh	<p>uploadsales_all.ksh and uploadsales.ksh perform the same function.</p> <p>uploadsales_all.ksh wraps uploadsales to simplify the process of running uploadsales.ksh for groups of POSU files.</p> <p>Must be run in at least phase 2. Can also be run ad hoc to trickle poll sales.</p> <p>saexprms.pc is one method of creating the POSU file that is uploaded by this job. Clients may also choose to produce an RTLOG directly from their POS data. If clients directly produce a POSU file, saexprms.pc is not a predependency</p> <p>uploadsales_all.ksh and uploadsales.ksh perform the same function.</p> <p>uploadsales_all.ksh wraps uploadsales to simplify the process of running uploadsales.ksh for groups of POSU files.</p> <p>Must be run in at least phase 2. Can also be run ad hoc to trickle poll sales.</p> <p>saexprms.pc is one method of creating the POSU file that is uploaded by this job. Clients may also choose to produce an RTLOG directly from their POS data. If clients directly produce a POSU file, saexprms.pc is not a predependency</p>	daily	./uploadsales_all.ksh \$UP<optional directory parameter>
RMS112 RMS489	uploadsales.ksh prepost dealfct post	Sales Posting Admin	Integration Admin	ad hoc 3	saexprms dealfct	salesprocess.ksh salmth	<p>uploadsales_all.ksh and uploadsales.ksh perform the same function.</p> <p>uploadsales_all.ksh wraps uploadsales to simplify the process of running uploadsales.ksh for groups of POSU files.</p> <p>Must be run in at least phase 2. Can also be run ad hoc to trickle poll sales.</p> <p>saexprms.pc is one method of creating the POSU file that is uploaded by this job. Clients may also choose to produce an RTLOG directly from their POS data. If clients directly produce a POSU file, saexprms.pc is not a predependency</p>	daily daily	

## RPM Program Dependency and Scheduling Details

Product	Program Name	Functional Area	Threaded	Driver	Phase	Program Pre-dependency	Program Post-dependency	Dependency Notes	Timing	Uses Restart/Recovery	Run Parameters for Programs
RPM	ClearancePriceChangePublishBatch	Clearances	Y	Price event (item/loc)	N/A	WorksheetAutoApproveBatch	ClearancePriceChangePublishExport		daily/ad hoc	N	clearancePriceChangePublishBatch.sh rpm-batch-user-alias
RPM	ClearancePriceChangePublishExport	Clearances	N	Price event (item/loc)	N/A	ClearancePriceChangePublishBatch			daily/ad hoc	N	clearancePriceChangePublishExport.sh /@tns-user-name [export-path]
RPM	FutureRetailRollUpBatch	Future Retail	Y	N/A	N/A	N/A	N/A		ad hoc	N	FutureRetailRollUpBatch.sh <username> <password> [dept=<deptid> class=<classid> subclass=<subclassid>]
RPM	InjectorPriceEventBatch	Price Change/Clearance/Promc	Y	Item/Location	N/A	N/A	PriceEventExecutionDealsBatch		ad hoc	N	injectorPriceEventBatch.sh rpm-batch-user-alias password [status=<status>]
RPM	ItemLocDeleteBatch	Purge	N	N/A	N/A	N/A	N/A		daily	N	[event_type=<event_type>] itemLocDeleteBatch.sh rpm-batch-user-alias
RPM	ItemReclassBatch	Future Retail	N	N/A	N/A	reclsdy(RMS)	NewItemLocBatch		daily/ad hoc	N	itemReclassBatch.sh rpm-batch-user-alias
RPM	LocationMoveBatch	Zone Structure/Future Retail	Y	Location move	N/A	NewItemLocBatch	PriceEventExecutionBatch		daily	N	locationMoveBatch.sh rpm-batch-user-alias
RPM	LocationMoveScheduleBatch	Zone Structure/Future Retail	Y	Location move	N/A	NewItemLocBatch	LocationMoveBatch, PriceEventExecutionBatch		daily, adhoc	N	locationMoveScheduleBatch.sh rpm-batch-user-alias
RPM	MerchExtractKickOffBatch	Pricing Worksheet	Y	Price strategy	N/A	PriceEventExecutionBatch WorksheetAutoApproveBatch PriceStrategyCalendarBatch wfcostcalc (RMS)	Wholesale Item Catalog Report (RMS)		daily	N	merchExtractKickOffBatch.sh rpm-batch-user-alias
RPM	NewItemLocBatch	Future Retail	N	N/A	N/A	ItemReclassBatch	LocationMoveBatch		daily/ad hoc	N	NewItemLocBatch.sh rpm-batch-user-alias [status [error-commit-count/process id]]
RPM	NewItemLocPublishMBPromoBatch	Promotions	N	N/A	N/A	NewItemLocBatch	N/A		daily/ad hoc	N	NewItemLocPublishMBPromoBatch.sh rpm-batch-user-alias
RPM	nightlyBatchCleanup		N	N/A	N/A	N/A	N/A		daily	N	nightlyBatchCleanup.sh </@db-connection-alias> <pre / post> <log path>
RPM	priceChangeAreaDifferentialBatch	Price Change	Y	N/A	N/A	N/A	N/A		ad hoc	N	priceChangeAreaDifferentialBatch rpm-batch-user-alias
RPM	PriceChangeAutoApproveResultsPurge	Purge	N	N/A	N/A	N/A	N/A		daily	N	priceChangeAutoApproveResultsPurgeBatch.sh rpm-batch-user-alias
RPM	PriceChangePurgeBatch	Purge	N	N/A	N/A	N/A	N/A		daily	N	priceChangePurgeBatch.sh rpm-batch-user-alias
RPM	PriceChangePurgeWorkspaceBatch	Purge	N	N/A	N/A	N/A	N/A		daily	N	priceChangePurgeWorkspaceBatch.sh rpm-batch-user-alias
RPM	PriceEventExecutionBatch	Price Change/Clearance/Promc	Y	Pricing event	N/A	salstage (RMS)	PriceEventExecutionRMSBatch		daily	N	priceEventExecutionBatch.sh rpm-batch-user-alias
RPM	PriceEventExecutionDealsBatch	Price Change/Clearance/Promc	Y	Pricing event	N/A	PriceEventExecutionRMSBatch	MerchExtractKickOffBatch		daily	N	priceEventExecutionDealsBatch.sh rpm-batch-user-alias
RPM	priceEventExecutionForChunkCCEmergencyEvents	Price Change/Clearance/Promc	Y	Item/Location	N/A	N/A	N/A		ad hoc	N	priceEventExecutionForChunkCCEmergencyEvents.sh </@db-connection-alias> <log path> <error path>
RPM	PriceEventExecutionRMSBatch	Price Change/Clearance/Promc	Y	Pricing event	N/A	PriceEventExecutionBatch	PriceEventExecutionDealsBatch		daily	N	priceEventExecutionRMSBatch.sh rpm-batch-user-alias
RPM	priceEventItemListPurgeBatch.sh	Purge	N	N/A	N/A	N/A	N/A		daily/ad hoc	N	priceEventItemListPurgeBatch connect_string logpath errpath
RPM	PriceStrategyCalendarBatch	Price Strategy	N	N/A	N/A	N/A	MerchExtractKickOffBatch		daily	N	priceStrategyCalendarBatch.sh rpm-batch-user-alias
RPM	primaryZoneModificationsBatch	Future Retail	Y	PZG definition updates	N/A	N/A	N/A		ad hoc	N	primaryZoneModificationsBatch <userid/password@sid> <log path> <error path>
RPM	processPendingChunksBatch	Price Change/Clearance/Promc	Y	N/A	N/A	N/A	N/A		ad hoc	N	processPendingChunksBatch.sh rpm-batch-user-alias
RPM	promotionArchiveBatch.sh	Promotions	N	N/A	N/A	N/A	N/A		daily	N	
RPM	PromotionPriceChangePublishBatch	Promotions	Y	Price event (item/loc)	N/A	WorksheetAutoApproveBatch	PromotionPriceChangePublishExport		daily/ad hoc	N	promotionPriceChangePublishBatch.sh rpm-batch-user-alias
RPM	PromotionPriceChangePublishExport	Promotions	N	Price event (item/loc)	N/A	PromotionPriceChangePublishBatch	N/A		daily/ad hoc	N	promotionPriceChangePublishExport.sh /@tns-user-name [export-path]
RPM	PromotionPurgeBatch	Purge	N	N/A	N/A	N/A	N/A		daily	N	promotionPurgeBatch.sh rpm-batch-user-alias
RPM	PurgeBulkConflictCheckArtifacts	Conflict Checking	N	N/A	N/A	MerchExtractKickOffBatch	N/A		daily	N	purgeBulkConflictCheckArtifacts.sh rpm-batch-user-alias
RPM	purgeConCheckResultsErrorData	Purge	N	N/A	N/A	N/A	N/A		daily	N	purgeConCheckResultsErrorData.sh </@db-connection-alias> <log path> <error path>
RPM	PurgeExpiredExecutedOrApprovedClearancesBatch	Purge	N	N/A	N/A	N/A	N/A		daily	N	purgeExpiredExecutedOrApprovedClearancesBatch.sh rpm-batch-user-alias
RPM	PurgeLocationMovesBatch	Purge	N	N/A	N/A	N/A	N/A		daily	N	purgeLocationMovesBatch.sh rpm-batch-user-alias
RPM	purgePayloadsBatch	purge	N	Price event	N/A	RegularPriceChangePublishExport, ClearancePriceChangePublishExport, PromotionPriceChangePublishExport	N/A		ad hoc	N	purgePayloads.sh </@tns-user-name> <publish-status>
RPM	purgeRPMBatchRunHistory	Purge	N	N/A	N/A	N/A	N/A		daily	N	purgeRPMBatchRunHistory.sh </@db-connection-alias> <log path> <error path>
RPM	purgeTxnExclusionSkulistWS	Purge	N	N/A	N/A	N/A	N/A		daily	N	purgeTxnExclusionSkulistWS.sh </@db-connection-alias> <log path> <error path>
RPM	PurgeUnusedAndAbandonedClearancesBatch	Purge	N	N/A	N/A	N/A	N/A		daily	N	purgeUnusedAndAbandonedClearancesBatch.sh rpm-batch-user-alias
RPM	refreshPosDataBatch	Price Event	Y	N/A	N/A	N/A	N/A		ad hoc	N	refreshPosDataBatch.sh <rpm-batch-user-alias> <location> [date(YYYYMMdd)]
RPM	RegularPriceChangePublishBatch	Regular Price Changes	Y	Price event (item/loc)	N/A	WorksheetAutoApproveBatch	RegularPriceChangePublishExport		daily/ad hoc	N	regularPriceChangePublishBatch.sh rpm-batch-user-alias
RPM	regularPriceChangePublishExport	Regular Price Changes	N	Price event (item/loc)	N/A	RegularPriceChangePublishBatch			daily/ad hoc	N	regularPriceChangePublishExport.sh /@tns-user-name [export-path]
RPM	RPMtoORPOSPublishBatch.sh	Price Change/Clearance/Promc	N	N/A	N/A	MerchExtractKickOffBatch WorksheetAutoApproveBatch	N/A		daily	N	ksh RPMtoORPOSPublishBatch.sh </@tns-user-name> <log path> <error path>
RPM	RPMtoORPOSPublishExport.sh	Price Change/Clearance/Promc	Y	Location	N/A	RPMtoORPOSPublishBatch.sh	N/A		daily	N	ksh RPMtoORPOSPublishExport.sh </@tns-user-name> <Numberof slots> <logpath> <error path> <Export path>
RPM	stagePromosForExtDashboard	Promotions	Y	Promotion Detail Id	N/A	N/A	N/A		daily	N	stagePromosForExtDashboard.sh </@db-connection-alias> <slots> <luw> <log path> <error path>

RPM	taskPurgeBatch.sh	Purge	N	N/A	N/A	N/A	N/A	daily	N	taskPurgeBatch.sh <rpm-batch-user-alias> [<purgeDays>] [Y/N]
RPM	WorksheetAutoApproveBatch	Pricing Worksheet	Y	Price strategy	N/A	N/A	MerchExtractKickOffBatch	daily	N	worksheetAutoApproveBatch.sh rpm-batch-user-alias
RPM	ZoneFutureRetailPurgeBatch	Purge	N	N/A	N/A	N/A	N/A	daily	N	zoneFutureRetailPurgeBatch.sh rpm-batch-user-alias
RPM	futureRetailPurgeBatch.sh	Purge	Y	Dept/Class/Subclass	N/A	N/A	N/A	daily	N	futureRetailPurgeBatch.sh rpm-batch-user-alias

## ReSA Program Dependency and Scheduling Details

Catalog ID	Job Name	Functional Area	Type	Driver	Phase	Program Pre-dependency	Program Post-dependency	Dependency/Run Notes	Frequency	Run Parameters for Programs
RSA13	rmst_saimptlog_promo	Oracle Retail Sales Audit	Integration	N/A	ad hoc	rpm program	saimptlog or saimptlogi		Daily	
RSA05	saescheat	Oracle Retail Sales Audit	Integration	N/A	ad hoc	satotals sarules	saexpim sapurge	Runs from saescheat and does not need to be seperately scheduled.	Monthly	saescheat /@Batch_Alias_Name
RSA25	saescheat_nextesn	Oracle Retail Sales Audit	Admin	N/A	ad hoc	N/A	N/A		monthly	
RSA03	saexpach	Oracle Retail Sales Audit	Integration	N/A	ad hoc	satotals sarules	sapreexp		daily	saexpach /@Batch_Alias_Name
RSA02	saexpdw	Oracle Retail Sales Audit	Integration	Store	ad hoc	sapreexp satotals sarules	resa2dw	resa2dw is a file transformation perl script	daily	saexpdw /@Batch_Alias_Name ; perl resa2dw inputfile outputfile
RSA09	saexpgl	Oracle Retail Sales Audit	Integration	N/A	ad hoc	sapreexp sarules	N/A		daily	saexpgl /@Batch_Alias_Name
RSA04	saexpim	Oracle Retail Sales Audit	Integration	N/A	ad hoc	sapreexp saescheat	N/A		daily	saexpim /@Batch_Alias_Name
RSA01	saexprms	Oracle Retail Sales Audit	Integration	Store	ad hoc	satotals sarules	saprepost saexprms post		daily	saexprms /@Batch_Alias_Name
RSA14	saexpsim	Oracle Retail Sales Audit	Integration	Store	ad hoc	satotals sarules	saprepost saexpsim post	resa2sim is a file transformation perl script	daily	saexpsim /@Batch_Alias_Name ; perl resa2sim inputfile outputfile
RSA06	saexpuar	Oracle Retail Sales Audit	Integration	N/A	ad hoc	satotals sarules	sapreexp		daily	saexpuar /@Batch_Alias_Name sagetref /@Batch_Alias_Name itemfile wastefile ref_itemfile prim_variantfile varupfile storedayfile codesfile errorfile errorfile cvallfile storeposfile tendertypefile merchcodesfile partnerfile supplierfile employeefile bannerfile currencyfile promfile whfile invstatusfile (To prevent a file from being written, place a ' ' in its place. Note: Item files must all be written together).
RSA00	sagetref	Oracle Retail Sales Audit	Integration	N/A	ad hoc	sastdycr	saimptlog or saimptlogi		daily	
RSA07	saimpadj	Oracle Retail Sales Audit		N/A	ad hoc	saimptlogfin	satotals	Clients can use either saimptlog & SQL loader or saimptlogi.	daily	saimpadj /@Batch_Alias_Name input_file rej_file
RSA11a	saimptlog	Oracle Retail Sales Audit		Store/Day	ad hoc	sagetref saprepost saimptlog pre	saprepost saimptlog post	Use sql Loader to load data into ReSA tables	daily	saimptlog user/pw infile badfile itemfile wastefile ref_itemfile primvariantfile varupfile storedayfile promfile codesfile errorfile cvallfile storeposfile tendertypefile merchcodefile partnerfile supplierfile employeefile bannerfile currencyfile whfile invstatusfile max_tran_gap(optional)
RSA18	saimptlogfin	Oracle Retail Sales Audit	Integration	N/A	ad hoc	saprepost saimptlogi post saimptlog savouch	satotals		daily	saimptlogfin /@Batch_Alias_Name store_day_file
RSA11b	saimptlogi	Oracle Retail Sales Audit	Integration	Store/Day	ad hoc	saprepost saimptlogi pre	saprepost saimptlogi post	Clients can use either saimptlog & SQL loader or saimptlogi.		
RSA19	saimptlogtdup_upd	Oracle Retail Sales Audit	Admin		ad hoc		saimptlog/saimptlogi	This program should be run before running saimptlog/saimptlogi if any Store-Day's have been deleted.	As needed	
RSA12	saordinvexp	Oracle Retail Sales Audit	Integration	Store	2	N/A	N/A	Doc said 2, xls said ad hoc - not sure either is correct	daily	saordinvexp /@Batch_Alias_Name
RSA20	sapreexp	Oracle Retail Sales Audit	Admin	N/A	ad hoc	saexpach saexpgl saexpim saexpdw saexpsim saexprms saexpuar		Should run before any SA export processes	daily	sapreexp /@Batch_Alias_Name
RSA26	saprepost	Oracle Retail Sales Audit	Admin	N/A	ad hoc	N/A	N/A		daily	saprepost /@Batch_Alias_Name program pre_or_post
RSA21	sapurge	Oracle Retail Sales Audit	Admin Business	Store	ad hoc	saprepost sapurge pre	saprepost sapurge post	This program should be run as the last program in the ReSA portion of the batch schedule	daily	sapurge /@Batch_Alias_Name deleted_items_file [optional list of store days to be deleted]
RSA17	sarules	Oracle Retail Sales Audit	Processing	N/A	ad hoc	satotals	saescheat		daily	saescheat /@Batch_Alias_Name store_no
RSA15	sastdycr	Oracle Retail Sales Audit	Business Processing	N/A	date_set	N/A	dtesys	(It should run before the DTESYS batch program and before the next store/day's transactions are received)	daily	sastdycr /@Batch_Alias_Name [YYYYMMDD]
RSA16	satotals	Oracle Retail Sales Audit	Business Processing	N/A	ad hoc	saimptlogfin	saescheat		daily	saescheat /@Batch_Alias_Name store_no
RSA08	savouch	Oracle Retail Sales Audit	Business Processing	N/A	ad hoc	saimptlog/saimptlogi	saimptlogfin		daily	savouch /@Batch_Alias_Name infile rejfile tendertype_file
RSA27	saprepost saexprms post	Oracle Retail Sales Audit	Admin							
RSA28	saprepost saexpdw post	Oracle Retail Sales Audit	Admin							
RSA29	saprepost saordinvexp post	Oracle Retail Sales Audit	Admin							
RSA30	saprepost saexpfm post	Oracle Retail Sales Audit	Admin							
RSA31	saprepost saexpsim post	Oracle Retail Sales Audit	Admin							
RSA32	saprepost saimptlog	Oracle Retail Sales Audit	Admin							
RSA33	saprepost saimptlog	Oracle Retail Sales Audit	Admin							
RSA34	saprepost sapurge pre	Oracle Retail Sales Audit	Admin							
RSA35	saprepost sapurge post	Oracle Retail Sales Audit	Admin							
RSA36	resa2sim	Oracle Retail Sales Audit	Integration							
RSA37	resa2dw	Oracle Retail Sales Audit	Integration							

### ReIM Program Dependency and Scheduling Details

Product	Program Name	Functional Area	Threaded	Driver	Phase	Program Pre-dependency	Program Post-dependency	Dependency Notes	Timing	Uses Restart/R ecovery	Run Parameters for Programs
ReIM	reimaccountworkspacepurge	Invoice Matching (ReIM)	N	N/A	N/A	N/A	N/A		Daily	N	batch-user-alias
ReIM	reimautomatch	Invoice Matching (ReIM)	Y	N/A	6	N/A	reimrollup		Daily	N	batch-user-alias
ReIM	reimpurge	Invoice Matching (ReIM)	N	N/A	0	N/A	reimposting		Daily	N	batch-user-alias PURGE ALL TABLE_NAME [COMMIT NOCOMMIT]
ReIM	reimcomplexdealupload	Invoice Matching (ReIM)	Y	N/A	5	vendinvc(RMS)	reimautomatch		Daily	N	batch-user-alias BlockSize PartitionNo [PartitionSize]
ReIM	reimcreditnoteautomatch	Invoice Matching (ReIM)	Y	N/A	6	N/A	reimrollup		Daily	N	batch-user-alias
ReIM	reimmediinjector	Invoice Matching (ReIM)	Y	N/A	5	edidlinv(RMS)	reimposting		Daily	N	batch-user-alias "EDI input file or directory with full path" "EDI reject file or directory with full path"
ReIM	reimmediinvdownload	Invoice Matching (ReIM)	N	N/A	7	reimposting	reimcreditnoteautomatch		Daily	N	batch-user-alias "EDI output file with path"
ReIM	reimfixeddealupload	Invoice Matching (ReIM)	Y	N/A	5	vendinvc(RMS)	reimautomatch		Daily	N	batch-user-alias BlockSize PartitionNo [PartitionSize]
ReIM	reimrollup	Invoice Matching (ReIM)	N	N/A	6	reimautomatch	reimposting		Daily	N	batch-user-alias
ReIM	reimreceiptwriteoff	Invoice Matching (ReIM)	N	N/A	6	reimautomatch	N/A		Daily	N	batch-user-alias
ReIM	reimposting	Invoice Matching (ReIM)	Y	N/A	6	reimrollup	N/A		Daily	N	batch-user-alias



## Allocation Program Dependency and Scheduling Details

Product	Program Name	Functional Area	Threaded	Driver	Phase	Program Pre-dependency	Program Post-dependency	Dependency Notes	Timing	Uses Restart/Rcovery	Run Parameters for Programs
Allocation	AllocSchedulerBatch.ksh	Scheduled Allocation	Y	N/A	N/A		None		daily	N	batch-user-alias
Allocation	alct_plan.ksh	Integration - Planning	N	N/A	N/A		alcl_plan.ksh		daily	N	
Allocation	alcl_plan.ksh	Integration - Planning	N	N/A	N/A	alct_plan.ksh			daily	Y	plan_data_input_file [thread_number]
Allocation	alct_receipt_plan.ksh	Integration - Planning	N	N/A	N/A		alcl_receipt_plan.ksh		daily	N	
Allocation	alcl_receipt_plan.ksh	Integration - Planning	N	N/A	N/A	alct_receipt_plan.ksh			daily	Y	reciept_data_input_file [thread_number]
Allocation	alct_size_profile	Integration - Planning	N	N/A	N/A		alcl_size_profile		daily	N	
Allocation	alcl_size_profile	Integration - Planning	N	N/A	N/A	alct_size_profile.ksh		The Allocation snapshot programs can functionally run concurrently. However, they use parallel processing so depending on database resources it may make sense to limit how many run concurrently.	daily	Y	input_file [thread_number]
Allocation	AlcSnapshotSOH.ksh	Snapshots	N	N/A	8	reclsdly.pc(RMS)		The Allocation snapshot programs can functionally run concurrently. However, they use parallel processing so depending on database resources it may make sense to limit how many run concurrently.	daily	N	batch-user-alias
Allocation	AlcSnapshotOnOrder.ksh	Snapshots	N	N/A	8	reclsdly.pc(RMS)		The Allocation snapshot programs can functionally run concurrently. However, they use parallel processing so depending on database resources it may make sense to limit how many run concurrently.	daily	N	batch-user-alias
Allocation	AlcSnapshotAllocIn.ksh	Snapshots	N	N/A	8	reclsdly.pc(RMS)		The Allocation snapshot programs can functionally run concurrently. However, they use parallel processing so depending on database resources it may make sense to limit how many run concurrently.	daily	N	batch-user-alias
Allocation	AlcSnapshotCrosslink.ksh	Snapshots	N	N/A	8	reclsdly.pc(RMS)		The Allocation snapshot programs can functionally run concurrently. However, they use parallel processing so depending on database resources it may make sense to limit how many run concurrently.	daily	N	batch-user-alias
Allocation	AlcSnapshotAllocOut.ksh	Snapshots	N	N/A	8	reclsdly.pc(RMS)		The Allocation snapshot programs can functionally run concurrently. However, they use parallel processing so depending on database resources it may make sense to limit how many run concurrently.	daily	N	batch-user-alias
Allocation	AlcSnapshotCustomerOrder.ksh	Snapshots	N	N/A	8	reclsdly.pc(RMS)		The Allocation snapshot programs can functionally run concurrently. However, they use parallel processing so depending on database resources it may make sense to limit how many run concurrently.	daily	N	batch-user-alias
Allocation	AlcDailyCleanup.ksh	Admin	N	N/A	N/A	AllocSchedulerBatch.ksh			daily	N	batch-user-alias
Allocation	AlcPurgeAlloc.ksh	Admin	Y	N/A	N/A	N/A			daily or weekly	N	batch-user-alias
Allocation	AlcPurgeWksht.ksh	Admin	Y	N/A	N/A	N/A			daily or weekly	N	batch-user-alias
Allocation	AlcDailyShrinkSessionTables.ksh	Admin	N	N/A	N/A	AlcDailyCleanup.ksh			daily	N	batch-user-alias



---

---

## Interface Diagrams for RMS and RPAS

Because RMS is the retailer's central merchandising transactional processing system, it is the principle source of the foundation data needed in some of the Oracle Retail suite of products. RMS provides foundation data to RPAS, and RPAS provides planning data to RMS.

This chapter presents flow diagrams for data processing from sources. The source system's program or output file is illustrated, along with the program or process that interfaces with the source. After initial interface processing of the source, the diagrams illustrate the flow of the data.

Before setting up a program schedule, familiarize yourself with the functional and technical constraints associated with each program. Refer to the *Oracle Retail Merchandising System Operations Guide* for more information about these interface programs.

## RMS Pre/Post Extract Diagrams

### RMS Pre RETL Extract Maintenance

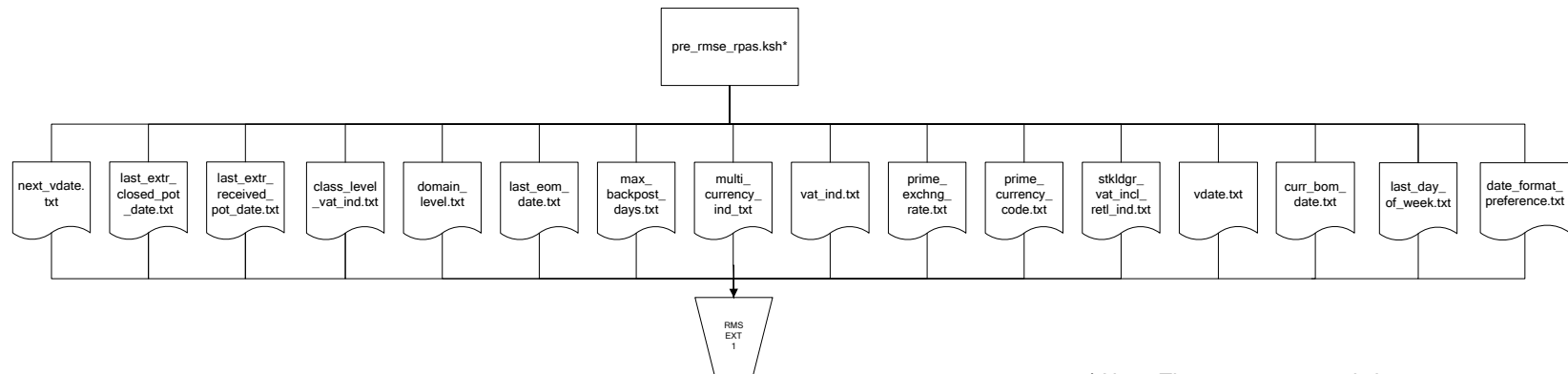

\* Note: The `pre_rmse_rpas.ksh` program checks for existing `.txt` output files. Because of this validation, retailers running the program for the first time should include an optional `-c` parameter. This parameter allows the program to run successfully without pre-existing `.txt` output files.

## RMS Foundation Data Extract Diagrams

Merchandise Hierarchy for RPAS

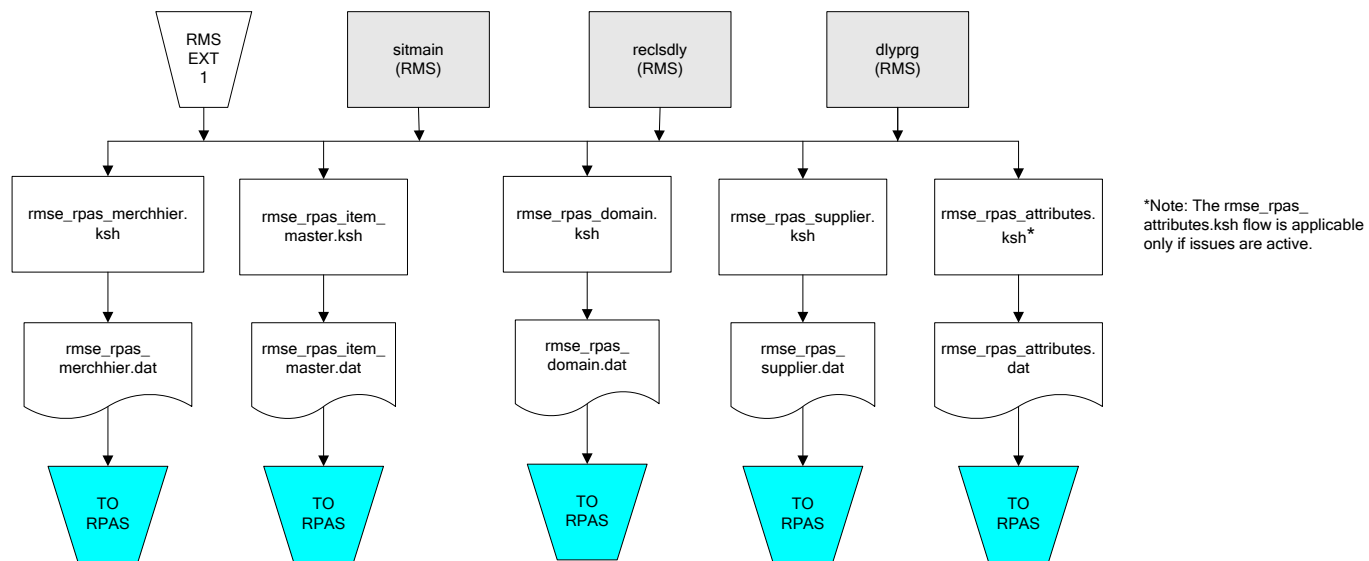

### Organization Hierarchy for RPAS

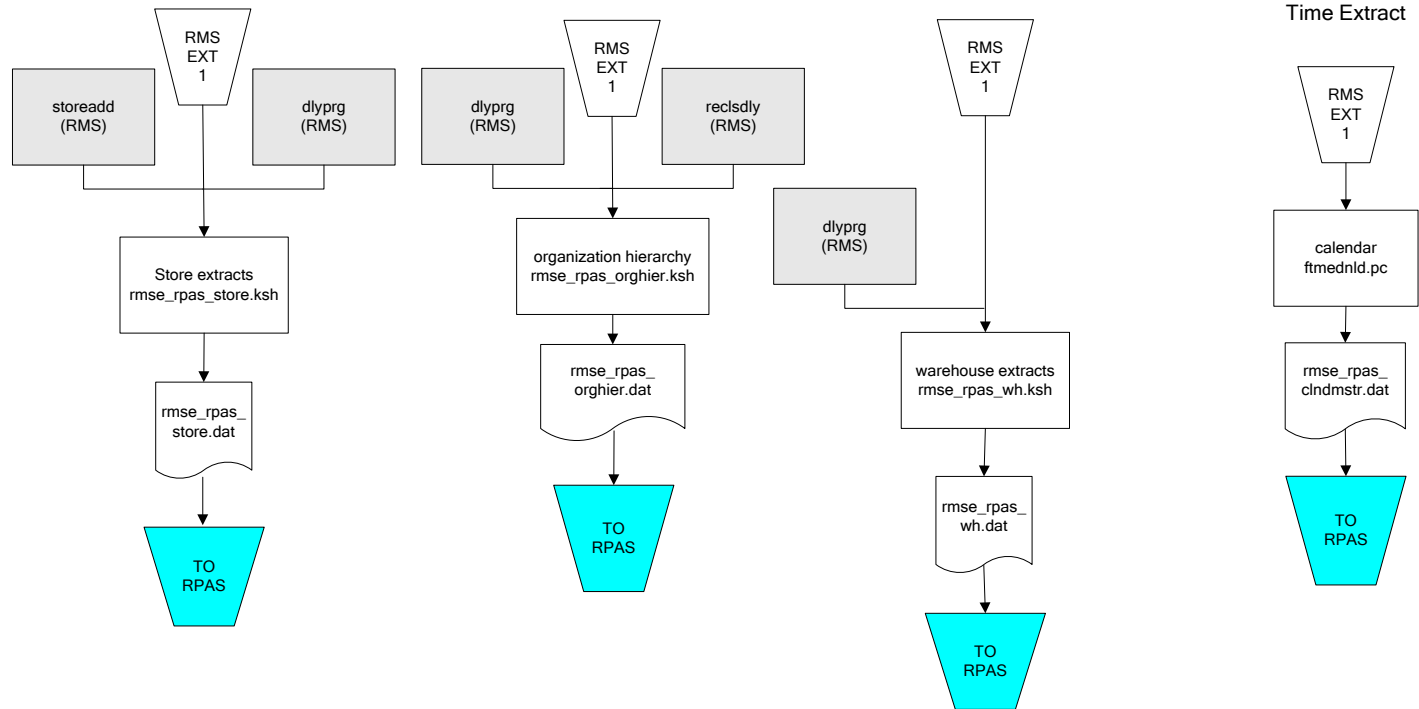

## RMS Fact Data Extract Diagrams

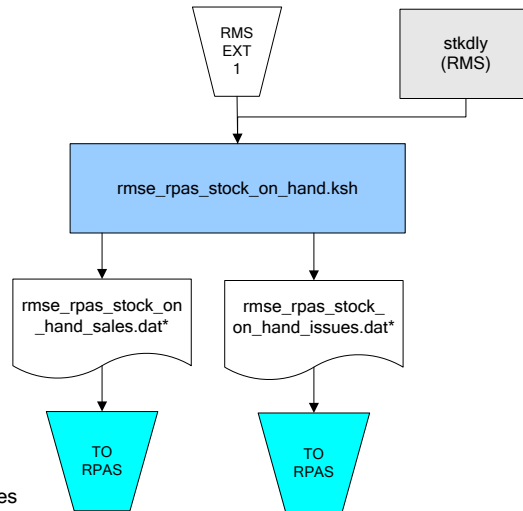

\* Note:  
 If issues are active, the following two files result from the rmse\_rpas\_stock\_on\_hand.ksh flow:  
 rmse\_rpas\_stock\_on\_hand\_issues.dat  
 rmse\_rpas\_stock\_on\_hand\_sales.dat

If issues are not active, the following file results from the rmse\_rpas\_stock\_on\_hand.ksh flow:  
 rmse\_rpas\_stock\_on\_hand\_sales.dat

## Sales Extracts For RPAS

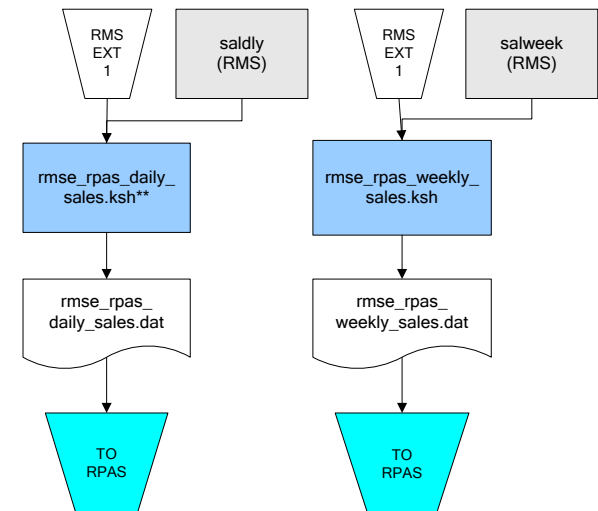

\*\* Note:  
 Depending upon the configuration of rmse\_rpas\_daily\_sales.ksh, the data can be pulled from TRAN\_DATA\_HISTORY or TRAN\_DATA.

## RPAS-RMS Fact Load Diagram

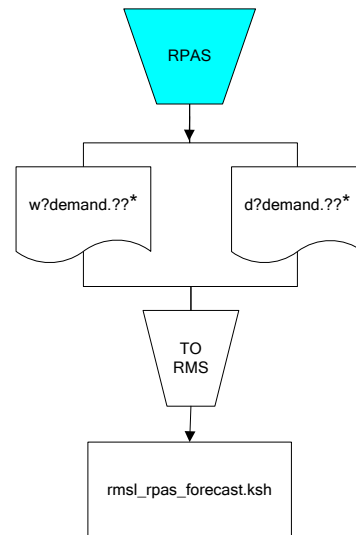

\*Note:

? can represent the following:

- i (for issues)
- s (for stores)

?? represents domain 01-99.



---

---

## Interface Diagrams for RMS and MFP

Because RMS is the retailer's central merchandising transactional processing system, it is the principle source of the foundation data needed in some of the Oracle Retail suite of products. RMS provides foundation data to RPAS, and RPAS provides planning data to RMS.

This chapter presents flow diagrams for data processing from sources. The source system's program or output file is illustrated, along with the program or process that interfaces with the source. After initial interface processing of the source, the diagrams illustrate the flow of the data.

Before setting up a program schedule, familiarize yourself with the functional and technical constraints associated with each program. Refer to the *Oracle Retail Merchandising System Operations Guide* for more information about these interface programs.

## RMS Pre/Post Extract Diagrams

### RMS Pre RETL Extract Maintenance

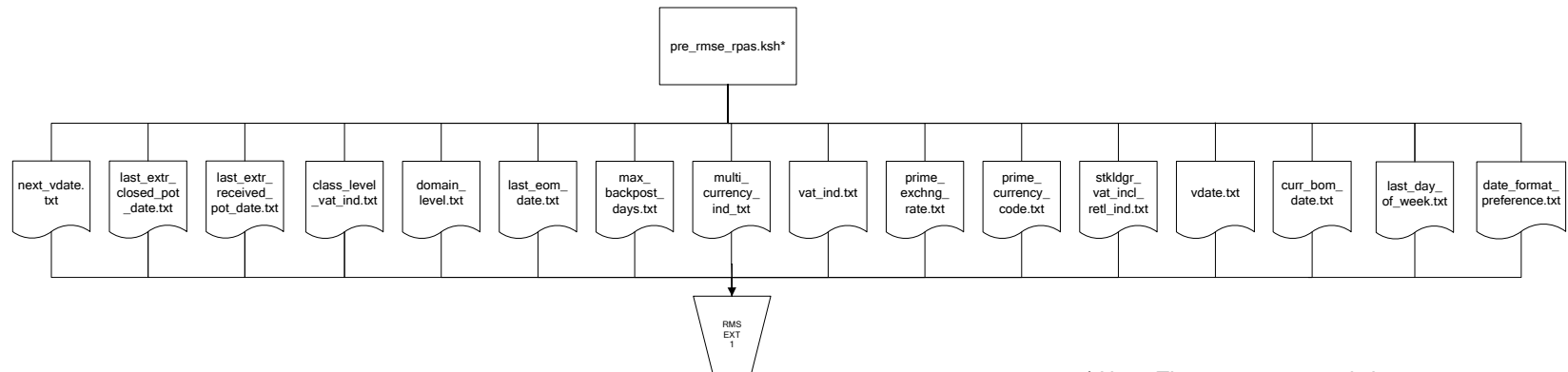

\* Note: The pre\_rmse\_rpas.ksh program checks for existing .txt output files. Because of this validation, retailers running the program for the first time should include an optional -c parameter. This parameter allows the program to run successfully without pre-existing .txt output files.

---

## RMS Foundation Data Extract Diagrams

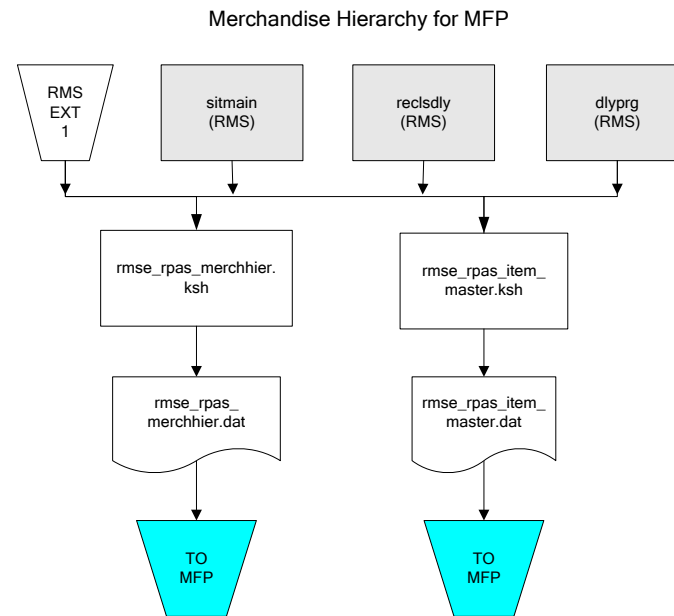

### Organization Hierarchy for MFP

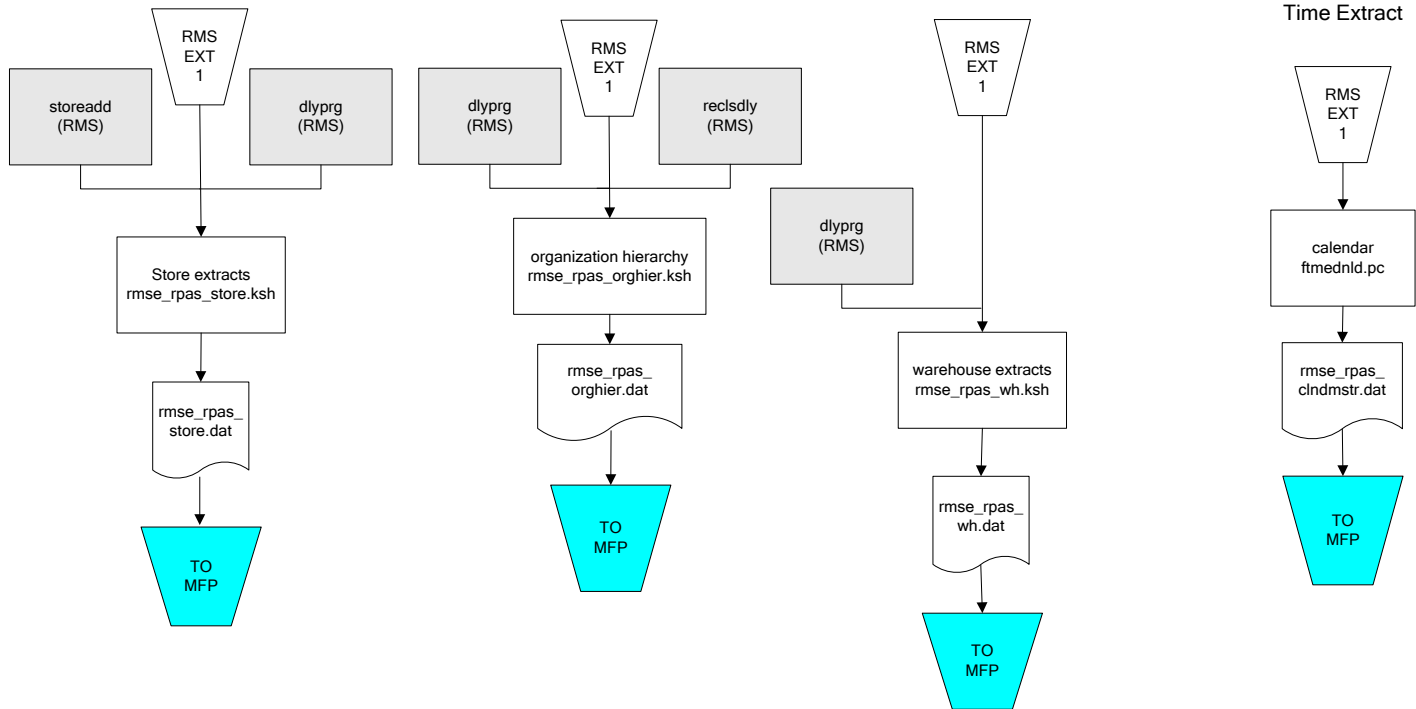

## RMS Fact Data Extract Diagrams

### Integration Extracts for MFP

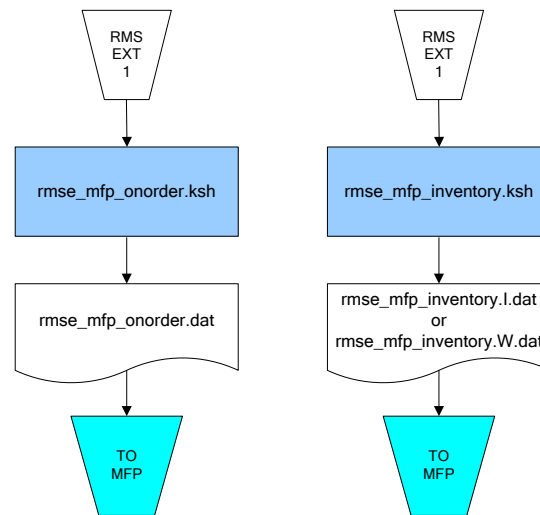

Note:  
I is for initial load and W is  
for weekly load..



---

---

## Interface Diagrams for RMS and AIP

This chapter presents flow diagrams for RETL extract data processing from RMS to AIP. The RMS program or output file is illustrated, along with the program or process that interfaces with the source. The diagrams illustrate the flow of the data after initial interface processing of the source.

Before setting up a program schedule, familiarize yourself with the functional and technical constraints associated with each program. See the *Oracle Retail Merchandising System Operations Guide Volume 1—Batch Overviews and Designs* for more information about the modules shown in the following diagrams.





## RMS Pre/Post Extract Diagrams

### RMS Pre RETL Extract Maintenance

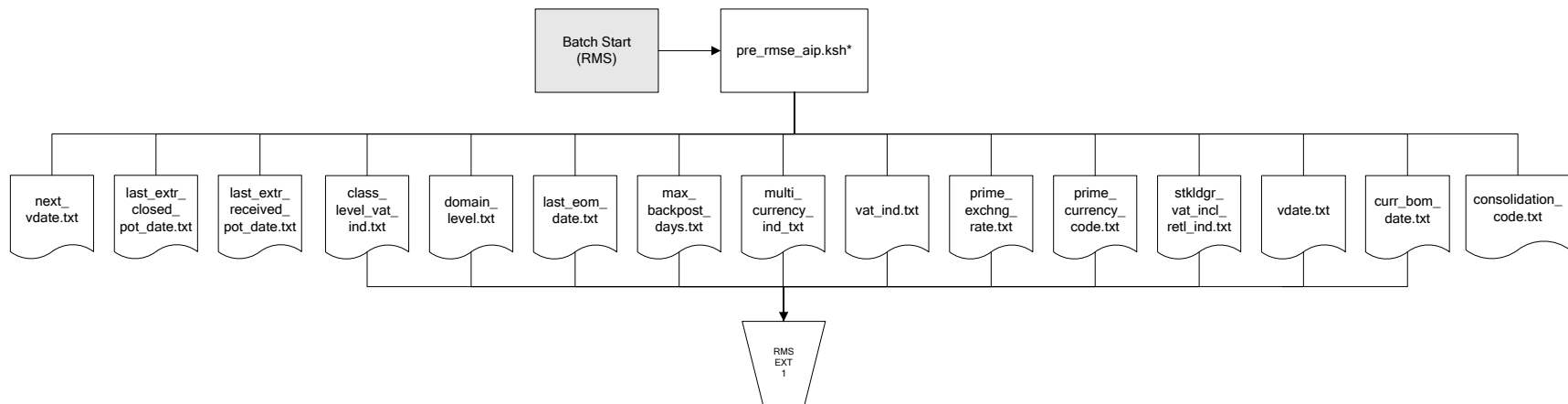

## RMS Foundation Data Extract Diagrams

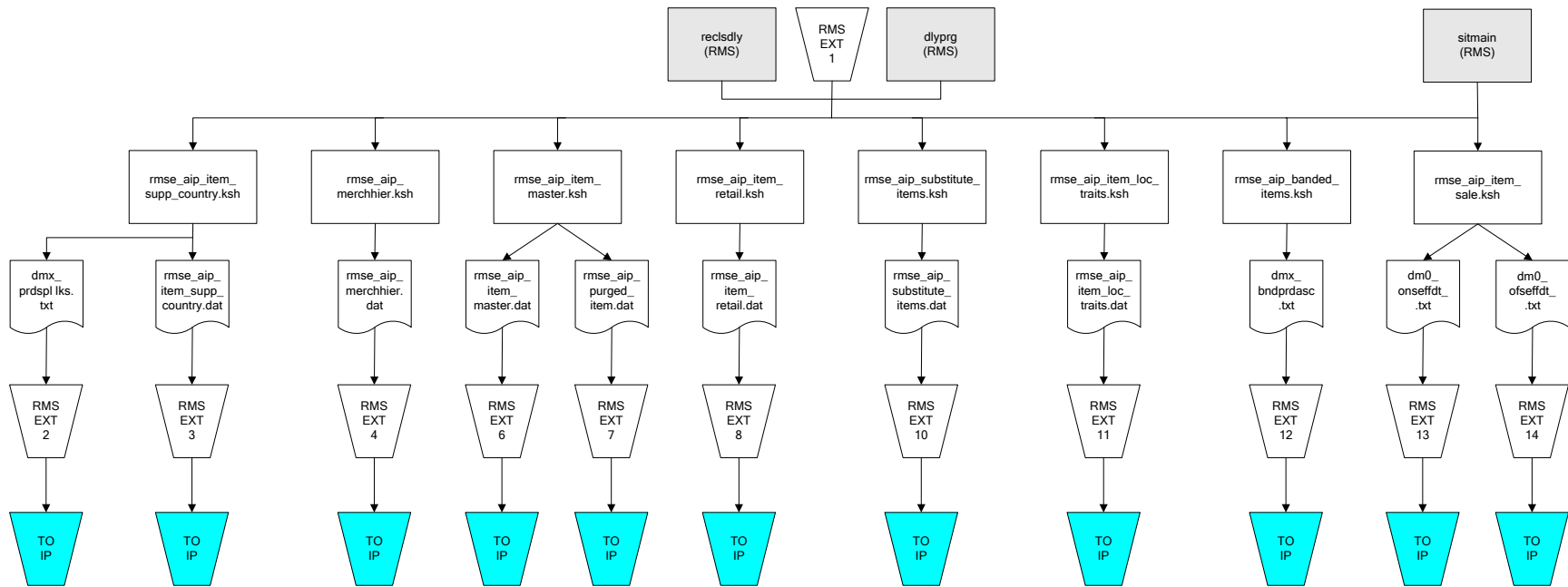

IP = Time-phased inventory planning tool

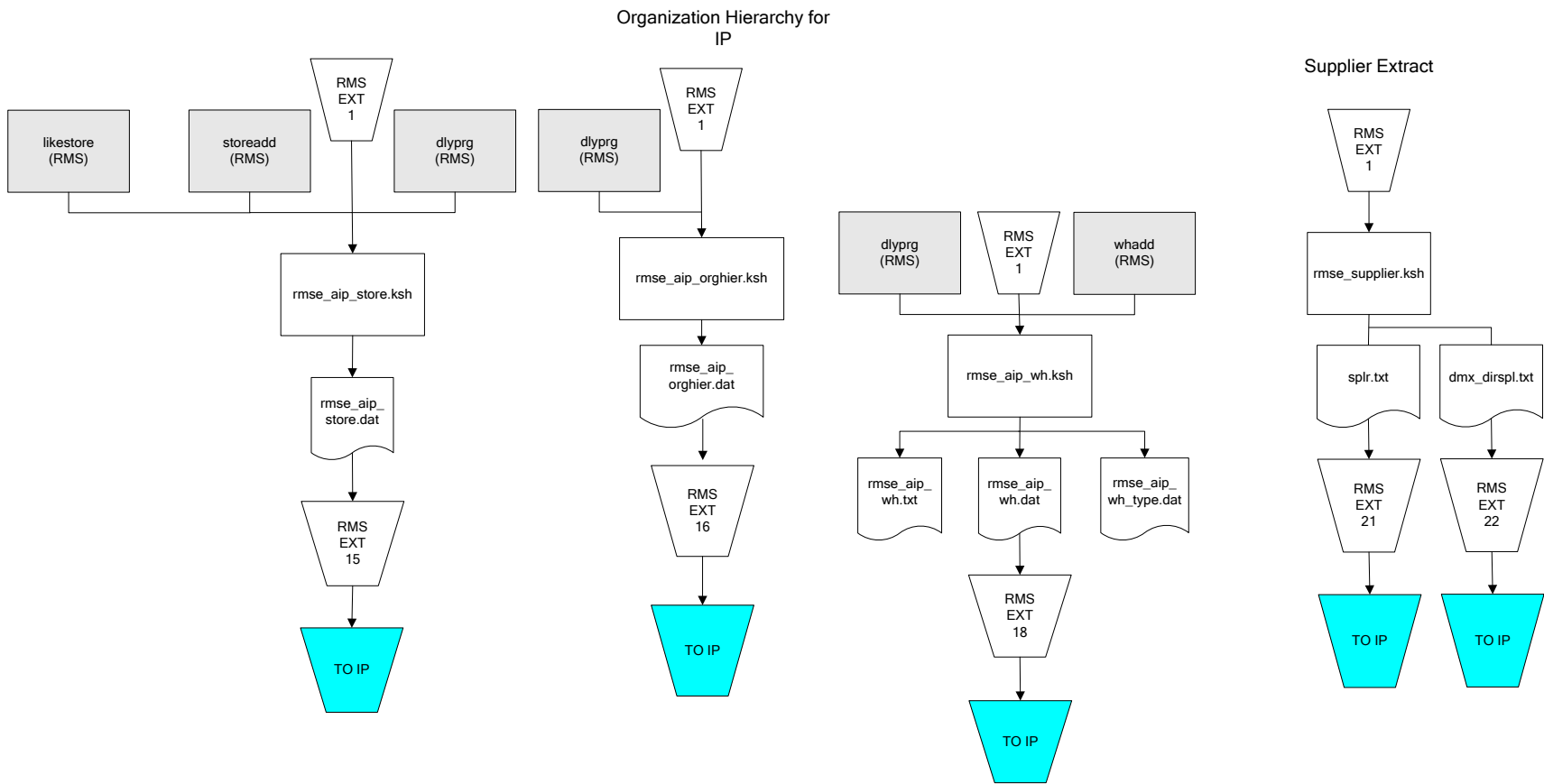

IP = Time-phased inventory planning tool

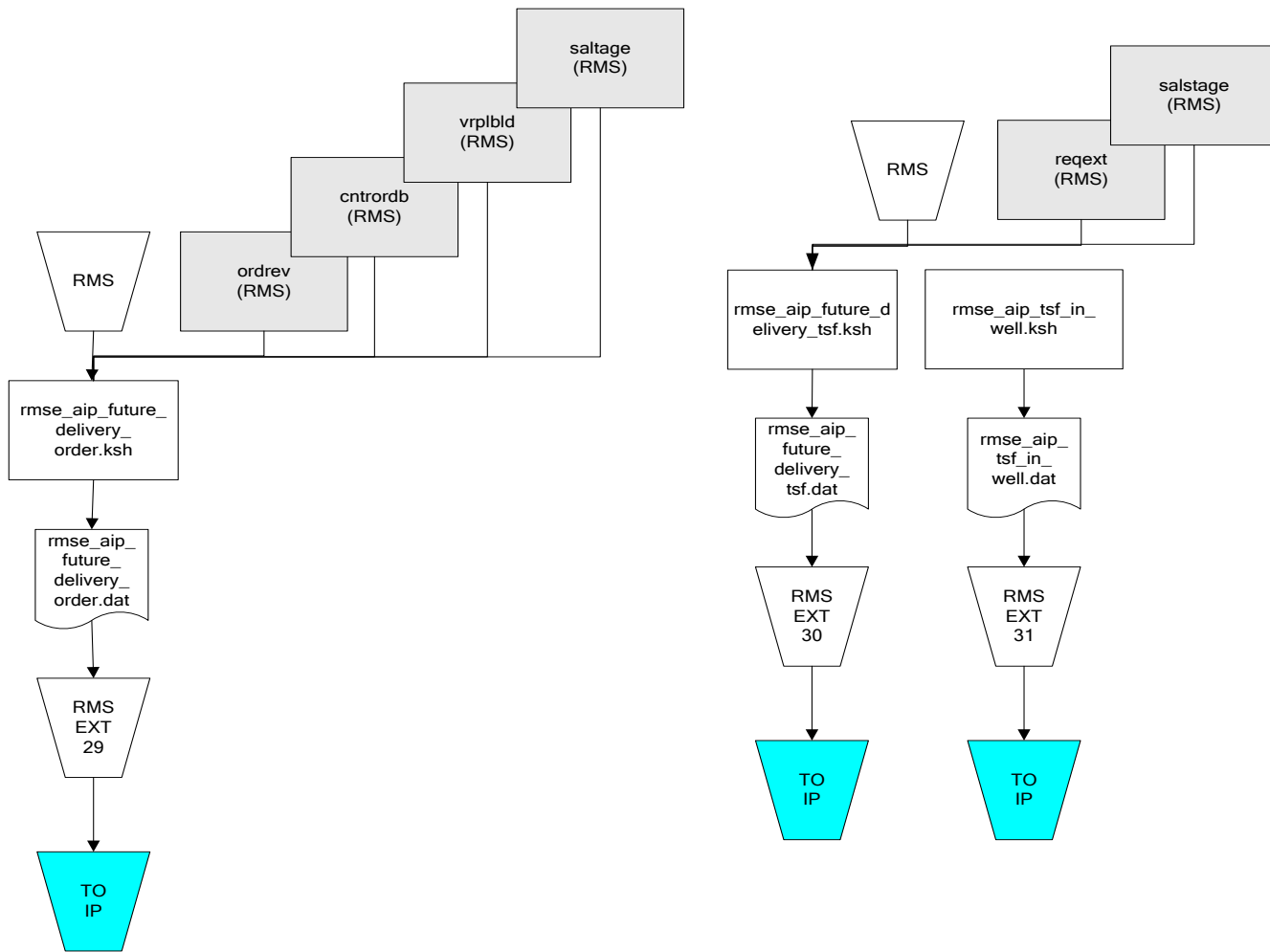

IP = Time-phased inventory planning tool

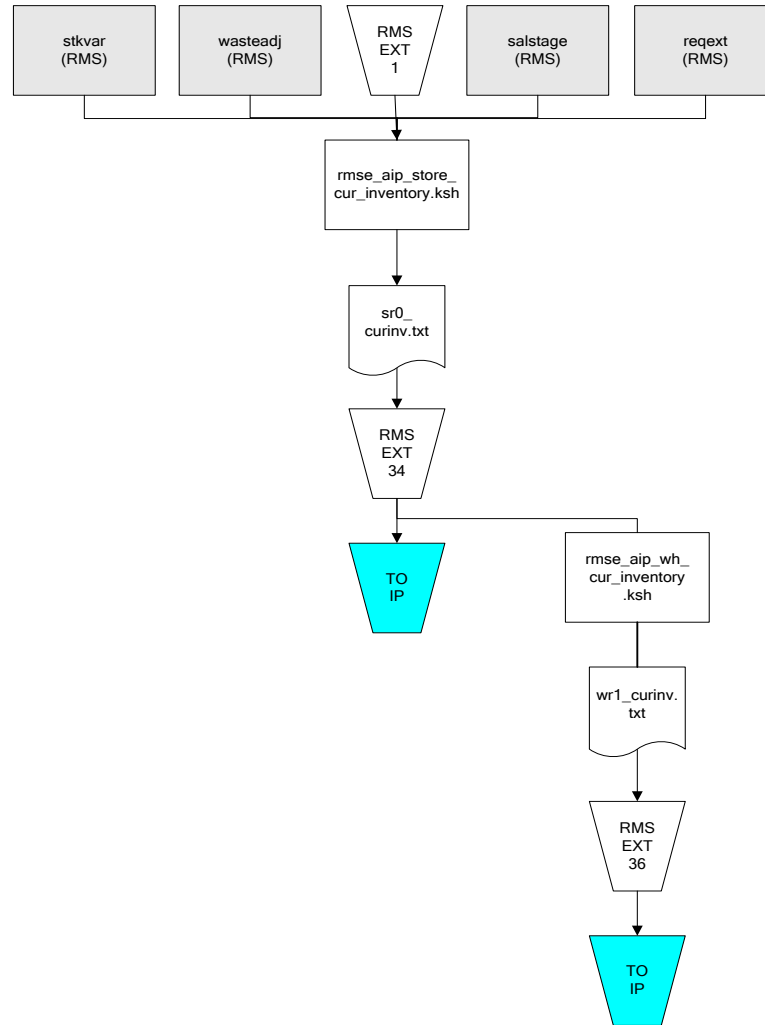
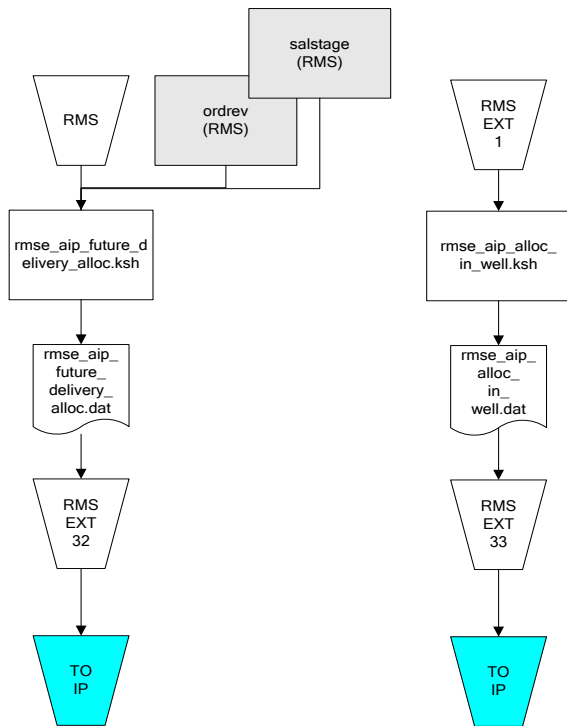

IP = Time-phased inventory planning tool

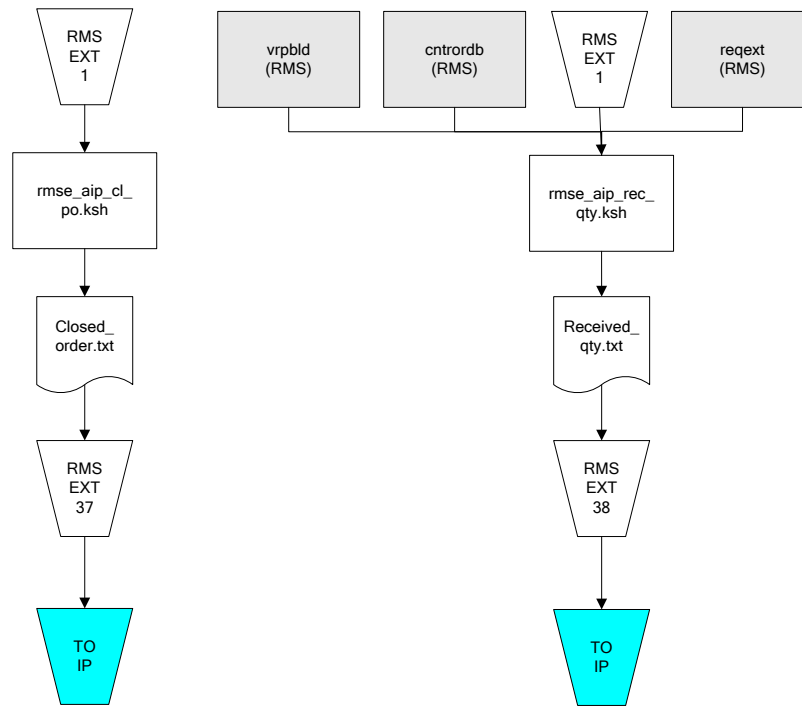

IP = Time-phased inventory planning tool

---

---

## Interface Diagrams for Allocation, AP and SPO

This chapter presents flow diagrams for RETL extract data processing from Assortment Planning (AP) and Size Profile Optimization (SPO) to Allocation. The Allocation program or output file is illustrated, along with the program or process that interfaces with the source. The diagrams illustrate the flow of the data after initial interface processing of the source.

Before setting up a program schedule, familiarize yourself with the functional and technical constraints associated with each program. See the *Oracle Retail Allocation Operations Guide* for more information about the modules shown in the following diagrams.





### Integration Extracts for Allocation

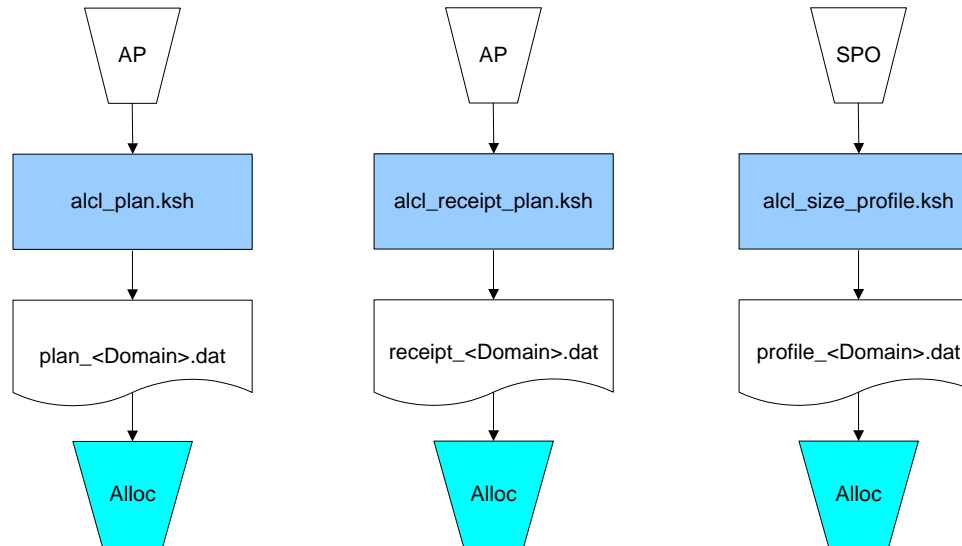

**Note:** See Allocation version-specific documentation to determine which of these programs apply to your version of Allocation.