

Oracle® Fusion Middleware

Understanding Security for Oracle WebLogic Server

11g Release 1 (10.3.3)

E13710-03

April 2010

This document introduces and explains the underlying concepts of the Oracle WebLogic Security Service.

Oracle Fusion Middleware Understanding Security for Oracle WebLogic Server, 11g Release 1 (10.3.3)

E13710-03

Copyright © 2007, 2010, Oracle and/or its affiliates. All rights reserved.

This software and related documentation are provided under a license agreement containing restrictions on use and disclosure and are protected by intellectual property laws. Except as expressly permitted in your license agreement or allowed by law, you may not use, copy, reproduce, translate, broadcast, modify, license, transmit, distribute, exhibit, perform, publish, or display any part, in any form, or by any means. Reverse engineering, disassembly, or decompilation of this software, unless required by law for interoperability, is prohibited.

The information contained herein is subject to change without notice and is not warranted to be error-free. If you find any errors, please report them to us in writing.

If this software or related documentation is delivered to the U.S. Government or anyone licensing it on behalf of the U.S. Government, the following notice is applicable:

U.S. GOVERNMENT RIGHTS Programs, software, databases, and related documentation and technical data delivered to U.S. Government customers are "commercial computer software" or "commercial technical data" pursuant to the applicable Federal Acquisition Regulation and agency-specific supplemental regulations. As such, the use, duplication, disclosure, modification, and adaptation shall be subject to the restrictions and license terms set forth in the applicable Government contract, and, to the extent applicable by the terms of the Government contract, the additional rights set forth in FAR 52.227-19, Commercial Computer Software License (December 2007). Oracle USA, Inc., 500 Oracle Parkway, Redwood City, CA 94065.

This software is developed for general use in a variety of information management applications. It is not developed or intended for use in any inherently dangerous applications, including applications which may create a risk of personal injury. If you use this software in dangerous applications, then you shall be responsible to take all appropriate fail-safe, backup, redundancy, and other measures to ensure the safe use of this software. Oracle Corporation and its affiliates disclaim any liability for any damages caused by use of this software in dangerous applications.

Oracle is a registered trademark of Oracle Corporation and/or its affiliates. Other names may be trademarks of their respective owners.

This software and documentation may provide access to or information on content, products, and services from third parties. Oracle Corporation and its affiliates are not responsible for and expressly disclaim all warranties of any kind with respect to third-party content, products, and services. Oracle Corporation and its affiliates will not be responsible for any loss, costs, or damages incurred due to your access to or use of third-party content, products, or services.

Contents

Preface	vii
Documentation Accessibility	vii
Conventions	vii
1 Introduction and Roadmap	
1.1 Document Scope.....	1-1
1.2 Document Audience.....	1-1
1.3 Guide to this Document.....	1-2
1.4 Related Information.....	1-2
1.5 Security Samples and Tutorials	1-3
1.5.1 Security Examples in the WebLogic Server Distribution.....	1-3
1.5.2 Additional Examples Available for Download.....	1-3
1.6 New and Changed Security Features In This Release.....	1-4
2 Overview of the WebLogic Security Service	
2.1 Introduction to the WebLogic Security Service.....	2-1
2.2 Features of the WebLogic Security Service	2-1
2.3 Oracle Platform Security Services (OPSS)	2-2
2.4 Balancing Ease of Use and Customizability.....	2-3
2.5 New and Changed Features in This Release.....	2-3
3 Security Fundamentals	
3.1 Auditing	3-1
3.2 Authentication.....	3-1
3.2.1 Subjects and Principals	3-2
3.2.2 Java Authentication and Authorization Service (JAAS)	3-3
3.2.2.1 JAAS LoginModules	3-3
3.2.2.2 JAAS Control Flags.....	3-3
3.2.3 CallbackHandlers	3-4
3.2.4 Mutual Authentication.....	3-4
3.2.5 Identity Assertion Providers and LoginModules	3-4
3.2.6 Identity Assertion and Tokens.....	3-5
3.2.7 Challenge Identity Assertion	3-5
3.2.8 Servlet Authentication Filters	3-5
3.2.9 Types of Authentication	3-6

3.2.9.1	Username/Password Authentication.....	3-6
3.2.9.2	Certificate Authentication	3-7
3.2.9.3	Digest Authentication	3-7
3.2.9.4	Perimeter Authentication	3-7
3.2.9.4.1	How is Perimeter Authentication Accomplished?	3-7
3.2.9.4.2	How Does WebLogic Server Support Perimeter Authentication?.....	3-8
3.3	Security Assertion Markup Language (SAML)	3-8
3.3.1	SAML Framework Concepts.....	3-9
3.3.2	SAML Components Provided in WebLogic Server	3-11
3.3.2.1	SAML Security Providers	3-12
3.3.2.2	Single Sign-On Services	3-12
3.3.2.3	Web Services Support for SAML Token Profile 1.1.....	3-12
3.4	Single Sign-On (SSO)	3-13
3.4.1	Web Browsers and HTTP Clients via SAML	3-13
3.4.2	Desktop Clients	3-14
3.5	Authorization	3-15
3.5.1	WebLogic Resources.....	3-15
3.5.2	Security Policies	3-16
3.5.3	ContextHandlers	3-16
3.5.4	Access Decisions	3-17
3.5.5	Adjudication	3-17
3.6	Identity and Trust	3-17
3.6.1	Private Keys.....	3-17
3.6.2	Digital Certificates	3-18
3.6.3	Certificate Authorities.....	3-18
3.6.4	Certificate Lookup and Validation.....	3-19
3.7	Secure Sockets Layer (SSL)	3-19
3.7.1	SSL Features.....	3-20
3.7.2	SSL Tunneling	3-21
3.7.3	One-way/Two-way SSL Authentication	3-22
3.7.4	Host Name Verification	3-22
3.7.5	Trust Managers	3-23
3.7.6	Asymmetric Key Algorithms	3-23
3.7.7	Symmetric Key Algorithms	3-23
3.7.8	Message Digest Algorithms	3-24
3.7.9	Cipher Suites	3-24
3.8	Firewalls	3-25
3.8.1	Connection Filters.....	3-25
3.8.2	Perimeter Authentication	3-26
3.9	Java EE and WebLogic Security	3-26
3.9.1	Java EE 6.0 Security Packages	3-26
3.9.1.1	The Java Secure Socket Extension (JSSE).....	3-26
3.9.1.2	Java Authentication and Authorization Services (JAAS)	3-26
3.9.1.3	The Java Security Manager	3-27
3.9.1.4	Java Cryptography Architecture and Java Cryptography Extensions (JCE)....	3-27
3.9.1.5	Java Authorization Contract for Containers (JACC).....	3-27
3.9.2	Common Secure Interoperability Version 2 (CSIV2)	3-28

4 Security Realms

4.1	Introduction to Security Realms	4-1
4.2	Users	4-1
4.3	Groups	4-2
4.4	Security Roles	4-2
4.5	Security Policies.....	4-3
4.6	Security Providers.....	4-3
4.6.1	Security Provider Databases	4-3
4.6.1.1	What Is a Security Provider Database?	4-3
4.6.1.2	Security Realms and Security Provider Databases.....	4-4
4.6.1.3	Embedded LDAP Server	4-5
4.6.1.4	RDBMS Security Store	4-5
4.6.2	Types of Security Providers	4-6
4.6.2.1	Authentication Providers	4-6
4.6.2.2	Identity Assertion Providers.....	4-7
4.6.2.3	Principal Validation Providers	4-8
4.6.2.4	Authorization Providers.....	4-9
4.6.2.5	Adjudication Providers.....	4-9
4.6.2.6	Role Mapping Providers.....	4-10
4.6.2.7	Auditing Providers.....	4-11
4.6.2.8	Credential Mapping Providers.....	4-11
4.6.2.9	Certificate Lookup and Validation Providers	4-12
4.6.2.10	Keystore Providers	4-12
4.6.2.11	Realm Adapter Providers.....	4-13
4.6.2.12	Security Provider Summary.....	4-13
4.6.3	Security Providers and Security Realms	4-14

5 WebLogic Security Service Architecture

5.1	WebLogic Security Framework	5-1
5.1.1	The Authentication Process.....	5-2
5.1.2	The Identity Assertion Process	5-3
5.1.3	The Principal Validation Process.....	5-3
5.1.4	The Authorization Process	5-4
5.1.5	The Adjudication Process	5-5
5.1.6	The Role Mapping Process	5-5
5.1.7	The Auditing Process	5-6
5.1.8	The Credential Mapping Process	5-6
5.1.9	The Certificate Lookup and Validation Process.....	5-7
5.2	Single Sign-On with the WebLogic Security Framework	5-8
5.2.1	Single Sign-On with SAML 1.1	5-8
5.2.1.1	WebLogic Server Acting a SAML 1.1 Source Site	5-8
5.2.1.1.1	POST Profile.....	5-8
5.2.1.1.2	Artifact Profile.....	5-9
5.2.1.2	Weblogic Server Acting as SAML 1.1 Destination Site	5-9
5.2.1.2.1	POST Profile.....	5-10
5.2.1.2.2	Artifact Profile.....	5-10

5.2.2	Single Sign-On and SAML 2.0.....	5-11
5.2.2.1	Service Provider Initiated Single Sign-On	5-11
5.2.2.2	Identity Provider Initiated Single Sign-On	5-13
5.2.3	Desktop SSO Process.....	5-14
5.3	SAML Token Profile Support in WebLogic Web Services.....	5-15
5.3.1	Sender-Vouches Assertions.....	5-15
5.3.2	Holder-of-Key Assertion	5-16
5.4	The Security Service Provider Interfaces (SSPIs).....	5-17
5.5	Weblogic Security Providers	5-17
5.5.1	WebLogic Authentication Provider	5-19
5.5.2	Alternative Authentication Providers	5-19
5.5.3	Password Validation Provider.....	5-20
5.5.4	WebLogic Identity Assertion Provider.....	5-20
5.5.5	SAML Identity Assertion Provider for SAML 1.1.....	5-21
5.5.6	SAML 2.0 Identity Assertion Provider	5-21
5.5.7	Negotiate Identity Assertion Provider	5-21
5.5.8	WebLogic Principal Validation Provider	5-22
5.5.9	WebLogic Authorization Provider	5-22
5.5.10	WebLogic Adjudication Provider	5-23
5.5.11	WebLogic Role Mapping Provider	5-23
5.5.12	WebLogic Auditing Provider.....	5-24
5.5.13	WebLogic Credential Mapping Provider	5-24
5.5.14	SAML Credential Mapping Provider for SAML 1.1.....	5-24
5.5.15	SAML 2.0 Credential Mapping Provider	5-25
5.5.16	PKI Credential Mapping Provider	5-25
5.5.17	WebLogic CertPath Provider	5-25
5.5.18	Certificate Registry	5-25
5.5.19	Versionable Application Provider.....	5-26
5.5.20	WebLogic Keystore Provider	5-26
5.5.21	WebLogic Realm Adapter Providers	5-26

Glossary

Preface

This preface describes the document accessibility features and conventions used in this guide—*Understanding Security for Oracle WebLogic Server*.

Documentation Accessibility

Our goal is to make Oracle products, services, and supporting documentation accessible to all users, including users that are disabled. To that end, our documentation includes features that make information available to users of assistive technology. This documentation is available in HTML format, and contains markup to facilitate access by the disabled community. Accessibility standards will continue to evolve over time, and Oracle is actively engaged with other market-leading technology vendors to address technical obstacles so that our documentation can be accessible to all of our customers. For more information, visit the Oracle Accessibility Program Web site at <http://www.oracle.com/accessibility/>.

Accessibility of Code Examples in Documentation

Screen readers may not always correctly read the code examples in this document. The conventions for writing code require that closing braces should appear on an otherwise empty line; however, some screen readers may not always read a line of text that consists solely of a bracket or brace.

Accessibility of Links to External Web Sites in Documentation

This documentation may contain links to Web sites of other companies or organizations that Oracle does not own or control. Oracle neither evaluates nor makes any representations regarding the accessibility of these Web sites.

Access to Oracle Support

Oracle customers have access to electronic support through My Oracle Support. For information, visit <http://www.oracle.com/support/contact.html> or visit <http://www.oracle.com/accessibility/support.html> if you are hearing impaired.

Conventions

The following text conventions are used in this document:

Convention	Meaning
boldface	Boldface type indicates graphical user interface elements associated with an action, or terms defined in text or the glossary.

Convention	Meaning
<i>italic</i>	Italic type indicates book titles, emphasis, or placeholder variables for which you supply particular values.
monospace	Monospace type indicates commands within a paragraph, URLs, code in examples, text that appears on the screen, or text that you enter.

Introduction and Roadmap

The following sections describe the contents and organization of this guide - *Understanding WebLogic Security*.

- [Section 1.1, "Document Scope"](#)
- [Section 1.2, "Document Audience"](#)
- [Section 1.3, "Guide to this Document"](#)
- [Section 1.4, "Related Information"](#)
- [Section 1.5, "Security Samples and Tutorials"](#)

1.1 Document Scope

While other security documents in the WebLogic Server documentation set guide users through specific tasks - such as programming WebLogic security, developing a custom security provider, or managing the WebLogic Security Service - this guide is intended for all users of the WebLogic Security Service. Thus, this document is the starting point for understanding the WebLogic Security Service.

Note: The WebLogic Security Service involves many unique terms. Before reading this manual, familiarize yourself with the terms in [Glossary](#).

1.2 Document Audience

This document is intended for the following audiences:

- **Application Architects** - Architects who, in addition to setting security goals and designing the overall security architecture for their organizations, evaluate WebLogic Server security features and determine how to best implement them. Application Architects have in-depth knowledge of Java programming, Java security, and network security, as well as knowledge of security systems and leading-edge, security technologies and tools.
- **Security Developers** - Developers who focus on defining the system architecture and infrastructure for security products that integrate into WebLogic Server and on developing custom security providers for use with WebLogic Server. They work with Application Architects to ensure that the security architecture is implemented according to design and that no security holes are introduced, and work with Server Administrators to ensure that security is properly configured. Security Developers have a solid understanding of security concepts, including authentication, authorization, auditing (AAA), in-depth knowledge of Java

(including Java Management eXtensions (JMX), and working knowledge of WebLogic Server and security provider functionality.

- **Application Developers** - Developers who are Java programmers that focus on developing client applications, adding security to Web applications and Enterprise JavaBeans (EJBs), and working with other engineering, quality assurance (QA), and database teams to implement security features. Application Developers have in-depth/working knowledge of Java (including Java Platform, Enterprise Edition (Java EE) Version 5 components such as servlets/JSPs and JSEE) and Java security.
- **Server Administrators** - Administrators work closely with Application Architects to design a security scheme for the server and the applications running on the server, to identify potential security risks, and to propose configurations that prevent security problems. Related responsibilities may include maintaining critical production systems, configuring and managing security realms, implementing authentication and authorization schemes for server and application resources, upgrading security features, and maintaining security provider databases. Server Administrators have in-depth knowledge of the Java security architecture, including Web services, Web application and EJB security, Public Key security, SSL, and Security Assertion Markup Language (SAML).
- **Application Administrators** - Administrators who work with Server Administrators to implement and maintain security configurations and authentication and authorization schemes, and to set up and maintain access to deployed application resources in defined security realms. Application Administrators have general knowledge of security concepts and the Java Security architecture. They understand Java, XML, deployment descriptors, and can identify security events in server and audit logs.

1.3 Guide to this Document

This document is organized as follows:

- [Chapter 2, "Overview of the WebLogic Security Service"](#) introduces the WebLogic Security Service, describes the audiences of this document, lists its key features, and gives a brief list what has changed in this release.
- [Chapter 3, "Security Fundamentals"](#) describes security concepts as they relate to WebLogic Server security. This section includes discussions of auditing, authentication, authorization, Secure Sockets Layer (SSL), firewalls, and the relationship between Java EE and WebLogic security.
- [Chapter 4, "Security Realms"](#) describes security realms, which are used to protect WebLogic resources.
- [Chapter 5, "WebLogic Security Service Architecture"](#) describes the WebLogic Server Security architecture. This section includes discussions of the WebLogic Security Framework, the Security Service Provider Interfaces (SSPIs), and the WebLogic security providers that are included as part of the product.
- [Glossary](#) defines key terms that you will encounter throughout the WebLogic Server security documentation.

1.4 Related Information

The following WebLogic Server documents contain information that is relevant to the WebLogic Security Service:

- *Securing Oracle WebLogic Server* - This document explains how to configure security for WebLogic Server and how to use Compatibility security.
- *Developing Security Providers for Oracle WebLogic Server* - This document provides security vendors and application developers with the information needed to develop custom security providers that can be used with WebLogic Server.
- *Securing a Production Environment for Oracle WebLogic Server* - This document highlights essential security measures for you to consider before you deploy WebLogic Server into a production environment.
- *Securing Resources Using Roles and Policies for Oracle WebLogic Server* - This document introduces the various types of WebLogic resources, and provides information that allows you to secure these resources using WebLogic Server. The current version of this document primarily focuses on securing URL (Web) and Enterprise JavaBean (EJB) resources.
- *Upgrade Guide for Oracle WebLogic Server* - This document provides procedures and other information you need to upgrade 6.x and earlier versions of WebLogic Server to the latest version. It also provides information about moving applications from a 6.x or earlier version. For specific information on upgrading WebLogic Server security, see "Security" in the *Upgrade Guide for Oracle WebLogic Server*.
- Javadocs for WebLogic Classes - This document provides reference documentation for the WebLogic security packages that are provided with and supported by this release of WebLogic Server.

1.5 Security Samples and Tutorials

In addition to the documents listed in [Section 1.4, "Related Information"](#), Oracle provides a variety of code samples for developers.

1.5.1 Security Examples in the WebLogic Server Distribution

WebLogic Server optionally installs API code examples in `WL_HOME\samples\server\examples\src\examples\security`, where `WL_HOME` is the top-level directory of your WebLogic Server installation. You can start the examples server, and obtain information about the samples and how to run them from the WebLogic Server Start menu.

The following examples illustrate WebLogic security features:

- Java Authentication and Authorization Service
- Outbound and Two-way SSL

1.5.2 Additional Examples Available for Download

Additional API examples are available for download at <https://www.samplecode.oracle.com>. These examples are distributed as .zip files that you can unzip into an existing WebLogic Server samples directory structure.

You build and run the downloadable examples in the same manner as you would an installed WebLogic Server example. See the download pages of individual examples for more information.

1.6 New and Changed Security Features In This Release

For a comprehensive listing of the new WebLogic Server features introduced in this release, "What's New in Oracle WebLogic Server" in *Oracle Fusion Middleware What's New in Oracle WebLogic Server*.

Overview of the WebLogic Security Service

The following sections introduce the WebLogic Security Service and its features:

- [Section 2.1, "Introduction to the WebLogic Security Service"](#)
- [Section 2.2, "Features of the WebLogic Security Service"](#)
- [Section 2.3, "Oracle Platform Security Services \(OPSS\)"](#)
- [Section 2.4, "Balancing Ease of Use and Customizability"](#)
- [Section 2.5, "New and Changed Features in This Release"](#)

2.1 Introduction to the WebLogic Security Service

Deploying, managing, and maintaining security is a huge challenge for an information technology (IT) organization that is providing new and expanded services to customers using the Web. To serve a worldwide network of Web-based users, an IT organization must address the fundamental issues of maintaining the confidentiality, integrity and availability of the system and its data. Challenges to security involve every component of the system, from the network itself to the individual client machines. Security across the infrastructure is a complex business that requires vigilance as well as established and well-communicated security policies and procedures.

WebLogic Server includes a security architecture that provides a unique and secure foundation for applications that are available via the Web. By taking advantage of the security features in WebLogic Server, enterprises benefit from a comprehensive, flexible security infrastructure designed to address the security challenges of making applications available on the Web. WebLogic security can be used standalone to secure WebLogic Server applications or as part of an enterprise-wide, security management system that represents a best-in-breed, security management solution.

2.2 Features of the WebLogic Security Service

The open, flexible security architecture of WebLogic Server delivers advantages to all levels of users and introduces an advanced security design for application servers. Companies now have a unique application server security solution that, together with clear and well-documented security policies and procedures, can assure the confidentiality, integrity and availability of the server and its data.

The key features of the WebLogic Security Service include:

- A comprehensive and standards-based design.

- End-to-end security for WebLogic Server-hosted applications, from the mainframe to the Web browser.
- Legacy security schemes that integrate with WebLogic Server security, allowing companies to leverage existing investments.
- Security tools that are integrated into a flexible, unified system to ease security management across the enterprise.
- Easy customization of application security to business requirements through mapping of company business rules to security policies.
- A consistent model for applying security policies to Java EE and application-defined resources.
- Easy updates to security policies. This release includes usability enhancements to the process of creating security policies as well as additional expressions that control access to WebLogic resources.
- Easy adaptability for customized security solutions.
- A modularized architecture, so that security infrastructures can change over time to meet the requirements of a particular company.
- Support for configuring multiple security providers, as part of a transition scheme or upgrade path.
- A separation between security details and application infrastructure, making security easier to deploy, manage, maintain, and modify as requirements change.
- Default WebLogic security providers that provide you with a working security scheme out of the box. This release supports additional authentication stores such as databases, and gives the option to configure an external RDBMS system as a datastore to be used by select security providers.
- Customization of security schemes using custom security providers
- Unified management of security rules, security policies, and security providers through the WebLogic Server Administration Console.
- Support for standard Java EE security technologies such as the Java Authentication and Authorization Service (JAAS), Java Secure Sockets Extensions (JSSE), Java Cryptography Extensions (JCE), and Java Authorization Contract for Containers (JACC).
- A foundation for Web services security including support for Security Assertion Markup Language (SAML) 1.1 and 2.0.
- Capabilities which allow WebLogic Server to participate in single sign-on (SSO) with web sites, web applications, and desktop clients.
- A framework for managing public keys which includes certificate lookup, verification, validation, and revocation as well as a certificate registry.

2.3 Oracle Platform Security Services (OPSS)

Oracle Platform Security Services (OPSS) provides enterprise product development teams, systems integrators (SIs), and independent software vendors (ISVs) with a standards-based, portable, integrated, enterprise-grade security framework for Java Standard Edition (Java SE) and Java Enterprise Edition (Java EE) applications.

OPSS provides an abstraction layer in the form of standards-based application programming interfaces (APIs) that insulates developers from security and identity

management implementation details. With OPSS, developers don't need to know the details of cryptographic key management or interfaces with user repositories and other identity management infrastructures. With OPSS, in-house developed applications, third-party applications, and integrated applications all benefit from the same uniform security, identity management, and audit services across the enterprise. OPSS is available as part of WebLogic Server.

For more information about OPSS, see *Oracle Fusion Middleware Security Overview*.

2.4 Balancing Ease of Use and Customizability

The components and services of the WebLogic Security Service seek to strike a balance between ease of use, manageability (for end users and administrators), and customizability (for application developers and security developers). The following paragraphs highlight some examples:

Easy to use: WebLogic Server provides a Domain Configuration Wizard to help with the creation of new domains with an administration server, managed servers, and optionally, a cluster, or with extending existing domains by adding individual servers. The Domain Configuration Wizard also automatically generates a config.xml file and start scripts for the servers you choose to add to the new domain.

Manageable: Administrators who configure and deploy applications in the WebLogic Server environment can use the WebLogic security providers included with the product. These default providers support all required security functions, out of the box. An administrator can store security data in the WebLogic Server-supplied, security store (an embedded, special-purpose, LDAP directory server) or use an external LDAP server, database, or user source. To simplify the configuration and management of security in WebLogic Server, a robust, default security configuration is provided.

Customizable: For application developers, WebLogic Server supports the WebLogic security API and Java EE security standards such as JAAS, JSS, JCE, and JACC. Using these APIs and standards, you can create a fine-grained and customized security environment for applications that connect to WebLogic Server.

For security developers, the WebLogic Server Security Service Provider Interfaces (SSPIs) support the development of custom security providers for the WebLogic Server environment.

2.5 New and Changed Features in This Release

See "What's New in Oracle WebLogic Server" for new and changed features in this release.

Security Fundamentals

The following sections describe security fundamentals as they relate to security in WebLogic Server:

- [Section 3.1, "Auditing"](#)
- [Section 3.2, "Authentication"](#)
- [Section 3.3, "Security Assertion Markup Language \(SAML\)"](#)
- [Section 3.4, "Single Sign-On \(SSO\)"](#)
- [Section 3.5, "Authorization"](#)
- [Section 3.6, "Identity and Trust"](#)
- [Section 3.7, "Secure Sockets Layer \(SSL\)"](#)
- [Section 3.8, "Firewalls"](#)
- [Section 3.9, "Java EE and WebLogic Security"](#)

3.1 Auditing

Auditing is the process whereby information about operating requests and the outcome of those requests are collected, stored, and distributed for the purposes of non-repudiation. In other words, auditing provides an electronic trail of computer activity. In the WebLogic Server security architecture, an Auditing provider is used to provide auditing services.

If configured, the WebLogic Security Framework will call through to an Auditing provider before and after security operations (such as authentication or authorization) have been performed, when changes to the domain configuration are made, or when management operations on any resources in the domain are invoked. The decision to audit a particular event is made by the Auditing provider itself and can be based on specific audit criteria and/or severity levels. The records containing the audit information may be written to output repositories such as an LDAP server, database, and a simple file.

3.2 Authentication

Authentication is the mechanism by which callers prove that they are acting on behalf of specific users or systems. Authentication answers the question, "Who are you?" using credentials such as username/password combinations.

In WebLogic Server, Authentication providers are used to prove the identity of users or system processes. Authentication providers also remember, transport, and make

identity information available to various components of a system (via subjects) when needed. During the authentication process, a Principal Validation provider provides additional security protections for the principals (users and groups) contained within the subject by signing and verifying the authenticity of those principals.

The following sections describe authentication concepts and functionality.

- [Section 3.2.1, "Subjects and Principals"](#)
- [Section 3.2.2, "Java Authentication and Authorization Service \(JAAS\)"](#)
- [Section 3.2.3, "CallbackHandlers"](#)
- [Section 3.2.4, "Mutual Authentication"](#)
- [Section 3.2.8, "Servlet Authentication Filters"](#)
- [Section 3.2.5, "Identity Assertion Providers and LoginModules"](#)
- [Section 3.2.6, "Identity Assertion and Tokens"](#)
- [Section 3.2.9, "Types of Authentication"](#)

3.2.1 Subjects and Principals

Subjects and principals are closely related.

A **principal** is an identity assigned to a user or group as a result of authentication. Both users and groups can be used as principals by application servers such as WebLogic Server. The Java Authentication and Authorization Service (JAAS) requires that **subjects** be used as containers for authentication information, including principals.

[Figure 3–1](#) illustrates the relationships among users, groups, principals, and subjects.

Figure 3–1 Relationships Among Users, Groups, Principals, and Subjects

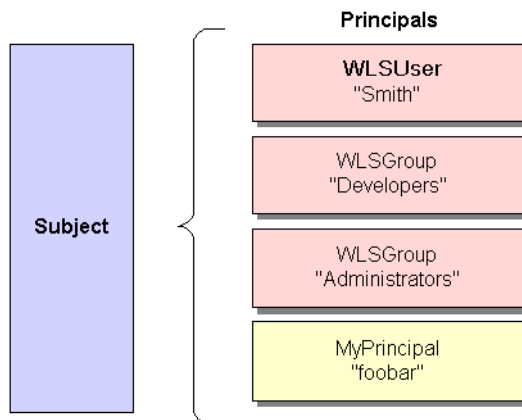

As part of a successful authentication, principals are signed and stored in a subject for future use. A Principal Validation provider signs principals, and an Authentication provider's LoginModule actually stores the principals in the subject. Later, when a caller attempts to access a principal stored within a subject, a Principal Validation provider verifies that the principal has not been altered since it was signed, and the principal is returned to the caller (assuming all other security conditions are met).

Any principal that is going to represent a WebLogic Server user or group needs to implement the `WLSUser` and `WLSGroup` interfaces, which are available in the `weblogic.security.spi` package.

3.2.2 Java Authentication and Authorization Service (JAAS)

Whether the client is an application, applet, Enterprise JavaBean (EJB), or servlet that requires authentication, WebLogic Server uses the Java Authentication and Authorization Service (JAAS) classes to reliably and securely authenticate to the client. JAAS implements a Java version of the Pluggable Authentication Module (PAM) framework, which permits applications to remain independent from underlying authentication technologies. Therefore, the PAM framework allows the use of new or updated authentication technologies without requiring modifications to your application.

WebLogic Server uses JAAS for remote fat-client authentication, and internally for authentication. Therefore, only developers of custom Authentication providers and developers of remote fat client applications need to be involved with JAAS directly. Users of thin clients or developers of within-container fat client applications (for example, those calling an Enterprise JavaBean (EJB) from a servlet) do not require the direct use or knowledge of JAAS.

3.2.2.1 JAAS LoginModules

A **LoginModule** is the work-horse of authentication: all LoginModules are responsible for authenticating users within the security realm and for populating a subject with the necessary principals (users/groups). LoginModules that are *not* used for perimeter authentication also verify the proof material submitted (for example, a user's password).

If there are multiple Authentication providers configured in a security realm, each of the Authentication providers' LoginModules will store principals within the same subject. Therefore, if a principal that represents a WebLogic Server user (that is, an implementation of the `WLSUser` interface) named "Joe" is added to the subject by one Authentication provider's LoginModule, any other Authentication provider in the security realm should be referring to the same person when they encounter "Joe". In other words, the other Authentication providers' LoginModules should not attempt to add another principal to the subject that represents a WebLogic Server user (for example, named "Joseph") to refer to the same person. However, it is acceptable for another Authentication provider's LoginModule to add a principal of a type other than `WLSUser` with the name "Joseph".

3.2.2.2 JAAS Control Flags

If a security realm has multiple Authentication providers configured, the Control Flag attribute on the Authenticator provider determines the ordered execution of the Authentication providers. The values for the Control Flag attribute are as follows:

- **REQUIRED** - This LoginModule must succeed. Even if it fails, authentication proceeds down the list of LoginModules for the configured Authentication providers. This setting is the default.
- **REQUISITE** - This LoginModule must succeed. If other Authentication providers are configured and this LoginModule succeeds, authentication proceeds down the list of LoginModules. Otherwise, return control to the application.
- **SUFFICIENT** - This LoginModule needs not succeed. If it does succeed, return control to the application. If it fails and other Authentication providers are configured, authentication proceeds down the LoginModule list.
- **OPTIONAL** - The user is allowed to pass or fail the authentication test of this Authentication providers. However, if all Authentication providers configured in a security realm have the JAAS Control Flag set to **OPTIONAL**, the user must pass the authentication test of one of the configured providers.

3.2.3 CallbackHandlers

A `CallbackHandler` is a highly-flexible JAAS standard that allows a variable number of arguments to be passed as complex objects to a method. There are three types of `CallbackHandlers`: `NameCallback`, `PasswordCallback`, and `TextInputCallback`, all of which are part of the `javax.security.auth.callback` package. The `NameCallback` and `PasswordCallback` return the username and password, respectively. `TextInputCallback` can be used to access the data users enter into any additional fields on a login form (that is, fields other than those for obtaining the username and password). When used, there should be one `TextInputCallback` per additional form field, and the prompt string of each `TextInputCallback` must match the field name in the form. WebLogic Server only uses the `TextInputCallback` for form-based Web application login.

An application implements a `CallbackHandler` and passes it to underlying security services so that they may interact with the application to retrieve specific authentication data, such as usernames and passwords, or to display certain information, such as error and warning messages.

`CallbackHandlers` are implemented in an application-dependent fashion. For example, implementations for an application with a graphical user interface (GUI) may pop up windows to prompt for requested information or to display error messages. An implementation may also choose to obtain requested information from an alternate source without asking the user.

Underlying security services make requests for different types of information by passing individual `Callbacks` to the `CallbackHandler`. The `CallbackHandler` implementation decides how to retrieve and display information depending on the `Callbacks` passed to it. For example, if the underlying service needs a username and password to authenticate a user, it uses a `NameCallback` and `PasswordCallback`. The `CallbackHandler` can then choose to prompt for a username and password serially, or to prompt for both in a single window.

3.2.4 Mutual Authentication

With **mutual authentication**, both the client and the server are required to authenticate themselves to each other. This can be done by means of certificates or other forms of proof material. WebLogic Server supports two-way SSL authentication, which is a form of mutual authentication. However, by strict definition, mutual authentication takes place at higher layers in the protocol stack than does SSL authentication. For more information, see [Section 3.7.3, "One-way/Two-way SSL Authentication"](#).

3.2.5 Identity Assertion Providers and LoginModules

When used with a `LoginModule`, Identity Assertion providers support single sign-on. For example, an Identity Assertion provider can process a SAML assertion so that users are not asked to sign on more than once.

The `LoginModule` that an Identity Assertion provider uses can be:

- Part of a custom Authentication provider you develop.
- Part of the WebLogic Authentication provider that Oracle developed and packaged with WebLogic Server.
- Part of a third-party security vendor's Authentication provider.

Unlike in a simple authentication situation, the LoginModules that Identity Assertion providers use *do not* verify proof material such as usernames and passwords; they simply verify that the user exists.

3.2.6 Identity Assertion and Tokens

Identity Assertion providers support user name mappers, which map a valid token to a WebLogic Server user. You develop Identity Assertion providers to support the specific types of tokens that you will be using to assert the identities of users or system processes. You can develop an Identity Assertion provider to support multiple token types, but the WebLogic Server administrator must configure the Identity Assertion provider so that it validates only one "active" token type. While you can have multiple Identity Assertion providers in a security realm with *the ability* to validate the same token type, only one Identity Assertion provider can actually perform this validation.

Note: To use the WebLogic Identity Assertion provider for X.501 and X.509 certificates, you have the option of using the default user name mapper that is supplied with the WebLogic Server product (`weblogic.security.providers.authentication.DefaultUserNameMapperImpl`) or providing your own implementation of the `weblogic.security.providers.authentication.UserNameMapper` interface. For more information, see "Do You Need to Develop a Custom Identity Assertion Provider?" in *Developing Security Providers for Oracle WebLogic Server*.

3.2.7 Challenge Identity Assertion

Challenge identity assertion schemes provide for multiple challenges, responses messages, and state. A WebLogic Server security realm can include security providers that support authentication protocols such as Microsoft's Windows NT Challenge/Response (NTLM), Simple and Protected GSS-API Negotiation Mechanism (SPNEGO), and other challenge/response authentication mechanisms. WebLogic Server includes a SPNEGO security provider, named the Negotiate Identity Assertion provider. You can develop and deploy security providers that implement NTLM or other challenge/response authentication mechanisms. For more information, see *Developing Security Providers for Oracle WebLogic Server*.

3.2.8 Servlet Authentication Filters

As defined by the Java Servlet API 2.3 specification, filters are objects that can modify a request or response. Filters are preprocessors of the request before it reaches the servlet, and/or postprocessors of the response leaving the servlet. Filters provide the ability to encapsulate recurring tasks in reusable units.

Filters can be used as a substitute for container-based authentication but there are some drawbacks to this design:

- As specified by the Java Servlet API 2.3 specification, filters are run after authentication and authorization. If filters are used for authentication, they must also be used for authorization thereby preventing container-managed authorization from being used. Most use cases that require extensions to the authentication process in the Servlet container do not require extensions to the authorization process. Having to implement the authorization process in a filter is awkward, time consuming, and error-prone.

- J2EE filters are defined per Web application. Code for a filter must reside in the WAR file for the Web application and the configuration must be defined in the `web.xml` file. An authentication mechanism is typically determined by the system administrator after an application is written (not by the programmer who created the WAR file). The mechanism can be changed during the lifetime of an application, and is desired for all (or at least most) applications in a site.

A **Servlet Authentication filter** is an extension of the filter object that overcomes these drawbacks, allowing filters to replace container-based authentication.

JAAS LoginModules (within a WebLogic Authentication provider) can be used for customization of the login process. Servlet Authentication filters enable the LoginModule model allowing the authentication provider to control the actual conversation with the client. Customizing the location of the user database, the types of proof material required to execute a login, or the population of the Subject with groups is implemented via a LoginModule. On the other hand, redirecting to a remote site to execute the login, extracting login information out of the query string, and negotiating a login mechanism with a browser is implemented via a Servlet Authentication filter.

3.2.9 Types of Authentication

WebLogic Server users must be authenticated whenever they request access to a protected WebLogic resource. For this reason, each user is required to provide a credential (for example, a password) to WebLogic Server. The following types of authentication are supported by the WebLogic Authentication provider that is included in the WebLogic Server distribution:

- [Section 3.2.9.1, "Username/Password Authentication"](#)
- [Section 3.2.9.2, "Certificate Authentication"](#)
- [Section 3.2.9.3, "Digest Authentication"](#)
- [Section 3.2.9.4, "Perimeter Authentication"](#)

WebLogic Server can use the WebLogic Authentication provider that is provided as part of the WebLogic Server product or custom security providers to perform the different types of authentication. For information on the WebLogic Authentication provider and how to configure authentication, see [Section 5.1.1, "The Authentication Process"](#) and the following sections in *Securing Oracle WebLogic Server*:

- [Configuring WebLogic Security Providers](#)
- [Configuring SSL](#)

3.2.9.1 Username/Password Authentication

In username/password authentication, a user ID and password are requested from the user and sent to WebLogic Server. WebLogic Server checks the information and if it is trustworthy, grants access to the protected WebLogic resource.

Secure Sockets Layer (SSL), or Hyper-Text Transfer Protocol (HTTPS), can be used to provide an additional level of security to username/password authentication. Because SSL encrypts the data transferred between the client and WebLogic Server, the user ID and password of the user do not flow in the clear. Therefore, WebLogic Server can authenticate the user without compromising the confidentiality of the user's ID and password.

3.2.9.2 Certificate Authentication

When an SSL or HTTPS client request is initiated, WebLogic Server responds by presenting its digital certificate to the client. The client then verifies the digital certificate and an SSL connection is established. The digital certificate is issued by an entity (a trusted certificate authority), which validates the identity of WebLogic Server.

You can also use **two-way SSL authentication**, a form of mutual authentication. With two-way SSL authentication, both the client and server must present a certificate before the connection thread is enabled between the two. See [Section 3.7.3, "One-way/Two-way SSL Authentication"](#).

Note: Two-way SSL authentication is supported by the WebLogic Authentication provider that is provided as part of the WebLogic Server product.

3.2.9.3 Digest Authentication

Using **digest authentication** enables the storage of password information that is required to support Web Services Security Password Digest.

When using **digest authentication**, the client makes an un-authenticated request to the server, and the server sends a response with a digest authentication challenge indicating that it supports digest authentication. The client generates a nonce and sends it to the server along with a timestamp, digest, and username. The digest is a cryptographic hash of the password, nonce, and timestamp. The client requests the resource again this time sending the username and a cryptographic hash of the password combined with the nonce value. The server generates the hash itself, and if the generated hash matches the hash in the request, the request is allowed.

The advantage of digest authentication is it is resistant to replay attacks. The implementation maintains a cache of used nonces/timestamps for a specified period of time. All requests with a timestamp older than the specified timestamp are rejected as well as any requests that use the same timestamp/nonce pair as the most recent timestamp/nonce pair still in the cache. WebLogic Server stores this cache in a database.

3.2.9.4 Perimeter Authentication

The concept of **perimeter authentication** is the process of authenticating the identity of a remote user outside of the application server domain.

The following sections describe perimeter authentication:

- [Section 3.2.9.4.1, "How is Perimeter Authentication Accomplished?"](#)
- [Section 3.2.9.4.2, "How Does WebLogic Server Support Perimeter Authentication?"](#)

3.2.9.4.1 How is Perimeter Authentication Accomplished? Perimeter authentication is typically accomplished by the remote user specifying an asserted identity and some form of corresponding proof material, normally in the form of a passphrase (such as a password, a credit card number, Personal Identification Number, or some other form of personal identification information), which is used to perform the verification.

The **authentication agent**, the entity that actually vouches for the identity, can take many forms, such as a Virtual Private Network (VPN), firewall, an enterprise authentication service, or some other form of global identity service. Each of these forms of authentication agents has a common characteristic: they all perform an authentication process that results in an artifact or **token** that must be presented to

determine information about the authenticated user at a later time. Currently, the format of the token varies from vendor to vendor, but there are efforts to define a standard token format using XML. In addition, there is a current standard for Attribute Certificates, which is based on the X.509 standard for digital certificates. But even after all of this, if the applications and the infrastructure on which they are built are not designed to support this concept, enterprises are still forced to require that their remote users re-authenticate to the applications within the network.

3.2.9.4.2 How Does WebLogic Server Support Perimeter Authentication? WebLogic Server is designed to extend the single sign-on concept all the way to the perimeter through support for identity assertion (see [Figure 3–2](#)). Provided as a critical piece of the WebLogic Security Framework, the concept of identity assertion allows WebLogic Server to use the authentication mechanism provided by perimeter authentication schemes such as the Security Assertion Markup Language (SAML), the Simple and Protected GSS-API Negotiation Mechanism (SPNEGO), or enhancements to protocols such as Common Secure Interoperability (CSI) v2 to achieve this functionality.

Figure 3–2 Perimeter Authentication

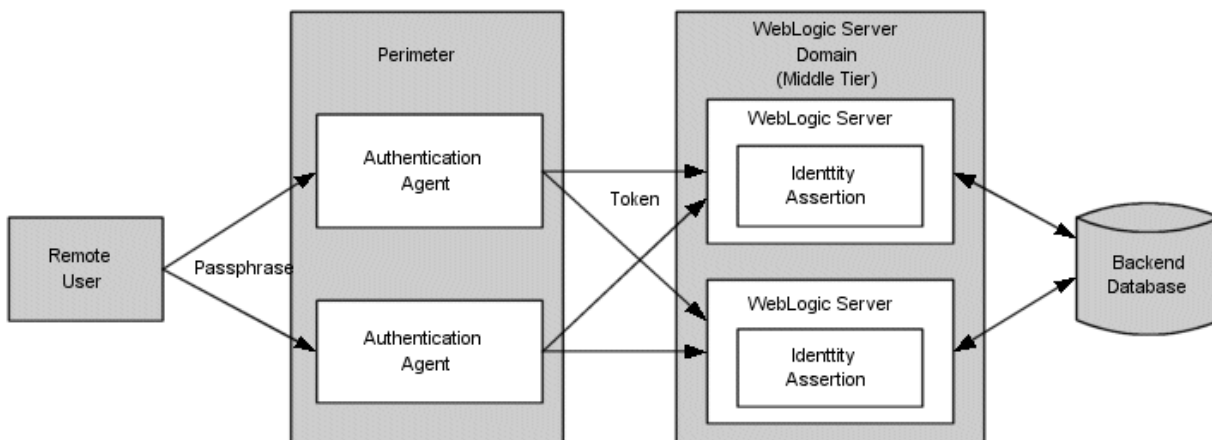

Support for perimeter authentication requires the use of an Identity Assertion provider that is designed to support one or more token formats. Multiple and different Identity Assertion providers can be registered for use. The tokens are transmitted as part of any normal business request, using the mechanism provided by each of the various protocols supported by WebLogic Server. Once a request is received with WebLogic Server, the entity that handles the processing of the protocol message recognizes the existence of the token in the message. This information is used in a call to the WebLogic Security Framework that results in the appropriate Identity Assertion provider being called to handle the verification of the token. It is the responsibility of the Identity Assertion provider implementation to perform whatever actions are necessary to establish validity and trust in the token and to provide the identity of the user with a reasonable degree of assurance, without the need for the user to re-authenticate to the application.

3.3 Security Assertion Markup Language (SAML)

The SAML standard defines a common XML framework for creating, requesting, and exchanging security assertions between software entities on the Web. This framework specifies how SAML assertions and protocols may be used to provide the following:

- Browser-based single sign-on (SSO) between online business partners

- The exchange of identity information in web services security

SAML was developed by the Organization for the Advancement of Structured Information Standards (OASIS), and this release of WebLogic Server includes broad support for SAML 1.1 and 2.0, including support for the following:

- SAML Web SSO profile

The SAML Web SSO profile specifies how SAML assertions and protocols should be used to provide browser-based single sign-on between an Identity Provider (a producer of assertions) and a Service Provider (a consumer of assertions).

In the SAML 2.0 Web SSO profile, a web user either invokes a resource hosted by a Service Provider site, or accesses an Identity Provider site in a way that results in an invocation on a resource hosted by the Service Provider. In either case, the web user is authenticated by the Identity Provider, which in turn generates an assertion on behalf of that user that contains information about the user's identity. The Identity Provider sends the assertion to the Service Provider, which consumes the assertion by extracting identity information about the user that is mapped to a Subject in the local security realm.

- Web Services Security (WS-Security) SAML Token profile 1.1

The SAML Token profile is part of the core set of WS-Security standards, and specifies how SAML assertions can be used for Web services security. WebLogic Server supports SAML Token Profile 1.1, including support for SAML 2.0 and SAML 1.1 assertions. SAML Token Profile 1.1 is backwards compatible with SAML Token Profile 1.0.

The following sections introduce how SAML is supported in WebLogic Server:

- [Section 3.3.1, "SAML Framework Concepts"](#)
- [Section 3.3.2, "SAML Components Provided in WebLogic Server"](#)

3.3.1 SAML Framework Concepts

The SAML framework is based on the following concepts.

Note: The terms for these concepts differ somewhat between SAML 1.1 and 2.0, particularly regarding how the entities to which they correspond are represented in the WebLogic Server Administration Console, as described in this section.

- **Identity Provider** - A system, or administrative domain, that asserts that a user has been authenticated and is given associated attributes. For example, there is a user Dan Murphy, he has an email address of dmurphy@company.com and he authenticated to this domain using a password mechanism. An Identity Provider is also known as a *SAML authority*, *asserting party*, or *source site*, and is often abbreviated as IdP.

You can configure a WebLogic Server instance to act in the role of Identity Provider. An Identity Provider is known by its Issuer URI (name). The SAML credential mapping provider supplies this functionality in WebLogic Server. (Note that the specific credential mapping provider you configure is specific to the version of SAML you are using.)

Note: When you configure SAML 1.1 services in a WebLogic Server instance, the Administration Console uses the term *source site* in place of Identity Provider.

- **Service Provider** - A system, or administrative domain, that determines whether it trusts the assertions provided to it by the Identity Provider. SAML defines a number of mechanisms that enable the Service Provider to trust the assertions provided to it. A Service Provider is also known as a *relying party*, or *destination site*, and is often abbreviated as SP.

Although a Service Provider may trust the assertions provided to it, local access policy defines whether the subject may access local resources. Therefore, even if a Service Provider trusts that a user is Dan Murphy, it does not mean Dan Murphy can access all the resources in the domain.

You can configure a WebLogic Server instance to act in the role of Service Provider. Trust relationships with Identity Provider partners must be established. The SAML identity assertion provider supplies this functionality in WebLogic Server. (Note that the specific identity assertion provider you configure is specific to the version of SAML you are using.)

When you configure SAML 1.1 services in a WebLogic Server instance, the Administration Console uses the term *destination site* in place of Service Provider.

- Assertion - An assertion is a package of information that supplies one or more statements made by an Identity Provider. The following types of statements are supported:
 - Authentication statements, which say when and how a subject was authenticated.
 - Attribute statements, which provide specific information about the subject (for example, what groups the Subject is a member of).
 - Authorization statements identify what the Subject is entitled to do.

Note: Note the following regarding SAML assertions in WebLogic Server:

- Attribute statements are supported only for the purpose of including group information. The SAML Authentication provider can retrieve group information from a SAML assertion (see "Configuring the SAML Authentication Provider" in *Securing Oracle WebLogic Server*.)
 - SAML authorization is not supported in this release of WebLogic Server.
-
-

- **Protocols** - SAML defines a number of request/response protocols for obtaining assertions. A SAML request can ask for a specific known assertion or make authentication or attribute decision queries, with the SAML response providing back the requested assertions. The XML format for protocol messages with their allowable extensions is defined in an XML schema.

WebLogic Server supports the *authentication request protocol*, which defines an authentication request (that is, a message containing an <AuthnRequest> statement) that causes an authentication response (that is, a message containing a

<Response> statement) to be returned. The authentication response contains an assertion that pertains to a Principal.

Typically the authentication request is sent by a Service Provider to an Identity Provider, which returns the authentication response. The authentication request protocol is used to support the Web Browser SSO Profile.

- **Bindings** - Bindings define the lower-level communication or messaging protocols (such as HTTP or SOAP) over which the SAML protocols can be transported. A binding details exactly how the SAML protocol maps onto transport and messaging protocols. For example, the mapping of the SAML <AuthnRequest> message onto HTTP.

For SAML 1.1, WebLogic Server provides support for HTTP POST and HTTP Artifact as profiles. For SAML 2.0, WebLogic Server provides support for HTTP POST and HTTP Artifact bindings for the Web SSO profile.

For SAML 2.0, WebLogic Server adds the HTTP Redirect binding for the Web SSO profile.

- **Profiles** - Descriptions of particular flows of assertions and protocol messages that define how SAML can be used for a particular purpose. A profile is the combination of protocols, bindings, and the structure of assertions that are used to support a particular use case, such as the Web SSO profile and SAML Token profile supported in WebLogic Server.
- **Metadata files** - SAML 2.0 defines a new metadata schema for exchanging configuration information between partners. WebLogic Server supports this schema by providing the ability to create local site configuration data that is published to a file and shared with partners for use with the Web SSO Profile. Partners subsequently import this metadata file to retrieve this configuration data, which is used to populate partner registries and ensure that SAML messages can be transmitted and consumed more consistently and reliably. Note that metadata files are not used with the WS-Security SAML Token Profile 1.1.

For a complete description of these concepts and how they apply to the SAML architecture, see the following:

- For SAML V1.1, see Technical Overview of the OASIS Security Assertion Markup Language (SAML) V1.1 (<http://www.oasis-open.org/committees/download.php/6628/sstc-saml-tech-overview-1.1-draft-05.pdf>).
- For SAML V2.0, see Security Assertion Markup Language (SAML) 2.0 Technical Overview (<http://www.oasis-open.org/committees/download.php/11511/sstc-saml-tech-overview-2.0-draft-03.pdf>).

3.3.2 SAML Components Provided in WebLogic Server

Support for SAML 1.1 and 2.0 is provided in the following WebLogic Server components:

- SAML security providers
- Single Sign-On services
- Web services support for SAML Token Profile 1.1

3.3.2.1 SAML Security Providers

WebLogic Server provides the following security providers to support SAML 1.1 and 2.0:

Table 3–1 Security Providers Included in WebLogic Server to Support SAML

To support . . .	The following provider . . .	Does the following . . .
SAML 1.1	SAML Credential Mapping provider Version 2	Generates SAML 1.1 assertions. This provider must be configured for a WebLogic Server instance that serves as an Identity Provider (or, as identified in the Administration Console, the <i>source site</i>).
SAML 1.1	SAML Credential Mapping provider Version 1	Generates SAML 1.1 assertions (deprecated).
SAML 1.1	SAML Identity Assertion provider Version 2	Consumes SAML 1.1 assertions. This provider must be configured for a WebLogic Server instance that serves as a Service Provider (or, as identified in the Administration Console, the <i>destination site</i>).
SAML 1.1	SAML Identity Assertion provider Version 1	Consumes SAML 1.1 assertions (deprecated).
SAML 2.0	SAML 2.0 Credential Mapping provider	Generates SAML 2.0 assertions. This provider must be configured for a WebLogic Server instance that serves as an Identity Provider.
SAML 2.0	SAML 2.0 Identity Assertion provider	Consumes SAML 2.0 assertions. This provider must be configured for a WebLogic Server instance that serves as a Service Provider.
SAML 1.1 and 2.0	SAML Authentication provider	Enables "virtual user" functionality for both the SAML 1.1 and SAML 2.0 Identity Assertion providers. (See "Configuring the SAML Authentication Provider" in <i>Securing Oracle WebLogic Server</i> .)

3.3.2.2 Single Sign-On Services

WebLogic Server can be configured to act as a SAML Identity Provider (IdP), Service Provider, or both. When acting as an IdP, the SAML credential mapping provider must be configured so that the IdP can produce assertions. When acting as a Service Provider, the SAML identity assertion provider must be configured so that the Service Provider can consume assertions.

SAML Single Sign-On Services (SSO) are configured on a per-server basis. To enable SAML SSO in two or more servers in a domain, such as in a cluster, the recommended approach is to do the following:

1. Create a domain in which the RDBMS security store is configured. For more information, see "Managing the RDBMS Security Store" in *Securing Oracle WebLogic Server*.
2. Ensure that SSO services are configured individually and identically on each server instance.

3.3.2.3 Web Services Support for SAML Token Profile 1.1

WebLogic Server Web services supports SAML Token Profile 1.1. This feature includes support for both SAML 2.0 and SAML 1.1 assertions and is backwards-compatible with SAML Token Profile 1.0.

You configure SAML tokens for a web service through use of the appropriate WS-SecurityPolicy assertions.

Note: SAML Token Profile 1.1 is supported only through WS-SecurityPolicy. The earlier "WLS 9.2 Security Policy" supports SAML Token Profile 1.0/SAML 1.1 only.

When using SAML Token Profile, the appropriate SAML security providers must be configured (either the SAML 2.0 or SAML 1.1 credential mapping or identity assertion providers) depending on the desired SAML version and assertion usage.

3.4 Single Sign-On (SSO)

Single Sign-On is the ability to require a user to sign on to an application only once and gain access to many different application components, even though these components may have their own authentication schemes. Single sign-on enables users to login securely to all their applications, web sites and mainframe sessions with just one identity. WebLogic Server provides single sign-on (SSO) with the following environments:

- [Section 3.4.1, "Web Browsers and HTTP Clients via SAML"](#)
- [Section 3.4.2, "Desktop Clients"](#)

3.4.1 Web Browsers and HTTP Clients via SAML

The Security Assertion Markup Language (SAML) enables cross-platform authentication between Web applications or Web services running in a WebLogic Server domain and Web browsers or other HTTP clients. WebLogic Server supports single sign-on (SSO) based on SAML. When users are authenticated at one site that participates in a single sign-on (SSO) configuration, they are automatically authenticated at other sites in the SSO configuration and do not need to log in separately.

Note: When you use the Administration Console to configure SAML, you will notice that the names used for some SAML entities differ between SAML 1.1 and 2.0. This section identifies the key terminology differences.

The following steps describe a typical scenario that shows how SAML SSO works.

1. A Web user attempts to access a target resource at a site that is configured to accept authentications through SAML assertions.

When configuring SAML 1.1 in the Administration Console, this site is called the *destination site*. In SAML 2.0, this site is called the *Service Provider*.

2. The Service Provider determines that the user's credentials need to be authenticated by a central site that can generate a SAML assertion for that user. The Service Provider redirects the authentication request to that central site.

In SAML 1.1, the site that generates the SAML assertion is called the *source site*. In SAML 2.0, this site is the *Identity Provider*. In both SAML versions, this site is sometimes called a *SAML Authority*.

3. The user logs in to the Identity Provider site, typically via a login web application hosted by that site. The Identity Provider authenticates the user, and generates a SAML assertion.
4. Information about the SAML assertion provided by the Identity Provider and associated with the user and the desired target is conveyed from the Identity Provider site to the Service Provider site by the protocol exchange.

Through a sequence of HTTP exchanges, the user browser is transferred to an Assertion Consumer Service (ACS) at the Service Provider site. The WebLogic Server SAML Identity Assertion provider makes up a portion of the ACS.

5. The Identity Assertion provider maps the identity contained in the assertion to a Subject in the local security realm. The access policies on the requested target are evaluated to determine whether the user is authorized for that target. If access is authorized, the user authenticated by the Identity Provider site is accepted as an authenticated user by the Service Provider site, thereby achieving Web-based SSO.

For more background information about the OASIS SAML standard, see the following:

- For SAML V1.1, see Bindings and Profiles for the OASIS Security Assertion Markup Language (SAML) V1.1 (<http://www.oasis-open.org/committees/download.php/3405/oasis-sstc-saml-bindings-1.1.pdf>).
- For SAML V2.0, see:
 - Profiles for the OASIS Security Assertion Markup Language (SAML) V2.0 (<http://docs.oasis-open.org/security/saml/v2.0/saml-profiles-2.0-os.pdf>).
 - Bindings for the OASIS Security Assertion Markup Language (SAML) V2.0 (<http://docs.oasis-open.org/security/saml/v2.0/saml-bindings-2.0-os.pdf>).

For information about how SSO with web browsers and HTTP clients is implemented in WebLogic Server, see [Section 5.2, "Single Sign-On with the WebLogic Security Framework"](#).

3.4.2 Desktop Clients

SSO with Desktop Clients uses HTTP-based authentication with Microsoft clients that have authenticated in the Windows Active Directory environment. The Windows Active Directory environment uses Kerberos as its security protocol. Kerberos provides network authentication of heterogeneous realms. This means a user logged into a Windows domain can access a Web application running on an application server and use their Windows Active Directory credentials to authenticate to the server. The application server can run on any platform that supports Kerberos.

When a Web server receives a request from a browser it can request that the browser use the Kerberos protocol to authenticate itself. This protocol performs authentication via HTTP, and allows the browser (in most cases, Internet Explorer) to pass a delegated credential to allow a web application to log into subsequent Kerberos-based services on the user's behalf.

When an HTTP server wishes to login a Microsoft client, it returns a 401 Unauthorized response to the HTTP request with the `WWW-Authentication:Negotiate` header. The browser then contacts the Key Distribution Center (KDC)/Ticket Granting Service (TGS) to obtain a service ticket. It chooses a special Service Principal Name for the ticket request. The returned ticket is then wrapped in a SPNEGO token which is encoded and sent back to the server using

an HTTP request. The token is unwrapped and the ticket is authenticated. Once authenticated, the page corresponding to the requested URL is returned.

For information about how SSO with Microsoft clients is implemented in WebLogic Server, see [Section 5.2.3, "Desktop SSO Process"](#).

3.5 Authorization

Authorization is the process whereby the interactions between users and WebLogic resources are controlled, based on user identity or other information. In other words, authorization answers the question, "What can you access?" In WebLogic Server, an Authorization provider is used to limit the interactions between users and WebLogic resources to ensure integrity, confidentiality, and availability.

The following sections describe authorization concepts and functionality:

- [Section 3.5.1, "WebLogic Resources"](#)
- [Section 3.5.2, "Security Policies"](#)
- [Section 3.5.3, "ContextHandlers"](#)
- [Section 3.5.4, "Access Decisions"](#)
- [Section 3.5.5, "Adjudication"](#)
- [Section 3.9.1.5, "Java Authorization Contract for Containers \(JACC\)"](#)

3.5.1 WebLogic Resources

A **WebLogic resource** is a structured object used to represent an underlying WebLogic Server entity, which can be protected from unauthorized access using security roles and security policies.

WebLogic resources are hierarchical. Therefore, the level at which you define these security roles and security policies is up to you. For example, you can define security roles and security policies on: entire enterprise applications (EARs); an Enterprise JavaBean (EJB) JAR containing multiple EJBs; a particular Enterprise JavaBean (EJB) within that JAR; or a single method within that EJB.

WebLogic resource implementations are available for:

- Administrative resources
- Application resources
- Common Object Model (COM) resources
- Enterprise Information System (EIS) resources
- Enterprise JavaBean (EJB) resources
- Java Database Connectivity (JDBC) resources
- Java Messaging Service (JMS) resources
- Java Naming and Directory Interface (JNDI) resources
- Server resources
- Web application resources
- Web service resources
- Work Context resources

Note: Each of these WebLogic resource implementations is explained in detail in the Javadocs for WebLogic Classes.

3.5.2 Security Policies

Security policies replace access control lists (ACLs) and answer the question "Who has access to a WebLogic resource?" A security policy is created when you define an association between a WebLogic resource and one or more users, groups, or security roles. You can optionally define date and time constraints for a security policy. A WebLogic resource has no protection until you assign it a security policy.

You assign security policies to any of the defined WebLogic resources (for example, an EJB resource or a JNDI resource) or to attributes or operations of a particular instance of a WebLogic resource (an EJB method or a servlet within a Web application). If you assign a security policy to a type of WebLogic resource, all new instances of that resource inherit that security policy. Security policies assigned to individual resources or attributes override security policies assigned to a type of WebLogic resource. For a list of the defined WebLogic resources, see [Section 3.5.1, "WebLogic Resources"](#).

Security policies are stored in an Authorization provider's database. By default, the XACML Authorization provider is configured in a domain, and security policies are stored in the embedded LDAP server.

To use a user or group to create a security policy, the user or group must be defined in the security provider database for the Authentication provider that is configured in the default security realm. To use a security role to create a security policy, the security role must be defined in the security provider database for the Role Mapping provider that is configured in the default security realm. By default, the WebLogic Authentication and XACML Role Mapping providers are configured in the database in the embedded LDAP server.

By default, security policies are defined in WebLogic Server for the WebLogic resources. These security policies are based on security roles and default global groups. You also have the option of basing a security policy on a user. Oracle recommends basing security policies on security roles rather than users or groups. Basing security policies on security roles allows you to manage access based on a security role that a user or group is granted, which is a more efficient method of management. For a listing of the default security policies for the WebLogic resources, see "Default Root Level Security Policies" in *Securing Resources Using Roles and Policies for Oracle WebLogic Server*.

3.5.3 ContextHandlers

A **ContextHandler** is a high-performing WebLogic class that obtains additional context and container-specific information from the resource container, and provides that information to security providers making access or role mapping decisions. The `ContextHandler` interface provides a way for an internal WebLogic resource container to pass additional information to a WebLogic Security Framework call, so that a security provider can obtain contextual information beyond what is provided by the arguments to a particular method. A ContextHandler is essentially a name/value list and as such, it requires that a security provider know what names to look for. (In other words, use of a ContextHandler requires close cooperation between the WebLogic resource container and the security provider.) Each name/value pair in a ContextHandler is known as a **context element**, and is represented by a `ContextElement` object.

Currently, three types of WebLogic resource containers pass ContextHandlers to the WebLogic Security Framework: the Servlet, EJB, and Web service containers. Thus, URL (Web), EJB, and Web service resource types have different context elements whose values Adjudication, Identity Assertion, Authorization Credential Mapping, and Role Mapping providers and the LoginModules used by an Authentication provider can inspect. An implementation of the `AuditContext` interface (used when a security provider is implemented to post audit events) may also examine the values of context elements.

For more information about the values of particular context elements, see "ContextHandlers and WebLogic Resources" in *Developing Security Providers for Oracle WebLogic Server*.

3.5.4 Access Decisions

Like LoginModules for Authentication providers, an **Access Decision** is the component of an Authorization provider that actually answers the "is access allowed?" question. Specifically, an Access Decision is asked whether a subject has permission to perform a given operation on a WebLogic resource, with specific parameters in an application. Given this information, the Access Decision responds with a result of `PERMIT`, `DENY`, or `ABSTAIN`.

3.5.5 Adjudication

Adjudication involves resolving any authorization conflicts that may occur when more than one Authorization provider is configured in a security realm, by weighing the result of each Authorization provider's Access Decision. In WebLogic Server, an Adjudication provider is used to tally the results that multiple Access Decisions return, and determines the final `PERMIT` or `DENY` decision. An Adjudication provider may also specify what should be done when an answer of `ABSTAIN` is returned from a single Authorization provider's Access Decision.

3.6 Identity and Trust

Private keys, digital certificates, and trusted certificate authority certificates establish and verify identity and trust in the WebLogic Server environment.

The public key is embedded into a *digital certificate*. A private key and digital certificate provide *identity*. The trusted certificate authority (CA) certificate establishes *trust* for a certificate. Certificates and certificate chains need to be validated before a trust relationship is established.

This topic details the concepts associated with identity and trust. For more information, see:

- [Section 3.6.1, "Private Keys"](#)
- [Section 3.6.2, "Digital Certificates"](#)
- [Section 3.6.3, "Certificate Authorities"](#)
- [Section 3.6.4, "Certificate Lookup and Validation"](#)

3.6.1 Private Keys

WebLogic Server uses public key encryption technology for authentication. With public key encryption, a public key and a *private key* are generated for a server. The keys are related such that data encrypted with the public key can only be decrypted

using the corresponding private key and vice versa. The private key is carefully protected so that only the owner can decrypt messages that were encrypted using the public key.

3.6.2 Digital Certificates

Digital certificates are electronic documents used to verify the unique identities of principals and entities over networks such as the Internet. A digital certificate securely binds the identity of a user or entity, as verified by a trusted third party (known as a certificate authority), to a particular public key. The combination of the public key and the private key provides a unique identity to the owner of the digital certificate.

Digital certificates enable verification of the claim that a specific public key does in fact belong to a specific user or entity. A recipient of a digital certificate can use the public key in a digital certificate to verify that a digital signature was created with the corresponding private key. If such verification is successful, this chain of reasoning provides assurance that the corresponding private key is held by the subject named in the digital certificate, and that the digital signature was created by that subject.

A digital certificate typically includes a variety of information, such as the following:

- The name of the subject (holder, owner) and other information required to confirm the unique identity of the subject, such as the URL of the Web server using the digital certificate, or an individual's e-mail address
- The subject's public key
- The name of the certificate authority that issued the digital certificate
- A serial number
- The validity period (or lifetime) of the digital certificate (defined by a start date and an end date)

The most widely accepted format for digital certificates is defined by the ITU-T X.509 international standard. Digital certificates can be read or written by any application complying with the X.509 standard. The public key infrastructure (PKI) in WebLogic Server recognizes digital certificates that comply with X.509 version 3, or X.509v3. Oracle recommends obtaining digital certificates from a certificate authority such as Verisign or Entrust.

For more information, see "Configuring SSL" in *Securing Oracle WebLogic Server*.

3.6.3 Certificate Authorities

Digital certificates are issued by certificate authorities. Any trusted, third-party organization or company that is willing to vouch for the identities of those to whom it issues digital certificates and public keys can be a certificate authority. When a certificate authority creates a digital certificate, the certificate authority signs it with its private key, to ensure that any tampering will be detected. The certificate authority then returns the signed digital certificate to the requesting party.

The requesting party can verify the signature of the issuing certificate authority by using the public key of the certificate authority. The certificate authority makes its public key available by providing a certificate issued from a higher-level certificate authority attesting to the validity of the public key of the lower-level certificate authority. This scheme gives rise to hierarchies of certificate authorities. This hierarchy is terminated by a top-level, self-signed certificate known as the root certificate, *because no other public key is needed to certify it*. Root certificates are issued by trusted (root) Certificate Authorities.

If the recipient has a digital certificate containing the public key of the certificate authority signed by a superior certificate authority who the recipient already trusts, the recipient of an encrypted message can develop trust in the public key of a certificate authority recursively. In this sense, a digital certificate is a stepping stone in digital trust. Ultimately, it is necessary to trust only the public keys of a small number of top-level certificate authorities. Through a chain of certificates, trust in a large number of users' digital signatures can be established.

Thus, digital signatures establish the identities of communicating entities, but a digital signature can be trusted only to the extent that the public key for verifying it can be trusted.

For more information, see "Configuring SSL" in *Securing Oracle WebLogic Server*.

3.6.4 Certificate Lookup and Validation

Applications that rely on public key technology for security must be confident that a user's public key is genuine. A user may have a chain of certificates which recursively point to the trusted CA that issued the initial certificate (referred to as the end certificate). A certificate chain must be validated before it can be used to establish trust. In addition, a user may not have a complete chain from a trusted CA to the target certificate. Completing a valid chain of certificates from the target certificate to the trusted CA is another requirement for public key technology.

In WebLogic Server, certificate validation is performed by the Certificate Lookup and Validation (CLV) framework which completes and validates X.509 certificate chains for inbound 2-way SSL, outbound SSL, application code, and WebLogic Web services. The CLV framework receives a certificate or certificate chain, completes the chain (if necessary), and lookups and validates the certificate in the certificate chain. The framework can use the end certificate, the Subject DN, the Issuer DN plus serial number, the subject key identifier and/or X.509 thumbprint to find and validate a certificate chain. In addition, the framework can perform additional validation on the certificate chain such as revocation checking.

The CLV framework is based on the JDK architecture and plug-in framework for locating and validating certificate chains. The CLV providers were built using the JDK CertPath Builder and CertPath Validator API/SPI.

3.7 Secure Sockets Layer (SSL)

SSL enables secure communication between applications connected through the Web.

This release of WebLogic Server replaces the Certicom SSL implementation in Weblogic Server with an SSL implementation based on Java Secure Socket Extension (JSSE). JSSE is the Java standard framework for SSL and TLS and includes both blocking-IO and non-blocking-IO APIs, and a reference implementation including several commonly-trusted CAs. See the *Java Secure Socket Extension (JSSE) Reference Guide*

(<http://java.sun.com/javase/6/docs/technotes/guides/security/jss e/JSSERefGuide.html>) for complete information.

Note: Support for the Certicom SSL implementation is deprecated as of this release and will eventually be removed. For this purpose, this release of WebLogic Server continues to support the Certicom SSLPlus Java version 4.0 SSL implementation, as well as RSA Cert-J version 2.1.1 and Crypto-J version 3.5.

WebLogic Server fully supports SSL communication. By default, WebLogic Server is configured for one-way SSL authentication, however, the SSL port is disabled. Using the Administration Console, you can configure WebLogic Server for two-way SSL authentication.

- To use one-way SSL from a client to a server: enable the SSL port on the server, configure identity for the server and trust for the client.
- To use two-way SSL between a client and a server: enable two-way SSL on the server, configure trust for the server, and identity for the server.

In either case, the trusted CA certificates need to include the trusted CA certificate that issued the peer's identity certificate. This certificate does not necessarily have to be the root CA certificate.

To acquire a digital certificate for your server, you generate a public key, private key, and a Certificate Signature Request (CSR), which contains your public key. You send the CSR request to a certificate authority and follow their procedures for obtaining a signed digital certificate.

Once you have your private keys, digital certificates, and any additional trusted CA certificates that you may need, you need to store them so that WebLogic Server can use them to verify identity. Store private keys and certificates in keystores.

Note: For purposes of backwards compatibility, you may also store your private keys and certificates in files.

To use SSL when connecting to a WebLogic server application with your browser, you simply specify HTTPS and the secure port (port number 7002) in the URL. For example: `https://localhost:7002/examplesWebApp/SnoopServlet.jsp`, where *localhost* is the name of the system hosting the Web application.

The following topics are discussed in this section:

- [Section 3.7.1, "SSL Features"](#)
- [Section 3.7.2, "SSL Tunneling"](#)
- [Section 3.7.3, "One-way/Two-way SSL Authentication"](#)
- [Section 3.7.4, "Host Name Verification"](#)
- [Section 3.7.5, "Trust Managers"](#)
- [Section 3.7.6, "Asymmetric Key Algorithms"](#)
- [Section 3.7.7, "Symmetric Key Algorithms"](#)
- [Section 3.7.8, "Message Digest Algorithms"](#)
- [Section 3.7.9, "Cipher Suites"](#)

3.7.1 SSL Features

WebLogic Server provides a pure-Java implementation of SSL. Generally, SSL provides the following:

- A mechanism that the communicating applications can use to authenticate each other's identity.
- Encryption of the data exchanged by the applications.

When SSL is used, the target (the server) always authenticates itself to the initiator (the client). Optionally, if the target requests it, the initiator can authenticate itself to the target. Encryption makes data transmitted over the network intelligible only to the intended recipient. An SSL connection begins with a handshake during which the applications exchange digital certificates, agree on the encryption algorithms to be used, and generate the encryption keys to be used for the remainder of the session.

SSL provides the following security features:

- Server authentication - WebLogic Server uses its digital certificate, issued by a trusted certificate authority, to authenticate to clients. SSL minimally requires the server to authenticate to the client using its digital certificate. If the client is not required to present a digital certificate, the connection type is called one-way SSL authentication.
- Client Identity Verification - Optionally, clients might be required to present their digital certificates to WebLogic Server. WebLogic Server then verifies that the digital certificate was issued by a trusted certificate authority and establishes the SSL connection. An SSL connection is not established if the digital certificate is not presented and verified. This type of connection is called two-way SSL authentication, a form of mutual authentication.
- Confidentiality - All client requests and server responses are encrypted to maintain the confidentiality of data exchanged over the network.
- Data Integrity - Each SSL message contains a message digest computed from the original data. On the receiving end, a new digest is computed from the de-crypted data and then compared with the digest that came with the message. If the data is altered, the digests don't match and tampering is detected.
- Data that flows between a client and WebLogic Server is protected from tampering by a third-party validation of user identities.

If you are using a Web browser to communicate with WebLogic Server, you can use the Hyper-Text Transfer Protocol with SSL (HTTPS) to secure network communications.

3.7.2 SSL Tunneling

WebLogic Server tunnels the HTTP, T3, and IIOP protocols over SSL. SSL can be used by Web browsers and Java clients as follows:

- A Web browser makes an SSL connection to a server over HTTPS. The browser then sends HTTP requests and receives HTTP responses over this SSL connection. For example:

```
https://myserver.com/mypage.html
```

WebLogic Server supports SSL versioning which means it can communicate with any clients over this protocol including Web browsers.

- Java clients using HTTP/T3 protocols are tunnelled over SSL. For example:

```
t3s://myserver.com:7002/mypage.html
```

Java clients running in WebLogic Server can establish either T3S connections to other WebLogic Servers, or HTTPS connections to other servers that support SSL, such as Web servers or secure proxy servers.

3.7.3 One-way/Two-way SSL Authentication

WebLogic Server supports one-way and two-way SSL authentication. With one-way SSL authentication, the target (the server) is required to present a digital certificate to the initiator (the client) to prove its identity. The client performs two checks to validate the digital certificate:

1. The client verifies that the certificate is trusted (meaning, it was issued by the client's trusted CA), is valid (not expired), and satisfies the other certificate constraints.
2. The client checks that the certificate Subject's common name (CN) field value matches the host name of the server to which the client is trying to connect

If both of the above checks return true, the SSL connection is established.

With two-way SSL authentication, both the client and the server must present digital certificates before the SSL connection is enabled between the two. Thus, in this case, WebLogic Server not only authenticates itself to the client (which is the minimum requirement for certificate authentication), but it also requires authentication from the requesting client. Two-way SSL authentication is useful when you must restrict access to trusted clients only.

Figure 3–3 illustrates WebLogic Server SSL connections and shows which connections support one-way SSL, two-way SSL, or both. The Web browser client, Web Server, Fat client, Web services client, and SSL server connections can be configured for either one-way or two-way SSL. WebLogic Server determines whether an SSL connection is configured for one-way or two-way. Use the Administration Console to configure SSL.

Figure 3–3 How WebLogic Server Supports SSL Connections

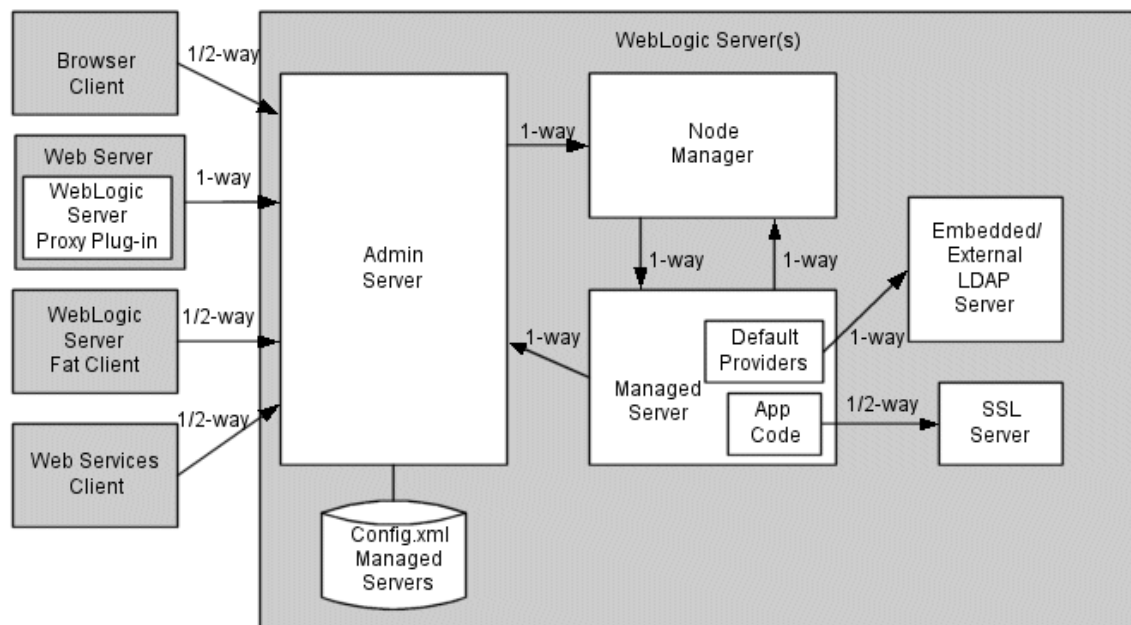

Note: The SSL server shown in this figure can be any J2EE compliant server.

3.7.4 Host Name Verification

Host Name verification is the process of verifying that the name of the host to which an SSL connection is made is the intended or authorized party. Host name verification prevents man-in-the-middle attacks when a Web client (a Web browser, a WebLogic

client, or a WebLogic Server acting as a client) requests an SSL connection to another application server.

By default, the SSL client, as a function of the SSL handshake, compares the common name in the SubjectDN of the SSL server's digital certificate with the host name of the SSL server to which it is trying to connect. If these names do not match, the SSL connection is dropped.

3.7.5 Trust Managers

The Trust Manager provides a way to override the default SSL trust validation rules. It allows the server to decide whether or not it trusts the client that is contacting it. Using a Trust Manager you can perform custom checks before continuing an SSL connection. For example, you can use the Trust Manager to specify that only users from specific localities, such as towns, states, or countries, or users with other special attributes, can gain access via the SSL connection.

WebLogic Server provides the `weblogic.security.SSL.TrustManager` interface. This interface allows custom Trust Manager implementations to be called during the SSL handshake. The custom implementation can override the handshake error detected by the SSL implementation validation check or raise an error based on its own certification rules.

WebLogic Server also provides the `weblogic.security.SSL.CertPath.TrustManager` interface which application and custom code can use to control if outbound SSL uses certificate lookup and validation.

Note: This interface replaces the `weblogic.security.SSL.TrustManagerJSSE` interface, which is deprecated in this release of WebLogic Server.

3.7.6 Asymmetric Key Algorithms

Asymmetric key (also referred to as public key) algorithms are implemented through a pair of different, but mathematically related keys: a public key and a private key.

- The public key (which is distributed widely) is used for verifying a digital signature or transforming data into a seemingly unintelligible form.
- The private key (which is always kept secret) is used for creating a digital signature or returning the data to its original form.

The Public Key Infrastructure (PKI) in WebLogic Server also supports digital signature algorithms. Digital signature algorithms are simply public key algorithms used to generate digital signatures.

WebLogic Server supports the Rivest, Shamir, and Adelman (RSA) algorithm.

3.7.7 Symmetric Key Algorithms

With symmetric key algorithms, you use the same key to encrypt and decrypt a message. This common key encryption system uses a symmetric key algorithm to encrypt a message sent between two communicating entities. Symmetric cryptography tends to be relatively fast compared to asymmetric cryptography.

A block cipher is a type of symmetric key algorithm that transforms a fixed-length block of plain text (unencrypted text) data into a block of cipher text (encrypted text)

data of the same length. This transformation takes place in accordance with the value of a randomly generated session key. The fixed length is called the block size.

The PKI in WebLogic Server supports the following symmetric key algorithms:

- DES-CBC (Data Encryption Standard for Cipher Block Chaining)
DES-CBC is a 64-bit block cipher run in Cipher Block Chaining (CBC) mode. It provides 56-bit keys. (8 parity bits are stripped from the full 64-bit key.)
- Two-key triple-DES (Data Encryption Standard)
Two-key triple-DES is a 128-bit block cipher run in Encrypt-Decrypt-Encrypt (EDE) mode. Two-key triple-DES provides two 56-bit keys (in effect, a 112-bit key).
For some time it has been common practice to protect and transport a key for DES encryption with triple-DES, which means that the input data (in this case the single-DES key) is encrypted, decrypted, and then encrypted again (an encrypt-decrypt-encrypt process). The same key is used for the two encryption operations.
- RC4 (Rivest's Cipher 4)
RC4 is a variable key-size block cipher with a key size range of 40 to 128 bits. It is faster than DES.

Note: Users cannot expand or modify this list of algorithms.

3.7.8 Message Digest Algorithms

WebLogic Server supports the MD5 and SHA (Secure Hash Algorithm) message digest algorithms. Both MD5 and SHA are well known, one-way hash algorithms. A one-way hash algorithm takes a message and converts it into a fixed string of digits, which is referred to as a message digest or hash value.

MD5 is a high-speed, 128-bit hash; it is intended for use with 32-bit machines. SHA offers more security by using a 160-bit hash, but is slower than MD5.

3.7.9 Cipher Suites

A cipher suite is an SSL encryption method that includes the key exchange algorithm, the symmetric encryption algorithm, and the secure hash algorithm. A cipher suite is used to protect the integrity of a communication. For example, the cipher suite called `RSA_WITH_RC4_128_MD5` uses RSA for key exchange, RC4 with a 128-bit key for bulk encryption, and MD5 for message digest.

Check the validation lists at <http://csrc.nist.gov/cryptval/> for FIPS140 validation status.

WebLogic Server supports the RSA cipher suites described in [Table 3-2](#).

Table 3-2 SSL Cipher Suites Supported by WebLogic Server

Cipher Suite	Symmetric Key Strength
<code>TLS_RSA_WITH_RC4_128_SHA</code>	128
<code>TLS_RSA_WITH_RC4_128_MD5</code>	128
<code>TLS_RSA_WITH_DES_CBC_SHA</code>	56
<code>TLS_RSA_EXPORT_WITH_RC4_40_MD5</code>	40

Table 3–2 (Cont.) SSL Cipher Suites Supported by WebLogic Server

Cipher Suite	Symmetric Key Strength
TLS_RSA_EXPORT_WITH_DES40_CBC_SHA	40
TLS_RSA_WITH_3DES_EDE_CBC_SHA	112
TLS_RSA_WITH_NULL_SHA	0
TLS_RSA_WITH_NULL_MD5	0
TLS_RSA_EXPORT1024_WITH_DES_CBC_SHA	56
TLS_RSA_EXPORT1024_WITH_RC4_56_SHA	56
TLS_RSA_WITH_AES_128_CBC_SHA	128
TLS_RSA_WITH_AES_256_CBC_SHA	256

3.8 Firewalls

A firewall limits traffic between two networks. Firewalls can be a combination of software and hardware, including routers and dedicated gateway machines. They employ filters that allow or disallow traffic to pass based on the protocol, the service requested, routing information, and the origin and destination hosts or networks. They may also allow access for authenticated users.

Figure 3–4 illustrates a typical setup with a firewall that filters traffic destined for a WebLogic Server cluster.

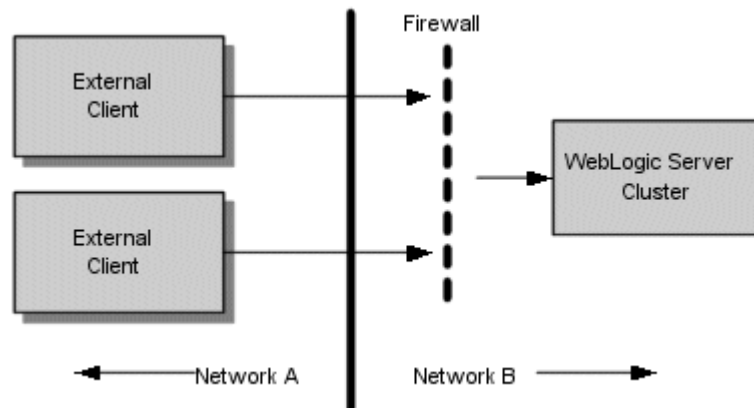
Figure 3–4 Typical Firewall Setup

You can use the following features in WebLogic Server in conjunction with firewalls:

- [Section 3.8.1, "Connection Filters"](#)
- [Section 3.8.2, "Perimeter Authentication"](#)

3.8.1 Connection Filters

You can use WebLogic Server connection filters to set up firewalls that filter network traffic based on protocols, IP addresses, and DNS node names. For more information, see "Using Network Connection Filters" in *Programming Security for Oracle WebLogic Server*.

3.8.2 Perimeter Authentication

You can use Identity Assertion providers to set up **perimeter authentication** - a special type of authentication using tokens. The WebLogic Server security architecture supports Identity Assertion providers that perform perimeter-based authentication (Web server, firewall, VPN) and handle multiple security token types/protocols (SOAP, SAML, SPNEGO, IIOP-CSIv2).

3.9 Java EE and WebLogic Security

For implementation and use of user authentication and authorization, WebLogic Server utilizes the security services of the JDK version 6.0. Like the other Java EE components, the security services are based on standardized, modular components. WebLogic Server implements these Java security service methods according to the standard, and adds extensions that handle many details of application behavior automatically, without requiring additional programming.

WebLogic Server's support for Java EE 6.0 security means that application developers can take advantage of Sun Microsystems' latest enhancements and developments in the area of security, thus leveraging a company's investment in Java programming expertise. By following the defined and documented Java standard, WebLogic Server's security support has a common baseline for Java developers. The innovations that WebLogic Server provides rest on the baseline support for J2SE 5.0.

The following topics are discussed in this section:

- [Section 3.9.1, "Java EE 6.0 Security Packages"](#)
- [Section 3.9.2, "Common Secure Interoperability Version 2 \(CSIv2\)"](#)

3.9.1 Java EE 6.0 Security Packages

WebLogic Server is compliant with and supports the following Java EE 6.0 security packages:

- [Section 3.9.1.1, "The Java Secure Socket Extension \(JSSE\)"](#)
- [Section 3.9.1.2, "Java Authentication and Authorization Services \(JAAS\)"](#)
- [Section 3.9.1.3, "The Java Security Manager"](#)
- [Section 3.9.1.4, "Java Cryptography Architecture and Java Cryptography Extensions \(JCE\)"](#)
- [Section 3.9.1.5, "Java Authorization Contract for Containers \(JACC\)"](#)

3.9.1.1 The Java Secure Socket Extension (JSSE)

JSSE is a set of packages that support and implement the SSL and TLS v1 protocol, making those protocols and capabilities programmatically available. WebLogic Server provides Secure Sockets Layer (SSL) support for encrypting data transmitted across WebLogic Server clients, as well as other servers.

3.9.1.2 Java Authentication and Authorization Services (JAAS)

JAAS is a set of packages that provide a framework for user-based authentication and access control. WebLogic Server uses only the authentication classes of JAAS.

Note: There are security configuration settings in a WebLogic Server domain that can impact the use of JAAS authorization if needed in your environment. See "Configuring a Domain to Use JAAS Authorization" in *Securing Oracle WebLogic Server* for more information about when you might need to do this.

JAAS is used as follows:

- For remote Java client authentication
- For authentication internally in instances of WebLogic Server in the Web and EJB containers and in the WebLogic Authentication and Identity Assertion providers.

For more information on JAAS, see [Section 3.2.2, "Java Authentication and Authorization Service \(JAAS\)"](#).

3.9.1.3 The Java Security Manager

Developed by Sun Microsystems, Inc., the Java Security Manager is the security manager for the Java Virtual Machine (JVM). The security manager works with the Java API to define security boundaries through the `java.lang.SecurityManager` class. The `SecurityManager` class enables programmers to establish a custom security policy for their Java applications.

The Java Security Manager can be used with WebLogic Server to provide additional protection for WebLogic resources running in the JVM. Use of the Java Security Manager to protect WebLogic resources in WebLogic Server is an optional security step.

You can use the Java Security Manager to perform the following security tasks to protect WebLogic resources:

- Modify the `weblogic.policy` file for general use.
- Set application-type security policies on EJBs and Resource Adapters.
You use the Java security policy file to perform this task.
- Set application-specific security policies on specific EJBs and Resource Adapters.
You use the deployment descriptors (`weblogic.xml`, `weblogic-ejb-jar.xml`, and `rar.xml`) to perform this task.

For more information on how to use the Java Security Manager to perform these tasks, see "Using Java Security to Protect WebLogic Resources" in *Programming Security for Oracle WebLogic Server*.

3.9.1.4 Java Cryptography Architecture and Java Cryptography Extensions (JCE)

Developed by Sun Microsystems, Inc., these security APIs provide a framework for accessing and developing cryptographic functionality for the Java platform and developing implementations for encryption, key generation and key agreement, and Message Authentication Code (MAC) algorithms.

WebLogic Server fully supports these security APIs.

3.9.1.5 Java Authorization Contract for Containers (JACC)

JACC provides an alternate authorization mechanism for the EJB and Servlet containers in a WebLogic Server domain. When JACC is configured, the WebLogic Security Framework access decisions, adjudication, and role mapping functions are

not used for EJB and Servlet authorization decisions. The JACC classes are used for role-to-principal mapping as well as for rendering access decisions. You cannot use the JACC framework in conjunction with the WebLogic Security Framework. The JACC classes used by WebLogic Server do not include an implementation of a Policy object for rendering decisions but instead rely on the J2SE 1.4 `java.security.Policy` object.

3.9.2 Common Secure Interoperability Version 2 (CSIv2)

WebLogic Server provides support for the Enterprise JavaBean (EJB) interoperability protocol that is based on Internet Inter-ORB (IIOP) (GIOP version 1.2) and the CORBA Common Secure Interoperability version 2 (CSIv2) specification. CSIv2 support in WebLogic Server:

- Interoperates with the Java 2 Enterprise Edition (J2EE) version 1.4.1 reference implementation.
- Allows WebLogic Server IIOP clients to specify a username and password in the same manner as T3 clients.
- Supports Generic Security Services Application Programming Interface (GSSAPI) initial context tokens. For this release, only usernames and passwords and GSSUP (Generic Security Services Username Password) tokens are supported.

Note: The CSIv2 implementation in WebLogic Server passed Java 2 Enterprise Edition (J2EE) Compatibility Test Suite (CTS) conformance testing.

The external interface to the CSIv2 implementation is a JAAS LoginModule that retrieves the username and password of the CORBA object. The JAAS LoginModule can be used in a WebLogic Java client or in a WebLogic Server instance that acts as a client to another Java EE application server. The JAAS LoginModule for the CSIv2 support is called `UsernamePasswordLoginModule`, and is located in the `weblogic.security.auth.login` package.

Note: For information related to load balancing support for CSIv2 in a WebLogic Server cluster, see "Server Affinity and IIOP Client Authentication Using CSIv2" in *Using Clusters for Oracle WebLogic Server*

Security Realms

This section covers the following topics:

- [Section 4.1, "Introduction to Security Realms"](#)
- [Section 4.2, "Users"](#)
- [Section 4.3, "Groups"](#)
- [Section 4.4, "Security Roles"](#)
- [Section 4.5, "Security Policies"](#)
- [Section 4.6, "Security Providers"](#)

4.1 Introduction to Security Realms

A security realm comprises mechanisms for protecting WebLogic resources. Each security realm consists of a set of configured security providers, users, groups, security roles, and security policies (see [Figure 4-1](#)). A user must be defined in a security realm in order to access any WebLogic resources belonging to that realm. When a user attempts to access a particular WebLogic resource, WebLogic Server tries to authenticate and authorize the user by checking the security role assigned to the user in the relevant security realm and the security policy of the particular WebLogic resource.

Figure 4-1 WebLogic Server Security Realm

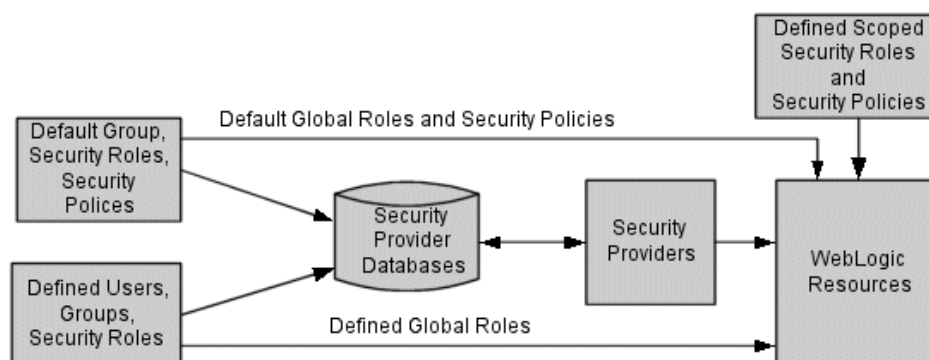

4.2 Users

Users are entities that can be authenticated in a security realm, such as `myrealm` (see [Figure 4-1](#)). A user can be a person, such as application end user, or a software entity, such as a client application, or other instances of WebLogic Server. As a result of

authentication, a user is assigned an identity, or principal. Each user is given a unique identity within the security realm. Users may be placed into groups that are associated with security roles, or be directly associated with security roles.

When users want to access WebLogic Server, they present proof material (for example, a password or a digital certificate) typically through a JAAS LoginModule to the Authentication provider configured in the security realm. If WebLogic Server can verify the identity of the user based on that username and credential, WebLogic Server associates the principal assigned to the user with a thread that executes code on behalf of the user. Before the thread begins executing code, however, WebLogic Server checks the security policy of the WebLogic resource and the principal (that the user has been assigned) to make sure that the user has the required permissions to continue.

When you use the WebLogic Authentication provider and you define a user, you also define a password for that user. WebLogic Server hashes all passwords. Subsequently, when WebLogic Server receives a client request, the password presented by the client is hashed and WebLogic Server compares it to the already hashed password to see if it matches.

Note: All user names and groups must be unique within a security realm.

4.3 Groups

Groups are logically ordered sets of users (see [Figure 4-1](#)). Usually, group members have something in common. For example, a company may separate its sales staff into two groups, Sales Representatives and Sales Managers. Companies may do this because they want their sales personnel to have different levels of access to WebLogic resources, depending on their job functions.

Managing groups is more efficient than managing large numbers of users individually. For example, an administrator can specify permissions for 50 users at one time by placing the users in a group, assigning the group to a security role, and then associating the security role with a WebLogic resource via a security policy.

All user names and groups must be unique within a security realm.

4.4 Security Roles

A **security role** is a privilege granted to users or groups based on specific conditions (see [Figure 4-1](#)). Like groups, security roles allow you to restrict access to WebLogic resources for several users at once. However, unlike groups, security roles:

- Are computed and granted to users or groups dynamically, based on conditions such as user name, group membership, or the time of day.
- Can be scoped to specific WebLogic resources within a single application in a WebLogic Server domain (unlike groups, which are always scoped to an entire WebLogic Server domain).

Granting a security role to a user or a group confers the defined access privileges to that user or group, as long as the user or group is "in" the security role. Multiple users or groups can be granted a single security role.

Note: In WebLogic Server 6.x, security roles applied to Web applications and Enterprise JavaBeans (EJBs) only. In subsequent releases, the use of security roles is expanded to include all of the defined WebLogic resources.

4.5 Security Policies

A security policy is an association between a WebLogic resource and one or more users, groups, or security roles. Security policies protect the WebLogic resource against unauthorized access. A WebLogic resource has no protection until you create a security policy for it. A policy condition is a condition under which a security policy will be created. WebLogic Server provides a set of default policy conditions. WebLogic Server includes policy conditions that access the HTTP Servlet Request and Session attributes and EJB method parameters. Date and Time policy conditions are included in the Policy Editor.

Note: Security policies replace the access control lists (ACLs) that were used to protect WebLogic resources in WebLogic Server 6.x.

4.6 Security Providers

Security providers are modules that provide security services to applications to protect WebLogic resources (see [Figure 4-1](#)). You can use the security providers that are provided as part of the WebLogic Server product, purchase custom security providers from third-party security vendors, or develop your own custom security providers. For information on how to develop custom security providers, see *Developing Security Providers for WebLogic Server*.

The following topics are discussed in this section.

- [Section 4.6.1, "Security Provider Databases"](#)
- [Section 4.6.2, "Types of Security Providers"](#)
- [Section 4.6.3, "Security Providers and Security Realms"](#)

4.6.1 Security Provider Databases

The following sections explain what a security provider database is and describe how security realms affect the use of security provider databases:

- [Section 4.6.1.1, "What Is a Security Provider Database?"](#)
- [Section 4.6.1.2, "Security Realms and Security Provider Databases"](#)
- [Section 4.6.1.3, "Embedded LDAP Server"](#)
- [Section 4.6.1.4, "RDBMS Security Store"](#)

4.6.1.1 What Is a Security Provider Database?

A **security provider database** contains the users, groups, security roles, security policies, and credentials used by some types of security providers to provide security services (see [Figure 4-1](#)). For example: an Authentication provider requires information about users and groups; an Authorization provider requires information about security policies; a Role Mapping provider requires information about security roles, and a Credential Mapping provider requires information about credentials to be

used to remote applications. These security providers need this information to be available in a database in order to function properly.

The security provider database can be the embedded LDAP server (as used by the WebLogic security providers), a properties file (as used by the sample custom security providers, available on the Web), or a production-quality, customer-supplied database that you may already be using.

Note: The sample custom security providers are available at <https://codesamples.samplecode.oracle.com/servlets/tracking?id=S224> on the Oracle Technology Network (OTN).

The security provider database should be initialized the first time security providers are used. (That is, before the security realm containing the security providers is set as the default (active) security realm.) This initialization can be done:

- When a WebLogic Server instance boots.
- When a call is made to one of the security provider's MBeans.

At minimum, the security provider database is initialized with the default groups, security roles, security policies provided by WebLogic Server. For more information, see "Security Providers and WebLogic Resources" in *Developing Security Providers for Oracle WebLogic Server*.

4.6.1.2 Security Realms and Security Provider Databases

If you have multiple security providers of the *same type* configured in the *same security realm*, these security providers may use the same security provider database. This behavior holds true for all of the WebLogic security providers and the sample security providers that are available at the <https://codesamples.samplecode.oracle.com/servlets/tracking?id=S224> on the Oracle Technology Network (OTN).

For example, if you configure two WebLogic Authentication providers in the default security realm (called `myrealm`), both WebLogic Authentication providers will use the same location in the embedded LDAP server as their security provider database, and thus, will use the same users and groups. Furthermore, if you or an administrator add a user or group to one of the WebLogic Authentication providers, you will see that user or group appear for the other WebLogic Authentication provider as well.

Note: If you have two WebLogic security providers (or two sample security providers) of the same type configured in two different security realms, each will use its own security provider database. Only one security realm can be active at a time.

Custom security providers that you develop (or the custom security providers that you obtain from third-party security vendors) can be designed so that each instance of the security provider uses its own database *or* so that all instances of the security provider in a security realm share the same database. This is a design decision that you need to make based on your existing systems and security requirements. For more information about design decisions that affect security providers, see "Design Considerations" in *Developing Security Providers for Oracle WebLogic Server*.

4.6.1.3 Embedded LDAP Server

WebLogic Server uses its embedded LDAP server as the database that stores user, group, security roles, and security policies for the WebLogic security providers. The embedded LDAP server is a complete LDAP server that is production quality for reasonably small environments (10,000 or fewer users). For applications that need to scale above this recommendation, the embedded LDAP server can serve as an excellent development, integration and testing environment for future export to an external LDAP server for production deployment. The embedded LDAP server supports the following access and storage functions:

- Access and modification of entries in the LDAP server
- Use of an LDAP browser to import and export security data into and from the LDAP server.
- Read and write access by the WebLogic security providers.

Note: WebLogic Server does not support adding attributes to the embedded LDAP server.

Table 4–1 shows how each of the WebLogic security providers uses the embedded LDAP server.

Table 4–1 Usage of the Embedded LDAP Server

WebLogic Security Provider	Embedded LDAP Server Usage
Authentication	Stores user and group information.
Identity Assertion	Stores user and group information.
Authorization	Stores security roles and security policies.
Adjudication	None.
Role Mapping	Supports dynamic role associations by obtaining a computed set of roles granted to a requestor for a given WebLogic resource.
Auditing	None.
Credential Mapping	Stores Username-Password credential mapping information.
Certificate Registry	Stores registered end certificates.

4.6.1.4 RDBMS Security Store

WebLogic Server provides the option of using an external RDBMS as a datastore that is used by the following security providers:

- XACML Authorization and Role Mapping providers
- WebLogic Credential Mapping provider
- PKI Credential Mapping provider
- The following providers for SAML 1.1:
 - SAML Identity Assertion provider V2
 - SAML Credential Mapping provider V2
- The following providers for SAML 2.0:
 - SAML 2.0 Identity Assertion provider

- SAML 2.0 Credential Mapping provider
- Default Certificate Registry

When the RDBMS security store is configured in a security realm, an instance of any of the preceding security providers that has been created in the security realm automatically uses only the RDBMS security store as a datastore, and not the embedded LDAP server. Other security providers continue to use their default stores; for example, the WebLogic Authentication provider continues to use the embedded LDAP server.

Oracle recommends that you configure the RDBMS security store at the time of domain creation. The Configuration Wizard has been enhanced to simplify the process. This ensures that when the domain is booted, the security policies required to access the domain can be retrieved from the external RDBMS.

Note that the use of the RDBMS security store is required to use SAML 2.0 services in two or more WebLogic Server instances in a domain, such as in a cluster. For more information about the RDBMS security store, see "Managing the RDBMS Security Store" in *Securing Oracle WebLogic Server*.

4.6.2 Types of Security Providers

The following sections describe the types of security providers that you can use with WebLogic Server:

- [Section 4.6.2.1, "Authentication Providers"](#)
- [Section 4.6.2.2, "Identity Assertion Providers"](#)
- [Section 4.6.2.3, "Principal Validation Providers"](#)
- [Section 4.6.2.4, "Authorization Providers"](#)
- [Section 4.6.2.5, "Adjudication Providers"](#)
- [Section 4.6.2.6, "Role Mapping Providers"](#)
- [Section 4.6.2.7, "Auditing Providers"](#)
- [Section 4.6.2.8, "Credential Mapping Providers"](#)
- [Section 4.6.2.9, "Certificate Lookup and Validation Providers"](#)
- [Section 4.6.2.10, "Keystore Providers"](#)
- [Section 4.6.2.11, "Realm Adapter Providers"](#)

Note: You cannot develop a single security provider that merges several provider types (for example, you cannot have one security provider that does authorization and role mapping).

4.6.2.1 Authentication Providers

Authentication providers allow WebLogic Server to establish trust by validating a user. The WebLogic Server security architecture supports Authentication providers that perform: username/password authentication, certificate and digest authentication directly with WebLogic Server, and HTTP certificate authentication proxied through an external Web server.

Note: An Identity Assertion provider is a special type of Authentication provider that handles perimeter-based authentication and multiple security token types/protocols.

A **LoginModule** is the part of an Authentication provider that actually performs the authentication of a user or system. Authentication providers also use Principal Validation providers which provide additional security by signing and verifying the authenticity of principals (users/groups). For more information about Principal Validation providers, see "Principal Validation Providers" in *Developing Security Providers for Oracle WebLogic Server*.

You must have at least one Authentication provider in a security realm, and you can configure multiple Authentication providers in a security realm. Having multiple Authentication providers allows you to have multiple LoginModules, each of which may perform a different kind of authentication. An administrator configures each Authentication provider to determine how multiple LoginModules are called when users attempt to login to the system. Because they add security to the principals used in authentication, a Principal Validation provider must be accessible to your Authentication providers.

Authentication providers and LoginModules are discussed in more detail in "Authentication Providers" in *Developing Security Providers for Oracle WebLogic Server*.

4.6.2.2 Identity Assertion Providers

Identity assertion involves establishing a client's identity using client-supplied tokens that may exist *outside* of the request. Thus, the function of an Identity Assertion provider is to validate and map a token to a username. Once this mapping is complete, an Authentication provider's LoginModule can be used to convert the username to principals. Identity Assertion providers allow WebLogic Server to establish trust by validating a user.

An Identity Assertion provider is a specific form of Authentication provider that allows users or system processes to assert their identity using tokens (in other words, perimeter authentication). You can use an Identity Assertion provider in place of an Authentication provider if you create a LoginModule for the Identity Assertion provider, or in addition to an Authentication provider if you want to use the Authentication provider's LoginModule. Identity Assertion providers enable perimeter authentication and support single sign-on.

WebLogic Server provides Identity Assertion providers that perform perimeter-based authentication (Web server, firewall, VPN), support token types such as Digest, SPNEGO, and SAML (1.1 and 2.0), and can handle multiple security protocols (Kerberos, SOAP, IIOP-CSIV2). You can also write custom Identity Assertion providers that support different token types, such as Microsoft Passport. When used with an Authentication provider's LoginModule, Identity Assertion providers support single sign-on. For example, the Identity Assertion provider can generate a token from a digital certificate, and that token can be passed around the system so that users are not asked to sign on more than once.

Note: To use the WebLogic Identity Assertion provider for X.501 and X.509 certificates, you have the option of using the default user name mapper that is supplied with the WebLogic Server product (`weblogic.security.providers.authentication.DefaultUserNameMapperImpl`) or providing your own implementation of the `weblogic.security.providers.authentication.UserNameMapper` interface. See "Do You Need to Develop a Custom Identity Assertion Provider?" in *Developing Security Providers for Oracle WebLogic Server*

Multiple Identity Assertion providers can be configured in a security realm, but none are required. An Identity Assertion provider can support more than one token type, but only one token type at a time can be active in a particular Identity Assertion provider. For example, a particular Identity Assertion provider can support both X.509 and SAML (either 1.1 or 2.0, but not both), but an administrator configuring the system must select which token type (X.509 or SAML) is to be active in that Identity Assertion provider. For example, if there only one Identity Assertion provider configured and it is set to handle X.509 tokens, but SAML token types must be supported as well, then another Identity Assertion provider must be configured that can handle SAML tokens and SAML must be set as its active token type.

Note: WebLogic Server provides separate Identity Assertion providers for SAML 1.1 and SAML 2.0. They are not interchangeable between versions of SAML. The SAML Identity Assertion provider V2 consumes SAML 1.1 assertions only, and the SAML 2.0 Identity Assertion provider consumes SAML 2.0 assertions only.

Identity Assertion providers are discussed in more detail in "Identity Assertion Providers" in *Developing Security Providers for Oracle WebLogic Server*.

4.6.2.3 Principal Validation Providers

A Principal Validation provider is a special type of security provider that primarily acts as a "helper" to an Authentication provider. Because some LoginModules can be remotely executed on behalf of RMI clients, and because the client application code can retain the authenticated subject between programmatic server invocations, Authentication providers rely on Principal Validation providers to provide additional security protections for the principals contained within the subject.

Principal Validation providers provide these additional security protections by signing and verifying the authenticity of the principals. This **principal validation** provides an additional level of trust and may reduce the likelihood of malicious principal tampering. Verification of the subject's principals takes place during the WebLogic Server's demarshalling of RMI client requests for each invocation. The authenticity of the subject's principals is also verified when making authorization decisions.

Because you must have at least one Authentication provider in a security realm, you must also have one Principal Validation provider in a security realm. If you have multiple Authentication providers, each of those Authentication providers must have a corresponding Principal Validation provider.

Note: You cannot use the WebLogic Server Administration Console to configure Principal Validation providers directly. WebLogic Server configures the required Principal Validation providers for you when you configure your Authentication providers.

Principal Validation providers are discussed in more detail in "Principal Validation Providers" in *Developing Security Providers for Oracle WebLogic Server*.

4.6.2.4 Authorization Providers

Authorization providers control access to WebLogic resources based on the security role a user or group is granted, and the security policy assigned to the requested WebLogic resource. For more information about WebLogic resources, security roles, and security policies, see *Securing Resources Using Roles and Policies for Oracle WebLogic Server*.

An **Access Decision** is the part of the Authorization provider that actually determines whether a subject has permission to perform a given operation on a WebLogic resource. For more information about, see "Principal Validation Providers" in *Developing Security Providers for Oracle WebLogic Server*.

You must have at least one Authorization provider in a security realm, and you can configure multiple Authorization providers in a security realm. Having multiple Authorization providers allows you to follow a more modular design. For example, you may want to have one Authorization provider that handles Web application and Enterprise JavaBean (EJB) permissions and another that handles permissions for other types of WebLogic resources. Another example might be to have one Authorization provider that handles domestic employees, and another that handles permissions for overseas employees.

WebLogic Server includes bulk access versions of the following Authorization provider SSPI interfaces:

- BulkAuthorizationProvider
- BulkAccessDecision

The bulk access SSPI interfaces allow Authorization providers to receive multiple decision requests in one call rather than through multiple calls, typically in a 'for' loop. The intent of the bulk SSPI variants is to allow provider implementations to take advantage of internal performance optimizations, such as detecting that many of the passed-in Resource objects are protected by the same policy and will generate the same decision result.

Authorization providers and Access Decisions are discussed in more detail in "Authorization Providers" in *Developing Security Providers for Oracle WebLogic Server*.

4.6.2.5 Adjudication Providers

As part of an Authorization provider, an Access Decision determines whether a subject has permission to access a given WebLogic resource. Therefore, if multiple Authorization providers are configured, each may return a different answer to the "is access allowed?" question. These answers may be PERMIT, DENY, or ABSTAIN. Determining what to do if multiple Authorization providers' Access Decisions do not agree on an answer is the function of an Adjudication provider. The Adjudication provider resolves authorization conflicts by weighing each Access Decision's answer and returning a final result. If you only have one Authorization provider and no

Adjudication provider, then an ABSTAIN returned from the single Authorization provider's Access Decision is treated like a DENY.

Note: The WebLogic Adjudication provider supports the use of the WebLogic Server Administration Console to control whether an abstain is treated as a permit or a deny.

You must configure an Adjudication provider in a security realm *only* if you have multiple Authorization providers configured. You can have only one Adjudication provider in a security realm.

Note: Because the default security realm has only one Authorization provider, it does not require an Adjudication provider, even though an Adjudication provider is provided. However, the Compatibility realm has two Authorization providers, so that realm does require an Adjudication provider.

WebLogic Server includes bulk access versions of the following Adjudication provider SSPI interfaces:

- BulkAdjudicationProvider
- BulkAdjudicator

The bulk access SSPI interfaces allow Adjudication providers to receive multiple decision requests in one call rather than through multiple calls, typically in a 'for' loop. The intent of the bulk SSPI variants is to allow provider implementations to take advantage of internal performance optimizations, such as detecting that many of the passed-in Resource objects are protected by the same policy and will generate the same decision result.

Adjudication providers are discussed in more detail in "Adjudication Providers" in *Developing Security Providers for Oracle WebLogic Server*.

4.6.2.6 Role Mapping Providers

A Role Mapping provider supports dynamic role associations by obtaining a computed set of security roles granted to a requestor for a given WebLogic resource. The WebLogic Security Framework determines which security roles (if any) apply to a particular subject at the moment that access is required for a given WebLogic resource by:

- Obtaining security roles from the J2EE and WebLogic deployment descriptor files.
- Using business logic and the current operation parameters to determine security roles.

A Role Mapping provider supplies Authorization providers with this security role information so that the Authorization provider can answer the "is access allowed?" question for WebLogic resources that use role-based security (that is, Web application and Enterprise JavaBean container resources).

You set security roles in J2EE deployment descriptors, or create them using the WebLogic Server Administration Console. Security roles set in deployment descriptors are applied at deployment time (unless you specifically choose to ignore deployment descriptors).

You must have at least one Role Mapping provider in a security realm, and you can configure multiple Role Mapping providers in a security realm. Having multiple Role Mapping providers allows you to work within existing infrastructure requirements (for example, configuring one Role Mapping provider for each LDAP server that contains user and security role information), or follow a more modular design (for example, configuring one Role Mapping provider that handles mappings for Web applications and Enterprise JavaBeans (EJBs) and another that handles mappings for other types of WebLogic resources).

Note: If multiple Role Mapping providers are configured, the set of security roles returned by all Role Mapping providers will be intersected by the WebLogic Security Framework. That is, security role names from all the Role Mapping providers will be merged into single list, with duplicates removed.

WebLogic Server includes bulk access versions of the following Role Mapping provider SSPI interfaces:

- BulkRoleProvider
- BulkRoleMapper

The bulk access SSPI interfaces allow Role Mapping providers to receive multiple decision requests in one call rather than through multiple calls, typically in a 'for' loop. The intent of the bulk SSPI variants is to allow provider implementations to take advantage of internal performance optimizations, such as detecting that many of the passed-in Resource objects are protected by the same policy and will generate the same decision result.

Role Mapping providers are discussed in more detail in "Role Mapping Providers" in *Developing Security Providers for Oracle WebLogic Server*.

4.6.2.7 Auditing Providers

An Auditing provider collects, stores, and distributes information about operating requests and the outcome of those requests for the purposes of non-repudiation. An Auditing provider makes the decision about whether to audit a particular event based on specific audit criteria, including audit severity levels. Auditing providers can write the audit information to output repositories such as an LDAP directory, database, or simple file. Specific actions, such as paging security personnel, can also be configured as part of an Auditing provider.

Other types of security providers (such as Authentication or Authorization providers) can request audit services before and after security operations have been performed by calling through the WebLogic Security Framework. For more information, see "Auditing Events From Custom Security Providers" in *Developing Security Providers for Oracle WebLogic Server*.

You can configure multiple Auditing providers in a security realm, but none are required.

Auditing providers are discussed in more detail in "Auditing Providers" in *Developing Security Providers for Oracle WebLogic Server*.

4.6.2.8 Credential Mapping Providers

A **credential map** is a mapping of credentials used by WebLogic Server to credentials used in a legacy or remote system, which tell WebLogic Server how to connect to a

given resource in that system. In other words, credential maps allow WebLogic Server to log into a remote system on behalf of a subject that has already been authenticated.

A Credential Mapping provider can handle several different types of credentials (for example, username/password combinations, SAML assertions, public key certificates, and alias/credential type combinations). You can set credential mappings in deployment descriptors or by using the WebLogic Server Administration Console. These credential mappings are applied at deploy time (unless you specifically choose to ignore the credential mappings).

You must have at least one Credential Mapping provider in a security realm, and you can configure multiple Credential Mapping providers in a security realm. If multiple Credential Mapping providers are configured, then the WebLogic Security Framework calls into each Credential Mapping provider to find out if they contain the type of credentials requested by the container. The WebLogic Security Framework then accumulates and returns all the credentials as a list.

Note: WebLogic Server provides separate Credential Mapping providers for SAML 1.1 and SAML 2.0. They are not interchangeable between versions of SAML. The SAML Credential Mapping provider V2 generates SAML 1.1 assertions only, and the SAML 2.0 Credential Mapping provider generates SAML 2.0 assertions only.

Credential Mapping providers are discussed in more detail in "Credential Mapping Providers" in *Developing Security Providers for Oracle WebLogic Server*.

4.6.2.9 Certificate Lookup and Validation Providers

The Certificate Lookup and Validation providers complete certificate paths and validate X509 certificate chains. There are two types of CLV providers:

- CertPath Builder - Receives a certificate, a certificate chain, or certificate reference (the end certificate in a chain or the Subject DN of a certificate) from a web service or application code. The provider looks up and validates the certificates in the chain.
- CertPath Validator - Receives a certificate chain from the SSL protocol, a web service, or application code and performs extra validation (for example, revocation checking).

There must be at least one CertPath Builder and one CertPath Validator configured in a security realm. Multiple CertPath Validators can be configured in a security realm. If multiple providers are configured, a certificate or certificate chain must pass validation with all the CertPath Validators in order for the certificate or certificate chain to be valid.

WebLogic Server provides the functionality of the CLV providers in the WebLogic CertPath provider and the Certificate Registry.

4.6.2.10 Keystore Providers

With WebLogic Server, a keystore creates and manages password-protected stores of private keys (and their associated public key certificates) and trusted certificate authorities.

The WebLogic Keystore provider that is included as part of the WebLogic Server product is used to obtain secured private keys from keystores.

Note: The WebLogic Keystore provider is deprecated in this release of WebLogic Server but is still supported. The development of custom Keystore providers is not supported. Use the WebLogic Trust and Identity keystores or the Java KeyStores (JKS) instead. All of the functionality that was supported by the WebLogic Keystore provider is available through use of these keystores. The WebLogic Keystore provider is only supported for backward compatibility. Oracle recommends using the WebLogic Keystore provider only when it is needed to support backward compatibility with a WebLogic Server 7.0 configuration.

4.6.2.11 Realm Adapter Providers

Realm Adapter providers provide backward-compatibility with 6.x WebLogic security realms by allowing the use of existing, 6.x security realms with the security features in this release of WebLogic Server. The Realm Adapter providers map the realm API (`weblogic.security.acl`) used in WebLogic Server 6.x to the APIs used in this release of WebLogic Server. [Figure 4-2](#) shows a Compatibility realm and the types of security providers supported.

Figure 4-2 *Compatibility Realm*

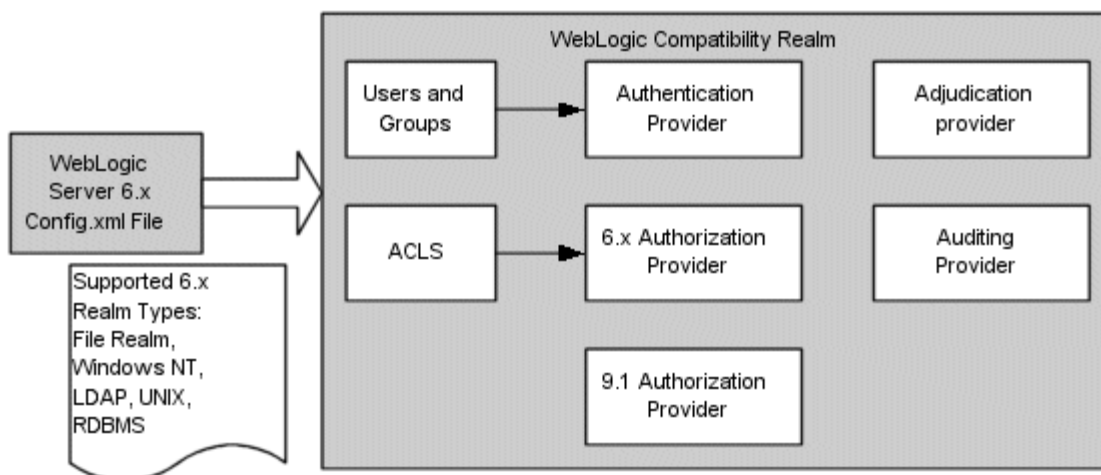

4.6.2.12 Security Provider Summary

[Figure 4-2](#) indicates whether you can configure multiple security providers of the same type in a security realm.

Table 4-2 *Multiple Providers of Same Type in Same Security Realm*

Type	Multiple Providers Supported?
Authentication provider	Yes
Identity Assertion provider	Yes
Principal Validation provider	Yes
Authorization provider	Yes
Adjudication provider	No
Role Mapping provider	Yes

Table 4–2 (Cont.) Multiple Providers of Same Type in Same Security Realm

Type	Multiple Providers Supported?
Auditing provider	Yes
Credential Mapping provider	Yes
Certificate Lookup and Validation provider	One CertPath Builder Multiple CertPath Validators
Keystore provider	Yes
Realm Adapter provider	Yes for all types of Realm Adapter providers supported except the Adjudication provider. See Figure 4–2 for the supported types.

4.6.3 Security Providers and Security Realms

All security providers exist within the context of a security realm. If you are *not* running a prior, 6.x release of WebLogic Server, the WebLogic Server security realm defined out-of-the-box as the **default realm** (that is, the active security realm called `myrealm`) contains the WebLogic security providers displayed in [Figure 4–3](#).

Note: If you are upgrading from a 6.x release to this release, your out-of-the-box experience begins with a Compatibility realm - which is initially defined as the default realm - to allow you to work with your existing configuration. Because the 6.x model is deprecated, you need to upgrade your security realm to the security model available in this release of WebLogic Server.

Figure 4–3 WebLogic Security Providers in a Security Realm

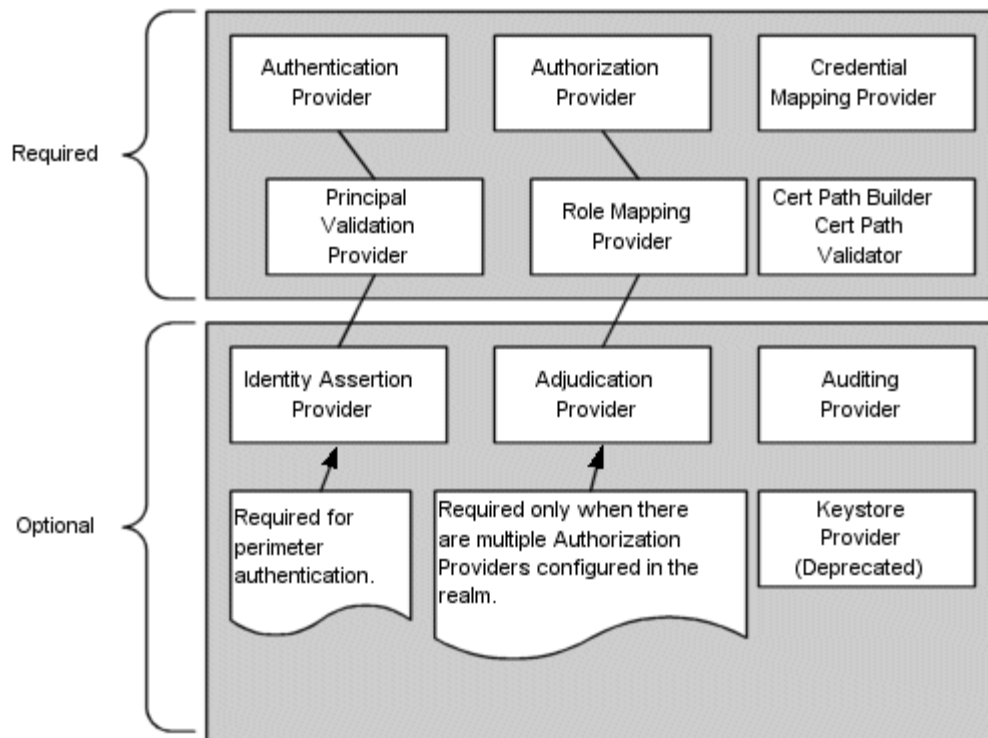

Because security providers are individual modules or components that are "plugged into" a WebLogic Server security realm, you can add, replace, or remove a security provider with minimal effort. You can use the WebLogic security providers, custom security providers you develop, security providers obtained from third-party security vendors, or a combination of all three to create a fully-functioning security realm. However, as [Figure 4-3](#) also shows, some types of security providers are required for a security realm to operate properly. [Table 4-1](#) summarizes which security providers must be configured for a fully-operational security realm.

Table 4-3 Security Providers in a Security Realm

Type	Required?
Authentication provider	Yes
Identity Assertion provider	Yes, if using perimeter authentication.
Principal Validation provider	Yes
Authorization provider	Yes
Adjudication provider	Yes, if there are multiple Authorization providers configured.
Role Mapping provider	Yes
Auditing provider	No
Credential Mapping provider	Yes
Certificate Lookup and Validation providers	Yes
Keystore provider	No

Note: The WebLogic Keystore provider is deprecated in this release of WebLogic Server but is still supported. The development of custom Keystore providers is not supported. Use Java KeyStores (JKS) instead. Oracle recommends using the WebLogic Keystore provider only when it is needed to support backward compatibility with a WebLogic Server 7.0 configuration. For information on how to use Java KeyStores, see "Configuring Keystores for Production" in *Securing Oracle WebLogic Server*.

For more information about security realms, see "Configuring WebLogic Security: Main Steps" in *Securing Oracle WebLogic Server*.

WebLogic Security Service Architecture

This section provides a description of the architecture of the WebLogic Security Service. The architecture comprises three major components, which are discussed in the following sections:

- [Section 5.1, "WebLogic Security Framework"](#)
- [Section 5.2, "Single Sign-On with the WebLogic Security Framework"](#)
- [Section 5.3, "SAML Token Profile Support in WebLogic Web Services"](#)
- [Section 5.4, "The Security Service Provider Interfaces \(SSPIs\)"](#)
- [Section 5.5, "Weblogic Security Providers"](#)

5.1 WebLogic Security Framework

[Figure 5–1](#) shows a high-level view of the WebLogic Security Framework. The framework comprises interfaces, classes, and exceptions in the `weblogic.security.service` package.

Figure 5–1 WebLogic Security Service Architecture

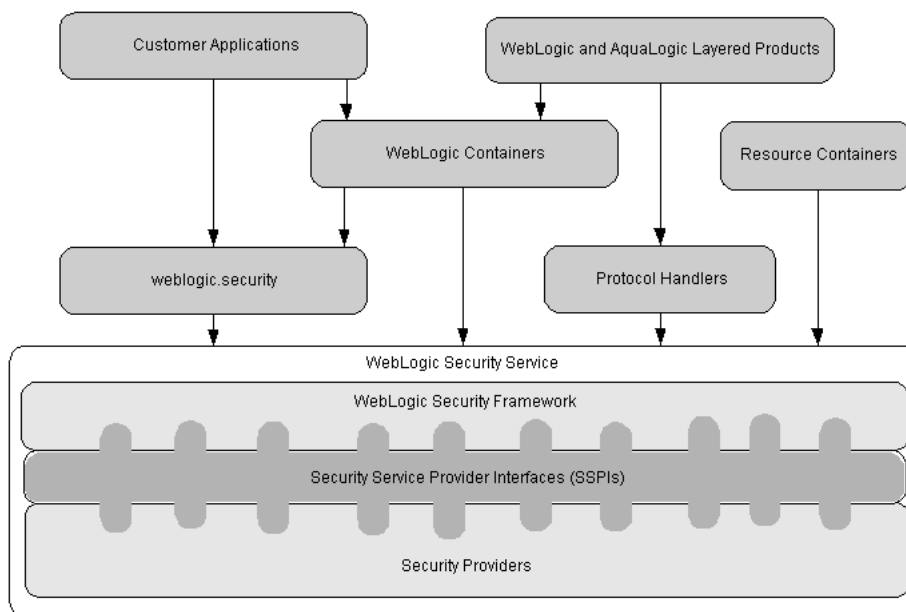

The primary function of the WebLogic Security Framework is to provide a simplified application programming interface (API) that can be used by security and application developers to define security services. Within that context, the WebLogic Security Framework also acts as an intermediary between the WebLogic containers (Web and EJB), the Resource containers, and the security providers.

The following sections describe the interactions between the WebLogic containers and Resource containers and each of the security providers via the WebLogic Security Framework:

- [Section 5.1.1, "The Authentication Process"](#)
- [Section 5.1.2, "The Identity Assertion Process"](#)
- [Section 5.1.3, "The Principal Validation Process"](#)
- [Section 5.1.4, "The Authorization Process"](#)
- [Section 5.1.5, "The Adjudication Process"](#)
- [Section 5.1.6, "The Role Mapping Process"](#)
- [Section 5.1.7, "The Auditing Process"](#)
- [Section 5.1.8, "The Credential Mapping Process"](#)
- [Section 5.1.9, "The Certificate Lookup and Validation Process"](#)

5.1.1 The Authentication Process

Figure 5–2 shows the authentication process for a fat-client login. JAAS runs on the server to perform the login. Even in the case of a thin-client login (that is, a Web browser client) JAAS is still run on the server.

Figure 5–2 The Authentication Process

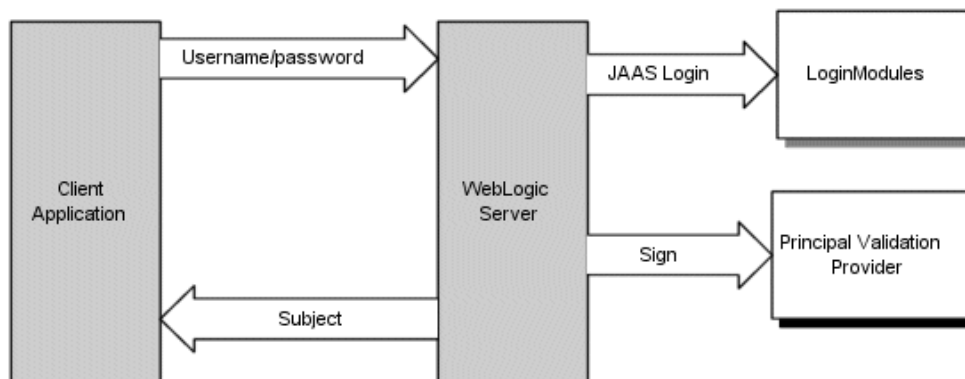

Note: Only developers of custom Authentication providers will be involved with this JAAS process directly. The client application could either use a JNDI Initial Context or JAAS to initiate the passing of the username and password.

When a user attempts to log into a system using a username/password combination, WebLogic Server establishes trust by validating that user's username and password, and returns a subject that is populated with principals per JAAS requirements. As Figure 5–2 also shows, this process requires the use of a LoginModule and a Principal

Validation provider. For more information on Principal Validation providers, see [Section 5.5.8, "WebLogic Principal Validation Provider"](#).

After successfully proving a caller's identity, an authentication context is established, which allows an identified user or system to be authenticated to other entities. Authentication contexts may also be delegated to an application component, allowing that component to call another application component while impersonating the original caller.

5.1.2 The Identity Assertion Process

Identity Assertion providers are used as part of perimeter authentication process. When perimeter authentication is used (see [Figure 5-3](#)), a token from outside of the WebLogic Server domain is passed to an Identity Assertion provider in a security realm that is responsible for validating tokens of that type and that is configured as "active." If the token is successfully validated, the Identity Assertion provider maps the token to a WebLogic Server username, and sends that username back to WebLogic Server, which then continues the authentication process. Specifically, the username is sent via a JAAS `CallbackHandler` and passed to each configured Authentication provider's `LoginModule` so that the `LoginModule` can populate the subject with the appropriate principals.

Note: To use the WebLogic Identity Assertion provider for X.501 and X.509 certificates, you have the option of using either the default user name mapper that is supplied with the WebLogic Server product (`weblogic.security.providers.authentication.DefaultUserNameMapperImpl`) or your own implementation of the `weblogic.security.providers.authentication.UserNameMapper` interface. See "Do You Need to Develop a Custom Identity Assertion Provider?" in *Developing Security Providers for Oracle WebLogic Server*.

Figure 5-3 Perimeter Authentication

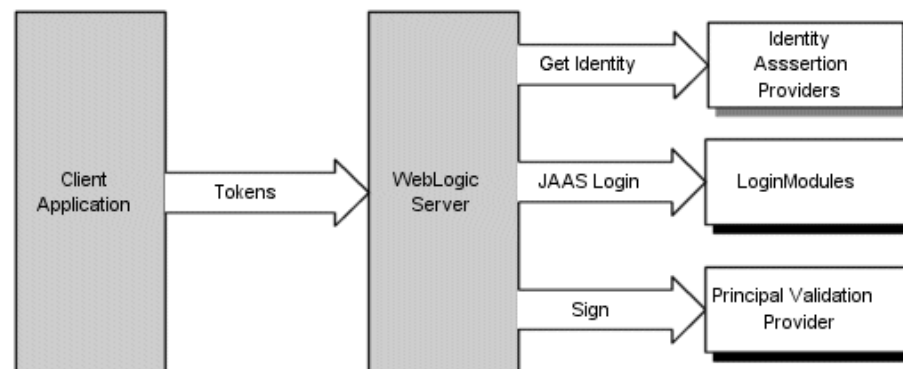

As [Figure 5-3](#) also shows, perimeter authentication requires the same components as the authentication process, but also adds an Identity Assertion provider.

5.1.3 The Principal Validation Process

As shown in [Figure 5-4](#), a user attempts to log into a system using a username/password combination. WebLogic Server establishes trust by calling the configured Authentication provider's `LoginModule`, which validates the user's

username and password and returns a subject that is populated with principals per JAAS requirements.

Figure 5-4 The Principal Validation Process

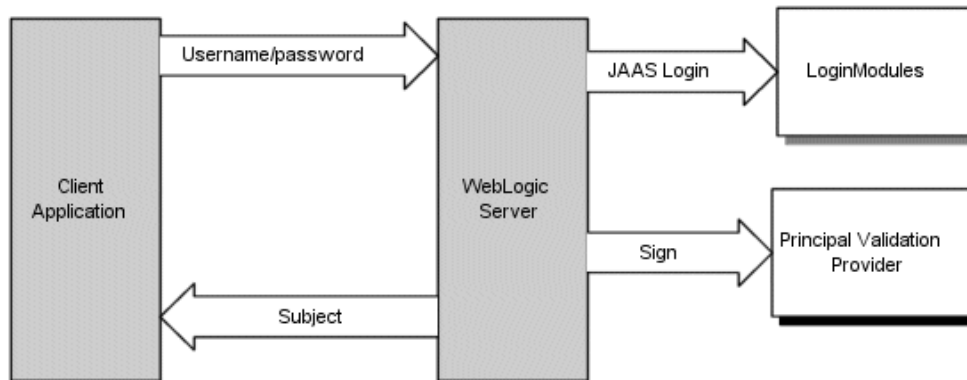

WebLogic Server then passes the subject to the specified Principal Validation provider, which signs the principals and returns them to the client application via WebLogic Server. Whenever the principals stored within the subject are required for other security operations, the same Principal Validation provider will verify that the principals stored within the subject have not been modified since they were signed.

5.1.4 The Authorization Process

Figure 5-5 illustrates how Authorization providers (and the associated Adjudication and Role Mapping providers) interact with the WebLogic Security Framework during the authorization process.

Figure 5-5 Authorization Process

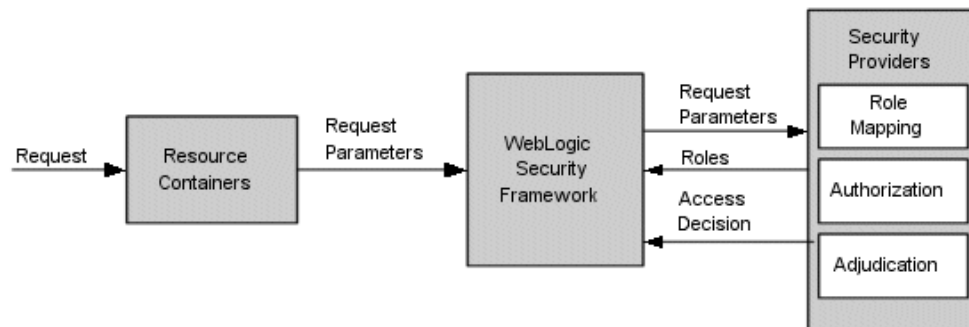

The authorization process is initiated when a user or system process requests a WebLogic resource on which it will attempt to perform a given operation. The resource container that handles the type of WebLogic resource being requested receives the request (for example, the EJB container receives the request for an EJB resource). The resource container calls the WebLogic Security Framework and passes in the request parameters, including information such as the subject of the request and the WebLogic resource being requested. The WebLogic Security Framework calls the configured Role Mapping providers and passes in the request parameters in a format that the Role Mapping providers can use. The Role Mapping providers use the request parameters to compute a list of roles to which the subject making the request is entitled and passes the list of applicable roles back to the WebLogic Security Framework. The Authorization provider determines whether the subject is entitled to perform the

requested action on the WebLogic resource, that is, the Authorization provider makes the Access Decision. If there are multiple Authorization providers configured, the WebLogic Security Framework delegates the job of reconciling any conflicts in the Access Decisions rendered by the Authorization providers to the Adjudication provider and the Adjudication provider determines the ultimate outcome of the authorization decision.

5.1.5 The Adjudication Process

If there are multiple Authorization providers configured (see [Figure 5-5](#)), an Adjudication provider is required to tally the multiple Access Decisions and render a verdict. The Adjudication provider returns either a TRUE or FALSE verdict to the Authorization providers, which forward it to the resource container through the WebLogic Security Framework.

- If the decision is TRUE, the resource container dispatches the request to the protected WebLogic resource.
- If the decision is FALSE, the resource container throws a security exception that indicates that the requestor was not authorized to perform the requested access on the protected WebLogic resource.

5.1.6 The Role Mapping Process

The WebLogic Security Framework calls each Role Mapping provider that is configured for a security realm as part of an authorization decision. For related information, see [Section 5.1.4, "The Authorization Process"](#).

[Figure 5-6](#) shows how the Role Mapping providers interact with the WebLogic Security Framework to create dynamic role associations.

Figure 5-6 Role Mapping Process

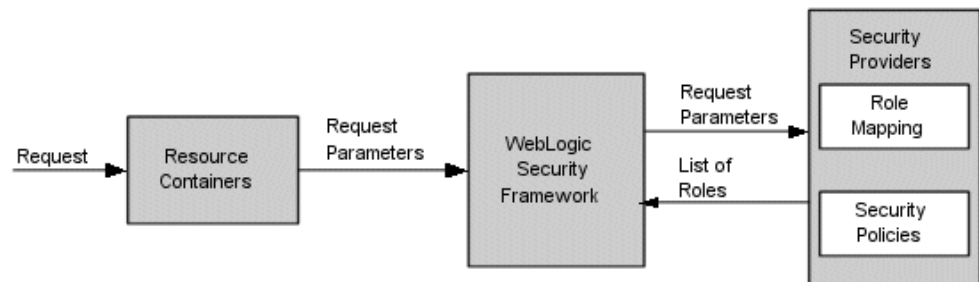

The role mapping process is initiated when a user or system process requests a WebLogic resource on which it will attempt to perform a given operation. The resource container that handles the type of WebLogic resource being requested receives the request (for example, the EJB container receives the request for an EJB resource). The resource container calls the WebLogic Security Framework and passes in the request parameters, including information such as the subject of the request and the WebLogic resource being requested. The WebLogic Security Framework calls each configured Role Mapping provider to obtain a list of the roles that apply. If a security policy specifies that the requestor is entitled to a particular role, the role is added to the list of roles that are applicable to the subject. This process continues until all security policies that apply to the WebLogic resource or the resource container have been evaluated. The list of roles is returned to the WebLogic Security Framework, where it can be used as part of other operations, such as access decisions.

The result of the dynamic role association (performed by the Role Mapping providers) is a set of roles that apply to the principals stored in a subject at a given moment. These roles can then be used to make authorization decisions for protected WebLogic resources, as well as for resource container and application code. For example, an Enterprise JavaBean (EJB) could use the Java EE `isCallerInRole` method to retrieve fields from a record in a database, without having knowledge of the business policies that determine whether access is allowed.

5.1.7 The Auditing Process

Figure 5-7 shows how Auditing providers interact with the WebLogic Security Framework and other types of security providers (using an Authentication provider as an example).

Figure 5-7 Auditing Process

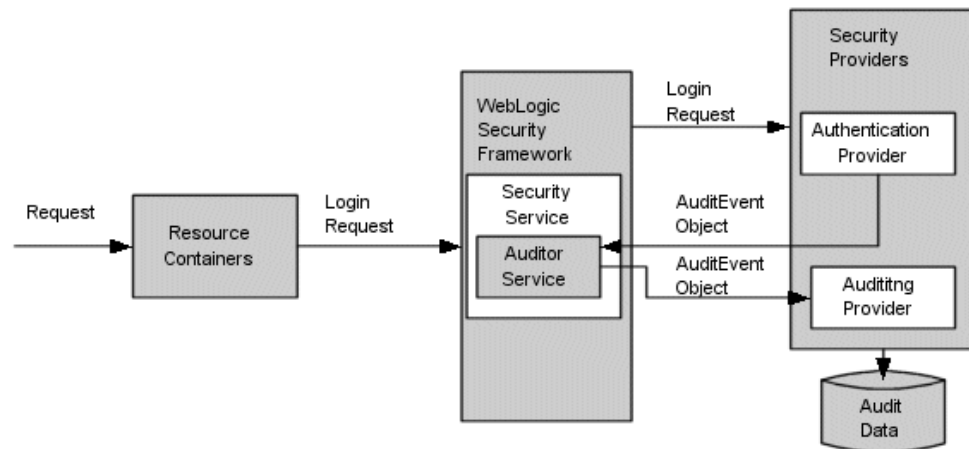

The auditing process is initiated when a resource container passes a user's authentication information (for example, a username/password combination) to the WebLogic Security Framework as part of a login request. The WebLogic Security Framework passes the information associated with the login request to the configured Authentication provider. If, in addition to providing authentication services, the Authentication provider is designed to post audit events, the Authentication provider instantiates an `AuditEvent` object. The `AuditEvent` object includes information such as the event type to be audited and an audit severity level. The Authentication provider then calls the Auditor Service in the WebLogic Security Framework, passing in the `AuditEvent` object. The Auditor Service passes the `AuditEvent` object to the configured Auditing providers' runtime classes, enabling audit event recording. The Auditing providers' runtime classes use the information obtained from the `AuditEvent` object to control audit record content. When the criteria for auditing specified by the Authentication providers in the `AuditEvent` object is met, the appropriate Auditing provider's runtime class writes out audit records. Depending on the Auditing provider implementation, audit records may be written to a file, a database, or some other persistent storage medium.

5.1.8 The Credential Mapping Process

Figure 5-8 illustrates how Credential Mapping providers interact with the WebLogic Security Framework during the credential mapping process.

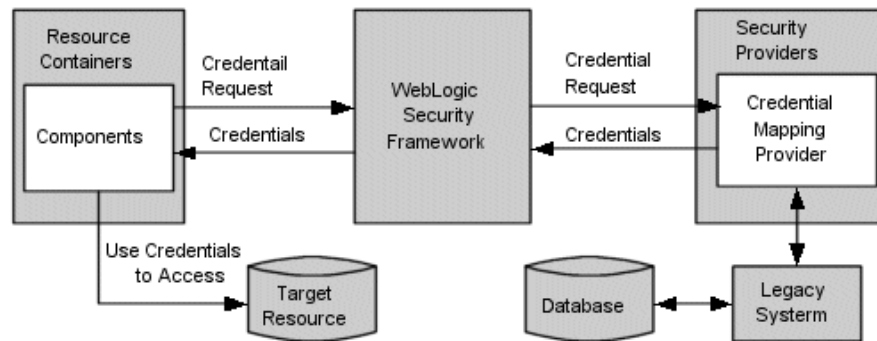
Figure 5–8 Credential Mapping Process

The credential mapping process is initiated when application components, such as JavaServer Pages (JSPs), servlets, Enterprise JavaBeans (EJBs), or Resource Adapters call into the WebLogic Security Framework (through the appropriate resource container) to access an Enterprise Information System (EIS), for example, some relational database like Oracle, SQL Server, and so on. As part of the call, the application component passes in the subject (that is, the "who" making the request), the WebLogic resource (that is, the "what" that is being requested) and information about the type of credentials needed to access the WebLogic resource. The WebLogic Security Framework sends the application component's request for credentials to a configured Credential Mapping provider that handles the type of credentials needed by the application component. The Credential Mapping provider consults its database to obtain a set of credentials that match those requested by the application component and returns the credentials to the WebLogic Security Framework. The WebLogic Security Framework passes the credentials back to the requesting application component through the resource container. The application component uses the credentials to access the external system.

5.1.9 The Certificate Lookup and Validation Process

During the certificate lookup and validation process, CertPath Builders, CertPath Validators, and the Certificate Lookup and Validation (CLV) framework all interact.

The process for building certificate chains works as follows:

1. The CLV framework is passed a certificate chain and a cert path selector (either the end certificate, the Subject DN, the Issuer DN plus serial number, and/or the subject key identifier) from either a WebLogic Web service or application code.
2. The CLV framework calls the CertPath Builder to locate the certificate chain and validate it. When using Web services, the CLV framework passes the server's list of trusted CAs to the provider. Application code passes in a list of trusted CAs to the provider.

3. If the certificate chain is found and valid, the CLV framework calls any CertPath Validators configured in the security realm the order they were configured.

The certificate chain is only valid if the CertPath Builder and all the configured CertPath Validators successfully validate it.

4. The CLV framework returns the certificate chain to the requesting party.
5. Processing continues.

The process for validating certificate chains works as follows:

1. The CLV framework is passed a certificate chain and a cert path selector (either the end certificate, the Subject DN, the Issuer DN plus serial number, and/or the

subject key identifier) from the SSL protocol, a WebLogic Web service, or application code.

2. The CLV framework ensures calls the certificate chain is ordered and each certificate in the chain signs the next.
3. If the certificate chain is valid, the CLV framework calls any CertPath Validators configured in the security realm the order they were configured.

The certificate chain is only valid if all the configured CertPath Validators successfully validate it. Validation stops if an error occurs.

4. The CLV framework returns the certificate chain to the requesting party.
5. Processing continues.

5.2 Single Sign-On with the WebLogic Security Framework

The SAML and Windows Integrated Login features provide web-based single sign-on (SSO) functionality for WebLogic Server applications. The following sections describe the interactions among the WebLogic containers, the security providers, and the WebLogic Security Framework during the single sign-on process:

- [Section 5.2.1, "Single Sign-On with SAML 1.1"](#)
- [Section 5.2.2, "Single Sign-On and SAML 2.0"](#)
- [Section 5.2.3, "Desktop SSO Process"](#)

5.2.1 Single Sign-On with SAML 1.1

The following sections describe how a WebLogic Server instance behaves during when configured with SAML 1.1 services:

- [Section 5.2.1.1, "WebLogic Server Acting a SAML 1.1 Source Site"](#)
- [Section 5.2.1.2, "Weblogic Server Acting as SAML 1.1 Destination Site"](#)

5.2.1.1 WebLogic Server Acting a SAML 1.1 Source Site

Acting as a SAML source involves the following:

- Generating valid SAML assertions that assert that a source domain has authenticated a user and provide the name by which the user is known at the SAML source site. Optionally, the names of the local (source site) groups that the user is a member of are provided.
- Providing a SAML ITS and a SAML Assertion Retrieval Service (ARS)

WebLogic Server can act as a SAML ITS and ARS. These services are provided by a servlet that is deployed based on configuration settings on the Server > Configuration > Federated Services pages in the Administration Console.

The SAML ITS service requires separate URLs for the POST and Artifact profiles for V1 SAML providers; separate URLs are not required for the POST and Artifact profiles with V2 SAML providers.

The following sections detail how WebLogic Server is used as a SAML source in the POST and Artifact profiles.

5.2.1.1.1 POST Profile The POST profile works as follows:

1. The user accesses the web site (for example, `http://www.weblogic.com/samlits/its`) for the SAML source site.
2. The SAML ITS servlet calls the SAML Credential Mapper to request a bearer assertion.
3. The SAML Credential Mapping provider returns the assertion. The SAML Credential Mapping provider also returns the URL of the SAML destination site and the path to the appropriate POST form.
4. The SAML ITS servlet generates a signed SAML response containing the generated assertion, signs it, base64-encodes it, and embeds it in the HTML form (default or custom).
5. The SAML ITS servlet returns the form to the user's browser.
6. The user's browser POSTs the form to the destination site's ACS.
7. The assertion is validated and if successful, the user is logged in and redirected to the target.

5.2.1.1.2 Artifact Profile

The Artifact profile works as follows:

1. The user accesses the web site (`www.weblogic.com`) for the SAML source site.
2. The SAML Inter-site Transfer Service (ITS) servlet calls the SAML Credential Mapper to request an assertion, passing in the desired assertion type (artifact).
3. The SAML Credential Mapping provider returns the assertion. The SAML Credential Mapping provider also returns the destination Assertion Consumer Service (ACS) URL and the assertion ID.
4. The SAML ITS servlet generates an artifact based on the assertion ID and the local source site's source ID. (This value is calculated from the Source Site URL configured on the Federation Services Source Site page.)
5. The SAML ITS servlet redirects the user to the Assertion Consumer Service (ACS) of the SAML destination site, passing the artifact as a query parameter.
6. The ACS gets the artifact from the query parameter and decodes it to get the source ID. It then uses the source ID to look up the URL of the Assertion Retrieval Service (ARS) of the SAML source site. The ACS then sends a request to the URL of the ARS of the SAML source site requesting the assertion corresponding to the artifact.
7. The SAML Assertion Retrieval Service (ARS) responds to the incoming assertion request, using the artifact to locate the corresponding assertion in its assertion store, and if found, returning the assertion to the SAML destination site.
8. The assertion is validated and if successful, the user is logged in and redirected to the target.

5.2.1.2 Weblogic Server Acting as SAML 1.1 Destination Site

WebLogic Server acts as a SAML destination site when an unauthenticated Web browser or HTTP client tries to access a protected WebLogic resource and SAML is configured as the authentication mechanism in the security realm.

The SAML destination site is implemented as a servlet authentication filter (referred to as the SAML authentication filter) deployed by the SAML Identity Assertion provider based on its configuration. The SAML destination site listens for incoming assertions at one or more configured URLs. These URLs provide the Access Consumer Service (ACS). The SAML destination site can also be configured to redirect unauthenticated

users to remote SAML source sites for authentication based on the particular URL they tried to access.

The following sections detail how WebLogic Server is used as a SAML destination in the POST and Artifact profiles.

5.2.1.2.1 POST Profile In a typical SSO scenario, the POST profile works as follows:

1. The user accesses the web site (for example, `http://www.weblogic.com/samlits/its`) for the SAML source site.
2. The SAML source site authenticates the user, generates an assertion, and returns a POST form containing the assertion in a signed SAML response to the user's browser.
3. The user's browser posts the POST form to the ACS at the SAML destination site. The ACS looks for an asserting party ID (APID) as a form parameter of the incoming request, and uses this to look up the configuration before performing any other processing.
4. Upon receiving a POST form from the SAML source site, the SAML destination site extracts the embedded SAML response from the POST form and verifies trust in the certificate used to sign the response. An optional recipient check may be performed depending on the configuration.
5. The SAML Authentication filter also ensures that this assertion has not been previously used. If the one-use check is configured, the filter checks to see if the assertion has already been used. If so, the filter returns an error. If not, the filter persists the assertion to enable future checks.
6. One of the following then occurs:
 - If the one-use check or any other validity/trust check fails, the login fails and WebLogic Server returns a 403 `Forbidden`.
 - If the one-use check and any other validity/trust checks are successful, the user is logged in (by the `assertIdentity()` call). The SAML authentication filter creates a session for the user and redirects the now authenticated user to the requested target URL.

5.2.1.2.2 Artifact Profile The Artifact profile works as follows:

1. The user accesses the web site (for example, `http://www.weblogic.com/samlits/its`) for the SAML source site.
2. The request is redirected to the SAML ITS service.
3. The SAML source site authenticates user.
4. After the user is authenticated, the SAML ITS generates an assertion and then generates a base-64 encoded artifact that contains the assertion ID and the source ID of the SAML ITS.
5. The SAML ITS redirects the user to the Assertion Consumer Service (ACS) of the SAML destination site, passing the artifact as a query parameter on the redirect URL. The ACS looks for an asserting party ID (APID) as a query parameter of the incoming request, and uses this to look up the configuration before performing any other processing. The ACS gets the artifact by looking for the query parameter.
6. The SAML authentication filter base64-decodes the artifact to determine the source ID of the SAML source site and the assertion ID. The source ID is used to look up the Assertion Retrieval URL for that source site. The filter then makes a SOAP

request to the Artifact Retrieval Service (ARS) at the SAML source site, sending the artifact and requesting the corresponding assertion.

7. The SAML source site returns an assertion.
8. The SAML authentication filter calls the `PrincipalValidator` to assert the user's identity.
9. One of the following then occurs:
 - If any validity/trust check fails, the login fails and WebLogic Server returns a `403 Forbidden`.
 - If all validity/trust checks are successful, the user is logged in (by the `assertIdentity()` call). The SAML authentication filter creates a session for the user and redirects the now authenticated user to the requested target URL.

5.2.2 Single Sign-On and SAML 2.0

The SAML 2.0 Web Single Sign-On (SSO) profile supported by WebLogic Server implements the Authentication Request Protocol in conjunction with the HTTP Redirect, HTTP POST, and HTTP Artifact bindings. The following sections describe the flow of execution in both ways of that this profile can be initiated, showing the interaction among the SAML 2.0 services provided in WebLogic Server and the WebLogic Security Service:

- [Section 5.2.2.1, "Service Provider Initiated Single Sign-On"](#)
- [Section 5.2.2.2, "Identity Provider Initiated Single Sign-On"](#)

5.2.2.1 Service Provider Initiated Single Sign-On

In a typical Service Provider initiated SSO scenario, an unauthenticated user tries to access a protected resource on a Service Provider site. In response, the Service Provider initiates a Web SSO session by identifying the appropriate Identity Provider partner and sending or redirecting an authentication request to that partner. The Identity Provider then authenticates the user, typically via a login web application, generates a SAML assertion containing that user's identity information, and returns the assertion to the Service Provider in the form of an authentication response.

When the Service Provider receives the authentication response, the Service Provider extracts the identity information from the assertion contained in the response and verifies the user's identity by mapping it to a Subject in the local security realm. If the user's identity is successfully mapped, the Service Provider can consequently authorize the user's access to the protected resource.

[Figure 5–9](#) shows the flow of execution in an example of a Service Provider initiated Web single sign-on session.

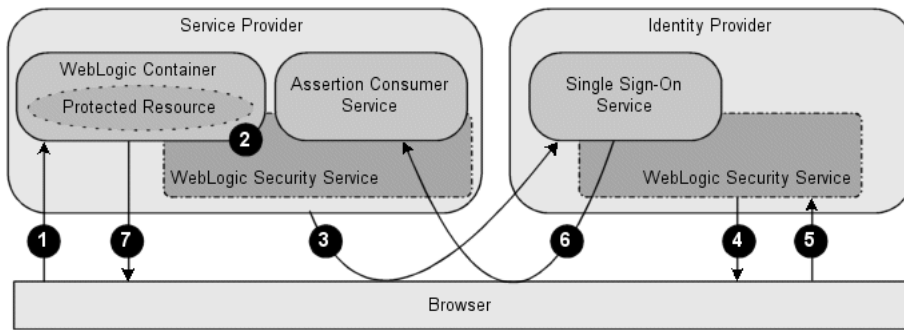
Figure 5–9 Service Provider Initiated Single Sign-On

Note the following callouts in [Figure 5–9](#) showing the flow of execution:

1. From a web browser, a user attempts to access a protected resource running in a WebLogic container that is hosted by a Service Provider.
2. The WebLogic container invokes the WebLogic Security Service to determine if the user is authenticated.
3. Because the user is not authenticated, the Service Provider generates an authentication request that contains information about the unauthenticated user and sends it to the Identity Provider, using the endpoint of the Identity Provider's Single Sign-On Service.

The Service Provider can be configured to use one of the following bindings for transmitting the authentication request:

- HTTP POST - When using the HTTP POST binding, the Service Provider sends an HTTP POST message containing the authentication request to the user's browser. The HTTP POST message is then sent to the Identity Provider's Single Sign-On Service.
 - HTTP Artifact - The Service Provider sends an HTTP redirect message that includes a SAML artifact to the user's browser. The SAML artifact contains a pointer to the authentication request message, which is maintained by the Service Provider's Artifact Resolution Service (ARS). When the Identity Provider receives the HTTP redirect message, it sends an artifact resolution request to the Service Provider's ARS to obtain the authentication request message.
 - HTTP Redirect - The Service Provider sends an HTTP redirect message to the user's browser, which sends an HTTP GET message to the Identity Provider's Single Sign-On Service.
4. The user is presented with a login web application hosted by an Identity Provider that is capable of authenticating that user. The Identity Provider challenges the user for his or her credentials.
 5. The user provides his or her username and password to the Identity Provider, which completes the authentication operation.
 6. The Single Sign-On Service hosted by the Identity Provider generates an assertion for the user and returns an authentication response to the Service Provider's Assertion Consumer Service (ACS).

The Identity Provider can be configured to use the following bindings:

- HTTP POST - The Identity Provider sends the authentication response, which contains the assertion, to the user's browser. The authentication response is transmitted to the Service Provider via an HTTP POST message.
- HTTP Artifact - The Identity Provider sends an authentication response, which contains a SAML artifact, to the user's browser. The SAML artifact contains a pointer to the assertion, which is handled by the Identity Provider's Artifact Resolution Service (ARS). The authentication response is transmitted to the Service Provider via an HTTP redirect message. When the Service Provider receives the response, it sends an artifact resolution request to the Identity Provider's ARS to obtain the assertion.

The ACS validates the assertion, extracts the identity information from that assertion, and maps that identity to a subject in the local security realm.

7. The ACS sends an HTTP redirect message to the browser, passing a cookie containing a session ID and enabling the browser to access the requested resource.

The WebLogic Security Service performs an authorization check to determine whether the browser may access the requested resource. If the authorization check succeeds, access to the resource is granted.

5.2.2.2 Identity Provider Initiated Single Sign-On

WebLogic Server also supports the scenario in which a web single sign-on session is initiated by an Identity Provider. In this scenario, a user is authenticated by an Identity Provider and issues a request on a resource that is hosted by a Service Provider. The Identity Provider initiates the SSO session by sending an unsolicited authentication response to the Service Provider.

When the Service Provider receives the authentication response, the Service Provider extracts the identity of the user from the assertion, maps that identity to a local subject, and performs an authorization check on the requested resource. If the authorization check succeeds, access is granted.

Figure 5–10 shows the flow of execution in a typical Identity Provider initiated SSO session.

Figure 5–10 Identity Provider Initiated Single Sign-On

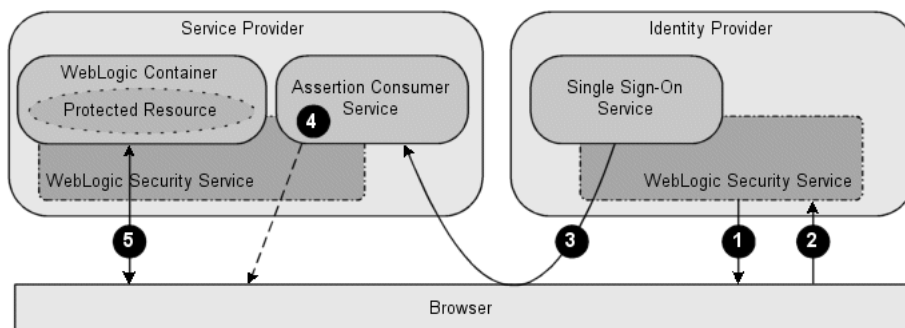

Note the following callouts in Figure 5–10 showing the flow of execution:

1. The user is presented with a login web application hosted by an Identity Provider that authenticates the user. The Identity Provider challenges the user for his or her credentials.
2. The user provides his or her username and password to the Identity Provider, which completes the authentication process.

The user issues a request on a resource that is hosted by a Service Provider.

3. The Single Sign-On Service hosted by the Identity Provider sends an unsolicited authentication response to the Service Provider to the Service Provider's Assertion Consumer Service (ACS).

Regardless of how the SSO session is initiated, the Identity Provider uses the same bindings as described in [Section 5.2.2.1, "Service Provider Initiated Single Sign-On"](#).

4. The ACS validates the assertion, extracts the identity information, and maps that identity to a subject in the local security realm. The ACS sends an HTTP redirect message to the browser, passing a cookie containing a session ID and enabling the browser to access the requested resource.
5. The WebLogic Security Service performs an authorization check to determine whether the browser may access the requested resource. If the authorization check succeeds, access to the resource is granted.

5.2.3 Desktop SSO Process

The process works as follows:

1. The Negotiate Identity Assertion provider is configured to support the `WWW-Authenticate` and `Authorization` HTTP headers. The Negotiate Identity Assertion provider uses a servlet authentication filter to generate the appropriate `WWW-Authenticate` header on unauthorized responses for the negotiate protocol and handles the `Authorization` headers on subsequent requests.
2. A user logs into the Windows 2000 or 2003 domain. The user acquires Kerberos credentials from the domain.
3. Using a browser that supports the SPNEGO protocol (for example, Internet Explorer or Mozilla), the user tries to access a Web Application running on an application server. The application server can be running on a UNIX or Windows 2000/2003 platform.
4. The browser sends a `GET` request to the application server.
5. The application server sends back an unauthorized response with the appropriate `WWW-Authenticate` headers.
6. The Servlet container gets the configured chain of servlet authentication filters from the WebLogic Security Framework.
7. The Servlet container calls the chain of servlet authentication filters. The Negotiate servlet authentication filter adds the `WWW-Authenticate` request header for the negotiate authentication scheme and calls into the WebLogic Security Framework to get the initial Negotiate challenge. The following message is sent back:

```
401 Unauthorized
WWW-Authenticate: Negotiate
```

8. The browser receives the `WWW-Authenticate` header and determines whether or not it can support the Negotiate authentication scheme. The browser then creates a SPNEGO token containing the supported GSS mechanism token types. It Base64 encodes the token and sends it back to the application server via an `Authorization` header on the original `GET` message as follows:

```
GET...
Authorization: Negotiate <Base64 encoded SPNEGO token>
```

9. Since the request is still unauthorized, the Servlet container calls the servlet authentication filters. The Negotiate servlet authentication filter handles the Authorization request header and calls the WebLogic Security Framework. The framework passes the token to the Negotiate Identity Assertion provider.
10. The Negotiate Identity Assertion provider uses the GSS context to get the name of the initiating Principal. This name is mapped to a username and passed back to the WebLogic Security Framework via a Callback handler.

The WebLogic Security Framework also determines to which groups the user belongs.
11. The authentication is complete and the GET request is processed.

5.3 SAML Token Profile Support in WebLogic Web Services

The WebLogic Web services and the WebLogic Security Framework have been enhanced to support the generation, consumption, and validation of SAML 1.1 and 2.0 assertions. When using SAML assertions, a web service passes a SAML assertion and the accompanying proof material to the WebLogic Security Framework. If the SAML assertion is valid and trusted, the framework returns an authenticated Subject with a trusted principal back to the web service. WebLogic Web services and the WebLogic Security Framework support the following SAML assertions:

- Sender-Vouches - The asserting party (different from the subject) vouches for the verification of the subject. The receiver must have a trust relationship with the asserting party.
- Holder-of-Key - The purpose of SAML token with "holder-of-key" subject confirmation is to allow the subject to use an X.509 certificate that may not be trusted by the receiver to protect the integrity of the request messages.

Conceptually, the asserting party inserts an X.509 public certificate (or other key info) into a SAML assertion. (More correctly, the asserting party binds a key to a subject.) In order to protect this embedded certificate, the SAML assertion itself must be signed by the asserting entity. For WebLogic Server, the Web service client signs the SAML assertion with its private key. That is, the signature on the assertion is the signature of the SAML authority, and is not based on the certificate contained in, or identified by, the assertion.

- Bearer - The subject of the assertion is the bearer of the assertion, subject to optional constraints on confirmation using attributes that may be included in the <SubjectConfirmationData> element of the assertion.

The following sections describe how the processing of these assertions work.

5.3.1 Sender-Vouches Assertions

All the Sender-Vouches assertions are basically the same, the difference is in how trust is established (meaning whether or not SSL is used for transport and whether or not the SAML assertion and the message bodies are signed).

The Sender-Vouches assertions are used in the following manner:

1. A user invokes a WebLogic Web service.
2. The Web service requests a SAML assertion from the user.
3. The user generates a SAML assertion and returns it to the Web service.

4. The Web service calls the SAML Credential Mapping provider, which generates an appropriate SAML assertion.
5. One of the following occurs. Note that this list represents the most likely scenarios and that other scenarios are possible.
 - The Web service sends an unsigned assertion and uses a non-SSL transport in a SOAP message to the destination. With this type of assertion, there is no proof material in the SOAP message so the assertion cannot be trusted nor can it be assumed that the assertion came from a trusted party.
 - The Web service uses the SSL protocol to send an unsigned assertion in a SOAP message to the destination. With this type of assertion, the client certificate is used to establish trust.
 - The Web service signs the assertion and sends it using a non-SSL transport in a SOAP message to the destination. With this type of assertion, the signature provides the proof material for trust but it can't be assumed that the connection was not compromised. However, modification of a signed assertion can be detected because any change will break the signature
 - The Web service signs the assertion and uses the SSL protocol to send the signed assertion in a SOAP message to the destination. With this type of assertion, trust is established either through the signature or the client certificate.
6. The SAML Identity Assertion provider consumes and validates the assertion and determines if the assertion is to be trusted.
7. If the assertion is to be trusted, the SAML Identity Assertion provider creates a Subject containing user principals and possibly group principals and returns the Subject with principals to the Web service.
8. The Web service returns the response to the user.

5.3.2 Holder-of-Key Assertion

In the Holder-of-Key assertion, the Web service client depends on the Web service server to ensure that the user is to be trusted.

The Holder-of-Key assertions are used in the following manner:

1. A user authenticates to a Web service client through some undetermined mechanism. The Web service client can be local or remote and may or may not be a WebLogic server instance.
2. The Web service client trusts the user, generates a SAML assertion containing the certificate of the user, and signs the SAML assertion with its private key. The Web service client returns the SAML assertion to the user.
3. The user inserts the SAML assertion information into a `wsse:Security` header in a SOAP message. The message body is signed with the private key of the user.
4. The user invokes a WebLogic Web service.
5. The Web service sends the SOAP message to the Web service server (in this case, a WebLogic Server instance). The Web service server makes a trust decision based on whether or not it trusts the SAML assertion and the SOAP message.
6. The Web services server receives the assertion and passes it to the SAML Identity Asserter. The SAML Identity Asserter verifies the assertion signature and verifies trust in the certificate used for that signature.

If this succeeds, the Web service server can assume that the key in the holder-of-key assertion does in fact belong to the Subject of the assertion. Web services can then use that key to verify the signature that signs the SOAP message, which establishes that the SOAP message was generated/sent by the holder of the key. It is up to the Web service server to verify trust in the X.509 certificate itself.

The Web service server returns a Subject with principals for the SAML assertion to the Web service client.

7. The Web service client returns the response to the user.

Optionally, the SSL protocol can be used with this assertion. If the SSL protocol is used, the client certificate can also be used as proof material.

5.4 The Security Service Provider Interfaces (SSPIs)

Security in this release of WebLogic Server is based on a set of Security Service Provider Interfaces (SSPIs). The SSPIs can be used by developers and third-party vendors to develop security providers for the WebLogic Server environment. SSPIs are available for Adjudication, Auditing, Authentication, Authorization, Credential Mapping, Identity Assertion, Role Mapping, and Certificate Lookup and Validation.

Note: The SSPI for Keystore providers is deprecated in this release of WebLogic Server. Use Java KeyStores (JKS) instead.

The SSPIs allow customers to use custom security providers for securing WebLogic Server resources. Customers can use the SSPIs to develop custom security providers or they can purchase customer security providers from third-party vendors.

To assist customers in developing custom security providers, sample custom security providers are also available at

<https://codesamples.samplecode.oracle.com/servlets/tracking?id=S224> on the Oracle Technology Network (OTN).

For more information on developing custom security providers, see *Developing Security Providers for Oracle WebLogic Server*.

5.5 Weblogic Security Providers

This section provides descriptions of the security providers that are included in the WebLogic Server product for your use. **Security providers** are modules that "plug into" a WebLogic Server security realm to provide security services to applications. They call into the WebLogic Security Framework on behalf of applications.

If the security providers supplied with the WebLogic Server product do not fully meet your security requirements, you can supplement or replace them with custom security providers. You develop a custom security provider by:

- Implementing the appropriate security service provider interfaces (SSPIs) from the `weblogic.security.spi` package to create runtime classes for the security provider.
- Creating an MBean Definition File (MDF) and using the WebLogic MBeanMaker utility to generate an MBean type, which is used to configure and manage the security provider.

For more information, see *Developing Security Providers for Oracle WebLogic Server*.

Figure 5–11 shows the security providers that are required and those that are optional in a WebLogic security realm.

Figure 5–11 WebLogic Security Providers

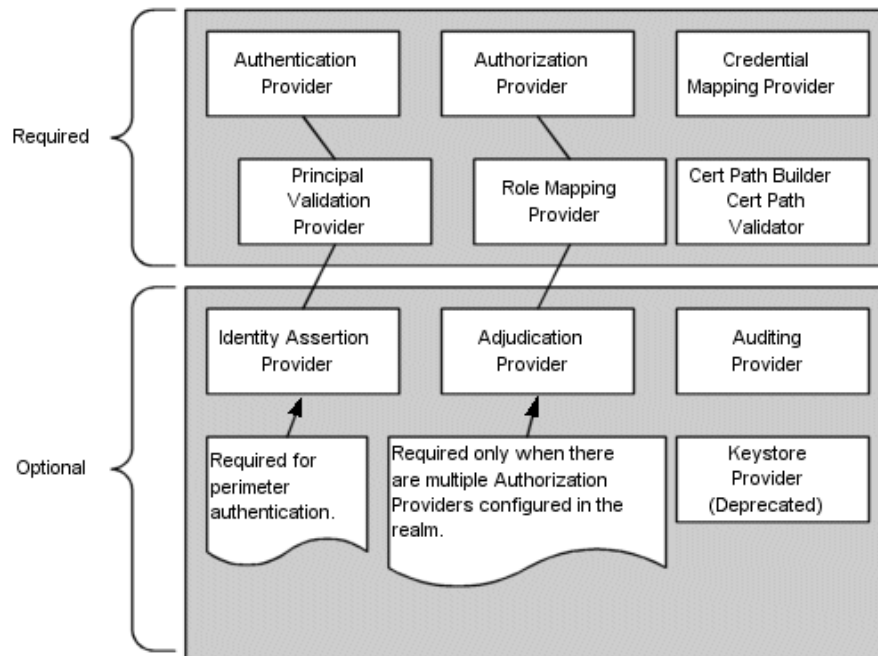

The security providers are described in the following sections:

- Section 5.5.1, "WebLogic Authentication Provider"
- Section 5.5.2, "Alternative Authentication Providers"
- Section 5.5.3, "Password Validation Provider"
- Section 5.5.4, "WebLogic Identity Assertion Provider"
- Section 5.5.5, "SAML Identity Assertion Provider for SAML 1.1"
- Section 5.5.7, "Negotiate Identity Assertion Provider"
- Section 5.5.8, "WebLogic Principal Validation Provider"
- Section 5.5.9, "WebLogic Authorization Provider"
- Section 5.5.10, "WebLogic Adjudication Provider"
- Section 5.5.11, "WebLogic Role Mapping Provider"
- Section 5.5.12, "WebLogic Auditing Provider"
- Section 5.5.13, "WebLogic Credential Mapping Provider"
- Section 5.5.14, "SAML Credential Mapping Provider for SAML 1.1"
- Section 5.5.17, "WebLogic CertPath Provider"
- Section 5.5.19, "Versionable Application Provider"
- Section 5.5.20, "WebLogic Keystore Provider"
- Section 5.5.21, "WebLogic Realm Adapter Providers"

5.5.1 WebLogic Authentication Provider

The default (active) security realm for WebLogic Server includes a WebLogic Authentication provider. The WebLogic Authentication provider supports delegated username/password and WebLogic Server security digest authentication. It utilizes an embedded LDAP server to store user and group information. This provider allows you to edit, list, and manage users and group membership.

This provider also provides a set of attributes, such as employee number and department number, that you can assign to users.

Note: In conjunction with the WebLogic Authorization provider, the WebLogic Authentication provider replaces the functionality of the File realm that was available in 6.x releases of WebLogic Server.

5.5.2 Alternative Authentication Providers

WebLogic Server provides the following additional Authentication providers which can be used instead of or in conjunction with the WebLogic Authentication provider in the default security realm:

- A set of LDAP Authentication providers that access external LDAP stores (Open LDAP, Netscape iPlanet, Microsoft Active Directory, Oracle Internet Directory, Oracle Virtual Directory, and Novell NDS).
- A set of Database Base Management System (DBMS) authentication providers that access user, password, group, and group membership information stored in databases for authentication purposes. Optionally, WebLogic Server can be used to manage the user, password, group, and group membership information. The DBMS Authentication provider are the upgrade path from the RDBMS security realm.

The following DBMS Authentication providers are available:

- SQL Authentication provider - A manageable authentication provider that supports the listing and editing of user, password, group, and group membership information.
- Read-only SQL Authentication provider - An authentication provider that supports authentication of users in a database and the listing of the contents of the database through the WebLogic Server Administration Console. The authentication provider requires a specific set of SQL statements so it might not meet all customer needs.
- Custom DBMS Authentication provider - A run-time authentication provider that only supports authentication. This provider require customer-written code that handles querying the database to obtain authentication information. This authentication provider is a flexible alternative that allows customer to adapt a DBMS Authentication provider to meet their special database needs.
- A Windows NT Authentication provider that uses Windows NT users and groups for authentication purposes. The Windows NT Authentication provider is the upgrade path for the Window NT security realm. The Windows NT users and groups are displayed through the WebLogic Server Administration Console however, they cannot be managed through the console.
- An LDAP X509 Identity Assertion provider that looks up the LDAP object for the user associated with an X509 certificate, ensures that the certificate in the LDAP

object matches the presented certificate, and then retrieves the name of the user from the LDAP object for the purpose of authentication.

Note: By default, these additional Authentication providers are available but not configured in the WebLogic default security realm.

5.5.3 Password Validation Provider

WebLogic Server includes a Password Validation provider, which manages and enforces a set of password composition rules when configured with one or more of the following authentication providers:

- WebLogic Authentication provider
- SQL Authenticator provider
- LDAP Authentication provider
- Active Directory Authentication provider
- iPlanet Authentication provider
- Novell Authentication provider
- Open LDAP Authentication provider

When the Password Validation provider is configured with an authentication provider, the authentication provider invokes the Password Validation provider whenever a password is created or updated. The Password Validation provider then performs a check to determine whether the password meets the criteria established by a set of configurable composition rules.

5.5.4 WebLogic Identity Assertion Provider

The WebLogic Identity Assertion provider supports certificate authentication using X.509 certificates and CORBA Common Secure Interoperability version 2 (CSIv2) identity assertion. The WebLogic Identity Assertion provider validates the token type, then maps X.509 digital certificates and X.501 distinguished names to WebLogic users. It also specifies a list of trusted client principals to use for CSIv2 identity assertion. The wildcard character (*) can be used to specify that all principals are trusted. If a client is not listed as a trusted client principal, the CSIv2 identity assertion fails and the invoke is rejected.

The WebLogic Identity Assertion provider supports the following token types:

- `AU_TYPE` - for a WebLogic AuthenticatedUser used as a token.
- `X509_TYPE` - for an X.509 client certificate used as a token.
- `CSI_PRINCIPAL_TYPE` - for a CSIv2 principal name identity used as a token.
- `CSI_ANONYMOUS_TYPE` - for a CSIv2 anonymous identity used as a token.
- `CSI_X509_CERTCHAIN_TYPE` - for a CSIv2 X.509 certificate chain identity used as a token.
- `CSI_DISTINGUISHED_NAME_TYPE` - for a CSIv2 distinguished name identity used as a token.
- `WSSE_PASSWORD_DIGEST` - for a `wsse:UsernameToken` with a password type of `wsse:PasswordDigest` used as a token.

5.5.5 SAML Identity Assertion Provider for SAML 1.1

The SAML Identity Assertion provider V2 validates SAML 1.1 assertions and verifies the issuer is trusted. If so, identity is asserted based on the authentication statement contained in the assertion.

Provider configuration includes settings that configure and enable SAML source site and destination site SSO services (such as ITS, ACS, and ARS) to run in the server.

The SAML Identity Assertion provider supports the following SAML Subject confirmation methods:

- artifact
- bearer
- sender-vouches
- holder-of-key

5.5.6 SAML 2.0 Identity Assertion Provider

Similar to the SAML Identity Assertion provider V2 for SAML 1.1, the SAML 2.0 Identity Assertion provider validates SAML 2.0 assertions and verifies that the issuer is trusted. If so, identity is asserted based on the authentication statement contained in the assertion.

Provider configuration includes settings that configure and enable SAML 2.0 Service Provider services, such as the Assertion Consumer Service and Artifact Resolution Service, to run in the server.

The SAML 2.0 Identity Assertion provider supports the following SAML Subject confirmation methods:

- bearer
- sender-vouches
- holder-of-key

5.5.7 Negotiate Identity Assertion Provider

The Negotiate Identity Assertion provider is used for SSO with Microsoft clients that support the SPNEGO protocol. Specifically, it decodes SPNEGO tokens to obtain Kerberos tokens, validates the Kerberos tokens, and maps Kerberos tokens to WebLogic users. The Negotiate Identity Assertion provider utilizes the Java Generic Security Service (GSS) Application Programming Interface (API) to accept the GSS security context via Kerberos. For more information about the Java GSS API, see <http://java.sun.com/javase/6/docs/technotes/guides/security/jgss/jgss-features.html>.

The Negotiate Identity Assertion provider interacts with the WebLogic Servlet container which handles `WWW-Authenticate` and `WWW-Authorization` headers, adding the appropriate Negotiate header.

By default, the Negotiate Identity Assertion provider is available but not configured in the WebLogic default security realm. The Negotiate Identity Assertion provider can be used instead of or in addition to the WebLogic Identity Assertion provider.

5.5.8 WebLogic Principal Validation Provider

The default (active) security realm for WebLogic Server includes a WebLogic Principal Validation provider. This provider signs and verifies WebLogic Server principals. In other words, it signs and verifies principals that represent WebLogic Server users or WebLogic Server groups.

Note: You can use the `WLSPrincipals` class (located in the `weblogic.security` package) to determine whether a principal (user or group) has special meaning to WebLogic Server (that is, whether it is a predefined WebLogic Server user or WebLogic Server group). Furthermore, any principal that is going to represent a WebLogic Server user or group needs to implement the `WLSUser` and `WLSGroup` interfaces (available in the `weblogic.security.spi` package).

The WebLogic Principal Validation provider includes implementations of the `WLSUser` and `WLSGroup` interfaces, named `WLSUserImpl` and `WLSGroupImpl`. These are located in the `weblogic.security.principal` package. It also includes an implementation of the `PrincipalValidator` SSPI called `PrincipalValidatorImpl`. For more information about the `PrincipalValidator` SSPI, see "Implement the `PrincipalValidator` SSPI" in *Developing Security Providers for Oracle WebLogic Server*.

Much as an Identity Assertion provider supports a specific type of token, a Principal Validation provider signs and verifies the authenticity of a specific type of principal. Therefore, you can use the WebLogic Principal Validation provider to sign and verify principals that represent WebLogic Server users or WebLogic Server groups.

5.5.9 WebLogic Authorization Provider

As of version 9.1, WebLogic Server includes an Authorization provider that supports the eXtensible Access Control Markup Language (XACML) 2.0 standard from OASIS. WebLogic This provider can import, export, persist and execute policy expressed using all standard XACML 2.0 functions, attributes, and schema elements.

New domains created using WebLogic Server 9.1 and later will default to using the XACML Authorization provider. Existing domains, upgraded WebLogic Server 9.1 and later, will continue to use the Authorization provider currently specified, such as third-party partner providers or the original WebLogic Server proprietary providers. If you use the WebLogic Server Administration Console to add a new Authorization provider, you can add the new provider as a `DefaultAuthorizer` or as a XACML provider.

Custom XACML providers are not supported in this release.

Version 9.1 of WebLogic Server also included the "default" WebLogic Authorization provider. This provider supplied the default enforcement of authorization for versions of WebLogic Server prior to 9.1. Using a policy-based authorization engine, the WebLogic Authorization provider returns an access decision to determine if a particular user is allowed access to a protected WebLogic resource. The WebLogic Authorization provider also supports the deployment and undeployment of security policies within the system.

5.5.10 WebLogic Adjudication Provider

The default (active) security realm for WebLogic Server includes a WebLogic Adjudication provider. This provider would normally be responsible for tallying the potentially differing results rendered by multiple Authorization providers' Access Decisions and rendering a final verdict on whether or not access will be granted to a WebLogic resource. However, because the default security realm only has one Authorization provider, only one Access Decision is produced so the WebLogic Adjudication provider is not used.

Note: The WebLogic Adjudication provider is used in the Compatibility realm, which has two Authorization providers.

The WebLogic Adjudication provider has an attribute called Require Unanimous Permit that governs its behavior. By default, the Require Unanimous Permit attribute is set to TRUE, which causes the WebLogic Adjudication provider to act as follows:

- If all the Authorization providers' Access Decisions return PERMIT, then return a final verdict of TRUE (that is, permit access to the WebLogic resource).
- If some Authorization providers' Access Decisions return PERMIT and others return ABSTAIN, then return a final verdict of FALSE (that is, deny access to the WebLogic resource).
- If any of the Authorization providers' Access Decisions return ABSTAIN or DENY, then return a final verdict of FALSE (that is, deny access to the WebLogic resource).

If you change the Require Unanimous Permit attribute to FALSE, the WebLogic Adjudication provider acts as follows:

- If all the Authorization providers' Access Decisions return PERMIT, then return a final verdict of TRUE (that is, permit access to the WebLogic resource).
- If some Authorization providers' Access Decisions return PERMIT and others return ABSTAIN, then return a final verdict of TRUE (that is, permit access to the WebLogic resource).
- If any of the Authorization providers' Access Decisions return DENY, then return a final verdict of FALSE (that is, deny access to the WebLogic resource).

Note: You set the Require Unanimous Permit attributes when you configure the WebLogic Adjudication provider. For more information about configuring an Adjudication provider, see "Configuring the WebLogic Adjudication Provider" in *Securing Oracle WebLogic Server*

5.5.11 WebLogic Role Mapping Provider

As of version 9.1, WebLogic Server includes a Role Mapping provider that supports the eXtensible Access Control Markup Language (XACML) 2.0 standard from OASIS. WebLogic This provider can import, export, persist and execute policy expressed using all standard XACML 2.0 functions, attributes, and schema elements.

New domains created using WebLogic Server 9.1 and later will default to using the XACML Role Mapping provider. Existing domains, upgraded to WebLogic Server 9.1 and later, will continue to use the Role Mapping provider currently specified, such as third-party partner providers or the original WebLogic Server proprietary providers. If you use the WebLogic Server Administration Console to add a new Role Mapping

provider, you can add the new provider as a DefaultRoleMapper or as a XACML provider.

Custom XACML providers are not supported in this release.

Version 9.1 of WebLogic Server also included the "default" WebLogic Role Mapping provider. This provider supplied the default enforcement of role mapping for versions of WebLogic Server prior to WebLogic Server 9.1. This provider determines dynamic roles for a specific user (subject) with respect to a specific protected WebLogic resource for each of the default users and WebLogic resources. The WebLogic Role Mapping provider supports the deployment and undeployment of roles within the system. The WebLogic Role Mapping provider uses the same security policy engine as the WebLogic Authorization provider.

5.5.12 WebLogic Auditing Provider

The default (active) security realm for WebLogic Server includes a WebLogic Auditing provider. This provider records information from a number of security requests, which are determined internally by the WebLogic Security Framework. The WebLogic Auditing provider also records the event data associated with these security requests, and the outcome of the requests.

5.5.13 WebLogic Credential Mapping Provider

The default (active) security realm for WebLogic Server includes a WebLogic Credential Mapping provider. You use the WebLogic Credential Mapping provider to associate, or map, a WebLogic Server user to the appropriate credentials to be used with a Resource Adapter to access an Enterprise Information System (EIS), for example, some relational database like Oracle, SQL Server, and so on. The provider maps a user's authentication credentials (username and password) to those required for legacy applications, so that the legacy application gets the necessary credential information. For example, the EIS may be a mainframe transaction processing, database systems, or legacy applications not written in the Java programming language.

If you only want to map WebLogic Server users and groups to username/password credentials in another system, then the WebLogic Credential Mapping provider is sufficient.

5.5.14 SAML Credential Mapping Provider for SAML 1.1

The SAML Credential Mapping provider V2 generates SAML 1.1 assertions for authenticated subjects based on relying party/destination site configuration. Assertions contain an authentication statement and, optionally, an attribute statement containing WebLogic Server group information. If the requested target has not been configured and no defaults are set, an assertion will not be generated. User information and group membership (if configured as such) are put in the AttributeStatement.

The Administration Console Federation Services configuration pages include settings that configure and enable SAML source site and destination site SSO services (such as ITS, ACS, and ARS) to run in the server.

The provider supports the following SAML Subject confirmation methods:

- artifact
- bearer

- sender-vouches
- holder-of-key

5.5.15 SAML 2.0 Credential Mapping Provider

The SAML 2.0 Credential Mapping provider generates SAML 2.0 assertions for authenticated subjects based on the configuration of Identity Provider services and the set of Service Provider partners. Assertions contain an authentication statement and, optionally, an attribute statement containing WebLogic Server group information. If the requested target has not been configured and no defaults are set, an assertion will not be generated. User information and group membership (if configured as such) are put in the AttributeStatement.

The Administration Console Federation Services configuration pages for SAML 2.0 include settings that configure and enable SAML 2.0 source site and destination site services (such as Single Sign-On, and Artifact Resolution Service) to run in the server.

The provider supports the following SAML Subject confirmation methods:

- bearer
- sender-vouches
- holder-of-key

5.5.16 PKI Credential Mapping Provider

The PKI (Public Key Infrastructure) Credential Mapping provider maps a WebLogic Server subject (the initiator) and target resource (and an optional credential action) to a public/private key pair or public certificate that should be used by the application when using the targeted resource. This provider can also map an alias to a public/private key pair or public certificate. The PKI Credential Mapping provider uses the subject and resource name, or the alias, to retrieve the corresponding credential from the keystore.

5.5.17 WebLogic CertPath Provider

The WebLogic CertPath provider is both a CertPath Builder and a CertPath Validator. The provider completes certificate paths and validates the certificates using the trusted CA configured for a particular server instance. If a certificate chain cannot be completed, it is invalid.

The WebLogic CertPath provider also checks the signatures in the chain, ensures that the chain has not expired, and checks that one of the certificates in the chain is issued by one of the trusted CAs configured for the server. If any of these checks fail, the chain is not valid.

Finally, the provider checks that each certificate's basic constraints (that is, the ability of the certificate to issue other certificates) to ensure the certificate is in the proper place in the chain.

The WebLogic CertPath provider can be used as CertPath Builder or a CertPath Validator in a security realm.

5.5.18 Certificate Registry

The Certificate Registry allows the system administrator to explicitly configure a list of trusted CA certificates that are allowed access to the server. The Certificate Registry provides an inexpensive mechanism for performing revocation checking. An

administrator revokes a certificate by removing it from the certificate registry. The registry is stored in the embedded LDAP server.

Certificate Registries are configured on a per domain basis rather than a per server basis.

The Certificate Registry is both a CertPath Builder and a CertPath Validator. In either case, the Certificate Registry ensures that the chain's end certificate is stored in the registry.

5.5.19 Versionable Application Provider

A versionable application is an application that has an application archive version specified in the manifest of the application archive (EAR file). Versionable applications can be deployed side-by-side and active simultaneously. Versionable applications allow multiple versions of an application, where security constraints can vary between the application versions.

The Versionable Application provider SSPI enables all security providers that support application versioning to be notified when versions are created and deleted. It also enables all security providers that support application versioning to be notified when non-versioned applications are removed.

5.5.20 WebLogic Keystore Provider

The WebLogic Keystore provider uses the reference keystore implementation supplied by Sun Microsystems in the Java Software Development Kit (SDK). It utilizes the standard Java KeyStore (JKS) keystore type, which implements the keystore as a file (one per machine). It protects each private key with its individual password. There are two keystore files associated with the WebLogic Keystore provider:

- One keystore file holds the trusted certificate authority (CA) certificates. WebLogic Server also ships a trusted certificate authority Keystore file that it uses by default to locate the trusted CA certificates, which are then used in SSL to verify client certificates.
- The other keystore file holds the server's private keys. WebLogic Server retrieves a private key from this file to initialize SSL. You can use the Sun Microsystems SDK `keytool` utility or the WebLogic Server `ImportPrivateKey` utility to add private keys to this file. Note that WebLogic Server can retrieve private keys and certificates from this keystore file.

Note: The WebLogic Keystore provider is deprecated in this release of WebLogic Server but is still supported. The development of custom Keystore providers is not supported. Use Java KeyStores (JKS) instead. All of the functionality that was supported by the WebLogic Keystore provider is available through use of Java KeyStores. The WebLogic Keystore provider is only supported for backward compatibility. Oracle recommends using the WebLogic Keystore provider only when it is needed to support backward compatibility with a WebLogic Server 7.0 configuration.

5.5.21 WebLogic Realm Adapter Providers

The WebLogic Realm Adapter providers provide backward-compatibility with 6.x WebLogic security realms by allowing the use of existing, 6.x security realms with the security features in this release of WebLogic Server. The WebLogic Realm Adapter

providers map the realm API (`weblogic.security.acl`) used in WebLogic Server 6.x to the APIs used in this release of WebLogic Server. The following WebLogic Realm Adapter providers are provided:

- Authentication (includes an Identity Assertion provider)

The Realm Adapter Authentication provider allows you to use version 6.x security realms and their data stores with the WebLogic security providers in WebLogic Server. The Realm Adapter Authentication provider also allows you to use implementations of the `weblogic.security.acl.CertAuthenticator` class with WebLogic Server. The Realm Adapter Authentication provider includes a component that provides identity assertion based on X.509 tokens.

- Authorization

In Compatibility security, two types of Authorization providers are used: the WebLogic Authorization provider and the Realm Adapter Authorization provider. The WebLogic Authorization provider is used for new security policies. The Realm Adapter Authorization provider is used for mapping to WebLogic Server 6.1 access control lists (ACLs).

- Auditing

The Realm Adapter Auditing provider allows you to use implementations of the `weblogic.security.audit` interface with WebLogic Server deployments using Compatibility security.

- Adjudication

The Realm Adapter Adjudication provider enables both the WebLogic Authorization provider and the Realm Adapter Authorization provider to be used together for a security realm in Compatibility security.

Although these security providers are configured using the WebLogic Server Administration Console, your existing 6.x security realms will continue to use the same MBeans and user interface present in WebLogic Server 6.1.

Note: The WebLogic Realm Adapter providers are deprecated and should only be used while upgrading to the security model available in this release of WebLogic Server.

Glossary

access control list (ACL)

In WebLogic 6.x, a data structure used to control access to computer resources. Each entry on the access control list (ACL) contains a set of permissions associated with a particular principal that represents an individual user or a group of users. Entries can be positive or negative. An entry is positive if it grants permission and negative if it denies permission. In WebLogic Server 7.0 and later, ACLs are deprecated and are replaced by security policies. To continue to protect WebLogic resources with ACLs, use Compatibility security. See also [Compatibility security](#), [group](#), [principal](#), [security policy](#), [user](#), [WebLogic resource](#).

Access Decision

Code that determines whether a subject has permission to perform a given operation on a WebLogic resource. The result of an Access Decision is to permit, deny, or abstain from making a decision. An Access Decision is a component of an Authorization provider. See also [Authorization provider](#), [subject](#), [WebLogic resource](#).

ACL

See [access control list \(ACL\)](#).

Adjudication provider and Adjudicator

A WebLogic security provider that tallies the results that multiple Access Decisions return, resolves conflicts between the Access Decisions, and determines the final PERMIT or DENY decision. The Adjudicator is a component of the Adjudication provider. See also [Access Decision](#), [security provider](#).

Artifact Resolution Service (ARS)

An addressable SAML service that stores the content for a SAML artifact and responds to artifact resolution requests sent by either an Identity Provider or Service Provider partner.

asserting party

When using web SSO, asserts that a user has been authenticated and given associated attributes. For example, there is a user Dan Murphy, he has an email address of dmurphy@company.com and he authenticated to this domain using a password mechanism. In web SSO, asserting parties are also known as SAML authorities. See also [relying party](#), [Security Assertion Markup Language \(SAML\)](#), [single sign-on](#).

assertion

An XML statement about whether or not a user has been logged in to a domain. Assertions can be thought of as XML representations of a Subject containing a username and groups.

Assertion consumer service (ACS)

An addressable component that receives assertions and/or artifacts generated by a SAML partner and uses them to authenticate users at the Service Provider, or destination, site.

Assertion receiver service (ARS)

An addressable component in the SAML 1.1 architecture that converts artifacts into SAML 1.1 assertions.

asymmetric key cryptography

A key-based cryptography that uses an encryption algorithm in which different keys, private and public, are used to encrypt and decrypt the data. Data that is encrypted with the public key can be decrypted only with the private key. This asymmetry is the property that makes public key cryptography so useful. Asymmetric key cryptography is also called public key cryptography. See also [private key](#), [public key](#), [symmetric key cryptography](#).

auditing

Process whereby information about operating requests and the outcome of those requests is collected, stored, and distributed for the purposes of non-repudiation. Auditing provides an electronic trail of computer activity. See also [Auditing provider](#).

Auditing provider

A security provider that provides auditing services. See also [auditing](#), [security provider](#).

authentication

Process whereby the identity of users or system processes are proved or verified. Authentication also involves remembering, transporting, and making identity information available to various components of a system when that information is needed. Authentication typically involves username/password combinations, but can also be done using tokens. See also [Authentication provider](#), [Identity Assertion](#), [LoginModule](#), [perimeter authentication](#), [token](#), [user](#).

Authentication provider

A security provider that enables WebLogic Server to establish trust by validating a user. The WebLogic Security Service architecture supports Authentication providers that perform username/password authentication; certificate-based authentication directly with WebLogic Server; and HTTP certificate-based authentication proxied through an external Web server. See also [authentication](#), [digital certificate](#), [security provider](#), [user](#).

authorization

Process whereby a user's access to a WebLogic resource is permitted or denied based on the user's security role and the security policy assigned to the requested WebLogic resource. See also [Authorization provider](#), [security policy](#), [user](#), [WebLogic resource](#).

Authorization provider

A security provider that controls access to WebLogic resources based on the user's security role and the security policy assigned to the requested WebLogic resource. See also [security provider](#), [user](#), [WebLogic resource](#).

Caching realm

A WebLogic Server 6.x feature that applies to WebLogic Server 7.0 and later only if you use Compatibility security. A Caching realm is a temporary location in memory that contains frequently called ACLs, users, groups, and so on, from the primary realm. In WebLogic Server 6.x, users, groups, and ACL objects are stored in the `filerealm.properties` file, and reading from a file can be very slow. The Caching realm is a communication layer on top of the primary realm and is used for lookups, by default. If the Caching realm lookup fails, a lookup is performed on the primary realm. See also [access control list \(ACL\)](#), [Compatibility security](#), [group](#), [user](#).

certificate

See [digital certificate](#).

certificate authentication

Method of providing a confident identification of a client by a server through the use of digital certificates. Certificate authentication is generally preferred over password authentication because it is based on what the user has (a private key), as well as what the user knows (a password that protects the private key).

certificate authority

A trusted entity that issues public key certificates. A certificate authority attests to a user's real-world identity, much as a notary public does. See also [certificate chain](#), [digital certificate](#), [entity](#), [private key](#), [public key](#), [trusted \(root\) certificate authority](#).

certificate chain

An array that contains a private key, the matching public key, and a chain of digital certificates for trusted certificate authorities, each of which is the issuer of the previous digital certificate. The certificate for the server, authority, authority2, and authority3, constitute a chain, where the server certificate is signed by the authority, the authority's certificate is signed by authority2, and authority2's certificate is signed by authority3. If the certificate authority for any of these authorities is recognized by the client, the client authenticates the server. See also [trusted \(root\) certificate authority](#).

Certificate Lookup and Validation (CLV) framework

A WebLogic Server framework which completes certificate paths and validates X509 certificate chains. The CLV framework receives a certificate or certificate chain, completes the chain (if necessary), and validates the certificates in the chain.

Certificate Reference

An string that uniquely identifies the certificate chain. For example, a subject DN or an issuer DN plus a serial number.

Certificate Registry

A list of trusted CA certificates that are allowed to access the servers in a domain. The Certificate Registry provides a mechanism for revocation checking. Only certificates in the Certificate Registry are valid.

Certificate Revocation List (CRL)

A list of certificates that a trusted CA has revoked.

CertPath

A JDK class that stores a certificate chain in-memory. Also used to refer to the JDK architecture and framework used to locate and validate certificate chains.

CertPath Builder

A provider in the Certificate Lookup and Validation (CLV) framework that completes the certificate path (if necessary) and validates the certificates.

CertPath Validator

A provider in the CLV framework that validates the certificates in a certificate chain.

Compatibility realm

Security realm that is the default (active) security realm if you are using Compatibility security. The Compatibility realm adapts your existing WebLogic Server 6.x Authentication and Authorization providers so that you can use them in WebLogic Server 7.x or later. The only security realm available in Compatibility security is the Compatibility realm. See also [Compatibility security](#), [default realm](#), [security provider](#), [security realm](#), [WebLogic security provider](#).

Compatibility security

The capability to run security configurations from WebLogic Server 6.x in later releases of WebLogic Server. Using Compatibility security in WebLogic Server 7.x or later, you configure 6.x security realms; define users, groups, and ACLs; manage protection of user accounts; and install custom auditing providers. The only security realm available in Compatibility security is the Compatibility realm. The Realm Adapter providers in the Compatibility realm allow backward compatibility to the authentication and authorization services in 6.x security realms. See also [access control list \(ACL\)](#), [Auditing provider](#), [Compatibility realm](#), [group](#), [Realm Adapter Authentication provider](#), [Realm Adapter Authorization provider](#), [security realm](#), [user](#).

connection filter

A programmable filter that WebLogic Server uses to determine whether the server should allow incoming connections from a network client. In addition to security policies that protect WebLogic resources based on user characteristics, you can add another layer of security by filtering based on network connections. See also [security policy](#), [user](#), [WebLogic resource](#).

connector

See [resource adapter](#)

context handler

A ContextHandler is a high-performing WebLogic class that obtains additional context and container-specific information from the resource container, and provides that information to security providers making access or role mapping decisions. The ContextHandler interface provides a way for an internal WebLogic resource container to pass additional information to a WebLogic Security Framework call, so that a security provider can obtain contextual information beyond what is provided by the arguments to a particular method. A ContextHandler is essentially a name/value list, and as such, it requires that a security provider know what names to look for. (In other words, use of a ContextHandler requires close cooperation between the

WebLogic resource container and the security provider.) See also [security provider](#), [WebLogic container](#), [WebLogic Security Framework](#).

credential

Security-related attribute of a subject, which may contain information used to authenticate the subject to new services. Types of credentials include username/password combinations, Kerberos tickets, and public key certificates. See also [credential mapping](#), [Credential Mapping provider](#), [digital certificate](#), [Kerberos ticket](#), [public key](#), [subject](#).

credential mapping

The process whereby a legacy system's database is used to obtain an appropriate set of credentials to authenticate users to a target resource. WebLogic Server uses credential mapping to map credentials used by WebLogic Server users to credentials used in a legacy (or any remote) system. WebLogic Server then uses the credential maps to log in to a remote system on behalf of a subject that has already been authenticated. See also [credential](#), [Credential Mapping provider](#), [resource](#).

Credential Mapping provider

A security provider that is used to provide credential mapping services and bring new types of credentials into the WebLogic Server environment. See also [credential](#), [credential mapping](#), [security provider](#).

Cross-Domain Single Sign-on

WebLogic Server security feature that allows users to authenticate once but access multiple applications, even if these applications reside in different DNS domains. You can use this feature to construct a network of affiliates or partners that participate in a Single Sign-On domain. See also [single sign-on](#).

CSiv2 protocol

A protocol that is based on IIOP (GIOP 1.2) and the CORBA Common Secure Interoperability version 2 (CSiv2) CORBA specification. The secure interoperability requirements for EJB2.0 and other J2EE1.4.1 containers correspond to Conformance Level 0 of the CSiv2 specification. The CORBA Security Attribute Service (SAS) is the protocol that is used in CSiv2. For more information, see http://www.omg.org/technology/documents/formal/omg_security.htm.

custom security provider

Security provider written by third-party security vendors or security developers that can be integrated into the WebLogic Security Service. Custom security providers are implementations of the Security Service Provider Interfaces (SSPIs) and are *not* supplied with the WebLogic Server product.

Custom security realm

In WebLogic Server 7.0 and later, supported only in Compatibility security. In WebLogic Server 6.x, you customize authentication by creating your own security realm and integrating it into the WebLogic Server environment. See also [Compatibility security](#).

database delegator

Intermediary class that mediates initialization calls between a security provider and the security provider's database. See also [security provider database](#).

Database Management System (DBMS) Authentication provider

A security provider that accesses user, password, group, and group membership information stored in databases for authentication purposes. Optionally, WebLogic Server can be used to manage the user, password, group, and group membership information.

declarative security

Security that is defined, or declared, using the application deployment descriptors. For Web applications, you define the deployment descriptors in the `web.xml` and `weblogic.xml` files. For EJBs, you define the deployment descriptors in the `ejb-jar.xml` and `weblogic-ejb-jar.xml` files.

default realm

The active security realm. In WebLogic Server 7.0 and later, you can configure multiple security realms in a WebLogic Server domain; however, only one can be the default (active) security realm. See also [Custom security realm](#), [security realm](#), [WebLogic Server domain](#).

digest authentication

An authentication mechanism in which a Web application authenticates itself to a Web service by sending the server a message digest along with its HTTP request message. The digest is computed by employing a one-way hash algorithm to a concatenation of the HTTP request message and the client's password. The digest is typically smaller than the HTTP request and does not contain the password.

digital certificate

Digital statement that associates a particular public key with a name or other attributes. The statement is digitally signed by a certificate authority. By trusting that authority to sign only true statements, you can trust that the public key belongs to the person named in the certificate. See also [digital signature](#), [public key](#), [trusted \(root\) certificate authority](#).

digital signature

String of bits used to protect the security of data being exchanged between two entities by verifying the identities of those entities. Specifically, this string is used to verify that the data came from the sending entity of record and was not modified in transit. A digital signature is computed from an entity's signed data and private key. It can be trusted only to the extent that the public key used to verify it can be trusted. See also [entity](#), [private key](#), [public key](#).

Domain Configuration Wizard

An interactive, graphical user interface (GUI) that facilitates the creation of a new WebLogic Server domain. The wizard can create WebLogic Server domain configurations for stand-alone servers, Administration Servers with Node Managers and Managed Servers, and clustered servers. You can use it to create the appropriate directory structure for your WebLogic Server domain, a basic `config.xml` file, and scripts that you can use to start the servers in your domain.

domain controller

A machine which holds Windows NT domain information. When configuring the Windows NT Authentication provider, the domain controller needs to be specified. See also [Windows NT Authentication provider](#).

embedded LDAP server

A server that contains user, group, security role, security policy and credential information. The WebLogic Authentication, Authorization, Role Mapping, and Credential Mapping providers use the embedded LDAP server as their security provider databases. See also [credential](#), [group](#), [security policy](#), [security role](#).

end certificate

The last certificate considered in a certificate chain.

entity

Something that exists independently as a particular and discrete unit. Persons, corporations, and objects are examples of entities.

File realm

In WebLogic Server 6.x, a realm that stores users, groups, encrypted passwords, and ACLs in a file. In WebLogic Server 7.0 and later you use a File realm only with Compatibility security. See also [Compatibility security](#).

filter

As defined by the Java Servlet API 2.3 specification, filters are objects that can transform a request or modify a response. Filters are not servlets, they do not actually create a response. They are preprocessors of the request before it reaches the servlet, and/or postprocessors of the response leaving the servlet. Filters provide the ability to encapsulate recurring tasks in reusable units and can be used to transform the response from a servlet or JSP page.

firewall

Software that monitors traffic between an internal network and the Internet, and that regulates the type of network traffic that can enter and leave the internal network. A firewall can be connected to the Internet or set up within a company's network to prevent unauthorized access to the network. Firewalls protect information on computers and information that is being carried over the network. Firewalls use various types of filters to prevent access, including limiting the types of protocols allowed and restricting access from network nodes by IP addresses and DNS node names.

global role

A security role that applies to all WebLogic resources within a security realm. For example, if the WebLogic Role Mapping provider is being used in the default security realm, global roles can be defined in terms of user, group, and hours of access. See also [Role Mapping provider](#), [scoped role](#), [security realm](#), [security role](#), [WebLogic resource](#).

group

Collection of users that share some characteristic, such as a department, a job function, or a job title. Groups are a static identity that a server administrator assigns. Groups are associated with security roles. Giving permission to a group is the same as giving the permission to each user who is a member of the group. See also [user](#).

host name verification

The process of verifying that the name of the host to which an SSL connection is made is the intended or authorized party. See also [Host Name Verifier](#), [Secure Sockets Layer \(SSL\)](#).

Host Name Verifier

Code that validates that the host to which an SSL connection is made is the intended or authorized party. A Host Name Verifier is useful when a WebLogic Server client or a WebLogic Server instance acts as an SSL client to another application server. It helps prevent man-in-the-middle attacks. By default, WebLogic Server, as a function of the SSL handshake, compares the common name in the subject distinguished name (DN) of the SSL server's digital certificate with the host name of the SSL server used to initiate the SSL connection. If the subject DN and the host name do not match, the SSL connection is dropped. See also [digital certificate](#), [host name verification](#), [Secure Sockets Layer \(SSL\)](#), [subject](#).

Identity Assertion

Special type of authentication whereby a client's identity is established through the use of client-supplied tokens that are generated from an outside source. Identity is asserted when these tokens are mapped to usernames. For example, the client's identity can be established by using a digital certificate, and that certificate can be passed around the system so that users are not asked to sign on more than once. Thus, identity assertion can be used to enable single sign-on. See also [authentication](#), [digital certificate](#), [Identity Assertion provider](#), [single sign-on](#), [SSL tunneling](#), [token](#).

Identity Assertion provider

A security provider that performs perimeter authentication - a special type of authentication using tokens. Identity Assertion providers also allow WebLogic Server to establish trust by validating a user. Thus, the function of an Identity Assertion provider is to validate and map a token to a username. See also [perimeter authentication](#), [security provider](#), [token](#), [user](#).

Identity Provider

A system, or administrative domain, that asserts that a user has been authenticated and is given associated attributes. For example, there is a user Dan Murphy, he has an email address of `dmurphy@company.com` and he authenticated to this domain using a password mechanism. Also known as a [SAML authority](#), or [asserting party](#).

Intersite Transfer Service (ITS)

An addressable component in the SAML 1.1 architecture that provides a point of functionality for SAML 1.1 processing, such as artifact or redirect generation.

JAAS control flag

If a security realm has multiple Authentication providers configured, the JAAS control flag determines how the login sequence uses the Authentication providers. See also [Authentication provider](#).

JAAS LoginModule

Responsible for authenticating users within the security realm and for populating a subject with the necessary principals (users/groups). A LoginModule is a required component of an Authentication provider, and can be a component of an Identity Assertion provider if you want to develop a separate LoginModule for perimeter authentication. LoginModules that are not used for perimeter authentication also verify the proof material submitted (for example, a user's password). See also [authentication](#), [group](#), [Identity Assertion provider](#), [perimeter authentication](#), [principal](#), [security realm](#), [subject](#).

Java Authentication and Authorization Service (JAAS)

Set of Java packages that enable services to authenticate and enforce access controls upon users. JAAS implements a Java version of the standard Pluggable Authentication Module (PAM) framework, and supports user-based authorization. WebLogic Server only implements the authentication portion of JAAS. See also [authentication](#), [authorization](#), [user](#).

Java Authorization Contract for Containers (JACC)

A permissions-based security model for EJBs and servlets. JACC can be used as a replacement for the EJB and Servlet container deployment and authorization provided by WebLogic Server.

Java Cryptography Architecture

A framework for accessing and developing cryptographic functionality for the Java platform. For a description of the Java Cryptography Architecture provided by Sun Microsystems, Inc., see <http://java.sun.com/j2se/1.5.0/docs/guide/security/CryptoSpec.html#Introduction>. See also [Java Cryptography Extensions \(JCE\)](#)

Java Cryptography Extensions (JCE)

Set of Java packages that extends the Java Cryptography Architecture API to include APIs for encryption, key exchange, and Message Authentication Code (MAC) algorithms. See <http://java.sun.com/j2se/1.5.0/docs/guide/security/jce/JCERefGuide.html> for a description of JCE provided by Sun Microsystems, Inc. See also [Java Cryptography Architecture](#).

Java Naming and Directory Interface (JNDI)

The Java Naming and Directory Interface (JNDI) is an application programming interface (API) that provides naming services to Java applications. JNDI is an integral component of the Sun Microsystems Java EE technology and is defined to be independent of any specific naming or directory service implementation. It supports the use of a single method for accessing various new and existing services. This support allows any service-provider implementation to be plugged into the JNDI framework using the standard service provider interface (SPI) conventions. In addition, JNDI allows Java applications in WebLogic Server to access external directory services such as LDAP in a standardized fashion, by plugging in the appropriate service provider.

Java Security Manager

Security manager for the Java virtual machine (JVM). The Java Security Manager works with the Java API to define security boundaries through the `java.lang.SecurityManager` class, thus, enabling developers to establish a custom security policy for their Java applications.

WebLogic Server supports the use of the Java Security Manager to prevent untrusted code from performing actions that are restricted by the Java security policy file. The Java Security Manager uses the Java security policy file to enforce a set of permissions granted to classes. The permissions allow specified classes running in that instance of the JVM to permit or deny certain runtime operations. See also [Java security policy file](#), [policy condition](#).

Java security policy file

File used by the Java Security Manager to enforce a set of permissions granted to specified classes running in an instance of the WebLogic Server-supported Java Virtual Machine (JVM). Classes running in that instance of the JVM use the permissions to permit or deny certain runtime operations. See also [Java Security Manager, policy condition](#).

JNDI

See [Java Naming and Directory Interface \(JNDI\)](#).

KDC/TGS

Key Distribution Center/Ticket Granting Service. In Kerberos authentication, the KDC maintains a list of user principals and is contacted through the kinit program for the user's initial ticket. The Ticket Granting Service maintains a list of service principals and is contacted when a user wants to authenticate to a server providing such a service.

The KDC/TGS is a trusted third party that must run on a secure host. It creates ticket-granting tickets and service tickets. The KDC and TGS are usually the same entity.

Kerberos

A network authentication service developed under Massachusetts Institute of Technology's Project Athena that strengthens security in distributed environments. Kerberos is a trusted third-party authentication system that relies on shared secrets and assumes that the third party is secure. It provides single sign-on capabilities and database link authentication (MIT Kerberos only) for users, provides centralized password storage, and enhances PC security.

Kerberos ticket

A sequence of a few hundred bytes in length that is used to control access to physically insecure networks. Kerberos tickets are based on the Kerberos protocol. Kerberos is a network authentication protocol that allows entities (users and services) communicating over networks to prove their identity to each other, while preventing eavesdropping or replay attacks. The protocol was designed to provide strong authentication for client/server applications by using secret-key cryptography. For more information, see <http://web.mit.edu/kerberos/www/>. See also [private key](#).

keystore

An in-memory collection of private key and trusted certificate pairs. The information is protected by a passphrase, such as a password, a credit card number, Personal Identification Number, or some other form of personal identification information. In the Administration Console, the keystore is referred to as the Trusted Keystore. For more information, see SDK 1.4.1 Javadoc produced by Sun Microsystems, Inc., which is available at <http://java.sun.com/javase/6/docs/api/index.html>. See also [private key](#), [trusted \(root\) certificate authority](#).

LDAP Authentication provider

Authentication provider that uses a Lightweight Data Access Protocol (LDAP) server to access user and group information, for example, iPlanet's Active Directory and Novell's OpenLDAP. See also [group](#), [user](#).

LDAP security realm

A WebLogic Server 6.x security realm. In WebLogic Server 6.x, security realms provide authentication and authorization services. The LDAP security realm provides authentication through an LDAP server. This server allows you to manage all the users for your organization in one place: the LDAP directory. The LDAP security realm supports Open LDAP, Netscape iPlanet, Microsoft Site Server, and Novell NDS. In WebLogic Server 7.x or later, you can only use the LDAP security realm when using Compatibility security. See also [authentication](#), [authorization](#), [Compatibility security](#), [File realm](#), [security realm](#), [user](#).

LoginModule

See [JAAS LoginModule](#).

MBean

Short for "managed bean," a Java object that represents a Java Management eXtensions (JMX) manageable resource. MBeans are instances of MBean types. MBeans are used to configure and manage security providers. See also [MBean type](#), [security provider](#).

MBean Definition File (MDF)

An XML file used by the WebLogic MBeanMaker to generate files for an MBean type. See also [MBean type](#), [WebLogic MBeanMaker](#).

MBean implementation file

One of several intermediate Java files generated by the WebLogic MBeanMaker utility to create an MBean type for a custom security provider. You edit this file to supply your specific method implementations. See also [MBean information file](#), [MBean interface file](#), [MBean type](#), [WebLogic MBeanMaker](#).

MBean information file

One of several intermediate Java files generated by the WebLogic MBeanMaker utility to create an MBean type for a custom security provider. This file contains mostly metadata and therefore requires no editing. See also [MBean implementation file](#), [MBean interface file](#), [MBean type](#), [WebLogic MBeanMaker](#).

MBean interface file

One of several intermediate Java files generated by the WebLogic MBeanMaker utility to create an MBean type for a custom security provider. This file is the client-side API to the MBean that your runtime class or your MBean implementation will use to obtain configuration data, and requires no editing. See also [MBean implementation file](#), [MBean information file](#), [MBean type](#), [runtime class](#), [WebLogic MBeanMaker](#).

MBean JAR File (MJF)

JAR file that contains the runtime classes and MBean types for a security provider. MJFs are created by the WebLogic MBeanMaker. See also [MBean type](#), [runtime class](#), [security provider](#), [WebLogic MBeanMaker](#).

MBean type

Factory for creating the MBeans used to configure and manage security providers. MBean types are created by the WebLogic MBeanMaker. See also [MBean](#), [security provider](#), [WebLogic MBeanMaker](#).

message digest

A digitally created hash, or fingerprint, created from a block of plain text. Even though the complete message is used to create the hash, the message cannot be recreated from the hash. Message digests help prevent man-in-the-middle attacks. Because there is only one digest for any given block of plain text, the digest can be used to verify the authenticity of the message. Thus, this process results in a digital signature of the message, which can be used to provide non-repudiation and integrity services. See also [message digest algorithm](#).

message digest algorithm

A computational procedure that is used to produce a message digest from a block of plain text. Once a message digest is produced, other security mechanisms are used to encrypt and convey the digest. See also [message digest](#).

mutual authentication

Authentication that requires both client and server to present proof of identity. Two-way SSL authentication is a form of mutual authentication in that both client and server present digital certificates to prove their identity. However, with two-way SSL, the authentication happens at the SSL level, whereas other forms of mutual authentication are executed at higher levels in the protocol stack. See also [authentication](#), [digital certificate](#), [Secure Sockets Layer \(SSL\)](#), [two-way SSL authentication](#), [trusted \(root\) certificate authority](#).

nonce

An opaque token used in Digest authentication.

non-repudiation

Irrefutable evidence that a security event occurred.

one-way SSL authentication

Type of SSL authentication which requires the server to present a certificate to the client, but the client is not required to present a certificate to the server. The client must authenticate the server, but the server will accept any client into the connection. Enabled by default in WebLogic Server. See also [mutual authentication](#), [two-way SSL authentication](#).

Password Validation provider

Security provider that can be configured with an authentication provider to enforce a set of password composition rules.

perimeter authentication

Authentication that occurs outside the application server domain. Perimeter authentication is typically accomplished when a remote user specifies an asserted identity and some form of corresponding proof material, normally in the form of a passphrase (such as a password, a credit card number, Personal Identification Number, or some other form of personal identification information.), to an authentication server (typically a Web server) that performs the verification and then passes an artifact, or token, to the application server domain (for example, a WebLogic Server domain). The application server can then pass the token around to systems in the domain so that users are not asked to sign on more than once.

The authentication agent, the entity that actually vouches for the identity, can take many forms, such as a Virtual Private Network (VPN), a firewall, an enterprise authentication service (Web server), or some other form of global identity service.

The WebLogic Server security architecture supports Identity Assertion providers that perform perimeter authentication (Web server, firewall, VPN) and handle multiple security token types and protocols (SOAP, IIOP-CSIV2). See also [authentication](#), [Identity Assertion](#).

policy condition

A condition under which a security policy will be created. Policy conditions, along with the specific information you supply for the condition (such as an actual user name, group, security role, or start/stop times), are called expressions. See also [policy statement](#).

policy expression

See [policy statement](#).

policy statement

A policy statement is the collection of expressions that define who is granted access to a WebLogic resource, and is therefore the main part of any security policy you create. Policy statements are also referred to as policy expressions. See also [policy condition](#).

principal

The identity assigned to a user, group, or system process as a result of authentication. A principal can consist of any number of users and groups. Principals are typically stored within subjects. See also [authentication](#), [group](#), [subject](#), [user](#).

principal validation

The act of signing and later verifying that a principal has not been altered since it was signed. Principal validation establishes trust of principals. See also [principal](#).

private key

An encryption/decryption key known only to the party or parties that exchange secret messages. It is called private because it must be kept secret from everyone but the owner. See also [public key](#).

private key algorithm

The computational procedure used to encode, or encrypt, ciphertext. Data encrypted with the private key can only be decrypted by the public key. See also [private key](#), [public key](#), [RDBMS security realm](#).

programmatic security

Application security that is defined in servlets and EJBs using Java methods.

public key

Value provided by a certificate authority as an encryption/decryption key that, combined with a private key, can be used to effectively encrypt and decrypt messages and digital signatures. The key is called public because it can be made available to anyone. Public key cryptography is also called asymmetric cryptography because different keys are used to encrypt and decrypt the data. See also [asymmetric key cryptography](#), [private key](#).

public key algorithm

The computational procedure used to encode, or encrypt, plain text. Data encrypted with the public key can only be decrypted by the private key. See also [private key](#), [private key algorithm](#), [public key](#).

public key cryptography

See [asymmetric key cryptography](#).

RDBMS security realm

A WebLogic Server 6.x security realm. In WebLogic Server 6.x, security realms provided authentication and authorization services. The RDBMS security realm stores Users, Groups, and ACLs in a relational database. In WebLogic Server 7.0 and later, you can only use the RDMS security realm when using Compatibility security. See also [access control list \(ACL\)](#), [authentication](#), [authorization](#), [Compatibility security](#), [group](#), [security realm](#), [user](#).

RDBMS security store

An external RDBMS containing a datastore that, when configured in a domain, is used by select security providers for storing security data.

Realm Adapter Adjudication provider

The Realm Adapter Adjudication provider enables both the WebLogic Authorization provider and the Realm Adapter Authorization provider to be used together for a security realm in Compatibility security. See also [Compatibility security](#), [Compatibility realm](#).

Realm Adapter Auditing provider

Auditing provider in the CompatibilityRealm that allows you to use implementations of the `weblogic.security.audit` interface with WebLogic Server deployments using Compatibility security. You must run Compatibility security in order to access the Compatibility realm and the Realm Adapter providers through the WebLogic Server Administration Console. See also [Compatibility security](#), [Compatibility realm](#).

Realm Adapter Authentication provider

Authentication provider in the Compatibility realm that allows backward compatibility to the authentication services in 6.x security realms. You must run Compatibility security in order to access the Compatibility realm and the Realm Adapter providers through the WebLogic Server Administration Console. See also [Compatibility security](#), [Compatibility realm](#).

Realm Adapter Authorization provider

Authorization provider in the Compatibility realm that allows backward compatibility to the authorization services in 6.x security realms. You must run Compatibility security in order to access the Compatibility realm and the Realm Adapter providers through the WebLogic Server Administration Console. See also [Compatibility security](#), [Compatibility realm](#).

Realm Adapter provider

Type of security provider used to access WebLogic Server 6.x security services when using Compatibility security in WebLogic Server 7.0 or later. These providers allow you to adapt 6.x security providers so that they can be used with WebLogic Server 7.0 and later. You must run Compatibility security in order to access the Compatibility realm and the Realm Adapter providers through the WebLogic Server Administration Console. See also [Compatibility security](#), [Compatibility realm](#).

relying party

In web SSO, determines whether assertions provided to it by an asserting party should be trusted. SAML defines a number of mechanisms that enable the relying party to trust the assertions provided to it. Although a relying party may trust the assertions

provided to it, local access policy defines whether the subject may access local resources. Therefore, even if a relying party trusts that a user is Dan Murphy, it does not mean Dan Murphy can access all the resources in the domain. See also [asserting party](#), [Identity Provider](#), [Security Assertion Markup Language \(SAML\)](#), [single sign-on](#).

resource

See [WebLogic resource](#).

resource adapter

System-level software driver (also called a connector) used by an application server (such as WebLogic Server) or an application client to connect to an enterprise information system (EIS). Resource adapters contain the Java components and, if necessary, the native components required to interact with the EIS.

The WebLogic Java EE Connector Architecture supports resource adapters developed by EIS vendors and third-party application developers that can be deployed in any application server supporting the Sun Microsystems Java EE Platform Specification.

Responder service

The URL on the SAML source site that will process requests for SAML. See also [SAML source site](#).

role condition

A condition under which a security role (global or scoped) will be granted to a user or group. Role conditions, along with the specific information you supply when creating the condition (such as an actual user name, group, or start/stop times), are called expressions. See [security policy](#), [role mapping](#).

role expression

Specific information that you supply when creating role conditions. See [role condition](#).

role mapping

Process by which the WebLogic Security Service compares users or groups against a security role condition to determine whether they should be dynamically granted a security role. Role mapping occurs at runtime, just prior to when an Access Decision is rendered for a protected WebLogic resource. See also [Access Decision](#), [group](#), [principal](#), [role condition](#), [security role](#), [user](#), [WebLogic resource](#), [WebLogic Security Service](#).

Role Mapping provider

A security provider that determines what security roles apply to the principals stored in a subject when the subject is attempting to perform an operation on a WebLogic resource. Because this operation usually involves gaining access to the WebLogic resource, Role Mapping providers are typically used with Authorization providers. See also [Authorization provider](#), [principal](#), [security role](#), [subject](#), [WebLogic resource](#).

role statement

A collection of expressions that define how a security role is granted, and is therefore the main part of any security role you create. See [role expression](#).

runtime class

Java class that implements a Security Service Provider Interface (SSPI) and contains the actual security-related behavior for a security provider. See also [security provider](#), [Security Service Provider Interfaces \(SSPIs\)](#).

SAML artifact

A small data object containing a pointer to a SAML protocol message. A SAML artifact is typically embedded in a SAML request/response, and partner that receives the SAML request/response subsequently de-references the SAML artifact to obtain the SAML protocol message by invoking the sending partner's Artifact Resolution Service. See also [Artifact Resolution Service \(ARS\)](#).

SAML assertion

A package of information that supplies one or more statements made by a SAML Authority. The following types of statements are supported:

- Authentication statements which say when and how a subject was authenticated.
- Attribute statements which provide specific information about the subject (for example, what groups the Subject is a member of).
- Authorization statements identify what the Subject is entitled to do.

SAML authority

An entity that can make authoritatively assert security information in the form of SAML assertions. See also [Identity Provider](#), [asserting party](#), [Single Sign-On Service](#).

SAML binding

Details exactly how the SAML protocol maps onto transport and messaging protocols.

SAML destination site

The receiver of a SAML assertion. See also [Service Provider](#).

SAML profile

Technical descriptions of particular flows of assertions and protocol messages that define how SAML can be used for a particular purpose.

SAML source site

A system, or administrative domain, that asserts that a user has been authenticated and is given associated attributes. A SAML source can be either the site that authenticates the user (such as with the SAML Web SSO profile), or the site that is forwarding identity when acting as a client (such as with Web Services Security SAML Token profile). See also [Identity Provider](#).

schema

A data structure associated with the data stored in a database. The DBMS Authentication providers require that the schema used to store data in the database be defined during configuration. See also [Database Management System \(DBMS\) Authentication provider](#).

scoped role

A security role that applies to a specific WebLogic resource in a security realm. See also [global role](#), [Role Mapping provider](#), [security role](#), [security realm](#).

secret key cryptography

See [symmetric key cryptography](#).

Secure Sockets Layer (SSL)

An Internet transport-level technology developed by Netscape to provide data privacy between applications. Generally, Secure Sockets Layer (SSL) provides (1) a mechanism

that the applications can use to authenticate each other's identity and (2) encryption of the data exchanged by the applications. SSL supports the use of public key cryptography for authentication, and secret key cryptography and digital signatures to provide privacy and data integrity. See also [authentication](#), [digital signature](#), [public key cryptography](#), [symmetric key cryptography](#).

Security Assertion Markup Language (SAML)

An XML-based framework for exchanging security information. SAML implementations provide an interoperable, XML-based, security solution that allows authentication and authorization information to be exchanged securely. SAML is the key to enabling single sign-on capabilities for Web services. For more information, see <http://xml.coverpages.org/saml.html>.

You can develop custom Identity Assertion providers for WebLogic Server that support different token types, including SAML. See also [authentication](#), [authorization](#), [Identity Assertion](#), [perimeter authentication](#), [Cross-Domain Single Sign-on](#), [user](#).

security policy

An association between a WebLogic resource and a user, group, or security role that protects the WebLogic resource against unauthorized access. A WebLogic resource has no protection until you assign it a security policy. You can assign security policies to an individual WebLogic resource or to components of the WebLogic resource.

In WebLogic Server 7.0 and later, security policies replace access control lists (ACLs), except when Compatibility security is used. See also [access control list \(ACL\)](#), [group](#), [security role](#), [user](#), [WebLogic resource](#).

security provider

In WebLogic Server 7.0 and later, software modules that can be "plugged into" a WebLogic Server security realm to provide security services (such as authentication, authorization, auditing, and credential mapping) to applications. A security provider consists of runtime classes and MBeans, which are created from SSPIs and MBean types, respectively. Security providers are WebLogic security providers (provided with WebLogic Server) or custom security providers. See also [custom security provider](#), [MBean](#), [MBean type](#), [runtime class](#), [Security Service Provider Interfaces \(SSPIs\)](#), [WebLogic security provider](#).

security provider database

Database that contains the users, groups, security policies, roles, and credentials used by some types of security providers to provide security services. The security provider database can be the embedded LDAP server (as used by the WebLogic security providers), a properties file (as used by the sample security providers), or a production-quality database that you may already be using. See also [credential](#), [embedded LDAP server](#), [group](#), [security role](#), [security policy](#), [WebLogic security provider](#).

security realm

In WebLogic Server 6.x, security realms provide authentication and authorization services. You use the File realm or a set of alternative security realms, including the Lightweight Data Access Protocol (LDAP), Windows NT, Unix, or RDBMS realms. If you want to customize authentication, you write your own security realm and integrate it into the WebLogic Server environment. In WebLogic Server 6.x you cannot have multiple security realms in a domain. See also [File realm](#).

In WebLogic Server 7.0 and later, security realms act as a scoping mechanism. Each security realm consists of a set of configured security providers, users, groups, roles,

and security policies. You can configure multiple security realms in a domain; however, only one can be the default (active) security realm. WebLogic Server provides two default security realms: myrealm and Compatibility realm. You can access an existing 6.x security configuration through the Compatibility realm. You can no longer write a custom security realm using the application programming interfaces as you could in WebLogic Server 6.x; rather, you configure a new security realm (called myrealm by default) to provide the security services you want and then set the new security realm as the default security realm. See also [Compatibility realm](#), [Custom security realm](#), [default realm](#), [Domain Configuration Wizard](#), [security provider](#), [WebLogic resource](#).

security role

A dynamically computed privilege that is granted to users or groups based on specific conditions. The difference between groups and roles is that a group is a static identity that a server administrator assigns, while membership in a role is dynamically calculated based on data such as user name, group membership, or the time of day. Security roles are granted to individual users or to groups, and multiple roles can be used to create security policies for a WebLogic resource. Once you create a security role, you define an association between the role and a WebLogic resource. This association (called a security policy) specifies who has what access to the WebLogic resource. See also [global role](#), [group](#), [role mapping](#), [scoped role](#), [security policy](#), [user](#), [WebLogic resource](#).

Security Service Provider Interfaces (SSPIs)

Set of WebLogic packages that enables custom security providers to be developed and integrated with the WebLogic Server Security Service. These interfaces are implemented by the WebLogic security providers and custom security providers. The WebLogic Security Framework calls methods in these interfaces to perform security operations. See also [security provider](#), [WebLogic Security Framework](#).

Service Provider

A system, or administrative domain, that determines whether it trusts the assertions provided to it by the Identity Provider. SAML defines a number of mechanisms that enable the Service Provider to trust the assertions provided to it. See also [relying party](#).

Servlet Authentication filter

A unique implementation of the Java EE filter object which replace container-based authentication. Servlet Authentication filters control the authentication conversation with the client redirecting to a remote site to execute the login, extracting login information out of the query string, and negotiating a login mechanism with the browser.

Simple and Protected GSS-API Negotiation Mechanism (SPNEGO)

A protocol that allows participation in a Kerberos SSO environment.

single sign-on

Ability to require a user to sign on to an application only once and gain access to many different application components, even though these components may have their own authentication schemes. Single sign-on is achieved using identity assertion, LoginModules, and tokens. See also [authentication](#), [Cross-Domain Single Sign-on](#), [Identity Assertion](#), [JAAS LoginModule](#), [token](#), [user](#).

Single Sign-On Service

Service used in the SAML 2.0 Web Single Sign-On Profile that:

- Accepts authentication requests from a Service Provider
- Authenticates the user
- Invokes the SAML 2.0 Credential Mapping provider to generate a SAML assertion
- Wraps the assertion in an authentication response to be sent to the Service Provider.

This service can also create an unsolicited authentication response, which is then sent to the Service Provider to start an Identity Provider initiated web single sign-on session.

SSL hardware accelerator

A peripheral Secure Sockets Layer (SSL) platform that attaches to a Web switch with the express purpose of improving SSL performance for a client. For example, the Alteon SSL Accelerator can be used with WebLogic Server. This accelerator performs a TCP handshake with the client (in this case, WebLogic Server) through a Web switch and performs all the SSL encryption and decryption for the session.

SSL tunneling

Tunneling Secure Socket Layer (SSL) over an IP-based protocol. Tunneling means that each SSL record is encapsulated and packaged with the headers needed to send the record over another protocol.

SSPI MBean

Interfaces used by Oracle to generate MBean types for the WebLogic security providers, and from which you generate MBean types for custom security providers. SSPI MBeans may be required (for configuration) or optional (for management). See also [custom security provider](#), [MBean type](#), [WebLogic security provider](#).

subject

A grouping of related information for a single entity, such as a person, as specified by the Java Authentication and Authorization Service (JAAS). The related information includes the Subject's identities, or Principals, as well as its security-related attributes (for example, passwords and cryptographic keys). A subject can contain any number of Principals. Both users and groups can be used as Principals by application servers such as WebLogic Server. In WebLogic security providers (security providers supplied with the WebLogic Server product), the Subject contains a Principal for the user (`WLSUser Principal`) and a Principal for each group of which the user is a member (`WLSGroups Principals`). Custom security providers may store identities differently. See also [authentication](#), [custom security provider](#), [group](#), [JAAS control flag](#), [principal](#), [user](#).

symmetric key cryptography

A key-based cryptography that uses an encryption algorithm in which the same key is used both to encrypt and decrypt the data. Symmetric key cryptography is also called secret key cryptography. See also [asymmetric key cryptography](#).

target URL

The requested URL that initiates the authentication process in web SSO. See also [SAML source site](#).

token

Artifact generated as part of the authentication process of users or system processes. When using Identify Assertion, a token is presented to show that the user has been

authenticated. Tokens come in many different types, including Kerberos and Security Assertion Markup Language (SAML). See also [authentication](#), [Security Assertion Markup Language \(SAML\)](#), [Secure Sockets Layer \(SSL\)](#), [Identity Assertion](#), [SSL tunneling](#), [Security Assertion Markup Language \(SAML\)](#), [user](#).

Trust Manager

An interface that enables you to override validation errors in a peer's digital certificate and continue the SSL handshake. You can also use the interface to discontinue an SSL handshake by performing additional validation on a server's digital certificate chain.

trusted (root) certificate authority

A well-known and trusted third-party organization or company that issues digital certificates used to create digital signatures and public-private key pairs. The function of the trusted certificate authority is similar to that of a notary public: to guarantee the identify of the individual or organization presenting the certificate. Trusted certificate authorities issue certificates that are used to sign other certificates. Certificate authorities are referred to as root certificate authorities because their authority is recognized and thus they do not need anyone to validate their identity. Trusted (root) certificate authority (CA) certificates are installed into applications that authenticate certificates. For example, Web browsers are usually distributed with several trusted (root) CA certificates pre-installed. If the server certificate is not signed by a well-known certificate authority and you want to ensure that the server's certificate will be authenticated by the client, it is good practice for the server to issue a certificate chain that terminates with a certificate that is signed by a well-known certificate authority. See also [certificate chain](#), [private key](#), [public key](#).

two-way SSL authentication

Authentication that requires both the client and server to present a certificate before the connection thread is enabled between the two. With two-way SSL authentication, WebLogic Server not only authenticates itself to the client (which is the minimum requirement for certificate authentication), it also requires authentication from the requesting client. Clients are required to submit digital certificates issued by a trusted certificate authority. This type of authentication is useful when you must restrict access to trusted clients only. Two-way SSL authentication is a form of mutual authentication. See also [authentication](#), [digital certificate](#), [mutual authentication](#), [Secure Sockets Layer \(SSL\)](#), [trusted \(root\) certificate authority](#).

UNIX security realm

A WebLogic Server 6.x security realm. The UNIX security realm executes a small native program, `wlauth`, to look up Users and Groups and to authenticate users on the basis of their UNIX login names and passwords. The `wlauth` program uses PAM (Pluggable Authentication Modules), which allows you to configure authentication services in the operating system without altering applications that use the service. In WebLogic Server 7.0 and later, you can only use the UNIX security realm when using Compatibility security. See also [authentication](#), [authorization](#), [Compatibility security](#), [group](#), [security realm](#).

user

An entity that can be authenticated. A user can be a person or a software entity, such as a Java client. Each user is given a unique identity within a security realm. For more efficient security management, Oracle recommends adding users to groups. A group is a collection of users who usually have something in common, such as working in the same department in a company. Users can be placed into groups that are associated

with security roles, or be directly associated with security roles. See also [entity](#), [group](#), [security role](#), [WebLogic resource](#).

WebLogic component

WebLogic Server implements Java EE component technologies, which include servlets, JSP Pages, and Enterprise JavaBeans. To build a WebLogic Server application, you must create and assemble components, using the service APIs when necessary. Components are executed in the WebLogic Server Web container or EJB container. Web components provide the presentation logic for browser-based Java EE applications. EJB components encapsulate business objects and processes. See also [WebLogic container](#), [Windows NT security realm](#).

WebLogic container

To promote fast development and portability, Java EE identifies common services needed by components and implements them in the container that hosts the component. Containers provide the life cycle support and services defined by the Java EE specifications so that the components you build do not have to handle underlying details. A component has only the code necessary to describe the object or process that it models. It has no code to access its execution environment or services such as transaction management, access control, network communications, or persistence mechanisms. These services are provided by the container, which is implemented in WebLogic Server. Additionally, WebLogic containers give applications access to the Java EE application programming interfaces (APIs). WebLogic containers are available for use once the server is started. This component/container abstraction allows developers to work within their fields of expertise. WebLogic Server provides two types of containers: the Web container and the EJB container. See also [WebLogic component](#), [Windows NT security realm](#).

WebLogic Java EE service

WebLogic Server implements Java EE services, which include access to standard network protocols, database systems, and messaging systems. To build a WebLogic Server application, you must create and assemble components, using the service APIs when necessary. Web applications and EJBs are built on Java EE application services, such as JDBC, Java Messaging Service (JMS), and Java Transaction API (JTA). See also [WebLogic component](#).

WebLogic MBeanMaker

Command-line utility that takes an MBean Definition File (MDF) as input and output files for an MBean type. See also [MBean Definition File \(MDF\)](#), [MBean type](#).

WebLogic resource

Entities that are accessible from WebLogic Server, such as events, servlets, JDBC connection pools, JMS destinations, JNDI contexts, connections, sockets, files, and enterprise applications and resources, such as databases. See also [entity](#).

WebLogic Security Framework

Interfaces in the `weblogic.security.service` package that unify security enforcement and present security as a service to other WebLogic Server components. Security providers call into the WebLogic Security Framework on behalf of applications requiring security services. See also [security provider](#).

WebLogic security provider

Any of the security providers that are supplied by Oracle as part of the WebLogic Server product. These providers were developed using the Security Service Provider

Interfaces (SSPIs) for WebLogic Server. See also [custom security provider](#), [security provider](#), [Security Service Provider Interfaces \(SSPIs\)](#).

WebLogic Security Service

The WebLogic Server subsystem that implements the security architecture. This subsystem comprises three major components: the WebLogic Security Framework, the Security Service Provider Interfaces (SSPIs), and the WebLogic security providers.

WebLogic Server domain

A collection of servers, services, interfaces, machines, and associated WebLogic resource managers defined by a single configuration file. See also [WebLogic resource](#).

Windows NT Authentication provider

An authentication provider that uses Windows NT users and groups for authentication purposes.

Windows NT security realm

A WebLogic Server 6.x security realm. The Windows NT Security realm uses account information defined for a Windows NT domain to authenticate Users and Groups. In WebLogic Server 7.0 and later, you can only use the Windows NT security realm when using Compatibility security. See also [authentication](#), [authorization](#), [Compatibility security](#), [group](#), [security realm](#), [user](#).