

Oracle® Retail Macro Space Management
Report Designer User Guide
Release 13.2.4

February 2012

Copyright © 2012, Oracle. All rights reserved.

Primary Author: Phil Wells

Contributors: Anshuman Accanoor

This software and related documentation are provided under a license agreement containing restrictions on use and disclosure and are protected by intellectual property laws. Except as expressly permitted in your license agreement or allowed by law, you may not use, copy, reproduce, translate, broadcast, modify, license, transmit, distribute, exhibit, perform, publish, or display any part, in any form, or by any means. Reverse engineering, disassembly, or decompilation of this software, unless required by law for interoperability, is prohibited.

The information contained herein is subject to change without notice and is not warranted to be error-free. If you find any errors, please report them to us in writing.

If this software or related documentation is delivered to the U.S. Government or anyone licensing it on behalf of the U.S. Government, the following notice is applicable:

U.S. GOVERNMENT RIGHTS Programs, software, databases, and related documentation and technical data delivered to U.S. Government customers are "commercial computer software" or "commercial technical data" pursuant to the applicable Federal Acquisition Regulation and agency-specific supplemental regulations. As such, the use, duplication, disclosure, modification, and adaptation shall be subject to the restrictions and license terms set forth in the applicable Government contract, and, to the extent applicable by the terms of the Government contract, the additional rights set forth in FAR 52.227-19, Commercial Computer Software License (December 2007). Oracle USA, Inc., 500 Oracle Parkway, Redwood City, CA 94065.

This software is developed for general use in a variety of information management applications. It is not developed or intended for use in any inherently dangerous applications, including applications which may create a risk of personal injury. If you use this software in dangerous applications, then you shall be responsible to take all appropriate fail-safe, backup, redundancy, and other measures to ensure the safe use of this software. Oracle Corporation and its affiliates disclaim any liability for any damages caused by use of this software in dangerous applications.

Oracle is a registered trademark of Oracle Corporation and/or its affiliates. Other names may be trademarks of their respective owners.

This software and documentation may provide access to or information on content, products, and services from third parties. Oracle Corporation and its affiliates are not responsible for and expressly disclaim all warranties of any kind with respect to third-party content, products, and services. Oracle Corporation and its affiliates will not be responsible for any loss, costs, or damages incurred due to your access to or use of third-party content, products, or services.

Value-Added Reseller (VAR) Language

Oracle Retail VAR Applications

The following restrictions and provisions only apply to the programs referred to in this section and licensed to you. You acknowledge that the programs may contain third party software (VAR applications) licensed to Oracle. Depending upon your product and its version number, the VAR applications may include:

(i) the **MicroStrategy** Components developed and licensed by MicroStrategy Services Corporation (MicroStrategy) of McLean, Virginia to Oracle and imbedded in the MicroStrategy for Oracle Retail Data Warehouse and MicroStrategy for Oracle Retail Planning & Optimization applications.

(ii) the **Wavelink** component developed and licensed by Wavelink Corporation (Wavelink) of Kirkland, Washington, to Oracle and imbedded in Oracle Retail Mobile Store Inventory Management.

(iii) the software component known as **Access Via**TM licensed by Access Via of Seattle, Washington, and imbedded in Oracle Retail Signs and Oracle Retail Labels and Tags.

(iv) the software component known as **Adobe Flex**TM licensed by Adobe Systems Incorporated of San Jose, California, and imbedded in Oracle Retail Promotion Planning & Optimization application.

You acknowledge and confirm that Oracle grants you use of only the object code of the VAR Applications. Oracle will not deliver source code to the VAR Applications to you. Notwithstanding any other term or condition of the agreement and this ordering document, you shall not cause or permit alteration of any VAR Applications. For purposes of this section, "alteration" refers to all alterations, translations, upgrades, enhancements, customizations or modifications of all or any portion of the VAR Applications including all reconfigurations, reassembly or reverse assembly, re-engineering or reverse engineering and recompilations or reverse compilations of the VAR Applications or any derivatives of the VAR Applications. You acknowledge that it shall be a breach of the agreement to utilize the relationship, and/or confidential information of the VAR Applications for purposes of competitive discovery.

The VAR Applications contain trade secrets of Oracle and Oracle's licensors and Customer shall not attempt, cause, or permit the alteration, decompilation, reverse engineering, disassembly or other reduction of the VAR Applications to a human perceivable form. Oracle reserves the right to replace, with functional equivalent software, any of the VAR Applications in future releases of the applicable program.

Content

Send Us Your Comments.....	vii
Preface	8
Documentation Accessibility.....	8
Related Documents.....	8
Customer Support.....	9
Review Patch Documentation.....	9
Oracle Retail Documentation on the Oracle Technology Network.....	9
Conventions.....	9
1 Overview of Report Designer	1
Where Report Designer Reports are Selected	3
2 Opening Window	6
Menu and Toolbar Options	6
3 Creating a New Report Template.....	8
Creating a New Report.....	8
Report Design Dialogue Box	9
Page Set Up Options.....	10
4 Commands	12
General Commands.....	12
Toolbar Only Commands	12
Menus and Toolbars	12
Commands common to Menu Bar and Toolbar	13
File.....	13
Edit.....	14
View.....	15
Insert.....	16
Window.....	17
Help	17
Toolbar Only Commands	17
Views	17
Text Justification	18
Text Style.....	18
5 Designing the Report Template.....	19
Overview of Report Item Properties	19
Insert	20
Adding a Label.....	21
Adding a Field.....	23
Adding an Image	26
Adding a Line.....	28
Adding a Rectangle	30

Adding a View	32
Working with Views.....	36
Adding a Table.....	38
Other Design Options.....	40
Using Snap to Neatly Align Items.....	40
Changing Label and Field Text via Toolbar.....	41
Using the Clipboard	42
Selecting Multiple Items	42
Using Grouping	43
Bring to Front or Send to Back	44
6 Opening an Existing Report Template	45
7 Printing the Report	47
Print Preview	47
Printing.....	48

Send Us Your Comments

Oracle Retail Space Management Report Designer User Guide, Release 13.2.4.

Oracle welcomes customers' comments and suggestions on the quality and usefulness of this document.

Your feedback is important, and helps us to best meet your needs as a user of our products. For example:

- Are the implementation steps correct and complete?
- Did you understand the context of the procedures?
- Did you find any errors in the information?
- Does the structure of the information help you with your tasks?
- Do you need different information or graphics? If so, where, and in what format?
- Are the examples correct? Do you need more examples?

If you find any errors or have any other suggestions for improvement, then please tell us your name, the name of the company who has licensed our products, the title and part number of the documentation and the chapter, section, and page number (if available).

Note: Before sending us your comments, you might like to check that you have the latest version of the document and if any concerns are already addressed. To do this, access the Online Documentation available on the Oracle Technology Network Web site. It contains the most current Documentation Library plus all documents revised or released recently.

Send your comments to us using the electronic mail address: retail-doc_us@oracle.com
Please give your name, address, electronic mail address, and telephone number (optional).

If you need assistance with Oracle software, then please contact your support representative or Oracle Support Services.

If you require training or instruction in using Oracle software, then please contact your Oracle local office and inquire about our Oracle University offerings. A list of Oracle offices is available on our Web site at www.oracle.com.

Preface

This guide enables you to configure the Oracle Retail Space Management, along with the server-side components required for the application.

Documentation Accessibility

Our goal is to make Oracle products, services, and supporting documentation accessible to all users, including users that are disabled. To that end, our documentation includes features that make information available to users of assistive technology. This documentation is available in HTML format, and contains markup to facilitate access by the disabled community. Accessibility standards will continue to evolve over time, and Oracle is actively engaged with other market-leading technology vendors to address technical obstacles so that our documentation can be accessible to all of our customers. For more information, visit the Oracle Accessibility Program Web site at <http://www.oracle.com/accessibility/>.

Accessibility of Code Examples in Documentation

Screen readers may not always correctly read the code examples in this document. The conventions for writing code require that closing braces should appear on an otherwise empty line; however, some screen readers may not always read a line of text that consists solely of a bracket or brace.

Accessibility of Links to External Web Sites in Documentation

This documentation may contain links to Web sites of other companies or organizations that Oracle does not own or control. Oracle neither evaluates nor makes any representations regarding the accessibility of these Web sites.

Access to Oracle Support

Oracle customers have access to electronic support through My Oracle Support. For information, visit <http://www.oracle.com/support/contact.html> or visit <http://www.oracle.com/accessibility/support.html> if you are hearing impaired.

Related Documents

For more information on Macro Space Management, see the following documents in the Oracle Retail Macro Space Management Release 13.2.4 documentation set:

- *Oracle Retail Macro Space Management Administration User Guide*
- *Oracle Retail Macro Space Management Administration Module Online Help*
- *Oracle Retail Macro Space Management Configuration User Guide*
- *Oracle Retail Macro Space Management Configuration Module Online Help*
- *Oracle Retail Macro space Management Data Importer User Guide*
- *Oracle Retail Macro space Management Data Importer Online Help*
- *Oracle Retail Macro Space Management Fixture Studio Online Help*
- *Oracle Retail Macro Space Management Product Studio User Guide*
- *Oracle Retail Macro Space Management Product Studio Online Help*
- *Oracle Retail Macro Space Management Store Planning User Guide*
- *Oracle Retail Macro Space Management Store Planning Online Help*

-
- *Oracle Retail Macro Space Management Report Designer User Guide*
 - *Oracle Retail Macro Space Management Report Designer Online Help*
 - *Oracle Retail Macro Space Management Release Notes*
 - *Oracle Retail Macro Space Planning Install Guide*
 - *Oracle Retail Macro Space Planning License Information*
 - *Oracle Retail Macro Space Planning Data Model*

For more information on In-Store Space Collaboration see the following documents in the Oracle Retail In-Store Space Collaboration Release 13.2.4 documentation set:

- *Oracle Retail In-Store Space Collaboration User's Guide*
- *Oracle Retail In-Store Space Collaboration Online Help*

Customer Support

To contact Oracle Customer Support, access My Oracle Support at the following URL:

<https://support.oracle.com>

When contacting Customer Support, please provide the following:

- Product version and program/module name
- Functional and technical description of the problem (include business impact)
- Detailed step-by-step instructions to re-create
- Exact error message received
- Screen shots of each step you take

Review Patch Documentation

When you install the application for the first time, you install either a base release (for example, 13.2) or a later patch release (for example, 13.2.4). If you are installing the base release and additional patch and bundled hot fix releases, read the documentation for all releases that have occurred since the base release before you begin installation.

Documentation for patch and bundled hot fix releases can contain critical information related to the base release, as well as information about code changes since the base release.

Oracle Retail Documentation on the Oracle Technology Network

Documentation is packaged with each Oracle Retail product release. Oracle Retail product documentation is also available on the following Web site:

http://www.oracle.com/technology/documentation/oracle_retail.html

(Data Model documents are not available through Oracle Technology Network. These documents are packaged with released code, or you can obtain them through My Oracle Support.)

Documentation should be available on this Web site within a month after a product release.

Conventions

Navigate: This is a navigate statement. It tells you how to get to the start of the procedure and ends with a screen shot of the starting point and the statement “the Window Name window opens.”

This is a code sample

It is used to display examples of code

Overview of Report Designer

Report Designer allows the users to produce customized planogram report templates for use in Macro Space Management and In-Store Space Collaboration.

In the example below, the report template will result in a report outputting

- Planogram Name
- Front view of planogram
- Table of merchandise contained in the planogram.

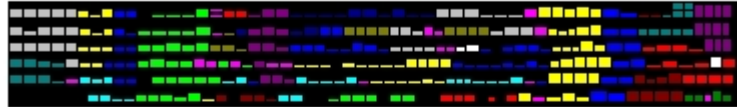
15 DR FROZEN ENTREE/PREPARED				
				
Bay	Name	Description	Manufactur	Qty
0	BANQUET	BANQUET SEL DNR CH	Generic Pro	216
0	BANQUET	BANQUET SEL DNR CH	Generic Pro	144
0	BANQUET	BANQUET SELECT ME	Generic Pro	216
0	BANQUET	BANQUET SELECT ME	Generic Pro	144
0	BANQUET	BANQUET DNR SEL YA	Generic Pro	216
0	BANQUET	BANQUET DNR SEL YA	Generic Pro	144
0	BANQUET	BANQUET CHICKEN FI	Generic Pro	216
0	BANQUET	BANQUET CHICKEN FI	Generic Pro	144
0	BANQUET	BANQUET ORIGINAL F	Generic Pro	132
0	BANQUET	BANQUET ORIGINAL F	Generic Pro	72
0	MICHELINA	MICHELINAS RAVIOLI A	Generic Pro	132
0	MICHELINA	MICHELINAS RAVIOLI A	Generic Pro	108
0	MICHELINA	MICHELINAS PENNE P	Generic Pro	132
0	MICHELINA	MICHELINAS PENNE P	Generic Pro	108
0	MICHELINA	MICHELINAS STUFFED	Generic Pro	132
0	MICHELINA	MICHELINAS STUFFED	Generic Pro	72
0	MICHELINA	MICHELINAS LEAN GO	Generic Pro	132
0	MICHELINA	MICHELINAS LEAN GO	Generic Pro	72
0	MICHELINA	MICHELINAS LEAN GO	Generic Pro	132
0	MICHELINA	MICHELINAS LEAN GO	Generic Pro	72
0	HLTHY CH	HLTHY CHC DU SALISB	Generic Pro	156
0	HLTHY CH	HLTHY CHC DU SALISB	Generic Pro	108
0	HLTHY CH	HLTHY CHC FRZ DNR B	Generic Pro	192

The general concept of using these templates is explained in the diagram below.

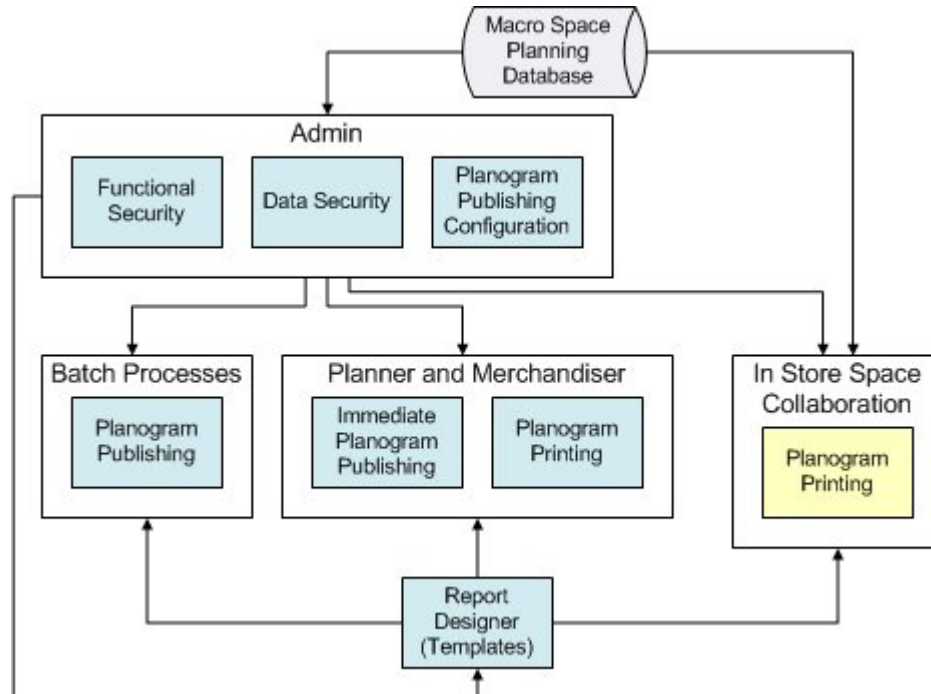

Macro Space Planning Database - this holds data in common between Macro Space Management and In-Store Space Collaboration.

Admin Module - this serves three purposes. Firstly permissions to access Report Designer and Planogram Publishing configuration are assigned in Functional Security. Next, the permissions for which planogram designs a user can publish or print are assigned in Data Security. Finally, the defaults for planogram publishing are assigned.

Batch Processes - planogram designs can be published using a batch process. Permissions must have previously been set in Admin. Planogram Publishing uses the default settings from the Planogram Publishing Configuration dialog box for the output of the published planograms.

Planner and Merchandiser modules - any user of these MSM modules may use Planogram Printing. Users with the appropriate permissions may use Immediate Planogram Publishing.

In-Store Space Collaboration - any user of this application may use Planogram Printing

Report Designer - this MSM module allows users to configure Planogram Design Reports. These reports may subsequently be used to print or publish planograms in the Planner and Merchandiser modules and in In-Store Space Collaboration.

Where Report Designer Reports are Selected

Report Designer Reports can be selected in the following locations.

Admin Module

This specifies which of the previously configured reports from Report Designer is used for Batch Planogram Publishing and as the default for Immediate Planogram Publishing and Planogram Printing.

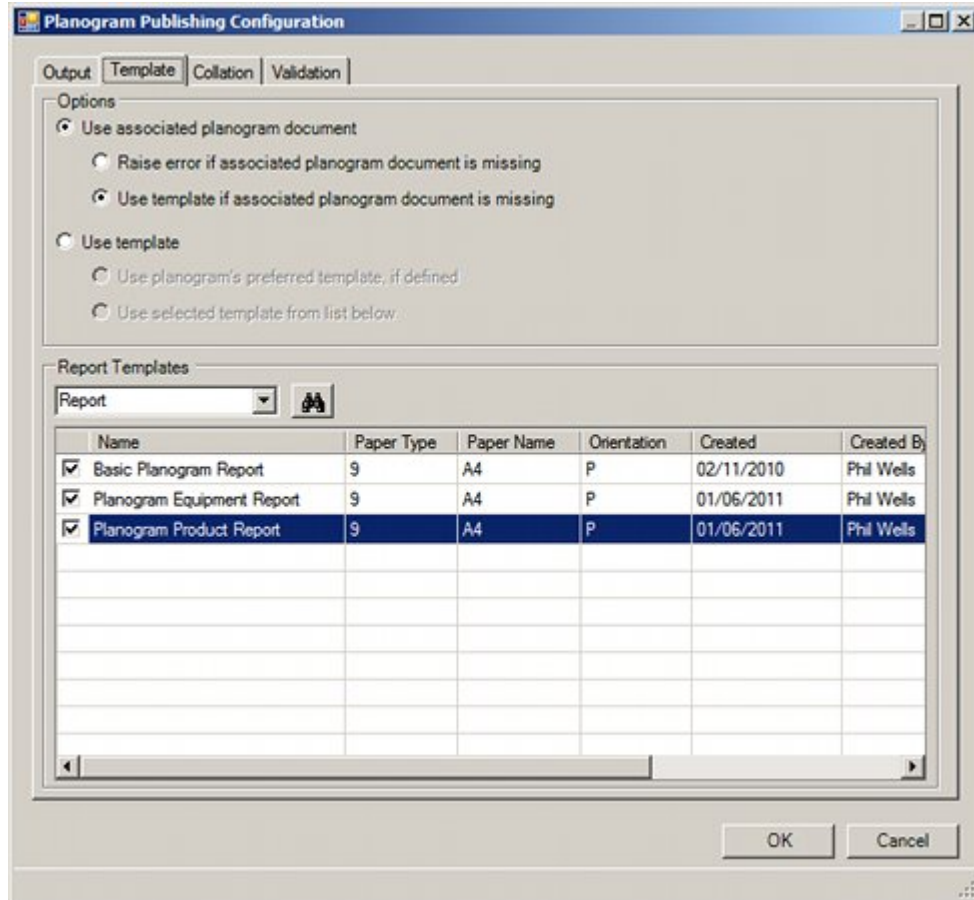

Planner and Merchandiser

The settings for Immediate Planogram Publishing are set in the dialog box - the default settings being picked up from the Planogram Publishing Configuration dialog box in Admin.

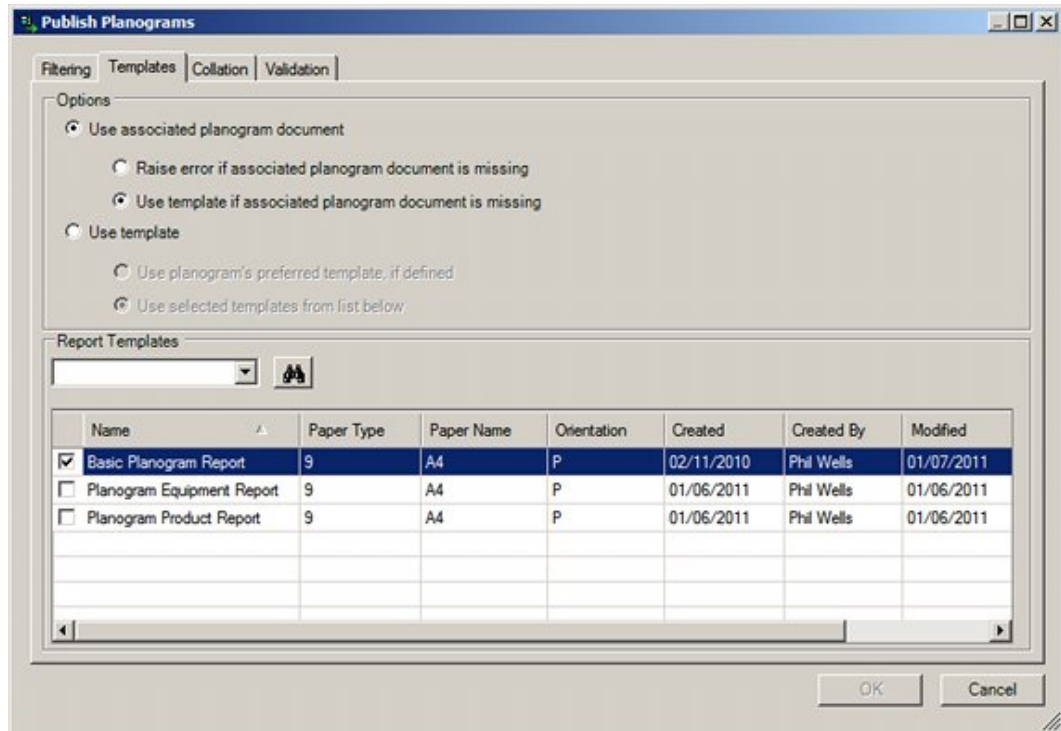

The settings for Planogram Printing are set in the dialog box - the default settings being picked up from the Planogram Publishing Configuration dialog box in Admin.

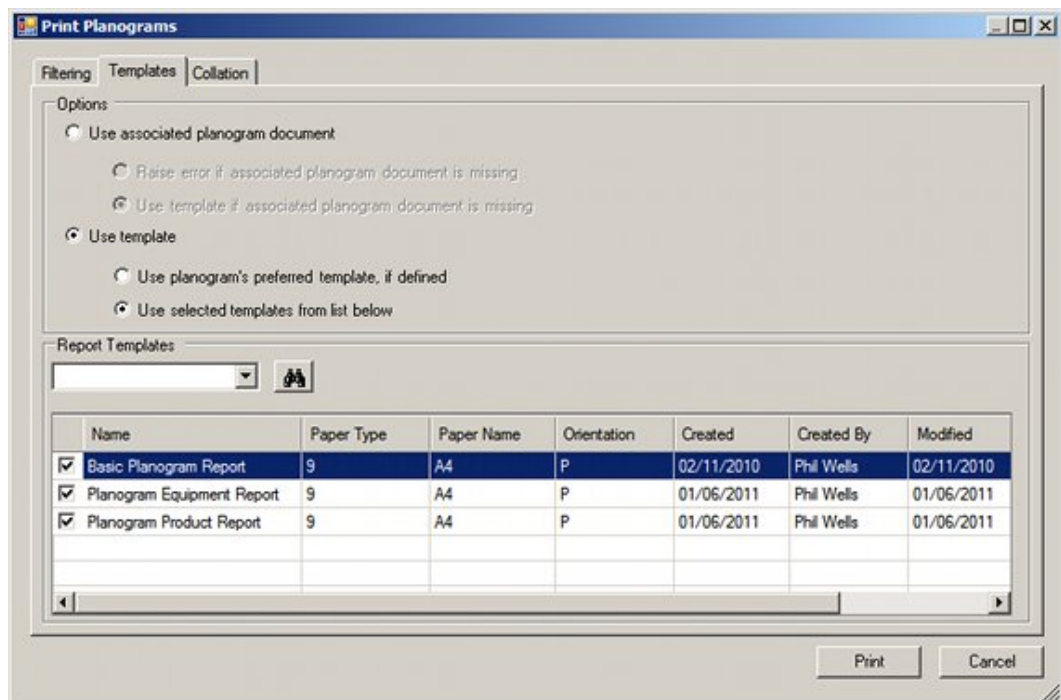

In-Store Space Collaboration

The settings for Planogram Printing are set in the dialog box - the default settings being picked up from the Planogram Publishing Configuration dialog box in Admin.

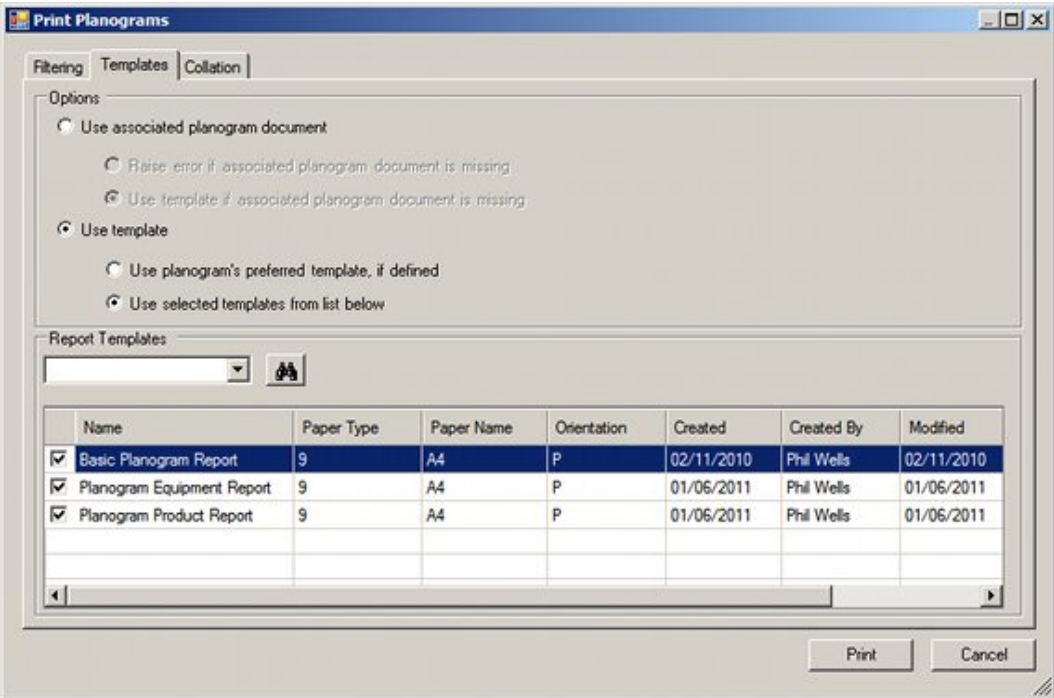

Opening Window

Report Designer will open in a blank screen.

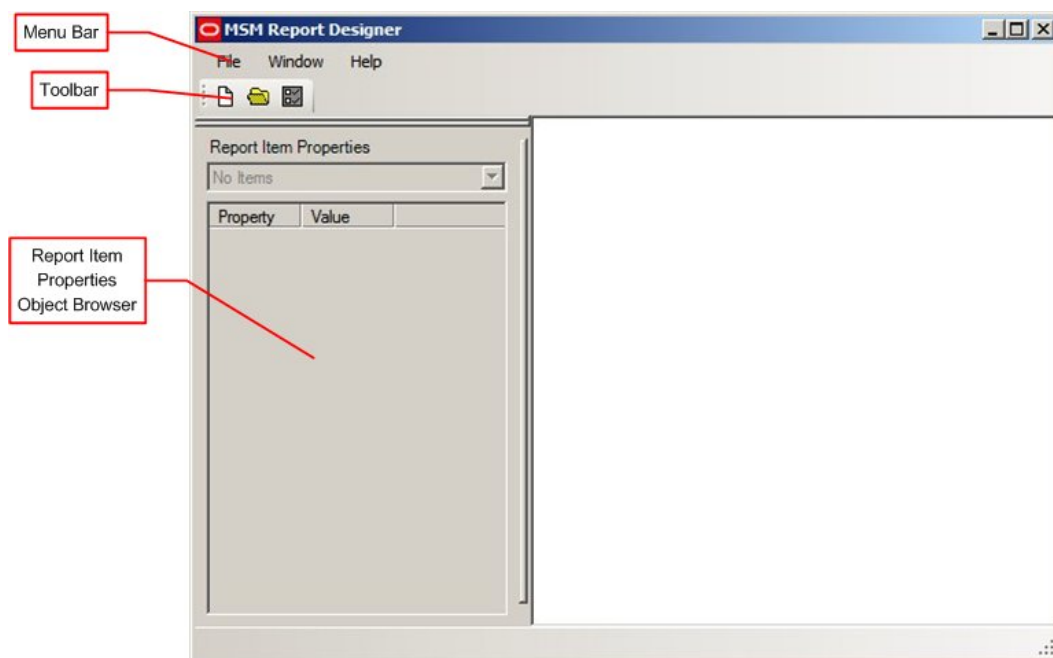

The Menu Bar gives access to some basic options.

The Toolbar gives access to similar options.

Report Item Properties in the Object Browser is not active at this stage.

Menu and Toolbar Options

The **File pull down menu** allows users to create a new report, open an existing one, set some basic preferences or exit the program.

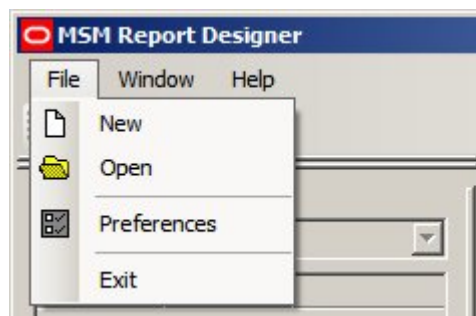

The **Window pull down menu** allows users to tile multiple reports, either horizontally, vertically or in a cascade.

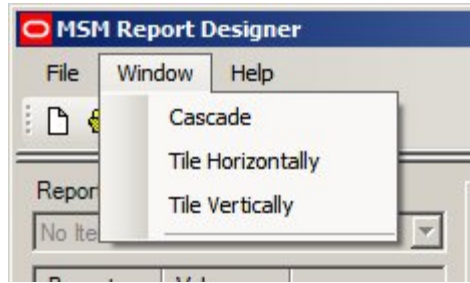

The **Help pull down menu** allows users to access this help file, or to get information on the version of the software.

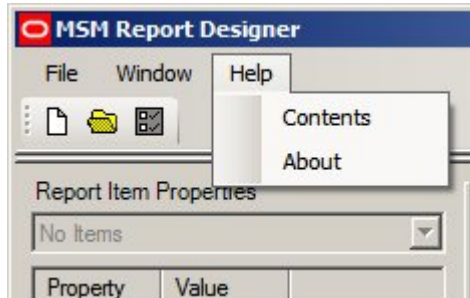

The **Toolbar** allows users to create a new report, open an existing one or set preferences.

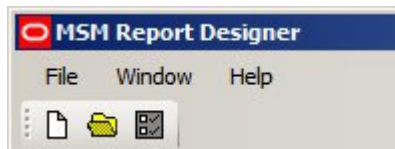

Creating a New Report Template

Creating a New Report

To **Create a New Report**, select the New option from the File pull down menu or select New from the toolbar.



This will bring up the New report dialogue box.

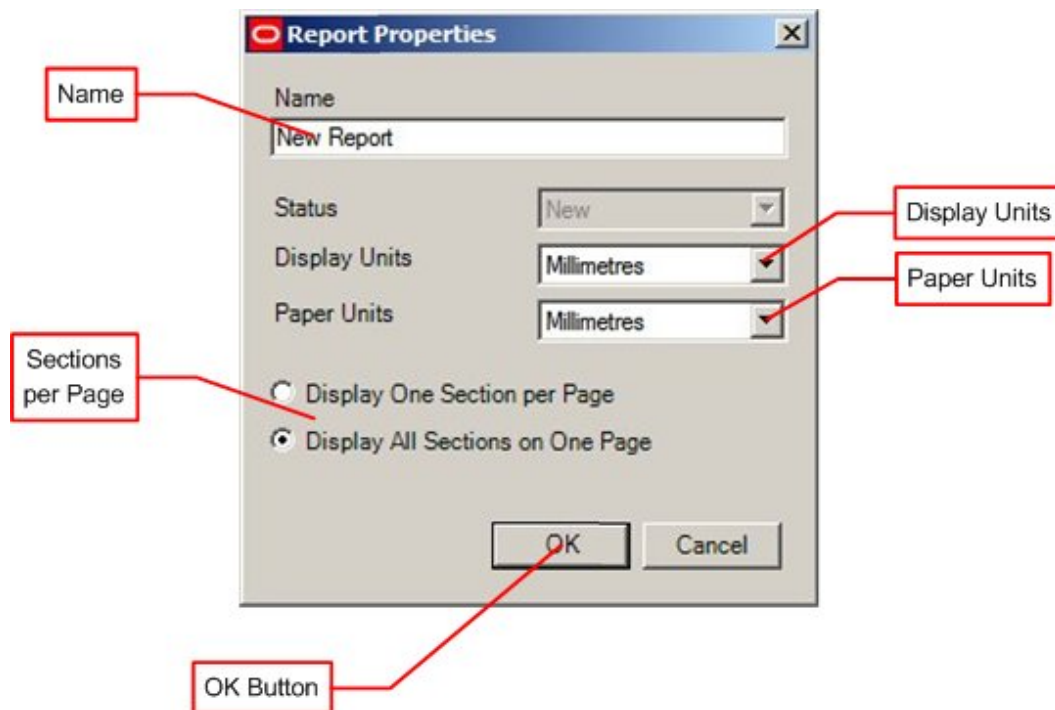

The user can define a **Name** for this Report Layout. This name must be unique. A maximum of 40 characters can be entered.

The **Display Units** will determine the units that are shown in the view objects to indicate the height of shelves, etc. This will display a choice of inches or mm.

The **Paper Units** determine the units for defining the size of the paper and the positions of objects on the paper. This will display a choice of inches or mm.

The **Sections per Page** options determines whether the report will generate a separate page for each section/profile in the planogram, or whether all sections will be shown on a single page. (Example here)

To complete the initial creation process, click on the **OK** button.

This will cause a Report Design dialogue box to appear.

Report Design Dialogue Box

The **Report Design dialogue box** appears within the main Report designer screen.

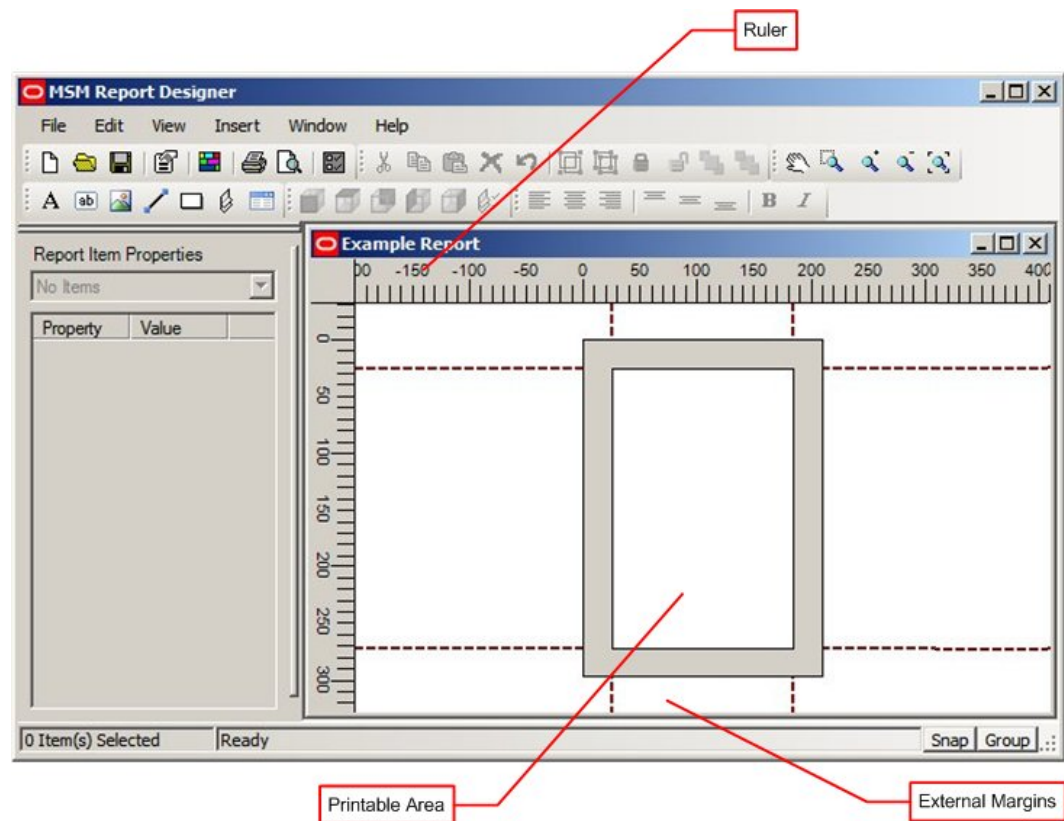

Rulers show the dimensions in the selected units. The units for the rulers will be determined by the Paper Units for the current user. The origin for the rulers will be the top left corner of the page. The rulers will be updated as the page is panned or zoomed.

External Margins are areas outside the area that will be printed. They can be used to hold data not intended for the printed output.

The **Printable Area** is the area inside the thick grey border. Only information inside of this area will be printed.

Page Set Up Options

The Page Set Up for printing can be activated from the File pull down menu.

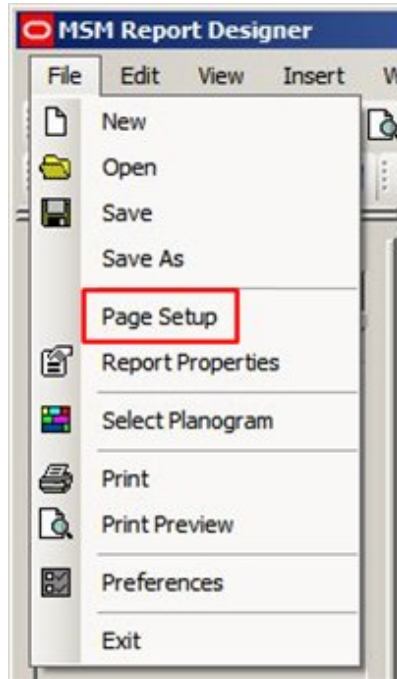

This will bring up the Page Set up dialogue box which allows the page set up to be configured before printing.

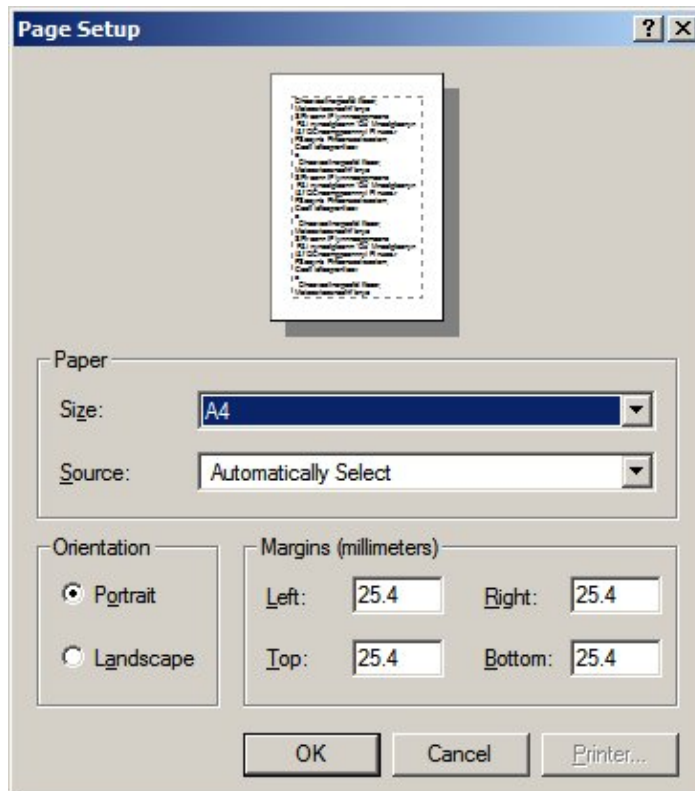

All page setup values will be stored with the report layout, except the *Source* (e.g. Tray). The default values will where possible be derived from the settings for the default printer.

Click on OK once all details have been configured.

Commands

General Commands

The majority of the commands that can be activated by the user are accessible from both the standard menus and from the toolbar. In all cases the operation of the command is identical regardless of how the user activates it.

For all commands, if the current state of the editing environment prevents the operation of that command, it will be disabled. For example, if no items are selected, the Cut or Copy commands will be disabled. Some commands will also change display state to indicate if they are currently in effect or to indicate an item in an operational state.

In all cases, selecting a command before a previous command has completed will cancel the prior command.

Toolbar Only Commands

These commands are only available from the main toolbar and provide quick access to several of the properties for the reporting items. All of these commands will also indicate the current state of the property by displaying the relevant button in a pressed state. The commands only available on the toolbar include:

- Views
- Text Justification
- Text Style

Menus and Toolbars

The full menus and toolbars will appear when a report has been created, or is opened for editing.

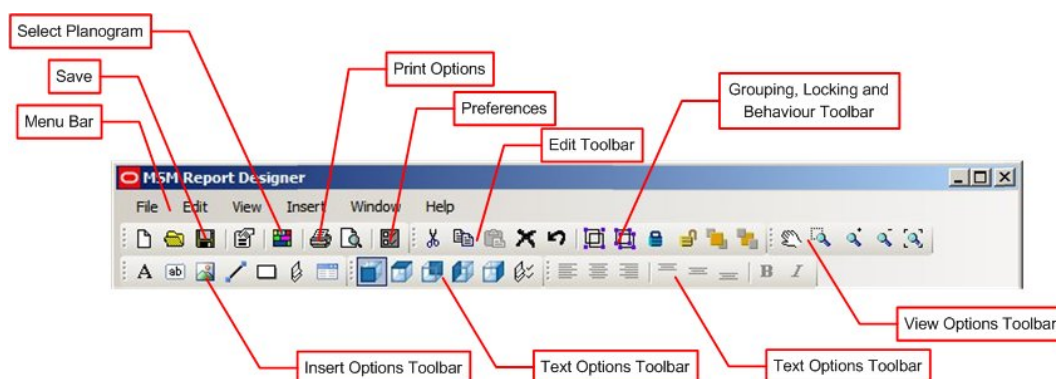

The **Menu Bar** gives access to the varying drop down menus.

The **Report Options** allow users to create, edit and save reports.

The **Select Planogram Option** allows users to select a planogram for the report.

The **Print Options** allow users to print the report.

Preferences allow users to set some personal preferences.

The **Edit Toolbar** gives access to editing options.

The **Grouping, Locking and Behavior Toolbar** allows users to group, lock and move objects in front of or behind others.

The **View Options Toolbar** allows users to change the screen scale and focal point.

The **Insert Options Toolbar** allows users to insert various types of object in the report.







The **View Directions Options Toolbar** allows users to select which direction a planogram is viewed from.

The **Text Options Toolbar** allows text to be justified or changed to bold/italic.

Commands common to Menu Bar and Toolbar

File







The **File commands** allow the user to manipulate report layout documents. Also provided are commands to adjust user preferences and to exit the designer.





Menu	Toolbar	Description
New		This will create a new empty layout document and display the Report Properties dialogue where initial parameters can be defined.
Open		This will display the Report Layouts dialogue allowing a layout to be opened for viewing or editing. If a layout is opened that has a read-only status, then all editing functionality will be disabled. Multiple Report Layouts can be open at any one time and each will be contained in a separate document window.
Save		This will save the layout, either updating the existing definition or adding a new one if this is a new layout.
Save As	None	This will display the Report Properties dialogue, where the user can enter a new name; it will then be saved as a new layout.
Page Setup	None	This will display the Page Setup dialogue. This will allow the report page dimensions and related options to be defined.
Report Properties		This will display the Report Properties dialogue which allows report specific information to be viewed or edited.
Select Planogram		This will display the Select Planogram dialog; this will allow the designer to test the report using real data. If a planogram is loaded like this, it will be used by the editor to represent an example of the planogram during editing. An option will also be provided to load a test planogram, this will be the default planogram when a layout is loaded and will contain generic test data. The Print command will also allow planograms to be loaded.
Print		This will display the Print dialogue to allow the current layout to be printed. The Select Planogram dialog will also be displayed allowing the user to select what to print.
Print Preview		This will display the Print Preview dialogue; this shows an example of the printed report. The report will preview using the currently loaded planogram (see Select Planogram).

Menu	Toolbar	Description
User Preferences		Displays the Options dialog, this allows the user to configure certain aspects of the design environment to their own personal preference.
Exit	None	This will close the application. It will prompt the user to save any pending changes.

Edit





The **Edit commands** allow the user to manipulate the individual items on a report layout.

Menu	Toolbar	Description
Cut		Copies the selected items to the clipboard and removes them from the layout. Any items already on the clipboard will be lost.
Copy		Copies the selected items to the clipboard. Any items already on the clipboard will be lost.
Paste		<p>Copies all items on the clipboard to the current layout. The items will be retained on the clipboard for further use.</p> <p>When items are pasted, they will be placed on the layout at the nearest point to the top left corner of the editing area but will retain their positions relative to each other. All the pasted items will be selected so that they can easily be relocated to the correct position on the layout. Any currently selected items will be automatically de-selected.</p> <p>Note that the clipboard is shared by all open layouts.</p>
Delete		Deletes the selected items from the current document, the items will not be placed on the clipboard.
Undo		<p>Undoes the last change in the current layout document.</p> <p>The undo stack is held per document but can only contain a limited number of undoes. The stack is lost when that layout is closed and is cleared when the layout is saved.</p>
Group		<p>This will group selected objects, giving them a common group.</p> <p>If items are grouped then, provided GROUP option is enabled in the status bar, all items will be selected if just one item in the group is picked.</p> <p>This will enable users to move sections of the report around more easily, by treating them as a single object.</p> <p>Turning the GROUP function off in the status bar will then allow objects to be manipulated singly.</p>
Ungroup		This will ungroup selected objects, reverting them to independent items.

Menu	Toolbar	Description
Lock		This will lock the selected items to prevent them from being edited or deleted. Locked items can still be selected, have their properties inspected and can still be copied to the clipboard. Note that locked items placed on the clipboard will not retain their locked status.
Unlock		This will unlock the selected items, allowing them to be once again moved or deleted
Bring To Front		This will change the display order of the selected items and bring them to the front so that they are not obscured. The selected items will retain their relative display order.
Send to Back		This will change the display order of the selected items and place them behind all other objects. The selected items will retain their relative display order.







View

The **View commands** are used to affect the view of the layout document.

Menu	Toolbar	Description
Pan		This will switch to pan mode. In this mode, clicking and dragging over the editing area will cause the view to scroll with the mouse. Note that this mode will stay active until it is manually deactivated.
Zoom Window		This will prompt the user to zoom into an area of the document defined by a rectangle drawn with the mouse. The area within the rectangle will be magnified to fill the editing area.
Zoom In		This will increase the magnification of the design view by a factor when the mouse is clicked in the design area. The magnification will be centered at the position of the mouse. Note that this mode will stay active until it is manually deactivated.
Zoom Out		This will decrease the magnification of the design view by a factor when the mouse is clicked in the design area. The magnification will be centered at the position of the mouse. Note that this mode will stay active until it is manually deactivated.
Zoom Extents		This will make the entire layout document page fit into the design area. If any parts of the layout are off the actual page area, these will be included. An extra padding margin will also be included to aid visual clarity.

Insert

The **Insert** commands are used to add the reporting items to the layout.

Menu	Toolbar	Description
Label		<p>This will add a text label object to the current document, the cursor will be changed and the user prompted to mark out the bounds of the label.</p> <p>The label when added will contain a default text string that is the same as the control name.</p>
Field		<p>This will add a field object to the current document, the cursor will be changed and the user prompted to mark out the bounds of the field.</p> <p>A dialog will then be displayed allowing the user to select the data source (held in the database) for the field.</p>
Image		<p>This will add an image object to the current document, the cursor will be changed and the user prompted to mark out the bounds of the image.</p> <p>A dialog will then be displayed allowing the user to select the source for the image. The image can be any of the following formats: BMP, GIF, PNG, JPEG.</p> <p>The image will be scaled to fit the bounds but will not maintain its aspect ratio.</p> <p>Note that the image must reside on a network accessible path that can be resolved by the server for the client versions.</p>
Line		<p>This will add a line object to the current document, the cursor will be changed and the user prompted to mark out the line.</p>
Rectangle		<p>This will add a rectangle object to the current document, the cursor will be changed and the user prompted to mark out the bounds of the rectangle.</p>
View		<p>This will add a planogram view diagram to the document, the cursor will be changed and the user prompted to mark out the bounds of the view.</p> <p>The diagram will default to a front view, but the user can change the view direction by pressing the appropriate button on the toolbar, or selecting the required option from the dropdown list in the Properties panel.</p> <p>By default a new view item will not include any extra information, to configure the view, use the Planogram View Properties.</p>
Table		<p>This will add a data table item to the current document, the cursor will be changed and the user prompted to mark out the bounds of the table.</p> <p>Once the table bounds have been defined, the table data dialogue will be displayed where the user can define the source for the data and how it is represented.</p>

Window

The **Window menu** is used to alter the way in which the document windows are arranged in the main editing area.

Menu	Toolbar	Description
Tile Horizontally	None	This will tile the open document windows vertically down the editing area. Each window will be stretched to fill the full width of the area.
Tile Vertically	None	This will tile the open document windows horizontally across the editing area. Each window will be stretched to fill the full height of the area.
Cascade	None	This will cascade the open document windows within the editing area. Each window will be positioned slightly down and to the right of the top-left corner of the previous one.
Document 1	None	A menu item will be included in the Window menu for each open document. This actual menu item text will be the name of the document contained in that window; this will also be used for the title of the window. Selecting the menu option will select that document; this will make it the currently active one and display it on top of other document windows. The main designer window will also include the title of the active document within its title bar.

Help





The **Help menu** provides information about the software.

Menu	Toolbar	Description
Contents	None	This will display the help contents page for the report designer.
About...	None	This will display the About dialog. This contains the software version as well as some other items of information.

Toolbar Only Commands

Views







These toolbar buttons will only be enabled if a Planogram View item is selected they allow the view direction and properties of a planogram diagram to be changed.

Toolbar	Description
	Views the planogram from the Top.
	Views the planogram from the Front.
	Views the planogram from the Back.
	Views the planogram from the Left.
	Views the planogram from the Right.

Toolbar	Description
	Opens the Planogram View dialog allowing the view properties to be edited.



Text Justification

These toolbar buttons will only be enabled if one or more Label or Field items are selected. The buttons will act as radio buttons, split into two groups: horizontal and vertical.

Toolbar	Description
	Aligns text to the left.
	Aligns text to the horizontal center.
	Aligns text to the right.
	Aligns text to the top.
	Aligns text to the vertical center (Middle).
	Aligns text to the bottom.

Text Style

These toolbar commands are used to change the text style of Label and Field items.

Toolbar	Description
	Toggles the Bold text style on and off.
	Toggles the Italic text style on and off.

Designing the Report Template

There are seven types of objects that can be added to the report being designed. These are selected from the Insert pull down menu or from the Insert toolbar.

Both sets of options work in an identical manner.

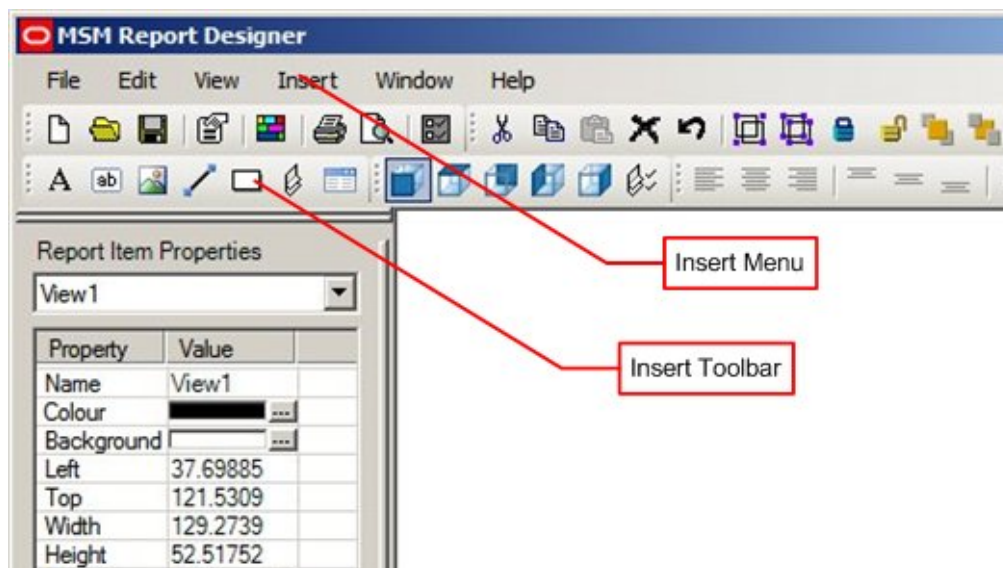

Overview of Report Item Properties



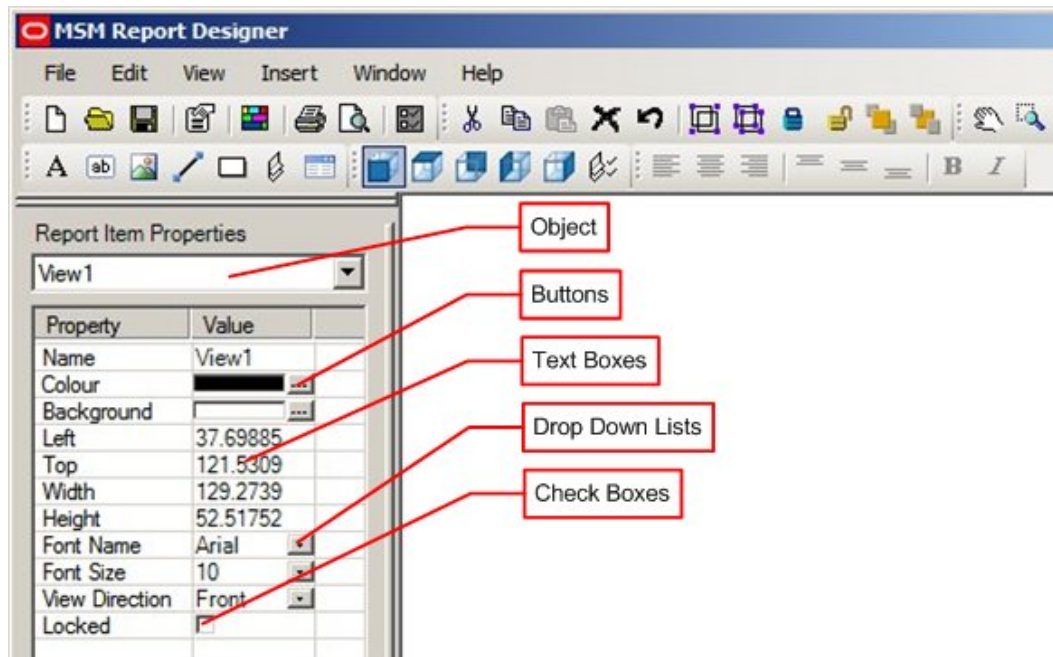



Report Item Properties will be found on the left of the screen. It allows any of the seven types of object that can be placed in the report to be customized.



The Object to be edited can be selected from a drop down list.
 Buttons give access to some editing options.
 Typing into Text Boxes allows other options to be customized.
 Drop down lists allow other options to be customized.
 Check boxes allow options to be turned on or off.

Insert

The **Insert** commands are used to add the reporting items to the layout.

Menu	Toolbar	Description
Label		This will add a text label object to the current document, the cursor will be changed and the user prompted to mark out the bounds of the label. The label when added will contain a default text string that is the same as the control name.
Field		This will add a field object to the current document, the cursor will be changed and the user prompted to mark out the bounds of the field. A dialog will then be displayed allowing the user to select the data source for the field.
Image		This will add an image object to the current document, the cursor will be changed and the user prompted to mark out the bounds of the image. A dialog will then be displayed allowing the user to select the source for the image. The image can be any of the following formats: BMP, GIF, PNG, JPEG. The image will be scaled to fit the bounds but will not maintain its aspect ratio. Note that the image must reside on a network accessible path that can be resolved by the server for the client versions.
Line		This will add a line object to the current document, the cursor will be changed and the user prompted to mark out the line.
Rectangle		This will add a rectangle object to the current document, the cursor will be changed and the user prompted to mark out the bounds of the rectangle.
View		This will add a planogram view diagram to the document, the cursor will be changed and the user prompted to mark out the bounds of the view. The diagram will default to a front view, but the user can change the view direction by pressing the appropriate button on the toolbar, or selecting the required option from the drop down list in the Properties panel. By default a new view item will not include any extra information, to configure the view, use the Planogram View Properties.

Menu	Toolbar	Description
Table		This will add a data table item to the current document, the cursor will be changed and the user prompted to mark out the bounds of the table. Once the table bounds have been defined, the table data dialogue will be displayed where the user can define the source for the data and how it is represented.

(See topics below for examples of these objects).

Adding a Label

To Add a Label to the report, click on the Label icon on the insert toolbar.



(Alternatively, select the Label option from the Insert pull down menu).

To add a label, move the cursor to the required start position in the Report Layout Designer. Hold down the left mouse button and drag to form a rectangle.

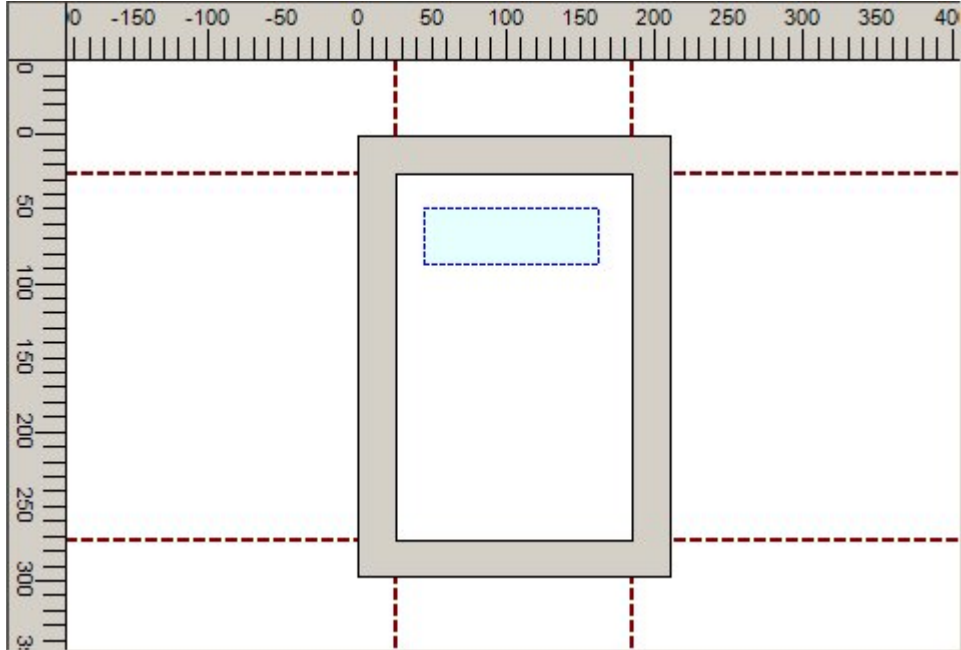

When the left hand mouse button is released, a rectangle will be drawn containing the initial name of the label.

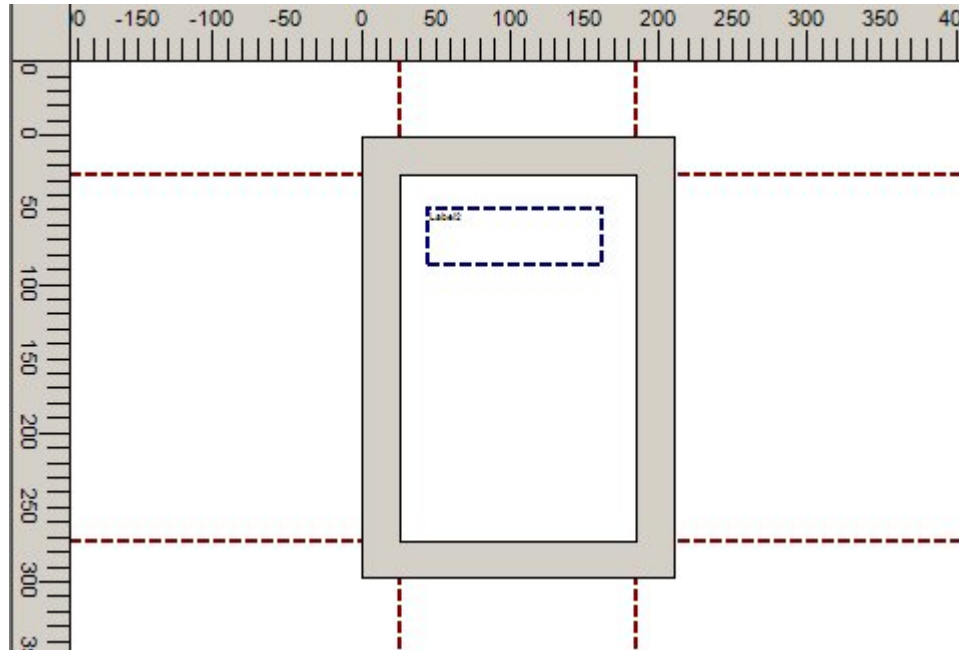

The varying properties of the Label can then be edited in the Report Item Properties Object Browser.

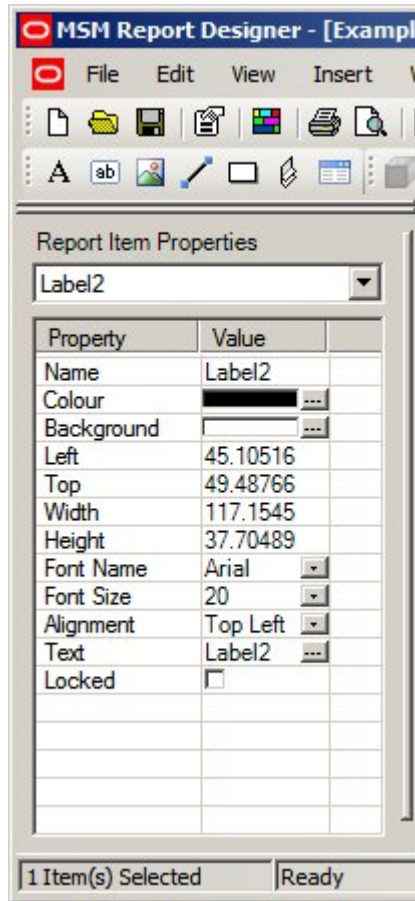

Name is what the label is called in the drop down list. It can be edited by typing in a different value, or the default value can be used.

Color is the color of the border of the label. It can be changed by clicking on the button and selecting a new color from the pallet that appears.

Background is the color of the background of the label. It can be changed by clicking on the button and selecting a new color from the pallet that appears.

Left, Top, Width and **Height** allow the position and size of the rectangle containing the label to be changed. They can be edited by typing in different values.

Font Name and **Font Size** can be changed by selecting new values from the drop down list.

Alignment can be changed from the drop down list. Alternatively, it can be changed using the alignment options on the toolbar.

Text is the text that will be displayed in the printed report. This must be set at design time.

Checking **Locked** means this item cannot be deleted.

Adding a Field

To **Add a Field** to the report, click on the Label icon on the insert toolbar.

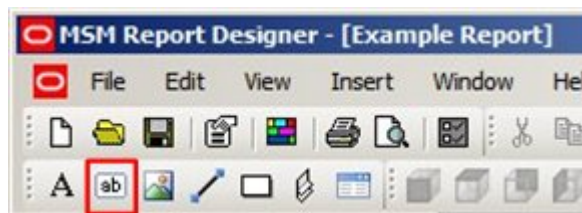

(Alternatively, select the Field option from the Insert pull down menu).

To add a field, move the cursor to the required start position in the Report Layout Designer. Hold down the left mouse button and drag to form a rectangle.

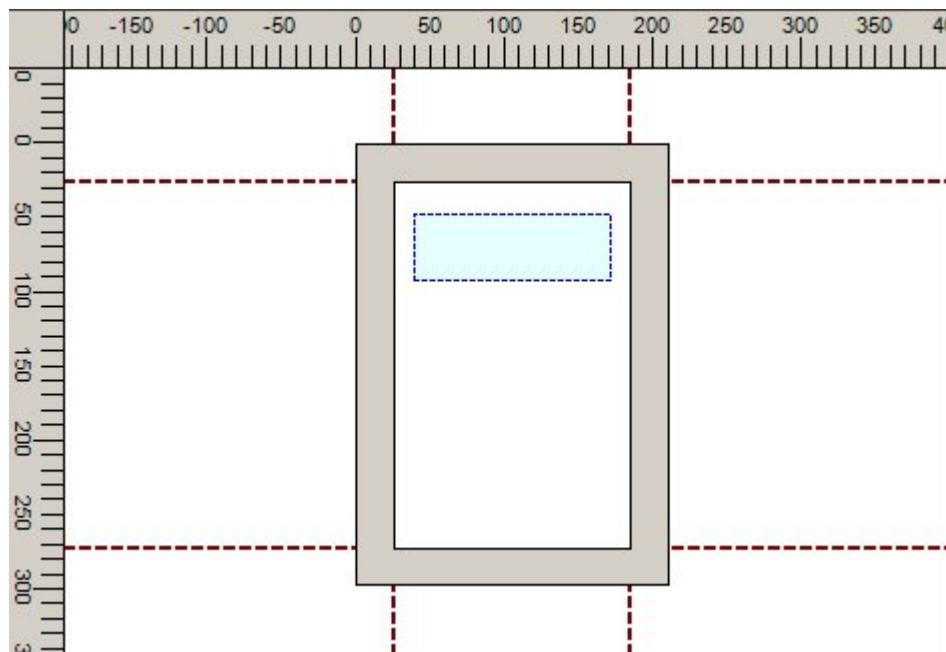

When the left hand mouse button is released, the Select Data Source dialogue box will appear.

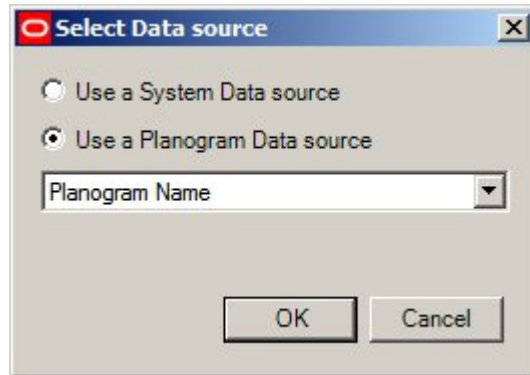

Select the name of the required field by means of the radio button and drop down lists.

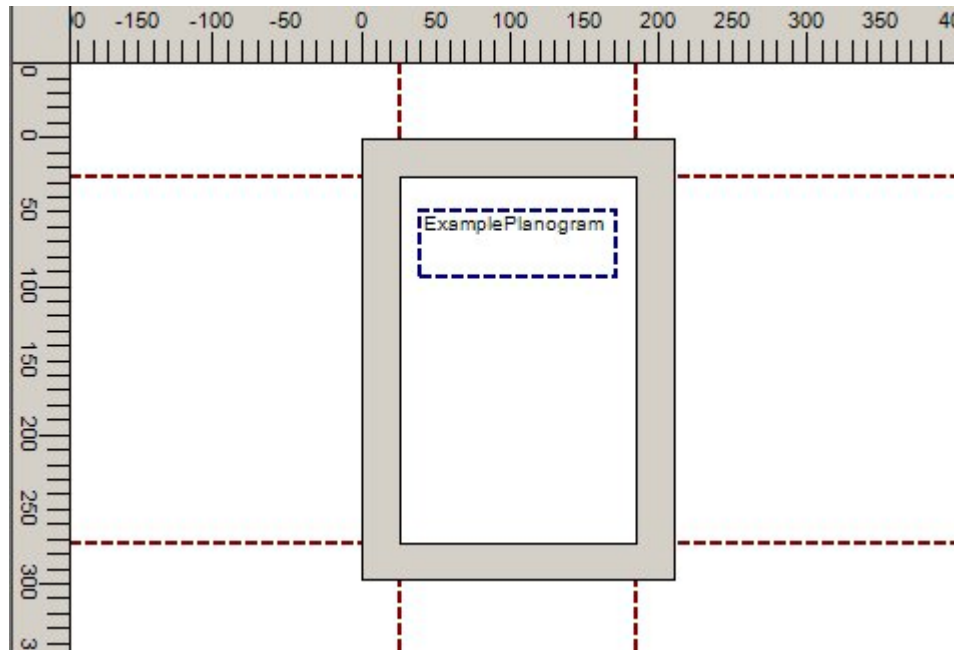

The varying properties of the Field can then be edited in the Report Item Properties Object Browser.

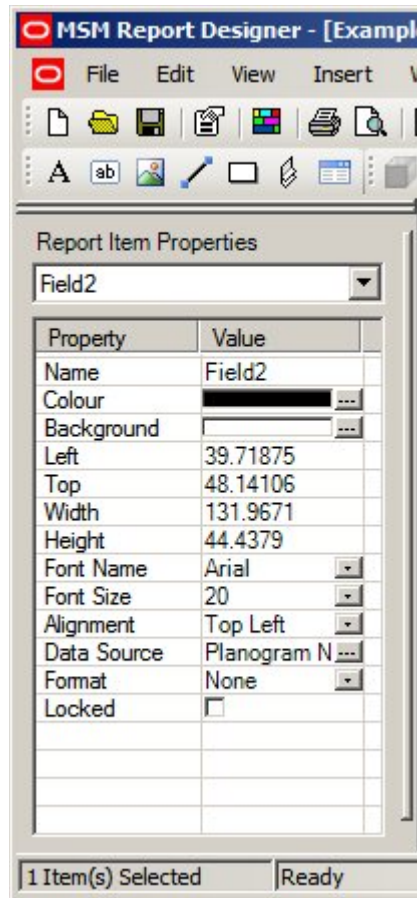

Name is what the label is called in the drop down list. It can be edited by typing in a different value.

Color is the color of the border of the label. It can be changed by clicking on the button and selecting a new color from the pallet that appears.

Background is the color of the background of the label. It can be changed by clicking on the button and selecting a new color from the pallet that appears.

Left, Top, Width and **Height** allow the position and size of the rectangle containing the label to be changed. They can be edited by typing in different values.

Font Name and **Font Size** can be changed by selecting new values from the drop down list.

Alignment can be changed from the drop down list. Alternatively, it can be changed using the alignment options on the toolbar.

Data Source can be changed by clicking on the button. It allows the label selected in the Select Data Source dialogue box to be changed.

Format allows the form of the selected field to be changed. For example, Planogram Names could be changed from capitalized to uppercase.

Checking **Locked** means this item cannot be deleted.

Adding an Image

To **Add an Image** to the report, click on the Image icon on the insert toolbar.

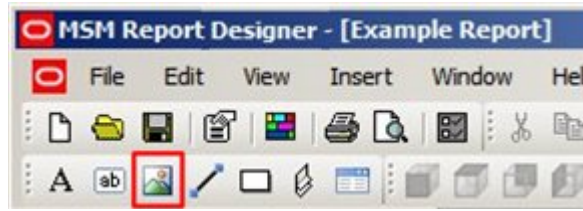

(Alternatively, select the Image option from the Insert pull down menu).

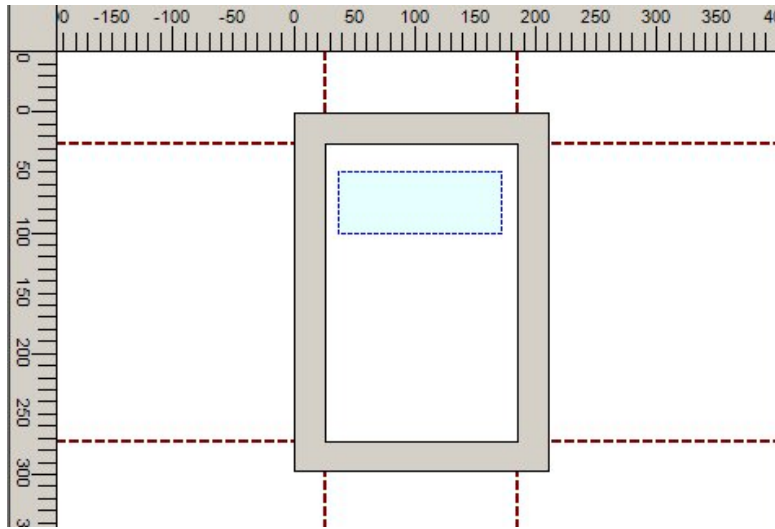

To add an image, move the cursor to the required start position in the Report Layout Designer. Hold down the left mouse button and drag to form a rectangle. When the left hand mouse button is released, the Select Data Source dialogue box will appear.

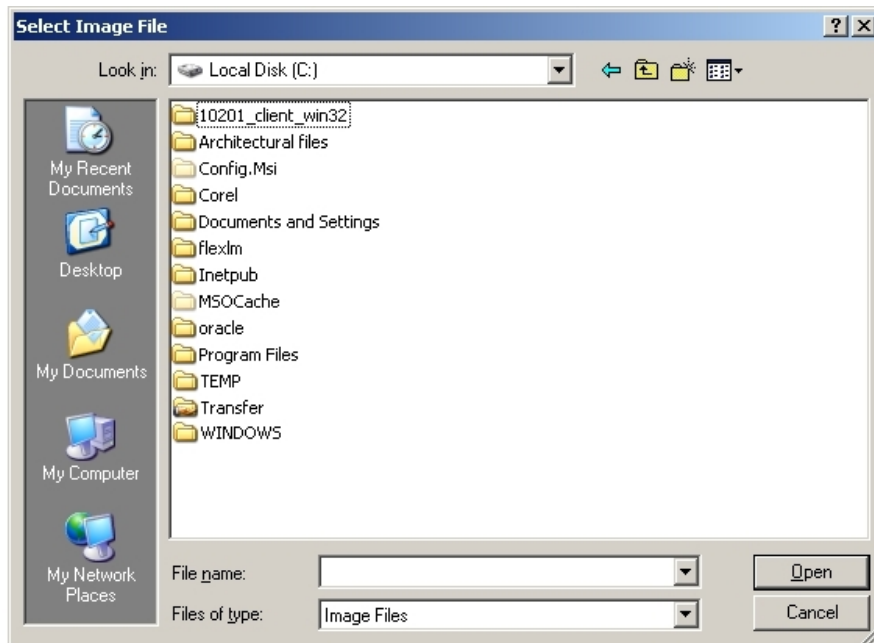

Select the name of the required image by means of the radio button and drop down lists.

Note: the image must reside on a network accessible path that can be resolved by the server for the client versions.

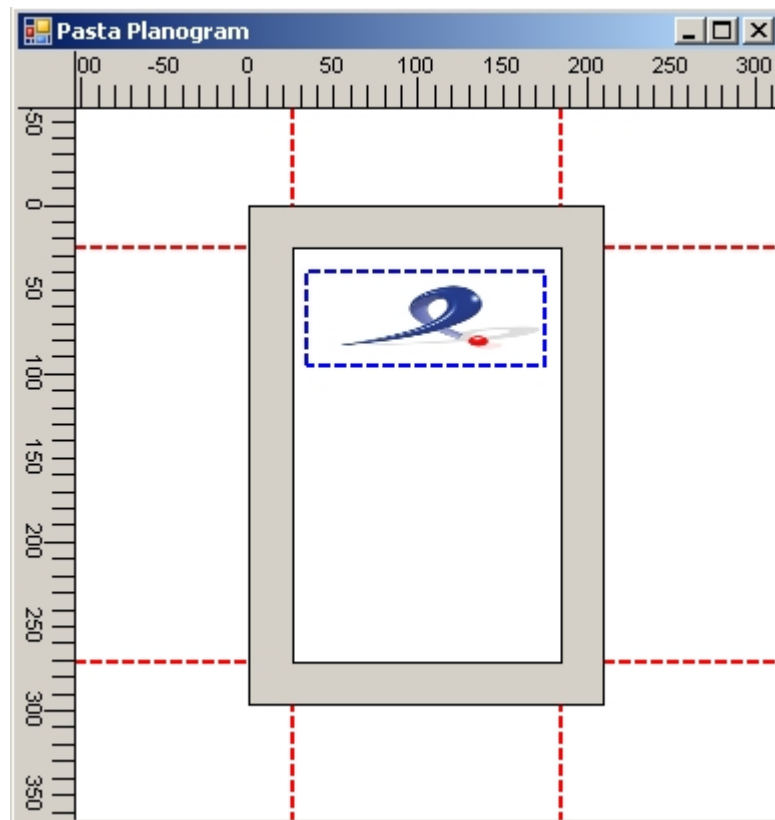

The selected Image will then appear in the report.

It will be scaled to fit the bounds but will not maintain its aspect ratio.

The varying properties of the Image can then be edited in the Report Item Properties Object Browser.

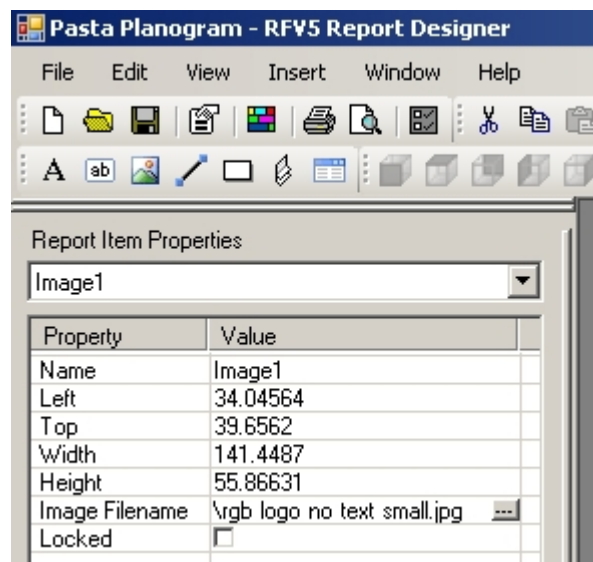

Name is what the label is called in the drop down list. It can be edited by typing in a different value.

Left, Top, Width and **Height** allow the position and size of the rectangle containing the label to be changed. They can be edited by typing in different values.

Font Name and **Font Size** can be changed by selecting new values from the drop down list.

Image Filename allows a different image to be selected.

Checking **Locked** means this item cannot be deleted.

Adding a Line

To **Add a Line** to the report, click on the Line icon on the insert toolbar.



(Alternatively, select the Line option from the Insert pull down menu).

To add a Line, move the cursor to the required start position in the Report Layout Designer. Hold down the left mouse button and drag to form a rectangle.

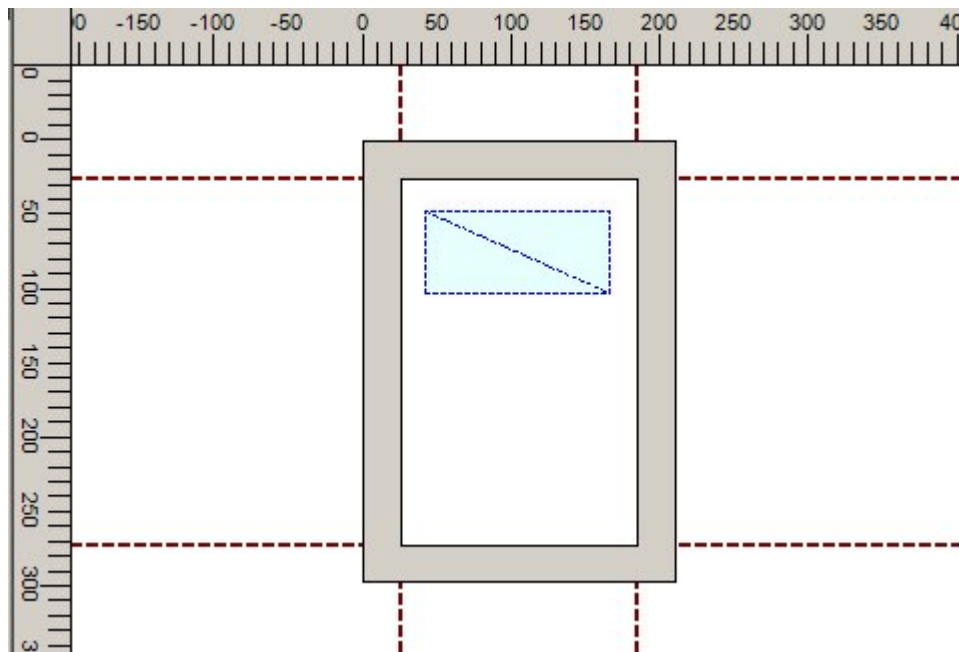

When the left hand mouse button is released, a line will be drawn from the first corner to the opposite corner of the rectangle.

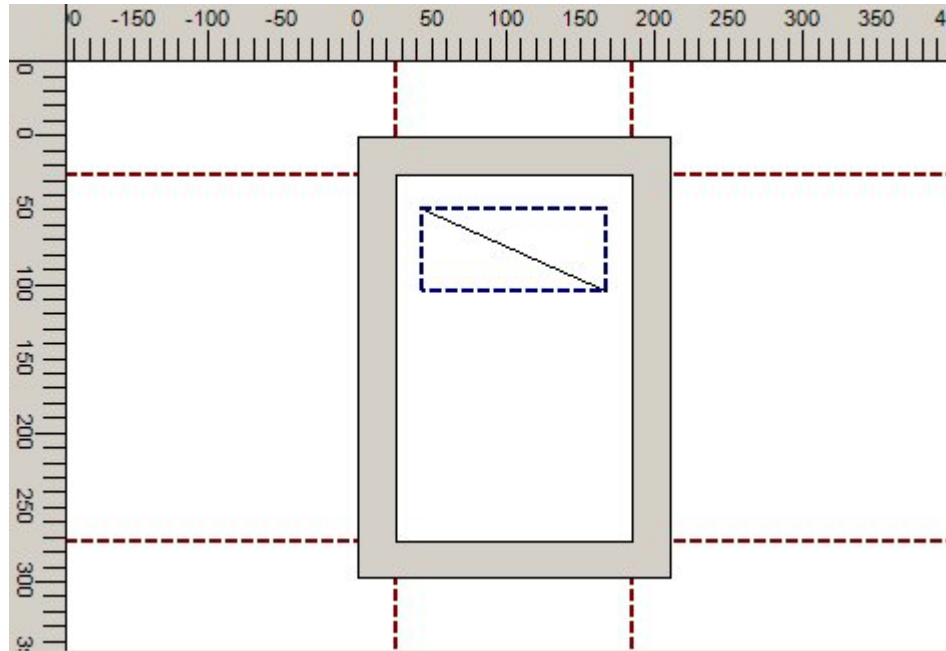

(If a horizontal or vertical line is drawn, no rectangle will appear).

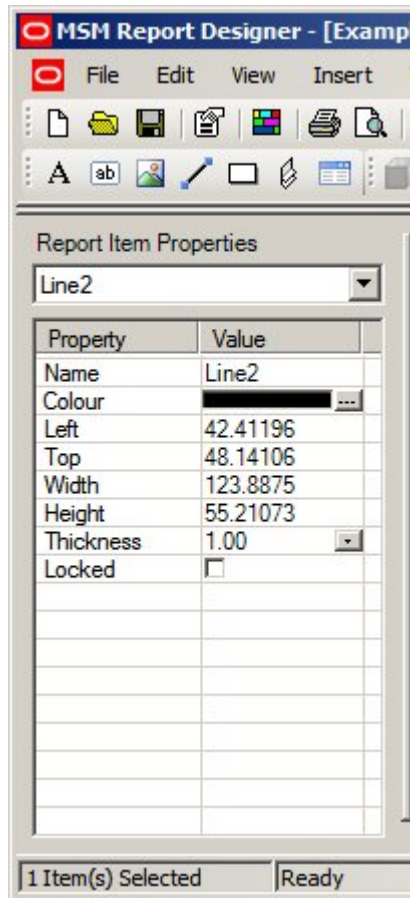

The varying properties of the Line can then be edited in the Report Item Properties Object Browser.

Name is what the Line is called in the drop down list. It can be edited by typing in a different value.

Color is the color of the Line. It can be changed by clicking on the button and selecting a new color from the pallet that appears.

Left, Top, Width and **Height** allow the position and size of the Line to be changed. They can be edited by typing in different values.

Thickness is the thickness of the line as drawn. It can be changed by selecting from the drop down list.

Checking **Locked** means this item cannot be deleted.

Adding a Rectangle

To **Add a Rectangle** to the report, click on the Rectangle icon on the insert toolbar.

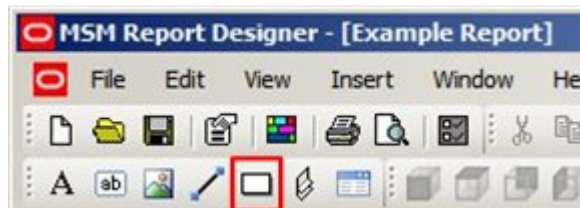

(Alternatively, select the Rectangle option from the Insert pull down menu).

To add a Rectangle, move the cursor to the required start position in the Report Layout Designer. Hold down the left mouse button and drag to form a rectangle.

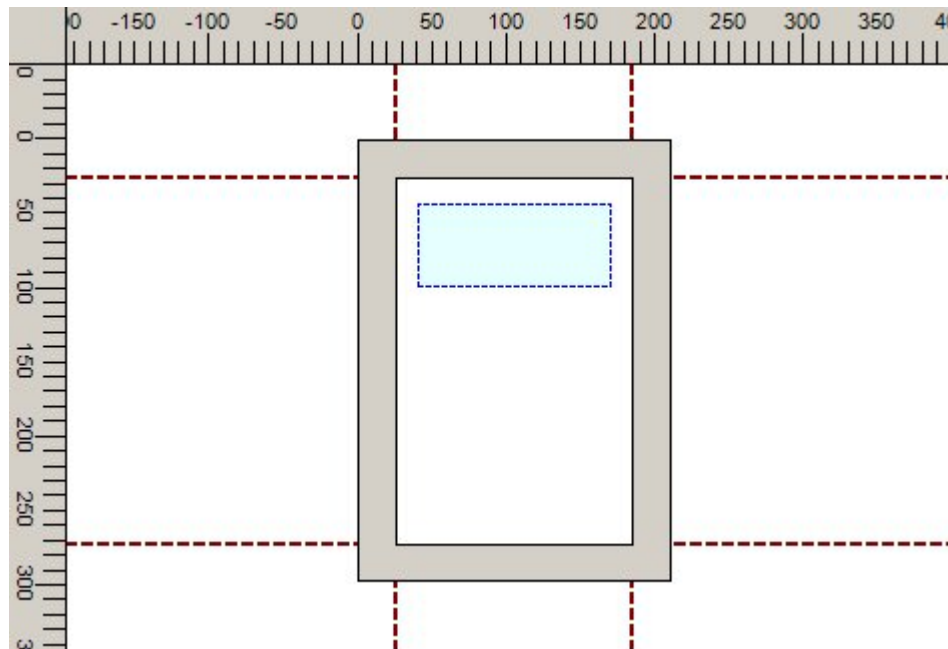

When the left hand mouse button is released, a rectangle will be drawn.

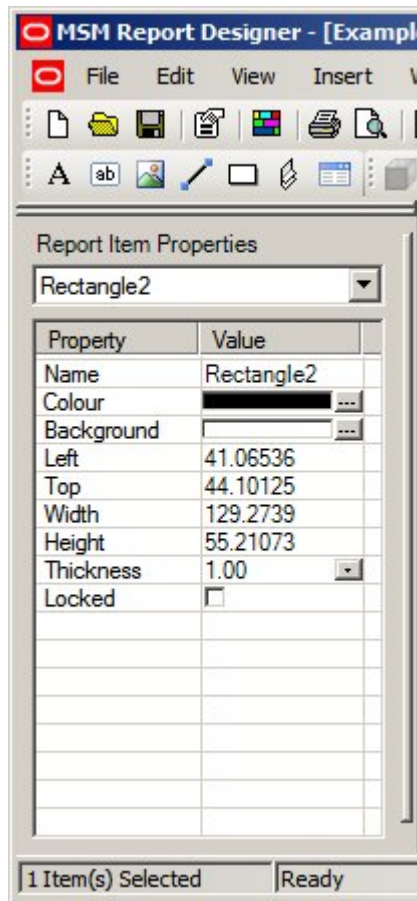
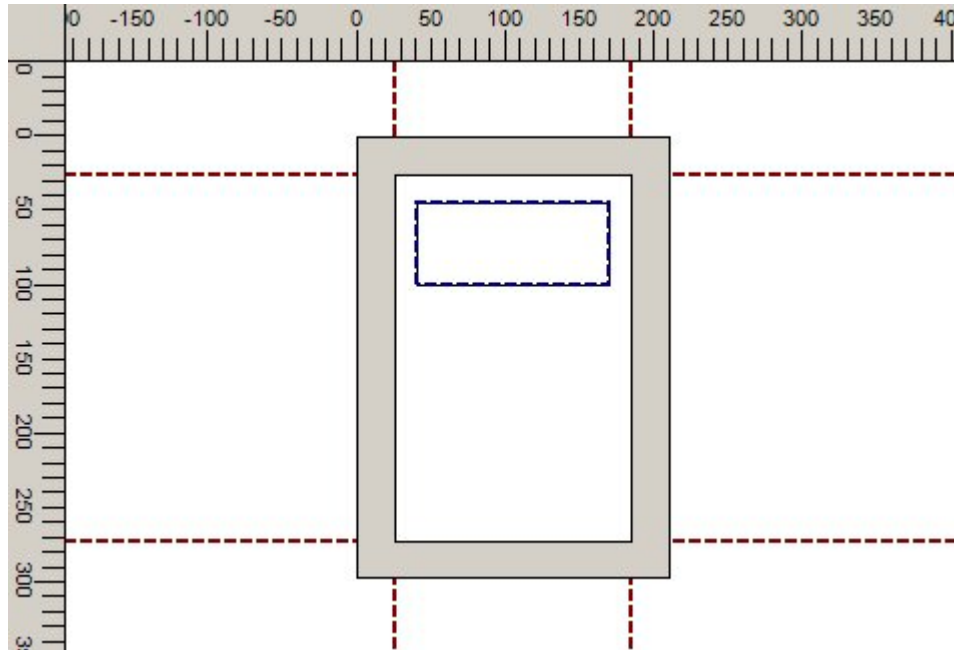

The varying properties of the Rectangle can then be edited in the Report Item Properties Object Browser.

Name is what the Rectangle is called in the drop down list. It can be edited by typing in a different value.

Color is the color of the border of the Rectangle. It can be changed by clicking on the button and selecting a new color from the pallet that appears.

Background is the color of the background of the Rectangle. It can be changed by clicking on the button and selecting a new color from the pallet that appears.

Left, Top, Width and **Height** allow the position and size of the rectangle containing the Rectangle to be changed. They can be edited by typing in different values.

Thickness is the thickness of the line as drawn. It can be changed by selecting from the drop down list.

Checking **Locked** means this item cannot be deleted.

Adding a View

To **Add a View** to the report, click on the View icon on the insert toolbar.

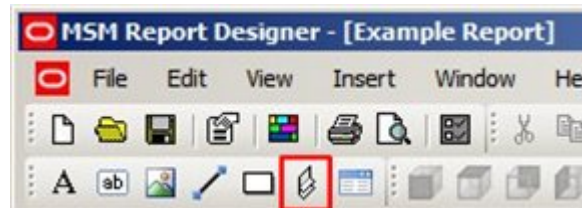

(Alternatively, select the View option from the Insert pull down menu).

To add a View, move the cursor to the required start position in the Report Layout Designer. Hold down the left mouse button and drag to form a View.

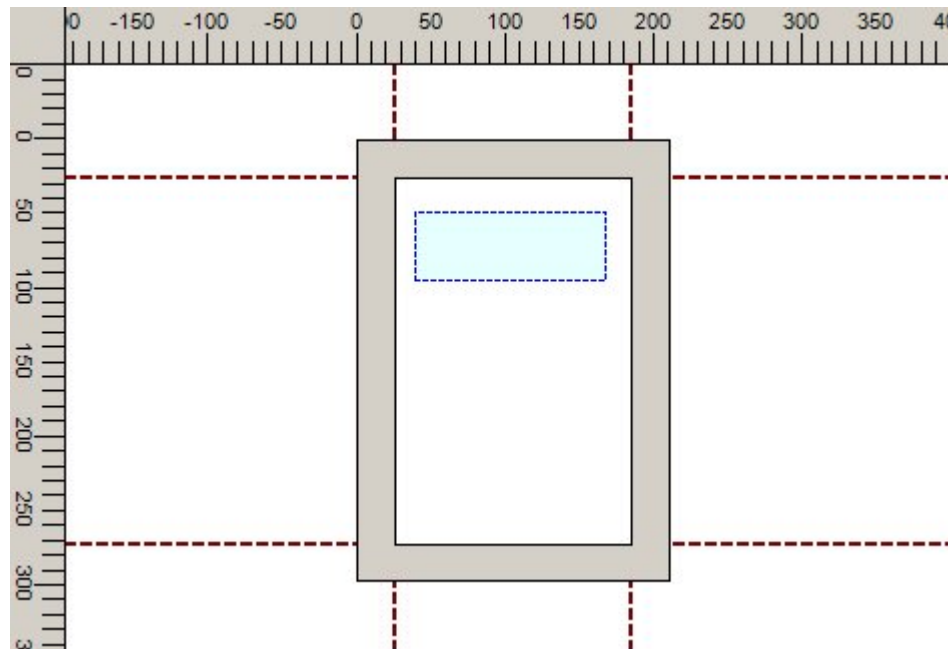

When the left hand mouse button is released, a View will be drawn.

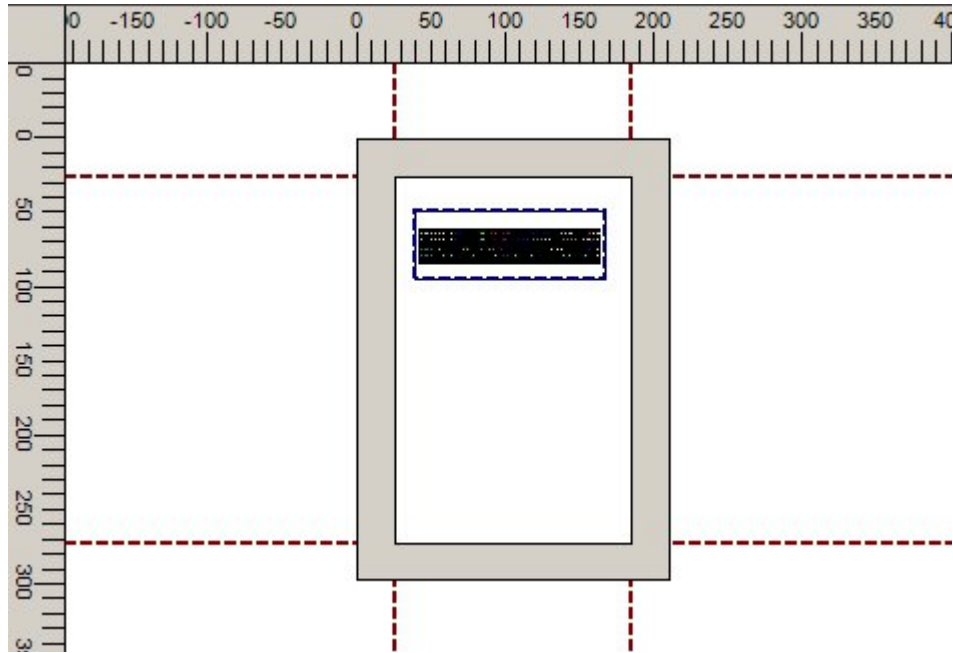

This view contains a dummy image. To add a planogram from the Oracle database, click on the Select Planogram option.



This will bring up the Select Planogram dialog box.

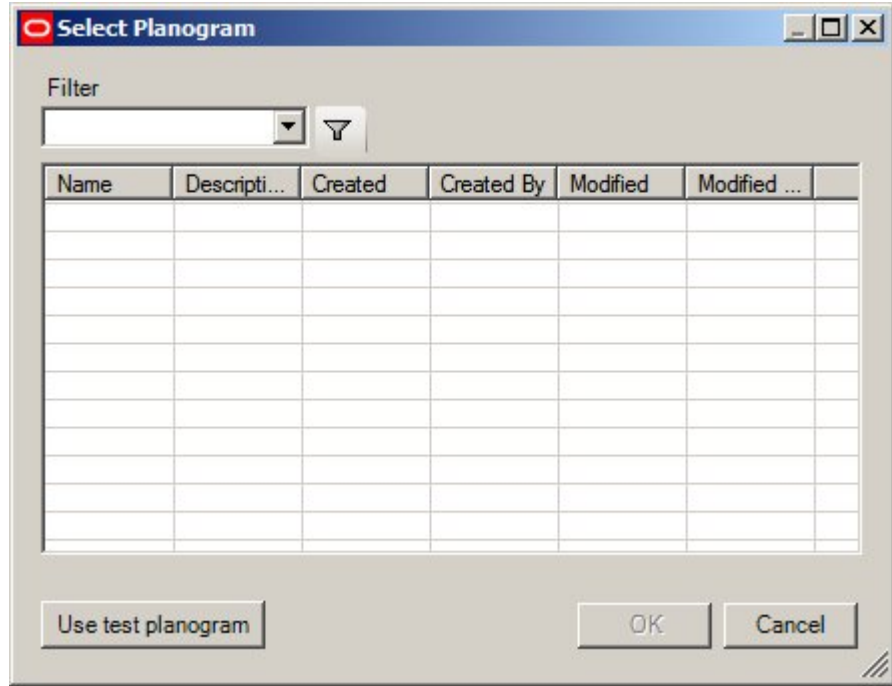

Note: Ensure the filter is set. If there is no filter criteria set, then all available planograms will be displayed in the list. If there is a large number of planograms in the database, the software may stop responding.

Set the filter criteria, click on the filter icon, then highlight a planogram in the list of those available. Click on the OK button and the planogram will be added to the view.

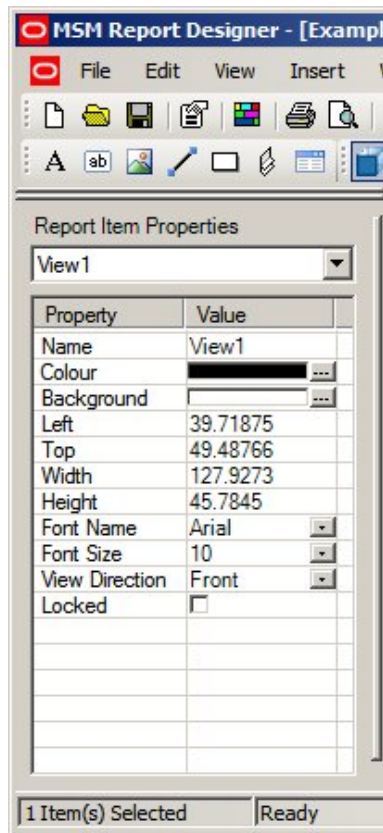
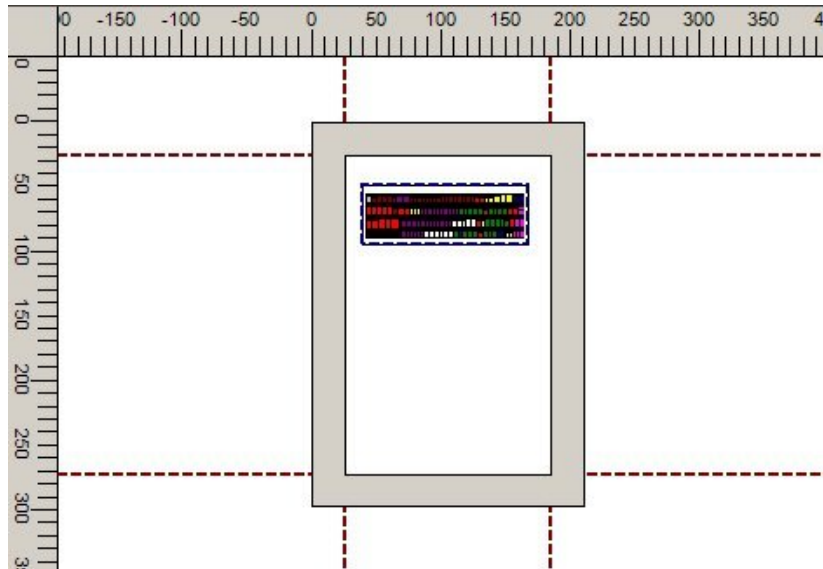

The varying properties of the View can then be edited in the Report Item Properties Object Browser.

Name is what the View is called in the drop down list. It can be edited by typing in a different value.

Color is the color of the border of the View. It can be changed by clicking on the button and selecting a new color from the pallet that appears.

Background is the color of the background of the View. It can be changed by clicking on the button and selecting a new color from the pallet that appears.

Left, Top, Width and **Height** allow the position and size of the rectangle containing the View to be changed. They can be edited by typing in different values.

Font Name and **Font Size** can be changed by selecting new values from the drop down list.

View Direction is the current direction the planogram is being viewed from. It can be changed by selecting from the drop down list.

Checking **Locked** means this item cannot be deleted.

Some details of the View can be customized using the Planogram View Options dialogue box available from the View Directions toolbar.

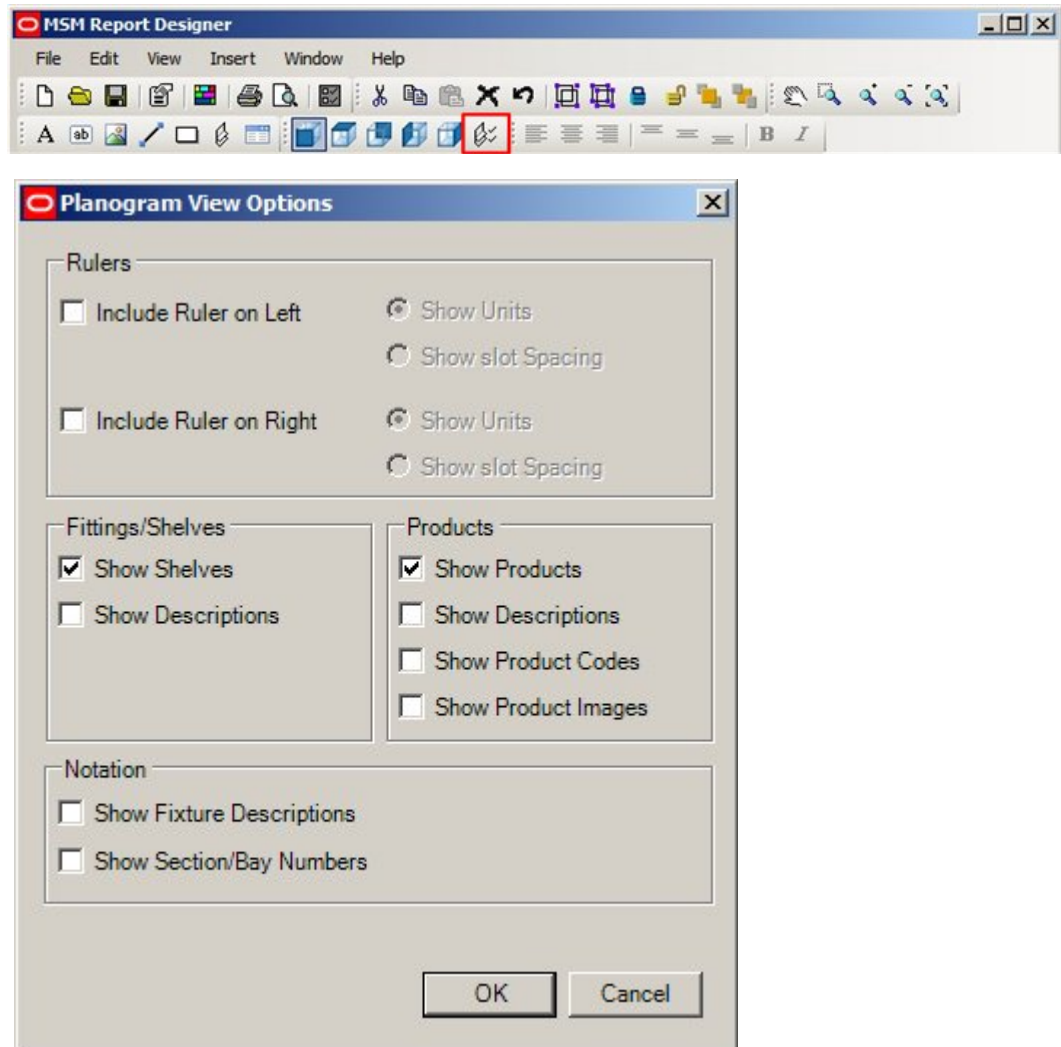

Note: The colors of the Fixtures in the view can be changed by going to Fixture Studio and changing the default color of the fixture. The colors of the Products in the view can be changed by going to Product Studio and changing the default color of the product. This will affect all instances of those fixtures or products. (See Fixture Studio and Product Studio help files for more information).

Working with Views

The **Views Toolbar** allows users to change the direction the planogram is viewed from.



It also allows some annotation of the planogram view.

The example below shows the planogram viewed from the front.

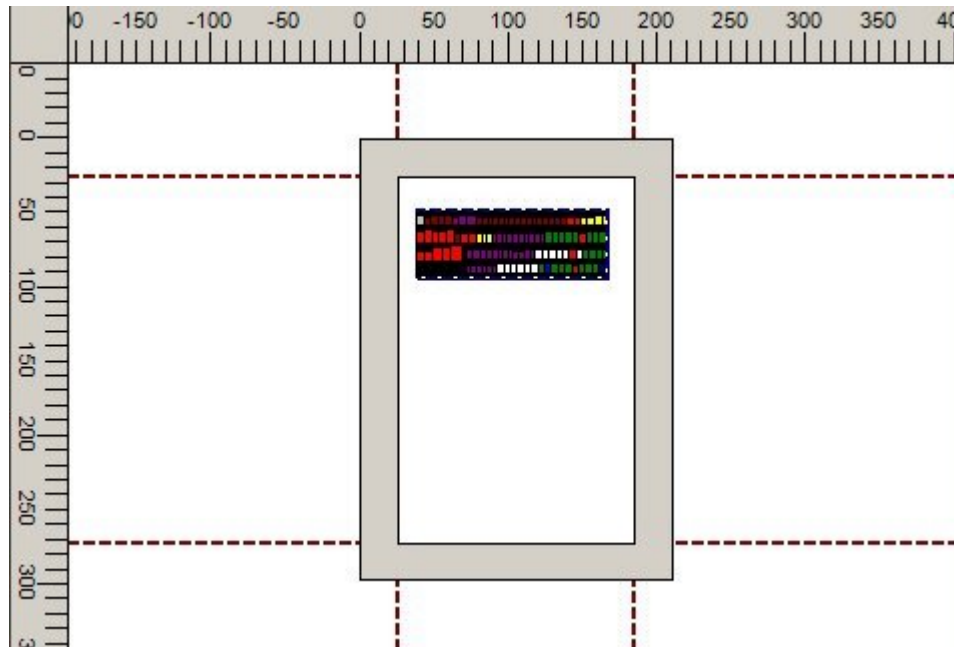

It is also possible to view it from the right using the View Directions toolbar.

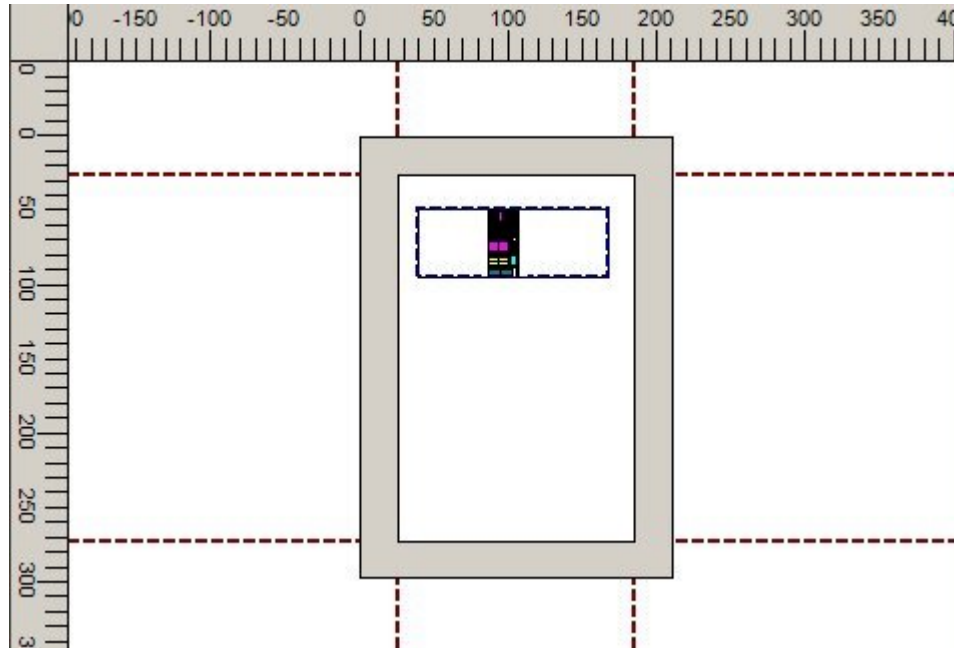

It is also possible to annotate the planogram view with some information. This is done by clicking on the Planogram view option in the Views toolbar.



This will bring up the Planogram View Options dialogue box.

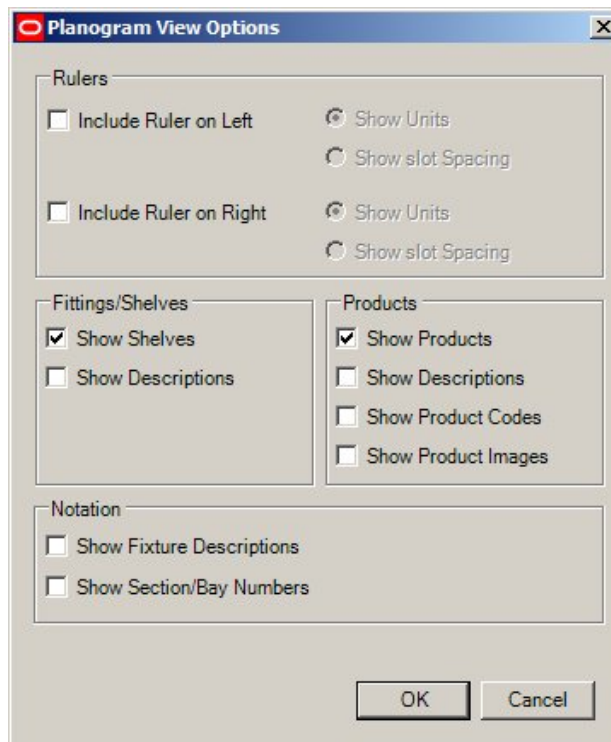

Tick the required options and they will appear in the Planogram view.

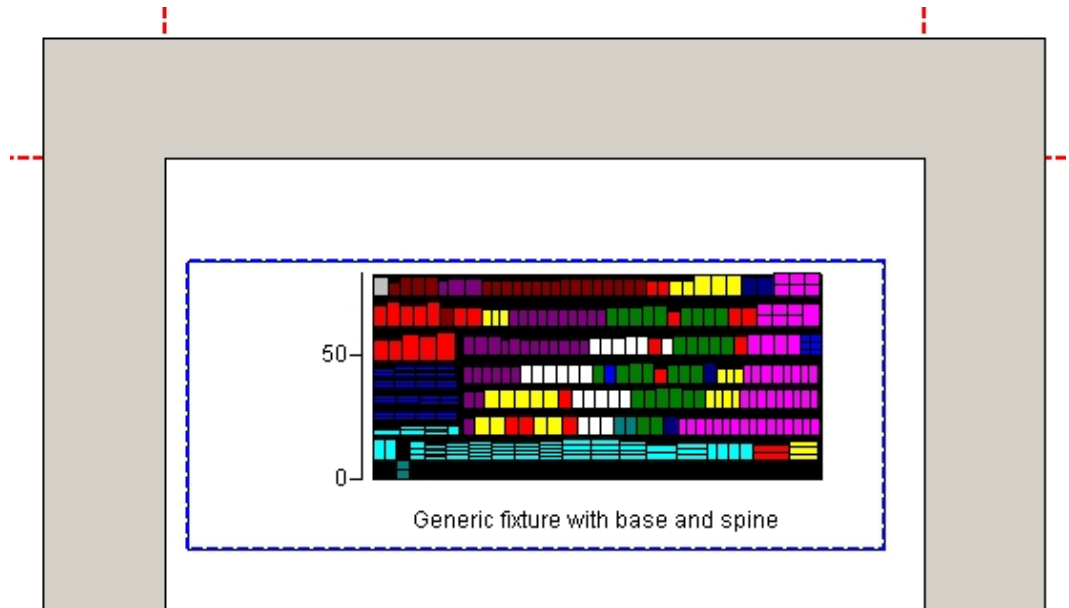

Adding a Table

To Add a Table to the report, click on the Table icon on the insert toolbar.

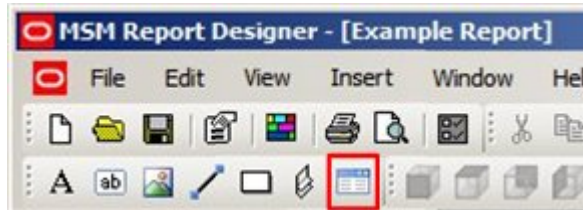

(Alternatively, select the Table option from the Insert pull down menu).

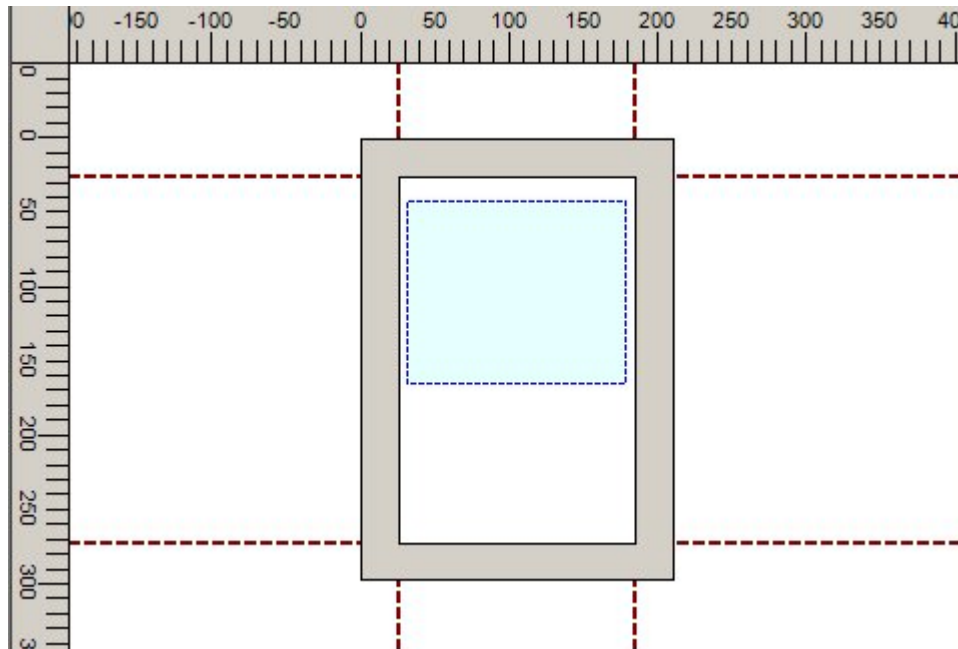

To add a Table, move the cursor to the required start position in the Report Layout Designer. Hold down the left mouse button and drag to form a rectangle.

When the left hand mouse button is released, the Select Data Source dialogue box will appear. This allows the table to be customized.

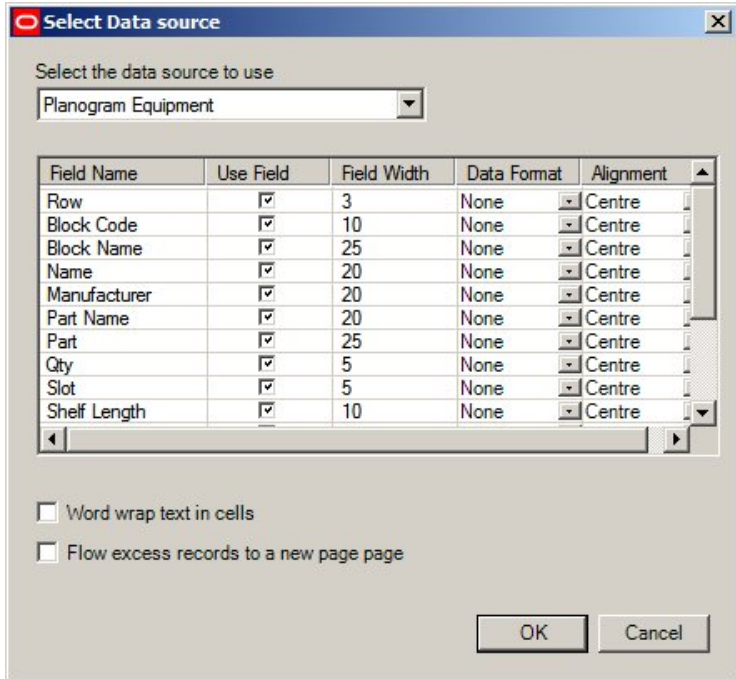

Field Name cannot be altered.

If the **Use Field** check box is ticked, the data will be included in the table.

Field Width can be changed by typing in an alternative value.

Data Format can be changed using the drop down list

Data Alignment within the table can be changed using the drop down list.

When the **OK** button is clicked, the table will appear.

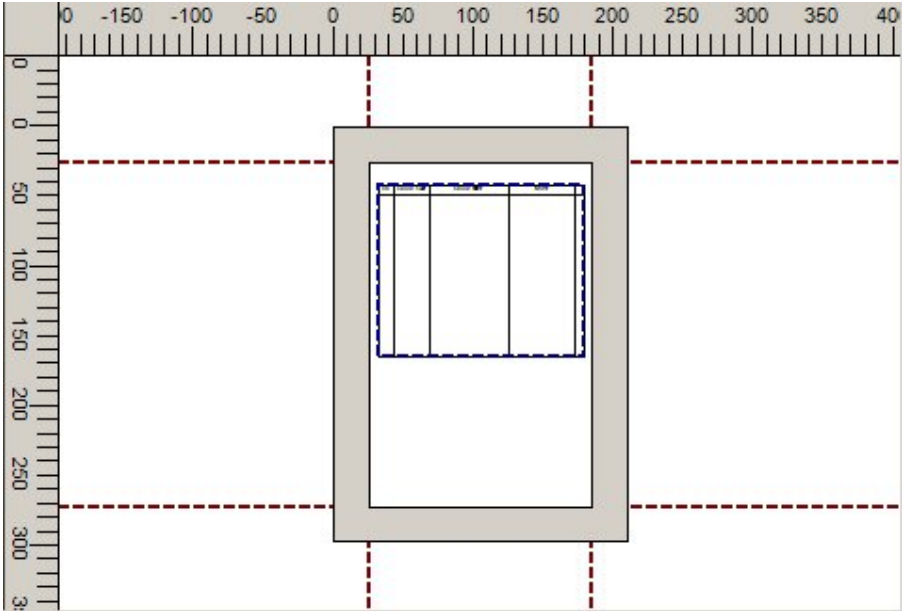

The varying properties of the Table can then be edited in the Report Item Properties Object Browser.

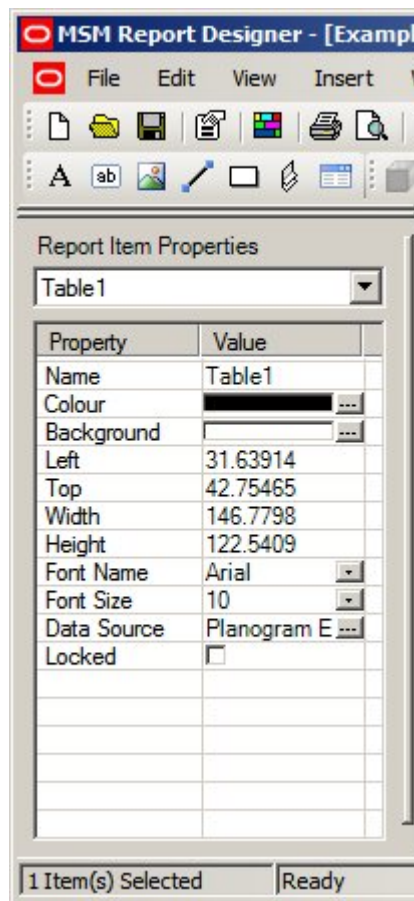

Name is what the Table is called in the drop down list. It can be edited by typing in a different value.

Color is the color of the border of the Table. It can be changed by clicking on the button and selecting a new color from the pallet that appears.

Background is the color of the background of the Table. It can be changed by clicking on the button and selecting a new color from the pallet that appears.

Left, **Top**, **Width** and **Height** allow the position and size of the rectangle containing the Table to be changed. They can be edited by typing in different values.

Font Name and **Font Size** can be changed by selecting new values from the drop down list.

Data Source can be changed from the drop down list.

Checking **Locked** means this item cannot be deleted.

Other Design Options

Using Snap to Neatly Align Items

The **Snap Option** allows users to align objects to an invisible grid.

Snap is turned on via the button on the Status bar.



The Snap Grid settings are set using the Preferences option called via the Preferences icon on the toolbar.

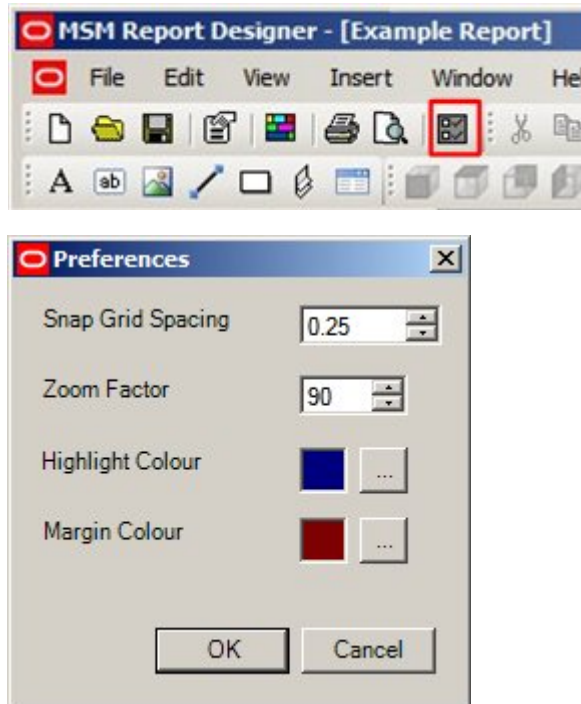

The Snap Grid spacing can then be set using the spin controls.

Note: To see the effect of the Snap Grid for the first time, it is recommended that the value be set to a fairly large one. Useful values are 25 mm for metric settings and 0.25" for imperial settings.

When the Snap option is selected objects can only be moved about in the design window to locations determined by the snap grid.

When the Snap option is turned off, objects can be moved to any location.

Changing Label and Field Text via Toolbar

The appearance of label and field text can be changed via the options on the toolbar. These options are grayed out until a label or field is selected to edit.



When a label or field is selected to edit, they become active.







Text can be justified Left, Center or Right, and Top, Middle or Bottom.

It can also be changed to Bold or Italic.

Selected options are highlighted.

Using the Clipboard

The **Cut**, **Copy** and **Paste** options can be used to move items from one report to another.

Menu	Toolbar	Description
Cut		Copies the selected items to the clipboard and removes them from the layout. Any items already on the clipboard will be lost.
Copy		Copies the selected items to the clipboard. Any items already on the clipboard will be lost.
Paste		<p>Copies all items on the clipboard to the current layout. The items will be retained on the clipboard for further use.</p> <p>When items are pasted, they will be placed on the layout at the nearest point to the top left corner of the editing area but will retain their positions relative to each other. All the pasted items will be selected so that they can easily be relocated to the correct position on the layout. Any currently selected items will be automatically de-selected.</p> <p>Note that the clipboard is shared by all open layouts.</p>
Delete		Deletes the selected items from the current document, the items will not be placed on the clipboard.
Undo		<p>Undoes the last change in the current layout document.</p> <p>The undo stack is held per document but can only contain a limited number of undoes. The stack is lost when that layout is closed and is cleared when the layout is saved.</p>

Selecting Multiple Items

Multiple Items can be selected by holding down the shift key while left clicking on the required objects.

In the example below the three objects on the left have been selected and are shown highlighted with selection boxes on the right.

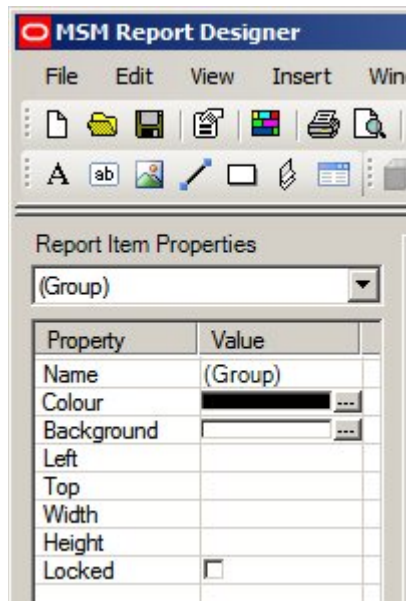
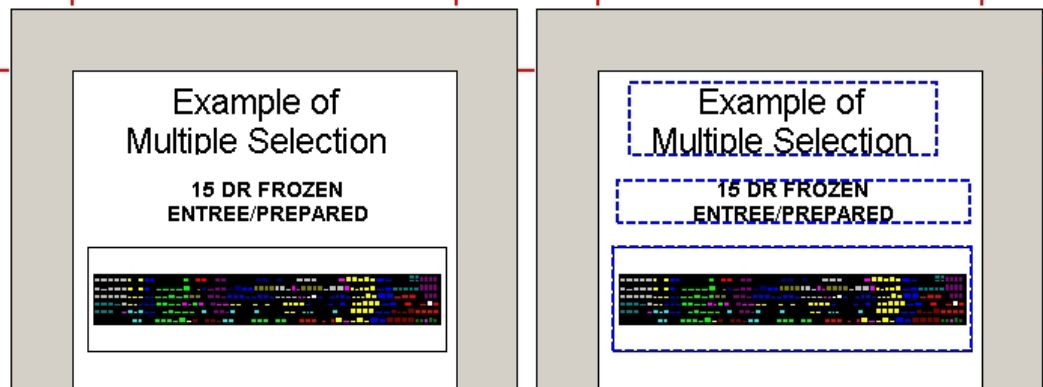

Note that the Report Properties Object Browser now shows a Group of items have been selected.

Only items that can be collectively edited are available in the display.

If they cannot be collectively edited, that section of the display is blank.

In the example on the left, the Left, Top, Width and Height values cannot be added while multiple objects are selected.

Using Grouping

Grouping allows all items in the group to be selected, even if just one item in the group is selected.

Grouping is turned on or off by using the Group button on the Status Bar.

(The Status bar also provides information on the number of items selected, etc).



Multi-selected items can be grouped or ungrouped using the options available on the toolbar.



Grouping Items

To Group items, ensure Group is selected on the Status bar. Multi-select the required items then click on the Group icon. Selecting any one of the grouped items will then select the others.

Un-grouping Items

To Un-group items, ensure Group is selected on the Status bar. Select the required group then click on the un-group icon. The items will now be ungrouped and will only select singly.

Bring to Front or Send to Back

Bring to Front or Send to Back can be used with superimposed objects.

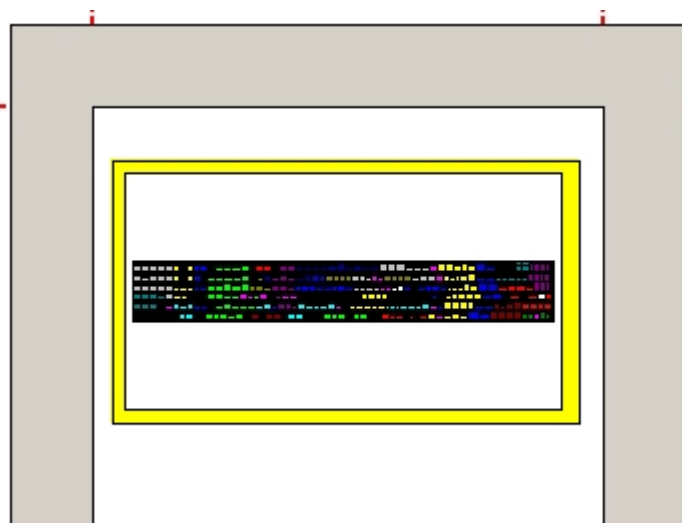

In this example a view has been superimposed on top of a yellow rectangle. The yellow rectangle is first selected (blue rectangle in left hand image), and then the Bring to Front icon is clicked on the toolbar. This brings the yellow rectangle in front of the view.

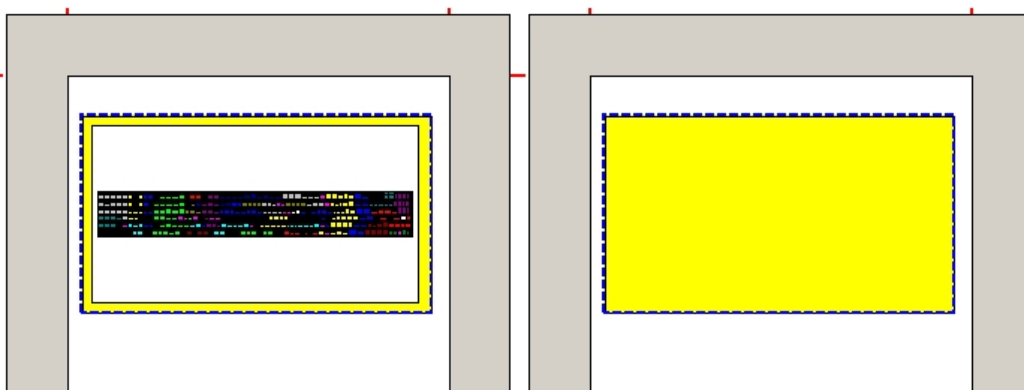

The process can be reversed by clicking on the Send to Back icon.

Printing the Report

Print Preview

Print Preview can be selected from the File pull down menu or from the toolbar.

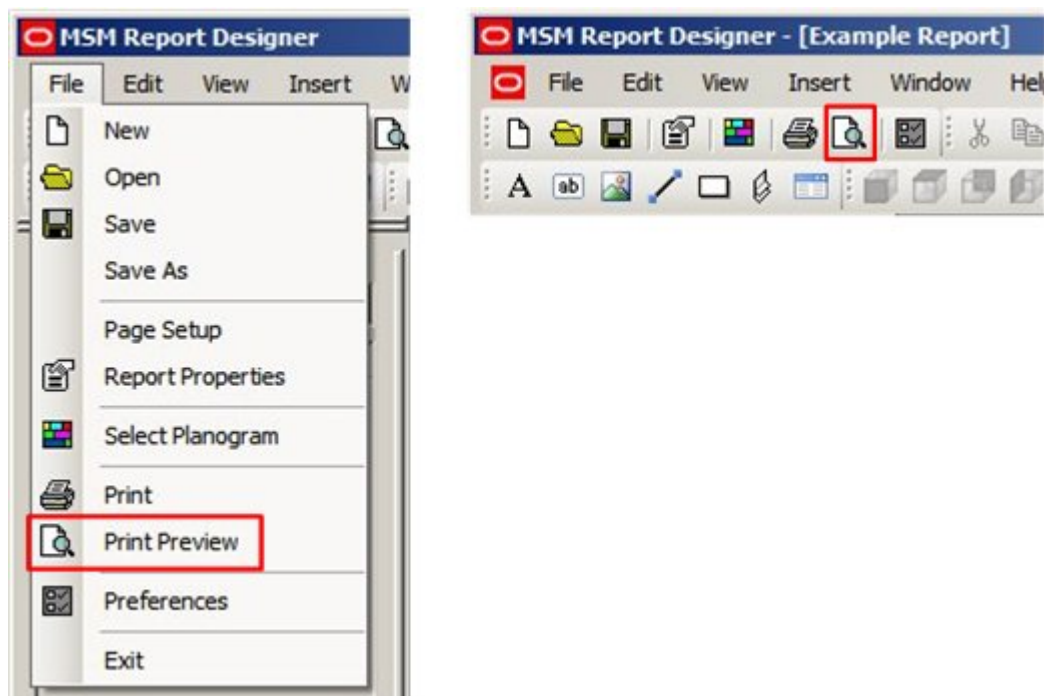

This will bring up the Print Preview dialogue box.

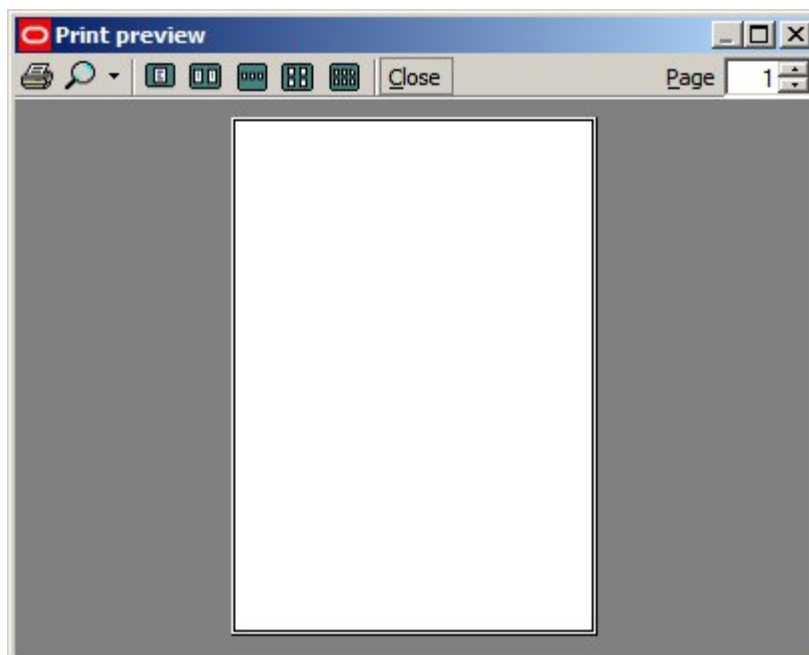

The icons at the top allow the user to print, zoom in or zoom out, or see multiple pages.

Note: The print preview does not print information for a specific planogram - it just allows the user to confirm that the format of the printed report is correct. Using the print button from the print preview will send the current preview to the default printer. To print a planogram specific report, use the print option.

Printing

Printing can be initiated from the Print options on the on the File pull down menu (or the toolbar) once a Report Design Template is open.

(Print Preview only allows test printing of a generic report. Reports on specific planograms must be initiated through the print option).

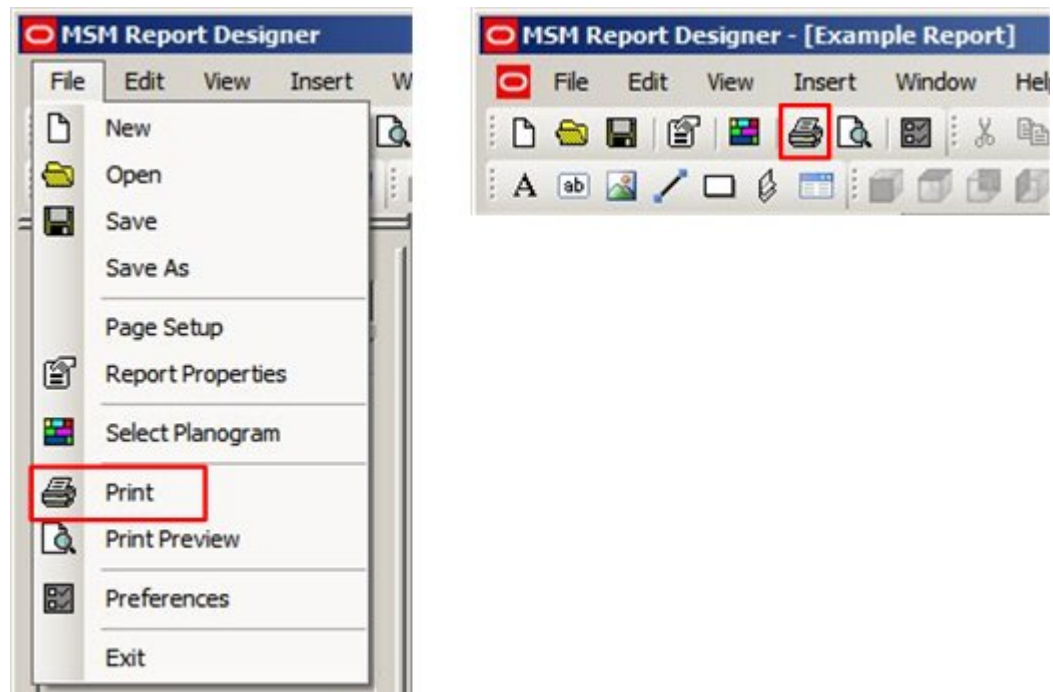

This will bring up the Print dialogue box.

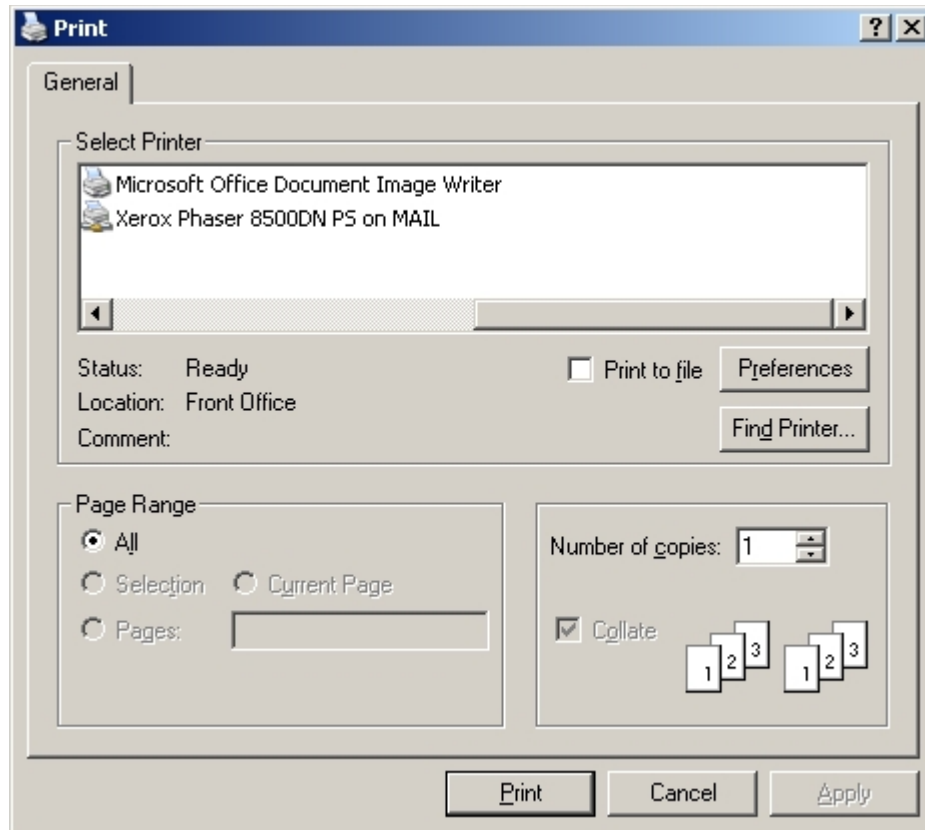

The **Page Range** option will be disabled, as will the **Collate** option. However, the user will be able to select the printer and set its preferences, as well as being able to set the number of copies that are printed.

When the options have been set, click on OK to print.

This will bring up the Select Planogram dialogue box.

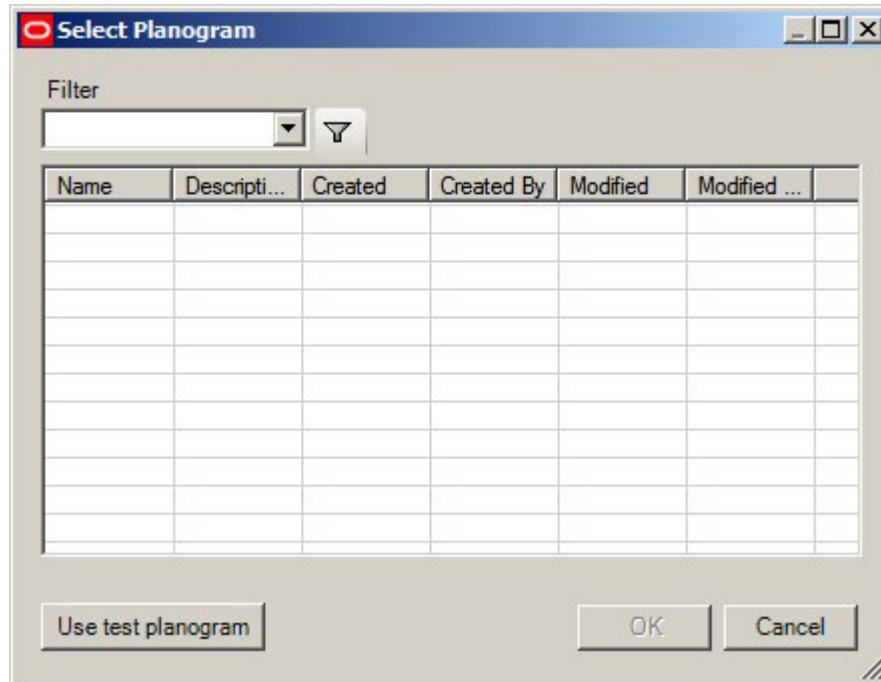

Select the required planogram (using the filter to reduce the number of planograms displayed).

Click on OK: the report on the selected planogram will then print.