

**Oracle® Purchasing**

User's Guide

Release 12.1

**Part No. E13410-05**

August 2010

Oracle Purchasing User's Guide, Release 12.1

Part No. E13410-05

Copyright © 1996, 2010, Oracle and/or its affiliates. All rights reserved.

Primary Author: Pratima Mahtani

Contributing Author: Srikanth Bevara, Kunal Dey, Chirag Vardia, Rakesh Chakravarthi, Gurupackiarathi Gandhi, Gowri Arur

Oracle is a registered trademark of Oracle Corporation and/or its affiliates. Other names may be trademarks of their respective owners.

This software and related documentation are provided under a license agreement containing restrictions on use and disclosure and are protected by intellectual property laws. Except as expressly permitted in your license agreement or allowed by law, you may not use, copy, reproduce, translate, broadcast, modify, license, transmit, distribute, exhibit, perform, publish or display any part, in any form, or by any means. Reverse engineering, disassembly, or decompilation of this software, unless required by law for interoperability, is prohibited.

The information contained herein is subject to change without notice and is not warranted to be error-free. If you find any errors, please report them to us in writing.

If this software or related documentation is delivered to the U.S. Government or anyone licensing it on behalf of the U.S. Government, the following notice is applicable:

#### U.S. GOVERNMENT RIGHTS

Programs, software, databases, and related documentation and technical data delivered to U.S. Government customers are "commercial computer software" or "commercial technical data" pursuant to the applicable Federal Acquisition Regulation and agency-specific supplemental regulations. As such, the use, duplication, disclosure, modification, and adaptation shall be subject to the restrictions and license terms set forth in the applicable Government contract, and, to the extent applicable by the terms of the Government contract, the additional rights set forth in FAR 52.227-19, Commercial Computer Software License (December 2007). Oracle USA, Inc., 500 Oracle Parkway, Redwood City, CA 94065.

This software is developed for general use in a variety of information management applications. It is not developed or intended for use in any inherently dangerous applications, including applications which may create a risk of personal injury. If you use this software in dangerous applications, then you shall be responsible to take all appropriate fail-safe, backup, redundancy and other measures to ensure the safe use of this software. Oracle Corporation and its affiliates disclaim any liability for any damages caused by use of this software in dangerous applications.

This software and documentation may provide access to or information on content, products and services from third parties. Oracle Corporation and its affiliates are not responsible for and expressly disclaim all warranties of any kind with respect to third party content, products and services. Oracle Corporation and its affiliates will not be responsible for any loss, costs, or damages incurred due to your access to or use of third party content, products or services.

---

# Contents

## Send Us Your Comments

## Preface

## 1 Setting Up

Overview of Setting Up.....	1-1
Defining Locations.....	1-18
Defining Buyers.....	1-20
Defining Approval Groups.....	1-21
Assigning Approval Groups.....	1-24
Annotating Purchasing Documents.....	1-26
Managing Attachments.....	1-28
Attaching Notes to Purchasing Documents.....	1-33
Defining Purchasing Options.....	1-33
Defining Receiving Options.....	1-42
Defining Requisition Templates.....	1-46
Purchasing Hazardous Materials.....	1-50
Regulation Background.....	1-50
Defining Hazard Classes.....	1-53
Defining UN Numbers.....	1-54
Defining Lookup Codes.....	1-55
Defining Quality Inspection Codes.....	1-57
Line Types in Purchasing Documents.....	1-59
Defining Line Types.....	1-62
Purchasing Services .....	1-65
Defining Document Types.....	1-67
Defining Document Styles.....	1-73

<b>Purchase Order Communication Setup Steps</b> .....	1-75
<b>Center-Led Procurement Setup</b> .....	1-79
<b>Controlling Purchasing Periods</b> .....	1-82
<b>Expense Charge Account Rules</b> .....	1-83
<b>Choosing Workflow Options</b> .....	1-85
<b>iProcurement Setup Windows</b> .....	1-89
<b>Oracle Services Procurement</b> .....	1-90
<b>Define Job and Category Association</b> .....	1-92

## **2 Approval, Security, and Control**

<b>Setting Up Document Approval and Security</b> .....	2-1
<b>Position Hierarchies</b> .....	2-6
<b>Document Security and Access</b> .....	2-7
<b>Approval Routing</b> .....	2-10
<b>Approval Authorization Control</b> .....	2-12
Defining Approval Authorization Rules.....	2-13
Using Approval Assignments.....	2-15
<b>Assigning Employees</b> .....	2-18
<b>The Document Approval Process</b> .....	2-19
Approved Documents and Supply.....	2-21
Document Status Checks.....	2-21
Document Submission Checks.....	2-22
Viewing and Responding to Approval Notifications.....	2-29
<b>Submitting a Document for Approval</b> .....	2-32
<b>Offline Approvers</b> .....	2-38
<b>Mass Forwarding Documents</b> .....	2-39
<b>Document Control Overview</b> .....	2-40
Document Control Options.....	2-41
Purchase Order Control Matrices.....	2-46
Document Control Applicability Matrix.....	2-49
Document Control Status Check Matrix.....	2-51
Document Control Submission Check Matrix.....	2-53
<b>Controlling Documents</b> .....	2-57
<b>MassCancel</b> .....	2-61
Defining MassCancel.....	2-61
Define MassCancel Listing.....	2-65
Running MassCancel.....	2-67
Run MassCancel Listing.....	2-68

### 3 Requisitions

<b>Overview of Requisitions</b> .....	3-1
Requisition Types.....	3-6
Reserving Funds for Requisitions.....	3-8
<b>Reviewing Requisitions</b> .....	3-9
Managing Requisitions.....	3-9
Updating Requisitions.....	3-12
<b>Overview of Internal Requisitions</b> .....	3-13
Demand for Internal Requisitions.....	3-16
Internal Requisition Approvals.....	3-18
Creation of Internal Sales Orders.....	3-19
Management of Internal Sales Orders.....	3-20
Pick Release for Internal Sales Orders.....	3-21
Ship Confirmation for Internal Sales Orders.....	3-21
Management of Internal Requisitions.....	3-22
Internal Requisitions Processing Summary.....	3-23
Internal Requisitions Setup Overview.....	3-24
Minimum Order Management Setup for Internal Requisitions.....	3-25
Minimum Shipping Execution Setup for Internal Requisitions.....	3-26
Minimum Purchasing Setup for Internal Requisitions.....	3-27
Minimum Inventory Setup for Internal Requisitions.....	3-28
Online Processing Automation for Internal Requisitions.....	3-30
Internal Requisitions Example.....	3-31
<b>Finding Requisitions</b> .....	3-36
<b>Using the Requisition Headers Summary Window</b> .....	3-39
<b>Using the Requisition Lines Summary Window</b> .....	3-40
<b>Using the Requisition Distributions Summary Window</b> .....	3-42
<b>Entering Requisition Preferences</b> .....	3-44
<b>Entering Requisition Headers</b> .....	3-48
<b>Entering Requisition Lines</b> .....	3-51
<b>Entering Requisition Distributions</b> .....	3-58
<b>Using Requisition Templates</b> .....	3-61

### 4 Purchase Orders

<b>Overview of Purchase Orders</b> .....	4-1
Purchase Order Types.....	4-2
Purchase Order Features.....	4-4
<b>Purchase Order Defaulting Rules</b> .....	4-10
<b>Finding Purchase Orders</b> .....	4-23

Using the Purchase Order Headers Summary Window.....	4-26
Using the Purchase Order Lines Summary Window.....	4-30
Using the Purchase Order Shipments Summary Window.....	4-32
Using the Purchase Order Distributions Summary Window.....	4-35
<b>Entering Purchase Order Preferences.....</b>	<b>4-37</b>
<b>Entering Purchase Order Headers.....</b>	<b>4-40</b>
<b>Entering Purchase Order Lines.....</b>	<b>4-46</b>
<b>Entering Purchase Order Price Reference Information.....</b>	<b>4-50</b>
<b>Entering Purchase Order Reference Document Information.....</b>	<b>4-51</b>
<b>Entering Purchase Order Miscellaneous Information.....</b>	<b>4-53</b>
<b>Entering Purchase Agreement Information.....</b>	<b>4-55</b>
<b>Entering Purchase Order Temporary Labor Information.....</b>	<b>4-58</b>
<b>Entering Currency Information.....</b>	<b>4-60</b>
<b>Entering Purchase Order Details Information.....</b>	<b>4-61</b>
<b>Entering Purchase Order Shipments.....</b>	<b>4-67</b>
<b>Entering Purchase Order Receiving Controls.....</b>	<b>4-71</b>
<b>Entering Purchase Agreement Price Break Information.....</b>	<b>4-73</b>
<b>Entering Purchase Order Distributions.....</b>	<b>4-75</b>
<b>Entering Outside Services Information.....</b>	<b>4-79</b>
<b>Entering Purchase Order Notification Controls.....</b>	<b>4-80</b>
<b>Entering and Viewing Purchase Order Acceptances.....</b>	<b>4-82</b>
<b>Entering Releases.....</b>	<b>4-84</b>
Entering Release Headers.....	4-84
Entering Release Shipments.....	4-87
Entering Release Distributions.....	4-93
<b>Automatic Release Generation.....</b>	<b>4-96</b>
<b>Copying Purchase Orders.....</b>	<b>4-99</b>
<b>Document Revision Numbering.....</b>	<b>4-103</b>
Document Revision Rules.....	4-104
Document Reapproval Rules.....	4-108
<b>Changing Encumbered Documents.....</b>	<b>4-113</b>
<b>Drop Shipments.....</b>	<b>4-114</b>
<b>Tax Information in Purchasing.....</b>	<b>4-116</b>
Viewing Tax Information.....	4-117
<b>Procurement Card Purchase Orders and Releases.....</b>	<b>4-118</b>
<b>Global Agreements.....</b>	<b>4-120</b>

## 5 Supply Base Management

Overview of Sourcing, RFQs, and Quotations.....	5-1
RFQs and Quotations.....	5-4

<b>Supplier Item Catalog</b> .....	5-5
Finding Supplier Items.....	5-9
Using the Supplier Item Catalog Tabbed Regions.....	5-13
Entering Order Pad Options (from Requisitions).....	5-16
<b>Receiving Price/Sales Catalog Information Electronically</b> .....	5-18
Setting a Price Tolerance in a Price/Sales Catalog Update.....	5-20
Monitoring Price Increases in a Price/Sales Catalog Update.....	5-21
<b>Overview of Automatic Sourcing</b> .....	5-24
Setting Up Automatic Sourcing.....	5-27
Defining Sourcing Rules.....	5-30
Assigning Sourcing Rules and Bills of Distribution.....	5-33
<b>Approved Supplier List</b> .....	5-35
ASL Repository Maintenance.....	5-35
ASL Business Needs.....	5-36
Defining Approved Supplier Statuses.....	5-37
Defining the Supplier and Item/Commodity Combination.....	5-40
Defining the Supplier-Item Attributes.....	5-43
View Approved Suppliers.....	5-48
<b>Entering RFQs</b> .....	5-49
Entering RFQ Headers.....	5-49
Entering RFQ Lines.....	5-53
Entering RFQ Supplier Information.....	5-55
Entering RFQ Terms Information.....	5-57
Entering RFQ Shipment Information.....	5-58
Entering RFQ Price Break Information.....	5-60
<b>Entering Quotations</b> .....	5-62
Entering Quotation Headers.....	5-62
Entering Quotation Lines.....	5-66
Entering Quotation Terms Information.....	5-69
Entering Quotation Shipment Information.....	5-70
Entering Quotation Price Break Information.....	5-72
<b>Copying Quotations from RFQs</b> .....	5-74
<b>Approving Quotations</b> .....	5-75
Finding Quotations for Approval.....	5-75
Approving Quotation Shipments.....	5-77
Approving Entire Quotations.....	5-79
<b>Defining Supplier Lists</b> .....	5-81
<b>Managing Buyer Workload</b> .....	5-83
Finding Requisition Lines for Review or Assignment.....	5-83
Reviewing Buyer Workload.....	5-85
Assigning Requisition Lines.....	5-86

**6 AutoCreate**

AutoCreate Documents Overview..... 6-1
AutoCreate Document Options..... 6-3
Additional AutoCreate Features..... 6-7
Oracle iProcurement Requisitions..... 6-8
Finding Requisition Lines for AutoCreate..... 6-9
Selecting AutoCreate Criteria..... 6-12
Entering Document Information and Completing AutoCreate..... 6-15
Using the Document Builder..... 6-17
Modifying Requisition Lines..... 6-19

**7 Professional Buyer's Work Center**

Buyer's Work Center Overview..... 7-1
Using the Demand Workbench: Requisitions..... 7-3
Requisitions: Demand Workbench..... 7-4
Purchase Orders..... 7-10
Finding Standard Purchase Orders..... 7-11
Entering Purchase Order Information..... 7-12
Purchase Agreements..... 7-17
Finding Agreements..... 7-18
Create And Update Agreements..... 7-19
Pricing Transparency for Standard PO and Global Blanket Purchase Agreement..... 7-23

**8 Communication With Suppliers**

Overview of Supplier Communication..... 8-1
Printed Purchase Orders Overview..... 8-3

**9 Receiving**

Overview of Receiving..... 9-1
Centralized Purchasing for Multiple Receiving Organizations..... 9-5
Receiving Locations..... 9-6
Movement Statistics..... 9-6
Receiving Controls, Options, and Profiles..... 9-7
Receipt Tolerances..... 9-12
Return Material Authorizations (RMAs)..... 9-13
Debit Memos..... 9-14
Drop Shipment Receipts..... 9-15
Receiving Open Interface..... 9-15



<b>Advance Shipment Notices (ASNs)</b> .....	9-15
<b>Managing Receipts</b> .....	9-21
Multiple Distributions.....	9-22
Cascading Receipts and Receiving Transactions.....	9-23
Express Receipts and Receiving Transactions.....	9-23
Entering Express Receipts.....	9-25
Finding Expected Receipts.....	9-25
Entering Receipt Header Information.....	9-29
Entering Receipt Lines.....	9-30
<b>Unordered Receipts</b> .....	9-34
Entering Unordered Receipts.....	9-36
Matching Unordered Receipts.....	9-36
<b>Receiving Transactions</b> .....	9-39
Finding Receiving Transactions (Summary).....	9-41
Using the Receiving Headers Summary Window.....	9-44
Using the Receiving Transaction Summary Window.....	9-45
Viewing Accounting Lines.....	9-47
Using the Receipt Header Details Window.....	9-50
Finding Transaction Status Information.....	9-51
Viewing Transaction Status Information.....	9-54
Finding Receiving Transactions.....	9-55
Entering Receiving Transactions.....	9-58
Drilling Down to Purchasing from Oracle General Ledger.....	9-61
<b>Inspections</b> .....	9-63
Inspecting Received Items.....	9-65
<b>Returns</b> .....	9-66
Finding Returns.....	9-68
Entering Returns.....	9-71
<b>Corrections</b> .....	9-73
Finding Corrections.....	9-74
Entering Corrections.....	9-78
<b>Finding Intransit Shipments</b> .....	9-80
Managing Shipments.....	9-81
<b>Control Numbers</b> .....	9-83
<b>Receiving Reports</b> .....	9-85
<b>Overview of Receipt Accounting</b> .....	9-86
Setting Up Inventory Accruals.....	9-89
Accrual Process for Perpetual Accruals.....	9-94
Monitoring Price Variances.....	9-101
Reconciling AP Accrual Accounts Balance.....	9-102
Accrual Process for Period-End Accruals.....	9-104

Identifying Journal Entry Batches in General Ledger.....	9-108
Accrual Write Off.....	9-111
<b>Automatic Offsets in Oracle Purchasing.....</b>	<b>9-120</b>
Defining Purchase Order Receipt Accruals.....	9-120
<b>Integration with Landed Cost Management.....</b>	<b>9-121</b>

## 10 Inquiries

Viewing Action History.....	10-1
Viewing Purchase Order Changes.....	10-3

## 11 Reports

Accrual Write-Off Report.....	11-1
Advanced Shipment Notice Discrepant Receipts Report.....	11-3
AP and PO Accrual Reconciliation Report.....	11-4
Backordered Internal Requisitions Report.....	11-6
Blanket and Planned PO Status Report.....	11-7
Buyer Listing.....	11-8
Buyer's Requisition Action Required Report.....	11-9
Cancelled Purchase Orders Report.....	11-11
Cancelled Requisitions Report.....	11-11
Contract Status Report.....	11-12
Country of Origin Report (by Item).....	11-13
Country of Origin Report (by Supplier).....	11-14
Encumbrance Detail Report.....	11-15
Expected Receipts Report.....	11-17
Financials/Purchasing Options Listing.....	11-19
Internal Requisition Status Report.....	11-19
Internal Requisitions/Deliveries Discrepancy Report.....	11-20
Invoice Price Variance Report.....	11-21
Invoice Price Variance by Supplier Report.....	11-22
Item Detail Listing.....	11-24
Item Summary Listing.....	11-25
Location Listing.....	11-25
Matching Holds by Buyer Report.....	11-27
Miscellaneous Accrual Reconciliation Report.....	11-28
New Supplier Letter Report.....	11-30
Open Purchase Orders Report (by Buyer).....	11-31
Open Purchase Orders Report (by Cost Center).....	11-32
Overdue Supplier Shipments Report.....	11-33
Overshipments Report.....	11-34

Printed Change Orders Report (Landscape).....	11-35
Printed Change Orders Report (Portrait).....	11-37
Printed Purchase Order Report (Landscape).....	11-39
Printed Purchase Order Report (Portrait).....	11-42
Printed RFQ Report (Landscape).....	11-44
Printed RFQ Report (Portrait).....	11-45
Printed Requisitions Report.....	11-46
Purchase Agreement Audit Report.....	11-47
Purchase Order Commitment by Period Report.....	11-48
Purchase Order Detail Report.....	11-49
Purchase Order Distribution Detail Report.....	11-51
Purchase Order and Releases Detail Report.....	11-52
Purchase Price Variance Report.....	11-53
Purchase Requisition Status Report.....	11-54
Purchase Summary Report by Category.....	11-55
Purchasing Activity Register.....	11-56
Purchasing Interface Errors Report.....	11-57
Purge Purchasing Open Interface Processed Data.....	11-59
Quality Code Listing.....	11-59
Quotation Action Required Report.....	11-60
Receipt Adjustments Report.....	11-61
Receipt Traveler.....	11-63
Receiving Account Distribution Report.....	11-64
Receiving Exceptions Report.....	11-66
Receiving Interface Errors Report.....	11-67
Receiving Transactions Register.....	11-68
Receiving Value Report.....	11-70
Receiving Value Report by Destination Account.....	11-73
ReqExpress Templates Listing.....	11-74
Requisition Activity Register.....	11-74
Requisition Distribution Detail Report.....	11-75
Requisition Import Exceptions Report.....	11-76
Requisitions on Cancelled Sales Order Report.....	11-77
RFQ Action Required Report.....	11-77
Savings Analysis Report (by Buyer).....	11-78
Savings Analysis Report (by Category).....	11-79
Standard Notes Listing.....	11-80
Substitute Receipts Report.....	11-81
Summary Accrual Reconciliation Report.....	11-82
Supplier Affiliated Structure Listing.....	11-83
Supplier Price Performance Analysis Report.....	11-84

Supplier Purchase Summary Report.....	11-85
Supplier Quality Performance Analysis Report.....	11-86
Supplier Service Performance Analysis Report.....	11-87
Supplier Volume Analysis Report.....	11-89
Suppliers on Hold Report.....	11-89
Uninvoiced Receipts Report.....	11-90
Unit of Measure Class Listing.....	11-92
Unit of Measure Listing.....	11-92
Unordered Receipts Report.....	11-93

## 12 Integration with Other Applications

Integration for Engineering and Construction Industry.....	12-1
Landed Cost Management.....	12-4
Pricing Transparency.....	12-6

## 13 Processes

Accrual Load.....	13-1
ASL Upgrade Process.....	13-2
Confirm Receipts Workflow Select Orders Process.....	13-3
Create Internal Sales Orders Process.....	13-4
Create Releases Process.....	13-5
Fill Employee Hierarchy Process.....	13-6
Generate Sourcing Rules And ASLs From Blanket Agreements.....	13-6
Import Price Catalog.....	13-8
Import Standard Purchase Orders.....	13-11
Mass Update of Purchasing Documents.....	13-13
Mass Update of Requisitions.....	13-15
Mass Close of Purchasing Documents.....	13-16
Payment on Receipt.....	13-16
PO Output for Communication.....	13-23
Purchasing Database Administration.....	13-24
Purchasing Documents Open Interface.....	13-25
Receipt Accruals - Period-End Process.....	13-25
Receiving Transaction Processor.....	13-28
Requisition Import Process.....	13-29
Reset Period End Accrual Flags.....	13-32
Reschedule Requisitions Process.....	13-33
Retrieve Time from Oracle Time and Labor (OTL).....	13-34
Retroactive Price Update on Purchasing Documents.....	13-34
Send Notifications for Purchasing Documents.....	13-36

<b>A</b>	<b>Windows and Navigator Paths</b>	
	Oracle Purchasing Windows and Navigator Paths.....	A-1
<b>B</b>	<b>Oracle Purchasing Alerts</b>	
	Using Oracle Alert in Oracle Purchasing.....	B-1
	Predefined Purchasing Alerts.....	B-2
<b>C</b>	<b>Oracle Purchasing Profile Options and Profile Option Categories</b>	
	Profile Options and Profile Option Categories Overview.....	C-1
	Profile Option Category and Profile Options Descriptions.....	C-5
<b>D</b>	<b>Function Security for Purchasing</b>	
	Function Security for Purchasing.....	D-1
<b>E</b>	<b>Procurement Workflows</b>	
	Overview of Procurement Workflows.....	E-1
	Customization Guidelines.....	E-2
	Using the Account Generator in Oracle Purchasing.....	E-6
	Decide How to Use the Account Generator.....	E-7
	What the Account Generator Does in Oracle Purchasing .....	E-9
	Customizing the Account Generator for Oracle Purchasing.....	E-24
	The Default Account Generator Processes for Oracle Purchasing.....	E-30
	Summary of the Generate Default Accounts Process.....	E-37
	Generate Default Accounts Process Activities.....	E-39
	Summary of the Generate Default Accrual Account Subprocess.....	E-43
	Summary of the Generate Default Budget Account Subprocess.....	E-43
	Summary of the Generate Default Charge Account Subprocess.....	E-44
	Summary of the Generate Default Variance Account Subprocess.....	E-44
	Summary of the Build Expense Charge Account Subprocess.....	E-45
	Summary of the Build Inventory Charge Account Subprocess.....	E-45
	Summary of the Build Shop Floor Charge Account Subprocess.....	E-46
	Summary of the Build Inventory Budget Account Subprocess.....	E-46
	Summary of the Build Project Account Subprocesses.....	E-47
	Summary of the Get Charge Account for Variance Account Subprocess.....	E-48
	Summary of the Get Variance Account from Organization Subprocess.....	E-48
	Summary of the Generate Accounts Using FlexBuilder Rules Process.....	E-49
	Using the Workflow Monitor with the Account Generator.....	E-49
	Requisition Approval Workflow.....	E-50

Customizing the PO Requisition Approval Workflow.....	E-51
The PO Requisition Approval Workflow Item Type.....	E-56
Summary of the Main Requisition Approval Process.....	E-62
Main Requisition Approval Process Activities.....	E-63
Summary of the Start of Approve Requisition Process.....	E-67
Start of Approve Requisition Process Activities.....	E-68
Summary of the Verify Requisition Subprocess.....	E-69
Verify Requisition Subprocess Activities.....	E-70
Summary of the Reserve At The Start Subprocess.....	E-71
Reserve At The Start Subprocess Activities.....	E-71
Summary of the Verify Approval Authority Subprocess.....	E-72
Verify Approval Authority Subprocess Activities.....	E-73
Summary of the Approval List Routing Subprocess.....	E-74
Approval List Routing Subprocess Activities.....	E-74
Summary of the Reject Requisition Subprocess.....	E-75
Reject Requisition Subprocess Activities.....	E-76
Summary of the Return Requisition to Submitter Subprocess.....	E-77
Return Requisition to Submitter Subprocess Activities.....	E-77
Summary of the Notify Approver Subprocess.....	E-78
Notify Approver Subprocess Activities.....	E-79
Summary of the Response with Approve Action Subprocess.....	E-80
Response with Approve Action Subprocess Activities.....	E-80
Summary of the Response with Approve and Forward Action Subprocess.....	E-81
Response with Approve and Forward Action Subprocess Activities.....	E-81
Summary of the Response with Forward Action Subprocess.....	E-82
Response with Forward Action Subprocess Activities.....	E-83
Summary of the Response with Reject Action Subprocess.....	E-83
Response with Reject Action Subprocess Activities.....	E-83
Summary of the Reserve Before Approve Subprocess.....	E-83
Reserve Before Approve Subprocess Activities.....	E-84
Summary of the Approve Requisition Subprocess.....	E-85
Approve Requisition Subprocess Activities.....	E-86
Summary of the Print Document Subprocess.....	E-87
Print Document Subprocess Activities.....	E-88
Summary of the Verify Approval Authority for Approve and Approve/Forward Action Subprocesses.....	E-88
Verify Approval Authority Subprocess Activities.....	E-89
<b>Purchase Order Approval Workflow.....</b>	<b>E-89</b>
Customizing the PO Approval Workflow.....	E-90
The PO Approval Item Type.....	E-95
Summary of the PO Approval Top Process.....	E-103

PO Approval Top Process Activities.....	E-104
Summary of the PO Approval Process.....	E-108
PO Approval Process Activities.....	E-109
Summary of the Verify PO Subprocess.....	E-112
Verify PO Subprocess Activities.....	E-112
Summary of the Reserve Before Approve Subprocess.....	E-114
Reserve Before Approve Subprocess Activities.....	E-114
Summary of the Verify Approval Authority Subprocess.....	E-116
Verify Approval Authority Subprocess Activities.....	E-116
Summary of the Approve PO Subprocess.....	E-117
Approve PO Subprocess Activities.....	E-118
Summary of the Print, Fax, and Email Document Subprocesses.....	E-120
Print, Fax, and Email Document Subprocess Activities.....	E-120
Summary of the Approve and Forward PO Subprocess.....	E-121
Approve and Forward PO Subprocess Activities.....	E-122
Summary of the Notify Approver Subprocess.....	E-124
Notify Approver Subprocess Activities.....	E-124
Summary of the Find Approver Subprocess.....	E-126
Find Approver Subprocess Activities.....	E-127
Summary of the Forward PO Subprocess.....	E-128
Forward PO Subprocess Activities.....	E-129
Summary of the Return PO to Submitter Subprocess.....	E-130
Return PO to Submitter Subprocess Activities.....	E-130
Summary of the Reject PO Subprocess.....	E-131
Reject PO Subprocess Activities.....	E-132
Change Order Process Activities.....	E-133
<b>Workflow Processes for Approving Change Orders.....</b>	<b>E-133</b>
Customizing the Change Order Workflow.....	E-133
The Change Order Workflow Item Attributes.....	E-136
Summary of the Get All Document Changes Subprocess.....	E-147
Get All Document Changes Subprocess Activities.....	E-147
Summary of the Get All Blanket PO Changes Subprocess.....	E-149
Get All Blanket PO Changes Subprocess Activities.....	E-149
Summary of the Get All Contract PO Changes Subprocess.....	E-150
Get All Contract PO Changes Subprocess Activities.....	E-150
Summary of the Get All Planned PO Changes Subprocess.....	E-150
Get All Planned PO Changes Subprocess Activities.....	E-151
Summary of the Get All Release Changes Subprocess.....	E-152
Get All Release Changes Subprocess Activities.....	E-152
Summary of the Get All Standard PO Changes Subprocess.....	E-153
Get All Standard PO Changes Subprocess Activities.....	E-153

Summary of the Do Document Changes Require Reapproval? Subprocess.....	E-154
Do Document Changes Require Reapproval? Subprocess Activities.....	E-154
Summary of the Change Order Reserve Before Approve Subprocess.....	E-155
Change Order Reserve Before Approve Subprocess Activities.....	E-156
Summary of the Approve PO (Change Order) Subprocess.....	E-157
Approve PO (Change Order) Subprocess Activities.....	E-158
Summary of the Print and Fax Document Processes (Change Order).....	E-160
Print and Fax Document Process (Change Order) Activities.....	E-161
<b>Workflow for Creating Purchase Orders and Releases.....</b>	<b>E-161</b>
Customizing the Automatic Document Creation Workflow.....	E-162
The PO Create Documents Item Type.....	E-167
Summary of Overall Document Creation / Launch Approval Process.....	E-171
Overall Document Creation / Launch Approval Process Activities.....	E-172
Summary of the Verify Req Line Information Process.....	E-174
Verify Req Line Information Process Activities.....	E-176
Summary of the Does Req Line Have Enough Information To Automatically Create A Document? Process.....	E-178
Does Req Line Have Enough Information To Automatically Create A Document? Process Activities.....	E-178
Summary of the Create and Approve Purchase Order Or Release Process.....	E-179
Create And Approve Purchase Order Or Release Process Activities.....	E-180
Summary of the Get Buyer Subprocess.....	E-181
Get Buyer Subprocess Activities.....	E-181
Using the Workflow Monitor for the PO Create Documents Workflow.....	E-182
<b>Confirm Receipts Workflow.....</b>	<b>E-184</b>
Customizing the Confirm Receipts Workflow.....	E-184
The Confirm Receipts Workflow Item Type.....	E-188
Summary of the Confirm Receipt Process.....	E-191
Confirm Receipt Process Activities.....	E-192
Summary of the Notify Requester Subprocess.....	E-194
Notify Requester Subprocess Activities.....	E-194
<b>PO Send Notifications Workflow.....</b>	<b>E-195</b>
Customizing the PO Send Notifications for Purchasing Documents Workflow.....	E-195
The PO Send Notifications for Purchasing Documents Item Type.....	E-199
Summary of the PO Document Approval Reminder Process.....	E-202
PO Document Approval Reminder Process Activities.....	E-203
<b>Price/Sales Catalog Notification Workflow.....</b>	<b>E-206</b>
Customizing the Issue Notifications Process.....	E-208
The PO Catalog Price Tolerances Exceeded Notifications Item Type.....	E-210
Summary of the Issue Notifications Process.....	E-210
Issue Notifications Process Activities.....	E-211



<b>Debit Memo Notification Workflow</b> .....	E-212
Customizing the Debit Memo Notification Workflow.....	E-212
The PO Debit Memo Notification Item Type.....	E-214
Summary of the Debit Memo Process.....	E-215
<b>Process Navigator Workflows</b> .....	E-216
<b>PO Approval Error Workflow</b> .....	E-217
Customizing the PO Approval Error Workflow.....	E-218
The PO Approval Error Item Type.....	E-221
Summary of PO Approval Error Workflow.....	E-221

**F 21 CFR Part 11 Compliance: Oracle E-Records**

21 CFR Part 11 Overview.....	F-1
E-records and E-signatures for Oracle Purchasing.....	F-2
Viewing Oracle E-Records and E-Signatures.....	F-3

**G Complex Work in the Procurement Suite**

Complex Work in the Procurement Suite.....	G-1
--	-----

**GLOSSARY**

**Index**



---

# Send Us Your Comments

## Oracle Purchasing User's Guide, Release 12.1

### Part No. E13410-05

Oracle welcomes customers' comments and suggestions on the quality and usefulness of this document. Your feedback is important, and helps us to best meet your needs as a user of our products. For example:

- Are the implementation steps correct and complete?
- Did you understand the context of the procedures?
- Did you find any errors in the information?
- Does the structure of the information help you with your tasks?
- Do you need different information or graphics? If so, where, and in what format?
- Are the examples correct? Do you need more examples?

If you find any errors or have any other suggestions for improvement, then please tell us your name, the name of the company who has licensed our products, the title and part number of the documentation and the chapter, section, and page number (if available).

Note: Before sending us your comments, you might like to check that you have the latest version of the document and if any concerns are already addressed. To do this, access the new Oracle E-Business Suite Release Online Documentation CD available on My Oracle Support and [www.oracle.com](http://www.oracle.com). It contains the most current Documentation Library plus all documents revised or released recently.

Send your comments to us using the electronic mail address: [appsdoc\\_us@oracle.com](mailto:appsdoc_us@oracle.com)

Please give your name, address, electronic mail address, and telephone number (optional).

If you need assistance with Oracle software, then please contact your support representative or Oracle Support Services.

If you require training or instruction in using Oracle software, then please contact your Oracle local office and inquire about our Oracle University offerings. A list of Oracle offices is available on our Web site at [www.oracle.com](http://www.oracle.com).



---

# Preface

## Intended Audience

Welcome to Release 12.1 of the *Oracle Purchasing User's Guide*.

This guide contains the information needed to implement and use Oracle Purchasing.

See Related Information Sources on page xxii for more Oracle E-Business Suite product information.

## Deaf/Hard of Hearing Access to Oracle Support Services

To reach Oracle Support Services, use a telecommunications relay service (TRS) to call Oracle Support at 1.800.223.1711. An Oracle Support Services engineer will handle technical issues and provide customer support according to the Oracle service request process. Information about TRS is available at

<http://www.fcc.gov/cgb/consumerfacts/trs.html>, and a list of phone numbers is available at <http://www.fcc.gov/cgb/dro/trsphonebk.html>.

## Documentation Accessibility

Our goal is to make Oracle products, services, and supporting documentation accessible to all users, including users that are disabled. To that end, our documentation includes features that make information available to users of assistive technology. This documentation is available in HTML format, and contains markup to facilitate access by the disabled community. Accessibility standards will continue to evolve over time, and Oracle is actively engaged with other market-leading technology vendors to address technical obstacles so that our documentation can be accessible to all of our customers. For more information, visit the Oracle Accessibility Program Web site at <http://www.oracle.com/accessibility/>.

## Accessibility of Code Examples in Documentation

Screen readers may not always correctly read the code examples in this document. The conventions for writing code require that closing braces should appear on an otherwise empty line; however, some screen readers may not always read a line of text that consists solely of a bracket or brace.

## Accessibility of Links to External Web Sites in Documentation

This documentation may contain links to Web sites of other companies or organizations that Oracle does not own or control. Oracle neither evaluates nor makes any representations regarding the accessibility of these Web sites.

## Structure

- 1 Setting Up
- 2 Approval, Security, and Control
- 3 Requisitions
- 4 Purchase Orders
- 5 Supply Base Management
- 6 AutoCreate
- 7 Professional Buyer's Work Center
- 8 Communication With Suppliers
- 9 Receiving
- 10 Inquiries
- 11 Reports
- 12 Integration with Other Applications
- 13 Processes
- A Windows and Navigator Paths
- B Oracle Purchasing Alerts
- C Oracle Purchasing Profile Options and Profile Option Categories
- D Function Security for Purchasing
- E Procurement Workflows
- F 21 CFR Part 11 Compliance: Oracle E-Records
- G Complex Work in the Procurement Suite
- GLOSSARY

## Related Information Sources

You can choose from many sources of information, including online documentation, training, and support services, to increase your knowledge and understanding of Oracle Purchasing.

**Warning:** This guide includes information about many features of Oracle Applications other than Oracle Purchasing. These other Oracle Applications may require separate licenses, and must be fully installed

to take advantage of their features.

### **Online Documentation**

All Oracle Applications documentation is available online (HTML or PDF).

- **Online Help** – Online help patches (HTML) are available on My Oracle Support.
- **PDF (Softcopy Guides)** - Adobe Acrobat PDF versions of all Oracle Applications guides are available on My Oracle Support..
- **Oracle eBusiness Suite Electronic Technical Reference Manuals** - Each Electronic Technical Reference Manual (eTRM) contains database diagrams and a detailed description of database tables, forms, reports, and programs for a specific Oracle Applications product. This information helps you convert data from your existing applications and integrate Oracle Applications data with non-Oracle applications, and write custom reports for Oracle Applications products. Oracle eTRM is available on My Oracle Support.

### **Related Documentation**

*Oracle E-Business Suite User's Guide*

*Multiple Organizations in Oracle Applications*

*Oracle Advanced Pricing User's Guide*

*Oracle Bills of Material User's Guide*

*Oracle Business Intelligence System Implementation Guide*

*Oracle Business Intelligence User Guide Online Help*

*Oracle Cost Management User's Guide*

*Oracle General Ledger User Guide*

*Oracle HRMS Documentation Set:* This documentation set includes the following volumes: *Oracle HRMS Compensation and Benefits Management Guide, Oracle HRMS Configuring, Reporting, and System Administration Guide, Oracle HRMS Enterprise and Workforce Management Guide, Oracle HRMS Implementation Guide, Oracle HRMS Payroll Processing Management Guide, and Oracle HRMS Workforce Sourcing, Deployment, and Talent Management Guide*

*Oracle Inventory User's Guide*

*Oracle Order Management User's Guide*

*Oracle Payables User's Guide*

*Oracle Procurement Contracts Online Help*

*Oracle Projects Documentation Set:* This documentation set includes the following volumes: *Oracle Project Billing User Guide, Oracle Project Costing User Guide, Oracle*

*Projects Fundamentals User Guide, Oracle Project Management User Guide, Oracle Project Resource Management User Guide, Oracle Projects Implementation Guide, and Oracle Projects APIs, Client Extensions, and Open Interfaces Reference.*

*Oracle Quality User's Guide*

*Oracle Receivables User's Guide*

*Oracle E-Business Suite Flexfields Guide*

*Oracle e-Commerce Gateway User's Guide*

*Oracle E-Business Suite Integrated SOA Gateway Documentation Set*

*Oracle Manufacturing APIs and Open Interfaces Manual*

*Oracle Order Management Open Interfaces, API, & Electronic Messaging Guide*

*Oracle Procurement Contracts Implementation and Administration Guide*

*Oracle Workflow Administrator's Guide*

*Oracle Workflow Developer's Guide*

## **Integration Repository**

The Oracle Integration Repository is a compilation of information about the service endpoints exposed by the Oracle E-Business Suite of applications. It provides a complete catalog of Oracle E-Business Suite's business service interfaces. The tool lets users easily discover and deploy the appropriate business service interface for integration with any system, application, or business partner.

The Oracle Integration Repository is shipped as part of the E-Business Suite. As your instance is patched, the repository is automatically updated with content appropriate for the precise revisions of interfaces in your environment.

## **Do Not Use Database Tools to Modify Oracle E-Business Suite Data**

Oracle **STRONGLY RECOMMENDS** that you never use SQL\*Plus, Oracle Data Browser, database triggers, or any other tool to modify Oracle E-Business Suite data unless otherwise instructed.

Oracle provides powerful tools you can use to create, store, change, retrieve, and maintain information in an Oracle database. But if you use Oracle tools such as SQL\*Plus to modify Oracle E-Business Suite data, you risk destroying the integrity of your data and you lose the ability to audit changes to your data.

Because Oracle E-Business Suite tables are interrelated, any change you make using an Oracle E-Business Suite form can update many tables at once. But when you modify Oracle E-Business Suite data using anything other than Oracle E-Business Suite, you may change a row in one table without making corresponding changes in related tables. If your tables get out of synchronization with each other, you risk retrieving erroneous information and you risk unpredictable results throughout Oracle E-Business Suite.



When you use Oracle E-Business Suite to modify your data, Oracle E-Business Suite automatically checks that your changes are valid. Oracle E-Business Suite also keeps track of who changes information. If you enter information into database tables using database tools, you may store invalid information. You also lose the ability to track who has changed your information because SQL\*Plus and other database tools do not keep a record of changes.



---

# Setting Up

## Overview of Setting Up

This section contains an overview of each step you need to complete to set up Oracle Purchasing. For instructions on how to complete each task, see the setup sections indicated in each step.

### Multiple Reporting Currencies:

If you plan to use Multiple Reporting Currencies (MRC) with Oracle Purchasing, additional setup steps are required. See: *Multiple Reporting Currencies in Oracle Applications*.

### Setup Checklist :

Some of the steps outlined in the setup checklist are Required, and some are Optional. Required Step With Defaults means that the setup functionality comes with pre-seeded, default values in the database; however, you should review those defaults and decide whether to change them to suit your business needs. If you want or need to change them, you should perform that setup step. You need to perform Optional steps only if you plan to use the related feature or complete certain business functions.

You need not perform some of the setup steps if you've already performed a common-application setup (setting up multiple Oracle Applications products).

The following table lists setup steps and a reference to their Oracle Application. After you log on to Oracle Applications, complete these steps to implement Purchasing:

Step No.	Required	Step	Application
Step 1	Required	Set Up System Administrator	Common Applications

<b>Step No.</b>	<b>Required</b>	<b>Step</b>	<b>Application</b>
Step 2	Required	Define Accounting Key Flexfields	Common Applications
Step 3	Required	Set Up Calendars, Currencies, and Ledgers	Common Applications
Step 4	Required	Define Human Resources Key Flexfields	Common Applications
Step 5	Required	Define Locations	Human Resources
Step 6	Required	Define Organizations and Organization Relationships	Human Resources
Step 7	Required	Convert to a Multi-Org Architecture	Common Applications
Step 8	Required	Define Inventory Key Flexfields	Common Applications
Step 9	Required	Define Units of Measure	Oracle Inventory
Step 10	Optional	Define Freight Carriers	Oracle Inventory
Step 11	Required Step with Defaults	Define Item Attributes, Codes, and Templates	Oracle Inventory
Step 12	Required	Define Categories	Oracle Inventory
Step 13	Optional	Define Catalog Groups	Oracle Inventory
Step 14	Required	Set Up Personnel	Human Resources
Step 15	Required	Set Up Oracle Workflow	Common Applications
Step 16	Required	Decide How to Use the Account Generator	Oracle Purchasing
Step 17	Required	Define Financial Options	Oracle Payables

<b>Step No.</b>	<b>Required</b>	<b>Step</b>	<b>Application</b>
Step 18	Optional	Define Subinventory Locations	Oracle Inventory
Step 19	Optional	Set Up Encumbrance Accounting for Purchase Orders with Shop Floor Destination Type	Oracle Enterprise Asset Management
Step 20	Optional	Define Cross-Reference Types	Oracle Purchasing
Step 21	Optional	Define Taxes	Oracle E-Business Tax
Step 22	Optional	Define Payment Terms	Oracle Payables
Step 23	Required	Set Up Approval Information	Oracle Purchasing
Step 24	Required Step with Defaults	Define Lookups and Classes	Oracle Purchasing
Step 25	Optional	Define Standard Attachments	Oracle Purchasing
Step 26	Required	Define Buyers	Oracle Purchasing
Step 27	Optional	Define Items	Oracle Purchasing
Step 28	Required Step with Defaults	Define Line Types	Oracle Purchasing
Step 29	Required	Start the Purchasing Database Administrator	Oracle Purchasing
Step 30	Optional	Define Transaction Reasons	Oracle Purchasing
Step 31	Required	Define Purchasing Options	Oracle Purchasing
Step 32	Required	Define Receiving Options	Oracle Purchasing
Step 33	Required	Set Up Transaction Managers and Resubmission Intervals	Oracle Purchasing
Step 34	Required	Define Suppliers	Oracle Payables

Step No.	Required	Step	Application
Step 35	Required Step with Defaults	Set Up Workflow Options	Oracle Purchasing
Step 36	Required	Submit Workflow-related Processes	Oracle Purchasing
Step 37	Optional	Define Descriptive Flexfields	Common Applications
Step 38	Optional	Set Up Automatic Sourcing	Oracle Purchasing
Step 39	Required	Open Inventory and Purchasing Accounting Periods	Oracle Purchasing
Step 40	Required	Perform Additional System Administrator Setup	Common Applications
Step 41	Required	Define Manufacturing System and User Profiles	Oracle Purchasing

### Setup Steps:

For those steps that are affected, a Context section indicates whether you need to repeat the step for each ledger, set of tasks, inventory organization, HR organization, or other operating unit under Multiple Organizations.

#### Step 1: Set Up System Administrator

This step involves the following tasks:

- Create a super user to use as a logon name during setup and assign the super user the required setup responsibilities. Typically, the required responsibilities are as follows (**Required**):
  - Purchasing
  - System Administrator
- Set up printers. Although you do not have to set up all of your printers now, it may be useful to set up one printer if you wish to print anything during setup. (**Optional**)

See: Setting Up Oracle Applications System Administrator, *Oracle Applications System Administrator's Guide*.

## Step 2: Define Accounting Key Flexfields (Required)

Define Accounting key flexfields and cross validation rules. You may not need to perform this step if you have already installed and set up Oracle General Ledger or performed a common-applications setup. See: *Designing Your Accounting Flexfield, Oracle General Ledger Implementation Guide*.

**Important:** If you are, or will be, fully installing other Oracle applications, be sure to coordinate with those products' flexfield setup before defining the key flexfields here, as it is not recommended to change flexfields after you acquire any flexfields data.

For instructions on how to set up key flexfields, see: *Planning and Defining Key Flexfields, Oracle Applications Flexfields Guide*.

## Step 3: Set Up Calendars, Currencies, and Ledgers (Required)

If you have defined your calendars, currencies, and ledgers while setting up a different Oracle Applications product, proceed to the next step.

**Context:** If you are performing a Multi-Org implementation of Purchasing, you may optionally create more than one calendar, currency, or ledgers. See: *Multiple Organizations in Oracle Applications*.

This step involves the following tasks:

- Set up calendars:
  - Define period types. See: *Defining Period Types, Oracle General Ledger User's Guide*.
  - Define accounting calendar. See: *Defining Calendars, Oracle General Ledger User's Guide*.

**Note:** You can define the following three optional items if you install certain Oracle Manufacturing applications.

- Define transaction calendar. See: *Defining Transaction Calendars, Oracle General Ledger Implementation Guide*. **(Optional)**
- Define workday calendar. See: *Overview of Workday Calendar, Oracle Bills of Material User's Guide*. **(Optional)**
- Define exception templates. See: *Overview of Workday Calendar, Oracle Bills of Material User's Guide*. **(Optional)**
- Define currencies. See: *Defining Currencies, Oracle General Ledger User's Guide*.

- Define conversion rate types. See: Defining Conversion Rate Types, *Oracle General Ledger User's Guide*.
- Define your accounting information. You must define at least one primary ledger for your organization. See: Defining Ledgers, *Oracle General Ledger Implementation Guide*.
- Assign your ledger to the current responsibility. See: Assigning the Ledger Accounts, *Oracle General Ledger Implementation Guide*.
- Define currency rates:
  - Define daily rates. See: Entering Daily Rates, *Oracle General Ledger User's Guide*.
  - Define period rates. See: Entering Period Rates, *Oracle General Ledger User's Guide*.
  - Define historical rates. See: Entering Historical Rates, *Oracle General Ledger User's Guide*.
- Set up accounting code combinations. You do not need to perform this task if you allow dynamic entry of code combinations for the chart of accounts corresponding to your Purchasing installation. See: *Oracle General Ledger User's Guide*
- Open and close accounting periods. See: Opening and Closing Accounting Periods, *Oracle General Ledger User's Guide*.

#### **Step 4: Define Human Resources Key Flexfields (Required)**

You may not need to set up Human Resources key flexfields if you have already installed and set up Oracle Human Resource Management Systems or performed a common-applications setup. Refer to the *Oracle HRMS Implementation Guide* for details.

**Important:** If you are, or will be, fully installing other Oracle applications, be sure to coordinate with those products' flexfield setup before defining the key flexfields here, as it is not recommended to change flexfields after you acquire any flexfield data.

For instructions on how to set up each of the key flexfields listed below, see: *Oracle E-Business Suite Flexfields Guide*.

Define Human Resources and Payroll key flexfields:

- Job flexfield
- Position flexfield
- Grade flexfield



- Cost allocation flexfield
- People Group flexfield
- Personal Analysis flexfield

### **Step 5: Define Locations (Required)**

If you're also setting up other Oracle applications, you may already have defined locations when you set up those applications.

You are required to set up at least one location for now. You can set up the remaining locations after you define inventory organizations and tax codes.

You may need to revisit this step after you set up organizations, if you want to link a location to an inventory organization.

See: Defining Locations, page 1-18.

### **Step 6: Define Organizations and Organization Relationships (Required)**

You may not need to perform this step if you have already installed and set up Oracle Inventory or performed a common-applications setup.

For the following tasks relating to setting up organizations, refer to your *Oracle HRMS Enterprise and Workforce Management Guide*.

- Define business groups, if you want to define new business groups rather than using the default Setup Business Group .See: Setting Up Security for Applications Using Some HRMS Windows, *Oracle HRMS Enterprise and Workforce Management Guide* and Representing Employers Using Business Groups, *Oracle HRMS Enterprise and Workforce Management Guide*.
- Assign business groups to responsibilities. Within your responsibility, make sure that the profile option *HR: Business Group* is set to the business group you want to use for that responsibility.

**Important:** It is important that the *HR: Business Group* profile option be set to the business group you want to use before you define organizations as described below.

- Define legal entities organizations.
- Define operating-units and assign them to legal entities.
- Set up inventory organizations. For the following tasks relating to setting up inventory organizations, see: *Oracle Inventory User's Guide*.
  - Classify the organizations as inventory organizations.

- Define accounting information for inventory organizations.
- Define inventory organization parameters.
- Define receiving options for the inventory organizations. For this task, see: *Defining Receiving Options*, page 1-42.
- Define human resources organizations.
- Define organization hierarchies. (**Optional**)

### **Step 7: Convert to a Multi-Org Architecture (Required)**

Although optional, this setup step is recommended even if your business is composed of just one operating unit. Performing this step now gives you the flexibility to add operating units later.

This step includes the following tasks:

- Set the profile options *MO: Operating Unit* and *HR: User Type*.
- Run the utility to convert to a Multi-Org architecture. It is recommended to involve your system administrator with this task.

See: *Multiple Organizations in Oracle Applications*.

If your company has implemented a shared services operating model, Multi-Org Access Control (MOAC) enables more efficient business transaction processing. You can access, process, and report on data across multiple operating units from a single responsibility without compromising data security or system performance.

To take advantage of Multi-Org Access Control, perform the following tasks:

- Define a Multi-Org Security Profile. See: *Defining a Security Profile, Oracle HRMS Implementation Guide*.
- Set the profile option *MO: Security Profile* to your security profile for each application responsibility that needs to access multiple operating units.
- Set the profile option *MO: Default Operating Unit* to a default operating unit for the responsibility from the step above.

### **Step 8: Define Inventory Key Flexfields (Required)**

You may not need to set up Inventory key flexfields if you have already installed and set up Oracle Inventory or performed a common-applications setup. See also: *Oracle Inventory Flexfields, Oracle Inventory User's Guide*.

**Important:** If you are, or will be, fully installing other Oracle applications, be sure to coordinate with those products' flexfield setup

before defining the key flexfields here, as it is not recommended to change flexfields after you acquire any flexfield data.

For instructions on how to set up each of the key flexfields listed below, see: *Oracle E-Business Suite Flexfields Guide*.

Define Inventory key flexfields:

- System Items flexfield. After you compile the System Items flexfields, the item flexfield view concurrent request is started.
- Item Category flexfield
- PO Item Category flexfield. See: Item Category Flexfield Structures, *Oracle Inventory User's Guide*.
- Item Catalog flexfield
- Stock Locator flexfield
- Account aliases flexfields
- Sales orders flexfield

**Note:** Even if you do not use any of the above flexfields, you must still enable at least one flexfield segment for each and compile them because Oracle Inventory transactions (such as the Define Items window), inquiries, and reports require a frozen flexfield definition.

### **Step 9: Define Units of Measure (Required)**

You may not need to perform this step if you have already installed and set up Oracle Inventory or performed a common-applications setup. See: *Oracle Inventory User's Guide*.

This step involves the following tasks:

- Define units-of-measure classes.
- Define units of measure.
- Define units-of-measure conversions. You can define three different conversion types for your needs: Standard, Intra-class, or Inter-class.

### **Step 10: Define Freight Carriers (Optional)**

Define freight carriers if you want to specify on a purchase order the freight carrier that

a supplier should use.

See: Defining Freight Carriers and Ship Methods, in the *Oracle Order Management Implementation Manual*.

**Context:** You must perform this step for each inventory organization.

### **Step 11: Define Item Attributes, Codes, and Templates**

See: *Oracle Inventory User's Guide*.

This step involves the following tasks:

- Define item attribute controls. (**Required with defaults**)  
**Default:** Most item attribute groups default to Item Master-level control. The rest default to the Item/Organization level.
- Define container type QuickCodes. These can be used to define physical attributes for items. (**Optional**)
- Define status codes. (**Required with defaults**)  
**Default:** Default status codes include basic statuses such as Active, Inactive, Obsolete, and Prototype.
- Define item type QuickCodes. (**Required with defaults**)  
**Default:** Default QuickCodes include finished goods, option class, kit, purchased item, and others.
- Define customer item commodity codes. These can be used to group customer items. (**Optional**)
- Define item templates. You can define an item template if many items share the same values for a number of attributes. (**Optional**)

### **Step 12: Define Categories**

If you're also setting up Oracle Inventory, you may already have performed this step when you set up Inventory.

This step involves the following tasks:

- Define category codes. See: Defining Categories, *Oracle Inventory User's Guide*. (**Required**)
- Define category sets. See: Defining Category Sets, *Oracle Inventory User's Guide*. (**Required with defaults**)  
**Default:** Examples of category sets are Inventory and Purchasing.
- Define default category sets. See: Defining Default Category Sets, *Oracle Inventory User's Guide*. (**Required with defaults**)

**Default:** Each functional area comes with a default category set.

### **Step 13: Define Catalog Groups (Optional)**

A catalog group consists of descriptive elements for items to which you assign sets of values such as type, size, or color. If you're also setting up Oracle Inventory, you may already have performed this step when you set up Inventory.

See: Defining Item Catalog Groups, *Oracle Inventory User's Guide*.

### **Step 14: Set Up Personnel**

You may not need to perform this step if you have already installed and set up Oracle Human Resource Management Systems or performed a common-applications setup. Refer to the *Oracle HRMS Enterprise and Workforce Management Guide* or the HRMS online help for details regarding the following steps.

This step involves the following tasks:

- Define employee QuickCodes. **(Required with defaults)**
- Define jobs. See: Representing Jobs and Positions, *Oracle HRMS Enterprise and Workforce Management Guide*. **(Required)**
- Define positions. You must define positions if you plan to use position approval hierarchies. See: Representing Jobs and Positions, *Oracle HRMS Enterprise and Workforce Management Guide*. **(Optional)**
- Define position hierarchies. You can define one or more position hierarchies to meet your needs. See: Position Hierarchy Window, *Oracle HRMS Enterprise and Workforce Management Guide*. **(Optional)**

**Default:** If you skip this task, you cannot use position approval hierarchies, but must use the employee/supervisor approval method instead.

- Define the following financial options in the Financial Options window; see: Defining Financials Options, *Oracle Payables User's Guide* **(Required)**:
  - Employee numbering
  - Position approval hierarchies option (whether to use position approval hierarchies)
  - Inventory organization
  - Business group (Make sure a business group is specified.)
  - Supplier numbering
- Define employees. If you use Purchasing without Oracle Human Resource Management Systems, use the setup window from within Purchasing for defining

employees. If you use Purchasing with Oracle Human Resource Management Systems, use the setup window for defining employees from within the Human Resource Management Systems application. Refer to the online help for the Enter Person window for entry details. See: *Entering a New Person, Oracle HRMS Enterprise and Workforce Management Guide*. **(Required)**

**Note:** Purchasing users must have user names, which is a later setup step. These Purchasing user names must be linked to an employee name.

#### **Step 15: Set Up Oracle Workflow (Required)**

Since Purchasing uses Oracle Workflow technology to perform document approvals, automatic document creation, and account generation via the Account Generator, you need to set up Oracle Workflow, if you haven't done so already. See: *Setting Up Oracle Workflow, Oracle Workflow Administrator's Guide*.

#### **Step 16: Decide How to Use the Account Generator (Required)**

The Account Generator process in Purchasing builds a charge, budget, accrual, and variance account for each purchase order, release, and requisition distribution based on the distribution's Expense, Inventory, or Shop Floor destination type. You must review the default process that Purchasing uses to see if it meets your accounting requirements. You can optionally customize the Account Generator for each ledger that you have defined. See: *Using the Account Generator in Oracle Purchasing, page E-6*.

**Context:** This step needs to be performed for each operating unit.

#### **Step 17: Define Financial Options (Required)**

See: *Defining Financials Options, Oracle Payables User's Guide*.

For Encumbrance setup dependencies please refer to the *Oracle Payables Implementation Guide*.

**Context:** This step needs to be performed for each operating unit.

#### **Step 18: Define Subinventory Locations (Optional)**

You can define your own subinventory locations such as Inspection, Cold Storage, or Reject-Disposition. You may not need to perform this step if you have already installed and set up Oracle Inventory. See: *Defining Subinventories, Oracle Inventory User's Guide*.

**Context:** This step needs to be performed for each inventory organization.

#### **Step 19: Set Up Encumbrance Accounting for Purchase Orders with Shop Floor Destination Type (Optional)**

Oracle Enterprise Asset Management (EAM) utilizes work orders to create demand for asset maintenance.

Purchasing supports encumbering or reserving funds for shop floor destination type purchase requisitions and purchase orders associated with EAM work orders. This

feature helps in budgetary control. For example, public sector organizations can encumber funds that have been committed to a supply purchase order.

To encumber funds for purchase requisitions or purchase orders in Oracle Purchasing, you must complete prerequisite setup steps in Oracle Enterprise Asset Management. For information on these setup steps, refer to the Encumbrance Accounting section in the *Oracle Enterprise Asset Management User's Guide*.

#### **Step 20: Define Cross-Reference Types (Optional)**

An example of a cross-reference type is one used to cross-reference an item number to the part number that the supplier uses. See: Defining Cross-Reference Types, *Oracle Inventory User's Guide*.

#### **Step 21: Define Taxes (Optional)**

Define taxes and assign them recovery rates or rules. You may not need to perform this step if you have already installed and set up Oracle Payables or performed a common-applications setup. See: Setting Up Taxes, *Oracle E-Business Tax User Guide* or refer to the *Oracle E-Business Tax Implementation Guide*.

**Default:** If you skip this step, there will be no tax calculated on a requisition or purchase order and other tax attributes cannot be selected/defaulted.

#### **Step 22: Define Payment Terms (Optional)**

If you're also setting up Oracle Payables, you may already have performed this step when you set up Payables. You can set up payment terms such as 1/10 Net 30, which indicates that you get a 1% discount if you pay within 10 days and the invoice is due in 30 days.

See: Payment Terms, *Oracle Payables User's Guide*.

#### **Step 23: Set Up Approval Information**

All approvers must be employees and must have a logon user name as described in Step 14 Set Up Personnel, page 1-11.

**Note:** Even offline approvers must have a user name. An offline approver is someone who approves Purchasing documents without logging on to Oracle Applications and using the Notifications Summary window. To set up offline approvers, see: Offline Approvers, page 2-38. You can set up offline approvers at any time, as long as user names have been assigned to all approvers and Workflow has been set up.

Once all approvers have been set up as employees and set up with user names, complete your approval setup as follows:

**Context:** This step needs to be performed for each operating unit.

- Define approval groups. See: Defining Approval Groups, page 1-21. **(Required)**

- Assign approval groups. See: Assigning Approval Groups, page 1-24. **(Required)**
- Fill employee hierarchy after defining position approval hierarchies. See: Fill Employee Hierarchy Process, page 13-6. If you are using position approval hierarchies, you *must* run the Fill Employee Hierarchy process. **(Optional)**
- Define document types. See: Defining Document Types, page 1-67. **(Required with defaults)**

**Default:** Each Purchasing document (such as a Standard Purchase Order, Blanket Purchase Agreement, Quotation, or Requisition) comes with standard defaults. Update these defaults to meet your security and approval needs.

#### **Step 24: Define Lookups and Classes**

This step involves the following tasks:

- Define Purchasing lookups. See: Defining Lookup Codes, page 1-55. **(Required with defaults)**  
**Default:** An example of a default lookup code that Purchasing provides is a Price Type of Fixed. See the section referenced above for a list of the other defaults that Purchasing provides.
- Define inspection codes. See: Defining Quality Inspection Codes, page 1-57. **(Optional)**  
**Default:** If you skip this task, you will not be able to assign inspection codes during receiving.
- Define hazard classes. See: Defining Hazard Classes, page 1-53. **(Optional)**  
**Default:** If you skip this task, you will not be able to assign hazard classes to items or purchase order lines.
- Define United Nations (UN) numbers. See: Defining UN Numbers, page 1-54. **(Optional)**  
**Default:** If you skip this task, you will not be able to assign UN numbers to items or purchase order lines.

#### **Step 25: Define Standard Attachments (Optional)**

If you do not want to define standard attachments now, you can do so at any time later. See: Annotating Purchasing Documents, page 1-26. See: Attaching Notes to Purchasing Documents, page 1-33.

#### **Step 26: Define Buyers (Required)**

Employees who will use Purchasing as buyers or managers must all be defined as buyers. See: Defining Buyers, page 1-20.



### **Step 27: Define Items (Optional)**

Although you can define items at any point from this step onward, it is recommended that you set up at least one item to ensure that your flexfields are working properly.

**Default:** If you skip this step, when you create a requisition or purchase order, you will be able to enter only an item description, not an item number.

**Context:** This step needs to be performed for each inventory organization.

This step involves the following tasks.

- Define items at the master level. See: Master Level vs. Organization Level, *Oracle Inventory User's Guide* and Defining Items, *Oracle Inventory User's Guide*. Note that some Inventory fields in the Master Item window, such as the Serial number fields, are available only if Inventory is fully installed rather than shared.
- Update the default categories assigned to the items.
- Assign items at the organization level. See: Updating Organization Level Items, *Oracle Inventory User's Guide*.
- Define item relationships. See: Defining Item Relationships, *Oracle Inventory User's Guide*.

### **Step 28: Define Line Types (Required with defaults)**

See: Defining Line Types, page 1-62.

**Default:** Default line types that Purchasing provides include Goods; Services; and Outside Processing, if Work in Process is installed.

### **Step 29: Start the Purchasing Database Administrator (Required)**

See: Purchasing Database Administration, page 13-24.

### **Step 30: Define Transaction Reasons (Optional)**

Transaction reason codes allow you to provide predefined explanations for each receiving transaction. Examples of transaction reason codes you can define include No Packlist, Shortage, Recall, or Supplier Error. If you're also setting up Oracle Inventory, you may already have performed this step when you set up Inventory.

See: Defining Transaction Reasons, *Oracle Inventory User's Guide*.

### **Step 31: Define Purchasing Options (Required)**

See: Defining Purchasing Options, page 1-33.

**Context:** This step needs to be performed for each operating unit.

### **Step 32: Define Receiving Options (Required)**

You may not need to perform this step if you've already defined receiving options in **Step 6 Define Organizations and Organization Relationships**. See: Defining Receiving

Options, page 1-42.

**Context:** This step needs to be performed for all inventory organizations. Use the Change Organization function in the Purchasing menu to perform this step for each inventory organization.

### **Step 33: Open Inventory and Purchasing Accounting Periods (Required)**

This step involves the following tasks.

- Open Inventory accounting period. See: Maintaining Accounting Periods, *Oracle Inventory User's Guide*.

**Context:** This task needs to be performed for each inventory organization.

- Open Purchasing accounting period. See: Purchasing Periods, page 1-82.

**Context:** This task needs to be performed for each ledger.

### **Step 34: Set Up Transaction Managers and Resubmission Intervals**

This step involves the following tasks:

- Start the following transaction managers. See: Administer Concurrent Managers Window, *Oracle Applications System Administrator's Guide*. **(Required)**
  - Receiving transaction manager
  - Document approval manager
- Define resubmission intervals for concurrent processes. Contact your system administrator if you need help with this task. See: Defining Managers and Their Work Shifts, *Oracle Applications System Administrator's Guide*. **(Optional)**

### **Step 35: Define Suppliers (Required)**

You may not need to perform this step if you have already installed and set up Oracle Payables or performed a common-applications setup. See: Entering Supplier Information, *Oracle iSupplier Portal Implementation Guide*.

### **Step 36: Set Up Workflow Options (Required with defaults)**

Purchasing uses Oracle Workflow technology to handle requisition and purchase order approvals, automatic creation of purchase orders and releases, purchase order changes (specifically, any additional approvals those changes require), and receipt confirmation. Workflow runs in the background. It automates these procurement activities whenever you submit a document for approval, create a requisition, or change a purchase order.

**Default:** Purchasing provides default functionality in these Workflow-automated processes. For example, one default functionality is for the automatic document creation workflow to create purchase orders automatically from approved requisition lines. If you do not want this default functionality, you can easily change it in the Oracle Workflow Builder.

For descriptions of the other defaults that Purchasing provides, see: Choosing Workflow Options, page 1-85.

### **Step 37: Submit Workflow-Related Processes**

Start the following Workflow-related processes, if you haven't already done so in the previous step:

- Send Notifications for Purchasing Documents process. See: Send Notifications for Purchasing Documents, page 13-36. **(Required)**
- Workflow Background Engine. Whether you need to submit this process depends on the options you chose or the defaults you accepted as described in the section Choosing Workflow Options, page 1-85. For instructions on submitting the Workflow Background Engine, see: To Schedule Background Engines, *Oracle Workflow Guide*. **(Required with defaults)**

**Default:** If you chose to accept the default Workflow options that Purchasing provides, you must start the Workflow Background Engine.

### **Step 38: Define Descriptive Flexfields (Optional)**

If you do not want to define descriptive flexfields now, you can define them at any time. See: Planning and Defining Descriptive Flexfields, *Oracle Applications Flexfields Guide*.

### **Step 39: Set Up Automatic Sourcing (Optional)**

You can set up Purchasing to automatically default source document information from a purchase agreement or catalog quotation onto a requisition or purchase order line for a particular item and supplier. Or you can default just a supplier and optionally a supplier site. See: Setting Up Automatic Sourcing, page 5-27.

You can set up automatic sourcing now or at any time on an ongoing basis.

### **Step 40: Perform Additional System Administrator Setup**

This step involves the following tasks:

- Define custom menus. **(Optional)**
- Define new responsibilities based on your business and security needs. See: Oracle E-Business Suite System Administrator's Guide, *Oracle Applications System Administrator's Guide*. **(Optional)**
- Define user names. Purchasing users must have user names, and the user names must be linked to an employee name. See: Users Window, *Oracle Applications System Administrator's Guide*. **(Required)**
- Define printers if you haven't already. See: Setting Up Your Printers, *Oracle Applications System Administrator's Guide*. **(Optional)**

### Step 41: Define Manufacturing System and User Profiles (Required)

See: Setting User Profile Options, *Oracle Applications System Administrator's Guide*. See: Common User Profile Options, *Oracle Applications System Administrator's Guide*. See: Profile Options in Purchasing, page C-1.

**Context:** This step needs to be performed for each operating unit.

## Defining Locations

Use the Locations window to define ship-to, receiving, and other location information for Purchasing documents.

### To set up locations for Purchasing:

1. Navigate to the Locations window.
2. For information on the Name, Description, Inactive Date, Global, and Address Details fields, follow the instructions in *Setting Up Locations, Oracle HRMS Enterprise and Workforce Management Guide* or see the online help for the Location window.

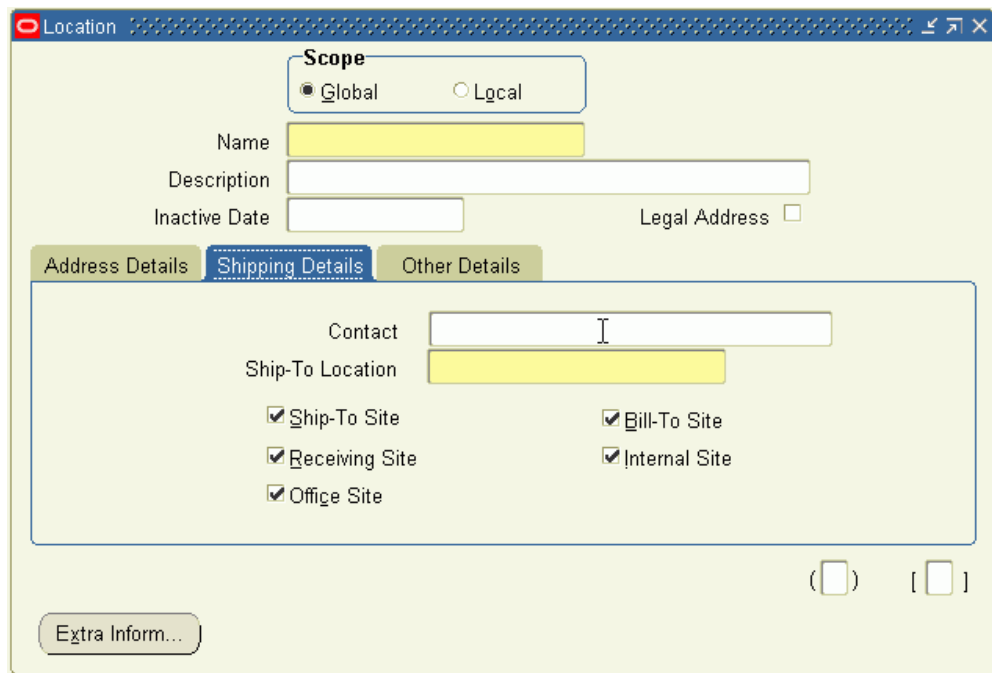

The screenshot shows the Oracle Location window with the following fields and options:

- Scope:** Radio buttons for  Global and  Local.
- Name:** A text input field.
- Description:** A text input field.
- Inactive Date:** A date input field.
- Legal Address:** A checkbox.
- Address Details:** A tabbed region with three tabs: Address Details, Shipping Details (selected), and Other Details.
- Shipping Details:** Contains the following fields and options:
  - Contact:** A text input field.
  - Ship-To Location:** A text input field.
  - Ship-To Site
  - Receiving Site
  - Office Site
  - Bill-To Site
  - Internal Site
- Extra Inform...:** A button at the bottom left.
- Navigation:** Two empty square buttons at the bottom right.

3. Fill in information in the Shipping Details tabbed region.

**Note:** Selecting the check boxes means that you are making the location Name a valid location in the list of values on a Purchasing

document. For example, selecting Ship-To Site makes the location Name a valid choice in the list of values for the Ship-To field on a purchase order header. Note that if you define a default Ship-To or Bill-To Location in the Supplier-Purchasing region of the Financials Options window for your organization, that is the location that *defaults* onto your purchase orders. But if you wanted to change that default, the location Name that you define here and enable as a Ship-To or Bill-To site is *available* in the list of values for you to choose from in the Ship-To or Bill-To fields.

*Contact:* Optional contact name for the location Name.

*Ship-To Location:* Usually the same as the location Name. You could select a separate, previously defined Ship-To Location—for example, if you wanted to create a location Name, Office A, and specify Receiving Dock A as its Ship-To Location. Note, however, that once you specify a separate Ship-To Location, you can no longer enable the location Name as a Ship-To Site. In this example, Receiving Dock A is the ship-to site for Office A; therefore, Office A itself cannot also be the ship-to site.

*Ship-To Site:* Select this option to make the location Name a valid ship-to organization on a purchase order or requisition.

*Receiving Site:* Select this option to make the location a valid receiving Location when creating a receipt or receiving transaction.

*Office Site:* Select this option to indicate that this location Name is an office site, such as a field office.

*Bill-To Site:* Select this option to make the location Name a valid bill-to site. The Bill-To Site, which is used by Payables, is specified on a purchase order header.

*Internal Site:* Select this option to make the location a valid internal ship-to location when creating an internal requisition.

4. Optionally fill in information in the Other Details tabbed region.

*Inventory Organization:* Select an inventory organization within which this location will be available in the list of values on a Purchasing document. By selecting no inventory organization, this location becomes available on Purchasing documents in all organizations.

*EDI Location:* If you use Electronic Data Interchange (EDI) to receive Advance Shipment Notices (ASNs) or ASNs with billing information (ASBNs), enter a defined location. This location should match the ship-to location specified on an ASN or ASBN. See: Advance Shipment Notices (ASNs), page 9-15.

5. If you want to use the Extra Information button to enter additional information required by your business, see: Entering Extra Information, *Oracle HRMS Enterprise*

and *Workforce Management Guide* or see the online help for that window.

## Defining Buyers

Use the Buyers window to define and maintain your buyers. Buyers can review all requisitions using the Requisitions window, and *only* buyers can enter and autcreate purchasing documents. See the Document Types window for rules governing access to documents. See: Defining Document Types, page 1-67.

### Prerequisites

- Define employees before performing this step. See the online help for the Enter Person window for details.
- Define locations before performing this step. See: Defining Locations, page 1-18.

#### To define buyers:

1. Navigate to the Buyers window.
2. If you are defining a new buyer click Add Buyer in the Buyers window. To enter changes to an existing buyer use the Search region to enter the buyer's name in the Buyer field, the category assigned to the buyer in the Category field, or the buyer's ship-to location in the Ship-to field. Once you have completed one or all of these fields click Go.

The screenshot shows the Oracle Personnel Buyers window. At the top, there's a navigation bar with 'ORACLE Personnel' and links for 'Diagnostics', 'Home', 'Logout', 'Preferences', and 'Help'. The user is logged in as 'CBROWN'. The main area is titled 'Buyers' and includes a search section with fields for 'Buyer', 'Category', and 'Ship To'. Below the search fields are 'Go' and 'Clear' buttons. A table below the search section has columns for 'Buyer', 'Category', 'Ship-To', 'Begin Date', and 'End Date'. The 'Category' field is currently selected, showing a dropdown menu with 'Item Category.Commodity' as an option. The 'Begin Date' and 'End Date' fields are set to '25-Apr-2006'. There are 'Add Buyer', 'Cancel', and 'Save' buttons at the bottom of the form.

3. Enter the Name of an employee who you want to define as a buyer. If the name you want does not appear in the list of values, use the Enter Person window to enter that person as an employee.
4. Enter the default purchasing Category of the goods the buyer typically orders.

Purchasing defaults this value in the Category field when you are autocreating documents. See: *Defining Categories, Oracle Inventory User's Guide*.

5. Enter the name of the ship-to location for which the buyer typically creates purchase orders. Purchasing defaults this value when you are autocreating documents.
6. Enter the Start Date that you want to initiate the responsibilities for a buyer. The default is the current date.
7. Enter the End Date after which the employee is no longer a buyer.
8. Click Save.

## Defining Approval Groups

Use the Approval Groups window to define and update approval groups. Once you have defined an approval group here, you can then use it to assign approval functions to jobs or positions in the Approval Assignments window. You cannot delete an approval group that is used in an active assignment. You can enable or disable the entire approval group, or you can enter inactive dates for individual approval rules.

### Prerequisites

- Define employees before performing this step. See the online help for the Enter Person window for details.
- Review how your choices in this window affect your approval routing. See: *Defining Approval Authorization Rules*, page 2-13.

#### **To define approval groups:**

1. Navigate to the Approval Groups window.

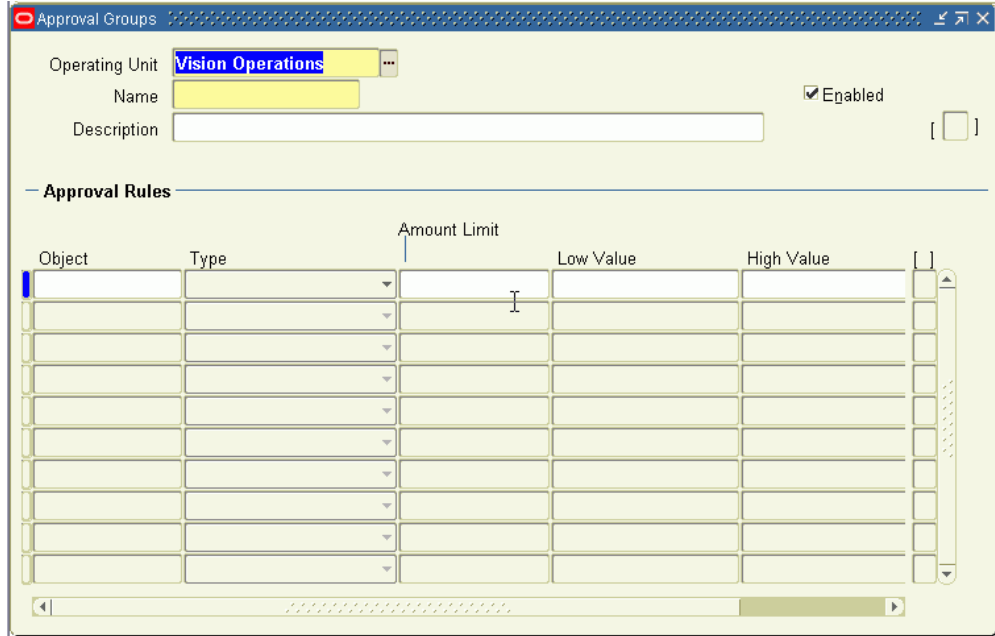

2. Select the Operating Unit for this approval group.
3. Enter the Name of the approval group. You can change existing approval group names, but names must be unique.
4. Select Enabled to permit the approval group to be assigned to a position/job in the Approval Assignments window.
5. Choose one of the following Objects:

*Account Range - (Required)* For this option, you enter the accounting flexfields for the Low and High Values. Include Type rules identify accounts that you want to be included on the document. Exclude Type rules identify accounts that you do not want on the document. *If you do not enter a rule for an account, the default is to exclude the account. If you enter only an Exclude Type rule, Purchasing does not automatically include everything else.*

For example, entering only the following account includes account 01.000.0451 and excludes all else:

---

Account Range	Type	Low Value	High Value
01.000.0451	Include	01.000.0451	01.000.0451

---

Entering only the following account excludes all accounts:



Account Range	Exclude	01.000.0451	01.000.0451
---------------	---------	-------------	-------------

Entering only the following two accounts includes all accounts except 01.000.0451:

Account Range	Include	00.000.0000	ZZ.ZZZ.ZZZZ
	Exclude	01.000.0451	01.000.0451

The Inactive Date is optional, but you must enter an Amount Limit for Include Type rules.

*Document Total* - (Required) The document total refers to the monetary limit on an individual document. For this option, the Type defaults to Include, and you can enter only the Amount Limit (required) and the Inactive Date (optional).

*Item Category Range* - For this option, you enter the purchasing category flexfields for the Low and High Values. Include Type rules identify manufacturing categories that you want to be included on the document. Exclude Type rules identify categories that you do not want on the document. If you do not define a rule for a category, the default is Include. The Inactive Date is optional, but you must enter an Amount Limit for Include Type rules.

*Item Range* - For this option, you enter the item flexfields for the Low and High Values. Include Type rules identify items that you want to be included on the document. Exclude Type rules identify items that you do not want on the document. If you do not define a rule for an item, the default is Include. The Inactive Date is optional, but you must enter an Amount Limit for Include Type rules.

*Location* - The location refers to the deliver-to location on a requisition as well as the ship-to location on purchase orders and releases. Include Type rules identify locations that you want to be included on the document. Exclude Type rules identify locations that you do not want on the document. For this option, you enter the location in the Low Value field. If you do not define a rule for a location, the default is Include. The Inactive Date is optional, but you must enter an Amount Limit for Include Type rules.

6. Select the rule Type: Include or Exclude indicates whether to allow objects that fall within the selected range.
7. Enter the Amount Limit. This is the maximum amount that a control group can authorize for a particular object range. This field is required only for Include type rules.
8. Enter the Low Value. This is the lowest flexfield (accounting, purchasing category,

or item) in the range pertinent to this rule. When the object is Location, enter the location. You cannot enter this field when the object is Document Total.

9. Enter the High Value. This is the highest flexfield (accounting, purchasing category, or item) in the range pertinent to this rule. You cannot enter this field when the object is Location or Document Total.
10. Enter the Inactive Date on which Purchasing will no longer use this rule in formulating the group.
11. Save your work.

## Related Topics

Defining Approval Assignments, page 1-24

Approval Authorization Rules, page 2-12

Defining Approval Authorization Rules, page 2-13

Using Approval Assignments, page 2-15

## Assigning Approval Groups

Use the Assign Approval Groups window to assign approval groups and approval functions to positions or jobs. If you are using approval hierarchies (the Use Approval Hierarchies option in the Financials Options window is enabled), you must first use the Approval Groups window to establish rules for your approval groups. Then you can assign approval groups to positions in this window. When you are not using approval hierarchies, you can use this window to assign approval groups and approval functions to jobs within your organization.

## Prerequisites

- Define approval groups before performing this step. See: Defining Approval Groups, page 1-21.
- Review how your choices in this window affect your approval routing. See: Using Approval Assignments, page 2-15.

### To assign approval groups:

1. Navigate to the Assign Approval Groups window.

Operating Unit: Vision Operations

Position:

Job:

Organization:

**Approval Assignments**

**Effective**

Document Type	Approval Group	From	To	

2. Select the Operating Unit for this approval group assignment.
3. Enter the Position for which you want to assign approval groups and approval functions. If the Use Approval Hierarchies option in the Financial Options window is not enabled, this field is not applicable.
4. If you are not using approval hierarchies, enter the Job.
5. Select the approval function you want to assign to this position or job.
6. Enter the approval group that you want to assign to the selected position or job. The list of values includes only enabled approval groups with at least one approval rule. See: Defining Approval Groups, page 1-21.
7. Enter the Start Date and End Date for the assignment.
 

**Important:** The start and end dates that you assign here are the effectivity dates of the assignment. When the system date reaches the end date of the assignment, the rule no longer applies. There is *no* explicit warning that the rule is no longer in effect.
8. Save your work.

## Related Topics

Defining Financials Options, *Oracle Payables User's Guide*

Representing Jobs and Positions, *Oracle HRMS Enterprise and Workforce Management Guide*

Defining Approval Groups, page 1-21

Approval Authorization Rules, page 2-12

Defining Approval Authorization Rules, page 2-13

Using Approval Assignments, page 2-15

## Annotating Purchasing Documents

Purchasing provides you with powerful features to create attachments for your purchasing documents. You can provide *unlimited* text, specify who can review the attachments, and print text attachments onto your purchase orders. You can even modify existing attachments to personalize your messages for different suppliers. You can easily provide all the information you need when you create your purchasing documents. You should be able to:

- Provide unlimited text attachments on your purchasing documents
- Designate the appropriate people who can review the attachments
- Print text attachments on your purchase orders and RFQs for the supplier to review
- Reuse attachments on different documents
- Copy and modify existing attachments to speed up data entry
- Copy attachments from your requisitions to your RFQs and purchase orders
- Provide standard attachments for an item that you can reference whenever you create a purchasing document for that item

## Major Features

### Copy

You can copy an existing long attachment so that you can customize it without having to retype the entire attachment. This feature is particularly useful if you have a lengthy document that you want to modify for different suppliers.

### Usage

You can indicate who has access to your long attachments. You indicate whether the

attachment is for an approver, receiver, buyer, or supplier. Or you can indicate that you want the attachment for internal use only. You can also enter attachments that will be displayed during invoice matching in Accounts Payable. To understand how to enter and review attachments for different usages, see: *Managing Attachments*, page 1-28.

### **Using Brief Notes**

You can provide brief notes on most of your documents. Unlike attachments, you cannot copy notes from one document to the next. You should provide notes when the attachment contains no more than 240 characters, you do not want to reuse the note on other documents, or you do not want to format the note. Otherwise, you should use attachments to provide additional text for your documents.

### **Using Attachments**

You can provide as much text as you want for your documents. You can provide attachments at the header and line level for the following documents:

- Requisitions
- Standard and Planned Purchase Orders (also shipment level)
- Blanket Purchase Agreements
- Releases (header and shipment levels)
- Contract Purchase Agreements (header level only)
- RFQs
- Quotations
- Receipts (line level only)
- Receiving Transactions (line level only)

You can also provide attachments for your items. When you create an attachment, you designate whether you want the attachment to be available to the supplier, receiver, approver, or buyer. Or, you can designate that you want the attachment to appear to anyone who has access to that particular document on-line. To understand how to create attachments for different usages, see: *Managing Attachments*, page 1-28.

### **Related Topics**

*Attaching Notes to Purchasing Documents*, page 1-33

*Managing Attachments*, page 1-28

## Managing Attachments

You can provide attachments for your items. When you reference an item on a purchasing document, Purchasing makes the corresponding item attachments available for you to review. Purchasing also prints text attachments on your purchase orders and RFQs if you choose Supplier as the usage when you create the item attachment.

### Requisition and Standard Purchase Order Attachments

You can create attachments for your requisition headers and lines. When you AutoCreate a requisition line onto a purchase order, Purchasing copies the attachments from the requisition header and line to the corresponding purchase order line. As a buyer, you can provide additional attachments to a purchase order even after you AutoCreated it from a requisition.

If the purchase order line references more than one requisition line, Purchasing copies only the header and line attachments from the requisition line that is the basis for the purchase order line. For example, if you place multiple requisition lines onto a single purchase order line, Purchasing copies only the requisition header and line attachments from the line where you use the Copy option.

For each requisition line copied, the corresponding header level attachment is copied. For example, you have a requisition with 3 lines and they have 3 line level attachments and a header level attachment. You then AutoCreate this requisition to a purchase order with 3 lines, each of the 3 lines in the purchase order would have the specific line attachment and the common header attachment.

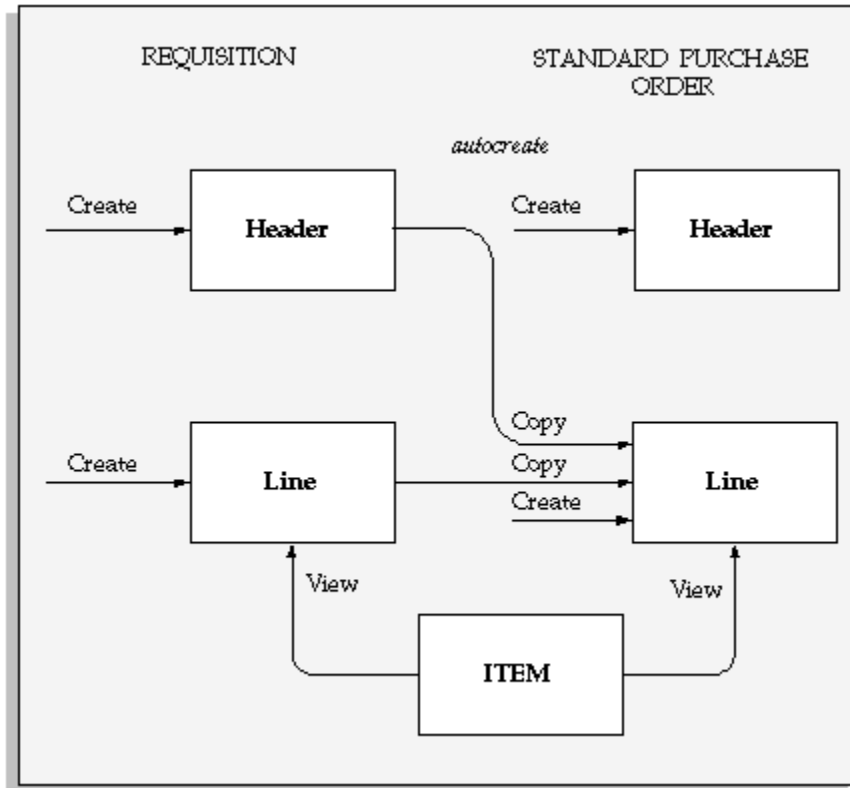

### Blanket Purchase Agreement and Release Notes

You can create long attachments for your blanket purchase agreements at the header and line level. You can review the blanket purchase agreement header attachment on the corresponding release header, and you can enter new attachments on the release header. You can also review the blanket agreement line attachment on the corresponding release shipment, and you can enter new attachments for the shipments. Purchasing does not copy requisition attachments to a blanket agreement or release when you AutoCreate a release.

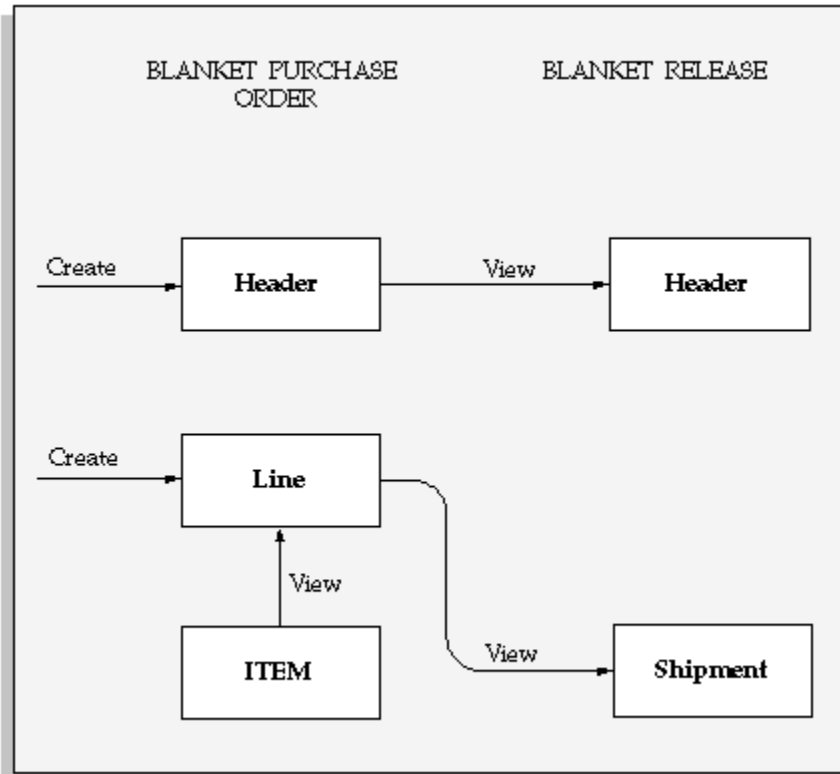

### Requisition, RFQ, and Quotation Notes

Similar to standard purchase orders, Purchasing copies requisition header and line attachments to the corresponding RFQ line. Purchasing copies all RFQ header and line attachments to the corresponding quotation header and line when you copy a quotation using the Entire RFQ or RFQ Header and Lines options in the Copy Document window. Purchasing copies only the attachments from the RFQ header to the quotation header when you copy a quotation using RFQ Header Only. If you choose the Selective option when copying a quotation, Purchasing copies the RFQ header attachments to the quotation header and lets you decide which line attachments you want to copy to the quotation line.



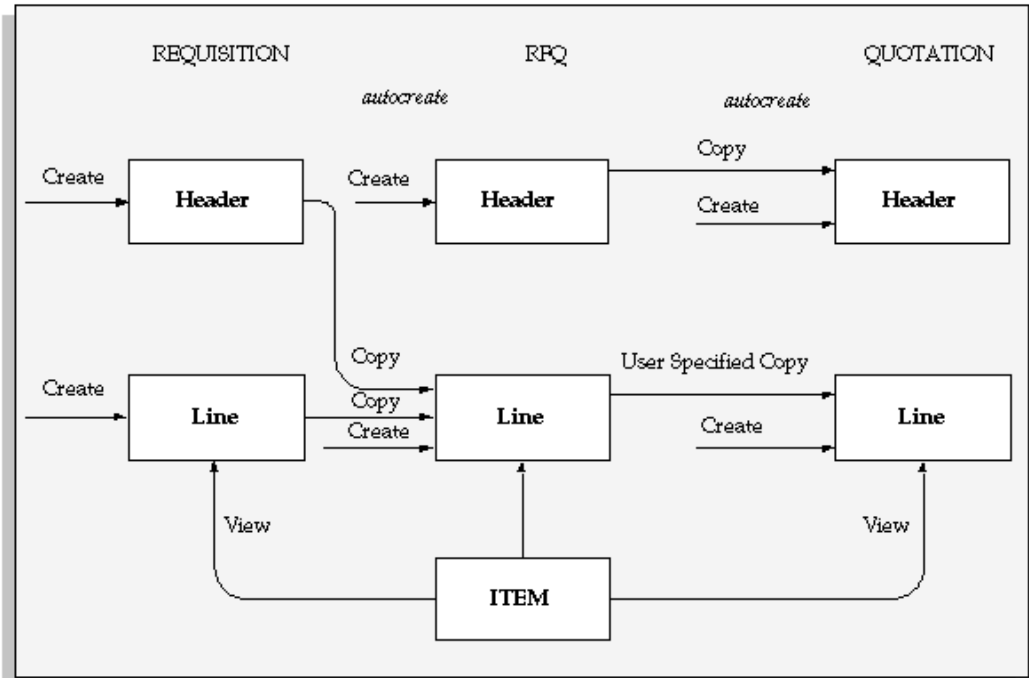

### Printing Attachments

You can print text attachments on your purchase orders and RFQs. To print an attachment on a purchase order or an RFQ, simply designate Supplier as the usage for the attachment. Purchasing prints these attachments on the corresponding purchase order or RFQ. Purchasing prints as much as possible on each page and continues printing on the next page where applicable.

Purchasing also prints item attachments and attachments with usage Receiver on the Receipt Traveler.

### Usages in Attachments

You can enter unlimited attachments on any requisition, purchase order, quotation, or request for quotation (RFQ). You decide which standard attachments to print on your documents and reports. You can easily combine the one-time attachments you enter for a specific document with predefined standard attachments. You can even create a new attachment directly from an existing attachment or use attachments to enter long descriptions for the items you purchase.

#### Understanding Usages

Purchasing provides you with a list of predefined usages you can use depending on the type of document you create. The following list shows the usages available for each document you can create.

- **Supplier**

You can use this usage on purchase orders, RFQs, quotations, requisitions, and for

items. Purchasing prints all Supplier text attachments on your documents.

- **Receiver**

You can use this usage on purchase orders, quotations, RFQs, receipts, requisitions, and for items. Purchasing displays these attachments to the receiver in the receiving windows and prints text attachments on the Receipt Traveler.

- **Approver**

You can use this usage on requisitions. Purchasing displays these attachments to the approvers when they approve your requisitions.

- **Buyer**

You can use this usage on requisitions. Purchasing displays these attachments to the buyers when they create purchase orders from your requisitions.

- **[Document] Internal**

You can enter these attachments only on a specific [Document]. Reference this usage when you want to enter information specific to a purchase order, quotation, RFQ, receipt, requisition, or item. Purchasing does not print or display these attachments outside the window you use to enter the document. RCV Internal attachments, however, are printed on the Receipt Traveler.

- **Payables**

You can use this usage on purchase orders. Purchasing displays these attachments during invoice matching in Accounts Payable.

#### **Defining a Standard Attachment**

To define a standard attachment, you simply provide the usage for this attachment, a meaningful and unique name, and the attachment itself. You can also provide a start date and end date to control the availability of this attachment. Purchasing defaults today's date as the start date for standard attachments. You can easily inactivate an attachment by entering an end date for it. You cannot use a standard attachment on a document after the end date has expired. You define standard attachments in the Documents window. See: *Using Notes, Oracle Common Application Components*.

#### **Referencing a Standard Attachment**

After you define your standard attachments, you can reference them on your documents. You can reference as many standard attachments to your documents as you want.

### **Related Topics**

Attaching Notes to Purchasing Documents, page 1-33

## Attaching Notes to Purchasing Documents

You can *attach* files, such as notes, comments, spreadsheets, and graphics to your application data.

For example, in Purchasing, you can attach files to purchasing documents.

An attached file may include comments, for example if the buyer would like to be notified when an item fails inspection.

### To attach notes to purchasing documents:

1. Choose the Attachments icon.

## Related Topics

About Attachments, *Oracle Applications User's Guide*

Working With Attachments, *Oracle Applications User's Guide*

Annotating Documents, page 1-26

Managing Attachments, page 1-28

## Defining Purchasing Options

Use the Purchasing Options window to define default values and controls for functions throughout Purchasing. You can often override purchasing options when you are creating documents.

You can define specific categories of options:

- **Document Control**

Define control options, such as the receipt close point. See: Document Control Options, page 1-34.

- **Document Defaults**

Define default options, such as the minimum release amount. See: Document Default Options, page 1-38.

- **Receipt Accounting**

Define the accrual method and the accounts which Purchasing will use as for receipt accounting. See: Receipt Accounting Options, page 1-40.

- **Document Numbering**

Define the numbering method, numbering type, and next number for each of your documents. See: Document Numbering Options, page 1-41.

## To define Purchasing Options:

1. Navigate to the Purchasing Options window.

**Document Control**

Price Tolerance (%) 10

Price Tolerance Amount (USD)

Enforce Full Lot Quantity Advisory

Receipt Close Point Received

Cancel Requisitions Optionally

Security Hierarchy QA.Hierarchy03

SBI Buying Company Identifier

Output Format PDF

Maximum Attachment Size (in MB) 5

Enforce Price Tolerance (%)

Enforce Price Tolerance Amount

Display Disposition Messages

Notify if Blanket PO exists

Allow Item Description Update

Enforce Buyer Name

Enforce Supplier Hold

Gapless Invoice Numbering

RFQ Required

**Document Defaults**

Requisition Import Group-By Item

Internal Requisition Order Type Internal

Internal Requisition Order Source Internal

Receipt Close Tolerance (%) 0

Invoice Close Tolerance (%) 0

Quote Warning Delay 7

Line Type Goods

Rate Type Corporate

Match Approval Level 3 Way

Price Break Type Cumulative

Price Type Cost Plus Fee

Minimum Release Amount (USD)

**Receipt Accounting**

Accrue Expense Items At Receipt

Accrue Inventory Items At Receipt

Automatic Offset Method Account

\* Expense AP Accrual Account 01-000-2220-0000-000

**Document Numbering**

Document	Entry	Type	Next Number
RFQ Number	Automatic	Numeric	306
Quotation Number	Automatic	Numeric	503
PO Number	Automatic	Numeric	6190
Requisition Number	Automatic	Numeric	18198

**Additional Information**

Cancel Save

About this Page Privacy Statement Copyright (c) 2008, Oracle. All rights reserved.

2. Select the Purchasing Options Operating Unit.

### Document Control Options

3. Enter the Price Tolerance Percentage. This is the percentage by which the autogenerated purchase order line price cannot exceed the requisition line price. If you select Enforce Price Tolerance Percentage, you can create, but not approve, purchase orders for which this tolerance is exceeded. There is no restriction on how much a price can decrease, but changes to the line (quantity or unit of measure for example) may cause the price tolerances to be exceeded.

**Note:** If the price on a requisition line is zero, then price tolerance checks do not apply.

4. Enter the Price Tolerance Amount. This is the dollar amount by which the autocreated purchase order line price cannot exceed the requisition line price.

**Note:** If you set both price tolerance percentage and amount values, the system will apply the more restrictive of the two.

5. Select one of the following values for the Enforce Full Lot Quantity option:

*None:* The requisition quantity is not rounded to the lot quantity.

*Automatic:* The requisition quantity is forced to the rounded quantity.

*Advisory:* An advisory message suggesting rounding and a suggested rounding quantity are displayed, but you can override.

Enforce Full Lot Quantity is used for rounding quantities on Internal Requisitions, for example:

- System Options Enforce Full Lot Quantities = Yes
- Items Rounding Factor = 75%
- Items Unit of Issue = DZ
- Unit of Measure on Internal Requisition = Each

If the user enters 6 Each on the Internal Requisition, the quantity will be rounding to 0. If the user enters 11 Each on the Internal Requisition, the quantity will be rounded to 12 Each.

See: Overview of Requisitions, page 3-1.

6. Select the Receipt Close Point, which is when the shipment is closed for receiving: Accepted (passed inspection), Delivered, or Received. Note that you need to set the receipt close tolerance percentage in the Default Options window. See: Defining Default Options, page 1-38.

7. The Cancel Requisitions options apply only to requisitions from which purchase orders were autocreated. Select one of the following:

*Always:* When canceling the purchase order, Purchasing also cancels the requisition.

*Never:* When canceling the purchase order, Purchasing does not cancel the requisition, so it is again available for inclusion on a purchase order.

*Optional:* When canceling the purchase order, you are given the option to cancel the requisition. See: Controlling Documents, page 2-57.

8. Select a Security Hierarchy, which is a position hierarchy from the Position Hierarchy window. When the Security Level is set to Hierarchy for a document in the Document Controls window, this position hierarchy governs access security for

the document.

**Important:** This field is enterable only when the form is accessed from the Purchasing menu.

9. If you have selected Gapless Invoice Numbering for the entire business unit or for a specific supplier site, enter the SBI Buying Company Identifier. This is an identifier included in the invoice number created by the Pay on Receipt process, as well as for debit memos resulting from return receipts, and invoices resulting from retroactive purchase price adjustments. This portion of the invoice number identifies the buying business unit and is included as follows:

**<Prefix>-<SBI Buying Company Identifier>-<Selling Company Identifier>-<Invoice Type Code>-<Seq #>**

Where:

- Prefix is specified by the profile option *PO: ERS Invoice Number Prefix*. (optional) and only applies to invoices resulting from the Payment on Receipt process. See: Profile Options in Purchasing, page C-1. See: Payment on Receipt, page 13-16.
- SBI Buying Company Identifier is a unique code for the operating unit. This is defined as a Purchasing Option and need not be unique.
- Selling Company Identifier is a code for the supplier site. It is defined in the supplier site window. The Selling Company Identifier does not need to be unique within the same supplier; however, it must be unique across suppliers.
- Invoice Type Code:
  - **ERS** (Evaluated Receipt Settlement) for Pay on Receipt invoices
  - **RTS** (Return to Supplier) for Debit Memos
  - **PPA** (Purchase Price Adjustment) for invoices resulting from a retroactive price adjustment
- Seq# is a gapless sequence number defined for each buying company/selling company/invoice type combination when Gapless Invoice Numbering is enabled.

All segments of the gapless invoice number are separated with a hyphen.

10. The PO Output Format selection defines the output format for purchase orders sent to the supplier using print, e-mail, or fax. It also enables functionality related to that output format.

*PDF:* Purchase orders are output in the Adobe Portable Document Format (PDF). You can view the purchase order fully formatted from the Enter Purchase Order window, Purchase Order Summary window, Change History page, Oracle iProcurement, and Oracle iSupplier Portal. You can also communicate the purchase order to the supplier from the Purchase Order Summary window.

*Text:* Purchase orders are output in text.

**Note:** Your ability to communicate the purchase order to the supplier from the Approval window remains the same with either setting. Only the formatting of the output changes.

See: Setup Purchase Order Communication to Suppliers, page 1-75

11. If the PO Output format is PDF, enter the Maximum Attachment Size. This indicates the maximum file size, in megabytes, that is allowed as a File type attachment to an e-mailed purchase order.  
See: About Attachments, *Oracle Applications User's Guide*.
12. Select Enforce Price Tolerance Percentage if you want Purchasing to enforce the price tolerance percentage.
13. Select Enforce Price Tolerance Amount if you want Purchasing to enforce the price tolerance amount.
14. Select Display Disposition Messages if you want to see any disposition messages defined against inventory items when they are placed on requisitions.
15. Select Notify If Blanket PO Exists if you want to be notified of existing blanket purchase agreements when you create a requisition, purchase order, or blanket purchase agreement line for the item. If you sourced the item, you see the following message: Blanket purchase order [number] already exists for this item. Your requestors can directly create a release for the blanket purchase agreements instead of creating a requisition or purchase order if you allow your requestor to enter releases. See: Viewing and Responding to Notifications, page 2-29.
16. You can define for each item whether you allow updating of the item description during the creation of requisition, RFQ, quotation, or purchase order lines. This update affects *only* the line you are creating. Select Allow Item Description Update if you want Yes to be the initial default of the Allow Description Update attribute when you are defining a new item.
17. Select Enforce Buyer Name to enforce entry of only your name as the buyer on purchase orders. Otherwise, you can enter the name of any active buyer. See: Defining Buyers, page 1-20.

18. Select Enforce Supplier Hold if you do not want to be able to approve purchase orders created with suppliers that are on hold. Use the Suppliers window to place suppliers on hold. See: Suppliers, *Oracle iSupplier Portal Implementation Guide*.

**Note:** Even if you put a supplier on hold in the Suppliers window, you can still approve a purchase order to that supplier if Enforce Supplier Hold is not checked here.

19. Select Gapless Invoice Numbering to enable gapless (no breaks in numbering) invoice number generation for your buying organization during Pay on Receipt processing. See: Payment on Receipt, page 13-16.

Note that you can enable gapless SBI numbering for the entire operating unit with this setting or limit it to a supplier site(s) in the Supplier Site window.

20. Select RFQ Required to require an RFQ for an item before you can autocreate the corresponding requisition line onto a purchase order. You can override this value for each item or requisition line.

#### **Document Default Options**

21. Select one of the following Requisition Import Group By options for requisitions imported through the requisition open interface: All (not grouped), Buyer, Category, Item, Location, or Supplier. See: Requisition Import Process, page 13-29.
22. Select the default Order Type for internal requisitions.

**Important:** The Order Type field is visible only if the application Oracle Order Management is installed.

Order types are defined in Order Management. The order type you choose here is the type that Purchasing uses to create sales orders from internal requisitions.

23. Select the default Order Source for internal requisitions.  
Purchasing defaults and only uses Internal. This is the source OrderImport uses to transfer internal requisitions from Purchasing to Order Management.
24. Enter the Receipt Close tolerance percentage for your shipments. Purchasing automatically closes a shipment for receiving if it is within the receiving close tolerance at the receiving close point. Set the receiving close point in the Control Options window. You can override this option for specific items and orders. See: Defining Control Options, page 1-34.
25. Enter the Invoice Close tolerance percentage for shipments. Purchasing automatically closes a shipment for invoicing if it is within the invoicing close tolerance at billing, when Payables matches invoices to purchase orders or receipts.



You can override this option for specific items and orders. See: Defining Control Options, page 1-34.

26. Enter the Quote Warning Delay. This is the number of days before a quotation expires that you want to receive an expiration warning. When a quotation is due to expire within the number of days you provide here, you receive the following message in the Notifications Summary window: Quotations active or approaching expiration: [number]. See: Viewing and Responding to Notifications, page 2-29.
27. Select a default Line Type for requisition, RFQ, quotation, and purchase order lines. When you create any of these documents, the line type is part of your item information. You can override the line type for each document line. See: Defining Line Types, page 1-62.

**Important:** This field is enterable only when the form is accessed from the Purchasing menu.

28. Select the currency Rate Type that defaults on requisitions, purchase orders, RFQs, and quotations. If the Rate Type is User, you can override this default for each document line. If either your functional currency (defined in your ledger) or your transaction currency (the currency you enter in a purchasing document window) is Euro (the European Monetary Unit currency), and the other is another European currency, Purchasing defaults in the appropriate conversion Rate Type, Rate, and Rate Date. See: Defining Conversion Rate Types, *Oracle General Ledger User's Guide*.
29. Select one of the following options for Match Approval Level:

*Two-Way:* Purchase order and invoice quantities must match within tolerance before the corresponding invoice can be paid.

*Three-Way:* Purchase order, receipt, and invoice quantities must match within tolerance before the corresponding invoice can be paid.

*Four-Way:* Purchase order, receipt, inspection, and invoice quantities must match within tolerance before the corresponding invoice can be paid.

See: Receiving Controls, Options, and Profiles, page 9-7.

**Note:** The Invoice Match Option in the purchase order Shipments window and the Match Approval Level here are independent options. The Invoice Match Option determines whether Payables performs invoice matching to the purchase order or the receipt. You can perform whichever Invoice Match Option you want on a shipment regardless of the Match Approval Level you choose here.

30. Select the Price Break Type that defaults on blanket purchase orders:

*Cumulative:* Price breaks apply to the cumulative quantity on all release shipments for the item.

*Non-cumulative:* Price breaks apply to quantities on individual release shipments for the item.

31. Select the Price Type that defaults on purchase orders. Use the Lookup Codes window to define price types. See: Defining Lookup Codes, page 1-55.
32. Enter the Minimum Release Amount that defaults on blanket, contract, and planned purchase orders. This amount is in your functional currency. See: Overview of Multi-Currency Accounting, *Oracle General Ledger User's Guide*.

### **Receipt Accounting Options**

33. Choose one of the following Accrue Expense Items options:

*At Receipt:* Accrue expense items upon receipt. You can override this flag in the Shipment Details window when you are entering purchase orders and releases.

*Period End:* Accrue expense items at period end.

**Important:** When using Cash Basis Accounting, you should set this option to Period End, but you will not normally run the Receipt Accrual - Period End process.

34. For Accrue Inventory Items, you currently have only one choice: On Receipt.
35. An offset is an accounting entry that is created to offset, or balance, another accounting entry. Automatic Offset Method is the method used to automatically create the account for the offsetting transaction. Here the offsetting account is the Receiving Inspection Account, which offsets the Accrual Account transaction at the time of receipt and the Charge Account at the time of delivery. The Automatic Offset Method controls which of the two accounts are used as the base account and which as the overlay account, as well as which segment is used to overlay the base account segment.

Choose one of the following Automatic Offset Method options:

*None:* No substitutions are made and the Receiving Inspection account for the destination organization is used.

*Balancing:* The base account is the Receiving Inspection Account for the destination organization and the balancing segment is overlaid with the balancing segment of the Charge Account.

*Account:* The base account is the Charge Account and the account segment is overlaid with the account segment of the Receiving Inspection Account.

**Note:** The Automatic Offset Method is not supported with retroactive pricing, shared services, and drop shipment flows.

36. Enter the default Expense AP Accrual Account.

### Document Numbering Options

37. Select the [Document] Number Entry method for RFQ, quotation, purchase order, and requisition numbers:

*Automatic:* Purchasing automatically assigns a unique sequential number to each document when you create the document.

*Manual:* You provide a document number manually when you enter the document.

**Important:** You can change the method of entering document numbers at any time. If you originally allow manual entry and switch to automatic entry, make sure to enter a Next Number that is higher than the highest number you assigned manually.

38. Select the [Document] Number Type you want Purchasing to use for RFQ, quotation, purchase order, and requisition numbers: Numeric or Alphanumeric.

**Important:** If you choose Automatic document number entry, you can *generate* only numeric document numbers, but you can still *import* either numeric or alphanumeric values from another purchasing system.

**Important:** If you import purchasing documents from a foreign system that references alphanumeric numbers, you must choose Alphanumeric as your number type, regardless of your numbering method.

If you choose Manual document number entry, you can choose numeric or alphanumeric numbers. You can change the document number type from Numeric to Alphanumeric whenever you want. You can change the document number type from Alphanumeric to Numeric only if all your current document numbers are numeric.

**Important:** The ordering of numeric values in lists of values can appear random when you use the Alphanumeric number type. If you are using Alphanumeric numbering, consider entering all numeric values with the same number of digits. For example, if you

can assume all numeric values contain six digits, you should enter the first value as 000001.

**Important:** You should setup the numbering type to be the same in all operating units in which you are planning to create and enable global agreements.

39. Enter the Next Number. This is the starting value you want Purchasing to use for generating unique sequential document numbers if you choose Automatic document number entry. Purchasing displays the next document number that will be used for a new document when you create the new document. You cannot enter this field if you choose Manual document number entry.

If you use Master Scheduling/MRP, Inventory, Work in Process, or any non-Oracle system to create requisitions automatically, you must also let Purchasing number the corresponding requisitions automatically.

40. Click Save.

## Defining Receiving Options

Use the Receiving Options window to define options that govern receipts in your system. Most of the options that you set here can be overridden for specific suppliers, items, and purchase orders. See: Receiving Controls, Options, and Profiles, page 9-7.

### To define receiving options:

1. Navigate to the Receiving Options window.

## 2. Select your Inventory Organization.

### Receiving Options

3. Enter the Enforce Ship To location option to determine whether the receiving location must be the same as the ship-to location. Choose one of the following options:

*None* - The receiving location may differ from the ship-to location.

*Reject* - Purchasing does not permit receipts when the receiving location differs from the ship-to location.

*Warning* - Purchasing displays a warning message but permits receipts when the receiving location differs from the ship-to location.

4. Choose an action for ASN Control. This field determines how Purchasing handles receiving against purchase order shipments for which an Advance Shipment Notice (ASN) exists. Choose one of the following options.

*None* - Purchasing does not prevent or warn you when you try to receive against a purchase order shipment for which an ASN exists.

*Reject* - Purchasing gives you a message and prevents you from receiving against a purchase order shipment for which an ASN exists.

*Warning* - Purchasing gives you a message informing you that an ASN exists for the purchase order shipment and lets you decide whether to receive against the purchase order shipment or its ASN.

5. Enter the maximum acceptable number of Days Early and Days Late for receipts.
6. Enter an action for Receipt Days Exceed-Action. This field determines how Purchasing handles receipts that are earlier or later than the allowed number of days selected above. Choose one of the following options:
  - None* - Receipts may exceed the allowed days early or late.
  - Reject* - Purchasing does not permit receipts outside the selected number of days early or late.
  - Warning* - Purchasing displays a warning message but permits receipts outside the selected number of days early or late.
7. Enter the maximum acceptable Over Receipt Tolerance percentage.
8. Enter the Action for Over Receipt Action. This field determines how Purchasing handles receipts that exceed the quantity received tolerance. Choose one of the following options:
  - None* - Receipts may exceed the selected tolerance.
  - Reject* - Purchasing does not permit receipts that exceed the selected tolerance.
  - Warning* - Purchasing displays a warning message but permits receipts that exceed the selected tolerance.
9. Enter the default RMA Receipt Routing that you assign goods: Direct Delivery, Standard Receipt, or Inspection Required.
10. Enter the default Receipt Routing that you assign goods: Direct Delivery, Standard Receipt, or Inspection Required. You can override this option at receipt time by changing the destination type for specific suppliers, items, and orders if the RCV: Allow Routing Override user profile is set to Yes. See: Profile Options in Purchasing, page C-1.
11. Check Allow Substitute Receipts if you want to receive substitute items in place of ordered items. You must define substitute items in the Item Relationships window before you can receive them. You can override this option for specific suppliers, items, and orders. See: Defining Item Relationships, *Oracle Inventory User's Guide*.
12. Check Allow Unordered Receipts if you want to receive unordered items. You can later match the unordered receipts to a purchase order. If you enable this option, you can override it for specific suppliers and items.
13. Check Allow Express Transactions to enable express deliveries and receipts. See: Express Receipts and Receiving Transactions, page 9-23.
14. Check Allow Cascade Transactions to enable cascading for receipts and receiving transactions. See: Cascading Receipts and Receiving Transactions, page 9-23.

15. Select Allow Blind Receiving if you want blind receiving at your site. Blind receiving helps you ensure that receivers record the exact amount they receive. With blind receiving, you cannot see the quantity due or the quantity ordered for shipments when you receive items. Purchasing ignores all quantity receipt tolerances to help ensure that you can receive the exact amount the supplier shipped.
16. Select Validate Serial Numbers on RMA Receipts if you want serial numbers validated. Restricts serial numbers displayed in the list of serial numbers for an RMA line.
17. Choose the Receipt Number Generation method for receipt numbers

*Automatic:* Purchasing automatically assigns a unique sequential number to each receipt when you create the receipt.

*Manual:* You provide a receipt number manually when you enter the receipt.

Purchasing numbers receipts within inventory organizations rather than across inventory organizations. So, for example, the same receipt number could be used by different inventory organizations.

**Important:** You can change the method of entering receipt numbers at any time. If you originally allow manual entry and switch to automatic entry, make sure to enter a Next Number that is higher than the highest number you assigned manually.

18. Choose the Receipt Number Type you want Purchasing to use for receipt numbers: Numeric or Alphanumeric.

**Important:** If you choose Automatic receipt number entry, you can *generate* only numeric receipt numbers, but you can still *import* either numeric or alphanumeric values from another purchasing system.

**Important:** If you have any alphanumeric documents in your system, you must choose Alphanumeric as your number type, regardless of your numbering method.

If you choose Manual receipt number entry, you can choose numeric or alphanumeric numbers. You can change the receipt number type from Numeric to Alphanumeric whenever you want. You can change the receipt number type from Alphanumeric to Numeric only if all your current receipt numbers are numeric.

**Important:** The ordering of numeric values in lists of values can

appear random when you use the Alphanumeric number type. If you are using Alphanumeric numbering, consider entering all numeric values with the same number of digits. For example, if you can assume all numeric values contain six digits, you should enter the first value as 000001.

19. Enter the Next Receipt Number. This is the starting value you want Purchasing to use for generating unique sequential receipt numbers if you choose Automatic receipt number entry. Purchasing displays the next receipt number that will be used for a new receipt when you create the new receipt. You cannot enter this field if you choose Manual receipt number entry.

### **Accounting**

20. Enter the accounting flexfield for the default Receiving Inventory Account.
21. Enter the account number for the Retroactive Price Adjustment Account. This is the account that receiving will use to post an adjusting entry for changes in pricing after a shipment has been received and accrued. See: Retroactive Price Update on Purchasing Documents, page 13-34.
22. Enter the account number for the Clearing Account. This is the account that is used for intercompany receivables in the procuring organization when the receiving organization is not the same as the procuring organization.

### **Cost Factors**

23. If you have implemented Oracle Advanced Pricing to calculate cost factors, check Interface to Advanced Pricing.
24. If you have implemented Oracle Transportation Execution to calculate transportation costs, check Interface to Transportation Execution.
25. Click Save.

## **Related Topics**

Defining Purchasing Options, page 1-33

Defining Purchase Order Receipt Accruals, page 9-120

## **Defining Requisition Templates**

Use the Requisition Templates window to define requisition templates. These templates automate requisitioning of commonly ordered items like office supplies. To create a requisition for office supplies, requestors in your organization simply use your template



and enter the quantity of each item they want to order.

To create a template, you can specify the items individually or you can reference an *existing* requisition or purchase order. If you reference an existing document, Purchasing adds all lines on the document to the template. You can reference multiple documents to add all their lines to the same template.

After you define a template, you can reference the template in the Supplier Item Catalog. When you do so, Purchasing displays all template lines that are valid for the destination organization, and you can use any of these lines on your requisition. You can create requisitions with this template as long as the requisition creation date is before the template inactive date.

### To define requisition templates:

1. Navigate to the Requisition Templates window.

Num	Type	Item	Rev	Category	Description	Source Type	UC

2. Select the Operating Unit for this template.
3. Enter the requisition Template name.
4. Enter a Description of the template.
5. Enter the Inactive Date after which you do not want any requestor to create a requisition from this template.
6. Enter the requisition Type: Internal or Purchase. In either case, you can enter individual requisition lines of either type.

7. If this template is to be used in Oracle iProcurement, select the Reserve PO Number option.

*No* prevents the requester from reserving a purchase order number at the time the requisition is approved.

*Optional* allows the requester to reserve a purchase order number at the time the requisition is approved.

*Yes* will automatically reserve a purchase order number at the time the requisition is approved.

### **To copy lines to a template:**

1. Select the Copy button to open the Base Document window.
2. Enter the Base Document Type: Purchase Order or Requisition.
3. Enter the base document Number from which you want to copy lines to the template.
4. Choose the OK button to copy all lines of the base document onto the template. You can choose the Cancel button to return to the Requisition Templates window without copying.

You can place lines from multiple documents onto the same requisition template.

### **To manually add lines to a template:**

1. Use the Lines region to manually add new lines to the template. You can also remove lines that you have copied from a base document, and you can change certain information in these lines.
2. Enter a Number in this field to identify the sequence of the line on your requisition. Purchasing provides default sequence numbers in increments of one.
3. Enter the line Type. You can enter or change information in this field only for new lines. The default is from the Purchasing Options window. See: Defining Default Options, page 1-38.
4. Enter the Item number. You can enter or change information in this field only for new lines.
5. For new lines only, you can enter the item Revision number.
6. If you entered an item, Purchasing displays the purchasing Category, and you cannot change it. Otherwise, you must enter a purchasing category.
7. Purchasing displays the item Description from the document you selected in the

Base Document Number field. If you are entering a new line, the description is from the item master. You can change the description only if this attribute is active for the item.

8. The Source type determines the source of the requisitioned items. The choice you have in this field is dependent on your user profile options and the system profile options. At either level, you may be restricted to one of the following options: Inventory or Supplier.

Note that if you have both options, you can source requisition lines independently of the requisition type. You can even mix inventory and supplier sourced requisition lines in the same requisition. Purchasing creates one internal sales order for each inventory source type requisition line on this requisition. The supplier source type requisition lines go onto purchase orders, either automatically with AutoCreate Documents or manually with the Purchase Orders window.

9. Enter the default unit of measure.
10. Optionally, enter a suggested quantity for requisitioners in Oracle iProcurement.
11. For supplier sourced lines, you can enter the unit price, and this price is used in the Requisitions window. For inventory sourced lines, the cursor does not enter this field, and the price in the Requisitions window is the actual cost from inventory.
12. If Oracle Services Procurement is implemented, enter an amount for a fixed price services line type. Amount is required and the source type must be Supplier.
13. Indicate that this line was from a negotiated source by checking the Negotiated checkbox. You can change it only if your responsibility has that function enabled.
14. Save your work.

### **To enter sourcing information :**

You can enter sourcing information for the current line in the lower part of the window.

1. For supplier source type lines, you can enter the name of the Buyer to whom you want to assign the requisition line. The buyers can query requisition lines that you assign to them when they AutoCreate purchase orders.
2. For supplier source type lines, you can select RFQ Required to indicate that you want to require an RFQ before the buyer can create a purchase order for the requisition. Purchasing displays a warning message if you try to create a purchase order without a required RFQ.
3. For supplier source type lines, you can enter a suggested Supplier for your requisition items. You can choose a supplier from the list of available suppliers.

4. For supplier source type lines, you can enter the supplier Site. You can enter this field only if you provide a suggested supplier name. You can choose a supplier site from the list of values.
5. For supplier source type lines, you can enter the name of your Contact at the supplier site.
6. For supplier source type lines, you can enter the Supplier Item number.
7. For inventory source type lines, you can specify the source Organization.
8. For inventory source type lines, you can optionally specify the Subinventory source. If you do so, Oracle Order Management reserves the goods and uses only the specified subinventory for allocation. If the goods do not exist at the specified subinventory, Order Management backorders them, even if they do exist in another subinventory.

## Related Topics

Overview of the Supplier Item Catalog, page 5-5

## Purchasing Hazardous Materials

Purchasing provides you with flexible features to handle all your hazardous materials purchasing and receiving requirements. You can *clearly* identify and classify hazardous materials and print information on your RFQs and purchase orders to ensure that your suppliers pack, label, and ship hazardous materials according to the regulations. You can also review hazardous materials information when receiving items and take the required safety precautions.

Use the Hazard Classes window (See: Defining Hazard Classes, page 1-53.) to define the hazard classes you need. Use the UN Numbers window (See: Defining UN Numbers, page 1-54.) to define the identification numbers you use and to assign them to hazard classes. Use the Item window to associate hazard classes and UN numbers with your items. See: Defining Items, *Oracle Inventory User's Guide*

## Regulation Background

Section 19 of the ISRS (International Safety Rating System) requires that you clearly identify and record all orders for hazardous materials. The US Department of Transportation provides similar regulations. These regulations provide an extensive classification system for hazardous materials. The purpose of this classification is to provide detailed requirements for shipping papers, package marking, labelling, and transport vehicle placarding applicable to the shipment and transportation of hazardous materials. For each hazardous material, the classification provides:

**Shipping Name**

Describes the item ordered or shipped. Shipping names are regulated in some cases.

Examples:

- Calcium hydrogen sulfite solution
- Epichlorohydrin
- Fuel oil
- Mercuric oleate, solid
- Petroleum Distillate
- Small arms ammunition

**Hazard Class**

Categorizes the hazardous material. Most hazardous materials belong to only one hazard class. Some materials belong to more than one hazard class and some materials do not belong to any. If a material belongs to more than one hazard class, you should list these classes in a specific order.

Examples:

- Corrosive Material
- Flammable liquid
- Forbidden
- Combustible liquid
- Poison A
- ORM-A
- Class A explosive

**Identification Number**

Identifies the hazardous material. Each identification number has a description. There are two types of identification numbers. Identification numbers preceded by "UN" (United Nations) have descriptions appropriate for international and US domestic shipments. Identification numbers preceded by "NA" (North American) apply only to US domestic shipments and shipments between the US and Canada. Identification numbers are not unique. For instance, the same UN Number may correspond to two closely related but different types of materials.

Examples:

- UN0001 Alarm Devices, Explosives

- UN0027 Black powder
- UN0180 Rockets
- NA1133 Cement
- NA2016 Grenade
- UN2016 Ammunition
- UN2769 Benzoic derivative pesticide, liquid
- UN2769 Benzoic derivative pesticide, solid

Some hazardous materials do not have a corresponding identification number.

Examples:

- Fuse, lighter
- Propellant, explosive, liquid

In some cases, hazardous materials that you identify by the same identification number can belong to two different hazard classes.

Example:

- Fuel, aviation, turbine engine has the ID Number UN1863, but it can be in either the Flammable Liquid or the Combustible Liquid hazard class.

### **Labels Required**

Specifies the labels required for each package of the hazardous material. The regulations provide detailed instruction concerning the format, size, colors, and printing of labels.

Examples:

- Flammable liquid
- Explosive C
- Poison B

### **Packaging Requirements**

Specify the packaging and placarding requirements and exceptions for the hazardous material. Packaging requirements depend mainly on the hazard class for the hazardous material, but there are many exceptions to this rule.

### **Shipping Requirements**

Specify the maximum amount of hazardous material you can carry per package depending on the mode of transportation you use. Also provide additional shipping, handling, storing, or other information about the hazardous material.

Examples:

- Keep cool
- Store away from acids

## Defining Hazard Classes

Use this window to define codes for different classes of hazardous materials. You provide the class name, description, and the date after which the class is no longer active. You can assign a hazard class to multiple UN numbers to identify hazardous items.

Purchasing automatically copies hazardous material information onto your documents and prints this information on your purchase orders, RFQs, and Receipt Travelers. Purchasing automatically displays hazardous material information for your receivers.

If you use Multilingual Support (MLS), translations can be entered for the hazard classes from within each of your installed languages. To enter the translations for the hazard classes, select Translations from the View menu. For more information on MLS, see the *Oracle E-Business Suite User's Guide*.

### To define hazard classes

1. Navigate to the Hazard Classes window.

Hazard Class	Description	End Date
Flammable Liquid	Liquid goods that burn if ignited	(example: 28-Apr-2006)
Flammable Solid	Solid goods that burn if ignited	(example: 28-Apr-2006)
		(example: 28-Apr-2006)
		(example: 28-Apr-2006)

2. If you are defining a new hazard class click Add Hazard Class. To enter changes to an existing hazard class use the Search region to enter the hazard class's name in the Hazard Class field or the description in the Description field. Once you have completed one or all of these fields click Go.
3. Enter a unique name for each hazard class you want to define. For example, you might provide any of the following classes: Explosive, Poisonous, Toxic.

4. Enter a description for your hazard class. You can use this description to provide a more detailed explanation of the hazard class.
5. Enter the date your hazard class becomes inactive. You cannot use the hazard class after this date.
6. Click Save.

## Related Topics

Purchasing Hazardous Materials, page 1-50

Defining UN Numbers, page 1-54

Defining Items, *Oracle Inventory User's Guide*

## Defining UN Numbers

Use this window to define United Nations identification numbers for hazardous materials. You can associate a hazard class with multiple identification numbers. You can also assign an identification number and a hazard class to each item you define.

Purchasing automatically copies hazardous material information onto your documents. Purchasing prints hazardous material information on your purchase orders, RFQs, and Receipt Travelers and displays this information for your receivers and inspectors.

If you use Multilingual Support (MLS), translations can be entered for the UN numbers from within each of your installed languages. To enter the translations for the UN numbers, select Translations from the View menu. For more information on MLS, see the *Oracle E-Business Suite User's Guide*.

## Prerequisites

Define Hazard Classes before performing this step. See: Defining Hazard Classes, page 1-53.

### To define UN numbers:

1. Navigate to the UN Numbers window.



**UN Numbers**  
\* Indicates required field

Cancel Save

**Search**

UN Number: UN2%  
Description:  
Hazard Class:

Go Clear

UN Number	Description	Hazard Class	End Date
UN2016	Ammunition	Flammable Solid	(example: 28-Apr-2006)
UN2979	Uranium metal pyrophor	Radioactive Material	(example: 28-Apr-2006)
			(example: 28-Apr-2006)

Add UN Number

Cancel Save

About this Page Privacy Statement Copyright (c) 2006, Oracle. All rights reserved.

2. If you are defining a new number click Add UN Number. To enter changes to an existing number use the Search region to enter the number in the UN Number field, the Description, or the Hazard Class. Once you have completed one or all of these fields click Go.
3. Enter the UN identification number. You can define multiple instances of the same UN number as long as the descriptions are different.
4. Enter a Description for your identification number.
5. Enter the Hazard Class you want to associate with the identification number. This is optional.
6. Optionally enter the Inactive Date for the identification number.
7. Click Save.

## Related Topics

Purchasing Hazardous Materials, page 1-50

Defining Hazard Classes, page 1-53

Defining Items, *Oracle Inventory User's Guide*

## Defining Lookup Codes

Use the Oracle Purchasing Lookups window to define lookup codes in Purchasing.

Purchasing uses lookup codes to define lists of values throughout the system. A lookup category is called a *lookup type*, and the allowable values for the lookup type are called

lookup codes. You can add your own codes to those initially provided for some of the lookup types, depending on your Access Level.

For example, Purchasing supplies the following Supplier Type codes: Employee and Supplier. You might want to define an additional code called Consultant to use for the purchase of consulting services.

**Important:** You cannot change or delete codes once you have added and saved them, but you can change the code descriptions.

For detailed information on defining and updating lookups, see: Lookups, *Oracle Applications Developer's Guid* or see the online help.

If you use Multilingual Support (MLS), translations can be entered for the lookups from within each of your installed languages. To enter the translations for the lookups, select Translations from the View menu. For more information on MLS, see the *Oracle E-Business Suite User's Guide*.

### To define lookup codes:

1. Navigate to the Oracle Purchasing Lookups window from the menu.

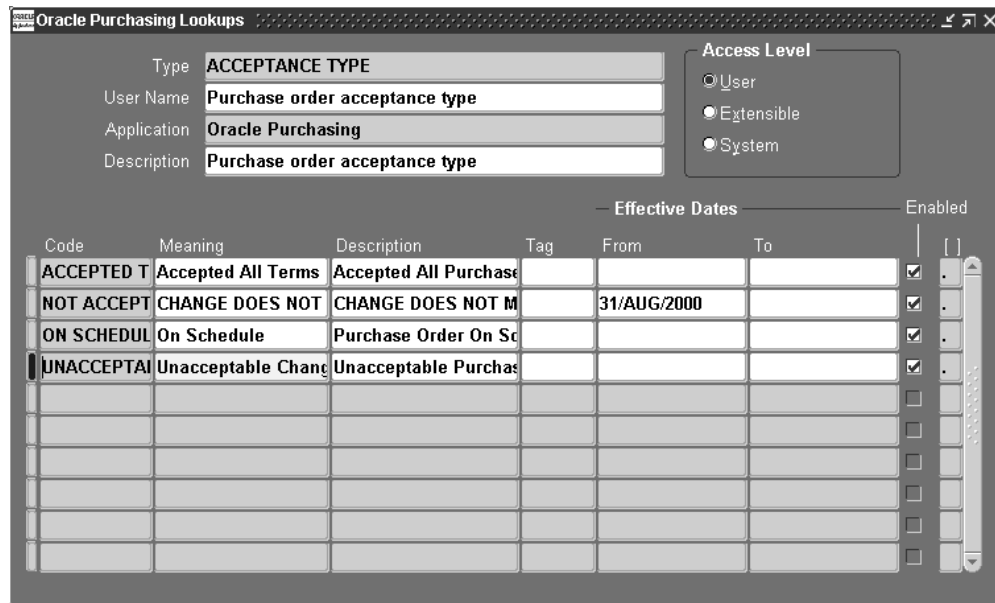

2. Enter one of the following predefined lookup Types: 1099 Supplier Exception, Acceptance Type, FOB (free on board), Freight Terms, Minority Group, Pay Group, PO/Requisition Reason, Price Type, Quotation Approval Reason, Reply/Receive Via, and Supplier Type.
3. Enter up to 25 characters as a unique code you want to add to the lookup codes already provided. Purchasing provides the following codes for the listed lookup

types:

*1099 Supplier Exception:* Purchasing provides no 1099 Supplier Exception codes, but you can define your own. These codes are used only in the Payables reports: 1099 Invoice Exceptions Report and 1099 Supplier Exceptions Report.

*Acceptance Type:* Purchasing provides Accepted Terms, On Schedule, and Unacceptable Changes.

*FOB:* Purchasing provides no FOB codes, but you can define your own. This code is printed on your purchase orders.

*Freight Terms:* Purchasing provides no Freight Terms codes, but you can define your own. This code is printed on your purchase orders.

*Minority Group:* Purchasing provides no Minority Group codes, but you can define your own. Minority Group codes are used to classify suppliers for reporting purposes.

*Pay Group:* Pay Groups can be assigned to Payables invoices. Then Payables payment batches can be limited to invoices assigned to a specified Pay Group. The system provides no Pay Group lookups, but you can define your own in this window.

*Price Type:* Purchasing provides Cost Plus Fee, Cost Plus Percentage, Fixed, Indexed, and Variable.

*Quotation Approval Reason:* Purchasing provides Best Delivery, Best Design, Lowest Price, Only Source, Quality, and Service.

*Reply/Receive Via:* Purchasing provides no Reply/Receive Via codes, but you can define your own.

*PO/Requisition Reason:* Purchasing provides no transaction reason/transaction nature codes for purchase orders, requisitions, RFQs, and quotations, but you can define your own.

*Vendor (Supplier) Type:* Purchasing provides Employee, Supplier, and Public Sector Companies. These codes are used to classify suppliers for reporting purposes. You enter this value in the Type field of the Classification region of the Suppliers window. See: Business Classifications, *Oracle iSupplier Portal Implementation Guide*. It is also used to define tax recovery rules. The Tax Authority supplier type indicates suppliers to whom you remit withholding taxes. See: Tax Rules in Oracle E-Business Tax, *Oracle E-Business Tax User's Guide*.

4. Enter an Inactive Date on which the code is no longer active.
5. Save your work.

## Defining Quality Inspection Codes

Use the Quality Inspection Codes window to define and update your inspection codes.

You can define as many codes for inspection as you want. Each code *must* have a corresponding numerical ranking, which provides an inspection scale. You use these inspection codes when you receive and inspect the items you ordered.

### To define quality inspection codes:

1. Navigate to the Quality Inspection Codes window.

**Quality Inspection Codes**  
\* Indicates required field

Cancel Save

Search

Ranking

Quality Code

Description

Go Clear

Ranking	Quality Code	Description	End Date
10	Excellent	Substantially exceeds quality standards	25-Mar-2007
20	Above Average	Exceeds quality standards	
30	Average	Meets quality standards	
40	Below Average	Below quality standards, but acceptable	
90	Unacceptable	Below quality standards, not acceptable	
99	Reject & Notify	Serious quality problem, contact supplier	

Add Quality Code

Cancel Save

About this Page Privacy Statement Copyright (c) 2006, Oracle. All rights reserved.

2. If you are defining a new code click Add Quality Code. To enter changes to an existing code use the Search region to enter the ranking in the Ranking field, the Quality Code, or the Description. Once you have completed one or all of these fields click Go.
3. Enter a Ranking number that corresponds to a specific quality code. This value must be between 0 and 100, where 0 represents the lowest quality. For example, 10 might represent a quality ranking of Poor, while 90 might represent a quality ranking of Excellent. Purchasing lists these rankings when you inspect your receipts.
4. Enter a Quality Code to indicate a particular quality standard. For example, you might want to define Excellent Condition or Damaged as quality codes.
5. Enter a description for your quality code. You can use this description to provide a more detailed explanation of the quality code.
6. Enter the Inactive Date after which the quality code is no longer active.
7. Save your work.

## Line Types in Purchasing Documents

Oracle Purchasing provides the line type feature so that you can clearly differentiate orders for goods from those for services or outside processing. In addition, the services related line types support a broad range of service categories including general business services, consulting services, and contingent labor.

### Background

Requestors and buyers generally order both goods and services by quantity. You order the number of items you need in a specific unit of measure and at a given price. For instance, a buyer could order 10 computer terminals at a price of \$1500 each. Later, the receiving agent records the receipt of one crate of 5 terminals. The accounts payable department receives a bill for 5 terminals, and matches the invoice against the original purchase order. Sometimes, you also need to order services in the same way. For example, you purchase 40 hours of product training at a rate of \$40 per hour. You simply record the hours of training ordered and the price per hour. Once you receive the training, you record the hours received.

However, you sometimes order services by amount rather than by quantity. For example, a project manager orders \$10,000 of consulting services to install a local area network. In this case, the buyer only needs to record the total amount of the service.

When half of the work is complete, the project manager records a receipt of \$5000. The consulting firm may send an invoice for the complete amount of the service, or it may send partial invoices. In either case, the accounts payable department must match the invoice to the original purchase order or receipt by amount.

Purchasing provides you with the features you need to order both goods and services. You should be able to:

- Create your own purchasing document line types. For each line type, you should be able to specify the value basis: amount or quantity. If you have implemented Oracle Services Procurement, you have the additional value basis of fixed price or rate. For both amount and quantity based line types, you can specify default values for category, unit of measure, and whether you require receipt. For quantity based lines, you can specify whether the line type is used for outside processing.
- Create a purchasing document with any combination of line types you need.
- AutoCreate purchase order lines from your requisition lines, grouping requisition lines for the same line type and item onto the same purchase order lines.
- Create services purchase order lines by selecting a fixed price or rate based line type, category, description, and amount for the line.
- Create amount-based purchase order lines by selecting an amount-based line type,

category, item description, and total amount for the line.

## Major Features

### Line Type

The line type governs the type of requisition, purchase order, RFQ, and quotation lines you create. Quantity-based line types let you order and receive and/or invoice based on the quantity of goods or services provided. Amount-based line types let you order and receive and/or invoice based on the value of the service provided.

### Quantity-Based Purchasing

Use quantity-based line types when you want to specify the quantity, unit of measure, and unit price for the items you are ordering. Purchasing provides Goods as an initial quantity-based line type. You can modify this line type or create new quantity-based line types to satisfy your needs.

### Fixed Price-Based Purchasing

If you have implemented Oracle Services Procurement, you can use fixed price-based line types when you want to order general business services or temporary labor services (with Oracle Services Procurement) by a fixed amount. You create an order for fixed price service by selecting a fixed price-based line type, category, item description, and total amount of the service. You can receive and match fixed price services by amount.

### Rate-Based Purchasing

If you have implemented Oracle Services Procurement, you can use rate-based line types when you want to order temporary labor services by per unit rate. You can use rate differentials with this line type. You create an order for rate based service by selecting a rate-based line type, category, unit of measure, price, item description, and total amount of the service. You can receive and match rate-based services by amount.

### Amount-Based Purchasing

Use amount-based line types when you want to order services and other items by amount. You create an order for a service by selecting an amount-based line type, category, item description, and total amount of the service. You can also receive and match services by amount.

### Outside Processing Line Types

You can use outside processing line types to enter purchasing documents to pay suppliers for outside processing operations. Purchasing provides Outside Processing as an initial outside processing line type, and you can create additional outside processing line types. You cannot use outside processing line types, unless Purchasing, Work in

Process, and Bills of Material are installed. See: Overview of Outside Processing, *Oracle Work in Process User's Guide*.

## **Temporary Labor Line Types**

If you have implemented Oracle Services Procurement, you can use temporary labor purchase basis line types to enter purchasing documents to pay contingent labor (contract labor) providers. See: Setting Up Services Procurement for Temporary Labor, page 1-90

## **Line Types Step by Step**

### **Defining Line Types**

Oracle Purchasing provides initial line types of Goods and Services. If Oracle Work in Process is installed, Oracle Purchasing also provides the line type Outside Processing. If Oracle Services Procurement is installed, Oracle Purchasing also provides Rate Based Temp Labor and Fixed Price Temp Labor line types. You can modify these line types or create new line types in the Line Types window. To define a new line type, you simply provide a name and description for lines types with a value basis of quantity, fixed price, rate, or amount. You can then optionally specify a default category (except for Oracle Services Procurement temp labor line types), whether receipt is required, and unit of measure. The unit price defaults to 1 for amount-based line types but is otherwise optional. You cannot specify a line as outside processing unless the value basis is quantity. You must provide a default unit of measure for rate-based and amount-based line types. You use the unit of measure for amount-based lines as reference information only. Purchasing does not perform any unit conversion for amount based lines. You can create a unit of measure such as AMOUNT for amount based line types to help you determine if you ordered by amount. See: Defining Line Types, page 1-62. See: Defining Units of Measure, *Oracle Inventory User's Guide*.

### **Creating Purchasing Document Lines**

Oracle Purchasing lets you specify whether you are creating a document line for quantity, fixed price, rate, amount, or outside processing depending on your implementation. You simply choose the line type when you create your document line. You enter the item, item description, quantity, unit of measure, and unit price or amount depending on the line type. See: Defining Line Types, page 1-62.

### **Setting Up a Default Line Type**

Since you typically use one line type more than the others, Purchasing lets you define a system default line type in the Purchasing Options window. All new purchasing document lines default to this line type. You can override this value when you need to create document lines of another type. You do not have to set up a system default if you use many different line types. See: Defining Default Options, page 1-38.

## AutoCreating Purchase Orders

You can use the AutoCreate Documents window to convert approved requisition lines for items and services into purchase orders and releases. You can gather requisition lines for the same line type and place them onto a single purchase order. You can also place requisitions for different line types onto the same purchase order. Purchasing combines requisition quantity and amount based lines for the same item, line type, unit of measure, and item revision onto a single purchase order line. See: Autocreate Documents Overview, page 6-1

## Enhanced Document Printing

Purchasing prints your document lines according to their line types. For quantity based line types, Purchasing prints the quantity, unit price and total amount for purchase orders and RFQs. Oracle Purchasing prints only the amount for fixed price, rate, and amount based document lines. If Oracle Services Procurement is implemented, note that the temporary labor information is not printed.

## Enhanced Reporting

The line type feature includes enhanced reporting to differentiate between quantity and amount based orders. Oracle Purchasing prints the line type so you can easily determine the basis of the information. For fixed price, rate, and amount based orders, Oracle Purchasing prints only the total amount of the order.

## Defining Line Types

Use the Line Types window to define and update line types.

When you enter a line on a purchasing document and choose a line type, Purchasing automatically displays the default information that you define here for the line type.

Line types let you distinguish their value basis between quantity and amount based line items. You use quantity based line items when you know the quantity and price of the line you are ordering. For example, you might buy a dozen pens for \$10. You use amount based line items when you are ordering a service.

If Oracle Services Procurement is implemented, fixed price and rate value based line types are also possible. You use fixed price based line items when you are ordering a service with a set fee. You use rate based line types when you are ordering services on a fee per unit basis. For example, you might order consulting services at \$250 per hour.

You can create line types to reflect different characteristics for the items you purchase. For example, you may want to define one line type for items you order by quantity and unit price, another line type for services you order by hour, and yet another that indicates an outside processing operation used in Oracle Work In Process (WIP). You can create purchasing document lines and specify whether they are for goods, services, outside processing, or any other line type you define.

You can further refine the definition of your line type by specifying a purchase basis for



a line type. You can choose a purchase basis of goods or services. If Oracle Services Procurement is implemented, you can also choose temp (temporary) labor. Value basis, discussed above, reflects how you wish to value the purchase. For example, quantity, amount, or rate. Purchase basis indicates the nature of the purchase and determines the attributes that are required, as well as the associated business flows downstream.

Outside processing line types are necessary when you are using WIP and want to enter purchasing documents for outside processing operations in WIP. When you choose an outside processing line type on a purchasing document line, you can enter only outside processing items and the destination type can be only Shop Floor.

Purchasing automatically provides you with a line type of Goods that is quantity based. If Work in Process is installed, Purchasing also provides you with an Outside Processing line type. You can set up your purchasing options to copy a default line type for lines you add to every requisition, purchase order, RFQ, or quotation document. You can override the default line type for each document line you create.

If you use Multilingual Support (MLS), translations can be entered for the line types from within each of your installed languages. To enter the translations for the line types, select Translations from the View menu. For more information on MLS, see the *Oracle E-Business Suite User's Guide*.

### Prerequisites

- Define categories. See: *Defining Categories, Oracle Inventory User's Guide*.
- Define units of measure. See: *Defining Units of Measure, Oracle Inventory User's Guide*.

### To define line types

1. Navigate to the Line Types window.

Name	Description	Value Basis	Purchase Basis	End Date	Update
Goods	All goods that are individually recorded and printed out (by item class, unit, and unit price)	Quantity	Goods		

2. If you are defining a new line type click Create. To enter changes to an existing line type use the Search region to enter the Name or the Description. Once you have completed one or all of these fields click Go. Enter your changes by clicking the Update icon for your line type.

**ORACLE® Purchasing** Diagnostics Home Logout Preferences

Logged In As CBROWN

**Create Line Type**  
\* Indicates required field

\* Name

\* Description

\* Value Basis

Purchase Basis

End Date  (example: 28-Apr-2006)

Outside Processing

Category  Item Category,Commodity

Price

Receipt Required

Receipt Close

[About this Page](#) [Privacy Statement](#) Copyright (c) 2006, Oracle. All rights reserved.

3. Enter the Name and Description of the line type.

4. Enter the Value Basis for the line type.

*Amount:* Receive items by amount. You cannot change the unit of measure and unit price on purchasing document lines.

*Fixed Price:* If Oracle Services Procurement is implemented, enter services by amount only. Receive items by amount. You cannot change the unit of measure and unit price on purchasing document lines.

*Quantity:* Receive items by quantity. Outside Processing line types must have this value basis.

*Rate:* If Oracle Services Procurement is implemented, enter services by rate (price) and amount. Receive items by amount.

**Important:** You can not change line type attributes after transactions have been created for that line type.

5. Enter the Purchase Basis for the line type.

*Goods:* For quantity value based line types.

*Services:* For amount and fixed price based line types.

*Temp Labor:* If Oracle Services Procurement is implemented, for fixed price and rate based line types.

6. Enter the End Date on which the line type is no longer usable.

7. Select Outside Processing to restrict this line type to purchasing outside processing. Also, when you use an outside processing line type on a purchasing document, your choices for the item are limited to outside processing items. You can select this check box only if the value basis is Quantity and if you are using Work in Process.

8. Enter the default purchasing Category for items with this line type. You can

override this purchasing category on purchasing document lines.

9. Select Receipt Required if you want this as the default on your purchasing document shipments with this line type. You can overrule the default when you enter the shipment.
10. Enter the default Unit of measure for items with this line type. You must enter a default unit when you use the Amount value basis for your line type. You can override this unit of measure on your purchasing document lines only when you use non-Outside Processing line types with Quantity value basis.

If you use the Amount value basis, you may want to choose your functional currency as the unit of measure. For example, if your functional currency is US dollars, you may want to define a unit of measure USD that you can use for your line types with the Amount value basis.

If Oracle Services Procurement is implemented, line types with a rate value basis the unit of measure class can be restricted by the setting of the profile PO: UOM Class for Temp Labor Service.

11. Enter the default Unit Price for items with this line type. Purchasing automatically enters a unit price of 1 when you use the Amount value basis and prevents you from updating this price when you create your line type. You can override this unit price on your purchasing document lines only when you use line types with Quantity value basis.
12. Click Save.

## Related Topics

Purchasing Services, page 1-59

Overview of Outside Processing, *Oracle Work in Process User's Guide*

## Purchasing Services

Oracle Purchasing provides you with the features you need to order both goods and services. To satisfy the special needs of buyers procuring services, Oracle Purchasing provides the functionality described here. In addition, you may want to consider implementing Oracle Services Procurement.

## Purchasing Services Step by Step

### Creating Requisitions for Services

Oracle Purchasing lets you create requisition lines for services and other amount based orders. The fixed price based and rate based line types are specifically designed for

procuring services.

*Amount Based:* When you choose an amount based line type, Purchasing automatically sets the unit price to 1 for your line and enters the default unit of measure for the line type. You cannot change the unit price or unit of measure for amount-based requisition lines. You enter the amount of the service in the Quantity field. Your total line amount is the same as the value displayed in the quantity field. You can use the quantity field in your distributions to allocate the order amount to multiple accounting flexfields.

*Fixed Price Based:* If Oracle Services Procurement is implemented, you can use fixed price service line type is for general business services where the purchase and invoice are based on a dollar amount of service. Once defined, you need only enter the amount to complete a fixed price requisition line.

*Rate Based:* If Oracle Services Procurement and Oracle iProcurement are implemented, you can create a rate based requisition line for contingent labor where you are billed a per unit rate such as hourly. This line type also enables you to capture agreed rates for price differentials such as an overtime rate or holiday rate.

## Creating Purchase Orders for Services

You can use AutoCreate Purchase Orders to create purchase order lines and releases from approved requisitions. You can gather all requisition lines for services and review these lines before placing specific ones on purchase orders. For amount based lines you can also split a requisition line for a service into several requisition lines for goods and services. Purchasing creates a purchase order for all of the requisition lines you choose.

You can also enter purchase orders for services manually by entering a service line type and the appropriate information for that line type.

If Oracle Services Procurement is implemented, the services line may require that you enter a job, price differentials, and details in the Temporary Labor tabbed region

## Sourcing Services

When you request a quotation from a supplier for a particular service, you can provide a complete description of the service you are requesting. You must choose a quotation type of Catalog if you want to use it for sourcing.

When you choose sourcing information for amount-based requisition and purchase order lines, Purchasing copies the total amount from your chosen quotation shipment into the Quantity field of your purchasing document. Since you are creating an amount-based line and the unit price is set to 1, the Quantity field displays the total amount for the line.

**Note:** Oracle Services Procurement fixed price and rate-based line types are not supported for quotations or request for quotations (RFQ).

## Receiving Services

You receive services the same way you receive goods. When you receive a service, your quantity fields reflect the amounts of your order. Simply specify the amount you receive, correct, or return in the Quantity fields. Oracle Purchasing displays your line type so you can determine whether you are receiving by amount or quantity. You must receive services and other amount-based purchases in the unit of measure specified on the purchase order.

**Note:** Oracle Services Procurement fixed price line types can not be received, corrected, or returned using Oracle Purchasing windows. These transactions can only be performed in the Oracle Purchasing Receiving Open Interface or in Oracle iProcurement.

Oracle Services Procurement rate-based line types can only be received using the Retrieve Time from Oracle Time and Labor process.

## Matching Service Purchase Orders

When matching payables invoices to a service purchase order or receipt lines, you match based on the amount. For amount based lines, Oracle Accounts Payable defaults the unit price to 1 when matching. You should not change the unit price.

## Defining Document Types

Use the Document Types window to define access, security, and control specifications for all Purchasing documents. You cannot enter new document types; you can enter new document subtypes only for RFQs and quotations.

If you use Multilingual Support (MLS), translations can be entered for the document types from within each of your installed languages. To enter the translations for the document types, select Translations from the View menu. For more information on MLS, see the *Oracle E-Business Suite User's Guide*.

## Prerequisites

- Before you use this window to set up your document types, you should perform the following steps:
- If you want to be able to choose the document approval hierarchy in this form, you must enable Use Approval Hierarchies in the Financials Options window. See: *Defining Financials Options, Oracle Payables User's Guide*.
- You must use the Position Hierarchy window to create and update the position hierarchies, since Purchasing uses these hierarchies as document approval routings. Refer to 'Representing Jobs and Positions' in your Oracle HRMS documentation set

for more information

### To define document types:

1. Navigate to the Document Types window.
2. Select your Operating Unit and click Go
3. Select a Document Type from the list and click its icon in the Update column. If your document type is one of Purchase Agreement, Purchase Order, Quotation, Release, Request for Quotation, or Requisition you can update the attributes discussed in the following steps.

The screenshot shows the Oracle Purchasing interface for updating a document type. The page title is "Update Document Type: Purchase Order Standard for Vision Operations". The user is logged in as "CBROWN". The form includes several sections:

- Document Name:** Standard Purchase Order
- Document Type Layout:** Standard Purchase Order Stylesheet
- Contract Terms Layout:** Oracle Contract Terms Template
- Approval:** A list of checkboxes for permissions: Owner Can Approve, Approver Can Modify, Can Change Forward-To, and Can Change Approval Hierarchy. Below these are dropdowns for Approval Workflow (PO Approval), Workflow Start Process (PO Approval Top Process), Forward Method (Hierarchy), and Default Hierarchy (Materials).
- Control:** A section with dropdowns for Security Level (Public), Access Level (Full), and Archive On (Approve).

Buttons for "Cancel" and "Apply" are present at the top right and bottom right of the form area.

4. You can enter user-defined Document Subtypes only for document types Quotation and Request for Quotation. You can delete Quotation and Request for Quotation document types you have created, but only if no actual document exists for the type. Purchasing provides the following document subtypes:

*Purchase Agreement* - Blanket and Contract (For more information on these document types, see: Purchase Order Types, page 4-2.)

*Purchase Order* - Planned, Standard, Requester Change Order (For more information on these document types, see: Purchase Order Types, page 4-2.)

*Quotation* - Bid, Catalog, and Standard (For more information on these document types, see: Types of Quotations and RFQs, page 5-5.)

*Release* - Blanket and Scheduled (For more information on these document types, see: Purchase Order Types, page 4-2.)

*Request for Quotation* - Bid, Catalog, and Standard (For more information on these document types, see: Types of Quotations and RFQs, page 5-5.)

*Requisition* - Internal and Purchase (For more information on these document types,

see: Requisition Types, page 3-6.)

5. Enter your Document Name for the document. The description must be unique for the given document type. The name that you enter here appears as a list of values choice in the Type field in the appropriate document entry window. For example, the Name Bid Quotation appears, along with the Quotation Class Bid, as a list of values choice in the Quotation Type field in the Quotations window.
6. The Quotation Class is applicable only for document types Quotation and Request for Quotation. Choose one of the following options:
  - *Bid* - The quotation or RFQ is for a specific fixed quantity, location, and date.
  - *Catalog* - The quotation or RFQ includes price breaks at different quantity levels.

For more information about *Bid* and *Catalog*, see: Types of Quotations and RFQs, page 5-5. (Although there are three types of quotations-*Bid*, *Standard*, and *Catalog* -there are only two quotation classes-*Bid* and *Catalog*. *Standard* belongs to the *Catalog* class.)

7. For purchasing documents other than requisitions, select the stylesheet for this document type in the Document Type Layout field.

If you have selected PDF as your purchase order output format, you must select a layout template in Document Type Layout. See: Defining Control Options, page 1-34. See: Setup Purchase Order Communication to Suppliers, page 1-75.
8. If you have implemented Oracle Procurement Contracts, you must select a contract terms layout template in Contract Terms Layout. Note that if a Document Type Layout is specified, Oracle Purchasing will use that template to format output. See the *Oracle Procurement Contracts Implementation and Administration Guide* for details.
9. Check Owner Can Approve to indicate that document preparers can approve their own documents. This field is not applicable when the Document Type is Quotation or RFQ.

**Important:** If you are using budgetary control and enable this option, you should also enable the Reserve at Requisition Completion option in the Financials Options window. Likewise, if you disable this option, you should also disable the Reserve at Requisition Completion option.

10. If you are defining a style that includes standard purchase order pricing enhanced and global blanket purchase agreement pricing enhanced; enable pricing transparency using the Pricing Enhanced checkbox.

**Note:** Pricing transparency is applied to the Standard Purchase Order and the Global Blanket Purchase Agreement Document Styles defined only when Pricing Enhanced check box is enabled.

Refer to the Pricing Transparency, page 7-23 section for more information.

11. Check Approver Can Modify to indicate that document approvers can modify documents. This field is not applicable when the Document Type is Quotation or RFQ.
12. Check Can Change Forward-To to indicate that users can change the person the document is forwarded to. This field is not applicable when the Document Type is Quotation or RFQ.

For more information on how this and the next two fields affect your approval routing, see: Approval Routing, page 2-10.

13. Check Can Change Approval Hierarchy to indicate that preparers and approvers can change the default approval hierarchy in the Approve Documents window. This field is not applicable when the Document Type is Quotation or RFQ.
14. Check Can Change Forward-From to indicate that preparers can change the name of the document creator. This field is applicable only when the Document Type is Requisition.
15. For Purchase requisitions only, select Use Contract Agreements for Auto Sourcing to require the requisition creation autosourcing logic to include approved contract purchase agreements. The autosourcing logic for requisition creation will not consider contract purchase agreements if this box is unchecked, even if you have the profile PO: Automatic Document Sourcing set to Yes.

*Include Non-Catalog Requests* - For Oracle iProcurement only, this checkbox is used in conjunction with the Use Contract Agreements for Auto Sourcing. Select this checkbox to enable the use of contract purchase agreements when autosourcing non-catalog requisitions.

16. For user-defined quotations and RFQs, Purchasing displays as a default the Security Level of the Standard Quotation or RFQ, and you cannot enter the field. Otherwise, choose one of the following options:
  - *Hierarchy* - Only the document owner and users above the owner in the defined purchasing security hierarchy may access these documents.
  - *Private* - Only the document owner may access these documents.
  - *Public* - Any user may access these documents.



- *Purchasing* - Only the document owner and users listed as buyers in the Define Buyers window may access these documents.

For an overview of Security Level and Access Level, see: Document Security and Access, page 2-7.

17. For user-defined quotations and RFQs, the Access Level is that of the Standard Quotation or Standard RFQ, and you cannot enter the field. Otherwise, choose one of the following Access Level options:
  - *Full* - Users can view, modify, cancel, and final close documents.
  - *Modify* - Users can only view and modify documents.
  - *View Only* - Users can only view documents.
18. The Forward Method field is not applicable when the Document Type is Quotation or RFQ. The following options apply regardless of whether you are using position hierarchies or the employee/supervisor relationship to determine your approval paths. Choose one of the following options:
  - *Direct* - The default approver is the first person in the preparer's approval path that has sufficient approval authority.
  - *Hierarchy* - The default approver is the next person in the preparer's approval path regardless of whether they have approval authority. (Each person in the approval path must take approval action until the person with sufficient approval authority is reached.)
19. The Archive When field is applicable only when the Document Type is Purchase Agreement, Purchase Order, or Release. Choose one of the following options:
  - *Approve* - The document is archived upon approval. This option is the default. The Change Order workflow begins only if this option is chosen. See: Workflow Processes for Approving Change Orders, page E-133.
  - *Communicate* - The document is archived upon communication. A document communicate action would be printing, faxing, or e-mail.
20. The Default Hierarchy field is not applicable when the Document Type is Quotation or RFQ. Otherwise, when Use Approval Hierarchies is enabled in the Financial Options window, you can enter a position hierarchy from the Position Hierarchy window. This hierarchy then becomes the default in the Approve Documents window.

### **Approval workflows for specific document types:**

In Purchasing, all approvals are handled in the background by Oracle Workflow

technology. The default approval workflow processes in Purchasing use the approval controls and hierarchies you define according to the setup steps in *Setting Up Document Approval and Security*, page 2-1. If you created a workflow process of your own and wanted to associate it with a specific document type, you would choose that workflow process here.

1. Select the Approval Workflow you want to use for this particular document type, or use the default that is already provided.

The PO Approval workflow is used for approving purchase orders. The PO Requisition Approval workflow is used for approving requisitions. If you've created a workflow of your own, you can select that for this document. See: *Approval Workflows*, page E-89.

2. Select the Workflow Startup Process you want to use for this particular document type, or use the default that is already provided.

Usually the Workflow Startup Process is the highest-level process in a workflow. The default startup process for the PO Approval workflow is the PO Approval Top Process. The default startup process for the PO Requisition Approval workflow is the Main Requisition Approval Process. If you've created a startup process of your own, you can select that for this document.

3. For requisitions only, select the Approval Transaction Type. If you have implemented Oracle Approvals Management, this selection associates the transaction type with the requisition document type. Leave the field blank to use the standard Oracle Purchasing approval logic. See: *Oracle iProcurement Implementation Guide and Oracle Approvals Management Implementation Guide*. See: *Setting Up Document Approval and Security*, page 2-1.

4. For requisitions only, select the Autocreate Workflow you want to use for automatically creating purchase orders or releases from approved requisition lines, or use the default that is provided.

The default workflow that comes with Purchasing is the PO Create Documents workflow. If you've created a workflow of your own, you can select that for this document. See: *Workflow for Creating Purchase Orders or Releases*, page E-161.

5. For requisitions only, select the Autocreate Workflow Startup Process you want to use, or use the default that is already provided.

The highest-level process for the PO Create Documents workflow is the Overall Document Creation / Launch Approval Process. If you've created a startup process of your own, you can select that for this document.

## Related Topics

Defining Financials Options, *Oracle Payables User's Guide*

Representing Jobs and Positions, *Oracle HRMS Enterprise and Workforce Management Guide*

Enter Person, *Oracle HRMS Enterprise and Workforce Management Guide*

Budgetary Control and Online Funds Checking, *Oracle General Ledger User's Guide*

Submitting a Document for Approval, page 2-32

Entering Requisition Headers, page 3-48

Entering Purchase Order Headers, page 4-40

Entering RFQ Headers, page 5-49

Entering Quotation Headers, page 5-62

## Defining Document Styles

Use the Document Styles window to create and update purchase order styles.

Purchase order document styles allow organizations to control the look and feel of the application to match the usage of the purchasing document. Through reusable document styles, organizations can turn on or off various Oracle Purchasing features, thereby simplifying the user interface. In addition, document styles provide the ability to define purchasing document names that align more closely with the naming conventions of your organization's business. When a purchasing document is created using a document style, disabled features are hidden.

For example, you can create a document style for a specific commodity, such as temporary labor. This document style optimizes field labels and presentation for that commodity, thereby simplifying purchase order entry.

## Prerequisites

- Document styles only apply to authoring documents in the Buyer Work Center.
- Document styles are not organization specific.

### To define document styles:

1. Navigate to the Document Styles window.
2. If you are defining a new document style click Create. To enter changes to an existing style use the Search region to enter the Name, Description, or the Status. Once you have completed one or all of these fields click Go. Enter your changes by clicking the Update icon for your document style.

**Note:** Once a style has been saved, you can only update the style to

be less restrictive.

The screenshot shows the Oracle Purchasing 'Update Document Style' form. At the top, there is a navigation bar with 'ORACLE Purchasing' and links for 'Diagnostics', 'Home', 'Logout', and 'Preferences'. Below the navigation bar, the form title is 'Update Document Style' with a sub-header 'Document Styles >'. A legend indicates that an asterisk (\*) denotes a required field. The form contains the following fields and sections:

- Name:** Text input field containing 'Standard Style'.
- Description:** Text input field containing 'Standard document style'.
- Status:** Dropdown menu set to 'Active'.
- Document Types:** A table with two columns: 'Enable Type' and 'Display Name'.

Enable Type	Display Name
<input checked="" type="checkbox"/> Standard Purchase Order	Standard Purchase Order
<input checked="" type="checkbox"/> Contract Purchase Agreement	Contract Purchase Agreement
<input checked="" type="checkbox"/> Blanket Purchase Agreement	Blanket Purchase Agreement
- Commodities:** A section with a 'Line Types' dropdown menu set to 'All'.
- Pricing:** A section with a 'Price Breaks' checkbox checked.

Buttons for 'Cancel' and 'Apply' are located at the top right and bottom right of the form. The footer contains 'About this Page', 'Privacy Statement', 'Diagnostics Home Logout Preferences', and 'Copyright (c) 2006, Oracle. All rights reserved.'

3. Enter the Name and Description of the document style. The style name must be unique.
4. Select the Status as Active for a new style or Inactive for a style you no longer want used.
5. You must enter a unique Display Name for the Standard Purchase Order. This is the name that appears in the Buyer Work Center.
6. If you are defining a style that applies to contract purchase agreements or blanket purchase agreements, check their boxes and enter a unique Display Name.
7. If Services Procurement is implemented, check the Purchase Bases that apply to this document style. See: Defining Purchase Basis, .
8. Select whether specific or all Line Types are enabled for this document style. See: Line Types in Purchasing Documents, .
9. If you are defining a style that includes blanket purchase agreements, enable price breaks using the Price Breaks checkbox.
10. If Services Procurement is implemented and you have enabled a Temp Labor basis, use the checkbox to enable Price Differentials.
11. If Services Procurement is implemented, enable the Complex Payments attributes that apply:

- Check Advances if advance payments are to be allowed.
  - Check Retainage if withholding of a portion of the payment until all work under a contract is accepted is to be allowed.
  - Check Progress Payments to enable partial payments during performance of the contract. If Progress Payments is enabled, at least one pay item must be selected.
    - *Milestone* - Enable for payments based on progress events. Enabled by default for Goods line type.
    - *Rate* - Enable when payment amount is pro-rated based on the percentage of work completed.
    - *Lump Sum* - Enable when payment amount is a fixed amount based on the percentage of work completed.
    - Enable Treat Progress Payments as Contract Financing if it applies to this style's progress payments.
12. In the Pricing region, select the Enhance Pricing checkbox if you wish to enable the Pricing Transparency functionality.
13. Select Deliverable Hold Control check box to initiate payment hold by deliverables under the Controls region.
- Deliverable Hold Control is applicable for a Purchasing Document Style with a Document Type of Standard Purchase Order and Complex Purchase Order irrespective of the Pay when Paid check. It enables you to hold a payment independent of Pay when Paid.
14. Click Apply.

## Related Topics

Line Types in Purchasing Documents,  
Oracle Services Procurement,

## Purchase Order Communication Setup Steps

This section discusses the setup steps which define your supplier's preferred communication method. Oracle Purchasing supports the following methods of communicating purchase orders:

- Print

- Facsimile (fax)
- Electronic mail (e-mail)
- Extensible Markup Language (XML)
- Electronic Data Interchange (EDI)

See: Purchase Order Communication to Suppliers, page 8-1.

**Important:** It is important to note that enabling PDF output (described below) activates the Communicate selection in the Tools menu of the Purchase Order Summary window.

### **Print purchase orders:**

The standard way to communicate purchase orders to your supplier is by printing them and sending a copy to the supplier in the mail. Your purchase order can be printed using text or PDF (Adobe Portable Document Format) formatting. This method requires that your system administrator configure the printers attached to your computer system. See: Setup Steps, page 1-4.

### **Setup steps for printed purchase orders:**

1. Navigate to the Supplier Sites window.
2. Under the General tab, choose Printed Document as the Supplier Notification Method.

### **Fax purchase orders:**

Purchase orders facsimiles can be sent using text or PDF formatting. If you choose text format you must implement a third party FCL compatible fax software (such as RightFax). If you choose PDF format you may also use a third party fax software. See: Purchase orders in PDF, page 1-78.

This communication method also requires that your system administrator configure your Oracle Application to support fax transmission. See: *Oracle E-Business Suite System Administrator's Guide*.

### **Setup steps for faxed purchase orders:**

1. Navigate to the Supplier Sites window.
2. Under the General tab, choose Fax as the Supplier Notification Method. Enter a default fax number for the supplier site. You can change the default fax number or the notification method at the time of document communication.

### **E-mail purchase orders:**

You can send e-mail copies of purchase orders using HTML or PDF formatting.

**Note:** PDF format purchase orders are sent as attached files. See: Purchase orders in PDF, page 1-78.

Oracle Purchasing supports various types of file attachments (MS Word, Excel, PDF etc.) that can be appended to purchasing documents in addition to long and short text attachments. When a purchase order is e-mailed to the supplier, the corresponding file attachments appear in a zip file attached to the e-mail. You may specify the maximum allowable size for this zip file to minimize network traffic through the Purchasing Options window.

**Note:** When communicating PDF purchase orders using e-mail, all File type attachments are zipped into a single zip file named "Attachments.zip."

This communication method requires that your system administrator configure your Oracle Application Notification Mailer workflow to support e-mail transmission. See: Implementing Notification Mailers, *Oracle Workflow Administrator's Guide*.

### **Setup steps for E-mail PO:**

1. Navigate to the Supplier Sites window.
2. Under the General tab, choose E-mail as the Supplier Notification Method. Enter a default e-mail address for the supplier site. You can change the default e-mail address or the notification method at the time of document communication.
3. Define an alternative e-mail address in the Profile option PO: Secondary E-mail Address to send a copy of the e-mail PO to your company. If you wish to resend the e-mail, the user will need to log into this secondary e-mail account and resend it from there.
4. Generic terms and conditions can be appended on the e-mail PO body by putting them in a text file. This text file needs to be placed in one of the directories specified in the UTL\_FILE parameter in the INIT.ORA file. Make sure that the file is placed in the directory that exists where the database server is running. Once this is done, the following profile options need to be set for e-mail PO to read the terms and conditions file and display them in the e-mail body.
  - Set profile PO: In File Path with the absolute path of the directory where the terms and conditions file is placed.
  - Set profile PO: Terms and Conditions File Name with the name of the file.

5. Restart the workflow notification mailer after setting the above profiles. Navigate to Requests, Submit Requests, and run the concurrent program Notification Mailer to restart the mailer. (See Setting Up Oracle Workflow in the *Oracle Workflow User's Guide* for more details)
6. Failed e-mails (due to incorrect e-mail address) will be delivered by the mailer into a discard file. You need to monitor this file and look for common expressions such as Undisclosed Recipient (or other common expressions) and insert these expressions into the tags file as defined by the TAGFILE parameter in the workflow mailer configuration file. You then need to change the standard error handler workflow to look for these tags and take appropriate actions (send notifications to administrator/buyer).

### **XML purchase orders:**

Purchase orders and change orders can be communicated to the supplier using XML if the Oracle XML Gateway is implemented. For details on setting up the XML Gateway for Oracle Purchasing see *Oracle Purchasing XML Transaction Delivery Guide*.

### **EDI purchase orders:**

Purchase orders and change orders can be communicated to the supplier using EDI if the Oracle e-Commerce Gateway is implemented. For details on setting up the e-Commerce Gateway for Oracle Purchasing see *Oracle e-Commerce Gateway User's Guide*.

### **Purchase orders in PDF:**

Purchase orders can be viewed online or e-mailed, and faxed to suppliers in Adobe Portable Document Format (PDF). You can specify a style sheet template to control the appearance and layout of the formatted PDF file. If you have implemented Oracle Procurement Contracts, you can specify a style sheet template to control the appearance and layout of the contract terms as part of the purchase order PDF file. These templates are managed using Oracle XML Publisher. See the *Oracle XML Publisher User's Guide*.

### **Setup steps for PDF purchase orders:**

1. If Oracle Procurement Contracts is implemented, define terms and conditions for procurement documents template. See the *Oracle Procurement Contracts Implementation Guide* for details.
2. Setup supplier:
  - Assign the preferred method of communication to the supplier site. Refer to the instructions given above.
  - Assign a language to the supplier site.



3. From the Control tab of the Purchasing Options window set the PO Output Format to PDF. See: *Defining Control Options*, page 1-34.
4. Assign a Unix directory to the profile PO: Fax Output Directory for the PO Document. The system will store the generated PDF document in this directory when the communication is fax.
5. Define the Document Type Layout in the Document Types window. There must be a layout template for the document type. If Oracle Procurement Contracts is implemented, define the layout template for the contract terms. See: *Defining Document Types*, page 1-67. These style sheets are created in the Oracle XML Publisher Template Manager. See the *Oracle XML Publisher User's Guide*.
6. If Oracle Procurement Contracts is implemented, define security for the buyer. Administrators can define the buyers that have access to the terms and conditions. When a buyer doesn't have access to the terms and conditions, he sees just the PO details in the PDF document. When the buyer has access to the terms and conditions, he sees the PO details and the textual terms in the PDF document. See the *Oracle Procurement Contracts Implementation Guide* for details.

## Center-Led Procurement Setup

Oracle Purchasing provides features to enable consolidation of similar functions across all of your global business units. This consolidation is typically referred to as centralized procurement or sourcing service centers. The goal of which is to create autonomous procurement business units within the enterprise.

### Major Features:

#### Global Agreements

Global agreements are agreements (blanket purchase agreements or contract purchase agreements) with a supplier that can be shared between business units. Global agreements empower the centralized service unit to negotiate on behalf of some or all other business units and store the negotiation outcome in a single document. This single document can then be used for automatic sourcing of requisition demand from any enabled business units.

#### Center-Led Procurement Automatic Sourcing

Sourcing rules, sourcing rule assignments and approved supplier lists (ASL) are created in the owning business unit. The global agreements referenced by automatic sourcing are then available for execution in all business units enabled by the buyer. Complete process automation is achieved by defining sourcing rule assignments for the global agreements in the executing business unit.

## Center-Led Procurement Accounting

In a centralized procurement environment you may create a purchase order in one operating unit, but require shipment to a different operating unit. Accounts are provided to ensure proper financial reconciliation between the procuring business unit and the receiving business unit using intercompany invoicing. This accounting requires that a transaction flow is defined between the two organizations.

## Center-Led Procurement Step by Step:

### Define Transaction Flows

Transaction flows define the procurement relationship between different operating units. The details of this relationship define how the expenses are transferred from one business unit to the other (could be a different ledger).

Defining a transaction flow consists of these steps:

1. Define transaction flow
2. Define intermediate nodes
3. Define intercompany relationship

See "Transaction Setup" in the *Oracle Inventory User's Guide* for details on setting up transaction flows.

### Global Agreements Setup Steps

Global agreements are blanket purchase agreements and contract purchase agreements which have been created to be used in a centralized procurement environment.

Defining a global agreement consists of these steps:

1. To take full advantage of all centralized procurement features, set the profile HR: Cross Business Groups to Yes at the site level.
2. Define a supplier site for the supplier in each operating unit that will be defined as a purchasing organization for the global agreement. The supplier site names do not need to be the same as the supplier site name in the global agreement.
3. Create a new blanket purchase agreement or contract purchase agreement with the Global checkbox enabled. See: *Entering Purchase Order Headers*, page 4-40.
4. Enable the the global agreement (select the purchasing organization and purchasing site) for those operating units that are authorized to order referencing the global agreement. See: *Entering Purchase Agreement Information*, page 4-55.
5. Define sourcing rule assignments for the global agreement in the executing operating unit. See: *Defining Sourcing Rules*, page 5-30

### Global Buyer Setup Steps

Enterprises using centralized purchasing can set up a global buyer which can create, update, and default onto purchasing documents. This enables buyers from multiple business units to fully participate in these actions without redundant setup procedures.

1. Define the global buyer as an employee in the business group that the buyer belongs to using the Oracle Human Resources Enter Persons window.
2. Define the global buyer as a buyer using the Oracle Purchasing Enter Buyers window. This can be done in any business group.
3. Set profile option HR: Cross Business Groups to Yes at the site level.
4. Assign as many Oracle Purchasing responsibilities as required to this global buyer. These responsibilities do not need to be linked to any specific business group.

### Global Requester Setup Steps

Enterprises using centralized purchasing can set up a global requester. This enables requisition creation from multiple business units (operating units).

1. Set profile option *HR: Cross Business Groups* to Yes at the site level.
2. Assign the Oracle Purchasing responsibility associated with the operating unit to the requester. You can assign all that are needed.
3. Requester selects the appropriate responsibility and creates the requisition.

### Global Supervisor Setup Steps

Enterprises using centralized purchasing can set up a global supervisor to approve purchase requisitions. This enables approvals from multiple business units.

**Note:** The global supervisor feature is only available to those enterprises using the employee/supervisor approval path.

1. Define the supervisor and assign to an approval group as you would normally set them up.
2. Set profile option *HR: Cross Business Groups* to Yes at the site level.

Once the profile is set to Yes, requisitions can be routed and forwarded to individuals in different business groups. The action history reflects the names of those who take action even though they are in different business groups.

## Related Topics

Defining Purchasing Options, page 1-33

## Controlling Purchasing Periods

Use the Control Purchasing Periods window to control the purchasing periods defined in the Accounting Calendar window. You use purchasing periods to create journal entries in your general ledger system. Purchasing lets you create journal entries only for transactions you enter in an open purchasing period. You create general ledger journal entries when encumbering requisitions, purchase orders or accruing receipts.

If you use encumbrance or budgetary control, Purchasing verifies that the GL Dates you provide on purchase order distributions and requisition distributions are within an open purchasing period. See: Budgetary Control and Online Funds Checking, *Oracle General Ledger User's Guide*.

If you use the Center-Led Procurement feature of Oracle Purchasing, you must insure that the purchasing periods remain open in all business units that you are likely to process purchase orders and receipts. See: Setup Center-Led Procurement, page 1-79.

### Prerequisites

- Before using this window you should define your purchasing periods in the Accounting Calendar window. See: Defining Calendars, *Oracle General Ledger User's Guide*.

#### **To control purchasing periods:**

1. Navigate to the Control Purchasing Periods window from the menu.  
Purchasing displays the Period Status, Period Number, Fiscal Year, Period Name, Begin Date, and End Date for each existing period.

Status	Num	Fiscal Year	Period	From Date	To Date
Open	1	2002	Jan-02	01/JAN/2002	31/JAN/2002
Open	12	2001	Dec-01	01/DEC/2001	31/DEC/2001
Open	11	2001	Nov-01	01/NOV/2001	30/NOV/2001
Open	10	2001	Oct-01	01/OCT/2001	31/OCT/2001
Open	9	2001	Sep-01	01/SEP/2001	30/SEP/2001
Open	8	2001	Aug-01	01/AUG/2001	31/AUG/2001
Open	7	2001	Jul-01	01/JUL/2001	31/JUL/2001
Open	6	2001	Jun-01	01/JUN/2001	30/JUN/2001
Open	5	2001	May-01	01/MAY/2001	31/MAY/2001
Open	4	2001	Apr-01	01/APR/2001	30/APR/2001

- In the Period Status field, you have the following options:

*Closed* - Use this option to close this purchasing period. When you close a purchasing period, Purchasing does not allow further accruals during this period. Purchasing reverses the status of accrued purchase order lines so that you can accrue them in the next period if you want.

*Future* - Use this option if you want to open this purchase period in the future. This option is available only when the current status is Never Opened.

*Never Opened* - Purchasing displays this default status if you have not opened this period in the past.

*Open* - Use this option to open this purchasing period.

*Permanently Closed* - Use this option if you do not want to open this period in the future. This option is irreversible.

## Related Topics

Defining Purchasing Options, page 1-33

Controlling the Status of AP Accounting Periods, *Oracle Payables User's Guide*

## Expense Charge Account Rules

When determining the default charge account for a line with a destination type of expense, the account generator may reference the charge account defined on the employee record. If the account generator references the employee record, then the Expense Charge Account Rules enable you to override one or multiple segments of that default account based on the item category. This ability to override does not interfere with the action of the account generator, but simply replaces those segments you configure after the account generator has created a charge account.

**Note:** This feature is available for lines containing one-time or inventory items as long as their destination type is expense.

The account segments defined in this window can only be used when the following conditions are true:

- Destination type is expense
- Purchase order was not created from a requisition
- Account was not set in preferences
- Account was not successfully derived from project-based rules
- Account was not successfully derived from the item setup

### Setup Steps:

1. Navigate to the Expense Charge Account Rules window.

Account Rule Type	Account Rule Value	Segment Name	Segment Value
ITEM CATEGORY	▼	⋮	▼
	▼		▼
	▼		▼
	▼		▼
	▼		▼
	▼		▼
	▼		▼

2. Select the Item Category in Account Rule Value. Duplicate rules for the same category are not permitted.
3. Select the account Segment Name. Duplicate rules for the same account segment are not permitted.
4. Select the account in Segment Value that you want to override the employee charge account segment for this item category.
5. Save your work.

## Choosing Workflow Options

Purchasing provides default functionality in its Oracle Workflow-automated processes. This default functionality is described in the sections below. If you do not want this default functionality, you can change it in the Oracle Workflow Builder.

Before you can use or modify any of the workflows in Purchasing, you need to set up Oracle Workflow if you haven't done so already. See: *Setting Up Oracle Workflow, Oracle Workflow Guide*.

Although Workflow is installed with Purchasing automatically, you need to complete additional setup steps described in the *Oracle Workflow Guide*, if you did not already do this as part of your installation or upgrade. Additionally install the Workflow Builder only if you want to modify the default workflows that Purchasing provides or if you just want to see and understand the workflow processes as they are graphically displayed in the Builder.

### Choosing Document Creation Options:

#### Prerequisite

- Before you can use or modify any of the workflows in Purchasing, you need to set up Oracle Workflow if you haven't done so already. See: *Setting Up Oracle Workflow, Oracle Workflow Guide*.

Oracle Purchasing integrates with Oracle Workflow technology to create standard purchase orders or blanket releases automatically from approved requisition lines. The workflow for creating purchasing documents automatically is called PO Create Documents. PO Create Documents includes important attributes which you should evaluate and consider changing in the Oracle Workflow Builder. See: *Customizing the Automatic Document Creation Workflow, page E-162.*

*Workflow for Creating Purchase Orders and Releases, page E-161*

#### Choosing a Process Mode for Automatic Document Creation

The item attribute Send PO Autocreation to Background is used by the Main Requisition Approval Process in the PO Requisition Approval workflow. Send PO Autocreation to Background determines whether the approval workflow should launch automatic document creation in *Background* mode. By default, this item attribute is set to Y for Yes. But you can change it to N for No if you'd rather process automatic document creation in *Online* mode.

Background and online modes affect your system performance in different ways. For more information on what *Background* and *Online* mean, see *PO: Workflow Processing Mode* in the section Profile Options in Purchasing, page C-1.

**Note:** The profile option *PO: Workflow Processing Mode* sets the

processing mode for the entire approval workflow in Purchasing, whereas the item attribute Send PO Autocreation to Background enables you to change the processing mode specifically for automatic document creation after requisition approval, regardless of how the profile option *PO: Workflow Processing Mode* is set.

### **If you want to keep the default mode of *Background***

1. Use the Submit Requests window in the System Administrator responsibility to start the Workflow Background Process, which must be running for Background mode.

**Important:** Since the item attribute Send PO Autocreation to Background contains a default value of Y-which means automatic document creation occurs in *Background* mode-you must start the Workflow Background Process if you are going to keep the default.

You can submit the process for all workflows or just for a particular workflow, in this case the PO Requisition Approval workflow. See: To Schedule Background Engines, *Oracle Workflow Guide*.

### **If you want to change the default mode to *Online***

1. Start the Oracle Workflow Builder and open the PO Requisition Approval workflow.

See: Opening and Saving Item Types, *Oracle Workflow Guide*.

2. Select the item attribute Send PO Autocreation to Background and open its Properties window.
3. Change its Default value from Y to N.

Automatic document creation, when launched from the requisition approval workflow process, will now perform in *Online* mode.

### **Deciding If You Want to Use the Timeout Feature**

#### **Prerequisite**

- Before you can use or modify any of the workflows in Purchasing, you need to set up Oracle Workflow if you haven't done so already. See: Setting Up Oracle Workflow, *Oracle Workflow Guide*.

The Timeout feature in the approval workflow enables you to specify a period of time after which, if no response has yet come from an approver, a reminder is sent. You can send up to two reminders to an approver using the Timeout feature. You can also specify that after a certain period of time, the document is forwarded automatically to



the next approver in the hierarchy. You can optionally set up this feature through the Oracle Workflow Builder.

If you don't set up the Timeout feature, the approval workflow will not time out; it will simply wait to receive a response from each approver.

### **To set up approval reminders using the Timeout feature**

1. Start the Workflow Builder and open the PO Approval workflow for purchase orders or the PO Requisition Approval workflow for requisitions.

See: Opening and Saving Item Types, *Oracle Workflow Guide*.

2. Open any of the following activities' Properties windows and enter a Timeout period (for instructions, see the Oracle Workflow Guide, *Oracle Workflow Guide*):

- To enable the Timeout feature in the PO Approval workflow, modify the following activities in the Notify Approver subprocess by entering a Timeout period in their Properties windows: Approve PO Notification, PO Approval Reminder 1, and PO Approval Reminder 2.
- To enable the Timeout feature in the PO Requisition Approval workflow, modify the following activities in the Notify Approver subprocess by entering a Timeout period in their Properties windows: Approve Requisition Notification, Requisition Approval Reminder1, and Requisition Approval Reminder2.

For example, you enter the following Timeout days in all three purchase order approval notifications as follows:

- Approve PO Notification - 3 days
- PO Approval Reminder 1 - 2 days
- PO Approval Reminder 2 - 1 day

In this example, the first notification, Approve PO Notification, times out after 3 days if the approver does not take an action on the notification, and PO Approval Reminder 1 sends the reminder notification. PO Approval Reminder 1 times out after 2 days, and PO Approval Reminder 2 times out after 1 day. Then the workflow looks for the next approver.

3. Save your changes.

The Workflow Background Process must be running for the Timeout feature to take effect.

See: Using the Workflow Background Engine, page 1-88.

## **Modifying Change Order Workflow Options:**

### **Prerequisite**

- Before you can use or modify any of the workflows in Purchasing, you need to set up Oracle Workflow if you haven't done so already. See: *Setting Up Oracle Workflow, Oracle Workflow Guide*.

Purchasing integrates with Oracle Workflow technology to let you define what changes to purchase orders or releases—for example, to amounts, suppliers, or dates—require full reapproval. All of the workflow processes and functions relating to change orders can be found within the PO Approval workflow. The change order workflow process uses the same reapproval rules already defined in Purchasing to determine whether a document, depending on its document type, requires reapproval. If you want to change the reapproval rules that the change order workflow uses, you can change those reapproval rules that determine what percentage change to a unit price, quantity, or document total requires reapproval. You can optionally change these rules by modifying their attributes in the Oracle Workflow Builder. See the section *Customizing the Change Order Workflow* in: *Workflow Processes for Approving Change Orders*, page E-133.

The change order workflow requires that Archive on Approve be chosen in the Document Types window. The Archive on Approve option copies the purchase order information into the archive tables in Purchasing every time you approve or reapprove a purchase order. The change order workflow needs to use this archive information to compare a document before and after you make a change.

## **Starting the Send Notifications for Purchasing Documents Process:**

The workflow process, Send Notifications for Purchasing Documents, looks for documents that are incomplete, rejected, or in need of reapproval and sends notifications to the appropriate people of the document's status. For these notifications to be sent, you need to start the concurrent program process Send Notifications for Purchasing Documents if you haven't done so already as part of your standard setup. See: *Send Notifications for Purchasing Documents*, page 13-36.

## **Using the Workflow Background Engine:**

### **Prerequisite**

- Before you can use or modify any of the workflows in Purchasing, you need to set up Oracle Workflow if you haven't done so already. See: *Setting Up Oracle Workflow, Oracle Workflow Guide*.

The Workflow Background Engine must be running if you are using the following options:

- The *Background* mode for Purchasing approvals. By default the profile option PO: Workflow Processing Mode is set to *Background*. You must start the Workflow

Background Engine in order for the *Background* mode to work. See: Profile Options in Purchasing, page C-1.

- The Timeout feature in any workflow. The Timeout feature sends reminder notifications.
- The Background mode for the item attribute Send PO Autocreation to Background in the PO Requisition Approval workflow. See: Choosing a Process Mode for Automatic Document Creation, page 1-85.
- The Confirm Receipts Workflow Select Orders process. This is a process you submit through the Submit Request window. If you submit it, the Workflow Background Engine must also be running. See: Confirm Receipts Workflow Select Orders Process, page 13-3.

If you are using the Workflow Background Engine for the Timeout feature, it is reasonable to schedule the process to run once or twice a day. If you are using it for *Background* mode, you should schedule it to run much more frequently; a workflow activity that is set to *Background* mode doesn't begin until the Workflow Background Engine picks it up for processing.

If you want to use the Workflow Background Engine for both requisitions and purchase orders, you need to submit it twice, once for PO Approval and once for PO Requisition Approval. Or, by not specifying an item type, you can submit it for all item types.

### **Report / Request Submission:**

In the Submit Requests window, in the System Administrator responsibility, select Workflow Background Process in the Name field.

See: To Schedule Background Engines, *Oracle Workflow Guide*.

## **iProcurement Setup Windows**

The following windows are part of Oracle iProcurement setup. Located in the Setup menu in Oracle Purchasing, they are used only by iProcurement. iProcurement is a self-service product used to create requisitions on the Web. These requisitions are turned into purchase orders in Purchasing. Use these windows only if you are setting up Oracle iProcurement:

- *Define Information Template* - enables you to create additional-information templates.

**Note:** Information templates are not the same as requisition templates in Purchasing. Requisition templates in Purchasing are a pre-filled listing of frequently ordered items. Information templates are additional information templates that a requester in iProcurement completes for certain items.

- *Item Source* - used to define internal or external catalog sources for items.
- *Define Catalog Server Loader Values* - enables you to define which catalog data to load into the system.
- *Define Catalog Server for External Suppliers* - enables communication with external suppliers outside the firewall.
- *Realms* - used to create user access privileges to internal or external catalogs.

For instructions on these windows, see the *Oracle iProcurement Implementation Manual*.

## Oracle Services Procurement

**Note:** Oracle Services Procurement requires a separate license from Oracle Purchasing.

This section discusses setting up Oracle Services Procurement. Oracle Services Procurement enables a streamlined process for sourcing, procuring and managing of services, including contingent labor, facilities management, marketing, information technology, and consulting services. These commodity areas usually account for a large percentage of an organization's spend. Oracle Services Procurement and Oracle Purchasing enable key business functions in the services procurement flow:

- Preferred supplier identification and management
- Long term agreements for fixed price and rate based services
- Purchase order management
- Time card management and payment request authorizations
- Invoice generation and payment

### Services Procurement Setup Step by Step:

The following setup steps are needed to implement Oracle Services Procurement in Oracle Purchasing.

1. Install Oracle Services Procurement and the latest Oracle Applications Financials family pack. **(Required)**
2. Set profile PO: Enable Services Procurement to Yes. **(Required)** See: Purchasing Profile Options, page C-1.
3. Define services procurement related jobs in Human Resources. **(Required)** See: Representing Jobs and Positions, *Oracle HRMS Enterprise and Workforce Management*

*Guide.*

4. Define Job and Category Association. **(Required)** See: Define Job and Category Association, page 1-92.
5. Enable Oracle Time & Labor for time cards:
  - Install and configure Oracle Time & Labor. **(Optional)**
  - Create contractors for services procurement in Oracle Human Resources. (**Optional**) See: Entering a New Person, *Oracle HRMS Enterprise and Workforce Management Guide*.
6. Set profile PO: UOM Class for Temp Labor Services. **(Required)** See: Purchasing Profile Options, page C-1.
7. Define Price Differential lookup codes. **(Required)**

This step involves the following tasks:

  1. Using the Application Developer responsibility, navigate to the Application Object Library Lookups window.
  2. Enter PRICE DIFFERENTIALS for the lookup Type.
  3. Enter Price Differentials for the lookup Meaning.
  4. Enter Oracle Purchasing for the lookup Application.
  5. Define your rate price differential lookup. Refer to the online help for details.

**Note:** Seeded lookup codes STANDARD and FIXED PRICE are not available for use.
8. Define line types for temp labor purchase basis. **(Required)** See: Defining Line Types, page 1-62.
9. Set system option profiles for notifications **(Optional)**:
  - PO: Amount Billed Threshold Percentage
  - PO: Contractor Assignment Completion Warning DelaySee: Purchasing Profile Options, page C-1.
10. Consider scheduling the Retrieve Time and Labor from OTL process. **(Optional)** See: Retrieve Time from Oracle Time & Labor (OTL), page 13-34.

## Define Job and Category Association

Part of the setup of Oracle Services Procurement is to associate a purchasing category set to an HR job. This is required for the entry of temp labor line types.

### Prerequisites

- Install and enable Oracle Services Procurement. See: Procurement Services Setup Step by Step, page 1-90.
- Define jobs. See: Representing Jobs and Positions, in your Oracle HRMS documentation set.
- Define categories. See: Defining Categories, *Oracle Inventory User's Guide*.

### To define associations:

1. Navigate to the Job Category Association window from the menu.
2. Click Create to define a new association.

You can search for existing associations by selecting Job, Category, or Business group. You then modify the association by clicking the Update icon.

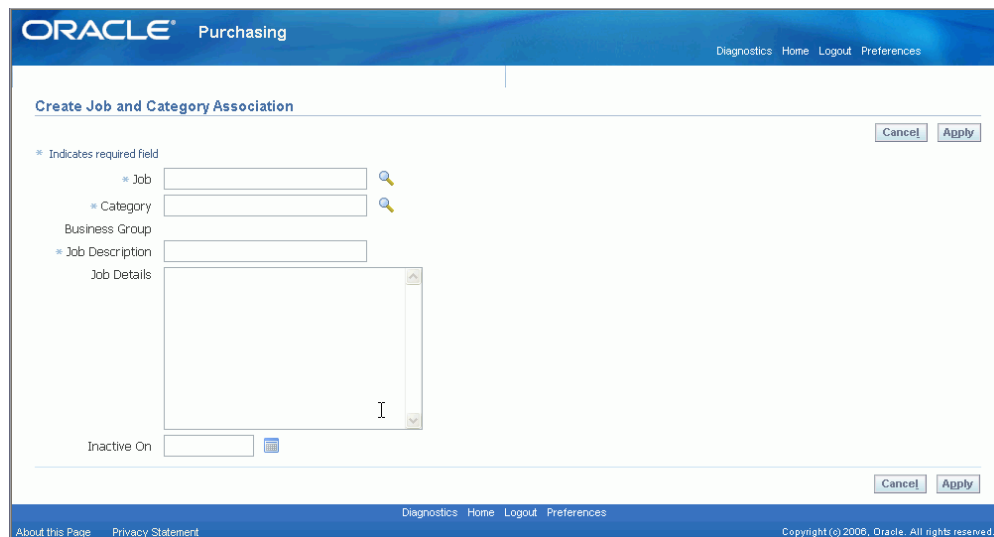

The screenshot shows the Oracle Purchasing interface for creating a job and category association. The page title is "ORACLE Purchasing" with navigation links for "Diagnostics", "Home", "Logout", and "Preferences". The main heading is "Create Job and Category Association". There are "Cancel" and "Apply" buttons at the top right and bottom right. The form includes several fields: "Job" (required), "Category" (required), "Business Group", "Job Description" (required), and "Job Details" (a large text area). An "Inactive On" field is at the bottom left. A legend indicates that an asterisk (\*) denotes a required field. The footer contains "About this Page", "Privacy Statement", "Diagnostics", "Home", "Logout", "Preferences", and "Copyright (c) 2006, Oracle. All rights reserved."

3. Enter or select the Job.

You can only enter jobs belonging to your business group unless the profile HR: Cross Business Groups is set to Yes.

4. Enter or select the Category.

5. Enter a descriptive title in Job Description.
6. Enter a narrative regarding this job in Job Details.
7. Enter an Inactive Date.
8. Save your work.

## **Related Topics**

Purchasing Services, page 1-59





---

## Approval, Security, and Control

### Setting Up Document Approval and Security

#### Human Resources with Purchasing

Human Resources and Purchasing share job and position information if they are installed together. You should consider your requirements from both perspectives before deciding on an approval/security structure.

Human Resources uses jobs to classify categories of personnel in your organization, and associates information like the exempt/non-exempt code and EEO code with individual jobs. Examples of a typical job include Vice President, Buyer, and Manager. Positions represent specific functions within these job categories. Examples of typical positions associated with the Vice President job include Vice President of Manufacturing, Vice President of Engineering, and Vice President of Sales.

Human Resources uses position hierarchies to define management line reporting and control access to employee information.

Review your Personnel department's system requirements before you decide how you want to use positions, jobs, and position hierarchies in Purchasing.

#### Using Approval Hierarchies

Approval hierarchies let you automatically route documents for approval. There are two kinds of approval hierarchies: position hierarchy and employee/supervisor relationships.

If you choose to use employee/supervisor relationships, you define your approval routing structures as you enter employees using the Enter Person window. In this case, Purchasing does not require that you set up positions.

If you choose to use position hierarchies, you must set up both jobs and positions. While positions and position hierarchies require more initial effort to set up, they are easy to

maintain and allow you to define approval routing structures that remain stable regardless of how frequently individual employees leave your organization or relocate within it.

## Using Security Hierarchies

Security hierarchies let you control who has access to certain documents. For example, you can create a security hierarchy in which only you and other buyers in that hierarchy can view each other's purchase orders.

Security hierarchies are not an alternative to approval hierarchies, but something different altogether. Changes you make to a security hierarchy do not affect the approval hierarchy and vice versa.

If you want to specify a Security Level of Hierarchy for any of your document types, you must first define all positions which should have access to the documents you want to restrict in this manner. (Even if you are using jobs to route documents for approval, you must define positions before you can enable this Security Level). You then define a security position hierarchy, and specify it in the Purchasing Options window.

## Approval Workflow

Purchasing uses Oracle Workflow technology to handle approvals. Workflow works in the background, using the approval controls and hierarchies you define in the setup steps below to route documents for approval. Because Workflow handles your approval process in the background, you can use Oracle Workflow Builder's easy interface to modify your approval process. See: Purchase Order Approval Workflow, page E-89. See: Requisition Approval Workflow, page E-50.

## Approval and Security Setup Steps

### To Setup Approval and Security:

1. Use the Financials Options window to indicate whether you want to route documents for approval using position hierarchies or employee/supervisor relationships. This decision applies only to the Business Group you choose for your Purchasing installation in the Financials Options window. See: About Financials Options, *Oracle Payables User's Guide*.

If you choose to use position hierarchies, you must define positions in addition to jobs. You later build your hierarchies by referencing these positions.

2. Use the Job window to create each of the job titles in your organization (for example: Buyer, Supply Base Engineer). If you are not using positions, you assign one or more employees to each job. If you are using positions, you assign one or more positions to each job, and later assign one or more employees to each position.

**Important:** You assign authorization rules to jobs or positions based on your decision in Step 1. It is important to ensure that your job/position infrastructure supports the different approval levels in your organization.

For example, if your purchasing staff includes a Junior Buyer, a Senior Buyer, a Supply Base Manager, and a Purchasing Manager, all of whom have different authorization levels for different document types, you should define a different job or position for each role. If your purchasing department is comprised of five employees with common authorization limits, then a single approval group (see steps 7 and 8) could be given to those five jobs or positions. See: Representing Jobs and Positions, *Oracle HRMS Enterprise and Workforce Management Guide*.

3. Use the Position window to create each of the positions in your organization. This step is required if you plan to use either security or position approval hierarchies. See: Representing Jobs and Positions, *Oracle HRMS Enterprise and Workforce Management Guide*.
4. Use the Position Hierarchy window to build and administer your position hierarchies. There are two distinct uses for position hierarchies in Purchasing: 1) document approval routing and 2) document security control. You can use a single position hierarchy for both purposes. See: Representing Jobs and Positions, *Oracle HRMS Enterprise and Workforce Management Guide*. See also: Position Hierarchies, page 2-6.
5. Use the Purchasing Options window to choose a single security hierarchy for your installation if you want to use the document Security Level of Hierarchy for any or all of your document types. See: Defining Control Options, page 1-34. For additional overview information, see Document Security and Access, page 2-7 and Approval Routing, page 2-10.

**Important:** Note that a security hierarchy controls which positions (and therefore which employees) have access to a particular document type. It does not control whether an employee has the authority to approve a document or perform other actions. An Off-line approver is a valid employee with approval authority, but without access to the relevant form. An On-line approver is an active employee with approval authorization, and with access to the relevant form.

6. Use the Document Types window to specify distinct security and approval controls for each document type/subtype. See: Defining Document Types, page 1-67.
7. Use the Approval Groups window to define approval authorization rules. See:

Defining Approval Groups, page 1-21.

8. Use the Assign Approval Groups window to associate approval rules with a specific job or position and a document type. See: Assigning Approval Groups, page 1-24.
9. Use the Enter Person window to assign employees to jobs or positions. If you are not using position approval hierarchies for document routing, you must provide the employee's supervisor. See: The online help for the Enter Person window, Enter Person, *Oracle HRMS Enterprise and Workforce Management Guide*.
10. Run the Fill Employee Hierarchy process. This process creates an employee-populated representation of your approvals hierarchy and should be run whenever you make a structural or personnel change to your hierarchies or assignments. You can set up this process to run automatically at predefined intervals. See: Fill Employee Hierarchy Process, page 13-6.

## Changing the Approval Hierarchy

When you make a change to an approval hierarchy—for example, by adding or removing an approver—existing documents still use the previous hierarchy before you changed it. Future documents use your changed hierarchy. Remember that every time you change a hierarchy, you must run the Fill Employee Hierarchy process.

If you are using position hierarchy approvals, and you move an employee out of a position that's in the approval hierarchy, assign another employee to the vacant position. You can remove a position altogether if it has no positions below it; you can also end-date the position or create a new version of the hierarchy. You can build a new version of a hierarchy by creating a new version of it or by copying an existing hierarchy.

If you are using employee/supervisor approvals, and you remove an employee or supervisor from an employee/supervisor chain, you must rebuild the employee/supervisor chain.

See: Change a Position Hierarchy, *Oracle HRMS Enterprise and Workforce Management Guide*.

## Approval and Security Setup Matrix

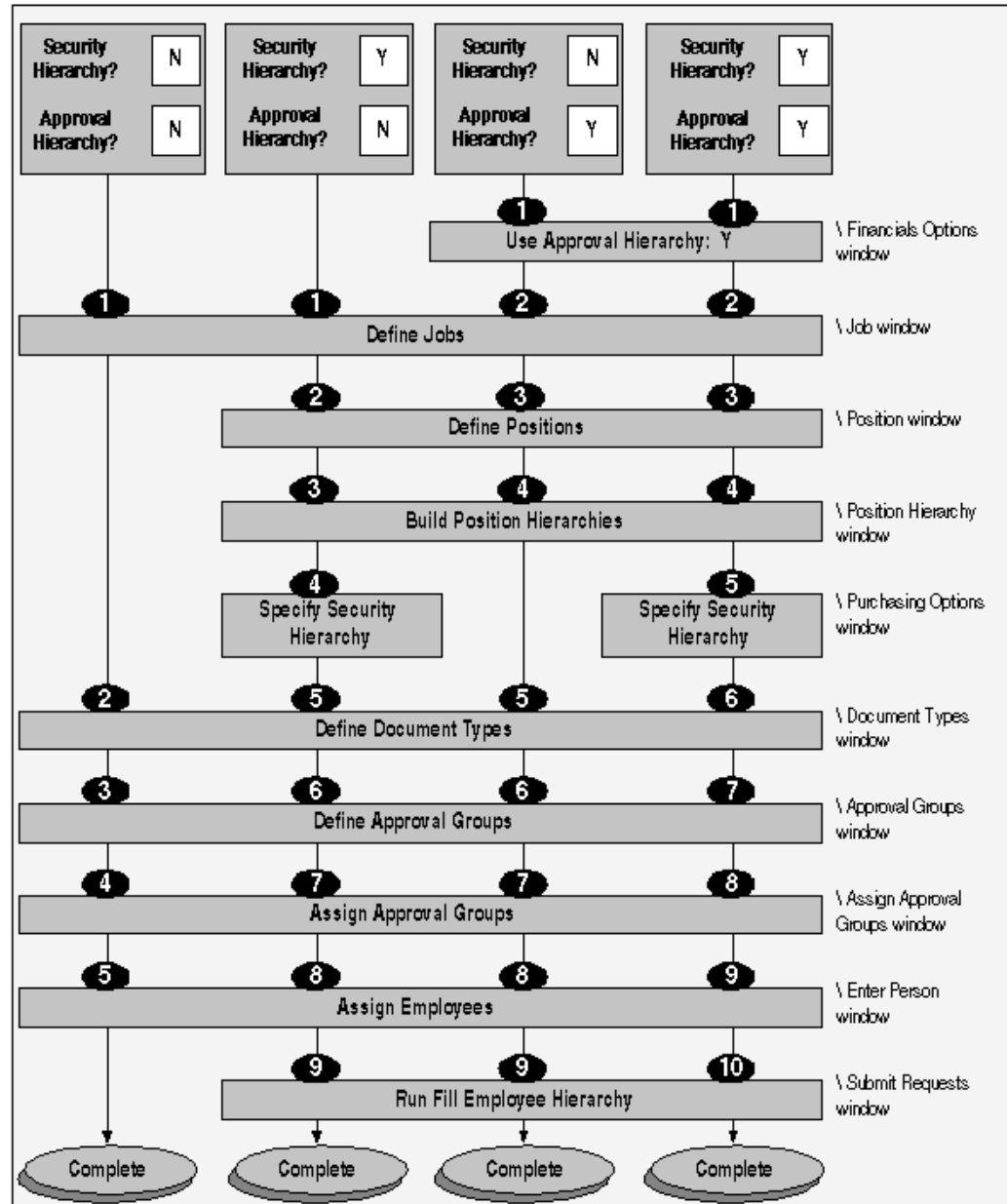

## Related Topics

Define a Position, *Oracle HRMS Enterprise and Workforce Management Guide*

Create a Position Hierarchy, *Oracle HRMS Enterprise and Workforce Management Guide*

Create a New Version of a Position Hierarchy, *Oracle HRMS Enterprise and Workforce Management Guide*

Copy an Existing Hierarchy, *Oracle HRMS Enterprise and Workforce Management Guide*

Delete a Position Hierarchy, *Oracle HRMS Enterprise and Workforce Management Guide*

Run the Position Hierarchy Report, *Oracle HRMS Enterprise and Workforce Management Guide*

## Position Hierarchies

Use the Positions window to create each of the positions in your organization. This step is required if you plan to use either security or position approval hierarchies. See: Representing Jobs and Positions, *Oracle HRMS Enterprise and Workforce Management Guide*.

All the positions you want to include in your hierarchies must be included in the Business Group you selected in the Financials Options window.

A position can be added to multiple hierarchies.

Use the Position Hierarchy window to build and administer your position hierarchies. There are *two* distinct uses for position hierarchies in Purchasing: 1) document approval routing and 2) document security control. You can use a single position hierarchy for both purposes. See: Representing Jobs and Positions, *Oracle HRMS Enterprise and Workforce Management Guide*.

When you build your hierarchies, always begin with the most senior position and work down. Use your organization charts and predefined special approval paths to facilitate this process.

While you can include a position in many hierarchies, it can appear only once within a single hierarchy.

If you want to use the document Security Level of Hierarchy for any or all of your document types, the hierarchy you specify in the Purchasing Options window must include all the positions in your organization that should have access to these documents. See: Defining Control Options, page 1-34.

If you build multiple hierarchies for use in the approval process, it is useful to give them meaningful names. This helps employees quickly choose the appropriate approval path when moving documents from one approval hierarchy to another.

For example, you can define a special approval hierarchy including a Facilities Manager and Chief Financial Officer for all plant and property purchases. Name this hierarchy "Facilities." Your default approval hierarchy for standard purchase orders (called "Purchasing") includes only your procurement staff and a Vice President of Operations, none of whom have the authority to approve plant and property items. When a buyer attempts to approve a standard purchase order for these items, Purchasing will require a forward-to employee. Assuming your setup allows changes to the default approval hierarchy for standard purchase orders, instruct buyers to route these documents to the "Facilities" approval hierarchy.

Before you can reference your position hierarchies in Purchasing, you must assign

employees to the referenced positions with the Enter Person window and then use the Submit Requests window to run the Fill Employee Hierarchy process. See: Fill Employee Hierarchy Process, page 13-6.

## Related Topics

Setting Up Document Approval and Security, page 2-1

## Document Security and Access

Purchasing lets you control which groups of employees have access to each document type, and what modification/control actions these individuals can take once they gain access. Use the Document Types window to specify your security options. See: Defining Document Types, page 1-67.

You can restrict document access based on the following Security Level options for each document type:

---

<b>Public</b>	All system users can access the document
<b>Private</b>	Only the document owner and subsequent approvers can access the document
<b>Purchasing</b>	Only the document owner, subsequent approvers, and individuals defined as buyers can access the document
<b>Hierarchy</b>	Only the document owner, subsequent approvers, and individuals included in the security hierarchy can access the document  Within the installation security hierarchy, you can access only those documents that you or your reporting employees own

---

**Important:** You must define one position hierarchy including all positions that require access to the document types you want to control with a Security Level of Hierarchy. You need to specify this hierarchy in the Purchasing Options window before you can choose a Security Level of Hierarchy for a given document type. See: Defining Control Options, page 1-34.

In addition to the Security Level, you specify an Access Level to control which modification/control actions you can take on a particular document type once you gain access. Document owners always have **Full** access to their documents. The Access Level

options include:

---

<b>View Only</b>	Accessing employees can only view this document
<b>Modify</b>	Accessing employees can view, modify, and freeze this document
<b>Full</b>	Accessing employees can view, modify, freeze, close, cancel, and final-close this document

---

Both the Security Level and Access Level apply to existing documents. Anyone with menu access to the document entry windows can create a document. These individuals then become the document owners unless they change the buyer name.

The Security Level and Access Level work together. For example, if you assign a Security Level of Public and an Access Level of Full to standard purchase orders, then all users can access all standard purchase orders from document entry, view, and control windows.

**Important:** While any document is in the approval process (regardless of Access or Security Level), no one can access it using an entry window.

If you change the Access Level to View Only for a document type, then all users (except for the document owner whose Access Level is always Full, and approvers who can optionally modify the document when it is in their approval queue based on the document control Approver Can Modify) can access these documents in the view windows, but not in the document entry or control windows. If you change the Security Level for a document type to Private, then only the document owner and subsequent approvers can access these documents.

Finally, the Security Level and Access Level work with the Approver Can Modify option that you choose in the Document Types window. If this control is set to Yes for a particular document type (even if the Access Level is View Only), then all approvers can modify documents in their pending approval queue. Once you approve a document, you cannot make further modifications.

The following tables describe the effects of all possible Security Level and Access Level combinations in which groups of employees can access documents using the view, entry, or control windows.

## Public Document Security Access Level Matrix



<b>Access Level</b>	<b>View Windows</b>	<b>Entry Window: Doc NOT in Approval</b>	<b>Entry Window:Doc in Approval</b>	<b>Control Window:Freze/ Close</b>	<b>Control Window: Cancel/ Final Close</b>
View Only	All	Owner	None	Owner	Owner
Modify	All	All	None	All	Owner
Full	All	All	None	All	All

### Private Document Security Access Level Matrix

<b>Access Level</b>	<b>View Windows</b>	<b>Entry Window: Doc NOT in Approval</b>	<b>Entry Window:Doc in Approval</b>	<b>Control Window:Freze/ Close</b>	<b>Control Window: Cancel/ Final Close</b>
View Only	Owner Approver	Owner	None	Owner	Owner
Modify	Owner Approver	Owner	None	Owner	Owner
Full	Owner Approver	Owner	None	Owner	Owner

### Purchasing Document Security Access Level Matrix

<b>Access Level</b>	<b>View Windows</b>	<b>Entry Window: Doc NOT in Approval</b>	<b>Entry Window:Doc in Approval</b>	<b>Control Window:Freze/ Close</b>	<b>Control Window: Cancel/ Final Close</b>
View Only	Owner Approver Buyers	Owner	None	Owner	Owner
Modify	Owner Approver Buyers	Owner Approver Buyers	None	Owner Buyers	Owner Buyers

<b>Access Level</b>	<b>View Windows</b>	<b>Entry Window: Doc NOT in Approval</b>	<b>Entry Window:Doc in Approval</b>	<b>Control Window:Freeze/ Close</b>	<b>Control Window:Cancel/ Final Close</b>
Full	Owner Approver Buyers	Owner Approver Buyers	None	Owner Buyers	Owner Buyers

## Hierarchy Document Security Access Level Matrix

<b>Access Level</b>	<b>View Windows</b>	<b>Entry Window: Doc NOT in Approval</b>	<b>Entry Window:Doc in Approval</b>	<b>Control Window:Freeze/ Close</b>	<b>Control Window:Cancel/ Final Close</b>
View Only	Owner Approver Hierarchy	Owner	None	Owner	Owner
Modify	Owner Approver Hierarchy	Owner Hierarchy	None	Owner Hierarchy	Owner
Full	Owner Approver Hierarchy	Owner Hierarchy	None	Owner Hierarchy	Owner Hierarchy

## Approval Routing

Purchasing lets you route documents for approval based on either position hierarchies or employee/supervisor relationships. In both cases, you control whether documents are routed to the first employee with enough authority to approve the document (Direct method), or if they must pass through each level of the associated hierarchy or reporting infrastructure regardless of authority (Hierarchy method). You can also control whether document owners are able to approve the documents they create.

Use the Document Types window to specify routing controls by document type. See: Defining Document Types, page 1-67.

## Owner Can Approve

Prevent or allow document owners to approve the documents they create.

## Can Change to Forward-To

Prevent or allow changes to the default forward-to employee.

If you are using position approval hierarchies and there is more than one employee associated with a particular position, Purchasing defaults a Forward-To employee in the Approvals window based on alphabetic order.

If you are using position approval hierarchies and allow changes to the Forward-To employee, the list of values in the Approvals window includes all employees in the selected hierarchy.

If you are routing documents using employee/supervisor relationships and you allow changes to the Forward-To employee, the list of values in the Approvals window includes all employees defined in the Business Group you specify in the Financials Options window.

## Can Change Forward-From

Prevent or allow changes to the default forward-from employee. This control applies only to requisitions.

If you allow changes to the forward-from employee, Purchasing restricts the Forward-From list of values in the Approvals window to requestors associated with the requisition you are trying to approve.

This flexibility allows you to build an approval history including the original requestor rather than the preparer.

## Can Change Approval Hierarchy

This control applies only if you are using position approval hierarchies. Prevent or allow changes to the default approval hierarchy.

If you allow changes to the default approval hierarchy, the list of values in the Approvals window includes all hierarchies defined in the Business Group you specify in the Financials Options window.

**Important:** When you submit a document for approval, Purchasing verifies that you are included in the default position hierarchy for your document. If you are not included in this hierarchy, and Allow Change to Approval Hierarchy is set to No, you cannot approve the document or route it to another employee.

## Forward Method

Select Direct to route documents to the first employee with enough authority to approve them. Select Hierarchy to route documents to the next person in the approval

hierarchy or reporting infrastructure regardless of authority.

Approval authority is determined by the approval rules you define in the Define Approval Groups and Assign Approval Groups windows. For example, a hierarchy of three approvers consists of one with a \$1,000 approval limit, one with a \$5,000 approval limit, and one with a \$10,000 approval limit. In a Direct forward method, a document totalling \$7,000 is routed directly to the approver with the \$10,000 approval limit. In a Hierarchy forward method, the document routes to all three approvers, stopping at the \$10,000 approver.

## Default Hierarchy

This control applies only if you are using position approval hierarchies. You must specify a default approval hierarchy for each document type.

Combine these controls to build an approval routing policy that is as strict or as flexible as your needs warrant. For example, if you set Allow Change to Approval Hierarchy and Allow Change to Forward-To to No, Purchasing forces employees to route all documents according to the approval hierarchy or employee / supervisor relationships that you define. If you set these controls to Yes, Employees can route documents for approval with a high degree of autonomy and flexibility within the structures you define.

## Related Topics

About Financials Options, *Oracle Payables User's Guide*

Submitting a Document for Approval, page 2-32

## Approval Authorization Control

You can define flexible groups of authorization rules (Approval Groups) which you assign to specific document types and jobs or positions (based on your implementation). These authorization rules are comprised of include/exclude and amount limit criteria that you specify for Document Total, Account Range, Item Range, Item Category Range, and Location. You can associate multiple approval groups (collections of authorization rules) with a single document/job or position combination to create unique approval structures in support of your organization's signature policies. Finally, you link employees to authorization limits when you assign them to jobs or positions.

When you attempt to approve a document, Purchasing evaluates the authorization rules associated with your job or position and the document type to determine whether you have adequate authority. If you do not have enough authority to approve the document, Purchasing provides default routing information based on your approval setup. Depending on the level of routing flexibility you specify, approvers may or may not be able to change these defaults.

## Related Topics

Defining Approval Groups, page 1-21

Assigning Approval Groups, page 1-24

Defining Approval Authorization Rules, page 2-13

Using Approval Assignments, page 2-15

## Defining Approval Authorization Rules

An approval group is a set of authorization rules comprised of include/exclude and amount limit criteria for the following Object Types: Document Total, Account Range, Item Range, Item Category Range, and Location. For each position or job, you ultimately associate these approval groups with document types to implement your authorization rules.

To build an approval group, first assign a descriptive name that will make it easy to reference in the Assign Approval Groups window. You can then add multiple rules for the same Object Type to your approval group. When you associate two or more rules for the same Object Type with a single job/position and document type combination, Purchasing uses the most restrictive criteria during the authorization check.

An Account Range rule defines the distribution accounting flexfield ranges and their amount limits that the approval group can approve, and an Include rule is required for at least one approval group associated with each document type in the Assign Approval Groups window.

- To include an account range, choose this Object Type with an Approval Type of Include, enter an Amount Limit, and specify the Value Low and Value High for your range.

**Important:** The Amount Limit that you specify for an Account Range Include rule applies to the sum of all accounts included in the range. It does not apply to each individual account within the range.

- To exclude an account range, choose this Object Type with an Approval Type of Exclude and specify the Value Low and Value High for your range. The approval group will be unable to approve documents including these accounting distributions, even if your enabling Include rule contains these accounts within its upper and lower bounds.

A Document Total rule defines the maximum document amount that the approval group can approve. This type of rule is optional for all but a blanket purchase agreement approval group. If you want to specify a Document Total, choose this Object Type with an Approval Type of Include and enter an Amount Limit.

**Note:** The Document Total rules are the only rules applied to blanket purchase agreements.

An Item Range rule defines the items and their amount limits that the approval group can approve. An Item Range rule is not required; approval groups can approve documents for all items by default.

- To include an item range, choose this Object Type with an Approval Type of Include, enter an amount limit, and specify the Value Low and Value High for your range. An Item Range Include rule allows you to specify approval amount limits for individual items or item ranges, and the Amount Limit you enter applies to the sum of all items within the range. Also, an Item Range Include rule does not implicitly exclude items that are not referenced in the rule.
- To exclude an Item Range, choose this Object Type with an Approval Type of Exclude and specify the Value Low and Value High for your range. The approval group will be unable to approve documents including these items.

An Item Category Range rule defines the item categories and their amount limits that the approval group can approve. An Item Category Range rule is not required; approval groups can approve documents for all item categories by default.

- To include an Item Category Range, choose this Object Type with an Approval Type of Include, enter an Amount Limit, and specify the Value Low and Value High for your range. An Item Category Range include rule allows you to specify approval amount limits for individual item categories or item category ranges, and the Amount Limit you enter applies to the sum of all item categories within the range. Also, an Item Category Range include rule does not implicitly exclude item categories that are not referenced in the rule.
- To exclude an Item Category Range, choose this Object Type with an Approval Type of Exclude and specify the Value Low and Value High for your range. The approval group will be unable to approve documents including these item categories.

A Location rule defines the ship-to and deliver-to locations and their amount limits that this approval group can approve. Purchasing verifies the ship to location for purchase orders and releases, and the deliver to location for requisitions. A Location rule is not required; approval groups can approve documents for all ship to and deliver to locations by default.

- To include a Location rule, choose this Object Type with an Approval Type of Include, enter an Amount Limit, and specify the Location you want to control using the Value Low field. A Location Include rule allows you to specify approval amount limits for individual ship to and deliver to locations. It does not implicitly exclude locations not referenced in the rule.

- To exclude a ship to or deliver to location, choose this Object Type with an Approval Type of Exclude and specify the location using the Value Low field. The approval group will be unable to approve purchase orders and releases that include this location as a ship to, or requisitions that include this location as a deliver to.

To illustrate approval group implementation, assume a Purchasing department is comprised of three kinds of purchasing professionals with a corresponding position defined for each in Purchasing: Senior Buyers (who purchase all manufacturing and MRO items/services with a \$50,000 document limit), MRO Buyers (who purchase all non-manufacturing items and services with a \$10,000 document limit), and Junior Buyers (who purchase all but one manufacturing item category with a \$25,000 document limit).

- This organization uses four two-segment item categories: MRO-SERVICE, MRO-SUPPLIES, MFG-GENERAL, and MFG-SPECIAL.
- First, define one approval group called "Buyer Master" containing a single Account Range Include rule for all accounting distribution ranges with a \$50,000 Amount Limit.
- You can then define a supplementary approval group called "MRO Buyer" containing two rules: 1) a Document Total rule with an Amount Limit of \$10,000 and 2) an Item Category Range rule excluding all item categories with MFG as the first segment.
- Finally, you can define another supplementary approval group called "Junior Buyer" containing three rules: 1) a Document Total rule with an Amount Limit of \$25,000, 2) an Item Category Range rule excluding all item categories with MRO as the first segment, and 3) another Item Category Range rule excluding the MFG-SPECIAL category.

## Related Topics

Defining Approval Groups, page 1-21

Defining Approval Assignments, page 1-24

Approval Authorization Rules, page 2-12

Using Approval Assignments, page 2-15

## Using Approval Assignments

Use the Assign Approval Groups window to associate approval groups with a specific job or position and a document type including: Purchase Requisition, Internal Requisition, Standard Purchase Order, Planned Purchase Order, Blanket Purchase Agreement, Contract Purchase Agreement, Scheduled Release, and Blanket Release. You can associate multiple approval groups with a single document type/job or position combination. Whenever you associate two or more approval groups with a single

document type/job or position combination, Purchasing uses the most restrictive rule to evaluate authorization limits.

**Important:** While individual approval groups do not require an enabling Account Range Include rule, every document type for each job/position must be associated with at least one approval group with this characteristic. Otherwise, employees in the associated job or position will be unable to approve this document type.

If no approval groups are associated with a particular document type for a given job or position, then employees assigned to this job or position will be unable to approve documents of this type.

**Example**

If you want to specify the approval assignments for the Purchasing department described in the Defining Approval Authorization Rules document (See: Defining Approval Authorization Rules, page 2-13), you can begin with the Senior Buyer position. Assuming Senior Buyers should be able to approve all document types, you can set up the control assignments as follows:

Control Function	Approval Group	Start Date
Blanket Purchase Agreement	Buyer Master	dd-MON-yy
Blanket Release	Buyer Master	dd-MON-yy
Contract Purchase Agreement	Buyer Master	dd-MON-yy
Internal Requisition	Buyer Master	dd-MON-yy
Planned Purchase Order	Buyer Master	dd-MON-yy
Purchase Requisition	Buyer Master	dd-MON-yy
Scheduled Release	Buyer Master	dd-MON-yy
Standard Purchase Order	Buyer Master	dd-MON-yy

This plan allows Senior Buyers to approve all document types for all account ranges with a maximum amount limit of \$50,000. The Senior Buyer position can approve all locations, items, and item categories by default.

If Junior Buyers can approve releases (and no other document types) based on the authorization criteria you specified in the Defining Approval Authorization Rules document, set up the Control Assignments as follows for this position:



Control Function	Control Group	Start Date
Blanket Release	Buyer Master	dd-MON-yy
Blanket Release	Junior Buyer	dd-MON-yy
Scheduled Release	Buyer Master	dd-MON-yy
Scheduled Release	Junior Buyer	dd-MON-yy

In this case, Junior Buyers can approve up to \$25,000 for each Blanket and Scheduled Release including all but one category of manufacturing items. These employees cannot approve Standard Purchase Orders, Planned Purchase Orders, Purchase Requisitions, Internal Requisitions, Blanket Purchase Agreements, or Contract Purchase Agreements regardless of document total or content. Finally, Junior Buyers are unable to approve any document type that includes MRO item categories.

**Important:** Note that we assigned two approval groups to each document type in this example. The Buyer Master approval group lets Junior Buyers approve releases by providing an enabling Account Range Include rule. The Junior Buyer approval group introduces the specific authorization restrictions for this position. Remember, the most restrictive rules prevail at approval time, so even though the Buyer Master Account Range Include rule allows for a \$50,000 Amount Limit, the Junior Buyer Document Total rule with a \$25,000 Amount Limit controls the approval ceiling.

MRO Buyers should be able to approve any document type for up to \$10,000 of MRO item categories. Set up the approval assignments as follows:

Control Function	Approval Group	Start Date
Blanket Purchase Agreement	Buyer Master	dd-MON-yy
Blanket Purchase Agreement	MRO Buyer	dd-MON-yy
Blanket Release	Buyer Master	dd-MON-yy
Blanket Release	MRO Buyer	dd-MON-yy
Contract Purchase Agreement	Buyer Master	dd-MON-yy

<b>Control Function</b>	<b>Approval Group</b>	<b>Start Date</b>
Contract Purchase Agreement	MRO Buyer	dd-MON-yy
Internal Requisition	Buyer Master	dd-MON-yy
Internal Requisition	MRO Buyer	dd-MON-yy
Planned Purchase Order	Buyer Master	dd-MON-yy
Planned Purchase Order	MRO Buyer	dd-MON-yy
Purchase Requisition	Buyer Master	dd-MON-yy
Purchase Requisition	MRO Buyer	dd-MON-yy
Scheduled Release	Buyer Master	dd-MON-yy
Scheduled Release	MRO Buyer	dd-MON-yy
Standard Purchase Order	Buyer Master	dd-MON-yy
Standard Purchase Order	MRO Buyer	dd-MON-yy

## Related Topics

- Defining Approval Groups, page 1-21
- Defining Approval Assignments, page 1-24
- Approval Authorization Rules, page 2-12
- Defining Approval Authorization Rules, page 2-13

## Assigning Employees

### To assign employee to jobs or positions:

1. Use the Enter Person window to assign employees to jobs or positions. If you are not using position approval hierarchies for document routing, you must provide the employee's supervisor. See: Enter Person, *Oracle HRMS Enterprise and Workforce Management Guide*.

You can assign an employee to only one job or position.

**Important:** If Human Resources is installed, you must maintain employee information using the People window for Human Resources. See: *Entering a New Person, Oracle HRMS Enterprise and Workforce Management Guide.*

2. Before you can reference your position hierarchies in Purchasing, you must run the Fill Employee Hierarchy process. This process creates an employee-populated representation of your approvals hierarchy and should be run whenever you make a structural or personnel change to your hierarchies or assignments. You can set up this process to run automatically at predefined intervals. See: *Fill Employee Hierarchy Process, page 13-6.*

The process creates an error log which lists all positions to which no employee is assigned, but having such positions is a benign error that does not hamper system operation.

## The Document Approval Process

### Approve Document Window

Purchasing lets you approve requisitions, standard and planned purchase orders, blanket and contract purchase agreements, and releases using a common process. When you complete your documents and are ready to initiate the approval process, select the Approve button in the document entry window to open the Approve Document window.

In the Approve Document window, choosing Submit for Approval (and then choosing OK) approves the document if Owner Can Approve is enabled for the specific document type in the Document Types window and you have the authority to approve the document. See: *Defining Document Types, page 1-67.* If the document requires someone else's approval, choosing Submit for Approval (and then choosing OK) automatically submits the document to that person (or routes it to multiple approvers) for approval, based on your approval hierarchy setup. See: *Setting Up Document Approval and Security, page 2-1.*

Purchasing offers the following document approval actions in the Approve Document window: Reserve or Unreserve (if using encumbrance / budgetary control), Submit for Approval, and Forward. You can also change the approval hierarchy from within the Approve Document window if Allow Change to Approval Hierarchy is selected for the document type in the Document Types window. You can also specify a Forward To person if you want the document to be approved by someone outside the approval hierarchy.

Purchasing offers several methods for supplier notification. You can select the Print option, and the document will automatically be printed once it is approved. In addition,

certain documents can be transmitted electronically by facsimile, e-mail, electronic data interchange (EDI), or extensible markup language (XML).

When submitting a blanket purchase agreement for approval, the Approve Document window can optionally provide the ability to automatically create or update supplier sourcing business rules. You may also initiate retroactive pricing updates on related documents.

When you select the Approve button in a document entry window, Purchasing performs submission checks to verify that the document is complete and in an appropriate state for the action you chose. Status checks are performed when you take an approval action. See: Document Submission Checks, page 2-22. See: Document Status Checks, page 2-21.

## Notifications Web Page

You can also approve documents through the Notification Details Web page, accessible through the Notifications Summary menu in Purchasing. The Notifications Summary page lists all the documents awaiting your approval, so that you can manage your pending approval queue and take approval actions. After opening a notification, you can drill down to the document itself, and review it and its action history. You can also modify the document if Approver Can Modify is enabled for the document type. See: Defining Document Types, page 1-67. (After you modify a document, you need to return to the notification to take an approval action.)

You can also view and respond to notifications through e-mail. Oracle Applications uses Oracle Workflow technology to route notifications through e-mail. This way, an approver who has easier access to e-mail than to the Purchasing application can view notifications and take approval actions.

See: To View Notifications from the Worklist, *Oracle Workflow Guide*.

See: Reviewing Notifications via Electronic Mail, *Oracle Workflow Guide*.

## Approval Workflow

Purchasing uses Oracle Workflow technology to handle the entire approval process. When you take an approval action in the Approve Document window or the notification, or through the Web or e-mail, you are "submitting" the approval action to Workflow. Workflow works in the background, using the approval controls and hierarchies you've defined to route documents for approval. Because Workflow handles your approval process in the background, you can use Oracle Workflow Builder's easy interface to modify your approval process. For more information about the approval workflows in Purchasing, see: Purchase Order Approval Workflow, page E-89 and Requisition Approval Workflow, page E-50.

## Related Topics

Submitting a Document for Approval, page 2-32

## Approved Documents and Supply

A Pre-Approved document does not show up as supply. A Pre-Approved document is one that meets the following conditions:

- A person with the final authority to approve the document approves it, but then forwards it to someone else for additional approval, thus changing its status to Pre-Approved.
- Your organization uses encumbrance (reserves funds for documents), and the document is authorized for approval but funds have not yet been reserved for it. Even if someone with sufficient approval authority approves the document, its status may still be Pre-Approved if funds were not able to be reserved at the time of approval. Once funds are reserved for the approved document, the document changes its status to Approved.

A Pre-Approved document does not show up as supply until its status changes to Approved.

When you make a change to an approved document that changes its status to Requires Reapproval, that change (for example, to quantity) does not show up as supply until the document has been approved again.

Approved requisition lines that have a line type based on rate or fixed price do not show up as supply.

## Document Status Checks

Purchasing performs a status check on all documents whenever you perform or attempt an approval action. This check verifies that the document is in a valid state to perform the selected approval action. If your document fails the status check, Purchasing provides an error message in the window in which you are working.

The following matrix describes the valid actions for each document state. Generally, lists of values in the document entry and approval windows restrict the list of available approval actions based on document status, so you should rarely encounter status check failures.

### Document Approval Status: Valid Action Rules

Current Document Status	Approve	Reserve	Unreserve	Forward	Reject
Incomplete	X	X	X	X	

<b>Current Document Status</b>	<b>Approve</b>	<b>Reserve</b>	<b>Unreserve</b>	<b>Forward</b>	<b>Reject</b>
In Process	X	X	X	X	X
Approved			X		
Pre-Approved	X	X	X	X	X
Rejected	X	X	X	X	
Returned	X	X	X	X	
Requires Reapproval	X	X	X	X	
Hold					
Frozen					
Cancelled					
Reserved	X		X	X	X
Not Reserved	X	X	X	X	X
Open	X	X	X	X	X
Closed	X	X	X	X	X

## Document Submission Checks

Purchasing performs a submission check on all documents that successfully complete a status check whenever you perform or attempt an approval action.

The submission check verifies that all mandatory fields have been entered and that various quantities, amounts, and dates are within prescribed ranges or limits. If your document fails any of the submission check rules, Purchasing automatically brings you to the Approval Errors window where you can review the cause(s) of failure. You can then return to the document entry window to make required corrections.

The following matrix describes the submission checks that are performed for each

document type.

## Submission Check Rules

HEADER	Standard	Planned	Blanket	Contract	Release	Requisition
Document must have a supplier	X	X	X	X		
Document must have a supplier site	X	X	X	X		
Supplier must not be on hold	X	X	X	X		
Supplier must be included in current Approved Supplier List entries for items requiring an approved supplier	X	X	X		X	
Document must have a currency	X	X	X	X		
Foreign currency must have a rate	X	X	X	X		
Foreign currency must have a rate type	X	X	X	X		
Foreign currency must have a rate date if rate type is not User	X	X	X	X		
Document must have a ship-to location	X	X	X	X		
Document must have a bill-to location	X	X	X	X		

HEADER	Standard	Planned	Blanket	Contract	Release	Requisition
Amount limit must be greater than or equal to Amount Agreed			X	X		
Amount limit must be greater than or equal to Minimum Release Amount		X	X			
Amount limit must be greater than or equal to the total amount already released		X	X	X		
Amount limit must be greater than or equal to the standard purchase order line total referencing this contract					X	
Related document cannot be on hold					X	
Release date must fall within related document effectivity dates					X	
Related purchase agreement cannot be on hold	X				X	
Related purchase agreement must be approved	X				X	



<b>HEADER</b>	<b>Standard</b>	<b>Planned</b>	<b>Blanket</b>	<b>Contract</b>	<b>Release</b>	<b>Requisition</b>
Related purchase agreement must not be expired (if release was never approved)	X				X	
Related document supplier cannot be on hold	X				X	
Current release total must be greater than or equal to header minimum release amount specified on related agreement	X				X	
Current release total plus all approved release totals must be greater than or equal to the related document amount limit	X				X	
Oracle Procurement Contracts: No contract terms validation errors	X		X	X		

<b>LINE</b>	<b>Standard</b>	<b>Planned</b>	<b>Blanket</b>	<b>Contract</b>	<b>Release</b>	<b>Requisition</b>
Each document must have at least one line	X	X	X			X
Line quantity must equal the sum of its shipment quantities	X	X				

<b>LINE</b>	<b>Standard</b>	<b>Planned</b>	<b>Blanket</b>	<b>Contract</b>	<b>Release</b>	<b>Requisition</b>
Line price limit must be equal to or greater than the unit price if price override is allowed	X	X	X			
If a line references a contract, the contract must be approved (and not on hold)	X	X				
If a line references a contract, the supplier on the contract must be the supplier on the PO header	X	X				
If a line on an incomplete purchase order references a contract, the line must have been created within the contract's effectivity dates	X					
PO line total related to a contract plus existing approved lines relating to the same contract cannot exceed contract amount limit	X					
Requisition line quantity must equal the sum of its distribution quantities						X

<b>LINE</b>	<b>Standard</b>	<b>Planned</b>	<b>Blanket</b>	<b>Contract</b>	<b>Release</b>	<b>Requisition</b>
Line may not use ATO or CTO items	X	X			X	X

<b>SHIPMENT</b>	<b>Standard</b>	<b>Planned</b>	<b>Blanket</b>	<b>Contract</b>	<b>Release</b>	<b>Requisition</b>
Each PO line must have at least one shipment	X	X				
Shipment quantity must equal the sum of its distribution quantities	X	X			X	
Each release must have at least one shipment					X	
Current shipment total must be greater than or equal to line minimum release amount specified on related document					X	
Price must be within specified price tolerance if Enforce Price Tolerance is Yes and the release was AutoCreated from a requisition					X	
Line may not use ATO or CTO items	X	X			X	X

<b>SHIPMENT</b>	<b>Standard</b>	<b>Planned</b>	<b>Blanket</b>	<b>Contract</b>	<b>Release</b>	<b>Requisition</b>
For an unreserve action, shipment must not be overbilled or overdelivered	X				X	
<b>DISTRIBUTION</b>	<b>Standard</b>	<b>Planned</b>	<b>Blanket</b>	<b>Contract</b>	<b>Release</b>	<b>Requisition</b>
Each shipment must have at least one distribution	X	X			X	
Each requisition line must have at least one distribution						X
An internally sourced requisition line must have only one distribution						X
Foreign currency distributions must have a rate	X	X			X	X
Foreign currency distributions must have a rate type	X	X			X	X
Foreign currency distributions must have a rate date if rate type is not User	X	X			X	X
If using encumbrance, the GL date must be in an open period	X	X	X		X	X

## Viewing and Responding to Approval Notifications

Use the Notification Details Web page, accessible through the Notifications Summary menu in Purchasing, to manage your pending approval queue and take approval actions. After opening a notification, you can also submit a document for approval from the notification if you didn't yet do it through the Approve Document window.

Purchasing offers the following document approval actions in the notification: Approve, Approve and Forward, Forward, and Reject. You can also reassign a notification to somebody else.

The approval amount noted in the notification includes nonrecoverable tax if you use tax and recovery rates. See: Tax Information in Purchasing, page 4-116.

The Notifications Web page requires Oracle Workflow to be set up. See: Setting Up Oracle Workflow, *Oracle Workflow Guide*.

### Reassign and Forward

A **Reassign** action is not recorded in the Action History window, but a **Forward** action is. See: Viewing Action History, page 10-1. To reassign a notification but still record you as the approver, choose Reassign, and then choose Transfer. To forward the notification so that the new approver is recorded in the action history instead of you, open the notification and select the Forward action. (Do not use the Reassign/Transfer option.)

### Ignore

Some reminder notifications include a response of Ignore. Ignore means that you are ignoring the notification for now. Purchasing will not display that notification again until the concurrent program process Send Notifications for Purchasing Documents runs. (See: Send Notifications for Purchasing Documents, page 13-36.)

### Close Button

When you click Close, Purchasing considers the notification closed. If you want to see the notification again, choose Search and select a status of All or Closed.

### Opening a Document

From a notification that you have opened, you can also drill down to the document and modify it if Approver Can Modify is enabled for the document type. See: Defining Document Types, page 1-67. Depending on the function security assigned to your responsibility, you have varying levels of access to information. A responsibility defines an application user's current privileges while working with Oracle Applications.

**Important:** After you modify a document

opened through the notification, you must return to the notification and choose Approve there, not in the document itself, so that Purchasing can record your approval action and continue with or complete the approval process.

## Purchasing Notifications

In the Notifications Summary list, notifications for the following Purchasing documents appear. The Send Notifications for Purchasing Documents process must be running for some of these notifications to be sent:

- Purchase orders and requisitions that require approval action.
- Requisitions or purchase orders that are incomplete.
- Purchase orders and releases that require acceptance. (You indicate on your standard purchase orders, purchase agreements, and releases whether you require your suppliers to accept your orders by a specific date by selecting Acceptance Required in the Terms and Conditions window.) For purchase orders and releases that have not been entered as accepted in the Acceptances window, Purchasing notifies you that acceptance is required. If the Acceptance Require By date indicates that the acceptance is overdue, Purchasing sends a notification that acceptance is past due.
- RFQs and quotations with a Status of In Process. Purchasing sends a notification that the document requires completion.
- RFQs for which the Status is Active and the current date is between the Due Date and the Close Date on the RFQ. Purchasing sends a notification that the RFQ is approaching expiration.
- Quotations for which the Status is Active and the current date is between the Effectivity end date on the Quotation and the Quote Warning Delay end date in the Default region of the Purchasing Options window. Purchasing sends a notification that the quotation is approaching expiration.
- Blanket purchase agreements or catalog quotations sent by your supplier through the Purchasing Documents Open Interface when price increases on those documents exceed a price update tolerance that you define. You receive a notification for each affected document. See: Receiving Price/Sales Catalog Information Electronically, page 5-18.
- Reschedule notifications from Master Scheduling/MRP. Master Scheduling/MRP

can automatically reschedule standard purchase orders and blanket and planned releases by changing the Need By date on the document if you respond to the reschedule notification with your approval. See: Summary of Exception Process 2, *Oracle Master Scheduling/MRP and Oracle Supply Chain Planning User's Guide*.

- Debit memos that failed to be created when you entered a Return to Supplier transaction, if automatic debit memo creation is enabled in both the Supplier Sites and the Returns windows. The buyer is notified. See: Debit Memos, page 9-14.
- If Oracle Services Procurement is implemented, you can also receive the Amount Billed Exceeded Threshold and the Contractor Assignment Completion notifications.

For notifications about purchase order acceptances, RFQ expiration, and quotation expiration, you can choose a response of Close. The closed notification won't reappear unless you change the expiration date on the document.

**If you receive a notification titled Document Manager Failed:**

Open the notification and read the detailed message. You or your system administrator may need to reactivate the PO Document Approval Manager. Once the PO Document Approval Manager is reactivated, respond to the notification by choosing Retry.

**Important:** After the PO Document Approval Manager is reactivated, you must respond to the notification with Retry to restart the approval process where it left off.

**If you receive a notification titled Unable to Reserve Document:**

You have several options:

- Reserve the document again if, for example, more funds have been allocated.

**Important:** To reserve funds for the document, first *open the document from the notification*. Choose the Approve button in the document, and then check Reserve and OK. Then respond with Retry in the notification.

- Send the document back to its preparer for modification; the preparer can then, for example, reduce the quantity on the document and submit it again for approval.
- Forward the document to somebody else with authority to reserve the funds.

**If you see Resubmit Requisition, Update Requisition, and Requisition Detail icons in a notification:**

These icons enable you to resubmit, update, or view requisitions only if iProcurement is installed.

## Additional Information

For more detailed instructions on how to use the Notifications Summary Web page, including the Worklist and Find Notifications pages accessible in the Workflow menu in Purchasing, see: *To View Notifications from the Worklist, Oracle Workflow Guide*, and *To Find Notifications, Oracle Workflow Guide*.

You can also view and respond to notifications through e-mail. Oracle Applications uses Oracle Workflow technology to route notifications through e-mail. This way, an approver who has easier access to e-mail than to the Purchasing application can view notifications and take approval actions. See: *Reviewing Notifications via Electronic Mail, Oracle Workflow Guide*.

## Related Topics

Overview of Function Security, *Oracle Applications System Administrator's Guide*

Function Security for Purchasing, page D-1

Send Notifications for Purchasing Documents, page 13-36

## Submitting a Document for Approval

Use the Approve Document window to take approval actions on documents that you create or modify. (You can also use this window to make changes to encumbered documents. See: *Changing Encumbered Documents*, page 4-113.)

### **To take approval actions:**

Navigate to the Approve Document window by selecting the Approve button in a document entry window.



1. If you are using encumbrance/budgetary control, Reserve and Unreserve options are available.

*Reserve* - You can reserve funds for the document only if you are using encumbrance/budgetary control. Requisition preparers can choose this option only if Reserve at Completion in the Financials Options window is enabled and the document is currently unreserved. See: Defining Financials Options, *Oracle Payables User's Guide*. When you select Reserve (and then OK), Purchasing reserves the funds now. Purchasing also automatically approves the document if the document has been preapproved, you're the appropriate approver, and no more approvals are required. If you get a message that you cannot reserve the funds, forward the document to an approver who has the authority to reserve them. If you don't select Reserve, but just select Submit for Approval (and then OK), Purchasing reserves funds later, when the approver with the authority to reserve the funds approves the document.

*Unreserve* - You can unreserve funds for the document only if you are using encumbrance/budgetary control and funds are currently reserved for that document.

*Unreserve Date* - If you selected Unreserve, enter an Unreserve Date that falls within an open reserve period.

*Use GL Override* - Use this selection to force the reservation of funds for the document. It defaults from the profile PO: Override Funds Reservation. See: Profile

Options in Purchasing, page C-1.

*Use Document GL Date to Unreserve* - This selection uses the document's distribution GL dates for the funds reversal instead of the unreserve date. It defaults from the profile PO: Use Document GL Date to Unreserve. See: Profile Options in Purchasing, page C-1.

*Accounting Date* - If dual budgetary control is enabled, then the Accounting Date for this document must be entered.

2. Select Submit for Approval.
3. Select Forward only if you want to forward the document to someone other than the next approver in the default Approval Path.

If you select Forward, you must enter a Forward To person. If you don't select Forward, Purchasing will automatically route the document to the appropriate person in the Approval Path, if you're not the appropriate approver.

If the Forward To person is higher up in the default (or selected) Approval Path, but still does not have enough approval authority, Purchasing will continue the approval process with the next person in that Approval Path. If the Forward To person is not in the default (or selected) Approval Path, and also does not have enough approval authority, you will receive an Approver Not Found notification.

4. If Allow Change to Approval Hierarchy is selected for the document type, you can select a new Approval Path. See: Defining Document Types, page 1-67.
5. Enter notes in the Note field to record information about your approval action or provide instructions for the next approver if your document requires additional authorization. See also: Attaching Notes to Purchasing Documents, page 1-33.
6. Enter your comments regarding recent changes to this document in the Change Summary field. If you are using PDF output for purchase orders, these are displayed on the cover page. See: Purchase Orders in PDF Format, page 1-78.
7. If appropriate for this document, select a supplier notification method from the Transmission Methods box. Refer to the discussion of Document Transmission Methods below.
8. If you are approving a blanket purchase agreement and your organization allows sourcing updates or retroactive pricing from this window open the Additional Options tab. Refer to To enter Additional Options, page 2-35 below.
9. Choose OK.

The document is submitted to the approval process, which routes the document to the appropriate approvers based on the approval hierarchies and controls you've defined. If Owner Can Approve is enabled for the specific document type in the

Document Types window and you have the authority to approve the document, then choosing OK approves the document.

**To cancel your approval action:**

1. Choose the Cancel button to cancel your approval action and return to your document entry window.

**To change the Forward From person:**

1. For requisitions only, if you have selected Forward as the action and if Allow change to Forward-From is enabled for the document type in the Document Types window, you can change the Forward From person to the original preparer or to any requestor on a line of the requisition. See: Defining Document Types, page 1-67.

**To change the Forward To person:**

1. If you have selected Forward as the action and if Allow change to Forward-To is enabled for the document type in the Document Types window, you can change the Forward To person. See: Defining Document Types, page 1-67.

The Forward To value is a default from the employee/supervisor relationship or from the approval hierarchy, depending on whether you are using approval hierarchies.

**To enter Additional Options :**

From the Additional Options tab of the Approve Document window you can automatically create or update sourcing rules, sourcing rule assignments, and approved supplier list entries during approval submission of a blanket purchase agreement.

**Important:** The PO: Allow Auto-generate Sourcing Rules profile must be set to either Create Only or Create and Update for the create or update options to be visible in the Document Approval window. See: Profile Options in Purchasing, page C-1.

**Important:** In addition to the profile above, your document archival method must be set to archive on Approval. If it is set to archive on Transmission the sourcing update checkboxes will not appear. See: Defining Document Types, page 1-67.

1. Select the Enable Automatic Sourcing checkbox and then choose a Release Generation Method to create new supplier sourcing rules, rule assignments, and approved supplier list entries.

2. Select the Update Existing Sourcing Rules and Assignments to extend an existing sourcing rule effectivity date or to add a new supplier and supplier site for a current sourcing rule effectivity date. The sourcing rules will not be updated if the item is multi-sourced (rule has multiple suppliers) or if the rules contains multiple items. This action also updates an existing approved supplier list (ASL) entry with the purchase agreement information as long as the agreement is not already listed in the ASL.

See: Approved Supplier Lists, page 5-35.

3. Select the Apply Price Update to Existing POs and Releases to have existing standard purchase orders (sourced to global agreements) and blanket agreement releases updated with the pricing from the blanket agreement that you are submitting for approval.
4. Once you have selected Apply Price Update to Existing POs and Releases you may also select Communicate Price Updates. This selection will enable communication of purchase orders and releases that are impacted by the new pricing to the supplier. Otherwise only this purchase agreement is communicated to the supplier.

### **Document Transmission Methods:**

Although your organization may prefer not to, you can request to prepare your purchase order for transmission to the supplier from the Approval window. You have a choice of several different methods by which the approved document can be transmitted to the supplier. Oracle Purchasing must be configured to support all of these methods. See: Communicating Purchase Orders to Suppliers, page 4-6.

Note that purchase orders can be transmitted using the traditional printed text method or in a PDF (Portable Document Format) file depending on your configuration. See: Purchase Order Communication to Suppliers, page 1-75.

### **To print the document:**

1. Select Print.

The document will automatically print once it is approved.

A purchase order will not print if the supplier site on the purchase order is already set up to receive purchase orders through Electronic Data Interchange (EDI) or XML delivery.

### **To send a facsimile of the purchase order:**

1. Select Fax and enter a Fax Number. RightFax, or any facsimile software that is compatible with the RightFax Fax Command Language (FCL), must be installed to use this functionality.

If the Supplier Notification Method in the supplier site window (General tab) is set to Fax and you have entered a fax number for that supplier site then the number

will default in. This is a default and you can change it. Once approved, the document will be faxed to the supplier by the purchase order approval workflow. See: Supplier and Supplier Sites Window Reference, *Oracle Payables User's Guide*

Selecting Fax and entering a Fax Number automatically sends a facsimile of the document once it is approved.

Selecting Fax without entering a Fax Number sends the document to your facsimile server once it is approved. Depending on your RightFax setup, you can choose where or when to send the documents that are stored on your facsimile server.

If the supplier is already set up to receive purchase orders through Electronic Data Interchange (EDI) or XML delivery, a facsimile of the purchase order will not be sent.

**To send an e-mail of the purchase order:**

1. Select E-mail and enter an e-mail address to send this standard purchase order, blanket agreement, or blanket release by way of e-mail. Selecting E-mail and entering an e-mail address automatically sends the purchasing document by way of e-mail, once it is approved.

If the Supplier Notification Method in the Supplier Site window (General tab) is set to E-mail and you have entered an e-mail address for that supplier site then the address will default into the Document Approval window. Once approved, the document will be e-mailed to the supplier by the purchase order approval workflow. The e-mail will be sent in the language indicated for the supplier site. See: Supplier and Supplier Sites Window Reference, *Oracle Payables User's Guide*

Note that setting your supplier site notification method as described above simply provides a default on this form. The buyer is free to change or override these defaults.

If the supplier is already set up to receive purchase orders through Electronic Data Interchange (EDI) or XML delivery, an e-mail of the purchase order will not be sent.

## Related Topics

Defining Document Types, page 1-67

The Document Approval Process, page 2-19

Viewing and Responding to Notifications, page 2-29

Setting Up Document Approval and Security, page 2-1

Purchase Order Approval Workflow, page E-89

Requisition Approval Workflow, page E-50

## Offline Approvers

An offline approver is someone who does not log on to Oracle Applications, but uses someone else to approve on his or her behalf.

All approvers, including offline approvers, need to have a logon user name. Even if the approver is set up as an employee in the approval hierarchy, Purchasing cannot continue with approval without that employee's also having a logon user name.

If in the Approve Document window you forward to an approver who does not have a logon user name, Purchasing alerts you right away. If an approver without a logon user name is already included in the approval hierarchy, the approval workflow will fail at that approver. (The document will remain In Process.)

To include the offline approver in document approvals, you need to:

- Assign the offline approver a logon user name.
- Use the notification handling feature to forward the offline approver's documents to a proxy approver—someone who can log on to Oracle Applications and approve the document on the offline approver's behalf.

You need to do both of these steps. The approval process needs to know the offline approver's logon user name before it can route that person's documents to the proxy approver. Both of these steps are described below.

When you designate a proxy approver to approve on the offline approver's behalf, the offline approver, not the proxy approver, shows up as having approved the document in the Action History window.

### To designate a proxy approver:

1. Assign the offline approver a logon user name if the approver does not already have one.

For instructions, see: *Users Window, Oracle Applications System Administrator's Guide*.

2. In the Purchasing or System Administrator responsibility, in the Workflow menu, navigate to Notification Rules, which opens a Web page.

In the System Administrator responsibility, the Workflow Administrator > Notification Rules menu enables you to reassign anyone's notifications. In the Purchasing responsibility, the Workflow User > Notification Rules menu enables you to reassign only your notifications.

3. Designate a proxy approver for the offline approver by following the instructions in *Defining Rules for Automatic Notification Handling, Oracle Workflow Guide*.

The instructions for defining these rules refer to a *role*. For Purchasing, *role* means

the user for whom you are designating a proxy approver.

When you reach the Find Notification Routing Rules Web page, enter the user name of the offline approver.

If you want to designate the proxy approver for both requisitions and purchase orders, when you reach the step about selecting the workflow (item type) for which you need to create the proxy approver, select the PO Requisition Approval workflow. Then repeat the steps for the PO Approval workflow, for purchase orders. (Recall that different document types are tied to their corresponding workflows-usually to either the PO Requisition Approval workflow or the PO Approval workflow-in the Document Types window during Purchasing setup. For example, the PO Approval workflow handles all purchase order types, unless you've set up the Document Types window to do differently.)

Once you have selected the workflow, you will be presented with a list of the notifications within the workflow. For offline approvers, you may want to select All notifications.

When you reach the step that asks you to enter a comment, it is advisable to enter a comment-for example, "This document requires your approval on Joan's behalf." This helps the proxy approver know whether it is just another document in his or her queue, or a document that needs to be approved for someone else.

## Mass Forwarding Documents

Use the Forward Documents window to forward all or selected documents awaiting approval from one approver to a new approver. This lets you keep your documents moving when the original approver of a document is unavailable.

### To mass forward documents:

1. Select Forward Documents from the menu. Purchasing displays the Find Documents window, where you *must* identify an approver or document number and operating unit. In this window enter or select the name of the original approver, or enter the document number, and select OK to display the Forward Documents window.



For each document available for forwarding, Purchasing displays the Forward Date, document Type, document Number, Currency, Amount, Status, From person, Note, document Description, document Owner, and Creation Date.

2. Select the documents you want to forward.
3. Enter the New Approver to whom you want to forward the selected documents.
4. Save your work.

**To select different search criteria:**

1. Click on the Find Documents button to display the Find Documents window. Here you can select a different approver or document number to be displayed in the Forward Documents window.

**To view action history:**

1. Select View Action History on the Tools menu. See: Viewing Action History, page 10-1.

## Document Control Overview

Purchasing allows you to control the status of your requisitions, planned and standard purchase orders, blanket and contract purchase agreements, and releases during the document life cycle.



Purchasing provides you with the features you need to satisfy the following basic needs. You should be able to:

- Delete unapproved documents or unapproved lines, shipments, and distributions that you add to previously approved documents
- Terminate existing commitments to buy from suppliers by fully or partially cancelling your documents
- Indicate that no further internal activity is expected or allowed on completed orders by final closing them
- Freeze or unfreeze documents to control whether modifications are allowed
- Place documents on hold to prevent printing, receiving, invoicing, and approval until the hold is removed
- Firm purchase orders to prevent Oracle Master Scheduling/MRP and Supply Chain Planning from suggesting reschedules in, cancellations, or new planned purchase orders within the time fence created by your firm date
- Control how Purchasing automatically closes documents for receiving and invoicing activity

Document Security determines the documents on which you can perform control actions. See: Document Security and Access, page 2-7.

If the document is a global agreement, the Manage Global Agreements function security determines if you can perform control actions. See: Function Security for Purchasing, page D-1

## Related Topics

Controlling Documents, page 2-57

## Document Control Options

### Delete

Before documents are approved, you can delete them or their components from the document entry window.

**Important:** If you are using automatic numbering, you cannot reuse document numbers that you delete with this option.

You can also use the appropriate entry window to delete unapproved lines, shipments, and distributions that you added to previously approved documents.

If you use online requisitions, Purchasing returns all requisitions associated with your delete action to the requisition pool. You can reassign these unfilled requisitions to other purchase orders or releases using the AutoCreate Documents window. See: Finding Requisition Lines for AutoCreate, page 6-9.

## Cancel

Purchasing lets you terminate an existing commitment to buy from a supplier by cancelling document headers, lines, shipments, or releases.

When you cancel a purchase order entity, you are unable to receive or pay for cancelled items and services, however, you can pay for all previously received orders. You also cannot modify a cancelled entity or its components. For example, if you cancel a line you cannot modify the associated shipments and distributions. If you cancel a document header, you cannot access the document in the corresponding entry form. You can approve documents that include cancelled entities (lines and shipments), but you cannot approve documents that are cancelled at the header level. You can also communicate cancelled documents to the supplier. Purchasing marks these documents with a cancellation notice to highlight this action to the supplier. Finally, you can Purge documents that were cancelled at the header level before the Last Activity Date that you specify when you submit Purge. See: Printed Purchase Order Overview, page 8-3. See: About Purging Records, *Oracle Payables User's Guide*.

If you are using encumbrance and budgetary control, Purchasing automatically creates negative debit encumbrance journal entries in your general ledger system to reverse the encumbrance that corresponds to the document header, lines, or shipments you are cancelling. The amount of the encumbrance is the lesser of the unbilled or undelivered amount on the shipment being cancelled. If the amount delivered is more than the billed at the time the shipment is cancelled, the encumbrance is left on the purchase order, awaiting invoicing of the delivered but not yet billed amount.

If you are using online requisitions with quantity or amount based line types, Purchasing returns unfilled requisitions associated with cancelled purchase order entities to the requisition pool based on the Cancel Requisitions control you specify in the Purchasing Options window. See: Defining Control Options, page 1-34. If you are using online requisitions with rate or fixed price based line types the unfilled requisitions are cancelled.

### Example

You order 100 items from a supplier, and after receiving 30 of these items, you realize that you no longer have a need for the outstanding balance. Cancel the remaining 70 items, print the purchase order, and send it to the supplier to indicate contractually that you do not want to take delivery of these items.

You should cancel documents or their components only if you are absolutely certain that all desired activities have been completed; you cannot undo a cancel action.

You can cancel an entire requisition or particular requisition lines. However, you cannot cancel a requisition line a buyer placed on a purchase order, modified during AutoCreate, or placed on a sales order.

If a buyer places a requisition line on a purchase order, you cannot cancel the requisition line or the corresponding requisition header until you cancel or final close all purchase order lines associated with the requisition.

Similarly, you cannot cancel a requisition if any of its lines are on an active internal sales order. However, if the related internal sales order is cancelled, you should cancel the originating requisition line.

When you cancel a requisition related to a cancelled sales order, the quantity cancelled on the requisition line is the same as the quantity cancelled on the sales order line, not the remainder of the requisition.

You cannot cancel a purchase order if there are batch receiving transactions in the receiving interface awaiting processing against the purchase order.

If you partially received a shipment corresponding to multiple distributions, Purchasing cannot always cancel the shipment. To make sure Purchasing can cancel a shipment, enter the delivery transactions for the receipts you entered against that shipment. You can use express delivery to facilitate this process.

Use the Control Document window to cancel a single document or its entities. Use the Define MassCancel and Run MassCancel windows to cancel many documents by accounting distribution and date range. See: Controlling Documents, page 2-57. See: Defining MassCancel, page 2-61. See: Running MassCancel, page 2-67.

## Final Close

Prevent modifications to or actions against completed documents, lines, and shipments by final closing them. Final-closed documents are not accessible in the corresponding entry forms, and you cannot perform the following actions against final-closed entities: receive, transfer, inspect, deliver, correct receipt quantities, invoice, return to supplier, or return to receiving. You can approve documents that include final-closed entities, but you cannot approve documents that are final closed at the header level. You can print final-closed documents; this is an internal control action that has no bearing on your contractual relationship with the supplier. Finally, you can Purge documents that were final closed at the header level before the Last Activity Date that you specify when you submit Purge. See: About Purging Records, *Oracle Payables User's Guide*.

You should final close documents or their components only if you are absolutely certain that all desired activities have been completed; you cannot undo a final-close action.

If you are using encumbrance and budgetary control, final close automatically creates credit encumbrance journal entries in your general ledger system to reverse the encumbrance that corresponds to the document header, lines, or shipments you are final closing. The amount of the encumbrance depends on whether the shipment is using online or period end accruals. For online accruals the encumbrance amount is the undelivered amount. For period end accruals the encumbrance amount is the unbilled amount.

If you are using encumbrance accounting you may want to finally close a cancelled shipment for which you have encumbrance balances (from any quantity delivered but

not billed at the time the shipment was cancelled, or from invoices cancelled after the shipment was cancelled). In this case, the the final close action will remove any encumbrance balances that were on the shipment.

If you are using online requisitions, Purchasing does not return unfilled requisitions associated with final-closed purchase order entities to the requisition pool. You must cancel or final close these requisitions using the Control Document window. See: Controlling Documents, page 2-57.

Payables can also final close documents during Payables Approval for purchase order matched invoices only, if you select Allow Final Matching in the Payables Options window. See: Payables Options, *Oracle Payables User's Guide*.

You can final close an entire requisition or particular requisition lines. However, you cannot final close a requisition line a buyer placed on a purchase order, modified during AutoCreate, or placed on a sales order.

If a buyer places a requisition line on a purchase order, you cannot final close the requisition line or the corresponding requisition header until you cancel or final close all purchase order lines associated with the requisition.

Similarly, you cannot final close a requisition if any of its lines are on an active internal sales order. If the related internal sales order is closed, you can final close the originating requisition line.

You cannot final close a purchase order if there are batch receiving transactions in the receiving interface awaiting processing against the purchase order.

## **Freeze**

Freeze your purchase orders and releases to prevent changes or additions while maintaining the ability to receive and match invoices against received shipments. You cannot access frozen documents in the entry forms.

Use the Control Document window to freeze or unfreeze a document. See: Controlling Documents, page 2-57.

## **Hold**

Place documents on hold to unapprove them while preventing printing, receiving, invoicing, and future approval until you remove the hold.

### **Example**

After sending a purchase order to a supplier and receiving some items, you discover a severe quality problem with one of the incoming lots. While you wait for corrective action from the supplier, place the document on hold until the problem is resolved.

Use the Control Document window to place a document on hold, or remove a hold. See: Controlling Documents, page 2-57.

## Firm

When you firm an order, Master Scheduling/MRP uses the firm date to create a time fence within which it will not suggest new planned purchase orders, cancellations, or reschedule-in actions. It continues to suggest reschedule-out actions for orders within the time fence. If several shipments with different promised or need-by dates reference the same item, Master Scheduling/MRP sets the time fence at the latest of all scheduled dates.

You can firm orders at the document header or shipment level. If you firm at the header level, Purchasing applies this control to every shipment on the document.

### Example

When you negotiate delivery dates for an allocated commodity, the supplier warns that you will be unable to expedite or cancel this order. Firm the order to prevent Master Scheduling/MRP from assuming you have this flexibility in its planning logic.

Use the relevant document entry window to firm a given order. See: *Entering Purchase Order Details Information*, page 4-61. See: *Entering Release Headers*, page 4-84.

You can also create firm time fences for specific items using the Item window. See: *Defining Items*, *Oracle Inventory User's Guide*.

## Close, Close for Receiving, Close for Invoicing

Purchasing automatically closes shipments for receiving and invoicing based on controls that you specify in the Purchasing Options window. Once all shipments for a given line are closed, Purchasing automatically closes the line. When all lines for a given header are closed, Purchasing automatically closes the document.

You can specify closing controls including: Receipt Close Tolerance, Receipt Close Point, and Invoice Close Tolerance. See: *Defining Purchasing Options*, page 1-33.

- The Receipt Close Tolerance lets you specify a quantity percentage within which Purchasing closes a partially received shipment. For example, if your Receipt Close Tolerance is 5% and you receive 96% of an expected shipment, Purchasing automatically closes this shipment for receiving.
- The Receipt Close Point lets you choose which receiving action (Received, Accepted, or Delivered) you want to use as the point when Purchasing closes a shipment for receiving based on the Receipt Close Tolerance. For example, if you set a Receipt Close Tolerance of 5% and choose Delivered as your Receipt Close Point, Purchasing closes shipments for receiving when you have delivered 95% or more of the ordered quantity.
- The Invoice Close Tolerance lets you specify a similar quantity percentage within which Purchasing automatically closes partially invoiced shipments for invoicing.

Purchasing does not include closed shipments in the Open Purchase Order reports, and you can purge documents that were closed at the header level before the Last Activity

Date that you specify in the Submit Purge window. See: *About Purging Records, Oracle Payables User's Guide*

You can close and reopen documents and their components for invoicing and receiving using the Control Document window. You can reopen a document at any time by modifying it or taking another action against it. See: *Controlling Documents, page 2-57.*

**Note:** The Close for Invoicing status does not prevent you from matching an invoice to a purchase order or to a receipt.

## Purchase Order Control Matrices

The following matrices describes each of the purchase order control functions including information on where the control is specified, what purchase order activities can occur when a document is in a given state, the related MRP/ATP effects, related encumbrance effects, and finally, related requisition effects.

Control Details	Close	Close for Invoicing	Close for Receiving
Document available to purge?	Yes, if header final closed before Last Activity Date	No	No
Modify controlled entity?	Yes	Yes	Yes
Action causes revision change?	No	No	No
Print or transmit document?	Yes	Yes	Yes
Receive against controlled entity?	Yes	Yes	Yes
RTV against controlled entity?	Yes	Yes	Yes
Invoice against controlled entity?	Yes	Yes	Yes
Does document maintain its approval status?	Yes	Yes	Yes

<b>Control Details</b>	<b>Close</b>	<b>Close for Invoicing</b>	<b>Close for Receiving</b>
AutoCreate or Release against document?	Yes	Yes	Yes
MRP/ATP Effect	Closed quantity no longer available as supply; supply is recreated when reopened	No effect	Closed quantity no longer available as supply; supply is recreated when reopened
Encumbrance Effect	No effect	No effect	No effect
Associated Requisitions	No effect	No effect	No effect
Transportation Integration	Closed quantity is no longer available for transportation planning	No effect	Closed quantity is no longer available for transportation planning

<b>Control Details</b>	<b>Cancel</b>	<b>Finally Close</b>	<b>Freeze</b>	<b>Hold</b>	<b>Firm</b>
Document available to purge?	Yes, if header cancelled before Last Activity Date	Yes, if header final closed before Last Activity Date	No	No	No
Modify controlled entity?	Cannot modify entity or below cancelled entity	Cannot modify entity or below final-closed entity	No	Yes	Yes
Action causes revision change?	Yes	No	No	No	No
Print or transmit document?	Yes	Yes	Yes	No	Yes

<b>Control Details</b>	<b>Cancel</b>	<b>Finally Close</b>	<b>Freeze</b>	<b>Hold</b>	<b>Firm</b>
Receive against controlled entity?	No	No	Yes	No	Yes
RTV against controlled entity?	No	No	Yes	Yes	Yes
Invoice against controlled entity?	Yes	No	Yes	No	Yes
Does document maintain its approval status?	Yes, if header, line, or shipment is cancelled; but if you cancel the header, the Cancelled check box is selected	Yes if header, line, or shipment is final closed; but if you final close the header, the Closure Status is updated correspondingly	Yes, but the Frozen check box is selected	No; documents on hold require reapproval	Yes
AutoCreate or Release against document?	Cannot add req to cancelled doc; cannot create release	Cannot add req to final-closed doc; cannot create release	Cannot create release against frozen purchase order	No effect	No effect
MRP/ATP Effect	Cancelled quantity no longer available as supply	Finally Closed quantity no longer available as supply	No effect. MRP can suggest reschedule actions	No effect	MRP will not reschedule in or cancel the order. (See Note)



Control Details	Cancel	Finally Close	Freeze	Hold	Firm
Encumbrance Effect	Outstanding encumbrance reversed as a negative DR (Period End: lesser of unbilled, undelivered. Accrue on Receipt: undelivered.)	Outstanding encumbrance reversed as CR (Period End: unbilled. Accrue on Receipt: undelivered.)	No effect	No effect	No effect
Associated Requisitions	Determined by Purchasing Options: Never, Always, Optional	Not returned to req pool; must manually final close or cancel associated req	No effect	No effect	No effect
Transportation Integration	Cancelled quantity is no longer available for transportation planning	Finally closed quantity is no longer available for transportation planning	No effect	On hold quantity is no longer available for transportation planning	No effect

**Note:** Within the time fence created by a Firm order, MRP will not suggest new planned orders, cancellations, or reschedule-in actions; but it will suggest reschedule-out actions.

## Document Control Applicability Matrix

The Document Control Applicability matrix describes which control actions are valid for each document type and entity.

<b>Current Document Type</b>	<b>Cancel</b>	<b>Finally Close</b>	<b>Close</b>	<b>Close for Invoice</b>	<b>Close for Receipt</b>	<b>Freeze</b>	<b>Hold</b>	<b>Firm</b>
Planned PO Header	X	X	X	X	X	X	X	X
Planned PO Line	X	X	X	X	X			
Planned PO Shipment	X	X	X	X	X			X
Standard PO Header	X	X	X	X	X	X	X	X
Standard PO Line	X	X	X	X	X			
Standard PO Shipment	X	X	X	X	X			X
Blanket Agreement Header	X	X	X			X	X	X
Blanket Agreement Line	X	X	X					
Contract Agreement Header	X	X	X			X	X	

<b>Current Document Type</b>	<b>Cancel</b>	<b>Finally Close</b>	<b>Close</b>	<b>Close for Invoice</b>	<b>Close for Receipt</b>	<b>Freeze</b>	<b>Hold</b>	<b>Firm</b>
Release Header	X	X	X			X	X	X
Release Shipment	X	X	X	X	X			X
Requisition Header	X	X						
Requisition Line	X	X						

## Document Control Status Check Matrix

Purchasing performs a status check on all documents when you choose a control action. This check verifies that the document is in a valid state to perform the selected control action. If your document fails the status check, Purchasing provides an error message in the window in which you are working.

The following matrix describes the valid actions for each possible document state. Generally, Purchasing restricts the list of available actions based on document status, so you should rarely encounter problems in the status check.

<b>Current Document Status</b>	<b>Cancel</b>	<b>Finally Close</b>	<b>Close</b>	<b>Open</b>	<b>Close for Invoice</b>	<b>Close for Receipt</b>	<b>Freeze</b>	<b>Hold</b>
Incomplete								X
In Process								X
Approved	X	X	X		X	X	X	X

Current Document Status	Cancel	Finally Close	Close	Open	Close for Invoice	Close for Receipt	Freeze	Hold
Pre-Approved								X
Rejected	X							X
Returned	X							
Requires Reapproval								X
On Hold								
Frozen	X	X	X	X	X	X		
Cancelled		X						
Finally Closed								
Reserved	X	X	X		X	X	X	X
Open	X	X	X		X	X	X	X
Closed		X		X			X	X
Closed for Invoicing	X	X	X	X		X	X	X
Closed for Receiving	X	X	X	X	X		X	X

## Document Control Submission Check Matrix

Purchasing performs a submission check on each document for which you choose a Cancel or Finally Close control action. The submission check verifies that the document satisfies specific conditions for these control actions. For example, if you try to cancel a blanket purchase agreement, the submission check verifies that all releases associated with this agreement have been cancelled or final closed. If your document fails any of the submission check rules, Purchasing opens the View Online Report window where you can review the cause(s) of failure.

The following matrix describes the submission checks that Purchasing performs for each document type.

<b>CANCEL</b>	<b>Standard</b>	<b>Planned</b>	<b>Blanket</b>	<b>Contract</b>	<b>Release</b>	<b>Requisition</b>
	X				X	
Shipment quantity received must be less than quantity ordered		X			X	
Shipment quantity billed must be less than quantity ordered			X			
Shipment quantity billed must be less than quantity received if receipt is required.	X				X	

<b>CANCEL</b>	<b>Standard</b>	<b>Planned</b>	<b>Blanket</b>	<b>Contract</b>	<b>Release</b>	<b>Requisition</b>
Distribution quantity delivered must be less than or equal to quantity ordered	X				X	
Distribution quantity billed must be less than or equal to quantity ordered	X				X	
Distribution quantity billed must be less than or equal to quantity received if receipt is required.	X				X	
Delivery quantity must equal receipt quantity for all receipts	X				X	
Cancel date must be within accounting distribution effectivity dates	X	X			X	X

<b>CANCEL</b>	<b>Standard</b>	<b>Planned</b>	<b>Blanket</b>	<b>Contract</b>	<b>Release</b>	<b>Requisition</b>
All associated releases must be cancelled or final closed		X	X			
All accounting flexfields must be valid	X	X			X	X
No pending receiving transactions.	X				X	
No unreceived ASNs.	X				X	
All lines referencing the agreement must be cancelled or finally closed.			X	X		
Corresponding sales order line must be closed						X

<b>CANCEL</b>	<b>Standard</b>	<b>Planned</b>	<b>Blanket</b>	<b>Contract</b>	<b>Release</b>	<b>Requisition</b>
Procurement Services: Timecards (approved, working, or rejected) must NOT exist.	X					

<b>FINALLY CLOSE</b>	<b>Standard</b>	<b>Planned</b>	<b>Blanket</b>	<b>Contract</b>	<b>Release</b>	<b>Requisition</b>
Delivery quantity must equal receipt quantity for all receipts	X				X	
Cancel date must be within accounting distribution effectivity dates	X	X			X	X
All associated releases must be cancelled or final closed		X	X			
All accounting flexfields must be valid	X	X			X	X



<b>FINALLY CLOSE</b>	<b>Standard</b>	<b>Planned</b>	<b>Blanket</b>	<b>Contract</b>	<b>Release</b>	<b>Requisition</b>
No pending receiving transactions.	X				X	
No unreceived ASNs.	X				X	
All lines referencing the agreement must be cancelled or finally closed.			X	X		
Corresponding sales order line must be closed						X
Procurement Services: Timecards (approved, working, or rejected) must NOT exist.	X					

## Controlling Documents

Use the Control Documents window to control requisitions and requisition lines as well as purchase orders, purchase order lines, releases, and shipments. For requisitions, the only available actions are Cancel and Finally Close. Only control options appropriate for the selected requisition or purchase order are displayed in the Actions field. The following control actions are available in this window:

- *Cancel* - If you use on-line requisitions, and you cancel a purchase order you did not receive or pay at all, Purchasing cancels the requisition lines associated with the purchase order if the Cancel Requisitions check box is selected. If the Cancel Requisitions check box is not selected, the requisition lines are not cancelled and are returned to the pool of available requisitions. You can then assign these requisition lines to new purchase orders to fulfill your requestors' needs. See: Defining Control Options, page 1-34.

If you use on-line requisitions with quantity or amount based line types, and you cancel a *partially* received purchase order line, Purchasing recreates requisition lines for the remainder of the maximum of the billed or received quantity you have not received. You can assign these requisition lines to a new purchase order line to fulfill the requestor's needs. See: Autocreate Document Options, page 6-3. If you have implemented Oracle Services Procurement and use on-line requisitions with rate or fixed price line types, no requisition lines are recreated.

If you are using encumbrance or budgetary control, Purchasing automatically creates negative debit entries in your general ledger system to cancel the encumbrance that corresponds to the purchase order header, lines, or shipments you are cancelling, using the action date you specify in Action Date. Purchasing recreates requisition encumbrances for the requisition lines you used to create the purchase order if the Cancel Requisitions check box is not selected. Purchasing uses the distributions from your cancelled purchase order to recreate the encumbrance for your requisition. See: Budgetary Control and Online Funds Checking, *Oracle General Ledger User's Guide*.

After you partially or completely cancel a purchase order, you need to inform your supplier of the cancellation. You can communicate purchase orders or releases you partially or completely cancelled. Purchasing automatically inserts a cancellation message on the purchase order, purchase order line, purchase order shipment, or release you cancelled.

You can source a requisition line from a line in the Prior Purchases region of the Supplier Item Catalog window. (A line in the Prior Purchases region corresponds to a purchase order line.) However, Purchasing does not automatically update the corresponding sourcing information if you cancel a blanket agreement or agreement line with which you source requisition lines. If you cancel a blanket agreement or agreement line, be sure to update the corresponding information in the Requisition Templates or the Sourcing Rules window. See: Defining Requisition Templates, page 1-46. See: Automatic Sourcing, page 5-24.

- *Close* - You can close at the header, release, line, and shipment levels.
- *Close for Invoicing* - You can close for invoicing at the header, release, line, and shipment levels. Note that if you close for invoicing a purchase order header that is currently open, Purchasing sets the status of all purchase order shipments to Closed for Invoicing, but the purchase order lines and header remain open. This status will not prevent you from matching an invoice to the purchase order or to the receipt.

- *Close for Receiving* - You can close for receiving at the header, release, line, and shipment levels. Note that if you close for receiving a purchase order header that is currently open, Purchasing sets the status of all purchase order shipments to Closed for Receiving, but the purchase order lines and header remain open.
- *Finally Close* - You can final close at the header, release, line, and shipment levels. Purchasing automatically closes fully billed and received purchase orders. However, to prevent further actions on the purchase order, you should use this window to final close purchase orders. Finally Close prevents modifications to the purchase order. Also, if you are using encumbrance or budgetary control, Finally Close automatically creates credit encumbrance journal entries in your general ledger system to reverse the encumbrance that corresponds to the purchase order header, lines, or shipments you are closing, using the action date you specify in Action Date. See: Budgetary Control and Online Funds Checking, *Oracle General Ledger User's Guide*.
- *Freeze* - You can freeze only at the header and release level. You freeze a purchase order when you want to prevent any future modifications to the purchase order. When you freeze a purchase order, you can still receive and pay for goods you already ordered. If you want to prevent future receipt or matching invoices against this purchase order, cancel or final close the purchase order instead.

If you use a Requisition template or source requisition lines from a purchase order line, Purchasing does not automatically update the corresponding sourcing information when you freeze a purchase order with which you source requisition lines. If you freeze a purchase order, be sure to update the corresponding information in the Requisition Templates or the Sourcing Rules window. See: Defining Requisition Templates, page 1-46. See: Automatic Sourcing, page 5-24.

- *On Hold* - You can place a purchase order on hold only at the header level. This unapproves the purchase order while preventing printing, receiving, invoicing, and future approval until you remove the hold.
- *Open* - You can open at the header, line, and shipment levels.
- *Open for Invoicing* - You can reopen for invoicing at the header, line, and shipment level.
- *Open for Receiving* - You can reopen for receiving at the header, line, and shipment level.
- *Release Hold* - You can release a hold only at the header level.
- *Unfreeze* - You can unfreeze only at the header and release levels.

### To control documents:

1. Navigate to the Control Document window by selecting Control from the Tools menu in the Requisition Headers Summary and Requisition Lines Summary windows. For purchase orders, you can navigate to the Control Document window from the summary windows titled Purchase Order Headers, Purchase Order Lines, and Purchase Order Shipments.

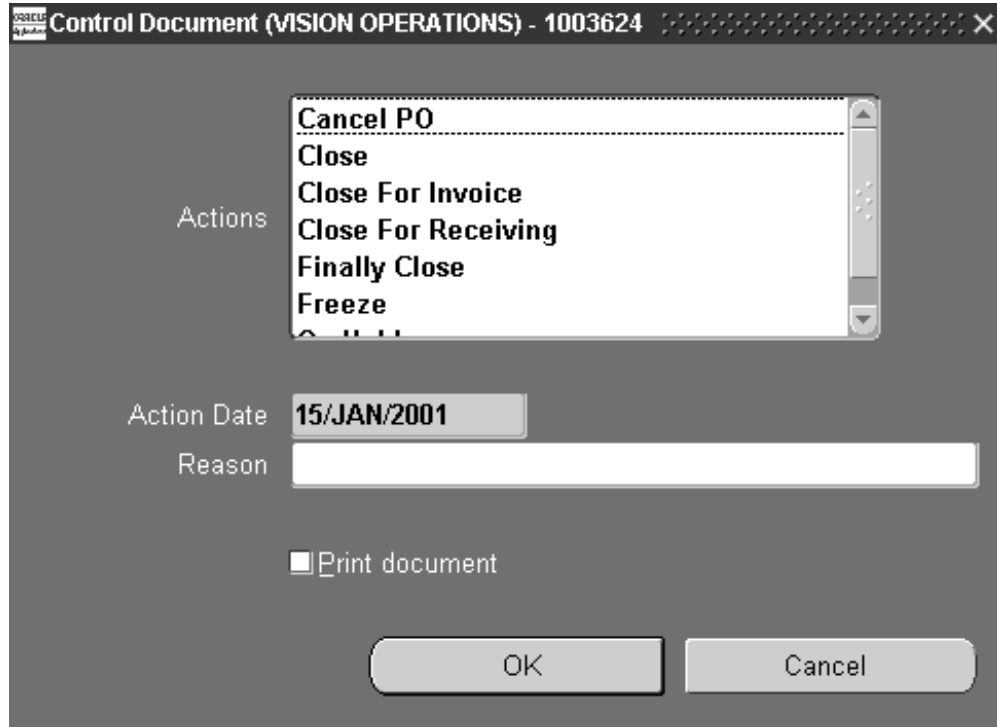

2. Select the control Action.
3. If you selected the Cancel action, you can update the Action Date.  
**Note:** If you are using encumbrance or budgetary control, make sure the action date you specify lies in an open period.
4. If you are using encumbrance or budgetary control, enter the GL Date for funds reversal related to your action.
5. The Cancel Requisitions check box appears only when you have selected the Cancel action for a purchase order. The operation of the check box is governed by the Cancel Requisitions flag in the Purchasing Options window. If this flag is set to Never, the check box does not appear. If this flag is set to Always, the check box appears checked when you select the Cancel action, but you cannot update the

check box. If this flag is set to Optional, the check box appears unchecked when you select the Cancel action, and you can update it. If the check box is checked, requisition lines associated with the cancelled purchase order header, line, shipment, or release are cancelled. If the check box is unchecked, requisition lines associated with the cancelled purchase order header, line, shipment, or release are not cancelled and are returned to the requisition pool. See: Defining Control Options, page 1-34.

6. If you are using encumbrance or budgetary control, select Use Document GL Date to Unreserve. This selection uses the document's distribution GL dates for the funds reversal instead of the unreserve date.
7. Optionally enter a Reason for the action.
8. If you are cancelling a purchase order, you can enter a Note to Supplier.
9. If you are cancelling a purchase order, you can communicate the the purchase order to the supplier. See: Document Transmission Methods, page 2-36.

**To cancel control actions:**

1. Select the Cancel button to cancel your actions and return to the previous window.

## Related Topics

Document Control Options, page 2-41

## MassCancel

### Defining MassCancel

Use the Define Mass Cancel window to specify criteria for cancelling groups of requisitions or purchase orders that you no longer want to honor.

You can specify a range of Accounting Flexfields for which to cancel requisitions or purchase orders. You can use this zone to specify a range of accounts, programs, projects, or funds, or one account, program, project, or fund for which to cancel purchase orders or requisitions. Purchasing selects for cancellation all purchase orders or requisitions that meet your other selection criteria and have distributions falling completely or partially within these ranges.

You can define multiple ranges of Accounting Flexfields, each including both a low and high value for each key segment. Purchasing excludes all values outside the specified ranges.

When you enter the Include Low field, Purchasing displays a pop-up window that contains a prompt for each segment you have defined for your Accounting Flexfield.

You enter both the low and high ends of each range in this pop-up window. After you finish entering each range, Purchasing displays your low segment values in concatenated form in the Low field and displays your high segment values, similarly, in the High field.

Note that Purchasing does not perform checking for incompatible ranges, so you must take care to insure that your High value is actually higher than your Low value. Otherwise, no documents will be selected for MassCancel.

After you specify your cancellation criteria, Purchasing selects all purchase orders or requisitions meeting your cancellation criteria and automatically prints the Define MassCancel Listing. This report lists requisitions and purchase orders that are not cancellable, that fall partially within your cancellation criteria, and that fully meet your cancellation criteria. You can cancel purchase orders or requisitions in the latter two categories using the Run MassCancel window.

#### **To define cancellation criteria**

1. Navigate to the Define MassCancel window from the menu.

Define MassCancel

Operating Unit: Vision Operations

Batch Name: [ ]

Document Type: [ ] Requisition Type: [ ]

Cancel Backing Requisition Lines

Creation Date: [ ] - [ ]

Supplier: [ ]

Include Rules

Low	High
[ ]	[ ]
[ ]	[ ]
[ ]	[ ]
[ ]	[ ]
[ ]	[ ]
[ ]	[ ]
[ ]	[ ]

Create Batch

2. Select the Operating Unit for this MassCancel Batch.
3. Enter the MassCancel Batch Name. Purchasing displays this name in the Run MassCancel window, where you can choose the batch for cancellation.
4. Choose one of the following Options:
  - *Requisition* - Use this option to submit MassCancel for Requisitions.
  - *Purchase Order* - Use this option to submit MassCancel for planned and standard purchase orders, and blanket purchase agreements.
5. Select Cancel Backing Requisition Lines to indicate that you want to cancel the backing requisition lines when you cancel a purchase order. The cursor enters this field only when you choose the Purchase Order option in this window and then only when the Cancel Requisitions option in the Purchasing Options window is set to Optional. In this case, the default is to disable the check box, but you can change it. You *cannot* disable this option when the Cancel Requisitions option is Always or enable this option when the Cancel Requisitions option is Never. See: Defining Control Options, page 1-34.

If you set the Cancel Backing Requisition Lines option to Never, when you complete your MassCancel for purchase orders Purchasing recreates the requisition

(and requisition encumbrance if you use requisition encumbrance or requisition budgetary control) from which you created your purchase order. *Therefore, you should define and run MassCancel for all your purchase orders before you define and run MassCancel for your requisitions.*

6. Enter the Start Date and End Date you want Purchasing to use to choose requisitions or purchase orders for cancellation. The creation date is the date you created your requisitions or purchase orders. Purchasing selects requisitions or purchase orders for cancellation that have creation dates between the start date and end date you specify here.
7. For requisitions only, enter the Requisition Type: Internal or Purchase.
8. Enter the Supplier Name for which you want Purchasing to choose purchase orders for MassCancel. If you specify a supplier name, Purchasing selects for cancellation all purchase orders for this supplier that also fit your other cancellation criteria. If you do not specify a supplier name, Purchasing selects all purchase orders that meet your other selection criteria. You cannot specify a supplier name if you are cancelling requisitions.
9. Enter the Low and High values of your MassCancel rule range. Neither value has to be a valid Accounting Flexfield value nor does it have to be made up of valid key segment values.

You must enter a Low and High value. If you want to cancel all documents in a specific range or for a specific supplier, regardless of the account, enter the lowest and highest possible account values. The lowest and highest possible values in a range are operating system dependent. The lowest possible value is either the number 0 or the character A. If the lowest value on your computer is the number 0, then the highest possible value is the character Z. If the lowest value on your computer is the character A, then the highest possible value is the number 0. You must determine which combination is correct for your computer. If you enter the incorrect combination of lowest to highest, Purchasing displays an error message so you know your computer accepts the other lowest to highest range combination. Note that ZZ is a higher value than Z. If you want to specify a single value to include, enter the same value in both the Low and High fields.

**Example**

You want to cancel all purchase orders you charge to project 305. You define your Accounting Flexfield as Fund - Account - Organization - Project. Your computer uses 0 as the lowest value. You specify the Include Low value as 00-0000-000-305 and Include High as ZZ-ZZZZ-ZZZ-305. Note that if none of the Accounting Flexfield segments are required, you can have a range of all null (empty) segments, which in effect means that all accounts are included in the range.

Overview of Encumbrance Accounting, *Oracle General Ledger User's Guide*

Define MassCancel Listing, page 2-65



## Define MassCancel Listing

Use the Define MassCancel Listing to review purchase orders and requisitions you have selected for cancellation using the Define MassCancel form. Purchasing prints this report automatically after you define your purchase order or requisition cancellation criteria in the Define MassCancel window and save your work. The report is in four sections: Unable to Cancel Requisitions, Unable to Cancel Purchase Orders, Partially in Range Documents, and Fully in Range Documents.

The Unable to Cancel Requisitions and Unable to Cancel Purchase Orders sections print documents which fit your selection criteria, but which are not cancellable by MassCancel for a reason that the report provides.

Purchasing displays one of the following reasons why you cannot cancel a requisition:

---

**Included in PO**

You have matched at least one line of your requisition to a purchase order. Therefore, you cannot cancel the entire requisition.

**One or more POs are created based on this REQ**

You have one or more purchase orders that have been created based on this requisition. Therefore, you cannot cancel the requisition.

**REQ is either incomplete, cancelled, or final closed**

The requisition is either incomplete, cancelled, or final closed. Therefore you cannot cancel the requisition.

---

Purchasing displays one of the following reasons why you cannot cancel a purchase order:

---

**Line Overbilled**

You have been billed for more goods or services than you ordered on at least one distribution of your purchase order.

If you required receipt, you have been billed for more goods or services than you have recorded deliveries for at least one distribution of your purchase order. Therefore, you cannot cancel the purchase order in its entirety.

---

---

<b>Line Overdelivered</b>	You have recorded deliveries in excess of goods or services ordered for at least one distribution of this purchase order. Therefore, you cannot cancel the purchase order in its entirety.
<b>Invalid Accounting Flexfield</b>	<p>One of the Accounting Flexfields you use for a purchase order distribution has expired. Therefore, you cannot create a journal entry using this Accounting Flexfield. You need to reactivate the Accounting Flexfield if you wish to cancel this line.</p> <p>Purchasing prints this Cannot Cancel Reason only if you are using encumbrance or budgetary control for purchase orders.</p>
<b>Shipment Fully Received</b>	You have received all the goods or services you ordered for at least one shipment of your purchase order. Therefore, you cannot cancel this purchase order in its entirety.
<b>Shipment Fully Billed</b>	<p>You have been billed for all the goods or services for at least one of your shipments for this purchase order. Therefore, you cannot cancel this purchase order in its entirety.</p> <p>If you have been billed for goods or services in <i>excess</i> of the quantity ordered, Purchasing prints Line Overbilled as the Cannot Cancel Reason.</p>
<b>Shipment Received But Not Delivered</b>	You have recorded receipts for some goods or services on at least one shipment for this purchase order. You have not recorded delivery of at least one of these items. Since you have received goods for this purchase order, you cannot cancel it in its entirety.
<b>Included in Invoice</b>	You have been billed for at least one item of your purchase order. Therefore, you cannot cancel the entire purchase order. Purchasing prints this Cannot Cancel Reason only if you are using encumbrance or budgetary control for purchase orders.

---

The Partially in Range Documents section prints purchase orders or requisitions having distributions which fall partially in the range of Accounting Flexfields you selected for

cancellation. Column headings provide you with descriptions of the contents of each column.

The Fully in Range section prints purchase orders or requisitions which meet all your selection criteria, and whose distributions fall completely within the range of Accounting Flexfields you selected for cancellation. Column headings provide you with descriptions of the contents of each column.

After you review the Define MassCancel Listing, you can complete the MassCancel process using the Run MassCancel window. You can cancel only purchase orders or requisitions which are Fully in Range or Partially in Range.

## Report Submission

Since this report is automatically submitted, it is not available in the Submit Requests window.

## Running MassCancel

Use the Run MassCancel window to cancel a group of purchase orders or requisitions you have selected for cancellation, usually as part of your year-end processing. When you cancel purchase orders or requisitions using this window, Purchasing reverses encumbrances associated with your requisitions or purchase orders. If you cancel a purchase order you created from a requisition, and you are using requisition encumbrance or requisition budgetary control, Purchasing allows you to recreate the requisition encumbrance using the distributions from your purchase order. *Therefore, if you are cancelling both requisitions and purchase orders as part of your year-end processing, you need to cancel purchase orders before you cancel requisitions.*

When you define your MassCancel criteria, you may select some purchase orders or requisitions for cancellation that Purchasing is unable to cancel for some reason. Purchasing does not display these purchase orders or requisitions in this window. However, you can review the Define MassCancel Listing for purchase orders or requisitions that are not cancellable, together with the reason why they are not cancellable. When the concurrent manager runs the MassCancel process, it checks all the purchase orders or requisitions for cancellability, using the same checks performed by the Define MassCancel window. The purchase orders or requisitions that cannot be cancelled are listed separately in the Run MassCancel Listing.

When you enter a batch name in this window, Purchasing displays the purchase orders or requisitions that can be cancelled. Cancel Backing Requisition Lines is checked if this option was selected for the batch in the Define MassCancel window. For each document, Purchasing displays the document Type (Requisition, Standard Purchase Order, Planned Purchase Order, or Blanket Purchase Agreement), document Number, Creation Date, and Supplier Name. Fully in Range is checked if all the distributions of this entry fall within all the Accounting Flexfield ranges you specify in the Define MassCancel window.

When you run MassCancel, Purchasing cancels all purchase orders or requisitions that

are selected. If you are using encumbrance or budgetary control, Purchasing creates reversal entries for your commitments and obligations (pre-encumbrances and encumbrances) when you cancel requisitions and purchase orders, respectively.

### Prerequisites

- Defining MassCancel, page 2-61
- Define MassCancel Listing, page 2-65

### To run MassCancel:

1. Navigate to the Run MassCancel window from the menu.
2. Enter the Batch Name of the MassCancel batch you want Purchasing to use for cancellation. See: Defining MassCancel, page 2-61.
3. If you are using budgetary control, enter the Cancel Date that you want Purchasing to use to create reversing encumbrance entries in your general ledger. Purchasing uses this date to reapply funds to a specific period. The date you enter must be in an open purchasing period.
4. Deselect each entry you do not want to cancel. If you save your work without running MassCancel, your selections are saved and are redisplayed the next time you query the batch.
5. Select the Run MassCancel button.

### To delete the MassCancel batch:

1. Select the Delete MassCancel Batch button to delete the selected MassCancel batch.

### Related Topics

Defining MassCancel, page 2-61

Define MassCancel Listing, page 2-65

Run MassCancel Listing, page 2-68

Overview of Encumbrance Accounting, *Oracle General Ledger User's Guide*

## Run MassCancel Listing

Use the Run MassCancel Listing to review purchase orders and requisitions you have cancelled or were unable to cancel using MassCancel. Purchasing prints this report automatically after you complete your Run MassCancel process. The listing is in three sections: Unable to Cancel Requisitions, Unable to Cancel Purchase Orders, and Cancelled Documents. The Unable to Cancel Requisitions and Unable to Cancel

Purchase Orders sections print documents which fit your selection criteria but which are not cancellable by MassCancel for another reason, which the report provides.

Purchasing prints one of the following reasons you cannot cancel a requisition:

---

<b>Included in Purchase Order</b>	You have matched at least one line of your requisition to a purchase order. Therefore, you cannot cancel the entire requisition.
<b>One or more POs are created based on this REQ</b>	You have one or more purchase orders that have been created based on this requisition. Therefore, you cannot cancel the requisition.
<b>REQ is either incomplete, cancelled, or final closed</b>	The requisition is either incomplete, cancelled, or final closed. Therefore you cannot cancel the requisition.

---

Purchasing prints one of the following reasons you cannot cancel a purchase order:

---

<b>Line Overbilled</b>	<p>You have been billed for more goods or services than you ordered on at least one distribution of your purchase order.</p> <p>If you required receipt, you have been billed for more goods or services than you have recorded deliveries for at least one distribution of your purchase order. Therefore, you cannot cancel the purchase order in its entirety.</p>
<b>Line Overdelivered</b>	You have recorded deliveries in excess of goods or services ordered for at least one distribution of this purchase order. Therefore, you cannot cancel the purchase order in its entirety.
<b>Invalid Accounting Flexfield</b>	<p>One of the Accounting Flexfields you use for a purchase order distribution has expired. Therefore, you cannot create a journal entry using this Accounting Flexfield. You need to reactivate the Accounting Flexfield if you wish to cancel this line.</p> <p>Purchasing prints this Cannot Cancel Reason only if you are using encumbrance or budgetary control.</p>

---

---

**Shipment Fully Received**

You have received all the goods or services you ordered for at least one shipment of your purchase order. Therefore, you cannot cancel this purchase order in its entirety.

**Shipment Fully Billed**

You have been billed for all the goods or services for at least one of your shipments for this purchase order. Therefore, you cannot cancel this purchase order in its entirety.

If you have been billed for goods or services in *excess* of the quantity ordered, Purchasing prints **Line Overbilled** as the Cannot Cancel Reason.

**Shipment Received But Not Delivered**

You have recorded receipts for some goods or services on at least one shipment for this purchase order. You have not recorded delivery of at least one of these items. Since you have received goods for this purchase order, you cannot cancel it in its entirety.

**Included in Invoice**

You have been billed for at least one item of your purchase order. Therefore, you cannot cancel the entire purchase order. Purchasing prints this Cannot Cancel Reason only if you are using encumbrance for purchase orders.

---

When you cancel purchase orders or requisitions and you are using encumbrance or budgetary control, Purchasing creates relieving encumbrance entries for your purchase orders or requisitions. See: Overview of Encumbrance Accounting, *Oracle General Ledger User's Guide*.

**Report Submission**

Since this report is automatically submitted, it is not available in the Submit Requests window.

**Related Topics**

Defining MassCancel, page 2-61

Running MassCancel, page 2-67

---

# Requisitions

## Overview of Requisitions

With online requisitions, you can centralize your purchasing department, source your requisitions with the best suppliers, and ensure that you obtain the appropriate management approval before creating purchase orders from requisitions. You can use Master Scheduling/MRP to generate online requisitions automatically based on the planning requirements of your manufacturing organization. See: *Overview of Implementing Planning Recommendations, Oracle Master Scheduling/MRP and Supply Chain Planning User's Guide*. You can use Inventory to generate online requisitions based on *replenishment* requirements. See: *Overview of Inventory Planning and Replenishment, Oracle Inventory User's Guide*. You can use Work in Process to generate online requisitions for outside processing requirements. See: *Overview of Outside Processing, Oracle Work in Process User's Guide*. Finally, you can use Purchasing to create internal requisitions, which are handled as internal sales orders and are sourced from your inventory rather than from outside suppliers like purchase requisitions. See: *Overview of Internal Requisitions, page 3-13*.

Purchasing provides you with the features you need to satisfy the following basic requisition needs. You should be able to:

- Create, edit, and review requisition information online. You should also be able to enter suggested supplier information, delivery instructions, multiple accounting distributions, and notes to buyers, approvers, and receivers.
- Review the current status and action history of your requisitions. You should always know who approves requisitions and whether they are in the approval, purchasing, receiving, or delivery stage.
- Route requisitions according to your approval structure. You should also be able to set authorization limits by amount, charge account, item category, and location.
- Review and approve requisitions that need your approval. You should also be able

to see the full requisition detail and review the action history before you approve a requisition.

- Print requisitions (with status Approved, Cancelled, Rejected, In Process, Pre-Approved, and Returned) for off-line review and approval. You should always be able to track the status of requisitions through the approval process.
- Import requisitions from other systems such as material or distributions requirement planning applications
- Perform online funds checking before creating requisitions. You should always know how your planned expenses compare to your budget.
- Automatically source requisitions from outstanding blanket purchase agreements, contract purchase agreements, or quotations you have made with suppliers
- Support flexible pricing rules
- Create requisitions quickly and easily for commonly purchased items
- Create internal requisitions that are sourced from your inventory by means of internal sales orders
- Provide attachments as notes on requisition headers and lines
- Assign requisition lines to buyers and review buyer assignments for requisition lines
- Forward all requisitions awaiting approval from one approver to an alternate approver. Within your security and approval constraints, you should be able to reroute requisitions from one approver to another whenever you want.
- Record suggested foreign currency information for each requisition line

## Major Features

### Eliminate Paper

With Purchasing, your requestors submit requisitions online. You therefore eliminate the need for paper requisitions that you can misplace or lose during the approval process.

### Quick Online Entry

With Purchasing, you can easily create requisitions online. Complete a requisition for any item by simply entering the requestor name, item description, delivery location,



price, delivery quantity, and accounting distribution. Purchasing uses the Account Generator to enter the distribution automatically whenever possible.

## **Approval Status**

Purchasing automatically displays the approval status of your requisition and informs you whether it is Approved, Cancelled, In Process, Incomplete, Pre-Approved, Rejected, or Returned. You know where your requisition is at all times.

## **Action History**

Purchasing lets you review the action history of requisitions as they move through the approval process. Purchasing uses your security and approval structure to help you forward requisitions. On-line notifications keep your requisitions moving. If someone rejects a requisition, you always know who and why.

## **Easy Resubmission**

Purchasing lets you resubmit a rejected requisition for reconsideration. Depending on how you define system setup options, resubmitted requisitions return either to the original approver for reconsideration or to an alternate approver that you choose.

## **Easy Cancellation / Final Close**

Purchasing lets you cancel or final close a requisition or requisition line before your manager approves it or before a buyer places it on a purchase order.

If you are using encumbrance or budgetary control, Purchasing automatically creates negative debit encumbrance entries for the cancelled requisitions. When you final close a purchase order, Purchasing creates credit entries which reverse the encumbrances.

## **Easy Assignment**

Purchasing lets you assign requisitions to specific buyers and review which requisitions are Assigned and Unassigned.

## **Accurate Accounting**

Purchasing uses the Account Generator to automatically supply accounting information as part of a requisition. You can allocate line item quantities to cost centers, organizations, projects, or departments. You can also create multiple distributions for a single item. For instance, you can allocate a computer system purchase across more than one cost center or organization

## Maximum Flexibility

Purchasing provides maximum flexibility by letting requestors create requisitions quickly and add details later. In the requisition header and on each line item, Purchasing provides space for descriptions and notes to approvers, buyers, and receivers.

## Quick Customization

Purchasing lets you use Descriptive Flexfields to tailor the format of the requisition header and line blocks to your unique needs without additional programming.

## Online Funds Availability Checking

Purchasing lets you verify whether you have enough funds available in your budget before you complete a requisition. You can check and reserve funds for a requisition at any level of a requisition.

## Online Approvals

Purchasing lets you approve or reject requisitions online. You can access full requisition detail and prior action history to review the full detail before making an approval decision. Depending on your approval controls, you may be able to update a requisition before you approve it.

## Requisition Templates

This feature, accessible through the Supplier Item Catalog, lets you quickly create requisitions for commonly purchased items. Buyers create templates that group commonly ordered items like office supplies into one place.

## Quantity Rounding

If Quantity Rounding for inventory sourced lines is enabled in the Purchasing Options window, Purchasing either displays the rounded quantity you should have entered in a warning message or it updates the quantity to the appropriate rounded quantity. The rounding is based on the Unit of Issue (or primary unit of measure if the Unit of Issue is not defined) and the Rounding Factor defined for the item in Inventory. Rounding is up or down to the nearest whole Unit of Issue/primary unit of measure using the rounding factor.

## Flexible Pricing

Pricing for your items can default in from the item definition or from negotiated documents. If your pricing is complex you can define your pricing rules using the

Oracle Advanced Pricing engine. To price requisitions and purchase orders based on pricing rules setup in Oracle Advanced Pricing, the requisition line need simply reference a contract purchase agreement. See: *Oracle Advanced Pricing User's Guide*.

## Requisition Printing

Purchasing provides a requisition printing capability to provide hard copy requisitions. You can print requisitions after completing them, or have somebody print and distribute all requisitions. Use the Printed Requisitions Report to print the requisitions which have the following status: Approved, Cancelled, Rejected, In Process, Pre-Approved, and Returned. The report does not include requisitions with status Incomplete.

## Quick Access to Particular Requisitions

You can place requisitions that you reference frequently in the Oracle Applications Navigator. Placing documents in the Navigator is useful when you need to query large documents with multiple lines, shipments, or distributions. When the requisition is open, choose Place on Navigator from the File menu. When you choose the Documents tabbed region in the Navigator, you can then access that document directly from within the Navigator. You can also do this with purchase orders. See: Using the Navigator's Documents Region, *Oracle Applications User's Guide*.

**Note:** Once you place a document in the Navigator, it is the first thing you see in the Navigator the next time you log into Purchasing. Choose Functions to return to the Purchasing menu.

## Requisition Import

Using Requisition Import, you can import requisitions from other Oracle Applications or from non-Oracle systems. Requisition Import lets you integrate Purchasing with new or existing applications such as Material or Distribution Requirement Planning systems. You can import requisitions as often as you want. Then, you can review or place these requisitions on purchase orders. See: Requisition Import Process, page 13-29

Master Scheduling/MRP, Work In Process, Order Management, and Inventory all provide requisition information to the requisition interface table from which Requisition Import creates requisitions. While requisitions can be imported with any approval status, they are most commonly approved since they correspond to specific production schedules, outside processing, or stock resupply. However, if you are using requisition encumbrance, Requisition Import changes the Approved status to Pre-Approved so that you can reserve funds for the requisition.

## Requisitions within Center-Led Procurement

Requesters can create requisitions that are sourced to global agreements (global enabled

blanket purchase agreements or contract purchase agreements). This is of particular benefit to large organizations in which management wants other business units to use pricing or terms negotiated by a business unit. This in turn increases the bargaining power of the negotiating business unit with their supplier as they are negotiating on behalf of multiple business units.

To take advantage of these global agreements the buyer in the negotiating operating unit must enable the other operating units that are to use the global agreement. See: *Entering Purchase Agreement Information*, page 4-55.

## Requisition Types

### Benefits of Online Requisitions

You can save time, money, and paper by processing requisitions online. With a paper system, you must provide forms to the requestor, the requestor must send the form to someone else to be approved, and the buyer must manually consolidate requisitions to place on a purchase order. Throughout all of these transactions, you may generate a number of errors, waste time, and lose money. Some of the many problems you may incur with paper requisitions include:

- The requestor may not fill in the requisition completely or accurately.
- The requestor's handwriting may be illegible.
- Someone without proper authority can potentially approve a requisition.
- The requestor might have to mail the requisition to an approver at a different location and wait a number of days to get it back.
- The approver or buyer may lose or damage the requisition.
- The buyer may translate the information from the requisition to the purchase order incorrectly.
- You may lose significant quantity discounts if the buyer cannot locate all the requisitions that reference a particular item.

Purchasing helps you eliminate these problems with online requisition processing. When you create a requisition online, you can instantaneously send it to an approver. The approver can access your requisition from any computer and provide a note, change the requisition, and reserve funds if necessary. You also set controls to ensure that only the appropriate people can approve a particular requisition. After approval, inventory sourced lines on the requisition are handled as internal sales orders. For supplier sourced lines, the buyer can then consolidate all similar requests onto a single purchase order to negotiate the best price. Through all of these transactions, you never have to use any paper. By processing requisitions online, you significantly reduce the length of the purchasing cycle. You can also provide requisition line defaults for both

supplier and internally sourced lines to speed up requisition entry and automatically source items to improve buyer efficiency. At any point, the requestor can review the requisition online to check the status of the requisition.

## **Implementing Online Requisitions**

Many companies want to provide online requisitions to everyone in the company. Others want to limit the number of users who have access to the system. Purchasing is flexible enough to meet the needs of your company. To give everyone access to the system, simply create a user name for each employee in the company and assign the employee the appropriate responsibilities. You can easily designate a smaller group of individuals as requisition preparers if you want to limit the number of requestors on the system. These people can create requisitions for anyone in the company by identifying the appropriate requestor directly on the requisition line. You might also want to limit some preparers to internal requisitions and others to purchase requisitions. You can also print requisitions to obtain signature approvals if some of the approvers do not have access to the system. You can then assign an individual to update the authorization status for these requisitions.

## **Purchase Requisitions**

Use the Requisitions window to create requisitions. You must choose the requisition type (internal or purchase). You can also provide a description, unlimited notes, and defaults for requisition lines. For each requisition line, you choose the item you want to order along with the quantity and delivery location. You can get sourced pricing from catalog quotations or open blanket purchase agreements. You can also choose a price from a list of historical purchase order prices. In the Distributions window, you can charge the item to the appropriate accounts, or you can let the Account Generator create the accounts for you. Once you complete the requisition, you send it through the approval process. See: *Entering Requisition Lines*, page 3-51. See: *Using the Account Generator in Oracle Purchasing*, page E-6.

## **Internal Requisitions**

Unlike purchase requisitions, which are supplied from purchase orders, internal requisitions are supplied from internal sales orders. Internal requisitions are not picked up when you AutoCreate RFQs or purchase orders, nor can they be assigned to a buyer in the Assign Requisitions window. See: *Internal Requisitions Overview*, page 3-13.

## **Requisition Templates**

Use the Requisition Templates window to define requisition templates for items you purchase frequently. For example, if you frequently buy certain office supplies, you can set up an office supplies template for your requestors. This template consists of a list of all items, prices, and sourcing information you want available to the requestor. When you want to order items from this template, use the Supplier Item Catalog, choose the office supplies template, and indicate the quantity you want to order. Purchasing

supplies default sourcing and delivery information. See: Defining Requisition Templates, page 1-46.

## Imported Requisitions

Purchasing lets you import or reschedule requisitions from other Oracle or non-Oracle systems. See: Requisition Import Process, page 13-29. For example, Work in Process uses Requisition Import to create requisitions for outside processing. See: Overview of Outside Processing, *Oracle Work in Process User's Guide*. Similarly, Master Scheduling/MRP automatically creates requisitions using Requisition Import when you mass load purchase requisitions. Master Scheduling/MRP also automatically reschedules existing requisitions by updating the need-by date during this process. See: Overview of Implementing Planning Recommendations, *Oracle Master Scheduling/MRP and Supply Chain Planning User's Guide*. If you are using Inventory, you can send a requisition requirement to Purchasing and then run Requisition Import in Purchasing to create the requisition. See: Overview of Inventory Planning and Replenishment, *Oracle Inventory User's Guide*.

## Paper Requisitions

You do not need to create a requisition online to purchase an item. Instead, you can reference a paper requisition number directly on the purchase order Distribution Details. See: Entering Purchase Order Distributions, page 4-75. Later, you can use the Purchase Orders window to review the status of the purchase orders referencing the paper requisitions.

## Reserving Funds for Requisitions

Purchasing lets you reserve or encumber funds for requisitions which are not sourced to an encumbered blanket purchase agreement (or global agreement). If you are using budgetary control, you can also check to see whether funds are available before you encumber the requisition. If you have problems reserving funds for a requisition, the Approval Errors window lets you review the reasons.

Purchasing automatically transfers the encumbrance from the requisition to the purchase order when you successfully approve the purchase order on which you placed the requisition. Purchasing also automatically transfers the encumbrance back to the requisition when you cancel the purchase order. See: Overview of Encumbrance Accounting, *Oracle General Ledger User's Guide*.

**Note:** Even if someone with sufficient approval authority approves a requisition, its status may still be Pre-Approved if funds were not able to be reserved at the time of approval. A Pre-Approved requisition does not show up as supply until its status changes to Approved. Once funds are reserved for the Pre-Approved requisition, the requisition's status changes to Approved and shows up as supply.

## Reviewing Requisitions

After you create a requisition, you can query the requisition at any time to review the status, action history, or problems with encumbering funds. Use the Requisition Summary windows to review requisitions. If a buyer has already placed the requisition line onto a purchase order, you can review the purchase order number. You can also review the changes that the buyer made to the requisition and the quantity receivers have delivered. See: Finding Requisitions, page 3-36.

Use the View Action History window to review the action history of requisitions. You can navigate to this window from the Tools menu in many entry windows. You can see who has approved or rejected the requisition and the corresponding notes the approvers provided. For Inventory sourced lines, you can review the status of the internal sales order. See: Viewing Action History, page 10-1.

Use the Approval Errors window to review reasons you could not completely reserve funds for requisitions.

## Managing Requisitions

Purchasing lets you manage requisitions to help buyers save money and time when creating requisitions.

## Sourcing Requisitions

You can suggest buyer and supplier information when creating a requisition. Simply provide the appropriate information in the Source Details tabbed region of the Requisitions window. A buyer can then query all requisition lines based on this information to help consolidate purchase orders. Alternatively, you can automatically source requisition line items by using the Sourcing Rule and Approved Supplier List windows. You use the Approved Supplier List window to list the primary blanket purchase agreement, contract purchase agreement, or catalog quotation for each item you want to order. When you create a requisition line for any item that you list in the Sourcing Rule and Approved Supplier List windows, Purchasing automatically provides suggested supplier, buyer, and source document information for you. See: Automatic Sourcing, page 5-24. See: Approved Supplier List, page 5-35. Purchasing also automatically provides the sourcing information if you use Requisition Import to import requisitions from an outside system. See: Requisition Import Process, page 13-29.

## Assigning Requisitions to a Buyer

Purchasing lets you manage the buyers' workload by reviewing how many requisition lines are assigned to a particular buyer and reassigning them to distribute the workload better. You can also review how many unassigned requisitions are urgent or are needed within a certain time limit so that you can assign them to the appropriate buyers for immediate ordering. See: Finding Requisition Lines for Review or Assignment, page 5-

## Returning Requisitions

A buyer can return a requisition line to the original preparer instead of placing it onto a purchase order. Upon returning the requisition line, the buyer indicates the reason for the return. For example, the purchase price may exceed the requisition price, or the buyer may know that the requested item is no longer being purchased. When a buyer returns an individual requisition line, Purchasing automatically returns all other lines on the same requisition that are not currently on a purchase order. Purchasing returns the other lines to let the preparer decide whether it is still appropriate to order the rest of the requisition as is. See: Autocreate Purchase Order Options, page 6-3.

If you are using encumbrance and budgetary control and the requisition is not sourced to an encumbered blanket purchase agreement, Oracle Purchasing automatically creates negative debit encumbrance journal entries in your general ledger system to reverse the encumbrance that corresponds to the requisition you are returning.

## Referencing Requisition Reports

You can use the Buyer's Requisition Action Required Report to review all current requisition lines that are not currently on a purchase order. You can choose from a number of report setup options to narrow the search to a particular list of approved requisition lines. You can also print reports to review requisition status, requisition distribution detail, and requisition import status. See: Buyer's Requisition Action Required Report, page 11-9.

## Managing Foreign Currency Information

For new requisitions, the initial default is the functional currency specified in the Financials Options window. You can specify a different suggested foreign currency for each requisition line.

If you source to a foreign currency blanket purchase agreement, contract purchase agreement, or catalog quotation, Oracle Purchasing retrieves the foreign currency information for the document. Your user-defined preferences for currency are overridden by the currency information on the source document. This is also true even if the source document currency is blank (the same as the base currency).

Purchasing automatically updates the functional unit price if you enter the foreign currency unit price using the specified rate. Purchasing also updates the foreign currency price if you update the functional unit price.

When you AutoCreate new purchase orders, Purchasing converts the requisition price into a purchase order price based on specified currency and rate information. (See: Entering Currency Information, page 4-60.) You cannot specify currency information in AutoCreate if you are adding requisition lines to an existing document. See: Entering Document Information and Completing AutoCreate, page 6-15.

Purchasing performs price tolerance verification for all currencies and uses the



requisition total in functional currency to verify authorization limits.

## **Cancelling Requisitions**

With Purchasing, you can submit a requisition for approval and then cancel the requisition or a requisition line if you no longer want to order the item. Use the Control Documents window to cancel the entire requisition or specific requisition lines. Once a buyer places a purchase requisition line onto a purchase order, you can no longer cancel the requisition line or the corresponding requisition header. Similarly, you cannot cancel a requisition line that has been modified with the AutoCreate Documents window, or a line that is currently on a sales order. See: Controlling Documents, page 2-57.

If you cancel an internal sales order or back order that was generated by an internal requisition, you get a warning message that the order line is related to a requisition line that is now awaiting cancellation. At this point, you can navigate to the Control Documents window and explicitly cancel the requisition line. Alternatively, you can continue processing sales orders and later use the MassCancel function to cancel any or all requisition lines awaiting cancellation. See: Defining MassCancel, page 2-61.

When you cancel an internal requisition related to a cancelled sales order, the quantity cancelled on the requisition is the same as the quantity cancelled on the sales order, not the remainder of the requisition. This is because a quantity of goods may have been shipped but not yet delivered against the requisition. See: Controlling Documents, page 2-57.

If you are using encumbrance or budgetary control, Purchasing automatically creates negative debit encumbrance journal entries in your general ledger system to cancel the encumbrance that corresponds to the requisition header or lines you are cancelling (unless they were sourced to an encumbered blanket purchase agreement). See: Budgetary Control and Online Funds Checking, *Oracle General Ledger User's Guide*.

Requisitions that were imported from a drop shipped sales order can not be cancelled. These requisitions are automatically cancelled when the drop shipped sales order is cancelled.

## **Final Closing Requisitions**

Use the Control Documents window to final close requisitions and requisition lines when you no longer need the items. You cannot final close a requisition line a buyer placed on a purchase order, a line that has been modified with the AutoCreate Documents window, or a line that is currently on a sales order. Purchasing automatically creates credit encumbrance journal entries to reverse the encumbrance that corresponds to the requisition header or lines you are final closing (unless they were sourced to an encumbered blanket purchase agreement).

## Updating Requisitions

### Updating Incomplete Requisitions

As a requisition preparer, you can change the information on a requisition before you send it through the approval process. To update a requisition you created using the Requisitions window, simply navigate to the Find Requisitions window and query up the requisition. Once you send a requisition through the approval process, your access to it is determined by the security and approval structure.

You may also unreserve an incomplete requisition to reverse any encumbrances.

### Recreating Requisitions

When you cancel a purchase order line in the Control Documents window, you have the option to either have the referencing requisition lines cancelled or return them to the requisition pool for placement on another purchase order. If you have already partially received the item, Purchasing recreates the requisition line for the unreceived quantity. See: Controlling Documents, page 2-57.

### Using Modify to Update Requisitions

A buyer may want to alter a requisition line before placing it onto a purchase order. The buyer can either return the requisition line to the preparer for changes or simply choose Modify from the Tools menu while in the AutoCreate Documents window to update the requisition line. You can split the requisition into multiple lines so that you can source the requisition across different suppliers. Or, you can change the requisition line if the preparer did not request the item correctly. For example, the preparer might order a computer, though you know you buy computers by ordering the peripherals and keyboards separately. The preparer can later review the requisition to see the original requisition line and the changes the buyer made. See: Additional Autocreate Features, page 6-7.

You can not modify, split, or return a requisition line that references a drop shipped sales order.

### Updating Requisitions During Approval

Instead of approving a requisition, the approver can reject the requisition and send a note to the preparer to make specific changes. Alternatively, the approver can make changes directly to the requisition without rejecting it. From the Notifications Summary window or any of the requisitions summary windows, the approver can navigate to the Requisitions window and make the appropriate changes, if Approver Can Modify is enabled for the document type in the Document Types window. See: Viewing and Responding to Notifications, page 2-29.

## Overview of Internal Requisitions

Internal requisitions provide the mechanism for requesting and transferring material from inventory to other inventory or expense locations. When Purchasing, Order Management, Shipping Execution, and Inventory are installed, they combine to give you a flexible solution for your inter-organization and intra-organization requests. You should be able to:

- Set up your supply chain and automatically source your requirements from inventory or suppliers
- Define your inter-organization shipping network, and optionally require that you use internal orders for your inter-organization transfers
- Use intransit inventory when you want to track items as they move between organizations
- Reduce warehousing, shipping, and handling costs by requesting items in fixed lot sizes
- Use the same windows for data entry and inquiry that you use for purchase requisitions and sales orders
- Take advantage of standard requisition and sales order functionality to suit your individual business requirements
- Automatically generate inventory replenishment requisitions and fulfill them via internal or external suppliers
- Automatically source MRP generated requisitions to internal or external suppliers
- View the status of requests online
- Use internal requisitions to move inventory items from one inventory organization to another, even if that organization belongs to a different operating unit, legal entity, or ledger

## Major Features

### Complete Item Sourcing Definition

Purchasing and Inventory combine to provide the flexibility you need to define your item sourcing information. You can use the default sourcing options to automatically determine the correct source type and source for your requests. You can specify either Inventory or Supplier as the default source type, as well as the source organization and subinventory for internal requests.

## Inter-Organization Shipping Network

Inventory provides the features you need to define your inter-organization shipping network. For transfers between two organizations, you can specify whether to use intransit or direct shipments. You can also require internal orders for transfers between specific organizations.

## Flexible Processing

You can tailor internal requisition processing to fit your requirements. You can limit online interaction by setting up background processes to automatically perform specific actions such as creating inventory replenishment requests and creating internal sales orders in Order Management. Or, you can take advantage of other features such as online requisition approvals, internal sales order cycles, and online receipt and delivery of internally requested items.

## Creating Online Requisitions

You can create online internal requisitions for both expense and inventory destinations using the same windows you use to create purchase requisitions. You can combine inventory and supplier sourced requisition lines on the same requisition. Also, Purchasing uses your item sourcing information to default the correct source type and supplier for the item and destination. You can define requisition templates for commonly requested internally sourced items.

## Full Unit of Issue Enforcement

Purchasing offers the option of full unit of issue enforcement in which quantities entered on internal requisitions are automatically rounded to a full unit of issue defined for the item. You can also set this option to recommend a rounded quantity on requisitions, but leave the opportunity to change the recommended quantity. The quantity rounding is based on the specified unit of issue, if available, otherwise on the primary unit of measure.

## Inventory Replenishment Requisitions

Inventory generates replenishment requisitions through min-max planning, reorder point planning, subinventory replenishment for replenishment counts, and Kanban replenishment. Purchasing uses your item sourcing information to create inter-organization or subinventory transfer requests. See: Overview of Inventory Planning and Replenishment, *Oracle Inventory User's Guide*. See: Demand for Internal Requisitions, page 3-16.

## **MRP Generated Requisitions**

MRP generated requisitions are sourced using the same item sourcing information that you define for inventory replenishment and online requisitions. For "buy" items, the Requisition Import process uses the item sourcing information to create either a purchase requisition or an inter-organization internal requisition for planned orders.

## **Approvals and Controls**

You can control internal requisition approvals and document security just as you control purchase requisitions. Purchasing gives you the flexibility you need to set up approvals and limits for internal requests. You can use the same authorization rules, or you can relax or tighten controls for internal requisitions.

## **Creation of Internal Sales Orders**

When you approve an internal requisition for a stocked item, Purchasing translates the requisition into an internal sales order, providing a link between the end user's requirement and the physical demand against Inventory.

## **Order Management**

Once you create an internal sales order from a requisition, you can manage internal requisitions just as you manage regular sales orders. You can use Order Management to define order cycles, approvals and holds to effectively process requisition orders. You can selectively pick release and otherwise process internal sales orders as easily as you do regular sales orders.

## **Complete Requisitions Status Visibility**

You get complete visibility on the status of requests through inquiries and reports. You get online visibility to the internal sales order number, as well as the shipment and delivery status for requisitions. You can report on backordered items, internal requisition status, and delivery discrepancies.

## **Exception Processing**

Internal requisitions help you manage exceptions to your normal business flow. Order Management automatically backorders your request when you have insufficient supply to fill the internal order by creating another shipment line for the unavailable quantity. You can reschedule orders when the shipment date changes, and the expected arrival date on the intransit shipment is updated automatically.

## Cancellation of Requisitions

You can easily cancel a request if you have a change in requirements or if you cannot fulfill the entire order. Using Order Management, you can partially or fully cancel the line quantities on the internal sales order. You complete the cancellation process by cancelling the original requisition line in Purchasing.

## Using Internal Requisitions

Internal requisitions provide a flexible solution to your inventory requisitioning needs. You can eliminate user intervention when you do not need it, such as when you are loading internal requisitions into Order Management or placing demand. The following sections describe the entire business and information flow for internal requisitions, and identifies opportunities for you to simplify processing.

## Demand for Internal Requisitions

Demand for inventory requests can come from several sources. The primary sources are:

- Online user's request for stock items out of inventory
- Inventory Replenishment Requests
- Oracle Master Scheduling/MRP and Supply Chain Planning generated requisitions
- External system's requests

## Online Requests

Online requisitions give you the choice of supplier or inventory sourced requisitions. Default sourcing information is determined by the requisition type, the item, and the destination of the request. When you enter a requisition, Purchasing automatically selects the correct source type and source information for the item and destination.

To restrict certain users to internal requisitions only, set their profile *PO: Legal Requisition Type to Internal*. Purchasing then requires that they source all internally orderable items from inventory. See: *Entering Requisition Headers*, page 3-48.

For frequently requested items, you can define requisition templates to create internal requisitions quickly. Requestors can pull up the template they need, fill in the need-by date and destination of the request, and specify the quantity for each desired item.

Internal requisitions also use the Account Generator, which automatically builds account distributions. You can specify only one accounting distribution per inventory sourced line. See: *Using the Account Generator in Oracle Purchasing*, page E-6.

## Inventory Replenishment Requests

Inventory automatically generates requisitions to maintain an item's stock level. The requisitions may request stock from an internal predefined source organization or from an outside supplier. See: Overview of Inventory Planning and Replenishment, *Oracle Inventory User's Guide*.

Inventory generates replenishment requests automatically using the following methods:

- Min-Max Planning
- Reorder Point Planning
- Subinventory Replenishments for Replenishment Counts
- Kanban Replenishments

All inventory replenishment methods create requisitions via the Requisitions Open Interface.

**Important:** If the destination subinventory uses locator control, you must specify a primary locator for direct inter-organization and subinventory transfers.

**Tip:** You can interface with third-party systems to enter count information and load it into Inventory using the Replenishment Interface. Inventory automatically creates replenishment requisitions using the source and planning method you define.

## Kanban Replenishments

In a pull-based system, inventory items for a particular part or assembly area are replenished as soon as they are needed. When the items are needed, kanban cards in Oracle Inventory change their Supply Status to Empty, and Inventory generates the kanban replenishment request automatically. Then Requisition Import in Purchasing validates and imports replenishment requests as requisitions. If the Source Type of the request is Supplier, Purchasing creates a blanket release (if a blanket agreement exists) or a standard purchase order (if a valid quotation exists) for the item. If the Source Type is Inter-Org, Requisition Import generates an internal requisition for the item. See: Overview of Kanban Replenishment, *Oracle Inventory User's Guide*. See: Requisition Import Process, page 13-29.

Once Purchasing approves the standard purchase order, blanket release, or internal requisition, Inventory automatically receives a status for the kanban card of In Process.

In Purchasing, Kanban replenishment requests look like any other purchasing document, and you receive them like you do any other shipment. As soon as you

receive the item for delivery through the Receipts or Receiving Transactions windows in Purchasing, Inventory automatically receives a status for the kanban request of Full, indicating that the inventory supply has been replenished.

## MRP Generated Requisitions

Master Scheduling/MRP creates requisitions for "buy" items when you release them using the Planner Workbench. MRP generated requisitions are sourced using the same rules as online and inventory replenishment requisitions. However, since MRP is planning for the entire organization, inventory sourced requisitions for MRP planned orders must be inter-organization transfer requests. You cannot request subinventory transfers using internal requisitions for MRP planned orders, unless you specify a non-nettable source subinventory on the internal requisition. See: *Viewing On-hand Quantities, Oracle Master Scheduling / MRP User's Guide*.

## External Systems

You can automatically import internal requisitions from other Oracle Applications or existing non-Oracle systems using the Requisitions Open Interface. This interface lets you integrate the Purchasing application quickly with new or existing applications. Purchasing automatically validates your data and imports your requisitions. You can import requisitions as often as you want. Then, you can review these requisitions, approve or reserve funds for them if necessary, and place them on internal sales orders. See: *Requisition Import Process, page 13-29*.

## Internal Requisition Approvals

After you create an internal requisition, you can optionally require approval. For online requests, you can set up approval rules that are specific for internal requisitions, or you can share the same rules you use for purchase requisitions. If you do not require additional approval steps, you can set up rules so that you can always complete and approve the document in the Requisitions window. See: *Entering Requisition Headers, page 3-48*.

Min-max planning, Reorder Point planning, and MRP generated requisitions are loaded as approved requisitions through the Requisitions Open Interface. If you set the Inventory Profile INV: RC Requisition Approval to Unapproved, you can optionally load Subinventory Replenishment requisitions as unapproved and use the document approval functionality in Purchasing. This profile option affects only Subinventory Replenishment requisitions. See: *Submitting a Document for Approval, page 2-32*. See: *Oracle Inventory Profile Options, Oracle Inventory User's Guide*. An internal requisition corresponding to a kanban card in Oracle Inventory enters Purchasing through Requisition Import with a status of Approved. (If encumbrance/budgetary control is on, Purchasing sets the status to Pre-Approved.) As soon as the internal requisition is approved, Inventory automatically receives a status for the kanban card of In Process. See: *Demand for Internal Requisitions, page 3-16*. See: *Requisition Import Process, page 13-29*.



Requisition supply is created for the destination organization as soon as the requisition is approved. If you create approved requisitions through Requisition Import, supply is created at the time the requisition is created. Master Scheduling/MRP and Inventory planning get complete visibility to the incoming internal requisition supply so the planning processes do not create additional reorders for items that you have already requested.

## Creation of Internal Sales Orders

Once you approve inventory sourced requisition lines, Purchasing translates the requisition into an internal sales order, providing the link between the requestor's requirement and the physical demand against inventory. You run two separate batch processes to create the internal sales order from the approved requisition:

- Create Internal Sales Orders. See: Create Internal Sales Orders Process, page 13-4.
- Order Import. See: Order Import, *Oracle Order Management Implementation Manual*.

Purchasing uses location associations to create internal sales orders from internal requisitions for a given deliver-to location. When you associate a customer and customer site with a location and then enter an internal requisition with that location as the deliver-to point, Purchasing uses the associated customer and customer site on the internal sales order that it creates. The associated customer site becomes the ship-to site for Order Management's ship confirmation. See: Defining Locations, page 1-18. See: Creating and Updating Customers, *Oracle Receivables User's Guide*.

Internal orders are automatically scheduled by setting the Schedule Ship Date on the sales order to the Need-by Date from the requisition. If you specify a subinventory on the internal requisition line, Order Management reserves the goods and uses only the specified subinventory for allocation. If the goods do not exist at the specified subinventory, Order Management backorders them, even if they do exist in another subinventory.

The Create Internal Sales Orders process loads the Order Management open interface, OrderImport, using the order type you define in the Purchasing Options window. See: Defining Internal Requisition Options, page 1-38. OrderImport creates internal sales orders from the records in the interface table, and determines the order cycle and defaults values based on the order type.

**Note:** You should not drop-ship internal sales orders. See: Drop Shipments, page 4-114.

## Multi-Org: Creation of Internal Sales Orders Across Operating Units

A Multi-Org implementation of Purchasing enables separate operating units within an organization to operate independently of each other. However, you may still need to obtain goods from another operating unit, and Purchasing supports this. You can create

an internal sales order for an item in another operating unit. When creating this internal sales order, you must create it in the destination organization's operating unit, and all Order Management activity must take place within that destination operating unit. For example, the following table lists the generalized steps involved and indicate the organization in which they take place.

Step	Action	Operating Unit 1 Inventory Org A	Operating Unit 2 Inventory Org B
1	Create and approve internal requisition.	X	
2	Run Create Internal Sales Orders.	X	
3	Run Order Import in Order Management		X
4	Perform pick release and ship confirm in Order Management.		X
5	Receive goods.	X	

When you use internal sales orders to transfer goods from another operating unit, the items' transfer cost is posted to the intercompany payables and receivables accounts as defined in the shipping network and an intercompany invoice can be generated. See: *Inter-Organization Shipping Network, Oracle Inventory User's Guide.*

## Management of Internal Sales Orders

You manage internal sales orders using some of the same windows as customer sales orders. Once you import an internal requisition using OrderImport, you can use the Sales Orders window to change the reserved quantity, schedule date, ship-to contact, and shipment priority. The destination organization has complete visibility to any changes in incoming supply based on schedule date changes or partial shipments.

The price on the internal sales order line comes directly from the price on the requisition line, and is always the item cost. OrderImport does not use the price list to recalculate the line price and Oracle Receivables ignores internal sales orders. So the price on the internal sales order is not used. The profile option INV: Advanced Pricing for Intercompany Invoice actually controls the price on the intercompany payables invoice. When this profile option is set to No (or null), the price on the intercompany invoice is derived from the Transfer Price List associated to the customer or item. If set to Yes, the price is derived from the Advanced Pricing engine. See: *Intercompany Invoice Pricing and Using Advanced Pricing Engine with Intercompany Invoicing, Oracle Inventory User's Guide.*

Once an internal sales order is scheduled, it is visible as demand. You can reserve

inventory for internal requisitions either to the organization, or the organization and subinventory levels.

Order Management *does not* process internal sales order lines for the Receivables Interface, even if the Receivables Interface is an action in the order cycle for the internal sales order.

**Note:** You should not drop-ship internal sales orders. See: Drop Shipments, page 4-114.

## Pick Release for Internal Sales Orders

You can directly pick release from the Shipping Transactions window. Or you can selectively release one internal sales order at a time by entering the internal sales order number as a pick release criterion. Or, you can release a group of internal sales orders by specifying the internal sales order, order type, and a range of dates, or by using the shipment planning delivery, trip, and trip stop information. You can also release internal sales orders with customer orders by entering a range of dates.

When you enter an internal requisition, you must specify the source organization, and you can optionally specify the subinventory source. If you do not enter source subinventory information on an internal requisition, picking proceeds using the standard inventory picking rules.

Oracle Shipping Execution releases only order lines which meet the prerequisites of the order cycle specific to the internal sales order type.

See: *Oracle Shipping Execution User's Guide*.

## Ship Confirmation for Internal Sales Orders

Use the Shipping Transactions window to ship confirm entire or partial shipments. You can also backorder the internal sales order when you do not have enough on-hand quantity to fulfill the request.

Partial shipments are handled by splitting internal order lines into multiple shipment schedules with different delivery dates. You cannot change the warehouse or the subinventories on the delivery details.

When you ship confirm, Shipping Execution updates the Inventory Interface and generates a delivery ship notice outbound (DSNO) transaction. Inventory automatically updates on-hand quantities to reflect the internally ordered items that you shipped. If you are shipping using intransit inventory, the destination organization gets complete visibility of the incoming intransit supply. Internal requisition supply is reduced by the quantity of the shipment.

You can also enter the expected arrival date at ship confirmation to provide a more accurate supply picture to MRP and inventory planning.

See: *Oracle Shipping Execution User's Guide*.

## Management of Internal Requisitions

### Update Intransit Information

For inter-organization transfers that use intransit, you can use the Manage Shipments window to update the expected arrival date. Master Scheduling/MRP and inventory planning get complete visibility to the change in expected arrival date. See: Managing Shipments, page 9-81.

### Receive, Inspect, and Deliver Items

Use the Receipts and Receiving Transactions windows to process receipts of inter-organization requests that use intransit. Receiving personnel can simply enter the requisition number on the shipping documentation and process the entire shipment using express receiving transactions. For receipt of partial shipments, you can record the quantities for the individual items included in the shipment. You can receive items into receiving, or you can receive the goods directly to the final destination, either an inventory or expense location.

If you receive items into receiving/inspection, you process inspections, transfers, and deliveries for internal requisitions just as you would process supplier receipts or inventory transfers. See: Overview of Receiving, page 9-1.

### View Internal Requisition Status

In Purchasing, you can view the internal sales order and any changes to it, by selecting View Sales Orders on the Tools menu in the Requisition Lines Summary window. Or, you can access the Sales Orders window directly in Order Management and query on the specific internal sales order number, or any other relevant criteria. The Sales Orders window provides information about the status of the internal sales order, quantities shipped, quantities cancelled, and dates of transactions.

You can also report on requisition status. See: Backordered Internal Requisitions Report, page 11-6, Internal Requisitions Status Report, page 11-19, Internal Requisitions/Deliveries Discrepancy Report, page 11-20, and Requisitions on Cancelled Sales Order Report, page 11-77.

### Cancelling Internal Requisitions

If you cancel an internal sales order that was generated by an internal requisition, you get a warning message that the order line is related to a requisition line that is now awaiting cancellation. You can then use the Control Document window to cancel the requisition line. See: Controlling Documents, page 2-57.

Purchasing lets you cancel or final close an inventory sourced requisition line only after you cancel the internal sales order in Order Management. See: Cancelling Orders, *Oracle Order Management User's Guide*.

## Internal Requisitions Processing Summary

Below is a summary of key transactions and processes you use for Internal requisitions. If you are using inventory replenishment or MRP generated internal requisitions, Pick Release and Ship Confirmation are the only required online transactions. If you are creating online requests, you also use the Requisitions window. See: Online Processing Automation for Internal Requisitions, page 3-30 for suggestions on how to implement automated processing and reduce online interaction.

Step	Action	Required	Window/Process
1	Create Internal Requisition	On-line or Automatic	Requisitions window and Requisition Import process: Inventory replenishment, MRP Planned Orders, External Sources
2	Approve Requisition	Optional	Approve Documents window
3	Create Internal Sales Orders	Automatic	Create Internal Sales Orders process, OrderImport process
4	Modify Order Schedule	Optional	Sales Orders window
5	Pick Release Orders	On-line	Release Sales Orders for Picking window or Shipping Transactions window
6	Confirm Pick-Wave Move Order	Optional	Transact Move Order window (if not auto-pick confirming from Pick Release window)
7	Ship Confirmation	On-line	Shipping Transactions window, Order Management Interface, Inventory Interface
8	Receive Items	Optional	Receipts window, Receiving Transaction Processor
9	Inspect Receipts	Optional	Receiving Transactions window, Receiving Transaction Processor

<b>Step</b>	<b>Action</b>	<b>Required</b>	<b>Window/Process</b>
10	Deliver Receipts	Optional	Receiving Transactions window, Receiving Transaction Processor, Inventory Transaction Processor
11	View Requisition Status	Optional	Requisition Headers Summary window, Requisition Lines Summary window
12	Cancelling Internal Orders	Optional	Sales Orders window, Control Document window, Define MassCancel window, Run MassCancel window

## Internal Requisitions Setup Overview

Internal requisitions provide a solution to a variety of inventory requisitioning needs. When you implement this feature, you need to carefully review the options and configure the applications to support your business processes.

For example, if you are using internal requisitions to generate inventory replenishment requisitions and fulfill them via subinventory transfers within a plant, you may want to limit your online interaction to pick release and ship confirmation. You do not have to record separate ship, receive, and deliver transactions when the same employee actually picks the items out of the source subinventory and places them at the destination in one step.

<b>Product</b>	<b>Internal Requisition Setup Function</b>
Order Management	Update profile options, Define transaction types, Define order number sources, Update/define default value rules, Define price lists, Define Concurrent Program Resubmission interval for the OrderImport process
Shipping Execution	Define release sequence rules, Define pick slip grouping rules, Define shipping parameters
Inventory	Define internally requested items, Define inter-organization shipping network, Define item sourcing, Define Concurrent Program Resubmission intervals in Inventory planning and replenishment windows

Product	Internal Requisition Setup Function
Purchasing	Define Internal Requisition Deliver-To Sites, Set Legal Requisition Type profile, Define Purchasing Options, Define Concurrent Program Resubmission intervals for the Requisition Import and Create Internal Sales Orders processes

## Minimum Order Management Setup for Internal Requisitions

You use standard sales order functionality to define transaction types for internal sales orders. You also need to use the Purchasing Options window to specify the order type you use for internal requisitions. See: *Defining Internal Requisition Options*, page 1-38.

You must perform the following setups in Order Management to use the internal requisition features. You may choose to take advantage of other Order Management features which require additional setups. See: *Oracle Order Management Recommended Setup*, *Oracle Order Management Implementation Manual*.

### Define Order Management Profile Options

Set the profile option OM: Item Flexfield. This profile option defines which structure of the item flexfield to use. See: *Order Management Profile Options*, *Oracle Order Management Implementation Manual*.

Note that Order Management uses the same ledger as defined in the System Options window in Oracle Receivables. See: *Accounting System Options*, *Oracle Receivables User's Guide*.

Use the Parameters window in Order Management to define the Item Master organization for this installation.

**Tip:** Set the Item Validation Organization to the same Item Master organization as your purchasing reference organization (set in the Financials Options window). See: *About Financials Options*, *Oracle Payables User's Guide*.

### Define Transaction Types

Use the Transaction Types window to define order and line types. Order Management provides default order cycle workflows that you must associate with each order and line type. See: *Defining Transaction Types*, *Oracle Order Management Implementation Manual*.

## Define an Order Management Number Source For Internal Requisitions

Define order number sources to automatically number internal sales orders as you import them. You can use a single order number source to assign unique numbers to all your orders, or you can use a different order number source within each order type. See: Defining Order Number Sources, *Oracle Order Management Implementation Manual*.

## Define a Price List For Internal Requisition

Although internal requisitions use the item's cost as the price, Order Management requires price lists to process all sales orders. Define a price list for use with the internal requisition order type. You do not need to add any lines to the price list. See: Defining a Price List, *Oracle Order Management Implementation Manual*.

## Decide which Default Value Rules to Use

Default value rules define the defaulting that occurs as orders are entered or imported. Order Management provides default value rules that you can use for internal sales orders. Confirm that the default value rules that Order Management provides suit your business needs. If not, use the Defaulting Rules window to modify them. See: Defining Default Value Rules, *Oracle Order Management Implementation Manual*.

## Define Inventory Accounting (Account Generator)

Order Management can dynamically create the Cost of Goods Sold (COGS) Account for each shipped or returned item based on rules you define. Order Management provides a default Account Generator process to be used in determining the COGS Account during the Inventory Interface process.

You can either accept the default COGS Account Generator process or customize it to suit your business needs. For more information on how to accept or customize this feature, see the Oracle Order Management documentation.

## Internal Sales Orders Processing Constraints (Optional)

Order Management processing constraints apply to all your sales orders, including internal sales orders imported from Purchasing. Processing constraints prevent users from adding, updating, deleting and cancelling order information beyond certain points in the order cycles. You can use the System rules Order Management provides, which prevent data integrity violations, or define your own, stricter, rules. See: Defining Processing Constraints, *Oracle Order Management Implementation Manual*.

## Minimum Shipping Execution Setup for Internal Requisitions

Perform the following steps:

- Define release sequence rules



- Define pick slip grouping rules
- Define shipping parameters

See: *Oracle Shipping Execution User's Guide*.

## Minimum Purchasing Setup for Internal Requisitions

### Define Internal Requisition Deliver-To Sites

Purchasing uses locations to identify the final delivery location for both inventory and supplier sourced requisitions. As a requestor, you want to specify the same destination for both purchase and internal requisitions. As a shipping clerk, you are concerned with the final delivery location of the item, regardless whether it is for an internal or external customer. Purchasing and Order Management use location associations to minimize the decisions you need to make when you create internal requests.

Use the Location window to define a location for each site that receives either inventory or supplier sourced material. See: *Defining Locations*, page 1-18. For internal requisition deliver-to locations, you also need to associate the locations with a customer. Use the Customers window to define a Customer and Ship-To site for each deliver-to location. Use the Business Purposes region in the Customers window to associate your internal locations to your customers. See: *Creating and Updating Customers, Oracle Receivables User's Guide*

**Tip:** Create an internal customer for each destination organization, and customer ship-to site for each deliver-to location within the destination organization.

**Tip:** Define the same address for the customer ship-to site as the deliver-to location. Order Management prints the ship-to address on the shipping documentation.

**Tip:** Order Management requires both a ship-to and an invoice-to for each order, even though internal order lines are not invoiced. When you define a customer, either make the ship-to address both a ship-to and bill-to business purpose and set the Primary flag to Yes on the business purpose, or assign the ship-to to a bill-to location.

### Set Up Internal Requisition Approvals and Security

You set up approval and security rules for internal requisitions just as you do for purchase requisitions. Use the Document Types, Positions, Position Hierarchies, Approval Groups, and Assign Approval Groups windows to set up approval and

security options for internal requisitions. See: Setting Up Document Approval and Security, page 2-1.

## Define Purchasing Options for Internal Requisitions

You need to set up these additional purchasing options to use internal requisitions:

- **Order Type**  
Pick the Order Type you defined in Order Management for internal sales orders. Purchasing uses this type to create sales orders from internal requisitions. See: Defining Internal Requisition Options, page 1-38.
- **Enforce Quantity Rounding**  
In the Purchasing Options window, specify whether you enforce lot quantity rounding or display advisory messages when you create online requisitions using the Requisitions window. See: Defining Control Options, page 1-34

## Minimum Inventory Setup for Internal Requisitions

### Define Internally Orderable Items

When you define internally orderable items, there are a few attributes that require extra consideration. See: Defining Items, *Oracle Inventory User's Guide*.

- **Inventory and Order Management regions**  
Items you use on internal requisitions must be Inventory enabled, internally orderable and stockable, shippable, and Order Management transactable for the source organizations. Under Inventory, you need to select the Inventory Item, Transactable, and Stockable options. Under Order Management, you need to select the Internal Ordered, Internal Orders Enabled, OE Transactable, and Shippable options.
- **Source Type - General Planning region**  
Specify a default source type of Inventory or Supplier.  
You cannot create intraorganization internal requisitions for MRP planned items. When you specify sourcing information for MRP planned items, you need to ensure that you do not define an intraorganization sourcing rule for these items.
- **List Price - Purchasing region**  
Inventory sourced requisitions use item costs for pricing. You may still want to specify a list price for items that are sourced both from suppliers or inventory.
- **Unit of Issue - Purchasing region**  
You use units of issue to round order quantities, minimizing shipping,

warehousing, and handling costs.

Enter the unit of measure you typically use to issue the item from inventory. Purchasing uses this unit of measure as the default for internal requisition lines sourced from inventory when you create them in the Requisitions window.

- **Rounding Factor - Purchasing region**

Enter a number between 0 and 1. This factor determines how to round the quantity on an internal requisition that results from conversions between the requisition line unit of measure and the item's Unit of Issue. This factor ensures that the unit of issue resolves to an integer, rather than a fractional amount.

Purchasing either performs rounding automatically or advises you of the suggested quantity, depending how you set up your purchasing options.

## **Set Up Item Sourcing**

Internal requisitions use the sourcing information you specify in Inventory. All items, subinventories, and organizations may have item sourcing information specified for them. At each level (item, subinventory, or organization), you can choose whether items are replenished from inventory or purchased from a supplier.

- **Source Type**

Specify Inventory as the default source type if you want to source requests from an internal stock location.

- **Source Organization and Subinventory**

If you specify an item to be replenished from inventory, you must specify a source organization; a source subinventory is optional. When you place an order for this item, Inventory creates an internal requisition for the item from the source location.

In case of a conflict between the item, subinventory, and organization levels, internal requisitions use the following order of precedence to determine the default source type and source for the item and destination:

- Sourcing information specified in the item-subinventory relationship
  - Sourcing information specified in the subinventory definition
  - Sourcing information specified in the item definition
  - Sourcing information specified in the organization setup options

## **Define the Inter-Organization Shipping Network**

Use the Shipping Networks window to define your inter-organization network. You must enable the network between each source (shipping) and destination (receiving)

organization.

- Internal Order Required

Select Internal Order Required if you want all transfers between these two organizations to use internal orders.

- Transfer Type

Specify whether you ship material directly, or use intransit inventory for shipments between these two organizations.

**Important:** If you use Lot, Serial, or Item Revision Control in both the source and destination organization, you must use intransit if you ship from an organization with less control (i.e. Lot Control), to an organization with more control (i.e. Lot and Serial Control).

- Receipt Routing

For intransit transfers, you can choose from the following primary receipt routings: Standard receipt, Inspection required, or Direct delivery.

- FOB Point

Specify whether the destination organization takes ownership of transferred items when they are issued to intransit (Shipment), or when they are received out of intransit (Receipt).

- Transfer Charge Type

Specify how you want to apply transfer costs to the destination organization. Choose either a predefined or requested percentage of the transaction value or a fixed amount that represents an added value.

### Set Up a Customer Association

To define your organization as the destination for an internal requisition, Order Management has to recognize you as a customer. See: Defining Locations, page 1-18. See: Creating and Updating Customers, *Oracle Receivables User's Guide*

### Online Processing Automation for Internal Requisitions

Internal requisitions provide a number of options to automate processing. You can set up the following processes to run automatically as often as you like to limit online interaction and streamline processing. See: Submitting a Request, *Oracle Applications System Administrator's Guide*.

- Reorder Point Planning Report

- Min-Max Planning Report
- Requisition Import
- Create Internal Sales Orders
- OrderImport

**Tip:** Create a report group to run all requests back-to-back over specific time intervals when you are using internal requisitions for automatic subinventory transfers.

## Internal Requisitions Example

Purchasing provides flexible internal requisitions that you can tailor to meet your needs. Review the example in this section to better understand how you can use internal requisitions.

*You are not required to manage internal requisition activities exactly as described in the following example. Rather, the objective of these examples is to highlight the flexibility of internal requisitions across a variety of situations.*

*Oracle Manufacturing recommends that you experiment and review the results of different approaches to determine the best implementation of the internal requisition functionality for your unique needs. You should use this example as a starting point to better understand how you might use internal requisitions.*

### Example Overview

Global Computers, Incorporated is a computer manufacturer with organizations in Austin, TX and Sacramento, CA.

The Austin organization repetitively manufactures plastic components and uses the components, along with purchased items, to assemble base and cover assemblies in the Sacramento organization. Ownership of inter-organization transfers between Austin and Sacramento changes hands at the time of receipt (FOB Point: Receiving).

The Sacramento organization uses the Austin base and cover assemblies to assemble configurations of Sentinel computers. Sacramento also has a local sales offices for customer visits and demonstrations. Your salespeople distribute sales brochures during customer visits.

Employees can request Sentinel Computers for their own use, as well as mouse pads and wrist pads for their offices.

Define the following items at Global Computers:

Item	Item Description	
A54888	Sentinel Base Assembly	Assembled in <b>Austin</b> , Sub Assembly of <b>Sentinel Computer</b> , Internally Orderable in <b>Austin</b> , Default Source Type of <b>Inventory</b> , Default Source Organization of <b>Austin</b> , Default Source Subinventory of <b>Repetitive Assembly</b>
S86662	Sentinel Cover Assembly	Sub Assembly of <b>Sentinel Computer</b> , Assembled in <b>Austin</b> , Internally Orderable from <b>Austin</b> , Default Source Type of <b>Inventory</b> , Default Source Organization of <b>Austin</b> , Default Source Subinventory of <b>Repetitive Assembly</b>
S56302	Sentinel Computer	Assembled in <b>Sacramento</b> , Internally Orderable by Employees
C13139	Hard Drive	Used in Sentinel Base Assembly
S85773	Sales Brochure	Purchased from external suppliers, Stocked at <b>Sacramento</b> for internal use, Limited quantities on hand at the sales office
M1002	Mouse Pad	Purchased from external suppliers, Stocked at <b>Sacramento</b> for internal use
M1002	Wrist Pad	Purchased from external suppliers, Stocked at <b>Sacramento</b> for internal use

Define the following subinventories at Global Computers:

Organization	Subinventory
Austin	<b>AUS-Finished Goods</b> : Contains completed <b>Sentinel Base Assemblies</b> , Contains completed <b>Sentinel Cover Assemblies</b> , Tracked - asset subinventory
Austin	<b>Repetitive Assembly</b> : Contains <b>Hard Drives</b> for final assembly in WIP, Uses Min/Max replenishment to signal replenishment, Request from <b>AUS-Stores</b> subinventory
Austin	<b>AUS-Stores</b> : Contains additional supply of <b>Hard Drives</b> , Tracked - asset subinventory

Organization	Subinventory
Sacramento	<b>SAC-Finished Goods:</b> Contains completed <b>Sentinel Computers</b> , Tracked - asset subinventory
Sacramento	<b>SAC-Stores:</b> Contains completed <b>Sentinel Base Assemblies</b> shipped from <b>Austin</b> , Contains completed <b>Sentinel Cover Assemblies</b> shipped from <b>Austin</b> , Tracked - asset subinventory
Sacramento	<b>Office Supplies:</b> Contains supply of <b>Wrist Pads</b> and <b>Mouse Pads</b> for internal use, Not tracked - expense subinventory
Sacramento	<b>Storage:</b> Central storage for excess <b>Sales Brochures</b> , Tracked - asset subinventory
Sacramento	<b>Visit Center:</b> Contains local supply of <b>Sales Brochures</b> for customer visits, Space for only 100 <b>Sales Brochures</b> , Not tracked - expense subinventory

### Inventory Replenishment Request (Manufacturing)

You use one **Hard Drive** during the assembly of each **Sentinel Base Assembly**, and keep a limited supply of the **Hard Drives** in your Repetitive Assembly subinventory. As you consume **Hard Drives** from the **Repetitive Assembly**, you want to automatically send inventory replenishment requests to transfer additional **Hard Drives** from your **Stores** subinventory. The material handler needs to receive the inventory request and transfer the material before you run into a shortage situation. You create a report group that submits the Min-Max Planning, Requisition Import, Create Internal Sales Orders, and OrderImport processes every two hours.

As soon as the **Hard Drive** supply in the **Repetitive Assembly** subinventory drops below the minimum quantity, the next run of the Min-Max Planning process automatically creates a replenishment order for the reorder quantity. The reorder uses the item sourcing information to automatically create an intraorganization request in the Austin plant to move **Hard Drives** from **Stores** to the **Repetitive Assembly** subinventory. The request is automatically loaded as an internal requisition and an internal sales order, providing visibility of the request to the material handlers in the Austin plant.

The material handler also runs Pick Release every two hours to identify the pull requests from the shop floor subinventory. The next run of Pick Release creates a move order line for the subinventory transfer of **Hard Drives**. The material handler picks the **Hard Drives** out of the **Stores** subinventory, completes a ship confirmation and replenishes the **Repetitive Assembly** subinventory before a shortage occurs. At ship confirmation, the on-hand balances of the two subinventories are automatically

updated.

### MRP Generated Inter-Organization Request (Manufacturing)

You use Oracle Master Scheduling/MRP and Supply Chain Planning in **Sacramento** to schedule production of the final assembly of the **Sentinel Computer**. The **Sentinel Base Assembly** and **Sentinel Cover Assembly** are provided by the **Austin** organization, so you define these items as "buy" items in **Sacramento**. You also specify the following sourcing information for the item:

- Source Type - **Inventory**
- Source Organization - **Austin**
- Source Subinventory - **AUS-Finished Goods**

Master Scheduling/MRP recommends that you produce 400 **Sentinel Computers** to fulfill demand over the next four weeks (100 each week), and you only have 100 **Sentinel Cover Assemblies** and 100 **Sentinel Base Assemblies** on hand in **Sacramento**. You need five days to ship material from **Austin** to **Sacramento**, so the planner implements planned orders for 100 **Sentinel Cover Assemblies** and 100 **Sentinel Base Assemblies** for the next three weeks using the Planner Workbench.

When the planner releases the planned orders for **Sacramento**, Master Scheduling/MRP automatically loads the Requisitions Open Interface and submits Requisition Import. Requisition Import uses the sourcing information that you set up to create a requisition line for each week sourced from the **Austin AUS-Finished Goods** subinventory. In the background, the Create Internal Sales Orders and OrderImport processes automatically load the internal sales order against the **Austin** organization.

What if you have a three day production delay in **Austin** and you need to delay the third shipment of **Sentinel Base Assemblies** for a few days? **Sacramento** needs visibility to the delay to adjust the production schedules of the final assembly of the **Sentinel Computers**. In **Austin**, you can use the Sales Orders window to update the scheduled shipment date by three days, or choose a different freight carrier for faster delivery if you need to expedite the shipment to prevent a shortage in **Sacramento**. When you ship the third shipment from **Austin**, you can update the expected arrival date, giving the planner and MRP in **Sacramento** full visibility of supply changes.

Each ship confirmation of the **Sentinel Base Assemblies** creates an intransit shipment from Austin to Sacramento. You do not require inspection of your own inter-organization transfers, so the receiving clerk in Sacramento receives directly into the Final Assembly subinventory when the shipment arrives. The intransit inventory balance is automatically updated and the inter-organization accounting entries are created along with the receipt transaction.

### Inventory Replenishment Request (Office Stock Locations)

In the Sacramento sales office, you use internal requisitions to replenish your stock of



sales brochures in the **Visit Center**.

Sales representatives use your brochures well, and most customers take brochures with them after the visit. You want easy access to brochures in the **Visit Center**, but only have room for 100 **Sales Brochures**. You typically use about 75 a week, but the number fluctuates with sales activity. Sales representatives take what they need; you do a stock count on Monday and Wednesday of each week and replenish whenever the stock count falls below 25.

You need to define min-max information for the **Sales Brochures** that you stock in the **Visit Center** subinventory. Use the Item Subinventories window to specify a planning method of Min-max planning, a minimum quantity of 25, and a maximum quantity of 100.

Requisition Import creates an approved internal requisition for subinventory transfers, and the sales order is automatically loaded.

The material handler reviews the picking slip, pulls the 80 Sales Brochures from **Storage** Subinventory and delivers them to the **Visit Center**. After delivering the material the handler records the shipment using the Confirm Shipments window. The shipment, receipt, and delivery information is recorded at once, and the on-hand balance of the **Storage** subinventory is updated automatically. Inventory automatically creates the necessary accounting entries to reduce the overall value of **Sales Brochures** in the **Storage** subinventory and charges the accounts associated with the **Visit Center** subinventory.

### Online Request for Goods out of Inventory

In **Sacramento**, you stock low-cost office supplies on site to provide quick delivery to your employees. Employees can request items that are sourced from suppliers or inventory, but they do not know the source type at the time of the request. You also require internal requisitions to process requests for goods out of the stock locations. You have a company policy to always request items from **Office Supplies** whenever possible. You do not require any additional approvals, and a material handler picks the items out of inventory and delivers them directly to your office. A one day turnaround time is required for all internal requests.

As a requestor, you want to order the following items to improve your comfort and productivity:

- **Sentinel Computer**
- **Mouse Pad**
- **Wrist Pad**
- **Glare Screen** (not stocked on site)

Use the Requisitions window to create your request. Since company policy dictates that you request items from inventory whenever possible, the default requisition type is

**Internal Requisition** and the default source type is **Inventory**. When you create the four requisition lines for your items, Purchasing automatically uses the item sourcing information to source the **Sentinel Computer** from the **SAC-Finished Goods** subinventory. Since the **Glare Screen** can only be purchased from suppliers, Purchasing sets the source type to Supplier and uses your sourcing rules and Approved Supplier List entries to determine the suggested supplier and document information. See: Automatic Sourcing, page 5-24. See: Approved Supplier List, page 5-35.

Material handlers need immediate visibility of your requests to be able to deliver in 24 hours. The system administrator sets the Create Internal Sales Orders and OrderImport processes to run every hour for internal sales orders.

The material handler in charge of the **Office Supplies** subinventory runs Pick Release twice a day to generate pick slips. The material handler reviews the picking slip, pulls the **Mouse Pad** and **Wrist Pad** from **Storage** and delivers them to your office. After getting your signature, the handler records the shipment using the Confirm Shipments window. The shipment, receipt, and delivery information is recorded at once, and the quantity delivered on the internal request is updated.

**Office Supplies** is an expense subinventory, and the correct accounts are charged when you receive the supplies into this subinventory. Since you are sourcing from an expense subinventory, ship confirmation does not generate any accounting entries for the issue of the items from the **Office Supplies** subinventory to your office location.

A separate material handler receives the **Sentinel Computer** request, and picks and ships it from the **SAC-Finished Goods** subinventory. When you complete the ship confirmation, Inventory automatically issues the Sentinel Computer out of the **SAC-Finished Goods** asset subinventory to the expense location listed on the requisition. Inventory and Purchasing also record the accounting transactions to credit the **SAC-Finished Goods** asset account and debits the appropriate charge account listed on the requisition.

## Finding Requisitions

Use the Find Requisitions window to:

- Access the Requisitions window.
- Perform requisition inquiries at header, line, and distribution levels

Depending on the function security assigned to your responsibility, you have varying levels of access to information. A responsibility defines an application user's current privileges while working with Oracle Applications. See: Function Security for Purchasing, page D-1.

### To enter search criteria:

1. Navigate to the Find Requisitions window. Then enter as many as desired of the search criteria described in the following steps.

2. Select the Operating Unit for this search.
3. Enter the requisition number. If you enter a requisition number, you can also enter a Line number.
4. Select the requisition Type (Purchase or Internal).
5. Enter the Preparer.
6. Enter the Requestor.
7. Enter the Buyer.
8. Select *Yes* or *No* to restrict the search to Modified requisitions.
9. Enter the Reference Number.
10. Enter the Import Source.
11. Enter the Line Type.
12. Use the tabbed regions to further restrict the search:
  - In the Item region, you can enter the following search criteria: Item number, Revision number, Category, item Description, and Supplier Item number.
  - In the Status region, you can limit the search by Approval status (Approved,

Incomplete, In Process, Pre-Approved, Rejected, or Returned), Control status (Open, Cancelled, or Finally Closed), or Reserved status (Yes or No).

- In the Date Ranges region, you can enter date ranges for the following dates: Creation, Need By, and Closed.
  - In the Sourcing region, you can limit the search by Source (Supplier or Inventory). For Supplier sourced requisitions, you can further limit the search by Supplier, Site, and Currency. For Inventory sourced requisitions, you can further limit the search by Organization and Subinventory. If you have enabled vendored managed inventory, you can limit your search results to those items by checking the VMI box.
  - In the Deliver To region, you can limit the search by Destination Type (Expense, Inventory, or Shop Floor), Organization, Location, and (for Inventory destinations only) Subinventory.
  - In the Related Documents region, you can limit the search by Document Type, Document number and Line Number, Purchase Order number, and drop shipment Sales Order number.
  - In the Accounting region, you can limit the search by Period, GL Date, Charge Account, Budget Account, and whether there are Active Encumbrances (Yes or No).
  - In the Projects region, you can limit the search by Project or Task number.
13. Select the Results group (Headers, Lines, or Distributions) to determine which summary window to open. Depending on the search criteria you have specified, all summary windows may not be available. For example, if you specify criteria in the Accounting region, only the Distributions summary window is available.
  14. Select the Find button to initiate the search and open the appropriate Summary window.

**To clear existing search criteria:**

- Select the Clear button to clear any existing search criteria.

**To enter a new requisition:**

- Select the New button to open the Requisitions window. See: Entering Requisition Headers, page 3-48.

## Related Topics

Using the Requisition Headers Summary Window, page 3-39

Using the Requisition Lines Summary Window, page 3-40

## Using the Requisition Headers Summary Window

Use the Requisition Headers Summary folder window to:

- View requisition header information.
- Drill down to view requisition line and distribution information.
- Access the Requisitions window for entry of new documents.
- Access the Requisitions, Requisition Preferences, and Control Document windows for maintenance of existing information.
- View information in the Action History window.

**To navigate to the Requisition Headers Summary window:**

- In the Find Requisitions window, select Headers in the Results region and select the Find button to open the Requisition Headers Summary folder window.

Number	Description	Approval Status	Creation Date	Currency
101284		Incomplete	15/JAN/2001 11:44:32	USD
101283		Incomplete	15/JAN/2001 11:33:32	USD
101282		Approved	15/JAN/2001 11:32:01	USD
101281		Approved	15/JAN/2001 11:22:48	USD
101280		Approved	15/JAN/2001 11:19:51	USD
101279		Approved	15/JAN/2001 10:52:08	USD
101271		Approved	12/JAN/2001 17:37:07	USD
101270		Incomplete	12/JAN/2001 17:35:10	USD
101256		Incomplete	11/JAN/2001 17:33:29	USD
101252		Incomplete	10/JAN/2001 12:48:56	USD

The following information is displayed: requisition Number, Preparer, Status, Description, Total amount, Currency, Creation Date, Type, Cancelled status, Finally Closed status, and Reserved status.

**To drill down to view requisition line information:**

- Select the Lines button to drill down to the Requisition Lines Summary folder window. You can also select View Lines on the Tools menu to open this window. See: Using the Requisition Lines Summary Window, page 3-40.

**To enter a new requisition:**

- Select the New button to open the Requisitions window. See: Entering Requisition Headers, page 3-48.

**To open the Requisitions window for the current line:**

- Select the Open button to open the Requisitions window and query the requisition on the current line. Your options in this window depend on the status of the requisition and your approval and security options. For example, if a requisition has a status of In Process, you cannot open it from this window. See: Entering Requisition Headers, page 3-48.

**To view requisition distributions information:**

- Select View Distributions on the Tools menu to open the Requisition Distributions Summary folder window. See: Using the Requisition Distributions Summary Window, page 3-42.

**To view action history:**

- Select View Action History on the Tools menu to open the Action History window. See: Viewing Action History, page 10-1.

**To view purchase orders:**

- Choose the Lines button to open the Requisition Lines Summary window. Then select View Purchase Orders on the Tools menu to open the purchase order.

**To view sales orders:**

- Choose the Lines button to open the Requisition Lines Summary window. Then select View Sales Orders on the Tools menu to open the Sales Orders window.

**To enter requisition control information:**

- Select Control on the Tools menu to open the Control Document window for the document on the current line. See: Controlling Documents, page 2-57.

**To enter requisition preferences:**

- Select Preferences on the Tools menu to open the Requisition Preferences window. See: Entering Requisition Preferences, page 3-44.

## Related Topics

Customizing the Presentation of Data in a Folder, *Oracle Applications User's Guide*

Finding Purchase Orders, page 4-23

## Using the Requisition Lines Summary Window

Use the Requisition Lines Summary folder window to:

- View requisition line information.

- Drill down to view requisition distribution information.
- Access the Requisitions window for entry of new documents.
- Access the Requisitions, Requisition Preferences, and Control Document windows for maintenance of existing information.
- View information in the Action History window.
- View purchase order and sales order information, if the requisition has been placed on a purchase or sales order.

**To navigate to the Requisition Lines Summary window:**

- In the Find Requisitions window, select Lines in the Results region and select the Find button to open the Requisition Lines Summary folder window. You can also navigate to this window from the Requisition Headers Summary window by selecting the Lines button or View Lines on the Tools menu.

Number	Line	Item	Rev	Category	Description	Quantity	UOM
101283	1	RW15027		PRODUCTN.E	Plastic Stock - White	500	Po
101282	1	RW15027		PRODUCTN.E	Plastic Stock - White	500	Po
101281	1	RW15027		PRODUCTN.E	Plastic Stock - White	500	Po
101280	1	RW15027		PRODUCTN.E	Plastic Stock - White	500	Po
101265	1	AS18947		PRODUCTN.F	Sentinel multimedia	10	Ea
101256	1	RW15027		PRODUCTN.E	Plastic Stock - White	500	Po
101238	1	RW15027		PRODUCTN.E	Plastic Stock - White	500	Po
101209	1	ASA		MISC.MISC	SRI'S A ITEM TOP	10	Ea
101208	1	CM13139		PRODUCTN.C	Hard Drive - 850 MB	10	Ea
101207	1	ASA		MISC.MISC	SRI'S A ITEM TOP	10	Ea

Buttons: Distributions, New, Open

The following information is displayed: requisition Number, Line, Item, item Revision, Category, item Description, quantity Ordered, quantity Delivered, Type, UOM, Price, Need By date, Requestor, Total amount, Currency, Modified status, Currency Price, Supplier, supplier Site, Supplier Item number, Contract number, Contract revision, Source Document Type, PO Number, PO Line number, Reference Number, Source Type, Source Organization, Source Subinventory, Destination Type, Destination Organization, Deliver To, Destination Subinventory, Finally Closed status, Cancelled status, and Reserved status.

**To drill down to view requisition distribution information:**

- Select the Distributions button to drill down to the Requisition Distributions Summary folder window. You can also select View Distributions on the Tools menu to open this window. See: Using the Requisition Distributions Summary Window,

page 3-42.

**To enter a new requisition:**

- Select the New button to open the Requisitions window. See: Entering Requisition Headers, page 3-48.

**To open the Requisitions window for the current line:**

- Select the Open button to open the Requisitions window and query the requisition on the current line. Your options in this window depend on the status of the requisition and your approval and security options. For example, if a requisition has a status of In Process, you cannot open its line from this window. See: Entering Requisition Headers, page 3-48.

**To view purchase orders:**

- Select View Purchase Orders on the Tools menu to open the purchase order.

**To view sales orders:**

- Select View Sales Orders on the Tools menu to open the Sales Orders window.

**To view project contract information:**

- Select View Project Contract Information on the Tools menu

## Related Topics

Customizing the Presentation of Data in a Folder, *Oracle Applications User's Guide*

Viewing Action History, page 10-1

Finding Purchase Orders, page 4-23

Controlling Documents, page 2-57

Entering Requisition Preferences, page 3-44

## Using the Requisition Distributions Summary Window

Use the Requisition Distributions Summary folder window to:

- View requisition distribution information.
- Access the Requisitions window for entry of new documents.
- Access the Requisitions, Requisition Preferences, and Control Document windows for maintenance of existing information.
- View information in the Action History window.

**To navigate to the Requisition Distributions Summary window:**

- In the Find Requisitions window, select Distributions in the Results region and



select the Find button to open the Requisition Distributions Summary folder window. You can also navigate to this window by selecting View Distributions on the Tools menu in the Requisition Headers Summary and Requisition Lines Summary windows.

Number	Line	Distribution	Item	Description	UOM
101283	1	1	RW15027	Plastic Stock - White	Pounds
101282	1	1	RW15027	Plastic Stock - White	Pounds
101281	1	1	RW15027	Plastic Stock - White	Pounds
101280	1	1	RW15027	Plastic Stock - White	Pounds
101265	1	1	AS18947	Sentinel multimedia	Each
101256	1	1	RW15027	Plastic Stock - White	Pounds
101209	1	1	ASA	SRI'S A ITEM TOP	Each
101208	1	1	CM13139	Hard Drive - 850 MB	Each
101207	1	1	ASA	SRI'S A ITEM TOP	Each
101197	1	1	PB-001	BIS	Each

The following information is displayed: requisition Number, Line number, Distribution number, Item, item Description, UOM, Price, Quantity, Amount, Charge Account, Contract Line number, and Contract Deliverable number.

**To enter a new requisition:**

- Select the New button to open the Requisitions window. See: Entering Requisition Headers, page 3-48.

**To open the Requisitions window for the current line:**

- Select the Open button to open the Requisitions window and query the requisition on the current line. Your options in this window depend on the status of the requisition and your approval and security options. See: Entering Requisition Headers, page 3-48.

**Related Topics**

Customizing the Presentation of Data in a Folder, *Oracle Applications User's Guide*

Viewing Action History, page 10-1

Finding Purchase Orders, page 4-23

Entering Requisition Preferences, page 3-44

## Entering Requisition Preferences

Use the Requisition Preferences window to enter requisition line defaults (including currency, destination, project, and sourcing default information). These defaults are applicable during this user session to all new requisition lines you create after you set the defaults until you exit Purchasing. You can override these defaults for specific lines.

### To enter main preferences:

1. Navigate to the Requisitions Preferences window by selecting Preferences on the Tools menu in the Requisitions window or in the Requisitions Headers, Lines, and Distributions Summary windows. In the Main tabbed region, you can enter the defaults described in the following steps.

The screenshot shows the 'Requisition Preferences (Vision Operations)' window. It has two tabs: 'Main' and 'Project Information'. The 'Main' tab is selected. The form contains the following fields and controls:

- Need-By: Text input field
- GL Date: Text input field
- Charge Account: Text input field
- Justification: Text input field
- Note To Receiver: Text input field
- Reference Number: Text input field
- Transaction Nature: Text input field
- Urgent:  checkbox
- Destination Type: Dropdown menu
- Requestor: Text input field
- Organization: Text input field
- Location: Text input field
- Subinventory: Text input field
- Currency: Text input field
- Rate Type: Text input field
- Rate Date: Text input field
- Rate: Text input field
- Source: Dropdown menu
- Buyer: Text input field
- Note To Buyer: Text input field
- RFQ Required:  checkbox
- Supplier: Text input field
- Site: Text input field
- Contact: Text input field
- Phone: Text input field
- Apply: Button

2. Enter the Need By date and time.
3. Enter the GL Date to be used when funds are reserved. You can enter a GL Date only if you set up your financials system options to use encumbrance or budgetary control for requisitions. See: *About Financials Options, Oracle Payables User's Guide*. See: *Budgetary Control and Online Funds Checking, Oracle General Ledger User's Guide*.
4. Enter the Charge Account for the cost of the items on the requisition line. The account you enter here is used only for expense destinations, and it overrides any account built by the Account Generator.
5. Enter a Justification for your requisition line. Buyers and approvers can review this

justification.

6. For Internal requisitions only, enter a Note To Receiver. For example, you could note that the receiver should unpack your requested items or that only you can accept delivery. For both internal and purchase requisitions, you can provide additional notes to the receiver by using attachments. See: *Attaching Notes to Purchasing Documents*, page 1-33.
7. Enter the default Reference Number for all requisition lines. You use the reference number to match your requisition line with a specific work, project, etc.
8. Enter the Transaction Nature. See: *Defining Lookup Codes*, page 1-55.
9. Check Urgent to indicate that your requisition should be expedited. Buyers have the option to process urgent requisitions faster when they AutoCreate purchase orders from requisitions.
10. Enter a default suggested Currency for the requisition lines. This must be an enabled code from the Currency window. See: *Defining Currencies, Oracle General Ledger User's Guide*.
11. Enter the default Rate Type. You can also set this default in the Purchasing Options window. *Defining Default Options*, page 1-38. Purchasing supplies you with one of two predefined currency rate types: User or EMU Fixed. A rate type of User means that you can enter a conversion rate between the foreign currency (or transaction currency in a document entry window) and the base currency (or functional currency, defined in your ledger). A rate type of EMU Fixed means that if either your transaction currency or your functional currency is Euro (the European Monetary Unit currency) and the other is another European currency, Purchasing automatically enters a conversion Rate Date and Rate for you that you cannot change.  
  
You can define additional currency rate types in the Daily Conversion Rate Types window. See: *Defining Conversion Rate Types, Oracle General Ledger User's Guide*.
12. Enter the default currency Rate Date.
13. Enter the default currency conversion Rate. Purchasing overrides this default when you are entering requisition lines if the rate type is not User and if you have established a rate for the rate type and date. See: *Entering Daily Rates, Oracle General Ledger User's Guide*.
14. Enter the Destination Type to indicate the final destination of the purchased items:
  - *Expense* - The goods are delivered to the requestor at an expense location.
  - *Inventory* - The goods are received into inventory upon delivery. This option is appropriate only if the item is stock enabled in the deliver-to organization.

- *Shop Floor* - The goods are delivered to an outside processing operation defined by Work in Process. This option is appropriate only for outside processing items.

If Enterprise Asset Management (EAM) is installed, you can use the shop floor destination for one-time (description based) and non-stocked items to be delivered to a maintenance work order location. You can also reserve or encumber funds for shop floor destination type purchase requisitions and purchase orders associated with EAM work orders. For information, refer to the Encumbrance Accounting section in the *Oracle Enterprise Asset Management User's Guide*.

15. Enter the Requestor. This is the employee who requests the quantities on the requisition lines. Purchasing copies this name as the requestor for every requisition line.
16. Enter the Organization. The default is the requestor's organization. The List of Values displays all valid receiving organizations.
17. Enter the delivery Location for all requisition lines. The default is the requestor's location. You can pick any location that does not have an organization or any location whose organization matches the deliver-to organization. See: Enter Person, *Oracle HRMS Enterprise and Workforce Management Guide*. See: Defining Locations, page 1-18.

If the Destination Type is Inventory, you can also enter the Subinventory. See: Defining Subinventories, *Oracle Inventory User's Guide*.

18. Enter the Source type: Inventory or Supplier. If you have both options, you can source requisition lines independently of the document type. You can also mix inventory and supplier sourced requisition lines in the same requisition. Purchasing creates one internal sales order for all Inventory source type requisition lines on this requisition. You can use the Autocreate Documents window to place Supplier source type requisition lines onto purchase orders.

For Inventory source type lines, you can enter a default Organization and Subinventory. If you specify a subinventory for an internal requisition line, Order Management reserves the goods and uses only the specified subinventory for allocation. If the goods do not exist at the specified subinventory, Order Management backorders them, even if they do exist in another subinventory.

For Supplier source type lines, you can enter the following defaults: Buyer, Note to Buyer, Supplier, Site, Contact, and Phone. You can also check RFQ Required to indicate that you want to require an RFQ before the buyer creates a purchase order for the requisition. If RFQs are required and you AutoCreate a purchase order before creating an RFQ for the requisition line, Purchasing displays a warning message. You can also set this default in the Purchasing Options window. See: Defining Default Options, page 1-38.

**Project tabbed region**

- Use the Project tabbed region to enter additional information if your organization has implemented any of the following products:
  - Oracle Projects
  - Oracle Project Manufacturing
  - Oracle Grants
  - Oracle Project Contracts

The project information you enter is used by Oracle Projects for Deliver To destination types of Expense, or by Oracle Project Manufacturing for Deliver To destination types of Inventory or Shop Floor. See: *Oracle Projects User's Guide*. See: *Oracle Project Manufacturing Implementation Manual*.

**To enter project information preferences:**

1. Choose the Project Information tabbed region.
2. Select a Project Number.

For a Deliver To destination type of Inventory or Shop Floor, you can optionally enter a Project Number if the Project Control Level is set to Project in the Project Information tabbed region of the Organization Parameters window.

For a Deliver To destination type of Expense, you can always optionally enter a Project Number.

3. If you entered a Project number, select a Task number.

You must enter a Task number for a Deliver To destination type of Inventory or Shop Floor, if the Project Control Level is set to Task in the Organization Parameters window and if you have entered a Project number.

4. If Oracle Grants is implemented, select an Award identifier.

5. Enter Expenditure information:

Expenditure information is required only if your Destination Type is Expense.

- Select the Expenditure Type.
- If you chose an Expenditure Type, enter an Expenditure Organization.
- If you chose an Expenditure Organization, select the Expenditure Item Date.

**To apply your defaults:**

- Select the Apply button to apply your defaults. The preferences entered here will affect new lines entered after you select Apply until you exit the application.

## Related Topics

Using the Account Generator in Oracle Purchasing, page E-6

## Entering Requisition Headers

Use the Requisitions window to:

- Enter internal and purchase requisitions. Your approval and security setup options determine which types of requisitions you can enter.
- Take approval actions on individual requisitions online.
- Edit requisitions. Your approval and security setup options determine which requisitions you can edit. See: Controlling Documents, page 2-57.

### **To enter requisition header information:**

1. Navigate to the Requisitions window from the menu, by selecting the New button in the Find Requisitions and requisitions summary windows, or by selecting the Requisitions button in the Order Pad of the Supplier Item Catalog.

Requisitions - [New]

Operating Unit: Vision Operations

Number:  Type: Purchase Requi

Description:  Status: Incomplete

Preparer: Brown, Ms. Casey

Total: USD  0.00

Lines | Source Details | Details | Currency

Num	Type	Item	Rev	Category	Description	UOM
<input type="text"/>	<input type="text"/>	<input type="text"/>	<input type="text"/>	<input type="text"/>	<input type="text"/>	<input type="text"/>
<input type="text"/>	<input type="text"/>	<input type="text"/>	<input type="text"/>	<input type="text"/>	<input type="text"/>	<input type="text"/>
<input type="text"/>	<input type="text"/>	<input type="text"/>	<input type="text"/>	<input type="text"/>	<input type="text"/>	<input type="text"/>
<input type="text"/>	<input type="text"/>	<input type="text"/>	<input type="text"/>	<input type="text"/>	<input type="text"/>	<input type="text"/>
<input type="text"/>	<input type="text"/>	<input type="text"/>	<input type="text"/>	<input type="text"/>	<input type="text"/>	<input type="text"/>

Destination Type:

Requester:

Organization:

Location:

Subinventory:

Source:

Supplier:

Site:

Contact:

Phone:

Outside Services | Catalog... | Distributions | Approve...

The upper part of the Requisitions window has the following display-only fields:

- *Preparer* - Your employee name from the Application User window.
  - *Status* - The requisition status:
  - *Incomplete* - The requisition is incomplete, or the preparer has not yet submitted the requisition to an approver.
  - *Rejected* - The approver rejected the requisition.
  - *Returned* - A buyer rejected the requisition. Purchasing returns to the preparer all requisition lines within the same requisition that are not on a purchase order.
  - *Total* - The currency code and the base currency total amount of all lines in this requisition.
2. Select the Operating Unit for this requisition.
  3. Enter a unique Requisition number. If automatic requisition number generation is active, the cursor does not enter this field and the number is generated when you save your work. See: Defining Numbering Options, page 1-41.
  4. Choose the Requisition Type:

- *Purchase Requisition* - The requisition lines are usually satisfied from an outside supplier by means of a purchase order.
- *Internal Requisition* - The requisition lines are usually satisfied from inventory by means of an internal sales order.

When you enter requisition lines you can source them independently of the document type. You can mix inventory and supplier sourced requisition lines in the same requisition of either document type. See: Profile Options in Purchasing, page C-1.

**To open the Supplier Item Catalog:**

- With the cursor in a requisition line row, select the Catalog button to open the Supplier Item Catalog. See: Overview of the Supplier Item Catalog, page 5-5.

**To take approval actions:**

- After completing a requisition, select the Approval button to open the Approve Documents window. See: Submitting a Document for Approval, page 2-32

**To check funds:**

- Select Check Funds on the Tools menu. See: Reserving Funds for Requisitions, page 3-8

**To view tax:**

- Select Manage Tax on Tools menu to view and manage taxes.

If budgetary controls are enabled you can unreserve funds. See: Reserving Funds for Requisitions, page 3-8

**To release reserved funds:**

1. Select Unreserve from the Tools menu.
2. Enter the Unreserve Date.
3. Check Use Document GL Date to Unreserve to use the document's distribution GL dates for the funds reversal instead of the unreserve date.
4. Click OK to reverse the funds reservation on this document.

**To enter requisition preferences:**

- Select Preferences on the Tools menu to open the Requisition Preferences window. See: Entering Requisition Preferences, page 3-44.

**To access your requisition quickly:**

- Choose Place on Navigator from the File menu. Choose the Documents tabbed region in the Navigator to later access the requisition more quickly. See also: Using the Navigator's Documents Region, *Oracle Applications User's Guide*.



**Note:** Once you place a document in the Navigator, it is the first thing you see in the Navigator the next time you log into Purchasing. Choose Functions to return to the Purchasing menu.

## Related Topics

Overview of Requisitions, page 3-1

Entering Requisition Lines, page 3-51

Changing Encumbered Documents, page 4-113

## Entering Requisition Lines

Use the Items tabbed region in the Requisitions window to enter requisition line information.

You can choose a predefined item (See: Defining Items, *Oracle Inventory User's Guide*.) or you can enter an item without an item number.

### **To enter requisition line information:**

1. Navigate to the Lines tabbed region in the Requisitions window.

2. Enter a line Type for the requisition line. Line types help you define how you want to categorize your items. The default for this field is the Line Type from the Purchasing Options window. (See: Defining Default Options, page 1-38.) If you change this line type, defaults from the Line Types window appear in the Category, UOM and Price fields, and the cursor moves to the Category field. See: Defining Line Types, page 1-62.

For purposes of requisition line entry, line types are handled in three classes: amount-based, quantity-based, and outside processing. The defaults that appear when you enter a line type are cleared if you change the line type to a different class. Once you have committed a line, you can change the line type only to another line type of the same class.

If Oracle Services Procurement is implemented, you can also select a fixed price service line type. If you select the fixed price service line type the Item, Quantity, UOM, and Price fields are not available for update.

3. For quantity-based line types and outside processing line types, enter the Item you want to request. Purchasing displays defaults for purchasing category, item description, unit of measure, and unit price for this item. See: Defining Items, *Oracle Inventory User's Guide*.
4. Enter the Revision (if any) that corresponds to the item you want to order.
5. Enter the purchasing Category. You cannot change the category if you provide an item number in the Item field.

6. Enter the item Description to explain the item in further detail. When you enter an item number, Purchasing displays the item description from the Items window. You can change this description only if the Allow Description Update attribute for the item is enabled. See: *Defining Items, Oracle Inventory User's Guide*.
7. Enter the unit of measure (UOM) you want to use for your requisition line. If you enter an item number, Purchasing defaults the unit of measure for this item. If you change this value, the quantity is rounded again if appropriate, and the price is recalculated. If you enter a line type that is amount based, Purchasing uses the unit of measure that you assigned to that line type in the Line Types window. You cannot change the unit of measure of amount based items.
8. Enter the Quantity you want to request for the item. You can enter decimal quantities, but you must enter a value greater than 0.  
  
You can use the Catalog button to get price breaks for different quantities from catalog quotations or blanket purchase agreements.  
  
If Quantity Rounding is enabled, Purchasing either displays the rounded quantity you should have entered in a warning message or it updates the quantity to the appropriate rounded quantity. The rounding is based on the Unit of Issue (or primary unit of measure if the Unit of Issue is not defined) and the Rounding Factor defined for the item in Inventory. Rounding is up or down to the nearest whole Unit of Issue/primary unit of measure using the rounding factor. See: *Overview of Requisitions, page 3-1*.
9. Enter the unit Price for the item. You can enter the price in decimal format. You must enter a value greater than or equal to 0. If you enter an item number, Purchasing defaults a price for this item, but you can change this value. Your price may change if you enter a suggested supplier and a source document later.  
  
Unit prices are in the functional currency. If you need to enter a foreign currency, see the instructions below.  
  
If you create a requisition line for an amount based line type, Purchasing sets the price to 1, and you cannot change it.
10. Enter the Need By date and time for the requested items. This is required only for planned items. You must enter a date greater than or equal to the requisition creation date.  
  
The Charge Account is rolled up from a single distribution after the distribution is created. If more than one distribution is created for the line, Multiple is displayed.  
  
The lower part of the screen below the Lines tabbed region consists of optional fields for which the default can be set in the Requisition Preferences window. See: *Entering Requisition Preferences, page 3-44*.
11. If Oracle Services Procurement is implemented and you have selected a fixed price based line type, enter the Amount.

12. Enter the Destination Type:

- *Expense* - The goods are delivered to the requestor at an expense location. The destination subinventory is not applicable.
- *Inventory* - The goods are received into inventory upon delivery.
- *Shop Floor* - The goods are delivered to an outside processing operation defined by Work in Process. Purchasing uses this option for outside processing items.

If Enterprise Asset Management (EAM) is installed, you can use the shop floor destination for one-time (description based) and non-stocked items to be delivered to a maintenance work order location. You can also reserve or encumber funds for shop floor destination type purchase requisitions and purchase orders associated with EAM work orders. For information, refer to the Encumbrance Accounting section in the *Oracle Enterprise Asset Management User's Guide*.

13. Enter the name of the employee who is requesting the item. You must provide a Requestor before you can approve the requisition. The default is the requisition preparer.

14. Enter the Organization.

15. Enter the delivery Location for the requested items. Purchasing defaults the deliver-to location that you assign to the employee in the Enter Person window. You must provide a deliver-to location before you can approve the requisition. Before the source of the line can be Inventory, the deliver-to location must be linked to a customer address in the Customer Addresses window. See: Creating and Updating Customers, *Oracle Receivables User's Guide*.

16. Enter the Subinventory. This field applies only when the Destination Type is Inventory.

17. Enter the Source type. The source type determines the source of the requisitioned items. The choice you have in this field is dependent on the PO: Legal Requisition Type profile option. You may be able to use either the Inventory or the Supplier source type, or both types. See: Profile Options in Purchasing, page C-1.

Note that if you have both options, you can source requisition lines independently of the document type. You can even mix inventory and supplier sourced requisition lines in the same requisition. Purchasing creates one internal sales order for all inventory source type requisition lines on this requisition. The supplier source type requisition lines are placed onto purchase orders with the AutoCreate Documents window.

Even if you are restricted to one type, Purchasing restricts the source type as appropriate for the item. If you are restricted to Inventory but you are requesting a

Supplier item (Purchased Item attribute - Yes, Internal Ordered Item attribute - No), the source type can be only Supplier. Conversely, if you are restricted to Supplier requisitions and you ask for an Inventory item (Purchased Item attribute - No, Internal Ordered Item attribute - Yes), the source type can be only Inventory. This is allowed because a requestor may not know the item source type.

For Inventory source type lines, you can enter a default Organization and Subinventory. If you specify a subinventory for an internal requisition line, Order Management reserves the goods and uses only the specified subinventory for allocation. If the goods do not exist at the specified subinventory, Order Management backorders them, even if they do exist in another subinventory.

You can not enter an internal order for an Oracle Services Procurement fixed priced service requisition line type.

18. For the Supplier source type, enter the suggested Supplier, Supplier Site, Contact, and Phone. For the Inventory source type, enter the Organization and Subinventory.
19. If Oracle Process Manufacturing (OPM) application is installed and implemented, you are a process manufacturing user, and the selected purchasing organization is a process organization, then the process fields are enabled. The three process fields are Secondary UOM, Secondary Quantity, and Grade. See: *Entering OPM line information*, page 3-57.
20. Save your work. If you save a requisition line without entering a distribution, Purchasing tries to generate a distribution line for you, using the Account Generator based on the information you have entered. If you want your distribution account numbers to be generated based on project information, you must enter project information in the Requisition Preferences or Requisition Distributions windows before committing the distribution line. See **To enter project information preferences** in: *Entering Requisition Preferences*, page 3-44. See **To enter project information** in: *Entering Requisition Distributions*, page 3-58.

**To enter line source details for the Supplier source type:**

- Navigate to the Source Details tabbed region. When the source type is Supplier, you can enter the Note to Buyer, Buyer, RFQ Required, Supplier Item number, source Document Type (Blanket, Contract, or Quotation), source Document, and document Line Number.

If you have chosen a global agreement as the source document the Global box will be checked and the owning organization displayed.

If Oracle Project Contracts is installed you can enter Contract number and Rev (version number) in this region. Additional project contract information can be entered in the Distributions window. See **To enter project information** in: *Entering Requisition Distributions*, page 3-58

**To enter line details:**

- Navigate to the Details tabbed region. You can enter a Justification, Note to Receiver, Transaction Nature, Reference Number, UN Number, and Hazard class. See: Defining Lookup Codes, page 1-55

**To enter line currency information:**

1. Navigate to the Currency tabbed region.
2. Enter a suggested currency for the requisition line. This must be an enabled code from the Currency window. The cursor enters the remaining currency fields only if you have entered a currency here. See: Defining Currencies, *Oracle General Ledger User's Guide*.
3. Purchasing supplies you with one of two predefined currency rate types: User or EMU Fixed. A rate type of User means that you can enter a conversion rate between the foreign currency (or transaction currency in a document entry window) and the base currency (or functional currency, defined in your ledger). A rate type of EMU Fixed means that if either your transaction currency or your functional currency is Euro (the European Monetary Unit currency) and the other is another European currency, Purchasing automatically enters a conversion Rate Date and Rate for you that you cannot change.

You can define additional currency rate types in the Define Daily Conversion Rate Types form, and you can enter User or one of your additional types. See: Defining Conversion Rate Types, *Oracle General Ledger User's Guide*.

4. Enter the currency rate date.
5. Enter the currency conversion rate. Purchasing overrides this default when you are entering requisition lines if the rate type is not User and if you have established a rate for the rate type and date. See: Entering Daily Rates, *Oracle General Ledger User's Guide*

**To enter outside processing information:**

- Select the Outside Services button to open the Outside Services window for outside processing line types. See: Entering Outside Services Information, page 4-79.

**To open the Supplier Item Catalog:**

- With the cursor in a requisition line row, select the Catalog button to open the Supplier Item Catalog. See: Overview of the Supplier Item Catalog, page 5-5.

**To enter requisition distributions:**

- Select the Distributions button to open the Distributions window. See: Entering Requisition Distributions, page 3-58.

**To view tax information:**

- After you have entered and saved all tax related information: Select Manage Tax from the Tools menu to see recoverable and nonrecoverable tax details for each line

and distribution. See: Viewing Tax Information, page 4-117

**To approve requisitions:**

- Select the Approval button to open the Approve Documents window. See: Submitting a Document for Approval, page 2-32

**To check funds:**

- Select Check Funds on the Tools menu. See: Reserving Funds for Requisitions, page 3-8

**To release reserved funds:**

- If budgetary controls are enabled, select Unreserve on the Tools menu. See: To Unreserve Funds, page 3-50.

**To enter requisition preferences:**

- Select Preferences on the Tools menu to open the Requisition Preferences window. See: Entering Requisition Preferences, page 3-44.

**Entering OPM line information:**

1. **Note:** Both Source and Destination organizations should be either process enabled or not process enabled.

If the OPM item is dual UOM controlled, then the Secondary UOM defaults to the value specified in the inventory item master table. You cannot change this field.

Depending on the selected dual UOM indicator, the Secondary Quantity is calculated.

- *Non-dual:* The secondary quantity is disabled.
  - *Fixed:* The secondary quantity is calculated using the conversion routine. You can change the secondary quantity and the primary Order Quantity is updated to reflect the change.
  - *Default:* The secondary quantity is calculated using the conversion routine. You can change the secondary quantity within the deviation limits specified in the item definition in OPM. The Primary Order Quantity is not updated to reflect the change.
  - *No default:* The secondary quantity is not calculated but you can enter the secondary quantity within the deviation limits specified in the item definition. The primary Order Quantity is not updated to reflect the change.
2. If the OPM item is grade controlled, then the Grade field is enabled and you can enter the grade. Grade represents the requested quality control grade for the selected item.

**Note:** All process items are flagged as Purchasable for use by Oracle Purchasing when they are synchronized to Oracle Inventory.

See the *Oracle Process Manufacturing Implementation Guide* for process item setup details.

## Related Topics

Overview of Requisitions, page 3-1

Using the Account Generator in Oracle Purchasing, page E-6

Entering Requisition Headers, page 3-48

Changing Encumbered Documents, page 4-113

## Entering Requisition Distributions

Use the Distributions window to enter requisition distributions or to view distributions that Purchasing has automatically created for you. You can charge the cost of this requisition line to multiple Accounting Flexfields or update the default values you provided in the Requisition Preferences window. Note that if the line source type is Inventory, you cannot approve the requisition if you enter more than one distribution line.

### To enter requisition distributions:

1. Navigate to the Distributions window by selecting the Distributions button in the Requisitions window. You begin in the Accounts tabbed region.



Num	Quantity	Charge Account	Recovery Rate	GL Date	Budget Account
1	10	01-510-7530-0000-000			

**Account Description**

Charge	Operations-Vision Operations In-Equi	Budget	
Accrual	Operations-No Department-Accounts	Variance	Operations-Vision Operations In-Equi

2. Enter the Quantity (Amount, if using Oracle Services Procurement) you want to distribute. The quantity must be in decimal format. Purchasing displays the quantity you have not yet assigned to an Accounting Flexfield. Multiple distribution quantities must total to the requisition line quantity.

Using decimal quantities in this field, you can easily distribute costs across distributions using percentages. For instance, you can have a simple quantity of one (1) on your requisition line. If you want to charge one Accounting Flexfield for 30% of the cost of the item and another Accounting Flexfield for 70% of the cost of the item, simply enter .3 and .7 as the respective quantities for the requisition distribution lines.

If you have a quantity different from one (1), you can use the Calculator to perform the arithmetic, as illustrated by the following example:

- Your requisition line quantity is 5000
  - You want to charge 35% of the cost to a first Accounting Flexfield
  - You want to charge 65% of the cost to a second Accounting Flexfield
  - Simply enter  $(5000 \times 35) / 100 = 1750$  as the quantity for the first requisition distribution and  $(5000 \times 65) / 100 = 3250$  as the quantity for the second requisition distribution.
3. When you enter a Charge Account, Purchasing uses the Account Generator to automatically create the following accounts for each distribution:
    - Accrual: the AP accrual account
    - Variance: the invoice price variance account

- If you are using encumbrance control, Purchasing also creates the following account for each distribution:

Budget: the encumbrance budget account

The Account Generator creates these accounts based on predefined rules. See: Using the Account Generator in Oracle Purchasing, page E-6.

With one exception, you cannot create or update these accounts manually. If the requisition line destination type is Expense, however, you can change the default charge account supplied by the Account Generator.

#### 4. Override the tax Recovery Rate for taxable items.

The recovery rate is the percentage of tax that your business can reclaim for credit. The recovery rate is based on the line in the Requisitions window and the setup in Oracle E-Business Tax .

You can change the recovery rate if the profile option *eBTax: Allow Override of Recovery Rate* is set to Yes. Depending on the setup in Oracle E-Business Tax, only certain recovery rates may be allowed.

You can choose to use a different recovery rate for different distributions, even if they use the same set of applicable tax.

For an overview of tax in Purchasing, see: Tax Information in Purchasing, page 4-116.

#### 5. Enter the GL Date that you want to use when you reserve funds. You can enter a GL Date only if you set up your financials options to use encumbrance for requisitions. The Reserved check box indicates whether funds have been reserved. The default is the current date. See: About Financials Options, *Oracle Payables User's Guide*.

If you enter a date that belongs to two separate accounting periods, Purchasing creates a journal entry in the first accounting period that contains this date. See: Controlling Purchasing Periods, page 1-82.

#### **To view tax information:**

- After you have saved the document: Select Manage Tax from the Tools menu to see the recoverable and nonrecoverable tax for each line and distribution. See: Viewing Tax Information, page 4-117.

#### **To release reserved funds:**

- If budgetary controls are enabled, select Unreserve on the Tools menu. See: To unreserve funds, page 3-50.

#### **Project tabbed region:**

- If your organization has implemented products dependant on project tracking information, you will see a Project Information tabbed region. Enter the required information. For instructions, see: Project Tab, page 3-47.

## Related Topics

Budgetary Control and Online Funds Checking, *Oracle General Ledger User's Guide*

Entering Requisition Lines, page 3-51

Changing Encumbered Documents, page 4-113

## Using Requisition Templates

From the Requisitions window, use the Supplier Item Catalog window and Requisition Templates to create requisitions more easily.

### To use requisition templates to enter requisitions:

1. Navigate to the Requisitions window by selecting Requisitions from the menu.
2. Enter requisition header information. See: Entering Requisition Headers, page 3-48.
3. Navigate to the Items tabbed region. See: Entering Requisition Lines, page 3-51
4. Select Catalog to open the Search Supplier Item Catalog window. See: Finding Supplier Items, page 5-9.
5. Select the desired Requisition Template from the list of values. See: Defining Requisition Templates, page 1-46.
6. Choose the Find button to open the Supplier Item Catalog window and display the template lines.
7. Copy the desired lines to the Order Pad. See: Using the Supplier Item Catalog Tabbed Regions, page 5-13.
8. Choose the Select button to close the Supplier Item Catalog window and transfer the order pad lines to the requisition.
9. Save your work.

## Related Topics

Overview of the Supplier Item Catalog, page 5-5



---

# Purchase Orders

## Overview of Purchase Orders

Purchasing provides the Purchase Orders window that you can use to enter standard and planned purchase orders as well as blanket and contract purchase agreements. You *must* be defined as a buyer to use this window. See: Entering Purchase Order Headers, page 4-40. See: Defining Buyers, page 1-20.

To create purchasing documents more quickly, use the AutoCreate Documents window. See: Autocreate Documents Overview, page 6-1.

Purchasing provides you the features you need to satisfy the following purchasing needs. You should be able to:

- Review all of your purchases with your suppliers to negotiate better discounts
- Create purchase orders simply by entering a supplier and item details
- Create standard purchase orders and blanket releases from both on-line and paper requisitions
- Quickly and effectively manage procurement in a global business environment using global agreements that can be shared across the entire enterprise
- Create accurate and detailed accounting information so that you charge purchases to the appropriate departments
- Check your funds availability while creating purchase orders
- Review the status and history of your purchase orders at any time for all the information you need
- Communicate purchase orders to suppliers flexibly using a number of options

- Inform your suppliers of your shipment schedule requirements
- Record supplier acceptances of your purchase orders. You always know whether your suppliers have received and accepted your purchase order terms and conditions
- Create your purchase orders by providing a quantity and price for each item you are ordering. Alternatively, you should also be able to create your purchase order simply by providing an amount if you are ordering a service that you cannot break down by price and quantity
- Create purchase orders that leverage flexible pricing structures or implement complex pricing from Oracle Advanced Pricing
- Copy purchase orders. See: Copying Purchase Orders, page 4-99.

## Purchase Order Types

Purchasing provides the following purchase order types: Standard Purchase Order, Planned Purchase Order, Blanket Purchase Agreement, and Contract Purchase Agreement. You can use the Document Name field in the Document Types window to change the names of these documents. For example, if you enter Regular Purchase Order in the Document Name field for the Standard Purchase Order type, your choices in the Type field in the Purchase Orders window will be Regular Purchase Order, Planned Purchase Order, Blanket Purchase Agreement, and Contract Purchase Agreement.

### Standard Purchase Orders

You generally create standard purchase orders for one-time purchase of various items. You create standard purchase orders when you know the details of the goods or services you require, estimated costs, quantities, delivery schedules, and accounting distributions. If you use encumbrance accounting, the purchase order may be encumbered since the required information is known.

### Blanket Purchase Agreements

You create blanket purchase agreements when you know the detail of the goods or services you plan to buy from a specific supplier in a period, but you do not yet know the detail of your delivery schedules. You can use blanket purchase agreements to specify negotiated prices for your items before actually purchasing them. Blanket purchase agreements can be created for a single organization or to be shared by different business units of your organization (global agreements). You can encumber funds for a blanket purchase agreement.

## **Global Blanket Agreements**

You may need to negotiate based on an enterprises' total global purchase volume to enable centralizing the buying activity across a broad and sometimes diverse set of businesses. Using global agreements (a special type of blanket purchase agreement), buyers can negotiate enterprise-wide pricing, business by business, then execute and manage those agreements in one central shared environment. Enterprise organizations can then access the agreement to create purchase orders that leverage pre-negotiated prices and terms. You can encumber funds for a global agreement.

## **Blanket Releases**

You can issue a blanket release against a blanket purchase agreement to place the actual order (as long as the release is within the blanket agreement effectivity dates). If you use encumbrance accounting, you can encumber each release.

## **Contract Purchase Agreements**

You create contract purchase agreements with your suppliers to agree on specific terms and conditions without indicating the goods and services that you will be purchasing. You can later issue standard purchase orders referencing your contracts, and you can encumber these purchase orders if you use encumbrance accounting.

## **Global Contract Agreements**

You can use global contract agreements (a special type of contract purchase agreement) to centralize a supplier relationship. Buyers throughout the enterprise can then leverage this relationship by referencing this global contract agreement in your standard purchase orders.

## **Planned Purchase Orders**

A planned purchase order is a long-term agreement committing to buy items or services from a single source. You must specify tentative delivery schedules and all details for goods or services that you want to buy, including charge account, quantities, and estimated cost.

## **Scheduled Releases**

You can issue scheduled releases against a planned purchase order to place the actual orders. If you use encumbrance accounting, you can use the planned purchase order to reserve funds for long term agreements. You can also change the accounting distributions on each release and the system will reverse the encumbrance for the planned purchase order and create a new encumbrance for the release.

## **Purchase Order Types Summary**

	<b>Standard Purchase Order</b>	<b>Planned Purchase Order</b>	<b>Blanket Purchase Agreement</b>	<b>Contract Purchase Agreement</b>
Terms and Conditions Known	Yes	Yes	Yes	Yes
Goods or Services Known	Yes	Yes	Yes	No
Pricing Known	Yes	Yes	Maybe	No
Quantity Known	Yes	Yes	No	No
Account Distributions Known	Yes	Yes	No	No
Delivery Schedule Known	Yes	Maybe	No	No
Can Be Encumbered	Yes	Yes	Yes	No
Can Encumber Releases	N/A	Yes	Yes	N/A

## Purchase Order Features

### AutoCreate

AutoCreate lets you compose a purchase order or a release from on-line requisitions in a few keystrokes. See: Autocreate Documents Overview, page 6-1.

### Workflow for Automatic Purchase Order and Release Creation

Purchasing uses Oracle Workflow technology to create purchase orders and releases automatically from approved requisition lines. Purchase orders and releases are created automatically only if the approved requisition lines are valid (for example, they contain valid source document information) and if the "Is Automatic Creation Allowed?" attribute in the Oracle Workflow Builder is set to 'Y' for Yes. (It is set to 'Y' by default.) See: Workflow for Creating Purchase Orders or Releases, page E-161. See: Choosing Workflow Options, page 1-85. See also: Automatic Release Generation, page 4-96.



## Accurate Accounting

You supply accounting information as part of your purchase order. You can allocate order line quantities and costs to cost centers, projects, or departments.

## On-line Funds Availability Checking

You can determine whether you have enough funds available in your budget before you complete a purchase order. You can check funds at the purchase order header, lines, shipments, distributions, and release levels. You can also check whether funds are available before you approve your purchase order. You can even set up your system setup options to prevent a buyer from approving a purchase order until sufficient funds are available.

To use on-line funds checking, you need to implement budgetary controls. You can check funds at the detail or summary level. You can also choose to check your funds for each period, quarter, or year. See: *Budgetary Control and Online Funds Checking, Oracle General Ledger User's Guide*

You can also unreserve funds that have been previously reserved. This can be done from the Tools menu in the document entry windows or the Approval window. Note that the GL date defaulted depends on the profile PO: Use Document GL Date to Unreserve.

## Revising Purchase Orders

To change a standard or planned purchase order, simply query this purchase order and enter your changes. You can provide additional paper requisition information to a standard purchase order. You can also revise blanket or contract purchase agreements. When you make changes to a purchase order or release, Purchasing's change order workflow processes determine whether or not the changes require reapproval and, if so, route the document for the necessary reapprovals. See: *Workflow Processes for Approving Change Orders*, page E-133.

To add on-line requisition lines to an existing standard purchase order or release, use AutoCreate. You can add requisition lines as a new purchase order line or add to an existing purchase order line. See: *Autocreate Document Options*, page 6-3.

When you change a purchase order, Purchasing automatically increments the revision number. See: *Document Revision Rules*, page 4-104.

## Shipment Schedules

You can create purchase order lines that have an unlimited number of ship-to locations and delivery dates. Each shipment line has a Ship-To Organization and Location, Promise-By Date, Need-By Date, and Last Accept Date. You receive goods and services against each shipment line.

## Acceptances

You can enter purchase order acceptances to verify that your suppliers have agreed to and accepted the details on the purchase orders you send to them. See: *Entering Purchase Order Acceptances*, page 4-82.

## Line Types

Purchasing uses Line Types to distinguish between items you order by quantity and price, and services that you order by amount. Line Types also serve to identify outside processing services for which Work in Process creates requisitions. See: *Defining Line Types*, page 1-62.

## Flexible Pricing

Prices can be manually entered or default into purchase orders from the item setup in Oracle Inventory, pricing information in a referenced purchase blanket agreement, or from more complex pricing rules set up in Oracle Advanced Pricing. To price a purchase order based on pricing rules setup in Oracle Advanced Pricing, its line need simply reference a contract purchase agreement. See: *Oracle Advanced Pricing User's Guide*.

In addition, purchase orders that reference blanket purchase agreements can have their prices automatically update through the Retroactive Price feature. See: *Retroactive Price Process*, page 13-34.

## Approving Purchase Orders

Purchasing checks purchase orders for accuracy and completeness before you communicate them to the supplier. You can submit purchase orders to the approval process from the Purchase Orders window before you communicate them. Also, you can use the Notifications Summary window to submit purchase orders for approval. See: *Submitting a Document for Approval*, page 2-32. See: *Viewing and Responding to Notifications*, page 2-29.

You can also assign an authorization limit to each buyer and decide whether you want to enforce this limit whenever any buyer approves a purchase order. See: *Overview of Purchasing Options*, page 1-33. See: *Defining Buyers*, page 1-20.

If you have implemented global supervisors (approvers), your purchase orders can be approved by any authorized approver within your global organization. See: *Center-Led Procurement Setup*, page 1-79.

## Communicating Purchase Orders to Suppliers

You can communicate purchase orders to the supplier at the time you approve them. (See: *Submitting a Document for Approval*, page 2-32.) Oracle Purchasing supports many communication methods depending on how your system is configured. These are:

- Print (paper or Adobe® PDF)
- Facsimile (fax)
- E-mail (HTML or Adobe® PDF)
- Extensible Markup Language (XML)
- Electronic Data Interchange (EDI)
- Online viewing (browser or Adobe® PDF)

You can also print purchase orders, change orders, and RFQs in other languages, if you use Multilingual Support (MLS). See: *Printed Purchase Order Overview*, page 8-3.

### **Copying Purchase Orders**

You can copy one purchase order to another. For example, if you want to renew a blanket purchase agreement with hundreds of lines, you can copy the previous agreement to a new document and change the effectivity dates. You can copy the following purchase order types:

- Standard purchase orders
- Blanket purchase agreements
- Planned purchase orders
- Global blanket agreements
- Global contract agreements

See: *Copying Purchase Orders*, page 4-99.

### **Cancelling Purchase Orders**

Purchasing lets you cancel a purchase order or purchase order line after you have approved it. When you cancel a purchase order or purchase order line, you pay only for those goods you received before cancellation, and you can optionally reassign any unfilled requisitions to another purchase order. See: *Controlling Documents*, page 2-57.

If you are using encumbrance or budgetary control and if you choose to cancel referencing requisitions, Purchasing creates negative debit entries in your general ledger system to cancel the encumbrance associated with the purchase order. Purchasing recreates encumbrances for the lines you used to create the purchase order, using the distributions from your cancelled purchase order. See: *Budgetary Control and Online Funds Checking*, *Oracle General Ledger User's Guide*.

## Closing and Final Closing Purchase Orders

Purchasing lets you automatically close a purchase order once you have received and paid for all items you ordered. This feature lets you conce

ntrate on those purchase orders that are overdue or partially received. You can also manually close purchase orders at any time. Of course, you always have the option to review or reopen a purchase order by adding new lines or creating additional receipt transactions until the purchase order is final closed. See: Controlling Documents, page 2-57.

If you designate an invoice as the final match to a purchase order, Payables final closes the purchase order shipment during Approval. You cannot update the status of a final-closed purchase order. See: Approval, *Oracle Payables User's Guide*.

If you are using encumbrance or budgetary control and if you choose to cancel referencing documents, Purchasing automatically creates credit entries in your general ledger system to reverse the encumbrance that corresponds to the purchase order you are final closing. See: Budgetary Control and Online Funds Checking, *Oracle General Ledger User's Guide*.

## Close for Receiving and Close for Invoicing

Purchasing automatically closes shipments for receiving and invoicing based on controls that you specify in the Purchasing Options window. Once all shipments for a given line are closed, Purchasing automatically closes the line. When all lines for a given header are closed, Purchasing automatically closes the document.

You can specify closing controls including: Receipt Close Tolerance, Receipt Close Point, and Invoice Close Tolerance. See: Defining Purchasing Options, page 1-33.

**Note:** The Close for Invoicing status does not prevent you from matching an invoice to a purchase order or a receipt.

## Holding and Freezing Purchase Orders

Purchasing lets you freeze a purchase order so that you can prevent changes or additions to it, but still receive and pay for goods already ordered. You can easily control your purchase order changes because you can freeze or unfreeze a purchase order when appropriate. Likewise, you can place a purchase order on hold to prevent all actions until you remove the order from hold. See: Controlling Documents, page 2-57

## Notification Controls (Using Oracle Alert)

For planned purchase orders, blanket purchase agreements, and contracts, you can establish expiration and release control notification conditions and specify the number of days before the condition is met that you want to be notified. In the Notification

Controls window, accessible through the Purchase Orders window, you can specify the following notification conditions:

- Amount released by date
- Amount not released by date
- Amount not released
- Amount released
- Expiration date

When the notification conditions are met, Purchasing sends you an Alert (or email) so that you can take appropriate action. See: *Entering Purchase Order Notification Controls*, page 4-80. See: *Using Oracle Alert in Oracle Purchasing*, page B-1.

### **Quick Access to Particular Purchase Orders**

You can place purchase orders that you reference frequently in the Oracle Applications Navigator. Placing documents in the Navigator is useful when you need to query large documents with multiple lines, shipments, or distributions. When the purchase order is open, choose Place on Navigator from the File menu. When you choose the Documents tabbed region in the Navigator, you can then access that document directly from within the Navigator. You can also do this with requisitions. See: *Using the Navigator's Documents Region*, *Oracle Applications User's Guide*.

**Note:** Once you place a document in the Navigator, it is the first thing you see in the Navigator the next time you log into Purchasing. Choose Functions to return to the Purchasing menu.

### **Viewing Changes to Purchase Orders**

You can view at a glance all past revisions made to archived purchase orders through the PO Change History menu item in the Oracle Purchasing Navigator. See: *Viewing Purchase Order Changes*, page 10-3.

### **Supplier Negotiation and Renegotiation using Oracle Sourcing**

If you have Oracle Sourcing enabled, you can initiate supplier negotiations directly from AutoCreate or initiate renegotiations with a supplier from the Purchase Order or Purchase Order Summary windows.

### **Contract Terms Management Using Oracle Procurement Contracts**

Oracle Procurement Contracts provides contract terms management capabilities for procurement professionals. Using a contract terms library, deliverables tracking, and formal change management, it extends Oracle Purchasing by offering embedded

contract negotiation, contract terms authoring, contract administration, and electronic contract signature capabilities.

If you license and implement Oracle Procurement Contracts, the following features are available in Oracle Purchasing:

- From the Purchase Order Terms window, you can author and manage contract terms, manage contract documents, view contract clauses and deliverables, and update deliverable statuses.
- The Purchase Order Summary window enables viewing purchase orders with details of contract terms clauses and deliverables as well as a supplier formatted purchase order with clauses, deliverables, and amendments.
- From the main menu, you can manage all of the contract deliverables assigned to you.
- The PO Change History window provides easy access to amendments to clauses, sections, deliverables, and changes to purchase order attributes.

## Purchase Order Defaulting Rules

Purchasing uses a *comprehensive* defaulting mechanism to provide most required purchase order information and minimize document creation time. For example, when you are entering a standard purchase order and you want only one shipment and distribution for each purchase order line, you do not need to navigate beyond the Lines tabbed region unless you want to change the default information in the shipments and distributions that Purchasing automatically creates.

Note that the Account Generator may be unable to build accounts for a number of reasons related to defaults. For example, if you have entered a one-time item and there is no default account for your user or category. In this case, you must enter distributions in the Distributions window.

## Purchase Order Default Matrix Conventions

The Purchase Order Default Matrix uses the following conventions:

- "Default" in this context means that Purchasing provides this information for you. It does not mean that you can always change the defaulted information.
- When options are listed as 1-2-3, Purchasing looks first for the option specified as 3. If new information is provided, or if information is not available in this source, Purchasing uses the next source. For example, when defaulting the currency to a standard purchase order header, Purchasing first provides the currency specified in the Financials Options window. When you specify a supplier, Purchasing updates the currency based on the supplier's default currency. Finally, when you specify a

supplier site, Purchasing updates the currency accordingly.

- For Releases, "Source Agreement" refers to Blanket Purchase Agreements or Planned Purchase Orders, as appropriate.
- The Last Acceptance Date is calculated using the Promised Date if available. Otherwise, Purchasing uses the Need-By date.
- Purchasing provides a GL Date only if you are using encumbrance.
- The following abbreviations are used in the matrix:
  - OSP Outside Processing
  - PO Opt Purchasing Options

***Purchase Order Header Defaulting Rules***

<b>Header Information</b>	<b>Standard</b>	<b>Planned</b>	<b>Blanket</b>	<b>Contract</b>	<b>Release</b>
Purchase Order Type	Value = "Standard"				Value = "Blanket"
Buyer	User name (must be buyer)	User name (must be buyer)	User name (must be buyer)	User name (must be buyer)	User name (must be buyer)
<b>Currency - 1</b>	Primary Ledger	Primary Ledger	Primary Ledger	Primary Ledger	Source Agreement (not changeable)
Currency - 2	Supplier	Supplier	Supplier	Supplier	
Currency - 3	Supplier Site	Supplier Site	Supplier Site	Supplier Site	
Supplier					Source Agreement (not changeable)

<b>Header Information</b>	<b>Standard</b>	<b>Planned</b>	<b>Blanket</b>	<b>Contract</b>	<b>Release</b>
Supplier Site	From supplier if only 1 "Purchasing" site exists	From supplier if only 1 "Purchasing" site exists	From supplier if only 1 "Purchasing" site exists	From supplier if only 1 "Purchasing" site exists	Source Agreement (not changeable)
Supplier Contact	From site if only 1 contact exists	From site if only 1 contact exists	From site if only 1 contact exists	From site if only 1 contact exists	
Confirm Order	Value = "No"	Value = "No"	Value = "No"	Value = "No"	
<b>Ship To Location - 1</b>	Financials Options	Financials Options	Financials Options	Financials Options	Source Agreement (not changeable)
Ship To - 2	Supplier	Supplier	Supplier	Supplier	
Ship To - 3	Supplier Site	Supplier Site	Supplier Site	Supplier Site	
<b>Bill To Location - 1</b>	Financials Options	Financials Options	Financials Options	Financials Options	Source Agreement (not changeable)
Bill To - 2	Supplier	Supplier	Supplier	Supplier	
Bill To - 3	Supplier Site	Supplier Site	Supplier Site	Supplier Site	
<b>Payment Terms - 1</b>	Financials Options	Financials Options	Financials Options	Financials Options	Source Agreement (not changeable)
Pay Terms- 2	Supplier	Supplier	Supplier	Supplier	
Pay Terms- 3	Supplier Site	Supplier Site	Supplier Site	Supplier Site	



<b>Header Information</b>	<b>Standard</b>	<b>Planned</b>	<b>Blanket</b>	<b>Contract</b>	<b>Release</b>
<b>Freight Terms - 1</b>	Financials Options	Financials Options	Financials Options	Financials Options	Source Agreement (not changeable)
Frt Terms - 2	Supplier	Supplier	Supplier	Supplier	
Frt Terms - 3	Supplier Site	Supplier Site	Supplier Site	Supplier Site	
<b>Ship Via - 1</b>	Financials Options	Financials Options	Financials Options	Financials Options	Source Agreement (not changeable)
Ship Via - 2	Supplier	Supplier	Supplier	Supplier	
Ship Via - 3	Supplier Site	Supplier Site	Supplier Site	Supplier Site	
<b>FOB - 1</b>	Financials Options	Financials Options	Financials Options	Financials Options	Source Agreement (not changeable)
FOB - 2	Supplier	Supplier	Supplier	Supplier	
FOB - 3	Supplier Site	Supplier Site	Supplier Site	Supplier Site	
Rate Type	Purchasing Options	Purchasing Options	Purchasing Options	Purchasing Options	Source Agreement (not changeable)
Effective Date					Source Agreement (not changeable)
Expiration Date					Source Agreement (not changeable)

<b>Header Information</b>	<b>Standard</b>	<b>Planned</b>	<b>Blanket</b>	<b>Contract</b>	<b>Release</b>
Minimum Release Amount		Purchasing Options	Purchasing Options		
Notification Control Expiration Date		Terms and conditions expiration date	Terms and conditions expiration date	Terms and conditions expiration date	
Acceptance Required	Value = "None"	Value = "None"	Value = "None"	Value = "None"	Value = "None"
<b>Transportation Arranged - 1</b>	Source Agreement		Source Agreement	Source Agreement	Source Agreement
Transportation Arranged- 2	Supplier Site		Supplier Site	Supplier Site	Source Agreement
Release Number					Existing number + 1
Release Date					Today's date

***Purchase Order Line Defaulting Rules***

<b>Line Information</b>	<b>Standard</b>	<b>Planned</b>	<b>Blanket</b>	<b>Contract</b>	<b>Release</b>
<b>Line Type</b>	Purchasing Options	Purchasing Options	Purchasing Options		
<b>Category - 1</b>	Line Type	Line Type	Line Type		
Category - 2	Item	Item	Item		
<b>UOM - 1</b>	Line Type	Line Type	Line Type		

<b>Line Information</b>	<b>Standard</b>	<b>Planned</b>	<b>Blanket</b>	<b>Contract</b>	<b>Release</b>
UOM - 2	Item	Item	Item		
Unit Price - 1	Line Type	Line Type	Line Type		
Unit Price - 2	List Price	List Price	List Price		
Unit Price - 3	Source document specified in Supplier-Item Attributes window	Source document specified in Supplier-Item Attributes window	Source document specified in Supplier-Item Attributes window		
UN Number	Item	Item	Item		
Hazard Class	Item	Item	Item		
OSP UOM Type	Item	Item	Item		
List Price	Item	Item	Item		
Market Price	Item	Item	Item		
Price Type	PO Preferences	PO Preferences	PO Preferences		
Allow Price Override		Value = "No"	Value = "No"		
Promised Date	PO Preferences	PO Preferences	PO Preferences		Source Agreement (not changeable)
Need-By Date	PO Preferences	PO Preferences	PO Preferences		Source Agreement (not changeable)

<b>Line Information</b>	<b>Standard</b>	<b>Planned</b>	<b>Blanket</b>	<b>Contract</b>	<b>Release</b>
Transaction Nature	PO Preferences	PO Preferences	PO Preferences		
Price Break Type			PO Preferences		

***Purchase Order Shipment Defaulting Rules***

<b>Shipment Information</b>	<b>Standard</b>	<b>Planned</b>	<b>Blanket</b>	<b>Contract</b>	<b>Release</b>
Ship-To Organization - 1					Financial System Options (blanket releases only)
Ship-To Org - 2	Financial System Options	Financial System Options	Agreement Header's Ship-To locations organization		Source Agreement (not changeable) (blanket releases only)
Ship-To Org - 3	PO Preferences - Validated against item	PO Preferences - Validated against item	Agreement Header's Ship-To locations organization		PO Preferences - Validated against item (blanket releases only)
Ship-To Location	PO Preferences - Validated against validated organization	PO Preferences - Validated against validated organization	Agreement Header		Source Agreement (not changeable)
<b>Promised Date - 1</b>	Lines	Lines	Lines		Lines

<b>Shipment Information</b>	<b>Standard</b>	<b>Planned</b>	<b>Blanket</b>	<b>Contract</b>	<b>Release</b>
Promised Date - 2	PO Preferences	PO Preferences	PO Preferences		PO Preferences
<b>Need-By Date - 1</b>	Lines	Lines	Lines		Lines
Need-By Date - 2	PO Preferences	PO Preferences	PO Preferences		PO Preferences
<b>Receipt Close Tolerance - 1</b>	Purchasing Options	Purchasing Options			Purchasing Options
Receipt Close - 2	Line Type	Line Type			Line Type
Receipt Close - 3	Item	Item			Item
<b>Invoice Close Tolerance - 1</b>	Purchasing Options	Purchasing Options			Purchasing Options
Invoice Close - 2	Item	Item			Item
<b>Invoice Matching (2, 3, 4 Way) - 1</b>	Purchasing Options	Purchasing Options			Purchasing Options
Invoice Match - 2	Supplier	Supplier			Supplier
Invoice Match - 3	Line Type	Line Type			Line Type
Invoice Match - 4	Item (Validation Org)	Item (Validation Org)			Item (Validation Org)
Invoice Match - 5	Item (Ship-To Org)	Item (Ship-To Org)			Item (Ship-To Org)

<b>Shipment Information</b>	<b>Standard</b>	<b>Planned</b>	<b>Blanket</b>	<b>Contract</b>	<b>Release</b>
<b>Accrue on Receipt - 1</b>	Else = Receipt Required Value	Else = Receipt Required Value			Else = Receipt Required Value
Accrue on Rct - 2	No, if Consigned Flag is checked				
Accrue on Rct - 3	No, if PO Opt expense accrual is "Period End"	No, if PO Opt expense accrual is "Period End"			No, if PO Opt expense accrual is "Period End"
Accrue on Rct - 4	Yes, if item is stockable in ship-to organization	Yes, if item is stockable in ship-to organization			Yes, if item is stockable in ship-to organization
Accrue on Rct - 5	Yes, if line type is OSP	Yes, if line type is OSP			Yes, if line type is OSP
<b>Enforce Ship-To Location - 1</b>	Receiving Options	Receiving Options			Receiving Options
Enforce Ship-To - 2	Supplier	Supplier			Supplier
Enforce Ship-To - 3	Item	Item			Item
<b>Allow Substitute Receipts - 1</b>	Receiving Options	Receiving Options			Receiving Options
Substitute Rct - 2	Supplier	Supplier			Supplier
Substitute Rct - 3	Item	Item			Item

<b>Shipment Information</b>	<b>Standard</b>	<b>Planned</b>	<b>Blanket</b>	<b>Contract</b>	<b>Release</b>
<b>Receipt Routing - 1</b>	Receiving Options	Receiving Options			Receiving Options
Receipt Routing - 2	Supplier	Supplier			Supplier
Receipt Routing - 3	Item	Item			Item
<b>Quantity Received Tolerance - 1</b>	Receiving Options	Receiving Options			Receiving Options
Qty Received - 2	Supplier	Supplier			Supplier
Qty Received - 3	Item	Item			Item
<b>Quantity Received Exception - 1</b>	Receiving Options	Receiving Options			Receiving Options
Rcvd Exception - 2	Supplier	Supplier			Supplier
Rcvd Exception - 3	Item	Item			Item
<b>Days Early Receipt Allowed - 1</b>	Receiving Options	Receiving Options			Receiving Options
Days Early Rct - 2	Supplier	Supplier			Supplier
Days Early Rct - 3	Item	Item			Item

<b>Shipment Information</b>	<b>Standard</b>	<b>Planned</b>	<b>Blanket</b>	<b>Contract</b>	<b>Release</b>
<b>Days Late Receipt Allowed - 1</b>	Receiving Options	Receiving Options			Receiving Options
Days Late Rct - 2	Supplier	Supplier			Supplier
Days Late Rct - 3	Item	Item			Item
<b>Last Accept Date</b>	Promised Date + Days Late Receipt Allowed	Promised Date + Days Late Receipt Allowed			Promised Date + Days Late Receipt Allowed
<b>Receipt Date Exception - 1</b>	Receiving Options	Receiving Options			Receiving Options
Receipt Dte Exc - 2	Supplier	Supplier			Supplier
Receipt Dte Exc - 3	Item	Item			Item
<b>Shipment Price</b>					Source Agreement (not changeable)
<b>Country of Origin - 1</b>	Supplier Site	Supplier Site			Supplier Site
Cntry of Origin - 2	Approved Supplier List	Approved Supplier List			Approved Supplier List (blanket releases only)
Consigned Flag	Approved Supplier List				



**Purchase Order Distribution Defaulting Rules**

<b>Distribution Information</b>	<b>Standard</b>	<b>Planned</b>	<b>Blanket</b>	<b>Contract</b>	<b>Release</b>
<b>Destination Type - 1</b>	If line type is OSP = "Shop Floor"	If line type is OSP = "Shop Floor"			If line type is OSP = "Shop Floor"
Destination Type - 2	If item stockable in ship-to org. = "Inventory"	If item stockable in ship-to org. = "Inventory"			If item stockable in ship-to org. = "Inventory"
Destination Type - 3	If item stockable in ship-to org, and purchasable and Accrue on Receipt is No = "Expense"	If item stockable in ship-to org, and purchasable and Accrue on Receipt is No = "Expense"			If item stockable in ship-to org, and purchasable and Accrue on Receipt is No = "Expense"
Destination Type - 4	If item is NOT stockable = "Expense"	If item is NOT stockable = "Expense"			If item is NOT stockable = "Expense"
<b>Requestor</b>	PO Preferences	PO Preferences			
<b>Deliver-To Location - 1</b>	PO Preferences if valid for ship-to org and item	PO Preferences if valid for ship-to org and item			Requestor's location
Deliver-To Loc - 2	Requestor's location	Requestor's location			Requestor's location
<b>Project Details</b>	PO Preferences	PO Preferences			PO Preferences

<b>Distribution Information</b>	<b>Standard</b>	<b>Planned</b>	<b>Blanket</b>	<b>Contract</b>	<b>Release</b>
<b>Rate Date</b>	PO Header	PO Header			Source Agreement (not changeable)
<b>GL Date</b>	PO Preferences	PO Preferences			Today's date if in valid period; else null
<b>Accounts</b>	Account Generator	Account Generator			Account Generator
<b>Recovery Rate</b>	Tax Code	Tax Code			Tax Code
<b>Requisition Information - 1</b>	PO Preferences	PO Preferences			
Requisition Information - 2	Source Requisition (Online)	Source Requisition (Online)			Source Requisition (Online)

## Related Topics

Defining Financials Options, *Oracle Payables User's Guide*

Suppliers, *Oracle iSupplier Portal Implementation Guide*.

Site Locations, *Oracle HRMS Enterprise and Workforce Management Guide*

Using the Account Generator in Oracle Purchasing, page E-6

Defining Purchasing Options, page 1-33

Defining Receiving Options, page 1-42

Profile Options in Purchasing, page C-1

Entering Purchase Order Shipments, page 4-67

Entering Purchase Order Distributions, page 4-75

## Finding Purchase Orders

Use the Find Purchase Orders window to:

- Access the Purchase Orders window.
- Access the Releases window.
- Perform purchase order inquiries at header, line, shipment, and distribution levels

Depending on the function security assigned to your responsibility, you have varying levels of access to information. A responsibility defines an application user's *current* privileges while working with Oracle Applications.

### To enter search criteria:

1. Navigate to the Find Purchase Orders window. Enter desired search criteria as described in the following steps.

The screenshot shows the 'Find Purchase Orders' window. The 'Operating Unit' is set to 'Vision Operations'. The search criteria section includes fields for Number, Release, Supplier, Ship-To Org, Bill-To, Ship-To, Line, and Shipment. On the right, there are fields for Type, Currency, Site, Line Type, and Buyer, along with checkboxes for 'Shgw External Locations', 'View Releases', 'Consumption Advice', 'Global Agreement', and 'With Contract Terms'. Below the search criteria is a tabbed interface with tabs for 'Line', 'Date Ranges', 'Status', 'Related Documents', 'Deliver To', 'Accounting', and 'Projects'. The 'Line' tab is active, showing fields for Item, Rev, Job, Category, Description, Supplier Item, VMI, and Consigned. To the right of the tabs is a 'Results' section with radio buttons for 'Headers', 'Lines', 'Shipments', and 'Distributions'. At the bottom, there are buttons for 'Clear', 'New Release (E)', 'New PO', and 'Find (J)'.

2. Select the Operating Unit for this search.
3. Enter the purchase order number. If you enter a purchase order number, you can also enter a Release, Line, and/or Shipment number for the purchase order.
4. Select the purchase order Type (Standard purchase order, Blanket purchase

agreement, Planned purchase order, Contract purchase agreement, Blanket Release, or Scheduled Release). Select the Global Agreement box to find just your global agreements.

5. Select the View Releases check box to include all associated releases for blanket purchase agreements and planned purchase orders. Purchasing automatically selects this check box if you specify selection criteria for which it would be required (for example, if you select Scheduled Releases as the purchase order Type). This check box is not available when inappropriate (for example, if you select Standard PO as the purchase order Type).
6. Enter the Currency.
7. Enter the Supplier. If you enter a supplier, you can also enter a supplier Site.
8. Enter the Ship To Organization.
9. Check Show External Locations to include locations not associated with this organization.
10. Enter the Bill To location.
11. Enter the Line Type.
12. Enter the Ship To location.
13. Enter the Buyer.
14. Enter the document Line number.
15. Check View Releases to include releases with the related blanket purchase agreement.
16. Enter the document Shipment number.
17. Check Consumption Advice to limit your results to purchase orders or releases which are created by the transfer of ownership of consigned stock in Oracle Inventory
18. Check Global Agreement to limit your results to global agreements that were either created in your operating unit or enabled for use in your operating unit.
19. If Oracle Procurement Contracts is implemented, select With Contract Terms to limit your results to purchase orders with contract terms.
20. Use the tabbed regions to further restrict the search:
  - In the Line region, you can enter the following search criteria: Item number,

Revision number, Job (Oracle Services Procurement), Category, item Description, Supplier Item Number, VMI (Yes or No), and Consigned (Yes or No).

- In the Date Ranges region, you can enter date ranges for the following dates: Order, Approved, Promised, Need By, and Closed.
  - In the Status region, you can limit the search by:
    - Order Approval status (Approved, In Process, Incomplete, Pre-Approved, Rejected, or Requires Reapproval)
    - Control status (Open, Closed, Finally Closed, Closed for Invoicing, Closed for Receiving, or Cancelled)
    - Hold status (Yes or No)
    - Frozen status (Yes or No)
    - Firmed status (Yes or No)
  - In the Related Documents region, you can limit the search by Contract number, Receipt number, Invoice number, Requisition number, Paper Requisition number, Supplier Quote number, and Source Document information (Type, Number, Line).
  - In the Deliver To region, you can limit the search by destination Type (Expense, Inventory, Shop Floor), Deliver To Person, Organization, Location, and Subinventory.
  - In the Accounting region, you can limit the search by Period, GL Date, Charge Account, Budget Account, and whether there are Active Encumbrances (Yes or No).
  - In the Projects region, you can limit the search by Project or Task number.
21. Select the Results summary window (Headers, Lines, Shipments, or Distributions). Depending on the search criteria you have specified, all summary windows may not be available. For example, if you specify criteria in the Accounting region, only the Purchase Order Distributions summary window is available.
22. Select the Find button to initiate the search and open the appropriate summary window.

**To clear existing search criteria:**

- Select the Clear button to clear any existing search criteria.

**To enter a new release:**

- Select the New Release button to open the Releases window. See: Entering Release Headers, page 4-84.

**To enter a new purchase order:**

- Select the New PO button to open the Purchase Orders window. See: Entering Purchase Order Headers, page 4-40.

**To enter purchase order preferences:**

- Select Preferences on the Tools menu to open the Purchase Order Preferences window. See: Entering Purchase Order Preferences, page 4-37.

## Related Topics

Function Security for Purchasing, page D-1

Overview of Purchase Orders, page 4-1

Using the Purchase Order Headers Summary Window, page 4-26

Using the Purchase Order Lines Summary Window, page 4-30

Using the Purchase Order Shipments Summary Window, page 4-32

Using the Purchase Order Distributions Summary Window, page 4-35

## Using the Purchase Order Headers Summary Window

Use the Purchase Order Headers results folder window to:

- View purchase order header information.
- Drill down to view purchase order line, shipment, and distribution information.
- Access the Purchase Orders and Releases windows for entry and update of documents.
- Access other windows from the Tools and Inquire menus.

Number	Release	Rev	Description	Type	Approval Status	Order Date
1003646		0		Standard Purc	Incomplete	16/JAN/200
1003640		0		Standard Purc	Approved	15/JAN/200
1003635		0		Standard Purc	Approved	15/JAN/200
1003632		0		Standard Purc	Approved	15/JAN/200
1003629		0		Standard Purc	Approved	15/JAN/200
1003627		0		Standard Purc	Approved	15/JAN/200
1003626		0		Standard Purc	Approved	15/JAN/200
1003623		0		Standard Purc	Approved	15/JAN/200
1003614		0		Standard Purc	Approved	15/JAN/200
1003608		0		Standard Purc	Incomplete	15/JAN/200

Buttons: Lines, New Release, New PO, Open

**To navigate to the Purchase Order Headers results window:**

- In the Find Purchase Orders window, select Headers in the Results region and select the Find button to open the Purchase Order Headers folder window.

**To drill down to view purchase order line information:**

- Select the Lines button to drill down to the Purchase Order Lines results folder window. You can also select View Lines on the Tools menu to open this window. See: Using the Purchase Order Lines Summary Window, page 4-30.

**To enter a new release:**

- Select the New Release button to open the Releases window. If the current record is a blanket purchase agreement or a planned purchase order, then you can create a release against it.

**Important:** Depending on how the Function Security is set for your user responsibility, you may not have access to the New Release button. (With Function Security, a system administrator can limit people's access to this function.)

**To enter a new purchase order:**

- Select the New PO button to open the Purchase Orders window. See: Entering Purchase Order Headers, page 4-40.

**Important:** Depending on how the Function Security is set for your user responsibility, you may not have access to the New PO button. (With Function Security, a system administrator can limit people's access to this function.)

**To open the Purchase Orders or Releases window for the current order:**

- Select the Open button to open the Purchase Orders window and query the purchase order on the current line. If the current order is for a blanket or scheduled release, Purchasing opens the Releases window and queries the current order. Your options in this window depend on the status of the order and your approval and security options. See: *Entering Purchase Order Headers*, page 4-40

**Important:** Depending on how the Function Security is set for your user responsibility, you may not have access to the Open button. For example the Open button will be enabled for global agreements only if they were created in your operating unit and if you have Manage Global Agreements function security. (With Function Security, a system administrator can limit people's access to this function.)

## Tools Menu Options

**To view acceptances:**

- Select Acceptances on the Tools menu to open the Enter Acceptances window. See: *Entering and Viewing Purchase Order Acceptances*, page 4-82.

**To enter purchase order control information:**

- Select Control on the Tools menu to open the Control Document window. See: *Controlling Documents*, page 2-57.

**To enter purchase order preferences:**

- Select Preferences on the Tools menu to open the Purchase Order Preferences window. See: *Entering Purchase Order Preferences*, page 4-37.

**To copy a purchase order:**

- Select the document you want to copy and then select Copy Document from the Tools menu. See: *Copying Purchase Orders*, page 4-99.

**To renegotiate blanket agreements in Oracle Sourcing:**

- Select the blanket purchase agreement you wish to renegotiate in the Purchase Order Headers window and then select either Create Auction or Create Sourcing RFQ from the Tools menu. See the Oracle Sourcing online help for more details.

**To respond to supplier changes to a purchase order:**

- If you have selected a purchasing document for which there are pending changes from the supplier, then select Respond to Changes on the Tools menu.

**To see the revision history for a purchase order:**

1. Select Change History from the Tools menu to view the revisions to the archived purchase order you selected in the Purchase Order Headers window. See: *Viewing Purchase Order Changes*, page 10-3



**To communicate the purchase order to the supplier:**

1. Select an approved purchase order and then select Communicate from the Tools menu.
2. In the Communicate window select the method that you would like to use to communicate this purchase order to the supplier.
3. Enter the Fax number or Email address as needed.
4. Click OK to send the purchase order.

You can also communicate purchase orders to the supplier at the time you approve them. See: Submitting a Document for Approval, page 2-32. See: Communicating Purchase Orders to Suppliers, page 4-6.

## **Inquire Menu Options**

**To navigate to the Purchase Order Lines results window:**

- In the Find Purchase Orders window, select Lines in the Results region and select the Find button to open the Purchase Order Lines folder window. You can also navigate to this window by selecting View Lines on the Inquire menu in the Purchase Order Headers results folder window.

**To drill down to view purchase order shipment information:**

- Select View Shipments on the Inquire menu to open the Purchase Order Shipments results folder window. See: Using the Purchase Order Shipments Summary Window, page 4-32.

**To drill down to view purchase order distributions information:**

- Select View Distributions on the Inquire menu to open the Purchase Order Distributions results folder window. See: Using the Purchase Order Distributions Summary Window, page 4-35.

**To view action history:**

- Select View Action History on the Inquire menu to open the Action History window. See: Viewing Action History, page 10-1.

**To view invoices:**

- Select Invoices on the Inquire menu to view invoice information: See: Invoice Overview (Payables), *Oracle Payables User's Guide*.

**To view receipts:**

- Select View Receipts on the Inquire menu to open the Find Receiving Transactions window. See: Finding Receiving Transactions (Summary), page 9-41.

**To view requisitions:**

- Select View Requisitions on the Inquire menu to open the Requisition Summary window. See: Using the Requisition Headers Summary Window, page 3-39.

**To view approval status in Workflow:**

- Select View Approval through Workflow on the Inquire menu to open the Workflow approval process view window.

**To view project contract information:**

- If Oracle Project Contracts is implemented, you can select View Project Contract Information on the Inquire menu to open the Project Information window.

**To view contract terms:**

- If Oracle Procurement Contracts is implemented, you can select View Contract Terms on the Inquire menu to open the Contract Terms window.

**To view the formatted purchase order:**

- Select View Document on the Inquire menu to see the purchase order in the format that will be communicated to the supplier. You can also view the purchase order in the supplier site language.

**To view procurement card information:**

- In the Purchase Order Headers summary window, which is a folder window, display the hidden field P-Card Number. See: Procurement Card Purchase Orders and Releases, page 4-118.

## Related Topics

Customizing the Presentation of Data in a Folder, *Oracle Applications User's Guide*

Overview of Purchase Orders, page 4-1

Finding Purchase Orders, page 4-23

Using the Purchase Order Lines Summary Window, page 4-30

Using the Purchase Order Shipments Summary Window, page 4-32

Using the Purchase Order Distributions Summary Window, page 4-35

## Using the Purchase Order Lines Summary Window

Use the Purchase Order Lines results folder window to:

- View purchase order line information.
- Drill down to view purchase order shipment and distribution information.
- Access the Purchase Orders and Releases windows for entry and update of documents.
- Access other windows from the Tools and Inquire menus.

**To navigate to the Purchase Order Lines results window:**

- In the Find Purchase Orders window, select Lines in the Results region and select the Find button to open the Purchase Order Lines folder window. You can also navigate to this window by selecting View Lines on the Inquire menu in the Purchase Order Headers results folder window.

**To drill down to view purchase order shipment information:**

- Select the Shipments button to drill down to the Purchase Order Shipments results folder window. You can also select View Shipments on the Inquire menu to open this window. See: Using the Purchase Order Shipments Summary Window, page 4-32.

**To enter a new release:**

- Select the New Release button to open the Releases window. If the current record is a blanket purchase agreement or a planned purchase order, then you can create a release against it.

**To enter a new purchase order:**

- Select the New PO button to open the Purchase Orders window. See: Entering Purchase Order Headers, page 4-40.

**To open the Purchase Orders or Releases window for the current line:**

- Select the Open button to open the Purchase Orders window and query the purchase order on the current line. If the current line is for a blanket or scheduled release, Purchasing opens the Releases window and queries the current line. Your options in this window depend on the status of the order and your approval and security options. See: Entering Purchase Order Headers, page 4-40.

**To view acceptances:**

- Select Acceptances on the Tools menu to open the Enter Acceptances window. See: Entering and Viewing Purchase Order Acceptances, page 4-82.

**To enter purchase order control information:**

- Select Control on the Tools menu to open the Control Document window. See: Controlling Documents, page 2-57.

**To enter purchase order preferences:**

- Select Preferences on the Tools menu to open the Purchase Order Preferences window. See: Entering Purchase Order Preferences, page 4-37.

**To communicate the purchase order to the supplier:**

- Select an approved purchase order and then select Communicate from the Tools menu. In the Communicate window select the method that you would like to use to communicate this purchase order to the supplier. Enter the Fax number or Email address as needed. Click OK to send the purchase order. You can also communicate purchase orders to the supplier at the time you approve them. See: Submitting a Document for Approval, page 2-32.

**To drill down to view purchase order distributions information:**

- Select View Distributions on the Inquire menu to open the Purchase Order Distributions results folder window. See: *Using the Purchase Order Distributions Summary Window*, page 4-35.

**To view action history:**

- Select View Action History on the Inquire menu to open the Action History window. See: *Viewing Action History*, page 10-1.

**To view invoices:**

- Select View Invoices on the Inquire menu to view invoice information: See: *Invoice Overview, Oracle Payables User's Guide*.

**To view receipts:**

- Select View Receipts on the Inquire menu to open the Find Receiving Transactions window. See: *Finding Receiving Transactions (Summary)*, page 9-41.

**To view Oracle Project Contract information:**

- If Oracle Project Contracts is implemented, you can select View Project Contract Information on the Inquire menu to open the Projects Information window.

**To view approval status in Workflow:**

- Select View Approval through Workflow on the Inquire menu to open the Workflow approval process view window.

**To view contract terms:**

- If Oracle Procurement Contracts is implemented, you can select View Contract Terms on the Inquire menu to open the Contract Terms window.

**To view the formatted purchase order:**

- Select View Document on the Inquire menu to see the purchase order in the format that will be communicated to the supplier.

## Related Topics

Customizing the Presentation of Data in a Folder, *Oracle Applications User's Guide*

Overview of Purchase Orders, page 4-1

Finding Purchase Orders, page 4-23

Using the Purchase Order Headers Summary Window, page 4-26

Using the Purchase Order Shipments Summary Window, page 4-32

Using the Purchase Order Distributions Summary Window, page 4-35

## Using the Purchase Order Shipments Summary Window

Use the Purchase Order Shipments results folder window to:

- View purchase order shipment information.
- Drill down to view purchase order distribution information.
- Access the Purchase Orders and Releases windows for entry and update of documents.
- Access other windows from the Tools and Inquire menus.

Note that this window does not display price breaks.

**To navigate to the Purchase Order Shipments results window:**

1. In the Find Purchase Orders window, select Shipments in the Results region and select the Find button to open the Purchase Order Shipments folder window. You can also navigate to this window by selecting View Shipments on the Tools menu in the Purchase Order Headers and Purchase Order Lines results folder windows.

**To drill down to view purchase order distribution information:**

- Select the Distributions button to drill down to the Purchase Order Distributions results folder window. You can also select View Distributions on the Tools menu to open this window. See: Using the Purchase Order Distributions Summary Window, page 4-35.

**To enter a new release:**

- Select the New Release button to open the Releases window. If the current record is a blanket purchase agreement or a planned purchase order, then you can create a release against it.

**To enter a new purchase order:**

- Select the New PO button to open the Purchase Orders window. See: Entering Purchase Order Headers, page 4-40.

**To open the Purchase Orders or Releases window for the current shipment:**

- Select the Open button to open the Purchase Orders window and query the purchase order shipment on the current line. If the current shipment is for a blanket or scheduled release, Purchasing opens the Releases window and queries the current shipment. Your options in this window depend on the status of the order and your approval and security options. See: Entering Purchase Order Headers, page 4-40.

**To view acceptances:**

- Select Acceptances on the Tools menu to open the Enter Acceptances window. See: Entering and Viewing Purchase Order Acceptances, page 4-82.

**To enter purchase order control information:**

- Select Control on the Tools menu to open the Control Document window. See: Controlling Documents, page 2-57.

**To enter purchase order preferences:**

- Select Preferences on the Tools menu to open the Purchase Order Preferences window. See: Entering Purchase Order Preferences, page 4-37.

**To communicate the purchase order to the supplier:**

- Select an approved purchase order and then select Communicate from the Tools menu. In the Communicate window select the method that you would like to use to communicate this purchase order to the supplier. Enter the Fax number or Email address as needed. Click OK to send the purchase order. You can also communicate purchase orders to the supplier at the time you approve them. See: Submitting a Document for Approval, page 2-32.

**To view action history:**

- Select View Action History on the Inquire menu to open the Action History window. See: Viewing Action History, page 10-1.

**To view invoices:**

- Select View Invoices on the Inquire menu to view invoice information: See: Invoice Overview, *Oracle Payables User's Guide*.

**To view receipts:**

- Select View Receipts on the Inquire menu to open the Find Receiving Transactions window. See: Finding Receiving Transactions (Summary), page 9-41.

**To view the requisitions for this shipment:**

- Select View Requisitions on the Inquire menu to open the Requisition Lines Summary window. See: Using the Requisition Lines Summary Window, page 3-40.

**To view approval status in Workflow:**

- Select View Approval through Workflow on the Inquire menu to open the Workflow approval process view window.

**To view contract terms:**

- If Oracle Procurement Contracts is implemented, you can select View Contract Terms on the Inquire menu to open the Contract Terms window.

**To view the formatted purchase order:**

- Select View Document on the Inquire menu to see the purchase order in the format that will be communicated to the supplier.

## Related Topics

Customizing the Presentation of Data in a Folder, *Oracle Applications User's Guide*

Overview of Purchase Orders, page 4-1

Finding Purchase Orders, page 4-23

Using the Purchase Order Headers Summary Window, page 4-26

Using the Purchase Order Lines Summary Window, page 4-30

Using the Purchase Order Distributions Summary Window, page 4-35

## Using the Purchase Order Distributions Summary Window

Use the Purchase Order Distributions results folder window to:

- View purchase order distribution information.
- Access the Purchase Orders and Releases windows for entry and update of documents.
- Access other windows from the Tools and Inquire menus.

### **To navigate to the Purchase Order Distributions results window:**

- In the Find Purchase Orders window, select Distributions in the Results region and select the Find button to open the Purchase Order Distributions folder window. You can also navigate to this window by selecting View Distributions on the Tools menu in the Purchase Order Headers, Purchase Order Lines, and Purchase Order Shipments results folder windows.

### **To enter a new release:**

- Select the New Release button to open the Releases window. If the current record is a blanket purchase agreement or a planned purchase order, then you can create a release against it.

### **To enter a new purchase order:**

- Select the New PO button to open the Purchase Orders window. See: Entering Purchase Order Headers, page 4-40.

### **To open the Purchase Orders or Releases window for the current line:**

- Select the Open button to open the Purchase Orders window and query the purchase order on the current line. If the current line is for a blanket or scheduled release, Purchasing opens the Releases window and queries the current line. Your options in this window depend on the status of the order and your approval and security options. See: Entering Purchase Order Headers, page 4-40.

### **To view acceptances:**

- Select Acceptances on the Tools menu to open the Enter Acceptances window. See: Entering and Viewing Purchase Order Acceptances, page 4-82.

### **To enter purchase order preferences:**

- Select Preferences on the Tools menu to open the Purchase Order Preferences window. See: Entering Purchase Order Preferences, page 4-37.

### **To communicate the purchase order to the supplier:**

- Select an approved purchase order and then select Communicate from the Tools

menu. In the Communicate window select the method that you would like to use to communicate this purchase order to the supplier. Enter the Fax number or Email address as needed. Click OK to send the purchase order. You can also communicate purchase orders to the supplier at the time you approve them. See: Submitting a Document for Approval, page 2-32.

**To view action history:**

- Select View Action History on the Inquire menu to open the Action History window. See: Viewing Action History, page 10-1.

**To view invoices:**

- Select View Invoices on the Inquire menu to view invoice information: See: Invoice Overview, *Oracle Payables User's Guide*.

**To view receipts:**

- Select View Receipts on the Inquire menu to open the Find Receiving Transactions window. See: Finding Receiving Transactions (Summary), page 9-41.

**To view Oracle Projects information:**

- If Oracle Projects is implemented, you can select View Project Information on the Inquire menu to open the Projects Information window.

**To view approval status in Workflow:**

- Select View Approval through Workflow on the Inquire menu to open the Workflow approval process view window.

**To view contract terms:**

- If Oracle Procurement Contracts is implemented, you can select View Contract Terms on the Inquire menu to open the Contract Terms window.

**To view the formatted purchase order:**

- Select View Document on the Inquire menu to see the purchase order in the format that will be communicated to the supplier.

## Related Topics

Customizing the Presentation of Data in a Folder, *Oracle Applications User's Guide*

Overview of Purchase Orders, page 4-1

Finding Purchase Orders, page 4-23

Using the Purchase Order Headers Summary Window, page 4-26

Using the Purchase Order Lines Summary Window, page 4-30

Using the Purchase Order Shipments Summary Window, page 4-32



## Entering Purchase Order Preferences

Use the Purchase Order Preferences window to enter preference information for purchase order lines, shipments, distributions, and releases. You can save time and effort by entering valid default values here. When you save your work in the Lines tabbed region in the Purchase Orders window, Purchasing creates a shipment using the organization and ship-to location if you provided valid values in the defaults region. Then, if it is successful in creating a shipment, Purchasing creates a distribution using these values. Similarly, when you save your work in the Purchase Order Shipments window, Purchasing creates a distribution if it does not already exist and if you provided a valid organization here. You can update these shipments and distributions by navigating to the Purchase Order Shipments or Purchase Order Distributions windows.

Purchasing can create shipments only when it has default information that meets the following criteria:

- There must be an organization and a location.
- The location must belong to the organization or not be assigned to any organization.
- If the line contains an item (and optionally a revision), that item (and revision) must be valid in the default shipment organization.

Purchasing can create distributions only when it has default information that meets the following criteria:

- If the Destination Type is Inventory, the line must have an item that is stock enabled in the ship-to organization. Also, if a default subinventory has been entered, it must be defined in the ship-to organization.
- The Account Generator must be able to supply the accounts. If the Destination Type is Expense, you can enter a default charge account, which overrides any account supplied by the Account Generator.
- If you are using encumbrance accounting, you must enter a default GL date.

Purchasing uses the preferences you enter in this window for the current line and all subsequent purchase order lines that you enter during this user session. Thus, for existing purchase orders, the defaults apply only to new lines, shipments, and distributions that you add during this session. If you want to clear the default information, either choose Delete Record in the Purchase Order Preferences window or exit the application. The default values are only valid for the session in which you are currently working. They are not saved to the database.

### **To enter main preferences:**

1. Navigate to the Purchase Order Preferences window by selecting Preferences on the

Tools menu in most of the purchase orders and releases windows.

The screenshot shows a software window titled "Purchase Order Preferences (Vision Operations)". It has two tabs: "Main" and "Project Information". The "Main" tab is active and contains the following fields:

- Confirming Order
- Price Type:
- Contract:
- Need-By:
- Requisition:
- Organization:
- Destination Type:
- Requester:
- Location:
- Subinventory:
- Minimum Release Amount:
- Transaction Nature:
- Promised:
- Requisition Line:
- Charge Account:
- Ship-To:

An "Apply" button is located at the bottom right of the window.

In the Main tabbed region, you can enter the defaults described in the following steps.

2. Select Confirming Order to indicate that this order is confirming a previous informal order with the supplier.
3. Enter a Price Type from the Lookup Codes window. See: Defining Lookup Codes, page 1-55.
4. For planned purchase orders and blanket purchase agreements, enter the Minimum Release Amount for a line.
5. If you are referencing contract purchase agreement on a standard purchase order, enter the Contract number. The contract must be effective; that is, the current date has to be within the effective date and the expired date of the contract.

If you reference a contract purchase agreement on a standard purchase order line, Purchasing adds the total amount of the purchase order line to the total amount of the contract.

6. Enter the Transaction Nature. See: Defining Lookup Codes, page 1-55.
7. Enter the Need By date and time when the requestor needs the item..

If you are using Purchasing with Master Scheduling/MRP, you must provide either a need-by date or a promised-by date for shipments that correspond to purchase order lines with Master Scheduling/MRP planned items. A need-by date is also

required for Inventory planned items. See: Overview of Implementing Planning Recommendations, *Oracle Master Scheduling/MRP and Supply Chain Planning User's Guide*.

8. Enter the Promised By date and time when the supplier promised delivery of the items.
9. Enter the paper Requisition Number for all distributions. Purchasing automatically copies this number to every distribution you create for this purchase order line. You can later review purchase orders based on paper requisitions using the Find Purchase Orders window. If you enter a requisition number, you can also enter a Requisition Line number. See: Finding Purchase Orders, page 4-23.
10. Enter the date you want to post expenses in your General Ledger for every distribution you create for this purchase order line. You can enter a GL Date only if you set up your financials system options to use encumbrance for purchase orders. See: About Financials Options, *Oracle Payables User's Guide*. See: Budgetary Control and Online Funds Checking, *Oracle General Ledger User's Guide*.
11. Enter the Accounting Flexfield that you want to charge for the expenses. Purchasing uses the account you enter here only for expense destinations within your operating unit and overrides any account built by the Account Generator. See: Using the Account Generator in Oracle Purchasing, page E-6.
12. Enter the organization. The List of Values displays all valid receiving organizations.
13. Enter the ship-to location for the shipment.
14. Enter the Destination type to indicate the final destination of the purchased items:
  - *Expense* - The goods are delivered to the requestor at an expense location. The destination subinventory is not applicable.
  - *Inventory* - The goods are received into inventory upon delivery.
15. Enter the Requestor. This is the employee who requests the quantities on the purchase order distribution lines. Purchasing copies this name as the requestor for every distribution you create for this purchase order line.
16. Enter the Deliver To location for all distributions. Purchasing copies this location to every distribution you create for this purchase order line. The default is the requestor's location. You can pick any location that does not have an organization or any location whose organization matches the ship-to organization. See: Enter Person, *Oracle HRMS Enterprise and Workforce Management Guide*. See: Defining Locations, page 1-18.
17. If the destination type is Inventory, you can enter the Subinventory. See: Defining

Subinventories, *Oracle Inventory User's Guide*.

**To apply your preference changes:**

- Select the Apply button to apply your changes.

**Project tabbed region**

- If your organization has implemented Oracle Projects, Oracle Project Manufacturing, or Oracle Grants use the Project tabbed region to enter additional information for those products. See: Project Tab, page 3-47

## Related Topics

Entering Purchase Order Lines, page 4-46

Entering Purchase Order Shipments, page 4-67

Entering Purchase Order Distributions, page 4-75

Overview of Purchasing Options, page 1-33

Purchase Order Defaulting Rules, page 4-10

## Entering Purchase Order Headers

Use the Purchase Orders window to:

- Enter standard and planned purchase orders as well as blanket and contract purchase agreements

**Note:** You can also receive blanket purchase agreement lines electronically from your suppliers through the Purchasing Documents Open Interface. See: Receiving Price/Sales Catalog Information Electronically, page 5-18.

- Enter purchase orders from paper requisitions or without a requisition
- Take approval actions on individual purchase orders and agreements on-line

If you want to create a release against a planned purchase order or a blanket purchase agreement, use the Enter Releases window. See: Entering Release Headers, page 4-84.

If you want to place on-line requisitions onto a new or existing purchase order, use the AutoCreate Documents window. See: Autocreate Documents Overview, page 6-1.

**To enter purchase order headers:**

1. Navigate to the Purchase Orders window:
  - by selecting the New PO button in the Find Purchase Orders window or any of its results windows

- by selecting the Open button in any of the Find Purchase Order results windows
- by selecting the Open button and then double-clicking the Open Documents icon in the Notifications Summary window when the current line is a purchase order
- if the PO: Display the AutoCreated Document profile option is set to Yes, Purchasing opens the Purchase Orders window when you have completed AutoCreation of a purchase order. See: Profile Options in Purchasing, page C-1.

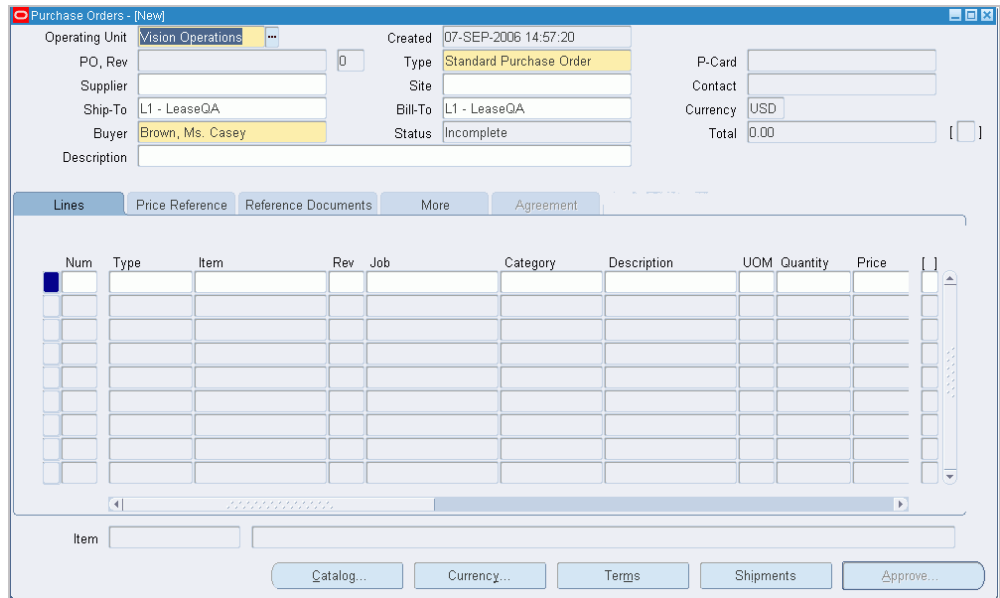

2. Select the Operating Unit for this purchase order.
3. The upper part of the Purchase Orders window has the following display-only fields:

*Created* - The system date is displayed as the creation date.

*Status* - Possible order status values are: Incomplete - The order has not been approved. Approved - You have approved the order. You can print it and receive items against it. Requires Reapproval - You approved the order and then made changes that require you to reapprove it.

*Total* - For standard and planned purchase orders, Purchasing displays the current Total order amount.

*Amount Agreed* - For blanket and contract purchase agreements only, Purchasing displays the agreed-to amount for the agreement. The amount Released value should not exceed the Amount Agreed. (Note also that if you change the Amount

Limit in the Terms and Conditions window, the Amount Agreed should be equal to or less than the Amount Limit.)

*Released* - For blanket and contract purchase agreements only, Purchasing displays the current total amount Released. The amount released is 0.00 until you create releases against the blanket purchase agreement or reference the contract on a standard purchase order.

*Currency* - Purchasing displays the functional currency. This is overridden by supplier currency information.

*P-Card* - Purchasing displays a procurement card number if the purchase order was created from an iProcurement requisition that used a corporate credit card for the purchase. This field displays if the profile option *PO: Use P-Cards in Purchasing* is set to Yes. Only the last four digits are displayed. Procurement cards can be used for items with a Destination Type of Expense, for documents that do not contain a Project number, and for standard purchase orders or releases only.

4. Select the Operating Unit for this purchase order.
5. Enter a unique Purchase Order number. The Revision is displayed to the right of the number. If you chose automatic purchase order number generation in your Purchasing Options, the cursor does not enter this field and the number is generated when you save your work.
6. Choose the purchase order Type: Standard Purchase Order, Planned Purchase Order, Blanket Purchase Agreement, Contract Purchase Agreement. See: Purchase Order Types, page 4-2.

**Important:** The names of the above purchase order types can be modified in the Document Types window. See: Defining Document Types, page 1-67.

7. Enter the name of the Supplier for this purchase order. To approve a purchase order, you must provide a supplier.

**Important:** You cannot change the supplier once you approve the purchase order. The purchase order becomes a legal document when you approve it. To change the supplier after you approve a purchase order, you must cancel the existing purchase order and create a new one for the other supplier.

8. Enter the Site of the supplier you want to use for your purchase order. If the supplier you choose has only one site, it is defaulted into this field. Before you can approve a purchase order, you must provide a site. Once the purchase order is approved, you can change the supplier site only if the PO: Change Supplier Site

profile option is set to Yes. And only sites with the same currency as the previous site can be used. If you change the supplier site, the revision will be incremented, and will require reapproval. You cannot enter the supplier site until you have entered a supplier.

You can optionally enter the name of the Contact at the supplier site. If the supplier you choose has only one contact name, it is defaulted into this field. You cannot enter a contact until you have entered a supplier site.

9. Enter the Ship To and Bill To locations for the purchase order. If you entered a supplier and supplier site, the Ship To and Bill To defaults reflect the locations you assigned to the supplier or supplier site. You can accept these values or change them to other locations. See: Purchase Order Defaulting Rules, page 4-10
10. If the Enforce Buyer Name option in your Purchasing Options is set to Yes, your name is displayed as the Buyer, and you cannot change this value. Otherwise, you can enter the name of any buyer. See: Defining Control Options, page 1-34.
11. For blanket and contract purchase agreements only, enter the total Amount Agreed. This is the amount you have agreed to spend with the supplier.
12. Enter a Description of the purchase order. These comments are for internal use only and do not print on the purchase order. You can enter up to 240 characters. If you want to add unlimited notes, use the Attachments feature. See: Attaching Notes to Purchasing Documents, page 1-33.
13. For blanket or contract purchase agreements, check the Global box to indicate that this is a global agreement that can be assigned to other operating units. This checkbox cannot be deselected once you have saved the document. See: Entering Purchase Agreement Information, page 4-55.
14. For standard and planned purchase orders and blanket purchase agreements, enter line information for the header you have just created. See: Entering Purchase Order Line Information, page 4-46.

**To open the Supplier Item Catalog:**

- Select the Catalog button to open the Supplier Item Catalog. See: Overview of the Supplier Item Catalog, page 5-5.

**To enter currency information:**

- Select the Currency button to open the Purchase Order Currency window. See: Entering Currency Information, page 4-60.

**To enter additional purchase order details information:**

- Select the Terms button to open the Terms and Conditions window. See: Entering Purchase Order Details Information, page 4-61.

**To enter shipment information:**

- Select the Shipments button to open the Purchase Order Shipments window. See: Entering Purchase Order Shipments, page 4-67.

**To enter price break information:**

- For blanket purchase agreements, you can select the Price Break button to open the Price Breaks window. See: Entering Purchase Agreement Price Break Information, page 4-73.

**To take approval actions:**

- Select the Approval button to open the Approve Documents window. See: Submitting a Document for Approval, page 2-32.

**To disable Payment on Receipt for the purchase order:**

- Select the Terms button. In the Pay On field, choose Null to disable Payment on Receipt for this document. Choose Receipt to enable Payment on Receipt. The Pay On field is disabled if the supplier site is not a Payment on Receipt site. See: Entering Purchase Order Details Information, page 4-61.

## Tools Menu Options

**To enter purchase order preferences:**

- Select Preferences on the Tools menu. See: Entering Purchase Order Preferences, page 4-37

**To enter notification controls:**

- Select Notification Control on the Tools menu (For planned purchase orders, contract purchase agreements, and blanket purchase agreements). See: Entering Purchase Order Notification Controls, page 4-80.

**To check funds:**

- Select Check Funds on the Tools menu. See: Online Funds Availability Checking, page 4-4

**To enter or view acceptances:**

- Select Acceptances on the Tools menu to open the Acceptances window. See: Entering and Viewing Purchase Order Acceptances, page 4-82

**To copy a purchasing document:**

- Select Copy Document from the Tools menu. See: Copying Purchase Orders: , page 4-99

**To renegotiate a blanket purchase agreement in Oracle Sourcing:**

- Select Create Buyer's Auction or Create Sourcing RFQ from the Tools menu.

**To release encumbered funds:**

1. If budgetary controls are enabled you can release encumbered funds for your



purchase order. See: Online Funds Availability Checking, page 4-5

2. Select Unreserve from the Tools menu.
3. Enter the Unreserve Date.
4. Check Use Document GL Date to Unreserve to use the document's distribution GL dates for the funds reversal instead of the unreserve date.
5. Click OK to reverse the the funds reservation on this document.

**To cancel the purchase order:**

- You can cancel the entire approved purchase order by selecting Cancel from the Tools menu. See: Document Control Options, page 2-41

**Note:** If you cancel a line of an approved purchase order from this window, the status of the purchase order will be Requires Reapproval.

## Inquire Menu Options

**To view action history:**

- Select View Action History on the Inquire menu to open the Action History window. See: Viewing Action History, page 10-1.

**To view the formatted purchase order:**

- Select View Document on the Inquire menu to see the purchase order in the format that will be communicated to the supplier.

## Actions Menu Options

**To view acquisition cost:**

- Select Acquisition Cost from the Actions menu to view the acquisition cost associated with purchase order lines and shipments summarized by cost factor.

**To view taxes:**

- Select Manage Tax from the Actions menu to view and manage the tax for the purchase order. See: Tax Information in Purchasing, .

## Other Purchase Order Options

**To reaccess a purchase order quickly:**

- Choose Place on Navigator from the File menu. Choose the Documents tabbed region in the Navigator to later access the purchase order more quickly. See also: Using the Navigator's Documents Region, *Oracle Applications User's Guide*.

**Note:** Once you place a document in the Navigator, it is the first thing you see in the Navigator the next time you log into Purchasing. Choose Functions to return to the Purchasing menu.

## Related Topics

Overview of Purchase Orders, page 4-1

Entering Purchase Order Lines, page 4-46

Changing Encumbered Documents, page 4-113

Procurement Card Purchase Orders and Releases, page 4-118

## Entering Purchase Order Lines

Use the Lines tabbed region in the Purchase Orders window to create purchase order lines.

When you save your work, Purchasing creates shipments and distributions if sufficient valid default information is available. Use the Purchase Order Shipments window to review, edit, and create multiple shipment lines for each purchase order line. See: Entering Purchase Order Shipments, page 4-67.

### **To enter a purchase order line:**

1. Select the Lines tabbed region in the Purchase Orders window.

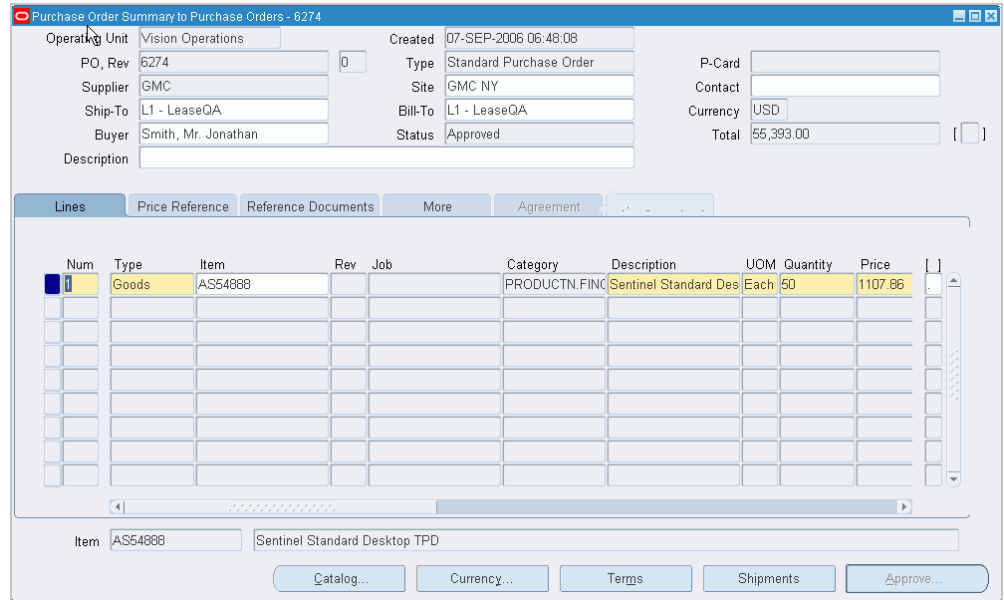

2. Enter the purchase line Number for the purchase order line. If you start a new purchase order line, Purchasing displays the next sequential line number available. You can accept this number or enter any line number that does not already exist. This number is used for *all* tabbed regions in the Purchase Orders window.

3. Enter the line Type for the item. When you create your purchase order line, you enter a line type as part of your item information. When you enter a line type, Purchasing automatically copies the corresponding defaults. You can change the line type after you have saved your work, if the change is in the same line type class, but Purchasing won't automatically copy the new defaults. If you change the line type before you save your work, Purchasing automatically copies the new defaults if the new line type is in a different line type class.

You can enter predefined items for your purchase order line only when you specify a quantity based line type. If Bills of Material and Work in Process are installed and you have defined an outside processing line type, you can enter that type here to purchase outside processing. See: Defining Default Options, page 1-38. See: Defining Line Types, page 1-62.

To enter lines for services, you can specify a line type that has its basis as amount. If Oracle Services Procurement is implemented, services lines with a rate based line type can be entered or fixed price based line type can be created from the Supplier Item Catalog. See: Defining Line Types, page 1-62. See: Overview of the Supplier Item Catalog, page 5-5.

4. Enter the Item you want to purchase. If you enter an item, Purchasing displays the purchasing category, item description, unit of measure, and unit price associated with the item. To create a purchase order line for a one-time item, simply skip the

item number field and enter a purchasing category and an item description. If you are purchasing outside processing, you can enter only outside processing items. See: Defining Items, *Oracle Inventory User's Guide*.

If you enter an item that is under automatic sourcing control the unit price will be displayed and reference information included from the most current agreement available to Oracle Purchasing. See: Overview of Automatic Sourcing, page 5-24

Note that you cannot enter an outside processing item in a global agreement, regardless of the item's defining organization.

5. Enter the Revision number for the item on the purchase order line. See: Defining Item Revisions, *Oracle Inventory User's Guide*. See: Inventory Attribute Group, *Oracle Inventory User's Guide*.
6. Enter the purchasing Category of the item you want to purchase. If you choose an item, Purchasing displays the purchasing category for the item. You cannot change the purchasing category if you choose an item. See: Defining Categories, *Oracle Inventory User's Guide*.
7. Enter the Description of the item. If you choose an item, Purchasing displays its description. You can change the item description only if you set up the item attributes to let you do so. The full item description for the current line is displayed beneath the Lines tabbed region.
8. Enter the total Quantity you are ordering on the purchase order line.
9. Enter the UOM of the item. The unit of measure qualifies the quantity you enter on the purchase order line. When you choose a line type, its default unit of measure appears here. When you choose an item number, its unit of measure overrides the line type default. You can change the UOM until the item has been received, billed, or encumbered. If the line is sourced to a quotation or global agreement, you cannot change the UOM after the line has been saved.
10. Enter the unit Price for the item. If you choose an item, the default price is the list price for the item. Otherwise, the default price is from the line type. The Amount field displays the unit price multiplied by the quantity.

If you entered an item that is under automatic sourcing control the unit price will be displayed from the most current agreement available to Oracle Purchasing. See: Overview of Automatic Sourcing, page 5-24

**Note:** If you manually override the defaulted price, Oracle Purchasing does not recalculate the price when pricing related changes are made to the purchase order.

11. Enter the Promised date and time that the supplier promised delivery of the items.

Multiple distributions, Promised date, and Need-By date display as "multiple" at the line level.

12. Enter the Need By date and time when the requester needs the item.

If you are using Master Scheduling/MRP, you must provide either a need-by date or a promised-by date for shipments that correspond to purchase order lines with Master Scheduling/MRP planned items. A need-by date is also required for Inventory planned items. See: *Overview of Implementing Planning Recommendations, Oracle Master Scheduling/MRP and Supply Chain Planning User's Guide*.

Multiple distributions, Promised date, and Need-By date display as "multiple" at the line level.

13. Optionally enter the Supplier's Item number for this item.
14. Select Reserved to reserve funds for the line.
15. If the Oracle Process Manufacturing (OPM) application is installed and implemented, you are a process manufacturing user, and the selected purchasing organization is a process organization, then the process fields are enabled. The three process fields are Secondary UOM, Secondary Quantity, and Grade. See: *Entering OPM Line Information*, page 3-57 for complete details.

**To recalculate prices:**

- If you have manually changed the price and then you have changed price related attributes of a line (for example: ship to organization or need-by date), you can have Oracle Purchasing recalculate the price by selecting Recalculate Price from the Tools menu.

## Related Topics

Tools Menu Options, page 4-44

Inquire Menu Options, page 4-45

Overview of Purchase Orders, page 4-1

Entering Purchase Order Headers, page 4-40

Overview of the Supplier Item Catalog, page 5-5

Entering Currency Information, page 4-60

Entering Purchase Order Details Information, page 4-61

Entering Purchase Order Shipments, page 4-67

Entering Purchase Agreement Price Break Information, page 4-73

Submitting a Document for Approval, page 2-32.

Entering Purchase Order Notification Controls, page 4-80

Entering and Viewing Purchase Order Acceptances, page 4-82

Viewing Action History, page 10-1

Entering Purchase Order Preferences, page 4-37

Changing Encumbered Documents, page 4-113

## Entering Purchase Order Price Reference Information

Use the Price Reference tabbed region in the Purchase Orders window to enter pricing information for purchase order lines.

**To enter price reference information:**

1. Select the Price Reference tabbed region in the Purchase Orders window.

Num	List Price	Market Price	Allow Price Override Price Type	Price Limit	Negotiated

2. Enter the List Price for the item. If you have entered an item, Purchasing displays the list price for the item. (See: Defining Items, *Oracle Inventory User's Guide*.) You can accept the default list price or change it. Use this field to help evaluate your buyers. Purchasing uses the list price you enter here in the savings analysis reports. See: Savings Analysis Report (By Buyer), page 11-78 and Savings Analysis Report (By Category), page 11-79.
3. Enter the latest Market Price for the item. If you enter an item, Purchasing displays the market price for the item. Use this field to help evaluate your buyers. Purchasing uses the price you enter here in the savings analysis reports if you do not provide a value in the List Price field.

4. Enter the Price Type from your lookup codes. See: Defining Lookup Codes, page 1-55.
5. For planned purchase orders and blanket purchase agreements only, check Allow Price Override to indicate that the release price can be *greater* than the price on the purchase agreement line. If you allow a price override, the release price cannot exceed the Price Limit specified on the line. If you do not allow a price override, Purchasing displays on the release the shipment price from the purchase agreement and prevents you from updating it. You cannot enter this field if the line type is amount based.
6. If you allow price override, enter the Price Limit. This is the maximum price per item you allow for the item on this agreement line.
7. Select Negotiated to indicate that the purchase price is negotiated. If the actual price is greater than or equal to the list price, then the field is unchecked as the default. If the actual price is less than the list price, then the field is checked as the default. You can accept the default value or change it.

## Related Topics

Overview of the Supplier Item Catalog, page 5-5

Entering Currency Information, page 4-60

Entering Purchase Order Details Information, page 4-61

Entering Purchase Order Shipments, page 4-67

Entering Purchase Agreement Price Break Information, page 4-73

Submitting a Document for Approval, page 2-32.

Entering Purchase Order Notification Controls, page 4-80

Entering and Viewing Purchase Order Acceptances, page 4-82

Viewing Action History, page 10-1

Entering Purchase Order Preferences, page 4-37

## Entering Purchase Order Reference Document Information

Use the Reference Documents tabbed region in the Purchase Orders window to enter reference document information for purchase order lines.

Purchasing lets you reference quotation information on your purchase orders.

### **To enter reference document information:**

1. Select the Reference Documents tabbed region in the Purchase Orders window.

2. Enter the Contract purchase agreement number. You cannot enter a contract number until you have entered a supplier in the header, and the contract must be for this supplier. The contract you choose must be effective; that is, the current date has to be within the effective date and the expired date of the contract.

If you reference a contract purchase agreement on a standard purchase order line, Purchasing adds the total amount of the purchase order line to the total amount of the contract purchase agreement. Purchasing lists only those contracts with the same supplier as the one on your standard purchase order.

If this purchase order references a global agreement then Global will be checked and the Owning Org will display the organization that owns the global agreement.

**Important:** If you have not yet provided a supplier on your standard purchase order, you cannot choose any contracts for your purchase order lines. If you want to change the supplier on your standard purchase order after you reference a contract on your purchase order lines, you must remove the references to the contract purchase agreement, or you will not be able to approve the purchase order. Purchasing lets you change suppliers only on standard and planned purchase orders with the status Incomplete.

Purchasing displays the Quotation and Quotation Line numbers, Quotation Type, and Supplier Quotation Number if you select a quotation from the Supplier Item Catalog or Supplier-Item Attributes windows.

3. You can enter project contract information in this region. If you are using Oracle



Project Contracts you can enter the project Contract number and Rev (version number). Once you have entered this information, you will then be able to enter additional project contract details at the distribution level.

## Related Topics

Overview of the Supplier Item Catalog, page 5-5

Entering Currency Information, page 4-60

Entering Purchase Order Details Information, page 4-61

Entering Purchase Order Shipments, page 4-67

Entering Purchase Agreement Price Break Information, page 4-73

Submitting a Document for Approval, page 2-32.

Entering Purchase Order Notification Controls, page 4-80

Entering and Viewing Purchase Order Acceptances, page 4-82

Viewing Action History, page 10-1

Entering Purchase Order Preferences, page 4-37

## Entering Purchase Order Miscellaneous Information

Use the More tabbed region in the Purchase Orders window to enter miscellaneous information for purchase order lines.

### **To enter miscellaneous information:**

1. Select the More tabbed region in the Purchase Orders window.

2. Enter a Note to the Supplier for the purchase order header. You can enter up to 240 characters. If you want to enter unlimited notes, use the Attachments feature. See: Attaching Notes to Purchasing Documents, page 1-33
3. Enter the UN identification Number for the item on the purchase order line. The default, if present, is from the item record. See: Defining UN Numbers, page 1-54.
4. Enter the Hazard Class for the item on the purchase order line. If you enter a UN number, Purchasing displays the corresponding hazard class. The default, *if present*, is from the item record. See: Defining Hazard Classes, page 1-53.
5. Select Capital Expense to indicate that the purchase is a capital expenditure.
6. Enter the Transaction Nature. See: Defining Lookup Codes, page 1-55.

## Related Topics

- Overview of the Supplier Item Catalog, page 5-5
- Entering Currency Information, page 4-60
- Entering Purchase Order Details Information, page 4-61
- Entering Purchase Order Shipments, page 4-67
- Entering Purchase Agreement Price Break Information, page 4-73
- Submitting a Document for Approval, page 2-32.
- Entering Purchase Order Notification Controls, page 4-80

Entering and Viewing Purchase Order Acceptances, page 4-82

Viewing Action History, page 10-1

Entering Purchase Order Preferences, page 4-37

## Entering Purchase Agreement Information

Blanket and contract purchase agreements may require additional information be entered. Discussed in this section are:

- Additional terms information
- Line pricing information
- Assignment of organizations to global agreements
- Renegotiating blanket purchase agreements

### **To enter additional agreement terms on the header:**

1. From the Purchase Orders window, select Terms.
2. Enter the effective dates, release amounts, and price update information in the Agreement Controls region. See: Entering Purchase Order Details Information, page 4-61.

### **To enter additional blanket agreement line information:**

1. In the Agreement tabbed region of the Purchase Orders window (when you've selected a Type of Blanket Purchase Agreement), enter the Minimum Release Amount against this purchase agreement line.

2. Enter the Quantity Agreed. This is printed on your purchase orders. Purchasing does not automatically compute the quantity agreed from the amount agreed. Use the Amount Agreed field to provide agreed amounts.
3. Enter the Amount Agreed. Purchasing does not automatically compute the amount agreed from the quantity agreed.
4. Optionally enter an Expiration Date to prevent ordering of the item after that date.  
If the item on the agreement has expired but already exists on an open release, you can still use the release. However, the expired line item will not be used for sourcing, and any future releases you create will not allow using the expired item.
5. Select Cumulative Pricing if you want Purchasing to choose the price break by adding the current release shipment quantity to the total quantity already released against the purchase agreement line. Otherwise, Purchasing chooses the price break by using the individual release shipment quantity.

**Note:** Cumulative Pricing can not be used with global agreements.

Organizations can take advantage of negotiations completed with suppliers by other business units. To do this the original blanket purchase agreement or contract purchase agreement is first created as a global agreement (Global checkbox). Then the agreement is enabled for use in the authorized business units (operating units).

**To enable organizations for a global agreement:**

1. From the Purchase Orders window, open a global agreement and select Enable Organizations from the Tools menu.

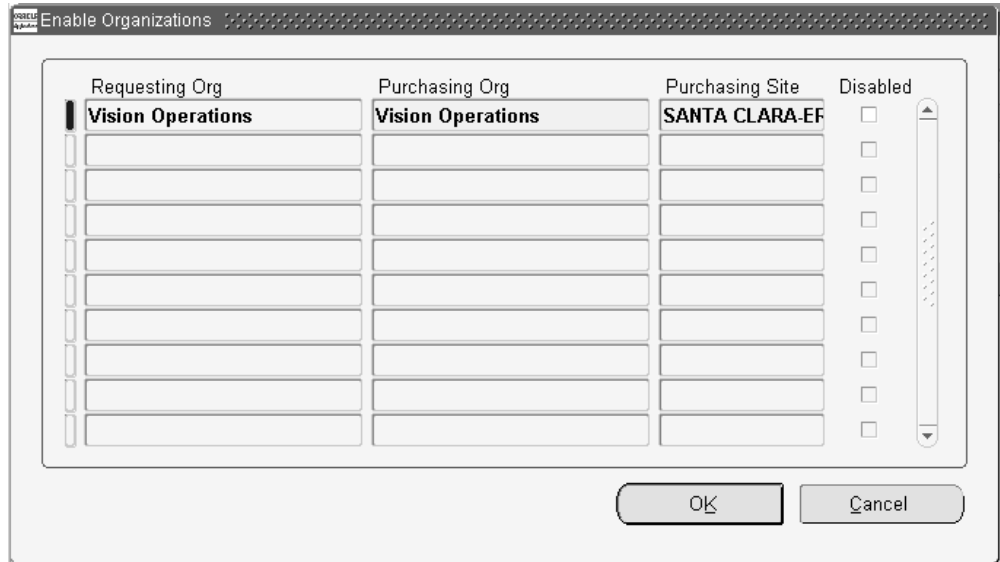

2. Select the Requesting Org operating unit. This organization can create requisitions that reference the global agreement.
3. Select the Purchasing Org operating unit. This organization creates purchase orders for the Requesting Org selected in the previous step.

**Note:** If encumbrance is enabled, the Requesting Org and the Purchasing Org must be the same.

4. Select the Purchasing Site. This is the supplier site in the purchasing organization which will fulfill the order.
5. To disable the global agreement in an organization check the Disabled box.
6. Click the OK button to save your organization assignments.

For more information on using global agreements see: Center-Led Procurement, page 1-79

**To renegotiate a blanket purchase agreement:**

1. If you have Oracle Sourcing enabled, query the blanket purchase agreement that you wish to renegotiate.
2. From the Tools menu, select Create Buyer's Auction or Create Sourcing RFQ.

**To encumber a blanket purchase agreement:**

- You can encumber a blanket purchase agreement from the Terms and Conditions window. See: Entering Purchase Order Details Information, page 4-61.

## Related Topics

- Overview of the Supplier Item Catalog, page 5-5
- Entering Currency Information, page 4-60
- Entering Purchase Order Details Information, page 4-61
- Entering Purchase Order Shipments, page 4-67
- Entering Purchase Agreement Price Break Information, page 4-73
- Submitting a Document for Approval, page 2-32.
- Entering Purchase Order Notification Controls, page 4-80
- Entering and Viewing Purchase Order Acceptances, page 4-82
- Viewing Action History, page 10-1
- Entering Purchase Order Preferences, page 4-37

## Entering Purchase Order Temporary Labor Information

If you have licensed and implemented Oracle Services Procurement, you can use the Temporary Labor tabbed region in the Purchase Orders window to enter temporary labor information for purchase order lines.

**To enter temporary labor information:**

1. Select the Temporary Labor tabbed region in the Purchase Orders window.

Purchase Orders (Vision Operations) - [New]

PO, Rev: 0    Type: Standard Purchase    Created: 16-MAR-2004 11:4  
 Supplier: TempsRUs    Site: SANFRAN    Contact: Stern, Robert  
 Ship-To: V1- New York City    Bill-To: V1- New York City    Currency: USD  
 Buyer: Green, Mr. Terry    Status: Incomplete    Total: 0.00 [ ]

Description: [ ]  
 P-Card: [ ]

Lines    Price Reference    Reference Documents    More    Agreement    Temporary Labor

— Contractor —

Num	First Name	Last Name	Start Date	End Date
1				

Job: ASSISTANT    Administrative Assistant

Buttons: Catalog...    Currency...    Terms    Shipments    Approve...

2. Optionally, enter the contractor's First Name.
3. Optionally, enter the contractor's Last Name.
4. Enter the contractor's Start Date.
5. Optionally, enter the contractor's End Date.

**To enter price differentials:**

- For a rate based line type you can enter price differentials after saving your line by selecting Price Differential from the Tools menu. See: Purchasing Services, page 1-59

## Related Topics

Setting Up Oracle Services Procurement, page 1-90

Entering Currency Information, page 4-60

Entering Purchase Order Details Information, page 4-61

Entering Purchase Order Shipments, page 4-67

Submitting a Document for Approval, page 2-32.

Viewing Action History, page 10-1

## Entering Currency Information

Use the Currency window to enter and change currency information for purchase orders, RFQs, and quotations.

For purchase orders, you can change currency information until the purchase order is approved or encumbered. Note that changing the purchase order supplier to one that uses a different currency *overrides* any information you have entered in this region.

### To enter currency information:

1. Navigate to the Currency window by selecting the Currency button in the Purchase Orders, RFQs, and Quotations windows.



The screenshot shows a dialog box titled "Currency (Vision Operations) - 1003667". It has a dark grey background. The fields are as follows:

Currency	USD
Rate Type	
Rate Date	16/JAN/2001
Rate	

At the bottom, there are two buttons: "Done" and "Cancel".

2. Purchasing displays the functional Currency from your Primary Ledger, and you can accept or change the currency. If you change the currency, you must update the unit price on all lines to reflect what that price would be at the new currency.
3. You can enter a Rate Type only if the currency for this document is different from your functional or base currency. The default is the currency rate type from the Purchasing Options window.

Purchasing supplies you with one of two predefined currency rate types: User or EMU Fixed. A rate type of User means that you can enter a conversion rate between the foreign currency (or transaction currency in a document entry window) and the base currency (or functional currency, defined in your set of books). A rate type of EMU Fixed means that if either your transaction currency or your functional currency is Euro (the European Monetary Unit currency) and the other is another European currency, Purchasing automatically enters a conversion Rate Date and Rate for you that you cannot change.

You can define additional currency rate types in the Daily Conversion Rate Types window, and you can enter User or one of your additional types as the default. Note that you cannot approve a purchase order without a rate type if you are not using your functional currency.



4. The default Rate Date is the current date. Purchasing uses this date to obtain the currency conversion rate from your conversion definitions and displays the rate if it finds one.
5. If the rate type is User, you can enter the conversion rate between the foreign currency and your functional currency. This rate corresponds to the value of your foreign currency in your functional currency. For example, if your functional currency is US Dollars, the foreign currency is British Pounds, and 1 British Pound equals 2 US Dollars, you should enter 2 in this field. For other rate types, when you enter a rate date for which a rate has been defined, Purchasing displays the rate.
6. Click Done to apply your entries.

**To cancel your entries and return:**

- Select the Cancel button to cancel your entries and return to the window from which you accessed the Currency window.

## Related Topics

Purchase Order Defaulting Rules, page 4-10

Defining Purchasing Options, page 1-33

Defining Currencies, *Oracle General Ledger User's Guide*

Defining Conversion Rate Types, *Oracle General Ledger User's Guide*

Entering Daily Rates, *Oracle General Ledger User's Guide*

Defining Sets of Books, *Oracle General Ledger User's Guide*

## Entering Purchase Order Details Information

Use the Terms and Conditions window to enter terms, conditions, and control information for purchase orders. Discussed in this section are:

- Purchase Order Terms
- Agreement Controls
- Contract Terms
- Encumbrance Controls

**To enter purchase order terms information:**

1. Navigate to the Terms and Conditions window by selecting the Terms button in the Purchase Orders window.
2. Enter the Payment terms for the purchase order. Purchasing displays default

payment terms that you can accept or change. See: Defining Payment Terms, *Oracle Payables User's Guide*.

3. Enter the Freight terms for the purchase order. Purchasing displays default freight terms that you can accept or change. See: Defining Lookup Codes, page 1-55
4. Enter the freight Carrier for shipment of the purchase order. Purchasing displays a default freight carrier that you can accept or change. See: Defining Freight Carriers, *Oracle Shipping Execution Guide*.
5. Enter the FOB point for the purchase order. Purchasing displays a default free on board (FOB) designation that you can accept or change. See: Defining Lookup Codes, page 1-55.

The screenshot shows the Oracle Terms and Conditions (Vision Operations) - [New] window. The window has two tabs: "Terms" and "Encumbrance". The "Terms" tab is active. The "Terms" section contains the following fields and options:

- Payment: Immediate
- Freight: Due
- Carrier: Airborne
- FOB: CIF
- Pay On: (empty)
- Transportation Arranged: (dropdown)
- Confirming Order
- Firm
- Acceptance Required: None
- By: (empty)
- Supply Agreement

Below the "Terms" section are two text input fields:

- Supplier Note
- Receiver Note

At the bottom is the "Agreement Controls" section, which includes:

- Effective: (date) - (date)
- Amount Limit: (text)
- Minimum Release: (text)
- Price Update Tolerance: (text) %

6. Optionally select a value in the Pay On field to enable or disable Payment on Receipt for this document.

Receipt is defaulted in this field if the supplier site is set up as a Payment on Receipt site in the Supplier Sites window. Receipt means that Payment on Receipt will automatically generate an invoice for this purchase order.

Select Null if you do not want Payment on Receipt to automatically create an invoice for this document. If the supplier site is not set up as a Payment on Receipt

site, this field is disabled, and you cannot change it. See: Payment on Receipt, page 13-16.

You can update the Pay On field again on a release (if the supplier is a Payment on Receipt site).

7. Select the Acceptance Required method. If you select a method, you can enter the due By date, when you require the supplier to return an acceptance for your purchase order. See: Entering and Viewing Purchase Order Acceptances, page 4-82.
  - *Document only*: Acceptance is entered for the entire document.
  - *Document or Shipment*: Acceptance is entered for the document or for individual shipments.
  - *Document and Signature*: If Oracle Procurement Contracts is implemented, acceptances are entered for the entire document with a signature. This method causes the approved document to have a status of Pre-Approved until signatures are completed.
8. Select Confirming Order to indicate that the purchase order is a confirming order. A confirming order is an order that you are submitting formally to confirm a verbal order already placed with the supplier. For confirming orders, Purchasing prints the following on the purchase order header: **This is a confirming order. Do not duplicate.**
9. Select Firm to indicate that the purchase order is firm. Firm your purchase order when you want to indicate to Master Scheduling/MRP or your manufacturing application that it should not reschedule this purchase order shipment.
10. Select Supply Agreement if you want Oracle Supplier Scheduling to communicate releases against this blanket purchase agreement to suppliers.

Supplier Scheduling can communicate releases against a blanket purchase agreement only when this option is selected.
11. If Oracle Transportation is implemented, select the party responsible for transportation from Transportation Arraigned. See: Oracle Transportation Overview, *Oracle Transportation User's Guide*.
12. Enter a Supplier Note and a Receiver Note. You can enter up to 240 characters in these fields.

**Note:** If you are entering a release, the remaining fields in this window are displayed from the original agreement and can not be updated.

**To enter purchase agreement information:**

1. Click Terms in the Purchase Orders window to navigate to the Terms and Conditions window.
2. For planned purchase orders, blanket purchase agreements, and contract purchase agreements, enter the Effective start date for the purchase order. A starting date is necessary if you are using a warning delay on notification controls. You cannot associate a purchase order line with a contract that is not yet effective. You also cannot create a release with a creation date that is before the corresponding blanket purchase agreement or planned purchase order effective date.
3. For planned purchase orders, blanket purchase agreements, and contract purchase agreements, enter the Effective expiration date for the purchase order. This date must be *later* than the start date and later than any existing releases. You cannot associate a purchase order line with a contract that has expired. You also cannot create a release with a date that is after the corresponding blanket purchase agreement or planned purchase order expiration date.
4. For planned purchase orders, blanket purchase agreements, and contract purchase agreements, enter the Amount Limit (for the total of all releases) and the Minimum Release Amount that can be released against this purchase order. For blanket and contract purchase agreements, the Amount Limit must be equal to or greater than the Amount Agreed. Enter Effective from and to dates to limit the agreement controls by time.
5. For blanket purchase agreements, enter a Price Update Tolerance only if you are importing price/sales catalog information through the Purchasing Documents Open Interface.

The Price Update Tolerance specifies the maximum percentage increase allowed to an item's price on this blanket purchase agreement when your supplier sends updated price/sales catalog information through the Purchasing Documents Open Interface. This field affects only blanket purchase agreements imported through the Purchasing Documents Open Interface. See: Setting a Price Tolerance in a Price/Sales Catalog Update, page 5-20.

If you have implemented Oracle Procurement Contracts; you can view and maintain contract clauses, supporting documents, and deliverables using that product. Oracle Purchasing provides access to these features, as well as the ability to view all contract content and their amendments in the PDF version of the purchase order and from the Change History window. See: Viewing Purchase Order Changes, page 10-3.

**To enter contract terms information (Oracle Procurement Contracts):**

1. Click Terms in the Purchase Orders window to navigate to the Terms and Conditions window.

**Note:** See the online help in the Oracle Procurement Contracts

windows for information regarding their use.

2. If Oracle Procurement Contracts is implemented, click Author Contract Terms to add contract clauses and deliverables to this purchase order.
3. Click Manage Contract Documents to add or maintain documents supporting the contract information for this purchase order.
4. Click View Contract Terms to view contract clauses and deliverables.
5. Click Update Deliverable Status to enter status information for the contract deliverables associated with this purchase order.

**To enter encumbrance information:**

1. Click Terms in the Purchase Orders window to navigate to the Terms and Conditions window.

The screenshot shows a web browser window titled "Terms and Conditions (Vision Enc) - [New]". The window has two tabs: "Terms" and "Encumbrance", with "Encumbrance" selected. Below the tabs is a section titled "Encumbrance Controls" with a horizontal line underneath. The form contains the following elements:

- An unchecked checkbox labeled "Encumber".
- A text label "Budget Account" followed by a wide text input field.
- A text label "GL Date" followed by a date input field.
- A text label "Amount To Encumber" followed by a numeric input field.
- A text label "Transaction Code" followed by a text input field.
- A text label "Encumbered Amount" followed by a numeric input field.
- A text label "Encumbrance Relieved" followed by a numeric input field.

2. If you have encumbrance turned on, select the Encumbrance tabbed region.
3. You can encumber a blanket purchase agreement by checking the Encumber box. See: Budgetary Control and Online Funds Checking, *Oracle General Ledger User's Guide*
4. Select the encumbrance Budget Account.
5. Enter the GL Date for this encumbrance reservation. This date must be in an open Purchasing period.
6. Enter the Amount to Encumber.
7. For Oracle Public Sector customers that have the USSGL profile option enabled, select the Transaction Code.

## Related Topics

Purchase Order Defaulting Rules, page 4-10

## Entering Purchase Order Shipments

Use the Shipments window to enter multiple shipments for standard and planned purchase order lines and to edit shipments that Purchasing automatically created for you. A purchase order shipment specifies the quantity, ship-to organization and location, date you want your supplier to deliver the items on a purchase order line, and country of origin for the items. When you save your work, Purchasing creates distributions if sufficient valid default information is available and if there are no existing distributions.

### To enter purchase order shipment information:

1. For standard and planned purchase orders, you can navigate to the Shipments window by selecting the Shipments button in the Purchase Orders window.

Num	Org	Ship-To	UOM	Quantity	Promised Date	Need-By	Original Promise
1	V1	L1 - LeaseQA	Each	50		07-SEP-2006 00:00	

Line Num: 1    Item: AS54888    Sentinel Standard Desktop TPD

Receiving Controls    Distributions

The first tabbed region in the Shipments window is the Shipments tabbed region. In addition to the enterable fields discussed in the following steps, this region displays the UOM, the Original Promise date (if the Promised date has already been changed, the original promised date is displayed here), the Charge Account, the line Amount, and a check box to indicate whether funds have been Reserved. See: *Budgetary Control and Online Funds Checking, Oracle General Ledger User's Guide.*

2. Enter the line Number for the shipment line. If you enter a new shipment line, Purchasing displays the next sequential line number available. You can enter any line number that does not already exist.
3. Enter the ship-to Organization. If you entered an item, you can pick only organizations in which the item is defined. If you entered a revision number on the purchase order line, then the item revision must also be defined in the organization. Note that you cannot update the organization once you have saved your work if the

shipment has distributions. See: Purchase Order Defaulting Rules, page 4-10

4. Enter the Ship-To location for the shipment. You can pick any location that does not have an organization or any location whose organization matches the organization in the previous field. See: Purchase Order Defaulting Rules, page 4-10.
5. Enter the Quantity (Amount, if using Oracle Services Procurement) for the shipment. This value must be greater than 0. The default is the quantity from the corresponding Purchase Order Line. If you decrease this quantity, Purchasing automatically defaults the quantity ordered of the next line to the total quantity that you have not yet placed on a shipment line. The UOM is displayed to the right of the Quantity.
6. Enter the date and time that the supplier Promised delivery of the items. This promised date is printed on the purchase order shipment. The default is from the Purchase Order Preferences window.
7. Enter the Need By date and time when the requestor needs the item. This date is printed on the purchase order if you do not enter a promised date. The default is from the Purchase Order Preferences window.

If you use Purchasing with Master Scheduling/MRP, you must provide a need-by date for purchase order shipments with Master Scheduling/MRP planned items. You must also provide a need-by date for Inventory planned items. See: *Overview of Implementing Planning Recommendations, Oracle Master Scheduling/MRP and Supply Chain Planning User's Guide*.

8. Optionally choose or change the Note for Receiver.

The Note for Receiver is a note which will be displayed at the time of receipt for this shipment.

The Note for Receiver displayed here defaults from the requisition line that this purchase order was created from. Otherwise, this field is blank.

9. Optionally choose or change the Country of Origin.

The Country of Origin is the country in which an item is manufactured.

The Country of Origin displayed here defaults from the Approved Supplier List, if it is defined there. If not, it defaults from the supplier site in the Supplier Sites window. Otherwise, this field is blank. You can leave it blank or select a country.

If you do not know the originating country, you can enter or change the Country of Origin later on the receipt.

10. If you are a process manufacturing user and the Oracle Process Manufacturing (OPM) application is installed, then the Oracle Purchasing for Process Inventory functionality is enabled. If the selected purchasing organization is a process organization, then the three process fields the Secondary UOM, Secondary



Quantity, and Grade are enabled. For more information on these fields see: *Entering OPM Line Information*, page 3-57.

**To display and enter more shipment information:**

1. Select the More tabbed region in the Purchase Order Shipments window.
2. Enter the Receipt Close Tolerance percent for your shipments. Purchasing automatically closes a shipment for receiving if it is within the receiving closing tolerance at the receiving close point. You need to set the receiving close point in the Purchasing Options window. See: *Defining Control Options*, page 1-34.
3. Enter the Invoice Close Tolerance percent for your shipments. Purchasing automatically closes a shipment for invoicing if it is within the invoicing closing tolerance at billing, when Payables matches invoices to purchase orders or receipts. See: *Defining Control Options*, page 1-34
4. Select one of the following options for Match Approval Level:
  - *Two-Way*: Purchase order and invoice quantities must match within tolerance before the corresponding invoice can be paid.
  - *Three-Way*: Purchase order, receipt, and invoice quantities must match within tolerance before the corresponding invoice can be paid.
  - *Four-Way*: Purchase order, receipt, accepted, and invoice quantities must match within tolerance before the corresponding invoice can be paid.

If you enter an item, a value for this field is defaulted. See: *Purchase Order Defaulting Rules*, page 4-10.

5. Select an Invoice Match Option:
  - *Purchase Order*: Payables must match the invoice to the purchase order.
  - *Receipt*: Payables must match the invoice to the receipt.

Choose Receipt if you want to update exchange rate information on the receipt or if you want your accounting to use exchange rate information based on the receipt date. (If you use Periodic Costing, you must match to the receipt to ensure accurate cost accounting.)

The Invoice Match Option defaults from the Supplier Sites window. You can change the Invoice Match Option on the shipment until you receive against the shipment.

**Note:** The Invoice Match Option and the Match Approval Level are independent options. You can perform whichever Invoice Match Option you want regardless of the Match Approval Level.

See: Entering Purchase Order Matched Invoices, *Accounts Payable User's Guide*.

6. Select Accrue at Receipt to indicate that the items on this purchase order line accrue upon receipt. Inventory destined items always accrue upon receipt. For expense items, if the Accrue Expense Items flag in the Purchasing Options window is set to Period End, the items cannot accrue upon receipt, and you cannot change the shipment level default. If the Accrue Expense Items flag is set to At Receipt, the default is to accrue upon receipt, but you can change it to Period End. See: Defining Accrual Options, page 1-40.

**Important:** If you are using Cash Basis Accounting, you should use the Purchasing Options window to set the Accrue Expense Items flag to Period End, and you should not select Accrue on Receipt in this window.

7. Select Firm to firm the purchase order shipment. Firm your purchase order when you want to indicate to Master Scheduling/MRP or your manufacturing application that it should not reschedule this shipment.
8. The VMI box will be checked if this item is under vendor managed inventory control. Likewise, the Consigned box will be checked if this is a supplier consigned item. See the *Oracle Consigned Inventory and Vendor Managed Inventory Process Guide* for details.

**To display status information:**

- Select the Status tabbed region in the Purchase Order Shipments window.

For each shipment, Purchasing displays the Status and the quantity (amount for Oracle Services Procurement) Ordered, Received, Cancelled, and Billed.

**To display drop ship information:**

- Select the Drop Ship tabbed region in the Purchase Order Shipments window. See: Drop Shipments, page 4-114.

For each shipment, Purchasing displays the Sales Order Number and Line, Ordered Quantity, Shipped Quantity, Sales Order Status, Ship To Customer Name, and Ship To Customer Contact.

**To enter receiving control information:**

- Select the Receiving Controls button to open the Receiving Controls window. See: Entering Purchase Order Receiving Controls, page 4-71.

**To enter purchase order distribution information:**

- Select the Distributions button to open the Distributions window. See: Entering Purchase Order Distributions, page 4-75.

**To view sales order for drop shipped orders:**

- Select View Sales Order on the Inquire menu to open the Sales Orders window for the sales order associated with this purchase order. See: Drop Shipments, page 4-114

## Related Topics

Tools Menu Options, page 4-44

Inquire Menu Options, page 4-45

Drop Shipments, page 4-114.

Entering Purchase Order Preferences, page 4-37

Changing Encumbered Documents, page 4-113

Processing Periodic Acquisition Costs, *Oracle Cost Management User's Guide*

## Entering Purchase Order Receiving Controls

Use the Receiving Controls window to enter receiving control information for purchase orders and releases. Note that controls you enter here apply to specific purchase orders/releases and override the receiving controls you enter in the Receiving Options window. See: Receiving Controls, Options, and Profiles, page 9-7.

**To enter purchase order receiving controls:**

1. Navigate to the Receiving Controls window by clicking Receiving Controls in the Shipments window for purchase orders and in the Releases window for releases.

**Receiving Controls**

**Receipt Date**

Days Early: 30

Days Late: 14

Action: Warning

Last Accept Date:

**Over Receipt Tolerance**

Tolerance: 10 %

Action: Warning

**Miscellaneous**

Allow Substitute Receipts

Receipt Routing: Direct Delivery

Enforce Ship To: None

OK Cancel

2. Enter the maximum acceptable number of Days Early and Days Late for receipts.
3. Enter the Action for receipt date control. This field determines how Purchasing handles receipts that are earlier or later than the allowed number of days selected above. Choose one of the following options:
  - *None* - Receipts may exceed the allowed days early or late.
  - *Reject* - Purchasing does not permit receipts outside the selected number of days early or late.
  - *Warning* - Purchasing displays a warning message but permits receipts outside the selected number of days early or late.

Purchasing displays the Last Accept Date, which is the last date when the shipment can be received. This is the promised date plus the number of days late allowed.

4. Enter the maximum acceptable over-receipt Tolerance percent.
5. Enter the Action for Overreceipt Quantity control. This field determines how

Purchasing handles receipts that exceed the quantity received tolerance. Choose one of the following options:

- *None* - Receipts may exceed the selected tolerance.
  - *Reject* - Purchasing does not permit receipts that exceed the selected tolerance.
  - *Warning* - Purchasing displays a warning message but permits receipts that exceed the selected tolerance.
6. Select Allow Substitute Receipts to indicate that receivers can receive substitute items in place of ordered items. You must define substitute items before you can receive them. See: *Defining Item Relationships, Oracle Inventory User's Guide*
  7. Enter the default Receipt Routing that you assign goods: Direct Delivery, Inspection Required, or Standard Receipt. You can override this routing during receipt by changing the destination type, if the RCV: Allow Routing Override user profile option is enabled. See: *Profile Options in Purchasing, page C-1.*
  8. Enter the Enforce Ship To location option to determine whether the receiving location must be the same as the ship-to location. Choose one of the following options:
    - *None* - The receiving location may differ from the ship-to location.
    - *Reject* - Purchasing does not permit receipts when the receiving location differs from the ship-to location.
    - *Warning* - Purchasing displays a warning message but permits receipts when the receiving location differs from the ship-to location.
  9. Select the OK button to apply your entries and return to the original window.
- To cancel your entries:**
- Select the Cancel button to cancel your entries and return to the original window.

## Related Topics

[Defining Receiving Options, page 1-42](#)

## Entering Purchase Agreement Price Break Information

Use the Price Break window to enter price break information for blanket purchase agreement lines.

**To enter price break information:**

1. Navigate to the Price Break window by selecting the Price Break button in the

## Purchase Orders window.

Num	Org	Ship-To	Quantity	-Effective-		Break Price	Discount (%)
				From	To		
1		M1- Seattle	0			50	

Line Num  Item

2. Enter a line Number for the shipment line. Purchasing displays the next available line number as the default.
3. Enter the ship to Organization. If you entered an item, you can select *only* organizations in which the item is defined. If you entered a revision number on the purchase order line, then the item revision must also be defined in the organization. See: Purchase Order Defaulting Rules, page 4-10.
4. Enter the Ship To location for the price break. You can select only locations for this organization or locations for which no organization is defined.
5. Enter the minimum Quantity that must to ordered to obtain this price break. The shipment quantity is displayed as the default.
6. Enter the Effective From date or date that this price break becomes effective.
7. Enter the Effective To date or that this price is no longer effective after. This date cannot be less than the date you entered in the Effective From date field.
8. Enter the Break Price at this quantity. Purchasing calculates the Discount % for you.
9. You can optionally enter a Discount % to have the Break Price calculated for you.

## Related Topics

Entering Purchase Order Lines, page 4-46

## Entering Purchase Order Distributions

Use the purchase order Distributions window to enter distribution information for purchase order shipments or to view distributions that Purchasing has automatically created for you. You can enter multiple distributions per shipment line. You can also enter information about paper requisitions in this window.

### To enter purchase order distribution information:

1. Navigate to the Distributions window by selecting the Distributions button in the Shipments window. The Shipments window is accessed from the Purchase Orders window. You begin in the Destination tabbed region.

Num	Type	Requester	Deliver-To	Subinventory	Quantity	P	
1	Expense				10		<input type="checkbox"/>
							<input type="checkbox"/>
							<input type="checkbox"/>
							<input type="checkbox"/>
							<input type="checkbox"/>

**PO Account Descriptions**

Charge   
Accrual   
Budget   
Variance

**Destination Account Descriptions**

Charge   
Variance

**Lines And Shipment Details**

Line Num  Shipment Num  Org  Ship-To   
Item

2. Enter the line Number for the distribution line. If you enter a new distribution line, Purchasing displays the next sequential line number available. You can enter any line number that does not already exist.
3. The destination type determines the final destination of the purchased items. Choose one of the following options:
  - *Expense* - The goods are delivered to the requestor at an expense location. The destination subinventory is not applicable.
  - *Inventory* - The goods are received into inventory upon delivery. You can choose this option only if the item is stock enabled in the ship-to organization.

- *Shop Floor* - The goods are delivered to an outside processing operation defined by Work in Process. You can choose this option only for outside processing items.

If Enterprise Asset Management (EAM) is installed, you can also reserve or encumber funds for shop floor destination type purchase requisitions and purchase orders associated with EAM work orders. For information, refer to the Encumbrance Accounting section in the *Oracle Enterprise Asset Management User's Guide*.

4. Enter the Requestor and Deliver To location for this distribution. If the destination type is Inventory, you can also enter the Subinventory.
5. Enter the Quantity (Amount, if using Oracle Services Procurement) of the purchase order shipment that you want to charge to the Accounting Flexfield. The default value comes from the quantity you enter in the Shipments window. If you decrease the default quantity, Purchasing automatically defaults on the next distribution line the total quantity you have not yet assigned to a distribution line.
6. Enter the purchasing accounts. When you save your changes in this window, Purchasing uses the Account Generator to automatically create the following accounts for each distribution:
  - *Charge*: the account to charge for the cost of this item in the purchasing operating unit
  - *Accrual*: the AP accrual account in the purchasing operating unit
  - *Variance*: the invoice price variance account in the purchasing operating unit
  - *Destination Charge*: the account to charge for the cost of this item in the destination operating unit
  - *Destination Variance*: the invoice price variance account in the destination operating unit

**Note:** The last two accounts are created only if the receiving destination operating unit is different than the purchasing operating unit and there is a transaction flow defined between the two organizations.

If you are using encumbrance control, Purchasing also creates the following account for each distribution:

- *Budget*: the encumbrance budget account

The Account Generator creates these accounts based on predefined rules. See: Using



the Account Generator in Oracle Purchasing, page E-6.

If the destination type is Expense and you are charging an account in your operating unit, the default charge account you enter in the Purchases Order Preferences window overrides the charge account supplied by the Account Generator. You can update the defaulted charge account.

For outside processing lines, the cursor does not enter this field during initial entry, since the Account Generator cannot build accounts until you have entered the Resource Sequence in the Outside Processing window.

For Oracle Public Sector customers using the automatic offset accounting feature the Charge Account will reflect the receiving inspection account based on the Receipt Accounting settings. See: *Defining Purchasing Options*, page 1-33 and *Defining Purchase Order Receipt Accruals*, page 9-120.

7. Override the tax Recovery Rate for taxable items.

The recovery rate is the percentage of tax that your business can reclaim for credit. The recovery rate is based on the information on purchase order Shipments window and the setup in Oracle E-Business Tax.

You can change the recovery rate if the profile option *eBTax: Allow Override of Recovery Rate* is set to Yes. Depending on the setup in Oracle E-Business Tax, only certain recovery rates may be allowed.

You can choose to use a different recovery rate for different distributions, even if they use the same set of applicable tax.

For an overview of tax in Purchasing, see: *Tax Information in Purchasing*, page 4-116.

8. Enter the GL Date you want to use when you reserve your funds. You can enter a GL Date only if you set up your financials system options to use encumbrance or budgetary control for purchase orders. The default is the current date. See: *About Financials Options, Oracle Payables User's Guide*. See: *Budgetary Control and Online Funds Checking, Oracle General Ledger User's Guide*.

If you enter a date that belongs to two separate accounting periods, Purchasing automatically creates a journal entry in the first accounting period that contains this date. See: *Controlling Purchasing Periods*, page 1-82.

The Reserved check box indicates whether you successfully reserved funds for this purchase order distribution. You reserve your distribution when you approve your purchase order. You cannot change any purchase order distribution that you have already encumbered unless you explicitly unreserve the funds. See: *Online Funds Availability Checking*, page 4-5 See: *About Financials Options, Oracle Payables User's Guide* See: *Budgetary Control and Online Funds Checking, Oracle General Ledger User's Guide*.

**To enter distribution detail information:**

1. Select the More tabbed region.
2. The Online check box indicates whether this distribution is part of an on-line requisition. If so, Purchasing displays the requisition number and line number.

If this distribution comes from an on-line requisition, Purchasing displays the Requesting Org, Requisition Number, Line number, and you cannot update these fields. If this distribution does not come from an on-line requisition, enter the paper requisition number in this field. The default is the paper requisition number from the Purchase Order Preferences window.

Purchasing displays the Budget Account, Accrual Account, and Variance Account numbers supplied by the Account Generator. Buyers cannot update these fields as they should be determined by the requesting department, but if you think they are incorrect then return the requisition to the requester. See: Autocreate Purchase Order Options, .

3. Enter the Rate Date for the currency. Purchasing uses this date to obtain the currency conversion rate from your conversion definitions. You cannot enter this field when you edit a purchase order created in your base currency. See: Defining Purchasing Options, page 1-33. See: Entering Daily Rates, *Oracle General Ledger User's Guide*.

**Note:** The Rate Date is a required field for a foreign currency purchase order, to complete the approval process.

4. You can enter the conversion Rate between the foreign currency and the base currency only when the rate type is User. If you entered a rate date for which a conversion rate is defined, Purchasing displays that rate and you cannot change it.

**To view tax information:**

- After you have saved the document: Select Manage Tax from the Action menu to see the recoverable and nonrecoverable tax for each line and distribution. See: Viewing Tax Information, page 4-117.

**To enter outside processing information:**

- Select the Outside Services button to open the Purchase Order Outside Services window. See: Entering Outside Services Information, page 4-79.

**Project tabbed region:**

- If your organization has implemented Oracle Projects, Oracle Project Manufacturing, or Oracle Grants use the Project tabbed region to enter additional information for those products. See: Project Tab, page 3-47

## Related Topics

- Tools Menu Options, page 4-44
- Inquire Menu Options, page 4-45
- Entering Purchase Order Shipments, page 4-67
- Changing Encumbered Documents, page 4-113

## Entering Outside Services Information

Use the Outside Services window to review and enter outside processing or outside services information for document lines.

### To enter outside processing information:

1. Navigate to the Outside Services window by selecting the Outside Services button in the Requisitions window and the Purchase Orders Distributions window when you've selected a line type of Outside Processing. See: Entering Requisition Lines, page 3-51. See: Entering Purchase Order Distributions, page 4-75.

The screenshot shows a software window titled "Outside Processing (1) - Distribution 1". It contains the following fields and values:

- Job: OSP JOB6
- Line: (empty)
- Assembly: (empty)
- Operation:
  - Sequence: 20
  - Code: (empty)
  - Department: OSP DEPT2
- Resource:
  - Sequence: 10
  - UOM: HR
  - Resource Qty: 1
- Unit Type: Assembly
- Assembly Qty: 1

Buttons: Done, Cancel

2. Enter the Job or repetitive Assembly that uses this outside processing operation. For an assembly, you can *also* enter the production Line. Use this to choose a schedule with the earliest first unit start date. **Note:** If this is an Enterprise Asset Management controlled item, only work order information can be entered.
3. Enter the operation Sequence number of the outside processing operation. Purchasing displays the operation Code and the Department.
4. Enter the Sequence number of the resource the outside processing operation uses. Purchasing displays the resource UOM and Quantity. Purchasing also displays the Unit Type and Assembly Quantity.

5. Select the Done button to apply your entries and return to the window from which you came.

**To cancel your entries:**

- Select the Cancel button to cancel your entries and return to the window from which you came.

## Related Topics

Requisitioning Outside Process Items, *Oracle Work in Process User's Guide*

Creating Outside Processing Purchase Orders, *Oracle Work in Process User's Guide*

## Entering Purchase Order Notification Controls

Use the Notification Controls window to enter notification controls for planned purchase orders, contract purchase agreements, and blanket purchase agreements. For these documents, you can establish expiration and release control notification conditions and specify the number of days before the condition is met that you want to be notified. When the notification conditions are met, Purchasing sends you an alert, using Oracle Alert (or e-mail).

**To enter notification controls:**

1. Select Notification Controls on the Tools menu in the Purchase Orders window to open the Notification Controls window and display any existing controls. The Notification Controls option is active on the menu only when there is no unsaved information for the purchase order.

Condition	Warning Delay	Effective		%	Amount
		From	To		
			12-OCT-2006		

2. Enter one of the following notification Conditions:
  - *Amount Not Released* - If you choose this condition, you can optionally specify effective and expiration dates, but you must specify the amount not released.
  - *Amount Released* - If you choose this condition, you can optionally specify the effective and expiration dates, but you must specify the amount released.
  - *Expiration* - Before you can use this condition, you must have specified an expiration date for the purchase order in the Details window. If you choose this condition, you must enter an effective date, and you can optionally enter an expiration date.
3. Enter the Warning Delay. This is the number of days before the expiration date that you want to be alerted. The warning delay is applicable only to the Expiration condition and helps you calculate the effective date.
4. Purchasing calculates the Effective Date based on your warning delay and the expiration date, but you can change this date. The effective date is required for the Expiration condition.
5. Purchasing displays the Expiration Date from the Terms and Conditions region as the default, but you can change this date.

**Important:** If you do not enter an expiration date and your condition continues to be met, the alert will be issued forever. Therefore, we recommend entry of an expiration date.

6. The Percent field is applicable only when you have already entered an order line. For the Amount Released (or Not Released) conditions, you can enter a percentage of the order line total, and Purchasing calculates the amount.
7. When the amount released (or not released) reaches the Amount you enter here, Purchasing sends you an alert. If you have already entered an order line, Purchasing calculates the percentage and displays it in the Percent field.
8. Select the Done button to save your work and return to the Purchase Orders window.

**To cancel your entries:**

- Select the Cancel button to cancel your entries and return to the Purchase Orders window.

## Related Topics

Using Oracle Alert in Oracle Purchasing, page B-1

Entering Purchase Order Headers, page 4-40

## Entering and Viewing Purchase Order Acceptances

Use the Acceptances window to view and enter purchase order acceptances from your suppliers. The original copy of the purchase order you send to the supplier is a legal offer to buy. A binding purchase contract does not exist until the supplier accepts your offer either by performing the contract or formally accepting the offer by returning an acceptance document to you.

You indicate on your standard purchase orders, purchase agreements, and releases whether you require your suppliers to accept your orders by a specific date. Purchasing notifies you in the Notifications Summary window of the orders for which the suppliers have not responded by the acceptance due date.

**To view acceptances:**

- Navigate to the Acceptances window by selecting Acceptances from the Tools menu in the Purchase Orders, Releases, and Purchase Order Summary windows when you do not have a purchase order open. Purchasing displays the Acceptances window with all previously accepted purchase orders for review.

**To enter acceptances:**

1. Navigate to the Acceptances window by selecting Acceptances from the Tools menu in the Purchase Orders or Releases windows.

Action	Rev	Action Date	Acceptance Party			Accepted	Acceptance Type	Signature	Comments
			Accepted By	Role					
	0	13-JUL-2004				<input type="checkbox"/>			
						<input type="checkbox"/>			
						<input type="checkbox"/>			
						<input type="checkbox"/>			
						<input type="checkbox"/>			
						<input type="checkbox"/>			
						<input type="checkbox"/>			
						<input type="checkbox"/>			
						<input type="checkbox"/>			
						<input type="checkbox"/>			

You can accept only purchase orders and releases that you approved at least once and that are not closed.

2. In the Action field, enter the results of your supplier follow-up. You can easily record the type of follow-up you performed such as Follow-up telephone call, Follow-up letter, or Fax follow-up. You can also use this field to record the outcome of the follow-up such as Will call back, No answer, Schedule slippage, or Cannot fulfill order.
3. Enter the Revision number. The default is the current revision. Purchasing removes the notification from the Notifications Summary window only when you record the acceptance of the most recent revision.
4. Enter the Action Date for the acceptance transaction. Today's date is the default, but you can enter any date.
5. Enter the Accepted By person. Your name is the default.
6. Enter the Role or title of the accepting person.
7. Select Accepted to indicate that the supplier accepted the purchase order. If you accept the most recent revision, Purchasing removes the acceptance requirement and the acceptance date from your purchase order or release. Purchasing also deletes the corresponding notification from the Notifications Summary window if any late acceptance notification exists for this order.
8. Enter an Acceptance Type for the acceptance. You can define your own acceptance types, or use one of the following that Purchasing provides. See: Defining Lookup Codes, page 1-55.
  - *Accepted All Terms* - The supplier accepted all the terms of the purchase order.
  - *On Schedule* - The supplier agreed to meet the delivery dates on the purchase order.

- *Unacceptable Changes* - The supplier made modifications to the terms of the purchase order that you do not find acceptable.

9. Click OK to save your entries.

**To enter or view eSignature details:**

- If Oracle Procurement Contracts and Oracle Quality eRecords are implemented, you can view the details of the electronic signatures from the Acceptances window by selecting eSignature Details in the Tools menu.

The electronic signature feature of Oracle Procurement Contracts is enabled for a specific document and requires that both the supplier and the buyer provide eSignatures before the document can be approved. Once the eSignatures have been entered you must check Signatures Complete. See: Entering Purchase Order Details Information, page 4-61.

## Related Topics

Entering Purchase Order Headers, page 4-40

Entering Release Headers, page 4-84

## Entering Releases

### Entering Release Headers

Use the Releases window to enter, edit, and approve releases against blanket purchase agreements or planned purchase orders.

**To enter release headers:**

1. Navigate to the Releases window from the menu or by clicking New Release in the Find Purchase Orders window.



2. Select the Operating Unit for the release.
3. Enter the PO number for the release you want to create. The list of values displays all blanket and planned purchase order numbers that have been approved, the document type, status, supplier, buyer, and effectivity date range (global agreements are not available for releases). When you select a purchase order, Purchasing displays the Supplier, Site, and Currency for that order. Purchasing also displays the Status of the release and the current Total amount of the release.

**Note:** Purchasing displays a P-Card number if the purchase order used one. A procurement card purchase order is created from a iProcurement requisition that used a corporate credit card for the purchase. This field displays if the profile option *PO: Use P-Cards in Purchasing* is set to Yes. Only the last four digits of the procurement card are displayed. Procurement cards can be used for items with a Destination Type of Expense, for documents that do not contain a Project number, and for standard purchase orders or releases only.

4. Purchasing displays the next Release number available. Until you have saved your release, you can change the release number to any number that does not already exist.
5. If the Enforce Buyer Name option in the Purchasing Options window is set to Yes, your name is displayed as the Buyer, and you cannot change this value. Otherwise, you can enter the name of any buyer. See: Defining Control Options, page 1-34.

6. Enter release shipment line information in the Shipments tabbed region. See: Entering Purchase Order Shipments, page 4-67

**To take approval actions:**

- Select the Approve button to open the Approve Documents window. See: Submitting a Document for Approval, page 2-32.

**To enter receiving control information:**

- Select the Receiving Controls button to open the Receiving Controls window. See: Entering Purchase Order Receiving Controls, page 4-71.

**To enter release distribution information:**

- Select the Distributions button to open the Distributions window. See: Entering Release Distributions, page 4-93.

**To view blanket purchase agreement information:**

- Select the Agreement button to view blanket agreement information for the release. See: Entering Purchase Order Details Information, page 4-61.

## Tools Menu Options

**To enter and view acceptances:**

- Select Acceptances on the Tools menu to open the Acceptances window. See: Entering and Viewing Purchase Order Acceptances, page 4-82.

**To view supplier details:**

- Select View Supplier Address from the Tools menu to view the complete supplier name and address for the release.

If budgetary controls are enabled you can unreserve encumbered funds for your release. See: Online Funds Availability Checking, page 4-5

**To release encumbered funds:**

1. Select Unreserve from the Tools menu.
2. Enter the Unreserve Date.
3. Check Use Document GL Date to Unreserve to use the document's distribution GL dates for the funds reversal instead of the unreserve date.
4. Click OK to reverse the the funds reservation on this document.

**To cancel the release:**

- You can cancel an approved release by selecting Cancel from the Tools menu. See: Document Control Options, page 2-41

**To view action history:**

- Select View Action History on the Tools menu to open the Action History window.

See: Viewing Action History, page 10-1.

**To enter preferences:**

- Select Preferences on the Tools menu. See: Entering Purchase Order Preferences, page 4-37

## Related Topics

Entering Release Shipments, page 4-87

Entering Release Distributions, page 4-93

Procurement Card Purchase Orders and Releases, page 4-118

## Entering Release Shipments

Use the Shipments tabbed region to enter shipment lines for planned and blanket releases and to edit shipments that Purchasing automatically generated for you. (See: Automatic Release Generation, page 4-96) A purchase order shipment specifies the quantity, ship-to location, date you want your supplier to deliver the items on a purchase order line, and country of origin for the items.

**To enter release shipment information:**

1. Navigate to the Shipments tabbed region in the Releases window.

The first tabbed region is the Shipments region. In addition to the enterable fields discussed in the following steps, this region displays the UOM, the Originally Promise date (if the Promised date has been changed, the original promised date is displayed here), the Charge Account, the shipment Amount, and a check box to indicate whether funds have been Reserved. See: Budgetary Control and Online Funds Checking, *Oracle General Ledger User's Guide*.

2. Enter the line Number for the shipment line. If you enter a new shipment line, Purchasing displays the next sequential line number available. You can enter any line number greater than zero that does not already exist.
3. Enter the source Line number. The list of values includes the item number, revision, and description.
4. For scheduled releases only, you can enter the source Shipment. This is the planned purchase order shipment against which you want to issue a release. The details from the shipment are used as defaults for the scheduled release shipment.
5. Enter the ship-to Organization. If you picked a line with an item, you can pick only organizations in which the item is defined. If you picked a revision number on the purchase order line, the item revision must also be defined in the organization. For scheduled releases (against planned purchase orders), you cannot change the default organization from the planned purchase order shipment. Note that you cannot update the organization once you have saved your work.
6. Enter the Ship-To location for the shipment. You can pick any location that does not have an organization or any location whose organization matches the organization in the previous field. See: Purchase Order Defaulting Rules, page 4-10 For blanket releases, Purchasing defaults the ship-to location from the Release Header zone. For scheduled releases, Purchasing gets default information from the planned purchase order shipment.
7. Enter the Quantity (Amount, if using Oracle Services Procurement) for the

shipment. This value must be greater than zero.

8. Enter the Price you want to use for this shipment. Purchasing displays the actual price for the shipment from the purchase order line price for the item. The actual price defaults from the purchase agreement line.

You can use list of values to choose purchase agreement price breaks. If your purchase agreement has price breaks, the quantity entered here determines what break price is defaulted into the Price field. The cursor does not enter this field when you are editing an existing line.

If you allow price override for this purchase order line in the Purchase Orders window, the release price cannot exceed the price limit specified for the line. If you allow price override but did not enter a price limit, Purchasing does not check the shipment price for the releases. If you do not allow price override, Purchasing displays the shipment price from the purchase agreement and prevents you from navigating to this field. This field can be defaulted from the purchase agreement price breaks if you have entered a sufficient quantity.

**Note:** If you manually override the defaulted price, Oracle Purchasing does not recalculate the price when pricing related changes are made to the release.

9. Enter the date and time that the supplier promised delivery of the items in the Promised field.
10. Enter the Need By date and time when the requester needs the item. The default is from the Purchase Order Preferences window.

If you use Purchasing with Master Scheduling/MRP, you must provide a need-by date or promised date for shipments that correspond to purchase order lines with Master Scheduling/MRP planned items. You must also provide a need-by date or promised date for Inventory planned items. See: *Overview of Implementing Planning Recommendations, Oracle Master Scheduling/MRP and Supply Chain Planning User's Guide*.

11. Optionally choose or change the Note for Receiver.

The Note for Receiver is a note which will be displayed at the time of receipt for this shipment.

The Note for Receiver displayed here defaults from the requisition line that this release was created from. Otherwise, this field is blank.

12. Optionally choose or change the Country of Origin.

The Country of Origin is the country in which an item is manufactured.

For a scheduled release, the Country of Origin defaults from the planned purchase

order. For a blanket release, the Country of Origin defaults from the Approved Supplier List, if it is defined there. If not, it defaults from the supplier site in the Supplier Sites window. Otherwise, this field is blank. You can leave it blank or choose a country.

If you do not know the originating country, you can enter or change the Country of Origin later on the receipt.

13. If you are a process manufacturing user and the Oracle Process Manufacturing (OPM) application is installed, then the Oracle Purchasing for Process Inventory functionality is enabled. If the selected purchasing organization is a process organization, then the three process fields the Secondary UOM, Secondary Quantity, and Grade are enabled. For more information on these fields see: *Entering OPM Line Information*, page 3-57.

**To display and enter more shipment information:**

1. Select the More tabbed region in the Releases window.
2. Enter the Receipt Close Tolerance percent for your shipments. Purchasing automatically closes a shipment for receiving if it is within the receiving closing tolerance at the receiving close point. You need to set the receiving close point in the Purchasing Options window. See: *Defining Control Options*, page 1-34
3. Enter the Invoice Close Tolerance percent for your shipments. Purchasing automatically closes a shipment for invoicing if it is within the invoicing closing tolerance at billing, when Payables matches invoices to purchase orders or receipts. See: *Defining Control Options*, page 1-34
4. Select one of the following options for Match Approval Level:
  - *Two-Way Matching*: Purchase order and invoice quantities must match within tolerance before the corresponding invoice can be paid.
  - *Three-Way Matching*: Purchase order, receipt, and invoice quantities must match within tolerance before the corresponding invoice can be paid.
  - *Four-Way Matching*: Purchase order, receipt, accepted, and invoice quantities must match within tolerance before the corresponding invoice can be paid.

If you enter an item, the default value for this field comes from the item information at the organization level. If not defined there, the default comes from the item information at the master level. If you do not enter an item, the default is from your Purchasing Options. See: *Receiving Controls, Options, and Profiles*, page 9-7.

5. Select an Invoice Match Option:
  - *Purchase Order*: Payables must match the invoice to the purchase order.

- *Receipt:* Payables must match the invoice to the receipt.

Choose Receipt if you want to update exchange rate information on the receipt or if you want your accounting to use exchange rate information based on the receipt date. (If you use Periodic Costing, you must match to the receipt to ensure accurate cost accounting.)

The Invoice Match Option defaults from the Supplier Sites window. You can change the Invoice Match Option on the shipment until you receive against the shipment.

**Note:** The Invoice Match Option and the Match Approval Level are independent options. You can perform whichever Invoice Match Option you want regardless of the Match Approval Level.

See: *Entering Purchase Order Matched Invoices, Oracle Payables User Guide* .

6. Select Accrue at Receipt to indicate that the items on this purchase order line accrue upon receipt. Shop Floor and Inventory destined items always accrue upon receipt, and you cannot change this default. For expense items, if the Accrue Expense Items flag in the Purchasing Options window is set to Period End, the items cannot accrue upon receipt, and you cannot change the default. If the Accrue Expense Items flag is set to At Receipt, the default is to accrue upon receipt, but you can change it to not accrue upon receipt. See: *Defining Accrual Options*, page 1-40.

**Important:** If you are using Cash Basis Accounting, you should use the Purchasing Options window to set the Accrue Expense Items flag to Period End, and you should not select Accrue on Receipt in this window.

7. Select Firm to firm the shipment to indicate to Master Scheduling/MRP or your manufacturing application that it should not reschedule this release shipment.

**To display status information:**

- Select the Status tabbed region.

For each shipment, Purchasing displays the Status and the quantity Ordered, Received, Cancelled, and Billed.

**To display item information:**

- Select the Item tabbed region in the Releases window.

For each shipment, Purchasing displays the Item number, purchasing category, item description, supplier item number, and the VMI checkbox.

**To view drop ship information:**

- If the shipment is part of a drop ship order select the Drop Shop tabbed region.

For each shipment, Oracle Purchasing displays Sales Order and Line Number, Ordered Quantity, Shipped Quantity, Sales Order Status, Ship To Customer Name, and Ship To Customer Contact.

- If the shipment is part of a drop ship order you may also view the sales order in Oracle Order Management by selecting View Sales Order from the Tools menu.

**To take approval actions:**

- Select the Approve button to open the Approve Documents window. See: Submitting a Document for Approval, page 2-32.

**To enter receiving control information:**

- Select the Receiving Controls button to open the Receiving Controls window. See: Entering Purchase Order Receiving Controls, page 4-71.

**To view and enter agreement details information:**

- Select the Agreement button to view and enter blanket agreement information for the release. See: Entering Purchase Order Details Information, page 4-61.

**To enter distribution information:**

- Select the Distributions button to open the Distributions window. See: Entering Release Distributions, page 4-93.

## Tools Menu Options

**To recalculate prices:**

- If you have manually changed the price and then you have changed price related attributes of a line (for example: ship to organization or need-by date), you can have Oracle Purchasing recalculate the price by selecting Recalculate Price from the Tools menu.

**To cancel the release shipment:**

- You can cancel an approved release shipment by selecting Cancel from the Tools menu. See: Document Control Options, page 2-41

**To view tax information:**

- Select Manage Tax from the Tools menu to see recoverable and nonrecoverable tax details for each shipment and distribution. See: Viewing Tax Information, page 4-117.

## Related Topics

Tools Menu Options, page 4-92

Entering Release Headers, page 4-84

Entering Release Distributions, page 4-93

Entering Purchase Order Preferences, page 4-37



## Entering Release Distributions

Use the release Distributions window to enter distribution information for release shipments or to view distributions that Purchasing has automatically created for you. You can enter multiple distributions per shipment line. You can also enter information about paper requisitions in this window.

### To enter release distribution information:

1. Navigate to the Distributions window by selecting the Distributions button in the Releases window.

Num	Source	Destination Type	Requester	Deliver-To	Subinventory	
1		Inventory				1

**Account Description**

Charge	<input type="text"/>	Budget	<input type="text"/>
Accrual	<input type="text"/>	Variance	<input type="text"/>

Outside Services

2. Enter the line Number for the distribution line. If you enter a new distribution line, Purchasing displays the next sequential line number available. You can enter any line number greater than zero that does not already exist.
3. For scheduled releases only, enter the Source (the planned purchase order distribution you want to release).
4. The Destination Type determines the final destination of the purchased items. Choose one of the following options:
  - *Expense* - The goods are delivered to the requestor at an expense location. The destination subinventory is not applicable.
  - *Inventory* - The goods are received into inventory upon delivery. You can choose this option only if the item is stock enabled in the ship-to organization.

- *Shop Floor* - The goods are delivered to an outside processing operation defined by Work in Process. You can choose this option only for outside processing items. If Enterprise Asset Management (EAM) is installed, you can use this destination for one-time (description based) and non-stocked items to be delivered to a maintenance work order location. You can also reserve or encumber funds for shop floor destination type purchase requisitions and purchase orders associated with EAM work orders. For information, refer to the Encumbrance Accounting section in the *Oracle Enterprise Asset Management User's Guide*.
5. Enter the Requestor and Deliver To location for this distribution. If the destination type is Inventory, you can also enter the Subinventory.
  6. Enter the Quantity (Amount, if using Oracle Services Procurement) of the purchase order shipment that you want to charge to the Accounting Flexfield. The default value comes from the quantity you enter in the Shipments region. If you decrease the default quantity, Purchasing automatically defaults on the next distribution line the total quantity you have not yet assigned to a distribution line. This quantity is printed on the release.
  7. Enter the Charge Account. When you save your changes in this window, Purchasing uses the Account Generator to automatically create the following three accounts for each distribution:
    - Charge: the account to charge for the cost of this item
    - Accrual: the AP accrual account
    - Variance: the invoice price variance accountIf you are using encumbrance control, Purchasing also creates the following account for each distribution:
    - Budget: the encumbrance budget account
  8. The Account Generator creates these accounts based on predefined rules. See: Using the Account Generator in Oracle Purchasing, page E-6.

You cannot create or update these accounts manually unless the destination type is Expense. In this case, the default charge account you enter in the Purchases Order Preferences window overrides charge account supplied by the Account Generator, and you can update the charge account in this zone.

For outside processing lines, the cursor does not enter this field during initial entry, since the Account Generator cannot build accounts until you have entered the Resource Sequence in the Outside Services window.
  9. Override the tax Recovery Rate for taxable items.

The recovery rate is the percentage of tax that your business can reclaim for credit. The recovery rate is based on the release shipment and the setup in Oracle E-Business Tax .

You can change the recovery rate if the profile option *eBTax: Allow Override of Recovery Rate* is set to Yes. Depending on the setup in Oracle E-Business Tax, only certain recovery rates may be allowed..

You can choose to use a different recovery rate for different distributions, even if they use the same set of applicable tax.

For an overview of tax in Purchasing, see: Tax Information in Purchasing, page 4-116.

10. Enter the GL Date you want to use when you reserve your funds. You can enter a GL Date only if you set up your financials system options to use encumbrance or budgetary control for purchase orders. The default is the current date. See: About Financials Options, *Oracle Payables User's Guide*. See: Budgetary Control and Online Funds Checking, *Oracle General Ledger User's Guide*.

If you enter a date that belongs to two separate accounting periods, Purchasing automatically creates a journal entry in the first accounting period that contains this date. See: Controlling Purchasing Periods, page 1-82.

The Reserved check box indicates whether you successfully reserved funds for this purchase order distribution. You reserve your distribution when you approve your purchase order. You cannot change any purchase order distribution that you have already encumbered unless you explicitly unreserve the funds in the Approve Document window. See: Submitting a Document for Approval, page 2-32. See: About Financials Options, *Oracle Payables User's Guide* See: Budgetary Control and Online Funds Checking, *Oracle General Ledger User's Guide*.

**To enter distribution detail information:**

1. Select the More tabbed region.

The Online check box indicates whether this distribution is part of an on-line requisition. If so, Purchasing displays the requisition number and line number.

2. If this distribution comes from an on-line requisition, Purchasing displays the Requisition Number and Line number, and you cannot update this field. If this distribution does not come from an on-line requisition, enter the paper requisition number in this field. The default is the paper requisition number from the Purchase Order Preferences window.

Purchasing displays the Budget Account, Accrual Account, and Variance Account numbers supplied by the Account Generator.

3. Enter the Rate Date for the currency. Purchasing uses this date to obtain the currency conversion rate from your conversion definitions. You cannot enter this field when you edit a purchase order created in your base currency. See: Defining

Purchasing Options, page 1-33. See: *Entering Daily Rates, Oracle General Ledger User's Guide*.

4. You can enter the conversion Rate between the foreign currency and the base currency only when the rate type is User. If you entered a rate date for which a conversion rate is defined, Purchasing displays that rate and you cannot change it.

**Project tabbed region**

- If your organization has implemented products which depend on tracking project related information, you can use the Project tabbed region to enter additional information for those products. For instructions see: *Project Tab, page 3-47*

**To view tax information:**

- Select Manage Tax from the Tools menu to see recoverable and nonrecoverable tax details for each shipment and distribution. See: *Viewing Tax Information, page 4-117*.

**Related Topics**

*Release Tools Menu Options, page 4-92*

*Entering Release Headers, page 4-84*

*Entering Release Shipments, page 4-87*

*Viewing Action History, page 10-1*

*Entering Purchase Order Preferences, page 4-37*

## **Automatic Release Generation**

You can minimize purchase order administrative costs by automatically creating releases for both manually entered and imported requisitions.

Purchasing provides you with the features you need to satisfy the following basic needs. You should be able to:

- Automatically create a release when you source your items from a single supplier using a single blanket purchase agreement.
- Specify for each blanket agreement whether you want to create approved releases automatically, create releases automatically but require manual approval, or require the use of the AutoCreate Documents window to create releases.
- Run the Create Release process automatically as part of the Requisition Import process.

## Major Features

### Flexible Sourcing Definitions

When you are defining your sourcing rules and Approved Supplier List entries, you can also define how you want your releases generated. Automatic Release automatically converts approved requisition lines to approved blanket purchase releases based on the sourcing rules and Approved Supplier List entries. Automatic Release/Review automatically converts approved requisition lines to blanket releases. Buyers can then review and modify these releases before approving them. Release Using Autocreate lets buyers use the AutoCreate Documents window to collect, review, and optionally modify requirements before creating and approving their releases. See: Autocreating Documents Overview, page 6-1.

You can define a different release generation method for each item and supplier. For frequently purchased items, you can set up Purchasing to automatically create and approve releases. For expensive or critical items, you can let Purchasing create the releases, while you review and approve them in a separate step. For infrequent purchases, your buyers can take more control by using the AutoCreate Documents window to combine requests.

You must set up a suggested blanket purchase agreement in the Approved Supplier List window so that Purchasing can use the price and ship-to information when it is generating releases against the agreement. See: Defining the Supplier/Item Attributes, page 5-43.

### Generate Releases Automatically

The Create Releases process generates releases when the following criteria are met:

- The requisition is sourced to an approved blanket purchase agreement that is not on hold
- The Approved Supplier List entry for the item, supplier, and agreement must be active, and the Release Generation method must be Automatic Release or Automatic Release/Review in the Approved Supplier List window
- The source agreement is still active and the release will not put the agreement over the amount limit
- The release amount must be greater than the minimum line release amount
- The supplier on the source agreement is active and not on hold
- The requisition line is Approved (and Reserved, if requisition encumbrance is active)

- The requisition line is not cancelled, closed, or already on a purchase order
- The line type of the requisition line is quantity based

**Note:** If the release generation method in the Approved Supplier List window is Automatic Release or Automatic Release/Review, then the Create Releases process creates the release. If the release generation method is Release Using AutoCreate, then the PO Create Documents workflow tries to create the release; if it cannot, then you must use the AutoCreate Documents window to create the release.

If the release generation method is Automatic Release, the process sets the status to Approved and updates the action history. Otherwise, the process sets the status to Incomplete and updates the notifications.

Purchasing automatically creates releases for requirements entered by any source: Work in Process, Master Scheduling/MRP, Inventory Planning, purchase requisitions, or external systems.

For foreign currency blanket purchase agreements, the automatic release process uses the rate on the agreement as the default rate for the release and translates the functional unit price on the requisition into the foreign currency price. Automatically generated releases use the price retrieved by sourcing, which is price break sensitive but does not consider the quantity already released against the blanket purchase agreement.

The Create Releases process creates a release for each source blanket purchase agreement, with a release shipment for each requisition line and a release distribution for each requisition distribution. If release archiving is set to Approve, the process updates the archive table for the release, shipments, and distributions. See: Create Releases Process, page 13-5.

If you've set up tax in Oracle E-Business Tax, the appropriate taxes automatically default onto the release shipments created by the Create Release process. See: Tax Information in Purchasing, page 4-116.

## Variable Release Generation Frequency

You can determine how often Purchasing creates releases by using the Submit Requests window to set the Create Releases process to run automatically at any frequency you desire. You can also use the Submit Requests window to run the process manually.

Optionally, you can set the profile PO: Release During ReqImport to create releases each time you run the Requisition Import process. For example, when you implement planned orders as requisitions in the MRP Planner Workbench, you can automatically create the releases at the same time you create the requisitions. As part of the Requisition Import process, Purchasing automatically creates (and optionally approves) releases for *all* blanket-sourced, approved requisitions, not just those created by the Requisition Import run.

## See Also

AutoCreate Documents Overview, page 6-1

Workflow for Creating Purchase Orders or Releases, page E-161

Profile Options in Purchasing, page C-1

Automatic Sourcing, page 5-24

Create Releases Process, page 13-5

Requisition Import Process, page 13-29

Submitting a Request, *Oracle Applications System Administrator's Guide*

## Copying Purchase Orders

You can copy the following purchase order types from one document to the other:

<b>From</b>	<b>To</b>
Standard purchase order	Standard purchase order
Blanket purchase agreement	Blanket purchase agreement
Blanket purchase agreement	Request for quotation
Blanket purchase agreement	Global blanket purchase agreement
Planned purchase order	Planned purchase order
Contract purchase agreement	Contract purchase agreement
Contract purchase agreement	Request for quotation
Contract purchase agreement	Global contract purchase agreement
Bid quotation (Bid quotation class)	Standard or planned purchase order
Self-defined Bid quotation (Bid quotation class)	Standard or planned purchase order
Catalog or Standard quotation (Catalog quotation class)	Blanket purchase agreement

<b>From</b>	<b>To</b>
Self-defined Catalog or Standard quotation (Catalog quotation class)	Blanket purchase agreement
Global blanket purchase agreement	Global blanket purchase agreement
Global contract purchase agreement	Global contract purchase agreement

For example, if you want to renew a blanket purchase agreement that contains hundreds of lines, you can copy the previous agreement to a new agreement and change the effectivity dates.

**Important:** Even though a document is listed in the above table you may be restricted from copying it due to security settings, line type restrictions, or other restrictions. Oracle Purchasing provides an error message when you attempt a restricted copy.

**To copy documents:**

1. Query the document you want to copy from the Purchase Orders, Purchase Order Summary, or Quotations windows.
2. With the document selected, choose Copy Document from the Tools menu.

The source document type and number is displayed in the From region of the Copy Document window. If you are copying a global agreement the Global checkbox will be checked.



The screenshot shows a 'Copy Document' dialog box with the following fields and options:

- From:**
  - Document Type: **Blanket Purchase Agreement**
  - Global
  - Document Number: **10186**
- To:**
  - Document Type: **Blanket Purchase Agreement**
  - Global
  - Document Number: [Empty field]
  - Copy Attachments
  - Copy Blanket Price to RFQ

Buttons: OK, Cancel

3. Select an eligible To Document Type.

You can change the To Document Type only if you're copying from a bid class quotation, a blanket purchase agreement, or a contract purchase agreement.

If you select a blanket purchase agreement or a contract purchase agreement and the from document is a global agreement you can not change the Global box.

4. Select other document options if needed.

*Document Number:* Enter a document number only if you use manual numbering. If you use automatic numbering, a document number will be created for you after you choose OK. You cannot use the Copy Documents window to modify documents by copying from one document to another with the same document number.

*Copy Attachments:* Check this box to copy an attachment from any level of the document.

*Copy Blanket Price to RFQ:* Check this box to copy the purchase price to the target price when copying a blanket agreement to an RFQ (request for quotation).

5. If Oracle Procurement Contracts is implemented you can select the source for Contract Terms (copy clauses and deliverables):
  - *Copy Latest Clauses from Library*: Check this box to copy the most recent version of clauses from the library.
  - *Copy Current Clauses from Document*: Check this box to copy the clauses as they exist in the From document.
  - *Do Not Copy Contract Terms*: Check this box to copy the document with no contract terms.

6. Choose OK.

Purchasing creates and displays the new document. A copied document has similar restrictions regarding modifications as a new document that has been saved. The document is an exact copy of the original except for the Promised By and Need By dates; if these dates are past dates, they change to today's date on the new document. Effectivity dates, if any, do not change.

If you use encumbrance accounting, GL dates are not be copied and default as today's date on the new document.

If you are copying a cancelled document, the Note to Supplier field will be blank. This is because a cancelled document changes the Note to Supplier to an explanation that the document was cancelled. Therefore, when you copy the cancelled document, the Note to Supplier is left blank.

7. Modify the document if you need to.

When you copy a quotation to a purchase order, project and task information from the quotation, if any, is copied to the purchase order distribution when you create the distribution or save the purchase order. (This is because project information is associated with the quotation line, but must be associated with the distribution on the purchase order.)

Information from the copied document overrides any information in the purchase order preferences, if you are copying to a purchase order.

8. Save and approve the document.

If information in the document you have just copied is invalid or outdated-for example, if a supplier or account is inactive or invalid-a message window appears after you choose Approve. Use this window to help you identify and correct invalid or outdated fields in the new document you're creating. You cannot approve the document until you update these fields appropriately.

## Related Topics

Defining Document Types, page 1-67

Types of Quotations and RFQs, page 5-5

Copying Quotations from RFQs, page 5-74

## Document Revision Numbering

You can create *multiple* revisions of your purchasing documents (planned and standard purchase orders and blanket and contract purchase agreements). Use the Document Types window to set whether each of these documents is archived upon approval or upon printing. All revisions begin at 0, and Purchasing increments this revision number by 1 when you make changes to controlled information and the current revision number is equal to the archived number. As a result, the first revision that you print might not be 0 if you are archiving on approval. See: Defining Document Types, page 1-67.

The following examples illustrate the difference between archiving on approval and on printing:

### ***Archiving On Approval***

<b>Action</b>	<b>Archive Rev</b>	<b>Current Rev</b>
Step 1. Create purchase order	None	0
Step 2. Approve purchase order	0	0
Step 3. Change controlled information	0	1
Step 4. Approve purchase order	1	1
Step 5. Print purchase order	1	1

### ***Archiving On Print***

<b>Action</b>	<b>Archive Rev</b>	<b>Current Rev</b>
Step 1. Create purchase order	None	0
Step 2. Approve purchase order	None	0
Step 3. Change controlled information	None	0

<b>Action</b>	<b>Archive Rev</b>	<b>Current Rev</b>
Step 4. Approve purchase order	None	0
Step 5. Print purchase order	0	0
Step 6. Change controlled information	0	1
Step 7. Approve purchase order	0	1
Step 8. Change controlled information	0	1
Step 9. Print purchase order	1	1

## Document Revision Rules

The following tables describe the additions and changes that cause Purchasing to increment document revision numbers in each of the document components:

<b>Header Information</b>	<b>Standard</b>	<b>Planned</b>	<b>Blanket</b>	<b>Contract</b>	<b>Release</b>
Buyer	X	X	X	X4	X
Contact	X	X	X	X	
Confirm	X	X	X	X	
Ship-To	X	X	X	X	
Bill-To	X	X	X	X	
Payment Terms	X	X	X	X	
Freight Carrier / Ship Via	X	X	X	X	
FOB	X	X	X	X	

<b>Header Information</b>	<b>Standard</b>	<b>Planned</b>	<b>Blanket</b>	<b>Contract</b>	<b>Release</b>
Freight Terms	X	X	X	X	
Brief Note to Supplier	X	X	X	X	
Acceptance Required	X	X	X	X4	4X
Acceptance Due Date	X	X	X	X	X
Amount Limit		X	X	X	
Effective Date		X	X	X	
Expiration Date		X	X	X	
Cancel Flag	X	X	X	X	
Amount Agreed			X	X	
Release Number					X
Release Date					X
Confirming Order	X	X	X	X	X
Oracle Procurement Contracts: Contract Terms	X		X	X	

<b>Line Information</b>	<b>Standard</b>	<b>Planned</b>	<b>Blanket</b>	<b>Contract</b>	<b>Release</b>
Unit Price	X	X	X		
Line Number	X	X	X		
Item	X	X	X		
Item Revision	X	X	X		
Item Description	X	X	X4		
Payment Terms	X	X	X		
Quantity	X	X	X		
Unit of Measure	X	X	X		
Source Quotation Header	X	X	X		
Source Quotation Line	X	X	X		
Hazard Class	X	X	X		
UN Number	X	X	X		
Contract Number	X	X	X		
Supplier Item Number	X	X	X		
Brief Note to Supplier	X	X	X		
Price Type	X	X	X		

<b>Line Information</b>	<b>Standard</b>	<b>Planned</b>	<b>Blanket</b>	<b>Contract</b>	<b>Release</b>
Quantity Agreed			X		
Amount Agreed			X		
Closed Code	X	X	X	X	X
Cancel Flag	X	X	X	X	X
Ship-To Location			X		
Quantity			X		
Break Price			X		
Price Break Number	X	X	X		

<b>Shipment Information</b>	<b>Standard</b>	<b>Planned</b>	<b>Blanket</b>	<b>Contract</b>	<b>Release</b>
Shipment Number	X	X			X
Ship-To	X	X			X
Quantity	X	X			X
Promise Date	X	X			X
Need-By Date	X	X			X
Last Acceptance Date	X	X			X

<b>Shipment Information</b>	<b>Standard</b>	<b>Planned</b>	<b>Blanket</b>	<b>Contract</b>	<b>Release</b>
Taxable	X	X			X
Shipment Price					X
Cancel Flag	X	X			X

<b>Distribution Information</b>	<b>Standard</b>	<b>Planned</b>	<b>Blanket</b>	<b>Contract</b>	<b>Release</b>
Quantity	X	X			X
Requestor	X	X			X
Distribution Number	X	X			X

## Document Reapproval Rules

Documents are unapproved when you add or change specific information, regardless of whether the revision is incremented. Almost all changes that cause the revision to be incremented also unapprove the document, as does placing the document on hold. However, if you change the line level Brief Note to Supplier, cancel the document or its entities, or change the Firm Demand flag or receiver note, the document does not require reapproval.

Controlled changes unapprove either the document header alone, or both the header and its shipments. However, you can continue to receive against approved shipments even when the header is unapproved.

You can also control whether-or how much of-a revision (for example, to Quantity) requires the document to undergo the entire approval process or to be instantly approved. See: Workflow Processes for Approving Change Orders, page E-133.

The following tables describe the additions and changes you can make that cause Purchasing to unapprove a document.



**Header Changes Unapproves Header**

<b>Header Information</b>	<b>Standard</b>	<b>Planned</b>	<b>Blanket</b>	<b>Contract</b>	<b>Release</b>
Buyer	X	X	X	X	X
Contact	X	X	X	X	
Confirm	X	X	X	X	
Ship-To	X	X	X	X	
Bill-To	X	X	X	X	
Payment Terms	X	X	X	X	
Ship via	X	X	X	X	
FOB	X	X	X	X	
Freight Terms	X	X	X	X	
Brief Note to Supplier	X	X	X	X	
Acceptance Required	X	X	X	X	X
Acceptance Due Date	X	X	X	X	X
Amount Limit		X	X	X	
Effective Date		X	X	X	
Expiration Date		X	X	X	

<b>Header Information</b>	<b>Standard</b>	<b>Planned</b>	<b>Blanket</b>	<b>Contract</b>	<b>Release</b>
Amount Agreed			X		
Release Number					X
Release Date					4
Oracle Procurement Contracts: Contract Terms	X		X	X	

***Line Changes Unapproves Header***

<b>Line Information</b>	<b>Standard</b>	<b>Planned</b>	<b>Blanket</b>	<b>Contract</b>	<b>Release</b>
Unit Price	X	X	X		
Line Number	X	X	X		
Item	X	X	X		
Item Revision	X	X	X		
Item Description	X	X	X		
Item Category	X	X	X		
Quantity	X	X	X		
Unit of Measure	X	X	X		

<b>Line Information</b>	<b>Standard</b>	<b>Planned</b>	<b>Blanket</b>	<b>Contract</b>	<b>Release</b>
Source Quotation Header	X	X	X		
Source Quotation Line	X	X	X		
Hazard Class	X	X	X		
Contract Number	X	X	X		
Supplier Item Number	X	X	X		
UN Number	X	X	X		
Price Type	X	X	X		
Price Limit			X		
Quantity Agreed			X		
Amount Agreed			X		
Brief Note to Supplier	X	X	X		
Promised Date	X	X	X		
Need-By Date	X	X	X		
Expiration Date			X		

<b>Line Information</b>	<b>Standard</b>	<b>Planned</b>	<b>Blanket</b>	<b>Contract</b>	<b>Release</b>
Capital Expense	X	X	X		

***Price Break Changes Unapproves Header***

<b>Price Break</b>	<b>Standard</b>	<b>Planned</b>	<b>Blanket</b>	<b>Contract</b>	<b>Release</b>
Ship-To Location			X		
Quantity			X		
Break Price			X		
Discount			X		

***Shipment Changes Unapproves Header and Shipment***

<b>Shipment</b>	<b>Standard</b>	<b>Planned</b>	<b>Blanket</b>	<b>Contract</b>	<b>Release</b>
Shipment Number	X	X			X
Ship-To	X	X			X
Quantity	X	X			X
Promise Date	X	X			X
Need-By Date	X	X			X
Last Acceptance Date	X	X			X

<b>Shipment</b>	<b>Standard</b>	<b>Planned</b>	<b>Blanket</b>	<b>Contract</b>	<b>Release</b>
Taxable (Header only)	X	X			X
Shipment Price					X
Sales Order Update Date (Drop Ship)	X				X

***Distribution Changes Unapproves Header and Shipment***

<b>Distribution</b>	<b>Standard</b>	<b>Planned</b>	<b>Blanket</b>	<b>Contract</b>	<b>Release</b>
Distribution Number (Header Only)	X	X			X
Quantity	X	X			X
Requestor (Header Only)	X	X			X
Charge Account	X	X			X
Subinventory	X	X			X

## Changing Encumbered Documents

You can make changes to a purchase order for which funds have already been reserved (or encumbered). You do this by temporarily reversing the encumbrance the document, making the desired changes, and reserving the document again. The Unreserve action (reversing the encumbrance) takes place at the header level only; it affects all lines on a purchase order, and changes the document's status to Requires Reapproval.

**Note:** If the appropriate approver modifies an encumbered requisition, Purchasing unreserves the requisition automatically.

**To make changes to an encumbered purchase order:**

1. Choose the Approve button.  
The Approve Document window appears.
2. Select Unreserve.  
The Unreserve option is available only if funds are currently reserved for at least one line in your document.
3. Enter an Unreserve Date that falls within an open reserve period.
4. Choose OK.
5. Make your changes to the document and choose Approve again.
6. In the Approve Document window that appears, select Reserve to reserve funds again for the document.
7. Select Submit for Approval and choose OK to resubmit the document for approval.

## Related Topics

Submitting a Document for Approval, page 2-32

Document Reapproval Rules, page 4-108

Overview of Encumbrance Accounting, *Oracle General Ledger User's Guide*

## Drop Shipments

Oracle Order Management and Oracle Purchasing integrate to provide drop shipments. Drop shipments are orders for items that your supplier ships directly to the customer either because you don't stock or currently don't have the items in inventory, or because it's more cost-effective for the supplier to ship the item to the customer directly.

Drop shipments are created as sales orders in Order Management. The Purchase Release concurrent program or workflow in Order Management creates rows in the Requisition Import tables in Purchasing. Then Purchasing's Requisition Import process creates the requisitions. Drop shipments are marked with the Source Type of External in Order Management and Supplier in Purchasing.

Integration between Oracle Purchasing and Oracle Order Management enables you to monitor the details and status of the drop shipment from the purchase order. Details of the drop shipment are included in the purchase order sent to the supplier. Changes to

the sales order in Order Management are automatically reflected on the documents in Oracle Purchasing.

Changes to a purchasing document that references a drop shipped sales order line are not allowed. Examples of changes in Oracle Purchasing that are not allowed are freezing, placing on-hold, and closing for receiving or invoicing of purchase order shipment information. You can cancel or finally close a partially filled drop shipment and the remaining quantity is placed on a requisition. Cancellation of a requisition line already on a sales order is not permitted.

When the drop shipment has been sent to the customer, the supplier can confirm the shipment through a phone call, an invoice, or an Electronic Data Interchange (EDI) document, such as an Advance Shipment Notice (ASN).

When you receive confirmation of a drop shipment, create a receipt against the shipment, even though you have not received the item physically (because your customer has received it directly). Even if your supplier sends an invoice, create the receipt for it. This creates inbound and outbound material transactions in your system for accounting purposes. You can also automatically create a receipt and delivery transaction against the drop shipment

Drop shipments support a destination type of expense or inventory only. Drop shipments only support a receipt routing of direct delivery.

You can handle returns of drop shipments using standard Order Management or Purchasing functionality. There are different ways you may want to handle returns depending on whether the customer returned the item to you or directly to the supplier.

**Note:** You should not drop-ship internal sales orders.

See the section Drop Shipments and the section Drop-Ship Order Flow in the *Oracle Order Management User's Guide*.

## Drop Shipments Across Business Units

Drop shipments across business units, also known as international drop shipments, is supported under the Oracle Center-Led Procurement flow. See: Center-Led Procurement Setup, page 1-79.

## Related Topics

Drop-Ship Return Flow, *Oracle Order Management User's Guide*

Advanced Shipment Notices (ASNs), page 9-15

Returns, page 9-66

Entering Receipt Header Information, page 9-29

Entering Receipt Lines, page 9-30

## Tax Information in Purchasing

Tax information defaults onto requisitions, purchase orders, and blanket releases only if your administrator has completed tax setup in Oracle E-Business Tax. Tax applicability rules along with attributes from the transaction are used in determining the tax for the transaction. For example, you can associate a tax with a ship-to location.

Depending on tax setup, you can override the recovery rate if the profile option *eBTax: Allow Override of Tax Recovery Rate* is set to Yes.

If you use partially recoverable tax, you can view the recoverable and nonrecoverable tax for each shipment and distribution by choosing Manage Tax from the Actions or Tools menu.

## Tax Attributes and Rules

You can set up Oracle E-Business Tax to default tax attributes and determine tax applicability in Oracle Purchasing based on your business needs. See: Setting Up Taxes, *Oracle E-Business Tax User Guide*.

## How Tax Defaults Affect Purchasing Documents

The tax attributes and rules you set up in E-Business Tax operate on transactions in the following windows and processes in Oracle Purchasing:

- Shipments window for standard and planned purchase orders
- Requisition lines in the Requisitions window
- Purchase order line shipments created by the AutoCreate Documents window
- Shipments tabbed region in the Releases window (for blanket releases)
- Release shipments created by the Create Releases process

## Recovery Rate

The tax recovery rate defaults on Oracle Purchasing documents are based on the attributes and rules you set up in E-Business Tax. You can view the tax recovery rate in the Manage Tax window. Override it using the Recovery Rate field is in the following windows:

- Requisition Distributions (for purchase requisitions)
- Purchase order Distributions (for planned and standard purchase orders)



- Release Distributions

The recovery rate is the percentage of tax your business can reclaim for credit. The nonrecoverable portion of the tax is included in the following:

- Encumbrance accounting and receipt or period-end accrual accounting
- Approval limit amounts

See: Overview of Receipt Accounting, page 9-86.

## Related Topics

Setting Up Taxes, *Oracle E-Business Tax User Guide*

Setting Up Tax Recovery Rates, *Oracle E-Business Tax User Guide*

Viewing Tax Information, page 4-117

Entering Taxes on Invoices, *Oracle Payables User's Guide*

## Viewing Tax Information

Use the Manage Tax window to view the total recoverable and non-recoverable tax, as well as tax information for each transaction line. When you enter or change tax attributes on a line or change the Recovery Rate on a distribution, the tax information in the Manage Tax window is recalculated once you save the document.

Use this window to view, not change, tax information. To change tax information, change the tax attributes on the Additional Tax Information window or the Recovery Rate in the document entry window if the profile options *eBTax: Allow Override of Tax Code* and *eBTax: Allow Override of Tax Recovery Rate* are set to Yes, if funds for the purchase order or release are not currently reserved (if you use encumbrance accounting), and if the shipment has not yet been received.

### To view tax details:

- Choose Manage Tax from the Actions or Tools menu, from the Requisitions, Purchase Orders, or Releases windows, or their corresponding Shipments or Distributions windows.

## Related Topics

Tax Defaults in Purchasing, page 4-116

Setting Up Taxes, *Oracle E-Business Tax User Guide*

Setting Up Tax Recovery Rates, *Oracle E-Business Tax User Guide*

Tax Information in Purchasing,

## Procurement Card Purchase Orders and Releases

A procurement card (or P-Card) is a corporate credit card issued to an employee or a supplier P-Card issued against a supplier. The purpose of either the employee or supplier P-Card is to enable the employee to purchase items directly from a supplier. Procurement cards can be assigned to requisitions in iProcurement only. After the requisition is created in iProcurement, a purchase order or release is generated in Purchasing by either the PO Create Documents workflow or by you using AutoCreate, depending on how you've set up Purchasing.

Procurement card purchase orders are approved and transmitted to the supplier like any other purchase order. They are approved through the approval workflows in Purchasing, and you transmit them to the supplier through facsimile, Oracle e-Commerce Gateway, or other method as usual. (The procurement card information itself is transmitted to the supplier through e-Commerce Gateway, through the outbound purchase order transaction.) Upon receiving the purchase order, the supplier transmits the procurement card information to the procurement card issuer (for example, a bank). The credit card issuer then sends transaction files back to Oracle Payables, which automatically generates accounting distributions and creates invoices to pay the issuer.

If a supplier rejects a procurement card order, the buyer can notify the requester of the rejection. The buyer can cancel the purchase order and ask the requester to resubmit the requisition, or re-send the purchase order using a different form of payment.

In Purchasing, you see a procurement card number on a procurement card requisition line in the AutoCreate Documents window (as a hidden field), and in the Purchase Orders, Releases, and Purchase Order Headers windows (if *PO: Use P-Cards in Purchasing* is set to Yes).

You cannot create a procurement card purchase order or release manually. Purchasing creates a procurement card purchase order or release through the PO Create Documents workflow or the AutoCreate Documents window, depending on your Purchasing setup. See: *Workflow Setup Options*, page 1-85.

Procurement card purchase orders and releases can be created only from requisition lines in iProcurement. To use procurement card purchase orders or releases in Purchasing, you must set up procurement card functionality in both iProcurement and Payables.

For information on setting up procurement card functionality, see the *iProcurement Implementation Manual* and the *Oracle Payables User's Guide*.

Procurement card purchase orders:

- Cannot be used with encumbrance accounting.
- Can be used for items with a Destination Type of Expense only.

- Cannot be used for documents that contain a Project number.
- Can be used for standard purchase orders or releases only.
- Are not available for invoice matching or invoice creation.
- Do not accrue on receipt. See: **Receiving**, below.
- Transmit the procurement card number to the supplier through e-Commerce Gateway, through the outbound purchase order transaction. See: Running the EDI Purchase Order Outbound Extract Program, *Oracle e-Commerce Gateway User's Guide*

## Approval

Requisitions and purchase orders that contain procurement card items are routed through the same approval process as any other document, unless you modify the approval workflow to treat them differently.

After a procurement card purchase order or release is approved, it is automatically closed for invoicing if you use the Two-Way match approval level.

## Receiving

You receive a procurement card order like any other. However, procurement card items do not accrue upon receipt. Payment and accounting for procurement card orders are already handled in Payables, which imports the credit card transaction files from the credit card issuer. If you accrue upon receipt, Purchasing accrues upon receipt all items except procurement card items. You cannot change the Accrue at Receipt check box in the Shipments window for procurement card purchase orders or releases.

Similarly, at period-end, Purchasing does not accrue or roll over procurement card orders to General Ledger.

## Invoicing

Since invoices for procurement card purchase orders are created through credit card transaction files that are imported from the credit card issuer into Payables, note the following:

- Procurement card purchase orders are not available for invoice matching in Payables.
- Procurement card shipment lines are automatically closed after approval if you use the Two-Way match approval level. (If you use Three-Way or Four-Way match approval levels, you can still receive or inspect against the shipment.)

- Payment on Receipt does not generate invoices automatically for procurement card orders, even if the supplier is set up as a Pay on Receipt site in the Supplier Sites window. A supplier site can be both a Pay on Receipt site and a Procurement Card Site; however, if the supplier site is a Pay on Receipt site, invoices will be generated automatically for all orders received from that supplier site when you run Payment on Receipt, except those that include procurement card information.
- Advance Shipment Notices (ASNs) that contain billing information (sometimes known as Advance Shipment and Billing Notices, or ASBNs), if they also contain procurement card information, are not automatically converted into invoices as they normally would be upon receipt.

Procurement Card Integration, *Oracle Payables User's Guide*

See: P-Cards, *Oracle iProcurement Implementation Guide*.

## Global Agreements

### Overview

Using global agreements, purchasing professionals are able to negotiate prices on behalf of multiple organizations within an enterprise and then enable the resulting agreement to be shared by those organizations for procuring products and services.

Global Agreements allow buying organizations to negotiate pricing and define agreements in a centralized shared services environment. Execution against the Global Agreement can be controlled and handled in more than one operating unit. Instead of creating multiple agreements in multiple operating units, you can create a single global agreement that can be viewed and used for sourcing by multiple operating units.

In addition to the Supplier/Supplier Site with whom the agreement was negotiated by the negotiating organization, it may not be the same supplier/supplier site which would be processing the purchase orders from the multiple buying organizations, where the agreement is enabled.

### Creating and Using a Global Agreement

- Create a Global Agreement in an Operating Unit (a Contract Purchase Agreement with the Global box and Enable All Sites box checked) - (N) Purchase Orders > Purchase Orders.
- Enable the Agreement in multiple Operating Units. (N) Purchase Orders > Purchase Orders > Tools > Enable Organizations.
- Optionally define local attributes for each of the operating units. This includes buyer, supplier site, freight carrier, currency.

- Local organizations can view and use the Global Agreement, however, they cannot make any changes to it. Only the local attributes can be changed by the buyers in the local organization.
- Standard POs are created in the local organization using the local document sequence number for Purchase Orders that gets generated and stored by the system.

## Global Agreements in Oracle Purchasing

The following areas are impacted by the global agreements enhancements in Oracle Purchasing:

- Requisitions, catalogs and Standard Purchase Orders refer to the global contract agreements even if the sites are valid for the supplier but do not necessarily match the site in the contract.
- If you select a contract, the catalogs reference the Global Contract Purchase Agreement when the catalog site differs from the site of the local CPA.
- Vendor based global ASL is used for referencing the Global Agreement.
- During automatic document sourcing, the buyer Can select the other valid supplier sites from the LOV apart from the default site.
- Once the Local or Global contract agreement goes through the amendment process and has a status of Requires Reapproval, you can refer to the contract once approved provided the agreement is not closed, cancelled or expired. (The profile option 'PO: Allow Referencing CPA Under Amendment' should be set to Yes).



---

# Supply Base Management

## Overview of Sourcing, RFQs, and Quotations

Purchasing provides you with request for quotation (RFQ), and quotation features to handle your sourcing needs. You can create an RFQ from requisitions, match supplier quotations to your RFQ, and automatically copy quotation information to purchase orders. Purchasing provides *complete* reporting to control your requests for quotations and evaluate supplier responses.

- Identify requisitions that require supplier quotations and automatically create a request for quotation.
- Create a request for quotation with or without approved requisitions so that you can plan ahead for your future procurement requirements.
- Record supplier quotations from a catalog, telephone conversation, or response from your request for quotation. You can also receive quotations electronically.
- Review, analyze, and approve supplier quotations that you want available to reference on purchase orders and requisitions. You should be able to evaluate your suppliers based on quotation information.
- Receive automatic notification when a quotation or request for quotation approaches expiration.
- Review quotation information on-line when creating purchase orders or requisitions and copy specific quotation information to a purchase order or requisition.
- Identify a supplier that you want to use only for receiving RFQs and quotations. You can later be able to access purchase history to help you decide if the quotations are acceptable.

- Hold all purchasing activity on a supplier at any time. You can still match invoices to approved purchase orders or receipts for this supplier. You can release a supplier hold at any time.
- Create, change, and review supplier information on-line. You can enter supplier site information, supplier contacts, and supplier-specific delivery information.
- Review the purchase history for a specific item. You can identify the suppliers you used in the past, quantities you ordered, and pricing information. You can match this information to specific purchase orders.
- Simplify the sourcing of commonly purchased items. You can define requisition templates for your commonly purchased items. Requestors can use these requisitions templates to create simple, pre-sourced requisitions.
- Source the items for which you negotiated purchase agreements automatically. If you created sourcing rules and Approved Supplier List entries for the items, supplier information is entered automatically in the Requisitions window when you create requisitions. You can also place supplier information for items onto blanket purchase order releases.
- Specify planning constraints, such as lead time, minimum order quantity, or fixed lot multiples, for each supplier site for an item so that if a supplier cannot currently meet your demand, Supply Chain Planning automatically uses another supplier that you specify. See: Defining the Supplier/Item Attributes, page 5-43.

## Major Features

### **Electronically Received Catalog Information**

You can receive price/sales catalog information electronically from your supplier through the Purchasing Documents Open Interface. The information is imported directly as blanket purchase agreement lines or catalog quotations. See: Receiving Price/Sales Catalog Information Electronically, page 5-18.

### **Flexible Document Numbers**

Purchasing identifies each RFQ or quotation with a unique document number. You decide whether you want to enter document numbers manually or have the numbers assigned automatically.

### **Sourcing Power**

Purchasing lets you source your items so you can negotiate the best deals with your suppliers. You can create requests for quotations, record the results, and reference the corresponding quotation when creating your purchase order. You can also review historical purchase prices so that you can evaluate how to purchase your items more



effectively.

**Supplier Defaulting**

For each supplier, you can define default preferred ship-to locations, freight terms and carriers, free-on-board information, tax names, and payment terms to be used when you enter purchase orders. You can always override any default.

**Supplier Purchasing Hold**

You can prevent purchasing activity on specific suppliers at any time by using the Suppliers window to provide a reason for holding the supplier. You cannot approve any purchase order for a supplier on hold; however, you can receive and match against approved purchase orders or receipts for a supplier on hold. You can release a hold at any time.

**AutoCreating RFQ and Quotation Information**

You can AutoCreate RFQs directly from requisitions. You can also Copy quotations directly from RFQs to facilitate recording responses from your suppliers. See: Copying Quotations from RFQs, page 5-74. (If you receive catalog information from your supplier electronically, that information is sent automatically in the form of a catalog quotation. See: Receiving Price/Sales Catalog Information Electronically, page 5-18.)

**Request for Quotation Requirement**

You can identify whether a request for quotation is necessary for a specific item or requisition line.

**Supplier Lists**

Purchasing lets you create supplier lists so that you can predefine groups of suppliers to whom you want to send RFQs. You can establish supplier lists according to criteria you define (item, manufacturing category, geographic location, or other) and you can combine supplier lists to produce many copies of your RFQ automatically.

**Purchasing History**

Purchasing lets you review your purchase price history information to help you source your items better. You can either review all historical prices for a particular item or the last prices you paid for a specific item by quantity. You can review the detailed information of the purchase order corresponding to this last price.

**Flexible, Custom Notes**

Purchasing lets you quickly add extended Notes and instructions to your RFQs and quotations. You can include standard notes or create your own custom notes. You can use as much descriptive text as you need.

## **Automatic Sourcing**

Automatic sourcing automatically defaults sourcing information onto the requisitions, blanket purchase orders, or quotations you create. You can easily assign any item with an item number to a specific blanket purchase agreement or quotation you created. Purchasing automatically assigns the name of the supplier for the blanket purchase order and quotation to any requisition for this item. (If you receive catalog information from your supplier electronically-and you specified sourcing rules to be sent electronically also-then the sourcing rule and Approved Supplier List entry for this supplier is entered in your system automatically.) See: Automatic Sourcing, page 5-24. See: Approved Supplier List, page 5-35.

## **RFQs and Quotations**

A request for quotation (RFQ) is sent to a supplier to request pricing and other information for an item or items. A quotation is the supplier's response to that RFQ. Some examples of how you send an RFQ to a supplier include creating an RFQ in the RFQs window and sending it by facsimile, making a phone call, or using Oracle iSupplier Portal. One way a supplier can send a quotation, whether or not in response to an RFQ, is through the Purchasing Documents Open Interface. (See: Receiving Price/Sales Catalog Information Electronically, page 5-18.) If you don't receive quotations electronically from your supplier, you can create the quotation manually using the Quotations window, or copy the quotation from an RFQ. (See: Copying Quotations from RFQs, page 5-74.)

## **Using Quotation Information on Your Documents**

Purchasing lets you use your quotation information when you build purchase orders.

### **Using Quotation Information for a Purchase Order**

When you create a purchase order (manually or from requisitions), you can use the Supplier Item Catalog window to retrieve quotation information. (The Supplier Item Catalog window can include quotations sent to you by your supplier through the Purchasing Documents Open Interface. See: Receiving Price/Sales Catalog Information Electronically, page 5-18.) Purchasing provides all your approved quotation shipment information for a specific item or manufacturing category. You can copy this quotation shipment to an existing blanket purchase agreement or standard purchase order when you add this item or purchasing category to a purchase order line. You can sort this quotation information according to your needs, using criteria such as price or quantity. You can easily evaluate the source that is best for an item.

After you select the quotation shipment you want to use, Purchasing copies the item unit price, quantity, unit of measure, supplier product number, inspection required status, receipt required status, quotation number, quotation type, and supplier

quotation number on your purchase order.

Purchasing automatically warns you when the terms and conditions of the quotation are different from the terms and conditions of your purchase order. The original purchase order terms and conditions remain unchanged.

### Using Partial Quotation Information on a Requisition

When you enter an item or purchasing category on a requisition line, you can use the Supplier Item Catalog window to access quotation shipment information for the item or category. After you select the quotation shipment you want to use, Purchasing automatically copies the item unit price, quantity, unit of measure, supplier product number, supplier name, supplier site, and supplier contact to your requisition line. Purchasing also copies the quotation item description on your purchase order if you define your items to do so.

### Types of Quotations and RFQs

There are three types of quotations and RFQs that come with Purchasing by default:

- *Catalog*: Used for high-volume items or items for which your supplier sends you information regularly. A Catalog quotation or RFQ also includes price breaks at different quantity levels.
- *Standard*: Used for items you'll need only once or not very often, but not necessarily for a specific, fixed quantity, location, and date. For example, you could use a Catalog quotation or RFQ for office supplies, but use a Standard quotation or RFQ for a special type of pen you don't order very often. A Standard quotation or RFQ also includes price breaks at different quantity levels.
- *Bid*: Used for a specific, fixed quantity, location, and date. For example, a Bid would be used for a large or expensive piece of equipment that you've never ordered before, or for an item that incurs transportation or other special costs. You cannot specify price breaks for a Bid quotation or RFQ.

For all three types, you can define effectivity dates at the header level. For Catalog and Standard quotations, you can also specify effectivity dates for individual price breaks. (For a Bid, you cannot specify effectivity dates at the shipment level.)

You can also define your own RFQ or quotation types using the Document Types window. See: *Defining Document Types*, page 1-67.

For advanced features in RFQs and quotations, please refer to the *Oracle Sourcing Implementation and Administration Guide*.

## Supplier Item Catalog

The Supplier Item Catalog provides a simple mechanism for locating items and their source information for the purpose of creating purchase order and requisition lines. You

can open the catalog from an existing requisition or purchase order and add lines to that document. Alternatively, you can open the catalog from the Navigator and search for item information from there.

## Overview of the Supplier Item Catalog

### Search Supplier Item Catalog Window

Purchasing displays the Search Supplier Item Catalog window whether you invoke the Supplier Item Catalog from the menu or from a requisition or purchase order.

To invoke the Supplier Item Catalog from a requisition or purchase order, select the Catalog button when the cursor is in the Lines tabbed region.

The Supplier Item Catalog does not support Outside Processing. However, you can open the Catalog from an outside processing line in a requisition or a purchase order to find other items.

In the search window, lists of values show only valid values. For example, inactive suppliers are not displayed.

The "Item description contains the words" field is used for keyword searches. If you search for "desk executive mahogany", you get any item whose description includes all three words. In this case you could widen the search by removing "mahogany" and/or "desk." The words in the description do not have to occur in the order listed, so searches on "desk executive" and "executive desk" would get the same result: all items whose description included both of the words.

The Deliver To Organization and Location (when invoked from the menu or a requisition) are the Ship To Organization and Location when the window is invoked from a purchase order. Lists of values display deliver-to or ship-to values, as appropriate. For query purposes, the deliver-to actually uses the associated ship-to information.

### Supplier Item Catalog Window

There are four tabbed regions in the upper screen of this folder window, but Function Security can be used to determine whether a user will be able to see all of them. A profile option (PO: Default Supplier Item Catalog Option) determines which of these tabbed regions is the default when the catalog opens from the menu and for the first time in a user session that the catalog opens from a requisition or purchase order. If you close the catalog and reopen it from a purchase order or requisition during the same session, the default source region is the last one previously open. The regions are:

---

Negotiated Sources	Long term agreements with a supplier that support repetitive buys: Blanket purchase agreements, quotations, planned purchase orders, and global agreements enabled for your operating unit. This tabbed region is a folder.
Prior Purchases	Actual past buys: Standard purchase orders, scheduled releases, blanket releases. This tabbed region is a folder.
Sourcing Rules	Sourcing rules. There are + and - iconic buttons just below the region box. Select the + icon or Expand Sourcing Rules on the Tools menu to display source documents for the rule in a folder region. Use the - icon or Collapse Sourcing Rules on the Tools menu to collapse the region displaying the documents. You must be in the documents region to add to the Order Pad or to select a price.
Requisition Templates	Requisition Templates. The PO: Legal Requisition Type profile option governs whether templates for supplier and internally sourced lines are displayed. This tabbed region is a folder.

---

## Using the Order Pad

Open the Supplier Item Catalog window by choosing Catalog in the Requisitions window to view and use the Order Pad. (The Order Pad is not available when you open the Supplier Item Catalog from the Purchase Orders window.) Select a line and click the Add button or double click to highlight the selected line in a source region and add it to the Order Pad. Validation takes place at this point, and if there is a problem, Purchasing displays a message window with an explanation. Depending on the problem, you may or may not be permitted to add the line. Also, if Disposition messages are enabled for the Purchasing Inventory organization, they are displayed as lines and added to the Order Pad.

When you add to the Order Pad, you must specify the following information. Defaults for this information are defined in the Order Pad Options window.

- Deliver-To organization (if you opened the catalog from the menu or a requisition)
- Ship-To organization (if you opened the catalog from a purchase order)

- Deliver-To location (if you opened the catalog from the menu or a requisition)
- Ship-To location (if you opened the catalog from a purchase order)
- Destination Type (Expense or Inventory)
- Subinventory (if the Destination Type is Inventory)
- Need-By date (if the item is planned in the destination organization)
- Quantity. The quantity must be greater than zero. It defaults to 1 or the quantity on the requisition/purchase order line if a quantity was specified and if the first record was added to the Order Pad.
- Amount. For services line type you can specify an amount.

If you are adding to the Order Pad from Negotiated Sources or Sourcing Rules and enter a quantity less than an existing price break quantity, Purchasing opens a Decision window and asks whether you want to increase the order quantity to reduce the unit price.

Use the Remove button or Clear Record to remove selected lines from the Order Pad. When you remove a line from the Order Pad, Purchasing returns it to the source region and highlights the line. To support returning a line to its source tabbed region, Purchasing does not permit Clear Record in the source tabbed regions or Clear Block in the Order Pad.

### **Order Pad Options**

You enter Order Pad defaults and options in the Order Pad Options window. Navigate to the Order Pad Options window by opening the Supplier Item Catalog from a requisition and choosing the Options button while you are on the Order Pad. (Note: The Order Pad is not available when you open the Supplier Item Catalog from the Purchase Orders window.) The Order Pad Options window includes the Copy Option tabbed region, where you can specify the Supplier, Supplier Site, Supplier Contact, FOB, Carrier, Payment Terms, and Freight Terms to be copied to the purchase order header.

### **Order Pad Total**

For each line on the Order Pad, Purchasing displays the extended price in that line's currency. To see the total Order Pad amount in your functional currency, open the Order Pad Total window by selecting the Order Total button.

### **Select Price Only Option**

As a mutually exclusive alternative to the Order Pad, there is a Select Price Only check box at the top right of the screen when you have opened the Supplier Item Catalog from a requisition or a purchase order. If the requisition or purchase order line is saved,

when you open the Catalog, you must use Select Price Only. This check box can be enabled only if nothing has been added to the Order Pad. If this check box is selected, the Add, Order Total, and Options buttons are disabled and the Select button is enabled. You can then select prices for inclusion on a requisition or purchase order.

## Related Topics

Profile Options in Purchasing, page C-1

Customizing the Presentation of Data in a Folder, *Oracle Applications User's Guide*

Finding Supplier Items, page 5-9

Using the Supplier Item Catalog tabbed regions, page 5-13

Entering Order Pad Options (from Requisitions), page 5-16

## Finding Supplier Items

Use the Search Supplier Item Catalog window to enter search criteria for supplier items.

Depending on the function security assigned to your responsibility, you have varying levels of access to information. A responsibility defines an application user's current privileges while working with Oracle Applications. See: Function Security for Purchasing, page D-1.

If you enter an item with **Purchasing Enabled = 'N'** and with **Internal Orders Enabled = 'Y'**, the item is valid for an internal order, but you cannot search for this item in the Supplier Item Catalog. If you want to be able to search the Supplier Item Catalog, the item must have **Purchasing Enabled = 'Y'**.

### To enter search criteria:

1. Navigate to the Search Supplier Item Catalog window by selecting Supplier Item Catalog from the menu. Also, the Search Supplier Item Catalog window is displayed when you select the Catalog button in the Requisitions and Purchase Orders windows.

The screenshot shows the 'Search Supplier Item Catalog' window with the following fields and controls:

- Operating Unit:** Vision Operations (dropdown menu)
- Commodity:** (text input)
- Requisition Template:** (text input)
- Item Section:**
  - Category Set:** (text input)
  - Category:** (text input)
  - Item, Rev:** (text input with a small button to the right)
  - Description:** (text input)
  - Job:** (text input)
  - Line description contains the words in sequence only:** (text input)
- Supplier Section:**
  - Supplier:** (text input)
  - Sourced Suppliers Only
  - Site:** (text input)
  - Supplier Item:** (text input)
- Additional Fields:**
  - Due Date:** (text input)
  - Line Type:** (text input)
  - UOM:** (text input)
  - Deliver-To Organization:** (text input)
  - Shgw External Locations
  - Deliver-To Location:** (text input)
  - Currency:** (text input)
- Buttons:** Clear, Find

Enter optional search criteria as described in the following steps:

2. Select the Operating Unit for this search.
3. Enter the Commodity. This is used to locate matching stored categories on Purchasing document lines.
4. Enter the Requisition Template. This is enabled only if the window is accessed from the menu or from the Requisitions window.
5. Enter the Category Set. This is used to find predefined items associated with a specific category set. If you access this window from the Requisitions or Purchase Orders windows, the default is the Purchasing category set. If you enter a category set, you can also further restrict the search by entering a Category.
6. Enter the Item number. If you access this window from the Requisitions or Purchase Orders window, the default is the item on the originating document line. If you enter an item, you can also further restrict the search by entering an item Revision number.
7. Enter the item Description. If you access this window from the Requisitions or Purchase Orders window, the default is the description on the originating document line.
8. If Oracle Services Procurement is implemented, enter the Job to search for fixed



price services. You can only enter these line types on purchase orders.

9. Enter key words separated by spaces in the Item description contains the words: field to find item descriptions containing all the specified words. The search is not case sensitive, nor does it consider the sequence of the words.
10. Enter the Supplier. If you access this window from the Requisitions or Purchase Orders window, the default is the supplier on the originating document line. If you enter a supplier, you can enter a supplier Site.
11. Enter the Supplier Item number. If you access this window from the Requisitions or Purchase Orders window, the default is the supplier item number on the originating document line.
12. Select Approved Suppliers Only to get only records where the supplier and the item exist in a current sourcing rule and Approved Supplier List entry.
13. Enter the Due Date to get documents that are current as of this date or future effective. If you access this window from the Requisitions or Purchase Orders window, the default is the due date on the originating document line.
14. Enter the Line Type. If you access this window from the Requisitions or Purchase Orders window, the default is the line type on the originating document line.
15. Enter the UOM. If you access this window from the Requisitions or Purchase Orders window, the default is the UOM on the originating document line.

**Important:** Since catalog quotations in the Negotiated Sources and Sourcing Rules tabbed regions can have different units of measure on the line and the price break, Purchasing performs the following test on the UOM you enter in this field:

If a UOM exists on the shipment, Purchasing returns rows where this matches the search value. If no UOM exists on the shipment, Purchasing returns rows where the line UOM matches the search value. We do this because if you add to the Order Pad from a row with a different UOM on the price break, this is the UOM we copy to the Order Pad.

16. Enter the Ship-to Organization. If you access this window from the menu or the Requisitions window, the field title is Deliver-To Organization. If you access this window from the Purchase Orders window, the field title is Ship-To Organization. The defaults are from the originating document line, deliver-to from the requisition and ship-to from the purchase order.
17. Select External Locations to limit your results to external (customer) locations. With

this checkbox unchecked, the results of the find include only internal ship-to locations.

18. Enter the Location. If you access this window from the menu or the Requisitions window, the field title is Deliver-To Location. If you access this window from the Purchase Orders window, the field title is Ship-To Location. The query is based on the ship-to location associated with the deliver-to location. The defaults are from the originating document line, deliver-to location from the requisition and ship-to location from the purchase order.
19. Enter the Currency. If you access this window from the Purchase Orders window, the default is the currency from the purchase order line.

**To clear existing search criteria:**

- Select the Clear button to clear any existing search criteria.

**To initiate the search:**

- Select the Find button to initiate the search and open the Supplier Item Catalog window.

**To close the Search Supplier Item Catalog window:**

- Select the Close Catalog button to close the Search Supplier Item Catalog window. This button is available only when you have accessed this window from the Requisitions or Purchase Orders windows; when you close the catalog window, you return to your originating document window.

**Note:** You must select either Find or Close Catalog before you can return to the originating document. While the Search Supplier Item Catalog window is open, you cannot:

- Exit to the menu
- Navigate to the originating document
- Save your work

## Related Topics

Overview of the Supplier Item Catalog, page 5-5

Defining Categories, *Oracle Inventory User's Guide*

Defining Category Sets, *Oracle Inventory User's Guide*

Defining Items, *Oracle Inventory User's Guide*

Suppliers, *Oracle iSupplier Portal Implementation Guide*.

Using the Calendar to Enter Dates, *Oracle Applications User's Guide*

Defining Line Types, page 1-62

Defining Units of Measure, *Oracle Inventory User's Guide*

Representing Organizations, *Oracle HRMS Enterprise and Workforce Management Guide*.

Site Locations, *Oracle HRMS Enterprise and Workforce Management Guide*

Defining Currencies, *Oracle General Ledger User's Guide*

## Using the Supplier Item Catalog Tabbed Regions

Use the Supplier Item Catalog window to:

- Review results of your search in the tabbed regions of the Search Supplier Item Catalog window.
- Select prices from the tabbed regions for placement onto requisition and purchase order lines.
- Place source lines from the tabbed regions onto the Order Pad, where you can modify them before placing them onto requisition and purchase order lines or onto new requisitions.

The Supplier Item Catalog window has four tabbed regions (Negotiated Sources, Prior Purchases, Sourcing Rules, and Requisition Templates), but Function Security controls which are present. A profile option (PO: Default Supplier Item Catalog Option) determines which of these tabbed regions is the default, but this applies only to regions permitted by Function Security.

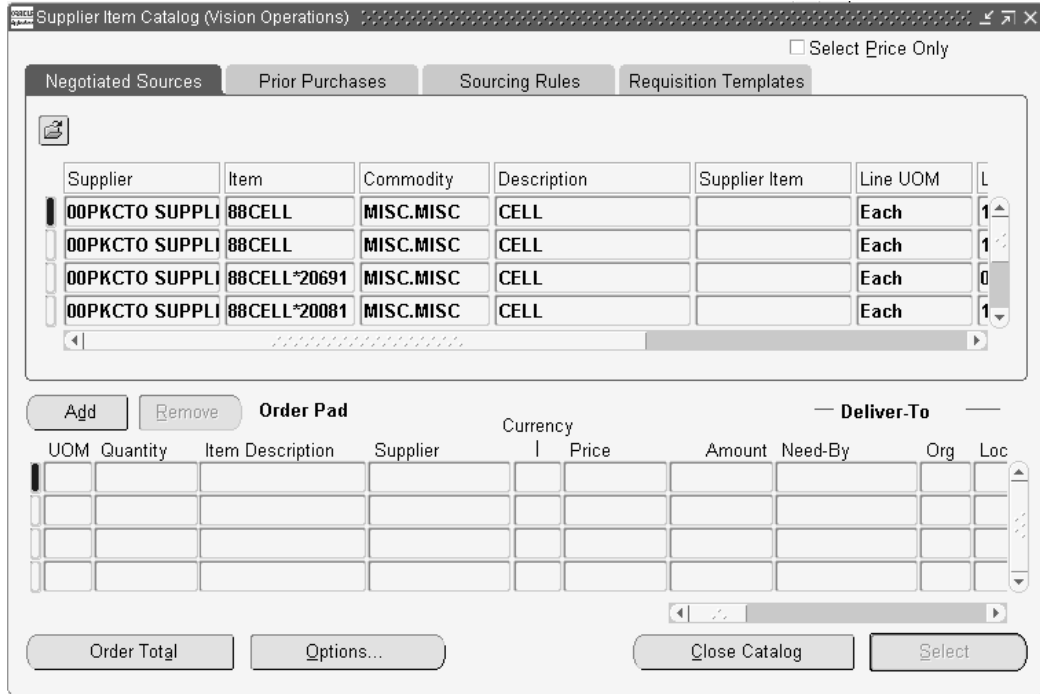

The query based on your search criteria is executed in the currently displayed alternative results region in the Supplier Item Catalog window. As you change tabbed regions, a query is executed in each tabbed region using the original search criteria. Search criteria are considered only in tabbed regions in which they are relevant.

For example, if your original search criteria consisted of a requisition template and a key word, the query in the Negotiated Sources tabbed region would ignore the requisition template.

**To review the tabbed regions:**

- Navigate to the Supplier Item Catalog window by selecting the Find button in the Search Supplier Item Catalog window. You can also navigate to the Search Supplier Item Catalog window by selecting the Catalog button in the Requisitions and Purchase Orders windows.

The Negotiated Sources tabbed region is a folder. As installed, it displays the Supplier, Item, Commodity, item Description, Supplier Item number, Line UOM, Line Price, Break Quantity, and Break Price.

The Prior Purchases tabbed region is a folder. As installed, it displays the Order Date, Supplier, Item number, Commodity, item Description, UOM, Price, Supplier Item number, Quantity, and Negotiated flag.

The Sourcing Rules tabbed region displays the Item number, Rank, Supplier, Rule number, and the rule Effective date range. You can expand and collapse sourcing rule lines either by selecting the + and - icons or from options on the Tools menu. When you expand a sourcing rule line, Purchasing opens a folder window that, as installed, displays the Rank, Commodity, Supplier Item, Line UOM, Line Price,

Break Quantity, and Break Price for documents referencing the rule.

The Requisition Templates tabbed region is a folder. As installed, it displays the Supplier, Item number, Commodity, UOM, Price, Source Type, Supplier Item number, Template name, Template Description, and Buyer.

**To select prices from the tabbed regions:**

1. Select the Select Price Only check box, if you opened the Supplier Item Catalog from a requisition (the target document.). If you opened the Supplier Item Catalog from a purchase order, the Select Price Only check box is already selected, and you cannot deselect it. You cannot use the Order Pad if you have checked Select Price Only. You cannot use the Order Pad if you opened it from a Purchase Order window.
2. Move the cursor to the desired line in one of the tabbed regions.
3. Select the Select button to copy the price of the current line to your target document.

**To use the Order Pad:**

1. Open the Supplier Item Catalog by choosing the Catalog button on a requisition or purchase order. You can access the Order Pad only when you open the Supplier Item Catalog from a requisition or purchase order.
2. Choose the Add button to place the current line in the open tabbed region onto the Order Pad. The cursor moves to the Order Pad, where you can select the Remove button to return the current line to its original tabbed region.
3. You can enter or edit the following fields for an Order Pad line: Quantity, Price, Need-By date, Organization, Location, Destination Type, and Subinventory.
4. Choose the Select button to add the order pad lines to the requisition or purchase order from which you accessed the catalog. This also closes the Supplier Item Catalog window.

**To create a new requisition from the Catalog:**

1. Open the Supplier Item Catalog from the menu.
2. Add lines to the Order Pad.
3. Select the Requisition button.

**To enter order pad options and defaults:**

- Select the Options button to open the Order Pad Options window. See: Entering Order Pad Options (from Requisitions), page 5-16.

**To view the current order pad total:**

- Select the Order Total button to open the Order Pad Total window. This window displays the Functional Currency and the current total amount on the order pad.

**To close the Supplier Item Catalog window:**

- Select the Close Catalog button to close the Supplier Item Catalog windows. This button is available only when you have accessed this window from the Requisitions or Purchase Orders windows; when you close the Search Supplier Item Catalog and the Supplier Item Catalog windows, you return to your originating document window.

**Note:** You must either Select information to copy back or Close Catalog before you can return to the originating document. While the Supplier Item Catalog window is open, you cannot:

- Exit to the menu
- Navigate to the originating document
- Clear the window
- Save your work

## Related Topics

Overview of the Supplier Item Catalog, page 5-5

Using the Search Supplier Item Catalog Window, page 5-9

Entering Requisition Lines, page 3-51

Site Locations, *Oracle HRMS Enterprise and Workforce Management Guide*

Representing Organizations, *Oracle HRMS Enterprise and Workforce Management Guide*

Customizing the Presentation of Data in a Folder, *Oracle Applications User's Guide*

## Entering Order Pad Options (from Requisitions)

Use the Order Pad Options window to enter order pad defaults and options. You access this version of the window when you have opened the Supplier Item Catalog from a requisition.

**To enter order pad defaults and options:**

1. Navigate to the Order Pad Options window by selecting the Options button in the Supplier Item Catalog window.

**Order Pad Options**

**New Order Pad Lines**

Default From Options  
 Default From Previous Line

**Deliver-To Defaults**

Need-By

Destination Type

Organization

Location

Requestor

Subinventory

Expense Charge Account

2. Select the default option:

*Default From Previous Line* - Defaults for Order Pad lines are from the previous line on the Order Pad. (The first line on the Order Pad uses defaults from this window.)

*Default From Options* - Defaults for Order Pad records come from this window.

3. Enter the default Need-By date.
4. Enter the default Destination Type: Expense or Inventory.
5. Enter the default Organization.
6. Enter the default Location.
7. Enter the default Requestor.
8. For the Destination Type of Inventory, enter the default Subinventory.

9. Enter the default Expense Charge Account.

**To apply the defaults:**

- Select the OK button to apply the defaults and return to the Supplier Item Catalog window.

## Related Topics

Overview of the Supplier Item Catalog, page 5-5

Site Locations, *Oracle HRMS Enterprise and Workforce Management Guide*

Representing Organizations, *Oracle HRMS Enterprise and Workforce Management Guide*

Representing Organizations,

## Receiving Price/Sales Catalog Information Electronically

Your supplier can send you the latest price/sales catalog information and responses to requests for quotation through the Purchasing Documents Open Interface. The Purchasing Documents Open Interface processes catalog data in the Oracle Applications interface tables to ensure that it is valid before importing it into Purchasing. One way to import catalog data into the Purchasing Documents Open Interface, and finally into Purchasing, is through Electronic Data Interchange (EDI). EDI programs import the catalog information into Purchasing directly as blanket purchase agreement lines or catalog quotations, whichever you choose. You can also choose to have the programs automatically populate the item master and/or apply sourcing rules to the imported item information. If you import price/sales catalog information as blanket purchase agreement lines, you can also specify release generation methods. You can import new documents, replace existing documents entirely, or update existing documents.

The catalog information is sent by the supplier in the form of a "flat file." Your supplier can send you flat files with any of three kinds of action codes: Original, Replace, or Update. An Original file is one in which all the catalog information is new to your system. A Replace file replaces already-created blanket purchase agreement lines or catalog quotations with new documents containing new price/sales catalog information. (The Purchasing Documents Open Interface program replaces the old documents by invalidating their effectivity dates; then it creates new documents with the new price/sales catalog information and the old effectivity dates.) An Update file updates existing blanket purchase agreement and catalog quotation lines without replacing the documents entirely. It updates the unit Price, item Description, unit of measure (UOM), Price Breaks, Expiration Date, and the supplier URL descriptive flexfield if you use one.

**Note:** An Update submission does not update the UOM on an agreement line for which an open release exists. Instead, it uses the Expiration Date field to expire the line on the agreement, and creates a



new line with the updated UOM, which will be used on future releases.

The Purchasing Documents Open Interface also imports price breaks. In an updated price/sales catalog, if the supplier updates an item's price, the Purchasing Documents Open Interface deletes the item's price breaks since they are no longer current with the new price. If the supplier sends new price breaks for an existing line, the current price breaks are deleted and the new price breaks sent by the supplier are created.

The Purchasing Documents Open Interface supports the Oracle e-Commerce Gateway transmissions of the price/sales catalogs (ANSI X12 832 or EDIFACT PRICAT) and responses to RFQs (ANSI X12 843 or EDIFACT QUOTES).

For e-Commerce Gateway to distinguish between Original, Replace, and Update action codes, you need to set up code-conversion categories and values in e-Commerce Gateway. See: *Defining Code Conversion Categories, Oracle e-Commerce Gateway User's Guide*. See: *Defining Code Conversion Values, Oracle e-Commerce Gateway User's Guide*.

Other setup includes making sure that default category sets are set up appropriately for both Purchasing and Inventory, setting Purchasing profile options, and allowing updating of the item master if you want to update the item description in the item master as well as on the blanket purchase agreement or quotation. For complete instructions on setup requirements, see the *Oracle Manufacturing, Distribution, Sales and Service Open Interfaces Manual*.

You can also import standard purchase orders through the Purchasing Documents Open Interface, using your own import program. You cannot update or replace existing standard purchase orders through the Purchasing Documents Open Interface. You must use the Change Order API.

## How Sourcing Works

When you import blanket purchase agreements and catalog quotations into Purchasing, you have the option of choosing Yes or No in the Create Sourcing Rules field in the Parameters window to enable Purchasing to create sourcing rules out of the supplier, item, and document information that the supplier sends.

## Original and Replacement Price/Sales Catalogs

If you choose Yes to create sourcing rules in an original or replacement price/sales catalog, Purchasing checks if a sourcing rule is assigned to the item at the item level and does the following:

- If no sourcing rules exist for the item, Purchasing generates a sourcing rule automatically, allocating 100 percent to the supplier importing the information.
- If a sourcing rule exists for the item, Purchasing compares the effectivity dates of the incoming document with those of the existing sourcing rule for the item. To ensure that only one sourcing rule is used for the item, Purchasing does the following:

- If the effectivity dates of the incoming document are the same as the existing sourcing rule's effectivity dates, Purchasing checks to see if the supplier is in the sourcing rule. If not, Purchasing adds the supplier to the existing sourcing rule with an allocation of 0 percent. Later, you can query the sourcing rule and define your own percentage splits between suppliers.
- If the effectivity dates of the incoming document are different than the existing sourcing rule's effectivity dates, but are within or overlap the existing effectivity dates, then a new sourcing rule is not created, so as not to conflict with the existing sourcing rule.
- If the effectivity dates of the incoming document do not overlap the existing sourcing rule's effectivity dates, Purchasing updates the item's sourcing rule with the new effectivity dates, adding the supplier at an allocation of 100 percent.
- Purchasing checks for an Approved Supplier List entry for the item and supplier/site combination. If an entry exists, Purchasing adds the document to the entry. If an entry does not exist, Purchasing creates a new entry with the new source document.

### Updated Price/Sales Catalogs

If you choose Yes to create sourcing rules in an Update submission, new sourcing information is created (as described above) only if the Update submission results in a new line being created.

### Related Topics

Running the EDI Price/Sales Catalog Inbound Program, *Oracle e-Commerce Gateway User's Guide*

Running the EDI Response to Request for Quotation Inbound Program, *Oracle e-Commerce Gateway User's Guide*

Import Price Catalogs, page 13-8

*Oracle Manufacturing, Distribution, Sales and Service Open Interfaces Manual*

### Setting a Price Tolerance in a Price/Sales Catalog Update

You can set a price update tolerance that specifies the maximum percentage increase allowed to an item's price when your supplier sends updated price/sales catalog information through the Purchasing Documents Open Interface. This price update tolerance affects only blanket purchase agreements and catalog quotations imported through the Purchasing Documents Open Interface. If the tolerance is exceeded, you receive a notification for each affected document and can accept or reject the price increase through the Exceeded Price Tolerances window. You can also access this

window through the notification.

Purchasing performs the price update tolerance check against the price on the current revision of the document. The price tolerance check is performed only on updated blanket purchase agreements and catalog quotations and only on line price increases (not price breaks).

#### **To set the price tolerance:**

- Define a price update tolerance at any of the following levels; Purchasing uses the first tolerance it finds, in this order: on the agreement in the Terms and Conditions window, at the item-supplier level in the Supplier-Item Attributes window, at the commodity-supplier level in the Supplier-Item Attributes window, and at the system level in the *PO: Price Tolerance (%) for Catalog Updates* profile option.

#### **Example**

If you set the Price Update Tolerance to 20 at the item-supplier level in the Supplier-Item Attributes window (and you haven't set the price tolerance on the agreement), a price increase of more than 20 percent for that item and supplier will send the buyer a notification. If you set the Price Update Tolerance to 20 on the agreement, a price increase of more than 20 percent on that document will issue a notification.

A price tolerance of 0 means you are alerted of every price increase. No tolerance means that you are not alerted of any price increase.

#### **Related Topics**

Receiving Price/Sales Catalog Information Electronically, page 5-18

Monitoring Price Increases in a Price/Sales Catalog Update, page 5-21

### **Monitoring Price Increases in a Price/Sales Catalog Update**

Use the Exceeded Price Tolerances window to accept or reject price increases to blanket purchase agreements and catalog quotations sent by your supplier through the Purchasing Documents Open Interface.

This window displays price increases only to blanket purchase agreements and catalog quotations received through the Purchasing Documents Open Interface and only if you define a Price Update Tolerance at one of four levels. See: *Setting a Price Tolerance in a Price/Sales Catalog Update*, page 5-20.

Purchasing performs the price update tolerance check against the price on the current revision of the document. The price tolerance check is performed only on updated blanket purchase agreements and catalog quotations and only on line price increases (not price breaks).

#### **To accept or reject price increases:**

1. Navigate to the Exceeded Price Tolerances window.

This window is available in the Purchasing menu. You can also navigate to this

window from the notification. The price increase notification is titled *Price tolerance exceeded during BLANKET update* or *Price tolerance exceeded during QUOTATION update*. Select the notification, and then choose the document icon to open the Exceeded Price Tolerances window.

You receive a notification for each affected document.

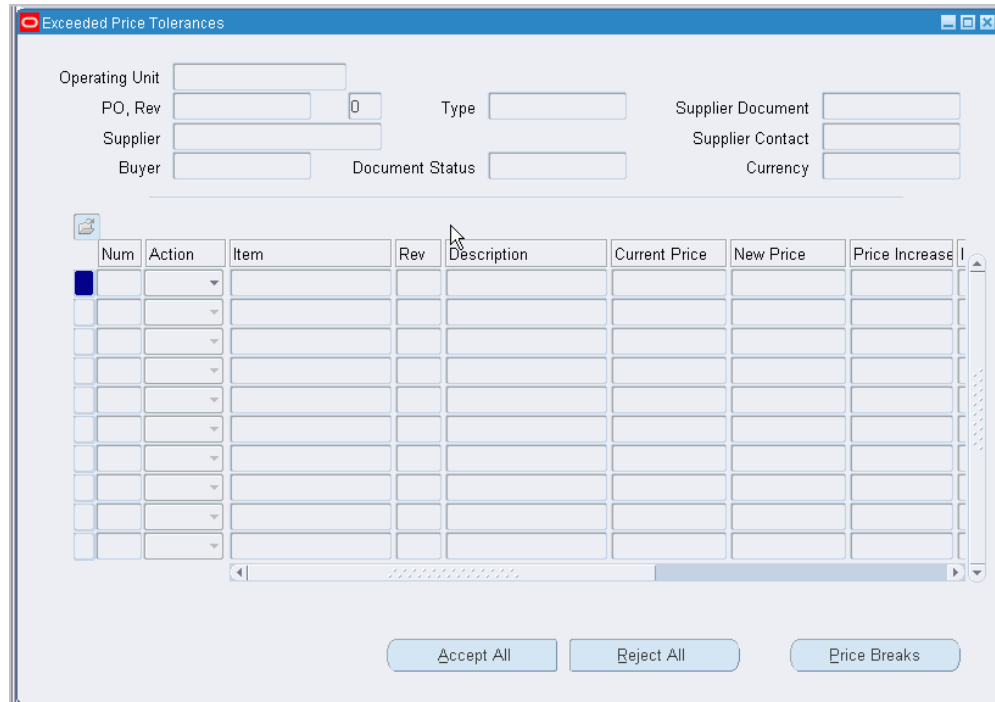

The updated document's header information is displayed at the top of the Exceeded Price Tolerances window. Its lines whose price updates exceeded the price tolerance are displayed below. You cannot change the price here, but simply accept or reject it.

*Document Status:* Approval Status of Approved or Incomplete entered in the Parameters window when importing the price/sales catalog, for your reference. You cannot change this field.

*Rev* - Item revision number.

*Current Price:* The current price of the item in Purchasing, on the blanket purchase agreement or quotation.

*New Price:* The updated price in the price/sales catalog submission. This price has exceeded your price tolerance.

*Increase (%):* Percentage by which the price of the item was exceeded over the price on the current blanket purchase agreement or quotation in Purchasing.

*Tolerance (%):* The price tolerance that is set in Purchasing for this item.

*Price Increase:* The difference between the current price on the blanket purchase

agreement or quotation in Purchasing and the updated price in the price/sales catalog submission.

2. Choose Price Breaks to view price break changes, if any.

The Price Breaks window is a view-only window.



3. In the Action column of the Exceeded Price Tolerances window, choose Accept or Reject to accept or reject each price update. Or choose Accept All or Reject All to accept or reject all price updates.

*Accept:* The price update to the document line is accepted.

*Reject:* The price is not updated on the document. Any other changes to the line-to-the item Description, UOM, Expiration Date, or URL descriptive flexfield-have already been made. Only the price update is not made. If you've customized the price/sales catalog workflow, you can enable the Reject action to send the supplier a notification that the price update for this item has been rejected. See: Price/Sales Catalog Notification Workflow, page E-206.

**Note:** The revision of the document is not updated until you accept all line updates (if the profile option *PO: Archive Catalog on Approval* is set to Yes).

**Important:** Depending on how the function security is set for your user responsibility, you may not have access to the Action field. (With function security, a system administrator can limit people's access to this function to view-only.)

## Related Topics

Receiving Price/Sales Catalog Information Electronically, page 5-18

## Overview of Automatic Sourcing

Purchasing lets you automatically source online requisitions with purchase agreements or quotations you create. You can easily assign any item with an item number to a specific purchase agreement or quotation. Purchasing automatically assigns the name of the supplier for the purchase agreement and quotation to any requisition for this item.

To achieve automatic sourcing, use the Sourcing Rule and Sourcing Rule/Bill of Distribution Assignments windows to create sourcing rules. Optionally use the Approved Supplier List and Supplier-Item Attributes windows to specify source document information for a particular item, supplier, and site.

## Defaulting Sourcing Information

For requisitions, if you define a purchase agreement or quotation as the source document for your item, and define and assign sourcing rules, Purchasing provides the following sourcing information for your requisition line: Buyer, Supplier, Site, Contact, Phone, Supplier Item Number, Document Type (Blanket, Contract, or Quotation) Source Document, Source Line Number, Rate Date, Rate Type, Rate, and RFQ Required (Yes or No). Oracle Purchasing also defaults the price depending on your pricing configuration. You can later review the sourcing information in the AutoCreate Documents window before placing the requisition line onto a purchase order.

Sourcing information defaults on a requisition from existing documents in the following order of precedence:

- Local blanket purchase agreement
- Global blanket purchase agreement
- Local contract purchase agreement
- Global contract purchase agreement
- Quotation

For standard purchase orders, if you define a global agreement or quotation as the source document for the item, and define and assign sourcing rules, Oracle Purchasing provides sourcing information for the purchase order line. Examples of sourcing information are: Contract, Document Type, document Number and Line, and Supplier Quotation number. Oracle Purchasing also defaults the price from the source document.

Sourcing information defaults on a purchase order from existing documents in the following order of precedence:

- Local blanket purchase agreement
- Global blanket purchase agreement

- Quotation

A requisition with a quotation, contract purchase agreement, or global agreement as a source document becomes a standard purchase order. A requisition with a blanket purchase agreement as a source document becomes a release.

Purchasing defaults sourcing information from the purchase agreement or quotation except under the following conditions:

- The document is not approved.
- The purchase agreement is frozen or cancelled, or the blanket purchase agreement line is cancelled.
- The document is not active.
- You have copied sourcing information back to the requisition from the Supplier Item Catalog.

## Sourcing by Item or Item Category

In the Approved Supplier List and Sourcing Rule windows, you source at an item or commodity level. That is, you provide sourcing information for a particular item at the item level, or for a category of items at the commodity level.

For inventory items, if no sourcing rule is provided at the item level in the Sourcing Rule/Bill of Distribution Assignments window, Purchasing automatically defaults the supplier or supplier site from the category-level sourcing rule if there is one.

The same is true of supplier statuses. If you debar a supplier for a specific commodity (category) in an Approved Supplier List entry, the supplier is prevented from supplying all items within that commodity. (Note: If you *approve* a supplier for a commodity, the item-specific status for the supplier still takes precedence.)

## Sourcing Globally or Locally

In the Approved Supplier List and Sourcing Rule windows, you also choose whether to exercise the sourcing information at a global or local level. A sourcing rule assigned at the global level in the Sourcing Rule / Bill of Distribution Assignments window is valid for all operating units. A global ASL entry in the Approved Supplier List window is valid for all inventory organizations in an operating unit. A local sourcing rule or ASL entry is valid only for the organization that you were in or that you chose when creating the sourcing rule or ASL entry.

Local entries take precedence over global ones. For example, if you have a global sourcing rule that says to use Supplier A for an item for all organizations in your company, and a local sourcing rule for the same item that says to use the local Supplier Z only for your organization, Purchasing defaults Supplier Z on requisitions or purchase orders created in your organization. Local entries are the default in the

Approved Supplier List window.

## Defining Allocation Percentages

When creating sourcing rules in the Sourcing Rule window, you must define allocation percentages. Master Scheduling/MRP uses these allocation percentages when creating planned orders, which Purchasing imports as requisitions through Requisition Import. In a *group* of requisitions imported from Master Scheduling/MRP, the requisitions show the percentage allocation you define. In other words, at the end of a planning period, a group of orders to those suppliers approximately equals the percentage split you defined. However, when you create an individual requisition in Purchasing, Purchasing sources to the supplier with the highest allocated percentage. The Approved Supplier List (ASL) entry for that supplier is then referenced in order to pick up source document information (from a purchase agreement or quotation), if source documents exist. If a percentage allocation is the same for some suppliers, and you have ranked the suppliers in the Sourcing Rule window, Purchasing sources to the one with the highest rank.

## Specifying Planning Constraints

The Supplier-Item Attributes window lets you optionally specify the capacity of individual supplier sites to supply specific items. Supply Chain Planning allocates planned orders taking these capacity constraints into account. For example, you define and assign a sourcing rule that says an item can come from either of two suppliers this year. In the sourcing rule, you also rank the suppliers so that Planning prefers Supplier 1 over Supplier 2. However, if the capacity of Supplier 1 in the Planning Constraints tabbed region of the Supplier-Item Attributes window includes a four-day lead time, but there is a need-by date of one day, Supply Chain Planning automatically defaults Supplier 2 onto planned orders if Supplier 2 has a lead time of less than one day. (If no suppliers can meet your demand, Supply Chain Planning uses the top-ranked supplier.)

In addition to lead time, you can define receiving schedules, minimum order quantities and fixed lot multiples, capacity per day, and tolerance fences. See: *Defining the Supplier/Item Attributes*, page 5-43.

These planning constraints apply to planned orders only.

## Automatic Sourcing with Center-Led Procurement

Centralized procurement enables you to extend automatic sourcing to global agreements negotiated by other business units. Automatic sourcing setup is the same but sourcing will be extended to look at global agreements matching the supplier and supplier site in other business units (operating units). This extended automatic sourcing will always evaluate purchase agreements in your operating unit first, then global agreements, and finally quotations.



## Automatic Sourcing with Oracle Services Procurement

Oracle Services Procurement extends automatic sourcing by always attempting to find a source document with a matching commodity and job title. This is done regardless of the setting of the PO: Automatic Document Sourcing profile or commodity entries in the Approved Supplier List.

### Setting Up Automatic Sourcing

Use the Sourcing Rules windows to default a supplier and optionally a supplier site on your requisition or purchase order line. Use the Approved Supplier List or the PO: Automatic Document Sourcing profile if you also want to default source document information from a purchase agreement or quotation on your requisition or purchase order line for an item-supplier combination.

By defining and assigning sourcing rules, Purchasing actively defaults the appropriate supplier onto your document as soon as you enter an item or commodity.

#### To default the supplier, site, and source document information:

1. Set the profile option *PO: Automatic Document Sourcing*.

Setting this profile option to Yes means that Purchasing automatically searches for the most current purchase agreement or quotation for an item-supplier combination, and defaults the information from this document onto a newly created document line. This method is useful if you do not want to maintain the most current source documents in the Approved Supplier List, particularly if you receive these documents regularly from your suppliers through the Purchasing Documents Open Interface. If you set this profile option to Yes, you do not have to specify source documents in the Approved Supplier List.

Note that if an item on a requisition is associated with both a purchase agreement, a global agreement, and a quotation, Purchasing uses the purchase agreement, then the global agreement, and then the quotation even if the global agreement or quotation were created more recently.

Setting this profile option to No means that Purchasing defaults sourcing information onto a newly created requisition or purchase order line only from those documents you have specified in the Approved Supplier List. This method is useful if you prefer to maintain and update the Approved Supplier List with documents that you choose.

**Note:** If Oracle Services Procurement is implemented, for services lines the automatic sourcing logic always acts as though this profile is set to Yes. No automatic sourcing is performed for fixed price services.

2. If you set the profile option in the previous step to No, create a source document (a

purchase agreement or quotation) and then tie the document to an Approved Supplier List entry.

See: Defining the Supplier and Commodity/Item Combination, page 5-40. Then see: Defining the Supplier/Item Attributes, page 5-43.

If you set the profile option in the previous step to Yes, you do not have to perform this step, although you can if you want to. Purchasing still uses the source documents in the Approved Supplier List if they are the most current, and uses documents outside the Approved Supplier List if they are not.

**Note:** When Use Approved Supplier is checked for an item in the Master Items window, you cannot approve the source document until the supplier is in the Approved Supplier List. Therefore, if Use Approved Supplier is checked for an item, create the Approved Supplier List entry and source document in the following order:

- Create an Approved Supplier List entry (this is the approved supplier you are enforcing for the item).
- Create and save a source document.
- If the PO: Automatic Document Sourcing profile is No, return to the Approved Supplier List window and tie the source document to the supplier.

3. Define and assign sourcing rules as described in **To default just the supplier and the supplier site** below.

**To default just the supplier and the supplier site:**

1. Make sure you have satisfied the prerequisites for defining and assigning sourcing rules:
  - Define items. See: Defining Items, *Oracle Inventory User's Guide*.
  - Create suppliers and supplier sites in the Suppliers window. See: Suppliers, *Oracle iSupplier Portal Implementation Guide*.
  - Set the profile options *MRP: Sourcing Rule Category Set* and *MRP: Default Sourcing Assignment Set*. See: Purchasing Profile Options, page C-1.
2. Use the Sourcing Rule window to define sourcing rules. See: Defining Sourcing Rules, *Oracle Master Scheduling/MRP and Supply Chain Planning User's Guide*

**Note:** Some of the fields in the Sourcing Rule window may already

be completed for you if your supplier sends you catalog information electronically. See: Receiving Price/Sales Catalog Information Electronically, page 5-18.

3. Use the Sourcing Rule/Bill of Distribution Assignments window to assign your sourcing rules to particular items or organizations. See: Assigning Sourcing Rules and Bills of Distribution, *Oracle Master Scheduling/MRP and Supply Chain Planning User's Guide*.

**Important:** When you enter an Assignment Set name in the Sourcing Rule/Bill of Distribution Assignments window, note that Purchasing can use only one assignment set—the one that is specified in the profile option *MRP: Default Sourcing Assignment Set*. (Note that the User level for the profile option takes precedence.)

Although creating and assigning a sourcing rule in the Sourcing Rule windows is all you need to do to default a supplier and supplier site onto your documents, you can still also create approved suppliers in the Approved Supplier List window. For example, if you checked Use Approved Supplier in the Master Items window when defining an item, you must define the supplier in the Approved Supplier List window.

If you want to verify the sourcing rule, create a requisition for the item to verify that the Supplier and Site default. If the sourcing rule is local, make sure the Organization field on the requisition is the organization in which the sourcing rule was created.

## Troubleshooting

If you encounter any problems with automatic sourcing after you set it up, the following solutions may help.

### **Purchasing is not using the sourcing rules defined in the Sourcing Rule/Bill of Distribution window**

Make sure that you have done both of the following:

- Assigned the sourcing rules to an assignment set in the Sourcing Rule/Bill of Distribution Assignments window.
- Made sure that the Assignment Set name in this window matches the assignment set name in the profile option *MRP: Default Sourcing Assignment Set*.

Purchasing can use only one assignment set at a time, so if Purchasing is not using your sourcing rules, they may belong to another assignment set. For the *MRP: Default Sourcing Assignment Set* profile option, choose the assignment set name to which your sourcing rules are assigned in the Sourcing Rule/Bill of Distribution

Assignments window.

Also make sure that the profile option *MRP: Default Sourcing Assignment Set* isn't also set at the User level. The User value for profile options takes precedence over System Administrator level values. If you believe that Purchasing is not using the correct Assignment Set, check if the profile option is also set at the User level.

### **Source document information is not defaulting onto my requisition or purchase order**

Assuming you have defined and assigned sourcing rules, the problem could be one of the following:

- Make sure you have followed the instructions in the following two sections: *Defining the Supplier and Commodity/Item Combination*, page 5-40 and *Defining the Supplier/Item Attributes*, page 5-43. Make sure that, for the item, the supplier and site in the Approved Supplier List matches the supplier and site in the sourcing rule.
- The Approved Supplier List entry may be local. In the Approved Supplier List window, choose the Record Details tabbed region and note the Global field. If the Global field is set to No, then the sourcing information specified for the item is used only locally, by your organization or the organization that originally created the Approved Supplier List entry, and other organizations will not receive the source document information. Likewise, if there are two Approved Supplier List entries for an item, and one is local and the other is global, the local entry takes precedence for your organization.
- Sometimes you may see just one, Global entry in the Approved Supplier List window, but local versions of that entry are visible only in the Supplier-Item Attributes window. Recall that a local entry takes precedence over a global one and is used only by the organization in which it was created. In the Approved Supplier List window, choose the Attributes button. If local entries exist, the Create Local button will be dimmed.

### **Related Topics**

*Setting Up and Implementing Sourcing Strategies, Oracle Master Scheduling/MRP and Supply Chain Planning User's Guide*

*Sourcing Rules and Bills of Distribution, Oracle Master Scheduling/MRP and Supply Chain Planning User's Guide*

*Overview of Automatic Sourcing, page 5-24*

### **Defining Sourcing Rules**

You can define sourcing rules that specify how to replenish items in an organization, such as purchased items in plants. Sourcing rules can also specify how to replenish all organizations, as when the entire enterprise gets a subassembly from a particular

organization.

If there is a conflict between a sourcing rule and a bill of distribution, the sourcing rule takes precedence. For instance, if you assign a bill of distribution to AUS that tells it to source a part from NYC, AUS can still define a sourcing rule to source the part from SAC. In this case, the local sourcing rule overrides the bill of distribution.

**To define a sourcing rule:**

1. Navigate to the Sourcing Rule window.

Type	Org	Supplier	Supplier Site	Allocation % Rank	Shipping Method	Intransit Time
Buy From		Supplier A	SUPPLIER A S	60 1		
Buy From		Supplier 7	SITE 7	40 1		

2. Enter a unique sourcing rule name.
3. Indicate whether this sourcing rule is used for all organizations (global) or a single organization (local).  

If the sourcing rule is local, you *must* enter an organization name; otherwise, your current organization will be the receiving organization.
4. Choose Copy From to copy the effectivity dates and shipping organization from another sourcing rule into this one.
5. Enter effectivity dates. You must enter a start date, but entering an end date is optional.
6. For each range of effectivity dates, you can include multiple shipping organizations. For each shipping organization you want to include, select a sourcing type to specify whether you make, buy, or internally transfer the item. You can also copy a list of shipping organizations from an existing sourcing rule.

If you enter a customer organization as the receiving organization, then you cannot select a supplier organization as the shipping organization.

**Note:** Suppliers and supplier sites are predefined in Oracle Payables. (See: Suppliers, *Oracle iSupplier Portal Implementation Guide*.)

7. Enter an allocation percentage for each shipping organization. Allocation percentage includes the number of planned orders issued to the part for the entire the planning horizon. Your total allocation may not exceed 100.

If the allocation percentage for all the shipping organizations included within a range of effectivity dates equals 100, Planning Active is checked. If the sourcing rule is not planning active, the planning process will not use the rule to assign planned orders.

**Note:** You cannot set the allocation percentage to less than or greater than 100 for sourcing rules that are already assigned in assignment sets.

8. Enter a numeric rank value to prioritize each sourcing type.

If you have two sources with the same allocation percentage, planned orders are sourced from the highest rank first.

9. Select a shipping method, such as FEDEX, UPS, or rail. (See: Defining Shipping Methods, *Oracle Inventory User's Guide*.)

**To copy shipping organizations from an existing sourcing rule:**

1. Select a sourcing type to specify whether you make, buy, or internally transfer the item.
2. Choose Copy Shipping Orgs From.
3. In the Find window, select a sourcing rule that includes the shipping organizations you want to duplicate in this new sourcing rule.
4. Choose OK.

**To purge a sourcing rule:**

1. Select a sourcing rule name.
2. Choose Purge.

## Assigning Sourcing Rules and Bills of Distribution

Once you have defined your sourcing rules and bills of distribution, you must assign them to particular items and/or organizations. These assignments are grouped together in assignment sets. This is where your various sourcing strategies define a particular supply chain network.

Each assignment set to represents selection of organizations and/or items you want planned. To influence the planning process, you must include an assignment set in your plan options.

In an assignment set you can assign your sourcing rules and bills of distribution at different levels, as follows:

- an item across all organizations
- a single item in an inventory organization
- all items in an inventory organization
- categories of items
- categories of items in an inventory organization
- all organizations

These levels allow you to assign a replenishment rule to as many or as few items as possible. For example, a category of items could be defined as packaging material, and a sourcing rule that identifies the suppliers could be assigned.

### **To assign a sourcing rule or bill of distribution:**

1. Navigate to the Sourcing Rule/Bill of Distribution Assignments window.

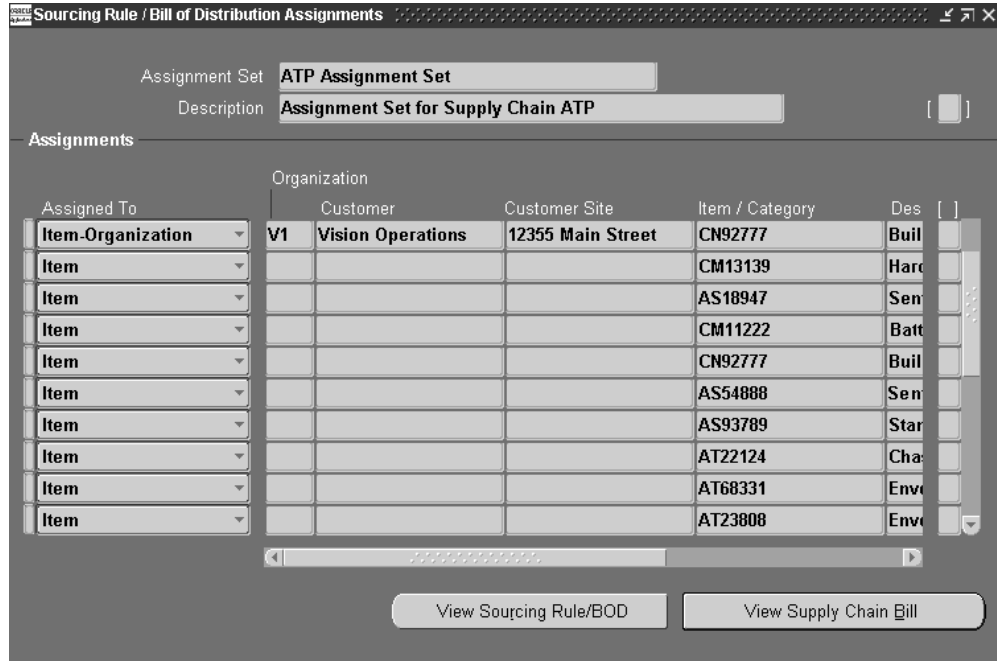

2. Enter an assignment set name and description.

**Note:** The assignment set name specified in the profile option *MRP: Default Sourcing Assignment Set* is the only one that Purchasing uses. If you want this assignment set to be used by Purchasing, update the profile option with this assignment set name, or create an assignment set that matches the profile option.

3. Select an Assigned To type. See: *Assignments Hierarchy, Oracle Master Scheduling/MRP and Supply Chain Planning User's Guide*

**Note:** You can assign a sourcing rule or bill of distribution to a category only if the profile option *MRP: Sourcing Rule Category Set* is set. See: *Profile Options in Purchasing*, page C-1.

4. Enter an organization name, if the Assigned To type requires one.

**Note:** You cannot assign customers modelled as organizations to a global sourcing rule.

5. Enter an Item/Category if you selected Item or Item-Org as the Assign To type.
6. Enter the sourcing rule or bill of distribution as the Type.



7. Enter the name of the sourcing rule or bill of distribution.

**To purge a sourcing rule or bill of distribution:**

1. Select an assignment set name.
2. Choose Purge.

## Approved Supplier List

All procurement organizations maintain lists that associate the items and services they buy with the companies who supply them, either formally or informally. Data stored in a controlled, global repository containing relevant details about each ship-from/ship-to/item relationship, is known as an Approved Supplier List (ASL). This repository includes information about all suppliers with business statuses including **Approved, Debarred, or New**.

Use the Approved Supplier List and Supplier-Item Attributes windows to specify blanket purchase agreements, contract purchase agreements, or quotations as source documents for a particular item and supplier or particular item category (commodity) and supplier. Purchasing automatically defaults this source document information, such as the Buyer, supplier Contact, and Supplier Item Number, for the item or commodity onto the requisition line. Standard purchase orders get source document information from global agreements and quotations. Requisitions get source document information from blanket purchase agreements, contract purchase agreements, or quotations. See: *Defining the Supplier and Commodity/Item Combination*, page 5-40. See: *Defining the Supplier/Item Attributes*, page 5-43.

**Note:** Purchasing can also search for the most current source documents for you, without your setting up the Approved Supplier List, if you set the profile option *PO: Automatic Document Sourcing* to Yes. See: *Setting Up Automatic Sourcing*, page 5-27

## Related Topics

*Defining Approved Supplier Statuses*, page 5-37

*Overview of the Approved Supplier List*, *Oracle Supplier Scheduling User's Guide*

*Main Features of Oracle Supply Chain Planning*, *Oracle Master Scheduling/MRP and Supply Chain Planning User's Guide*

*Overview of Automatic Sourcing*, page 5-24

## ASL Repository Maintenance

Through maintenance of the Approved Supplier List repository the following goals are realized:

- Supports Supplier Certification programs by providing a single store of information regarding a supplier's current status.
- Helps design engineers achieve higher quality designs at a lower total cost through the re-use of preferred suppliers in new designs. Avoids supply base proliferation or unnecessary design dependence on 'difficult' suppliers.
- Eliminates redundant sourcing efforts within departments, and across organizations. Facilitates a more global approach to contract negotiation.
- Provides immediate procurement visibility when a supplier is assigned an unfavorable status. This 'early warning' can help prevent problem replication in multiple organizations.
- Complies with external Quality System process requirements like ISO 9001/9002.  
If Oracle Quality is implemented, eRecord tracking of ASL changes can be done. See FDA CFR 21 Part 11, *Oracle Quality User's Guide*.
- Provides storage for general data attributes that are unique to the supplier/item intersection.
- Maintains lists of supplier 'candidates' by commodity or item for future consideration.

## ASL Business Needs

Using Oracle Purchasing Approved Supplier List, you can:

- Set approval/certification status at the appropriate level for your business. For example, approve a supplier for a given commodity (e.g. 'Office Supplies') for expense purchases while approving a specific supplier/site for each production item.
- Approve suppliers (they perform their own manufacturing), distributors (they represent manufacturers), and manufacturers (they manufacture items marketed and sold by distributors).
- Define global or local ASL entries. All organizations should be able to specify their own attributes (information about the supplier/item relationship) even if the supplier/item status is defined as a global record. This enables individual ship-to-organizations to determine, for example, whether they are ready to perform supplier scheduling, their purchasing unit of measure, their default item price, etc.
- Link the primary supplier item number with your internal item number. This designated item will default to Purchase Order and Requisition lines.

- Specify a Review By date indicating a proactive, planned review of the business with a longstanding supplier partner.
- Review ASL information in a flexible inquiry format.
- Define your own approval statuses and associate them with specific business rules.
- Control procurement activity by preventing purchase order approval or supplier schedule confirmation for certain supplier/item combinations.
- Control whether Sourcing Rules must be comprised of approved suppliers.
- Define reference information, including planning constraints such as lead time, for the supplier/item combination.
- Disable ASL entries. See: Defining the Supplier and Item/Commodity Combination, page 5-40.

## Related Topics

Setting Up Automatic Sourcing, page 5-27

Overview of Supplier Scheduling, *Oracle Supplier Scheduling User's Guide*

Sourcing Rules and Bills of Distributions, *Oracle Master Scheduling/MRP and Supply Chain Planning User's Guide*

Bucket Patterns, *Oracle Supplier Scheduling User's Guide*

Defining Supplier Lists, page 5-81

Defining Ship-to Organization Level Defaults and Controls, *Oracle Supplier Scheduling User's Guide*

Defining the Supplier/Item Attributes, page 5-43

Defining Approved Supplier Statuses, page 5-37

View Approved Suppliers, page 5-48

Defining the Supplier and Item/Commodity Combination, page 5-40

Defining Sourcing Rules, page 5-30

Defining Bills of Distributions, *Oracle Master Scheduling/MRP and Supply Chain Planning User's Guide*

## Defining Approved Supplier Statuses

You can create any number of Approved Supplier Statuses to describe the condition of the Approved Supplier, ranging from fully Approved (the supplier has demonstrated the ability to satisfy rigorous quality, cost, and delivery requirements over a sustained period) to Debarred (no business is allowed with this supplier for a particular item or

commodity), or New if you have never placed a purchase order with the supplier.

**Note:** If you debar a supplier for a specific commodity (category) in the Approved Supplier List, the supplier is prevented from supplying all items within that commodity. However, if you approve a supplier for a commodity, the item-specific status for the supplier still takes precedence.

Each Approved Supplier Status can have business rules applied to manage the characteristics of the status. You can prevent or allow certain business rules for each status, change the name of a status, or create a status of your own. For example, the default status of Approved allows all the default business rules: PO Approval, Sourcing, Schedule Confirmation, and Manufacturer Linking. But you could change the Approved status to prevent one of the Business Rules. Likewise, you can create your own status with your own combination of Business Rules.

In the Status field in the Approved Supplier List window, Purchasing lets you choose among these supplier statuses. Defining your own supplier statuses in this window is optional.

**To define Approved Supplier Statuses:**

1. Navigate to the Approved Supplier List Statuses window.

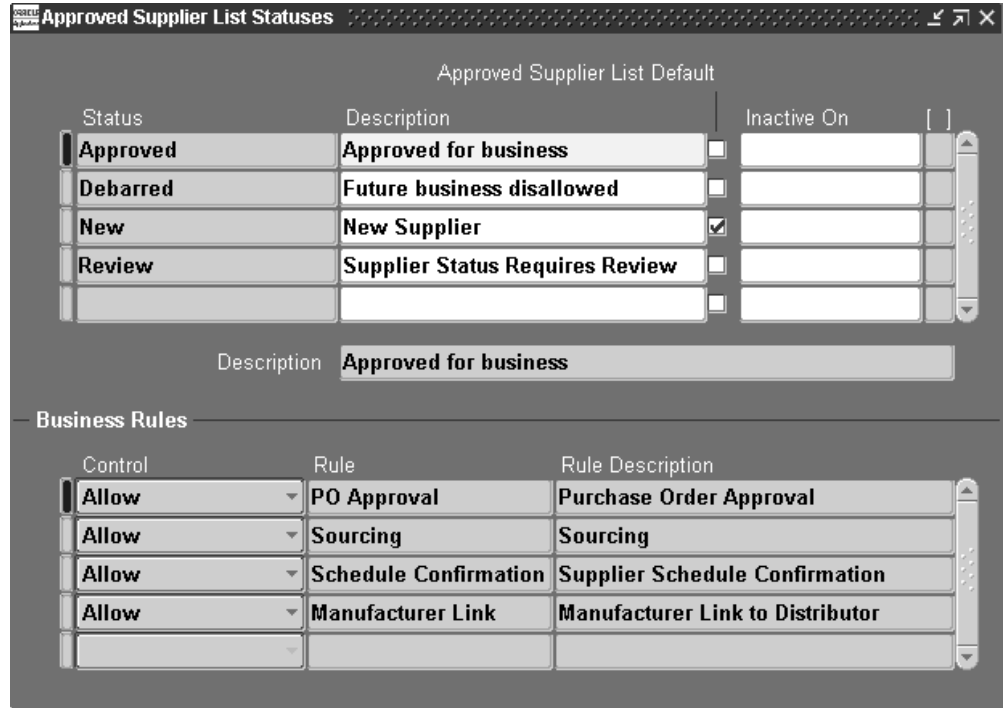

2. Enter a unique Status name.
3. Enter a status Description to convey the meaning of the status.
4. Optionally check Approved Supplier List Default to set this status as a default.

This is the status that appears as the default for suppliers you add to the Approved Supplier List window. (You can change a supplier's status from within the Approved Supplier List window.)

**Note:** You can only have one Approved Supplier Status as a default.

5. Optionally choose a date for Inactive On to set the time when the status will no longer be active.
 

Existing Approved Supplier List entries still use the status you inactivate today. New entries you create, however, will not.
6. If you choose to apply Business rules to the Approved Supplier Status, choose a Control. By choosing a Control, you either Allow or Prevent the Business Rule.
7. Select a Business Rule.
  - PO Approval - Enables you to allow or prevent purchase order approvals

sourced to this supplier.

- Sourcing - Enables you to allow or prevent sourcing to this supplier.
- Schedule Confirmation - Enables you to allow or prevent schedule confirmation for this supplier in Supplier Scheduling.
- Manufacturer Link - In the Approved Supplier List window, you choose a Business from one of the following: Direct (Supplier), Manufacturer, or Distributor. If you have a Distributor defined in the Approved Supplier List window, this Business Rule enables you to allow or prevent linking to the Manufacturer also defined in the Approved Supplier List window.

## Related Topics

Defining Planners, *Oracle Master Scheduling/MRP and Supply Chain Planning User's Guide*

View Approved Suppliers, page 5-48

Defining the Supplier and Item/Commodity Combination, page 5-40

## Defining the Supplier and Item/Commodity Combination

### Prerequisites:

- Define items. See: *Defining Items, Oracle Inventory User's Guide*.
- Create suppliers and supplier sites in the Suppliers window. See: *Suppliers, Oracle iSupplier Portal Implementation Guide*.

### To define the supplier and item/commodity combination:

1. Navigate to the Approved Supplier List window.
2. In the Organizations window that appears, choose the ship-to organization for which you want to define Approved Supplier List (ASL) entries.

Type	Commodity	Item	Description
Item		AS54999	Sentinel Standard Desktop - Rugged

Business	Supplier	Site	Status	Disabled	Supplier Item	Manufacturer
Direct	Advanced Network	SANTA CLARA	Approved	<input type="checkbox"/>		
				<input type="checkbox"/>		
				<input type="checkbox"/>		
				<input type="checkbox"/>		
				<input type="checkbox"/>		

3. Choose one of the following options to which you want to assign a supplier:

- Item - Assigns a supplier to a particular item.
- Commodity - Assigns a supplier to a group of items belonging to a category (or commodity).

**Note:** If you have defined your item in the item master with the Must Use Approved Vendor flag set to Yes, Purchasing will use the item level ASL when both item and commodity ASLs exist. If the flag is set to No, both commodity and item ASLs would be considered.

4. Select an Item or Commodity.

5. Choose a Business from the following:

- *Direct* (Supplier): Company sells their products directly to you

If you choose Direct, choose the supplier Name and optionally, the Site.

**Important:** The supplier Name and Site, if you specify one, must match the sourcing rule Supplier and Site to default the supplier information or source document information successfully. See: Defining Sourcing Rules, page 5-30.

- *Manufacturer*: Company manufactures and sells through distributors  
If you choose Manufacturer, choose the Manufacturer Name.
- *Distributor*: Company sells products made by manufacturers  
If you choose Distributor, choose the distributor Name and optionally, the Site.  
You must associate the Distributor with a Manufacturer, meaning you must define a Manufacturer before you define its Distributor.

6. Choose the supplier's approval Status.

Use one of the default Statuses provided, or choose a status of your own if you defined other statuses in the Approved Supplier List Statuses window. See: Defining Approved Supplier Statuses, page 5-37.

If you debar a supplier for a specific commodity, the supplier is prevented from supplying all items within that commodity. However, if you approve a supplier for a commodity, the item-specific status for the supplier still takes precedence.

7. Optionally choose the supplier item number.

For Suppliers and Distributors, this supplier item number defaults to your purchase order and requisition lines, and is used to validate the source documents.

8. Optionally choose a Review By date.

You can use this date to determine when a proactive business review will be performed for the supplier.

9. Choose the Record Details tabbed region.

10. Choose one of the following in Global:

- Yes - This ASL entry is valid for all inventory organizations in your operating unit.
- No - This ASL entry is local-that is, valid only for the organization you chose in the Organizations window when you first navigated to the Approved Supplier List window.

**Note:** If you have two ASL entries for the same item or commodity-one Global entry that applies to all organizations in your company and one local entry that applies only to your organization-the local entry takes precedence.

11. Optionally specify additional information, such as Supplier Scheduling, source documents, and capacity details for the ASL entry.



See: Defining the Supplier/Item Attributes, page 5-43.

**To disable an ASL entry that you no longer want to use:**

1. In the Approved Supplier List window, identify the line (ASL entry) you want to disable.
2. In the Key Attributes tabbed region, select the Disabled check box for the line.

The item-supplier combination in this ASL entry is inactive for new documents that you create. Note that disabling an ASL entry is not the same as debarring a supplier. Debarring a supplier prevents sourcing to that supplier for that item or for all items in that commodity. Disabling an ASL entry disables just that line. You will still be able to source to that supplier if a separate ASL entry for the supplier is enabled.

If you disable a local ASL entry, Purchasing uses the Global entry instead, if there is one.

**To re-enable a supplier and item/commodity combination:**

- Deselect the Disabled check box.

The item-supplier combination in this ASL entry is now active for new documents you create.

## Related Topics

Overview of Automatic Sourcing, page 5-24

Defining Sourcing Rules, page 5-30

Assigning Sourcing Rules and Bills of Distribution, page 5-33

Setting Up and Implementing Sourcing Strategies, *Oracle Master Scheduling/MRP and Supply Chain Planning User's Guide*

Defining the Supplier/Item Attributes, page 5-43

## Defining the Supplier-Item Attributes

Use the Supplier-Item Attributes window to specify additional information for the Approved Supplier List entry, including source document, Supplier Scheduling, and planning constraint information.

**To define the supplier and commodity-item attributes:**

1. Navigate to the Supplier-Item Attributes window by choosing the Attributes button in the Approved Supplier List window.

Supplier-Item Attributes (M1)

Global  
 Local

Item: f11000    Commodity:   
 Supplier: Office Supplies, Inc.    Site: OFFICESUPPL  
 Operating Unit: Vision Operations

Purchasing UOM: Each  
 Release Method: Release Using AutoCrea  
 Price Update Tolerance:  %  
 Country of Origin:

Source Documents    Supplier Scheduling    Planning Constraints    Inventory

Seq	Type	Number	Line	Global	Owning Org	Status	From
1	Blanket	1115	1	<input type="checkbox"/>		Approved	
				<input type="checkbox"/>			
				<input type="checkbox"/>			
				<input type="checkbox"/>			
				<input type="checkbox"/>			

**Note:** The Create Local button creates a copy of an existing global Approved Supplier List entry and makes it local to your organization. The Create Local button is not available if you are already creating a local entry or if a local entry for the item (in this or the Approved Supplier List window) already exists.

2. Choose the Purchasing UOM.
3. Choose the Release generation Method from the following options:
  - *Automatic Release/Review*: automatically generate releases, but require a separate step for approval. Run the Create Releases process to generate the release.
  - *Automatic Release*: automatically generate approved releases. You cannot choose this option if purchase order encumbrance is on. Run the Create Releases process to generate the release
  - *Release Using AutoCreate*: use the AutoCreate window or the PO Create Documents workflow to create releases.
4. Enter a Price Update Tolerance only if you are importing price/sales catalog information through the Purchasing Documents Open Interface.

The Price Update Tolerance specifies the maximum percentage increase allowed to a price for this item/supplier combination when the supplier sends updated price/sales catalog information through the Purchasing Documents Open Interface. This field affects only blanket purchase agreements and catalog quotations imported through the Purchasing Documents Open Interface. See: Setting a Price Tolerance in a Price/Sales Catalog Update, page 5-20.

5. Optionally choose the Country of Origin.

The Country of Origin is the country in which an item is manufactured. You can choose a Country of Origin if you specified a supplier Site in the Approved Supplier List window.

The Country of Origin is defaulted onto purchase orders for this item/supplier combination. However, you can change or enter the Country of Origin on the purchase order or later on the receipt.

6. Choose one of the following attribute groupings from the tabbed region:

- **Source Documents:** lets you associate specific quotations or purchase agreements with the supplier/item combination.
- **Supplier Scheduling:** lets you associate Supplier Scheduling information with the supplier/item combination. You can choose this option if you specified an item and a supplier site.
- **Capacity Constraints:** lets you specify capacity constraints for the supplier/item combination. You can choose this option if you specified an item and a supplier site.
- **Inventory:** if vendor managed inventory or consigned inventory are enabled, this region lets you specify inventory control information for the supplier/item combination. You can choose this option if you specified an item and a supplier site.

**If you chose Source Documents:**

1. **Note:** Setting the profile option *PO: Automatic Document Sourcing* to Yes enables Purchasing to default source documents automatically if you prefer that rather than specifying source documents here. See: Setting Up Automatic Sourcing.

2. Enter a unique Seq (Sequence) Number.

The Sequence Number is used internally. If you enter more than one source document, Oracle Purchasing will use the document with the lowest sequence number.

3. Select a Document Type from the following:

- Blanket
- Contract
- Quotation

A requisition with a quotation or a contract purchase agreement as a source document becomes a standard purchase order. A requisition with a blanket purchase agreement as a source document becomes a release.

If you are creating a Blanket as a source document for Oracle Supplier Scheduling, make sure the Supply Agreement option is selected for the blanket purchase agreement in the Terms and Conditions window. See: Entering Purchase Order Details Information, page 4-61. Supplier Scheduling can communicate releases against a blanket purchase agreement only when this option is selected.

4. Choose a Document Number.

If Purchasing does not let you enter a particular document number, it may be because the document is frozen, canceled, or not approved, or the agreement line is canceled. A quotation must be active.

5. Choose a Line Number.

The Status and Effective Dates, if any, are displayed.

If this document is a global agreement the Global check box will be checked.

**If you chose Supplier Scheduling:**

1. Optionally check Enable Planning Schedules and/or Enable Shipping Schedules if you want to build Planning and/or Shipping Schedules.

If you check Enable Planning Schedules and/or Enable Shipping Schedules, you can choose an assigned Scheduler.

2. Check Enable AutoSchedule if you want your schedule automatically built.

3. If you check Enable Planning Schedules and Enable AutoSchedule, you must choose the following:

- Plan Bucket Pattern
- Plan Schedule Type

4. If you check Enable Shipping Schedules and Enable AutoSchedule, you must choose the following:

- Ship Bucket Pattern

- Ship Schedule Type
5. If you check Enable Planning Schedules and Enable Authorizations, you can optionally choose up to four Resource Authorizations with their associated timefences.

**If you chose Planning Constraints:**

1. **Note:** The information you enter here is used by Supply Chain Planning for planned orders. See: Overview of Supply Chain Planning Logic, *Oracle Master Scheduling/MRP and Supply Chain Planning User's Guide*.
2. In the Processing Lead Time field, enter the number of lead days it takes to receive this item after ordering it.
3. Choose a Supplier Capacity Calendar pattern to define the dates upon which the supplier delivers to this organization.  
This calendar is independent of your workday calendar.
4. Choose Order Modifier options to indicate ordering constraints, if any:
  - *Minimum Order quantity:* The minimum quantity you can order.
  - *Fixed Lot Multiple:* The incremental quantity you can order on top of the Minimum Order quantity. For example, if the Minimum Order quantity is 100 and the Fixed Lot Multiple is 10, you must order at least 100, and if you order more than that, you must order 110, 120, and so on.
5. Create one or more entries in the Capacity area to indicate what the capacity is during a certain period or periods:
  - *From Date:* The date from which the capacity constraints take effect.
  - *To Date:* The date (optional) until which the capacity constraints take effect.
  - *Capacity per Day:* Quantity of units per day. This field is required if a From Date is entered.
6. Create one or more entries in the Tolerance Fences area to indicate how the capacity fluctuates depending on how many days in advance you order:  
For example, if you enter 12 Days in Advance and a Tolerance % of 2, you can exceed the supplier's capacity by 2 percent if you order 12 days in advance. You must specify a Tolerance % if you specify Days in Advance.

**If you chose Inventory:**

1. The information that you enter here enables use of the Vendor Managed Inventory (VMI) and Consigned Inventory functionality within Purchasing.  
For VMI check VMI Enable and:
2. Enter the UOM that the following minimum and maximum quantities represent.
3. Enter the Minimum quantity level for this item.
4. Enter the Maximum quantity level for this item.
5. If Supply Chain Exchange (SCE) is enabled, check the Automatic Allowed box to enable the replenishment method approval selection below.
6. Select the replenishment Approval method of Automatic, Supplier and Buyer, or Buyer. This field is only enabled if SCE is enabled and VMI Automatic Allowed is checked.

For consigned inventory check Consigned from Supplier and:

1. Enter the number of days allowed before billing in Billing Cycle (Days).
2. The system will display the Last Billing Date.

## Related Topics

AutoScheduling, *Oracle Supplier Scheduling User's Guide*

Resource Authorizations, *Oracle Supplier Scheduling User's Guide*

Defining Sourcing Rules, page 5-30

Assigning Sourcing Rules and Bills of Distribution, page 5-33

Setting Up and Implementing Sourcing Strategies, *Oracle Master Scheduling/MRP and Supply Chain Planning User's Guide*

Defining the Supplier and Commodity/Item Combination, page 5-40

Paying Your Supplier, *Oracle Consigned Inventory and Vendor Managed Inventory Process Guide*

## View Approved Suppliers

Use the Approved Supplier List Summary window to view all the Approved Supplier List entries. When you select and open a line in the Approved Supplier List Summary window, the Approved Supplier List window for that supplier appears.

**To view the Approved Supplier List:**

1. Navigate to the Search Approved Supplier List window from the menu. The

Approved Supplier List Summary window opens.

2. Select the Operating Unit for your search.
3. Optionally choose or enter data into the available fields to further define your search.

**Note:** Check Include Global Entries to specify that Global Entries are to be included.

4. Choose Find to begin the search.

**Note:** You can choose Clear to erase the data from the form to redefine your search, or choose New to navigate to the Approved Supplier List window to define new approved suppliers.

5. Choose a record to view then choose Open to view your selection in the Approved Supplier List window.

## Entering RFQs

### Entering RFQ Headers

Use the RFQs window to:

- Enter and edit a request for quotation (RFQ)
- Review and edit an RFQ you autocreated from on-line requisitions

Each RFQ consists of header, line, and shipment information. You can send the RFQ to as many suppliers you want and decide how much item information to provide to the suppliers.

There are two methods of creating an RFQ; manual entry and by copying a blanket purchase agreement. Manual entry is described in this section below and the copy blanket agreement to RFQ process is described in detail in the Purchase Orders section. See: Copying Purchase Orders, page 4-99.

For information on the difference between RFQs and quotations, and the different types of RFQs and quotations, see: RFQs and Quotations, page 5-4.

**Note:** Whether or not you send an RFQ, suppliers can send you catalog quotations electronically, through the Purchasing Documents Open Interface. See: Receiving Price/Sales Catalog Information Electronically,

page 5-18.

**Prerequisites:**

- Define suppliers and supplier sites. See: Suppliers, *Oracle iSupplier Portal Implementation Guide*.
- Define supplier lists. See: Defining Supplier Lists, page 5-81.
- Define locations. See: Defining Locations, page 1-18.
- Define buyers. See: Defining Buyers, page 1-20.
- Define unit of measure classes. See: Defining Unit of Measure Classes, .
- Define units of measure. See: Defining Units of Measure, *Oracle Inventory User's Guide*.
- Define payment terms. See: Defining Payment Terms, *Oracle Payables User's Guide*.

**To enter RFQ header information:**

1. Navigate to the RFQs window. Purchasing displays today's date as the Created date and the functional Currency from your ledger.



RFQs - [New]

Operating Unit: Vision Operations

Number: [ ] Type: [ ] Created: 08-SEP-2006

Ship-To: L1 - LeaseQA Bill-To: L1 - LeaseQA Status: In Process

Due Date: [ ] Description: [ ] Reply Via: [ ]

Close Date: [ ] Buyer: Brown, Ms. Casey

Quote Approval Required

Quote Effectivity: [ ] - [ ]

Currency: USD [ ]

Num	Type	Item	Rev	Category	Description	UOM	[ ]

Item: [ ] [ ]

Currency... Terms Shipments Suppliers

2. Select the Operating Unit for this RFQ.
3. Enter a unique number for the RFQ. In the Purchasing Options window, you can choose whether RFQ numbers are numeric or alphanumeric and whether Purchasing automatically generates them when you save your changes. See: Defining Numbering Options, page 1-41.
4. In the Type field, enter one of the document names defined for RFQs. The list of values lists the Document Type (Document Name) and Quotation Class from the Document Types window. For existing RFQs, the list of values includes only RFQs with the same Quotation Class. See: Defining Document Types, page 1-67. See also: Types of Quotations and RFQs, page 5-5.
5. Enter the Ship-To and Bill-To locations for the items on the RFQ. See: Defining Locations, page 1-18.
6. Use the Status field to control the status of the RFQ:
  - *In Process* - The initial status when you create the RFQ.
  - *Active* - Choose this status when the RFQ is complete and you are ready to send it to your suppliers. Only Active RFQs are printed.
  - *Printed* - The status assigned to the RFQ when you have printed at least one copy of it. You must change the status to Active if you want to reprint the RFQ.

- *Closed* - Choose this status to close the RFQ when all suppliers have responded or when you no longer want responses. When you close an RFQ, Purchasing deletes all follow up notifications associated with it.
7. Enter the Due Date when you want your suppliers to reply. Purchasing prints the reply due date on the RFQ. Purchasing notifies you if the current date is between the RFQ reply due date and the close date and if the RFQ is Active. Purchasing knows that a supplier replied to an RFQ if you enter a quotation for this supplier referencing the RFQ. See: Viewing and Responding to Notifications, page 2-29. See: Entering Quotation Headers, page 5-62.
  8. Enter the Reply/Receive Via code for the method you want the supplier to use to send the quotation. For example, by mail, telephone, or FAX. See: Defining Lookup Codes, page 1-55.
  9. Enter the Close Date for the RFQ. Purchasing prints the close date on the RFQ. Purchasing notifies you if the current date is between the RFQ reply due date and the close date and if the RFQ is Active. Purchasing warns you when you enter a quotation against this RFQ after the close date. See: Viewing and Responding to Notifications, page 2-29.
  10. Select Require Quote Approval to enforce approval of any quotation referencing this RFQ before the quotation can be used for a purchase order.
  11. Purchasing displays your name as the Buyer. You can forward the RFQ to another buyer by choosing the name of this buyer from the list of values. The buyer you enter receives all notifications regarding this RFQ.
  12. Enter the beginning and ending Effectivity Dates for the supplier quotation.
  13. Enter RFQ lines in the Lines tabbed region: See: Entering RFQ Lines, page 5-53.

**To enter supplier information:**

- Select the Suppliers button to open the RFQ Suppliers window. See: Entering RFQ Supplier Information, page 5-55

**To enter currency information:**

- Select the Currency button to open the Currency window. See: Entering Currency Information, page 4-60.

**To enter terms and conditions information:**

- Select the Terms button to open the RFQ Terms window. See: Entering RFQ Terms Information, page 5-57.

**To enter shipment information:**

- When the Quotation Class of the header Type is Bid, you can select the Shipments button to open the RFQ Shipments window. See: Entering RFQ Shipment

Information, page 5-58.

**To enter price break information:**

- When the Quotation Class of the header Type is Catalog, you can select the Price Break button to open the Price Breaks window. See: Entering RFQ Price Break Information, page 5-60.

## Entering RFQ Lines

Use the Items tabbed region in the RFQs window to enter and edit RFQ lines.

**To enter an RFQ line:**

1. Select the Items tabbed region in the RFQs window.

The screenshot shows the 'RFQs (Vision Operations) - 100083' window. The header section contains the following fields: Number (100083), Type (Standard RFQ), Created (02/JAN/2001), Ship-To (HYDE), Bill-To (HYDE), Status (Active), Due Date (06/JAN/2001), Description (empty), Reply Via (Email), Close Date (10/JAN/2001), Buyer (Stock, Ms. Pat), and Currency (USD). There is also a checkbox for 'Quote Approval Required' and a 'Quote Effectivity' range from 16/JAN/2001 to 16/JAN/2002. The 'Items' tab is selected, showing a table with the following data:

Num	Type	Item	Rev	Category	Description	UOM
1	Goods	C1118		MISC.MISC	C1118	Each

Below the table, there are input fields for 'Item' (C1118) and 'C1118', and buttons for 'Currency...', 'Terms', 'Price Breaks', and 'Suppliers'.

2. Enter a unique Number for the RFQ line.
3. Enter the line Type for the item. When you enter a line type, Purchasing automatically copies the corresponding purchasing category, unit, and unit price. You can enter predefined items only when you choose a quantity based line type. Purchasing defaults the value you define in the Purchasing Options window. See: Defining Default Options, page 1-38. See: Defining Line Types, page 1-62.
4. Enter the Item for your RFQ line. Purchasing retrieves the item description, purchasing category, and unit of measure. If you do not enter a predefined item, you must provide a purchasing category and item description for the RFQ line. For amount based line types, the cursor does not enter this field. See: Defining Items, *Oracle Inventory User's Guide*.

5. Enter the Revision number for the item on the requisition line.
6. Enter the purchasing category for your RFQ line. If you enter a predefined item, Purchasing supplies the purchasing category.
7. Enter the item Description for your RFQ line. If you enter an item, Purchasing supplies the item description. You can set up the item definition so that you can override the item description for this particular RFQ. See: *Defining Items, Oracle Inventory User's Guide*.
8. Enter the UOM for your RFQ line. If you enter an item number, Purchasing supplies the unit of measure. For amount based line types, the cursor does not enter this field.
9. Enter an optional Target Price for the RFQ line. You may want to provide a target price on the RFQ line for negotiation purposes. For amount based line types, Purchasing uses a target price of 1.
10. Enter the supplier's number for the item.

**To enter additional RFQ line information:**

1. Select the More tabbed region in the RFQs window. You can enter optional information in the fields described in the following steps.
2. Enter a unique line number for your RFQ line. Purchasing defaults the next available line number.
3. Enter the UN Number for the item on the RFQ line. See: *Defining UN Numbers, page 1-54*.
4. Enter the Hazard class for the item on the RFQ line. If you enter a UN number, Purchasing displays the corresponding hazard class if one has been defined. See: *Defining Hazard Classes, page 1-53*.
5. Enter the Minimum Order Quantity for the item on the RFQ line.
6. Enter the Maximum Order Quantity for the item on the RFQ line.
7. Optionally enter a Project Number.
8. Optionally enter a Task Number.
9. Optionally enter a Contract Number for Oracle Project Contracts.
10. Optionally enter a Revision for Oracle Project Contracts.
11. Enter a note to the supplier about this item. This note prints on the RFQ.

**To copy RFQs to quotations:**

- Select Copy Document on the Tools menu to open the Copy Document window.  
See: Copying Quotations from RFQs, page 5-74.

**Related Topics**

Entering RFQ Headers, page 5-49

Entering RFQ Supplier Information, page 5-55

Entering RFQ Terms Information, page 5-57

Entering RFQ Shipment Information, page 5-58

Entering RFQ Price Break Information, page 5-60

Entering Currency Information, page 4-60

*Oracle Project Management User Guide, Oracle Project Management User Guide*

*Oracle Project Manufacturing Implementation Manual*

**Entering RFQ Supplier Information**

Use the RFQ Suppliers window to:

- Enter the suppliers to which this RFQ will be sent. You can also delete suppliers from the RFQ until you have printed the RFQ for them.
- Review the supplier activity.

**To enter RFQ supplier information:**

1. Navigate to the RFQ Suppliers window by selecting the Suppliers button in the RFQs window. For each supplier that you enter, Purchasing displays the Printed and Responded dates as well as the Count of the number of times the RFQ has been printed. The Responded date is the receipt date recorded for the quotation from the supplier.

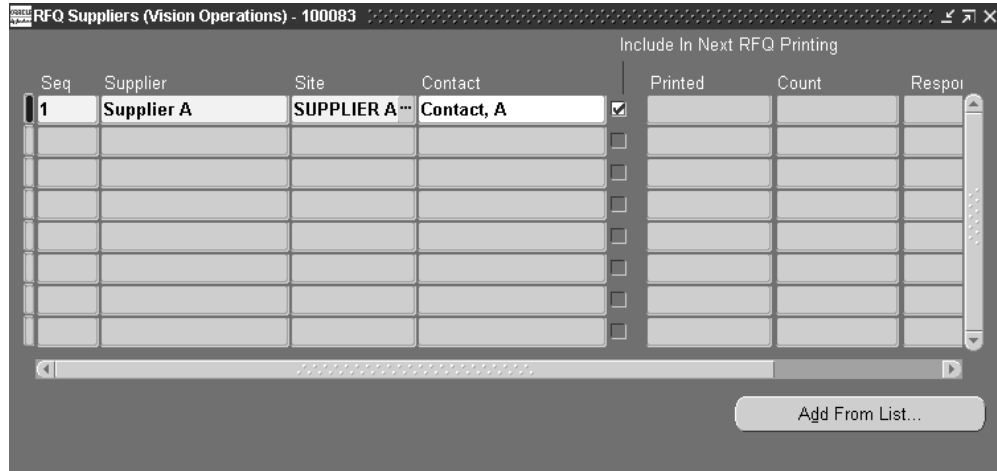

The Include In Next RFQ Printing check box is checked when you add a supplier. You can postpone printing the RFQ for a supplier by deselecting the check box. After you print the RFQ for a supplier, Purchasing deselects this field. If you want to reprint the RFQ for a supplier, you must use this window to select the field again.

2. Enter a unique sequence number for the supplier on the RFQ Suppliers list. Purchasing uses this sequence number to print your RFQs for these suppliers.
3. Enter the name of the active Supplier you want to place on the RFQ Supplier list. The list of values displays the supplier name, number, Tax ID number, and VAT number.
4. Enter the Supplier Site you want to place on the RFQ Supplier list for this supplier. You can choose only sites that you defined as RFQ Only suppliers. You cannot enter the same supplier site twice.
5. Enter the name of the Contact for this site
6. If you want to postpone printing the RFQ for a supplier, you can deselect Select for Printing.

**To add suppliers from supplier lists:**

1. Select the Add From List button in the RFQ Suppliers window to open the Supplier Lists window. This window is a display-only version of the Supplier Lists window, but includes only the Supplier List name, Description, and a Count of the number of suppliers on the list. See: Defining Supplier Lists, page 5-81.
2. Select any supplier list for which you want to copy all suppliers to the RFQ. Suppliers already on the RFQ are omitted.
3. Select the Apply button to close the window and add these suppliers to the RFQ.

Otherwise, you can select the Cancel button to return to the RFQ Suppliers window without adding suppliers from a list.

## Related Topics

Entering Currency Information, page 4-60

Entering RFQ Headers, page 5-49

Entering RFQ Lines, page 5-53

## Entering RFQ Terms Information

Use the RFQ Terms window to enter terms and conditions information for RFQs.

### To enter RFQ terms and conditions information:

1. Navigate to the RFQ Terms window by selecting the Terms button in the RFQs window. All terms and conditions information is optional. The defaults are from the Financial Options window. See: *Defining Financials Options, Oracle Payables User's Guide*.

The screenshot shows a window titled "RFQ Terms (Vision Operations) - 100083". Inside the window, there is a section titled "Terms and Conditions". This section contains several input fields: "Payment Terms" is set to "2/10 Net 30", "Freight Terms" is set to "Due", "Carrier" is empty, "FOB" is set to "Origin", and "Note To Supplier" is empty. There are also small icons for navigation and window control in the top right corner.

2. Enter the Payment terms for the RFQ. Purchasing displays default payment terms that you can accept or change. See: *Defining Payment Terms, Oracle Payables User's Guide*.
3. Enter the Freight terms for the RFQ. Purchasing displays default freight terms that you can accept or change. See: *Defining Lookup Codes, page 1-55*
4. Enter the freight Carrier for shipment of the RFQ. Purchasing displays a default freight carrier that you can accept or change. See: *Defining Freight Carriers, Oracle Shipping Execution Guide*.
5. Enter the FOB point for the RFQ. Purchasing displays a default free on board (FOB) designation that you can accept or change. See: *Defining Lookup Codes, page 1-55*.
6. Enter a Note To Supplier. You can enter up to 240 characters in this field.

## Related Topics

Entering RFQ Headers, page 5-49

Entering RFQ Lines, page 5-53

## Entering RFQ Shipment Information

Use the RFQ Shipments window to enter and review shipment information for Bid RFQs.

**Important:** Use this window to request as many shipment quotations as you want. You might want to provide multiple shipments if you want to receive quotations from your suppliers for different ship-to locations, quantities, or other criteria.

### To enter RFQ shipment information:

1. Navigate to the RFQ Shipments window by selecting the Shipments button in the RFQs window. This button is available only when the RFQ header Type has a Quotation Class of Bid. See: Entering RFQ Headers, page 5-49.

Num	Org	Ship To	Qty	UOM	Price	Last Accept Date	Need-By	Firm
1	V1	Atlanta	1	Each	714.83			<input type="checkbox"/>
								<input type="checkbox"/>
								<input type="checkbox"/>
								<input type="checkbox"/>
								<input type="checkbox"/>

Item

2. In the Shipments tabbed region, enter the shipment Number. Purchasing supplies shipment numbers in increments of one.
3. Enter the Organization.
4. Enter the Ship-To location for the quotation shipment. Purchasing defaults the ship-to location from the RFQ header.
5. Enter the Quantity for which you want to receive a quotation from your supplier.



6. Enter the shipping UOM for the RFQ shipment line. You may want the supplier to ship the item in different units of measure depending on the quantity ordered. Purchasing defaults the unit of measure from the RFQ line. For amount based line types, the field is not applicable.
7. Enter the unit Price for the RFQ shipment line. Leave this field blank if you want the supplier to provide a price independent of the price you want. For amount based line types, the cursor does not enter this field, and the price is set to 1.
8. Enter the Last Accept Date.
9. Enter the Need-By date.
10. Select Firm to indicate that the bid is firmed.  
  
The Approved check box indicates that there is an approved quotation shipment referencing this line.

**To enter additional RFQ shipment information:**

1. Select the More tabbed region in the RFQ Shipments window.
2. Enter the shipment number. Purchasing provides shipment numbers in increments of one.
3. Choose the Match Approval Level. The default is from the Purchasing Options window. See: Defining Default Options, page 1-38.
  - *Two-Way* - Purchase order and invoice quantities must match within tolerance.
  - *Three-Way* - Purchase order, receipt, and invoice quantities must match within tolerance.
  - *Four-Way* - Purchase order, receipt, inspection, and invoice quantities must match within tolerance.
4. Enter the Quantity Received Exception option. See: Defining Receiving Options, page 1-42.
  - *None* - Receipts may exceed the selected tolerance.
  - *Reject* - Receipts cannot exceed the selected tolerance.
  - *Warning* - The receiver gets a warning message, but receipts can exceed the tolerance.
5. Enter the Quantity Received Tolerance. The default is from the Receiving Options window. See: Defining Receiving Options, page 1-42.

## Related Topics

Entering RFQ Headers, page 5-49

Entering RFQ Lines, page 5-53

## Entering RFQ Price Break Information

Use the RFQ Price Breaks window to enter pricing information for RFQs.

**Important:** Use this window to request as many price breaks as you want. You can provide multiple price breaks if you want to receive quotations from your suppliers for different terms, ship-to locations, or quantities.

### To enter RFQ price break information:

1. Navigate to the RFQ Price Breaks window by selecting the Price Breaks button in the RFQs window. This button is available only when the RFQ header Type has a Quotation Class of Catalog.

Num	UOM	Quantity	Price	Org	Ship-To	Discount (%)	Effective	
							From	To
1	Each	1	714.83		HYDE			

Item: C1118 C1118

2. In the Price Break tabbed region, enter the line Number. Purchasing supplies line numbers in increments of one.
3. Enter the Quantity at this price.
4. Enter the shipping UOM for the RFQ price break line. You may want the supplier to ship the item in different units of measure depending on the quantity you order. Purchasing defaults the unit of measure from the RFQ line.
5. Enter the unit Price for the RFQ price break line. You might want to provide price discounts to indicate to the supplier the prices you would like to receive. Leave this

field blank if you want the supplier to provide a price independent of the price you want

6. Enter the Organization.
7. Enter the Ship-To location for the quotation line shipment. Purchasing defaults the ship-to location from the RFQ header.
8. Enter the Discount percentage from the unit price for the RFQ line. If you enter a unit price and break price for this line, Purchasing does not automatically calculate the discount. You should provide either a break price or a discount, not both. If you enter both values for the RFQ, Purchasing prints only the break price on the RFQ. If you provide a discount without providing a break price, Purchasing prints the discount on the RFQ.
9. Enter the Effective Date when you want to be able to start using the quotation from your supplier. If you leave this field blank, Purchasing applies the quotation effective date from the RFQ Header window. You can also enter lead time information instead of date information.
10. Enter the Expiration Date when you no longer need the quotation from your supplier. If you leave this field blank, Purchasing applies the expiration date from the RFQ header.
11. Enter the Lead Time for this RFQ line.
12. Enter the UOM you want to use to define the lead time.
13. Enter the Payment Terms for the RFQ. Purchasing prints these terms on the RFQ only if they are different from the terms on the RFQ header. The default is the payment terms from the RFQ header.
14. Enter the Freight Terms for the RFQ. Purchasing prints these terms on the RFQ only if they are different from the freight terms on the RFQ header. The default is the freight terms from the RFQ header.
15. Enter the FOB point for your RFQ Line. Purchasing prints this FOB point on the RFQ only if it is different from the FOB point on the RFQ header. The default is the FOB name from the RFQ header.
16. Enter the freight carrier for your RFQ. Purchasing prints this carrier on the RFQ only if it is different from the carrier on the RFQ header. The default is the carrier from the header.

The Approved check box indicates that there is an approved quotation shipment referencing this line.

**To enter additional RFQ price break information:**

1. Select the More tabbed region in the RFQ Price Breaks window.
2. Enter the line number. Purchasing provides line numbers in increments of one.
3. Choose the Match Approval Level. The default is from the Purchasing Options window. See: Defining Default Options, page 1-38.
  - *Two-Way* - Purchase order and invoice quantities must match within tolerance.
  - *Three-Way* - Purchase order, receipt, and invoice quantities must match within tolerance.
  - *Four-Way* - Purchase order, receipt, inspection, and invoice quantities must match within tolerance.
4. Enter the Quantity Received Tolerance. The default is from the Receiving Options window. See: Defining Receiving Options, page 1-42.
5. Enter the Quantity Received Exception option. See: Defining Receiving Options, page 1-42.
  - *None* - Receipts may exceed the selected tolerance.
  - *Reject* - Receipts cannot exceed the selected tolerance.
  - *Warning* - The receiver gets a warning message, but receipts can exceed the tolerance.

## Related Topics

Entering RFQ Headers, page 5-49

Entering RFQ Lines, page 5-53

## Entering Quotations

### Entering Quotation Headers

Use the Quotations window to:

- Enter and edit quotations
- Review and edit quotations you copied from RFQs

For information on the difference between RFQs and quotations, and the different types of RFQs and quotations, see: RFQs and Quotations, page 5-4.

**Note:** You can also receive catalog quotations electronically from your suppliers through the Purchasing Documents Open Interface. See: Receiving Price/Sales Catalog Information Electronically, page 5-18.

**Prerequisites:**

- Define suppliers and supplier sites. See: Suppliers, *Oracle iSupplier Portal Implementation Guide*.
- Define supplier lists See: Defining Supplier Lists, page 5-81.
- Define locations. See: Defining Locations, page 1-18.
- Define buyers. See: Defining Buyers, page 1-20.
- Define unit of measure classes. See: Defining Unit of Measure Classes, *Oracle Inventory User's Guide*.
- Define units of measure. See: Defining Units of Measure, *Oracle Inventory User's Guide*.
- Define payment terms. See: Defining Payment Terms, *Oracle Payables User's Guide*.

**To enter quotation header information:**

1. Navigate to the Quotations window by selecting Quotations from the menu. Purchasing displays the functional Currency from your ledger.

The screenshot shows the 'Quotations - [New]' window. The 'Operating Unit' is 'Vision Operations'. The 'Ship-To' and 'Bill-To' fields are both 'L1 - LeaseQA'. The 'Status' is 'In Process'. The 'Response Date' is '08-SEP-2006'. The 'Buyer' is 'Brown, Ms. Casey'. The 'Currency' is 'USD'. The 'Items' table is empty. The 'Approve...' button is highlighted.

2. Select the Operating Unit for the quotation.
3. Enter a unique number for the quotation. In the Purchasing Options window, you can choose whether quotation numbers are numeric or alphanumeric and whether Purchasing automatically generates them when you save your changes. See: Defining Numbering Options, page 1-41.
4. In the Type field, enter one of the document names defined for quotations. The list of values lists the Document Type (Document Name) and Quotation Class from the Document Types window. For existing quotations, the list of values includes only quotations with the same Quotation Class. See: Defining Document Types, page 1-67. See also: Types of Quotations and RFQs, page 5-5.
5. If you copied this quotation from an existing RFQ, Purchasing displays the corresponding RFQ number, which you can override.

You can also manually provide an RFQ number. Purchasing verifies the supplier and supplier site you provide and lets you choose from a corresponding list of RFQs. If you want to enter a quotation as a response to an RFQ for a supplier you did not provide on the RFQ supplier list, you need to modify the RFQ supplier list first. If you change the supplier or supplier site information on this quotation after you enter an RFQ number, Purchasing removes the RFQ number, and you must re-enter it. See: Entering RFQ Supplier Information, page 5-55.

If you enter the number of an RFQ for which you already entered a response for this supplier and supplier site, Purchasing displays a warning message but permits

your entry.

**Important:** If you are entering a quotation that is a response to an RFQ you previously sent to the supplier, you need to provide this RFQ number to indicate to Purchasing that the supplier responded.

6. Enter the Supplier for this quotation. When you enter a supplier name, Purchasing uses the default terms, conditions, and currency information for this supplier in the Quotation Terms and Currency windows. The list of values displays the supplier name, number, Tax ID number, and VAT number.
7. Enter the supplier Site for this quotation. You do not need to provide a supplier site for a quotation. When you enter a supplier site, Purchasing uses the default terms, conditions, and currency information for this supplier site in the Quotation Terms and Currency windows.
8. Enter a supplier Contact for this quotation.
9. Enter the Ship-To and Bill-To locations for the items on the quotation. See: Defining Locations, page 1-18.
10. Use the Status field to control the status of the quotation:
  - *In Process* - The initial status when you create the quotation. Purchasing sends you notifications that the quotation is awaiting completion.
  - *Active* - Choose this status when the quotation is complete and you are ready to approve it. Only Active quotations can be approved.
  - *Closed* - When you enter a quotation, you provide an expiration date for it. Purchasing sends you a notification when the quotation approaches expiration using the warning delay you provided in the quotation header. You can manually close the quotation to acknowledge the notification. If you do not acknowledge the notification by closing the quotation, the status of your quotation is still Active. You cannot use Closed quotation information on purchase orders.
11. Enter the Supplier Quote number.
12. Select Approval Required to indicate that approval is required to purchase goods based on this quotation.
13. The Response Date is the date you actually received the quotation. Purchasing defaults today's date as the response date, but you can change this date.
14. Enter the beginning and ending Effective Dates for the quotation.

15. Purchasing displays your name as the Buyer. You can forward the quotation to another buyer by choosing the name of this buyer from the list of values. The buyer you enter receives all notifications regarding this quotation.
16. Enter quotation lines in the Lines tabbed region. See: Entering Quotation Lines, page 5-66.

**To approve the quotation:**

- Select the Approve button to open the Approve Entire Quotation window. See: Approving Entire Quotations, page 5-79.

**To enter currency information:**

- Select the Currency button to open the Currency window. See: Entering Currency Information, page 4-60.

**To enter terms and conditions information:**

- Select the Terms button to open the Quotation Terms window. See: Entering Quotation Terms Information, page 5-69.

**To enter shipment information:**

- When the Quotation Class of the header Type is Bid, you can select the Shipments button to open the Quotation Shipments window. See: Entering Quotation Shipment Information, page 5-70.

**To enter price break information:**

- When the Quotation Class of the header Type is Catalog, you can select the Price Breaks button to open the Price Breaks window. See: Entering Quotation Price Break Information, page 5-72.

## Entering Quotation Lines

Use the Items tabbed region in the Quotations window to enter and edit quotation lines.

**Important:** If your supplier gives you a single quotation that is independent of the quantity you order, you must still provide at least one shipment quotation since you approve quotation information by shipment rather than by line. Therefore, if your supplier provides you with a base unit price only, you can enter the base unit price here, but you must also provide a shipment with the same base unit price.

**To enter a quotation line:**

1. Select the Items tabbed region in the Quotations window.



Quotations (Vision Operations) - 100112

Number		Type	Standard Quotati	RFQ	100083	
Supplier	Supplier A	Site	SUPPLIER A SITE	Contact	Contact, A	
Ship-To	V1- New York City	Bill-To	V1- New York City	Status	Active	
Description					Supplier Quote	
	<input checked="" type="checkbox"/> Approval Required				Response Date	16/JAN/2001
Effectivity	16/JAN/2001	-	16/JAN/2002	Buyer	Stock, Ms. Pat	
					Currency	USD

Items More

Num	Type	Item	Rev	Category	Description	UOM	
1	Goods	C1118		MISC.MISC	C1118	Each	...

Item C1118 C1118

Currency... Terms Price Breaks Approve...

2. Enter a unique Number for the quotation line.
3. Enter the line Type for the item. When you enter a line type, Purchasing automatically copies the corresponding purchasing category, unit, and unit price. You can enter predefined items only when you choose a quantity based line type. Purchasing defaults the value you define in the Purchasing Options window. See: Defining Default Options, page 1-38. See: Defining Line Types, page 1-62.
4. Enter the Item for your quotation line. Purchasing retrieves the item description, purchasing category, and unit of measure. If you do not enter a predefined item, you must provide a purchasing category and item description for the quotation line. For amount based line types, the cursor does not enter this field. See: Defining Items, *Oracle Inventory User's Guide*.
5. Enter the Revision number for the item on the requisition line.
6. Enter the purchasing Category for your quotation line. If you enter a predefined item, Purchasing supplies the purchasing category.
7. Enter the item Description for your quotation line. If you enter an item, supplies the item description. You can set up the item definition so that you can override the item description for this particular quotation. See: Defining Items, *Oracle Inventory User's Guide*.
8. Enter the UOM for your quotation line. If you enter an item number, Purchasing supplies the unit of measure. For amount based line types, the cursor does not enter

this field.

9. Enter the unit Price for the quotation line. For amount based line types, Purchasing uses a target price of 1.
10. Enter the supplier's number for the item.

**To enter additional quotation line information:**

1. Select the More tabbed region in the Quotations window. You can enter optional information in the fields described in the following steps.
2. Enter a unique line number for your quotation line. Purchasing defaults the next available line number.
3. Enter the UN Number for the item on the quotation line. See: Defining UN Numbers, page 1-54. If you enter a UN number, Purchasing displays the corresponding hazard class if one has been defined.
4. Enter the Hazard class for the item on the quotation line. See: Defining Hazard Classes, page 1-53.
5. Enter the Minimum Order Quantity for the item on the quotation line.
6. Enter the Maximum Order Quantity for the item on the quotation line.
7. Optionally enter a Project Number.
8. Optionally enter a Task Number.
9. Optionally enter a Contract Number for Oracle Project Contracts.
10. Optionally enter a Revision for Oracle Project Contracts.
11. Enter a Note From Supplier about this item.

**To approve the quotation:**

- Select the Approve button to open the Approve Entire Quotation window. The Approve button is disabled if the quotation is not active and doesn't have at least one shipment. See: Approving Entire Quotations, page 5-79.

## Related Topics

Entering Currency Information, page 4-60

Entering Quotation Headers, page 5-62

Entering Quotation Terms Information, page 5-69

Entering Quotation Shipment Information, page 5-70

## Entering Quotation Terms Information

Use the Quotation Terms window to enter terms and conditions information for quotations.

### To enter quotation terms and conditions information:

1. Navigate to the Quotation Terms window by selecting the Terms button in the Quotations window. All terms and conditions information is optional. If you created the quotation using the Copy Document window, the defaults are from the RFQ. Otherwise, the defaults are from the supplier site, supplier, or the Financial Options window. See: Defining Financials Options, *Oracle Payables User's Guide*.

Quotation Terms (Vision Operations) - 100112

Terms and Conditions

Payment Terms	10/10 Net 30	Freight Terms	Due
Carrier	Roadway	FOB	Origin
Note From Supplier			
Created	16/JAN/2001	Received Via	
Warning Delay	7		

2. Enter the Payment terms for the quotation. Purchasing displays default payment terms that you can accept or change. See: Defining Payment Terms, *Oracle Payables User's Guide*.
3. Enter the Freight terms for the quotation. Purchasing displays default freight terms that you can accept or change. See: Defining Lookup Codes, page 1-55
4. Enter the freight Carrier for shipment of the quotation. Purchasing displays a default freight carrier that you can accept or change. See: Defining Freight Carriers, *Oracle Shipping Execution Guide*.
5. Enter the FOB point for the quotation. Purchasing displays a default free on board (FOB) designation that you can accept or change. See: Defining Lookup Codes, page 1-55.
6. Enter a Note To Supplier. You can enter up to 240 characters in this field.
7. Enter the method the supplier used to answer to your RFQ. For instance, you could ask your supplier to send a quotation by mail, telephone, or FAX. See: Defining Lookup Codes, page 1-55.

8. Enter the Warning Delay (in days) that you want Purchasing to use when sending you an on-line notification before the quotation expiration date.
9. Save your work.

## Related Topics

- Entering Quotation Headers, page 5-62
- Entering Quotation Lines, page 5-66

## Entering Quotation Shipment Information

Use the Quotation Shipments window to enter shipment information for bid quotations.

### To enter quotation shipment information:

1. Click Shipments to open the Quotation Shipments window.

Num	Org	Ship To	Qty	UOM	Price	Last Accept Date	Need-By	Firm	AI
1	V1	V1- New York C		Each	50			<input type="checkbox"/>	<input type="checkbox"/>
								<input type="checkbox"/>	<input type="checkbox"/>
								<input type="checkbox"/>	<input type="checkbox"/>
								<input type="checkbox"/>	<input type="checkbox"/>
								<input type="checkbox"/>	<input type="checkbox"/>

Item: 20000    Paper - requires 2-way match office supply item

Approve...

2. In the Shipments tabbed region, enter the shipment Number. Purchasing supplies shipment numbers in increments of one.
3. Enter the Organization.
4. Enter the Ship-To location for the quotation shipment. Purchasing defaults the ship-to location from the quotation header.
5. Enter the Quantity for which you received a quotation from your supplier.
6. Enter the shipping UOM for the quotation shipment line. You may want the supplier to ship the item in different units of measure depending on the quantity ordered. Purchasing defaults the unit of measure from the quotation line. For amount based line types, the field is not applicable.

7. Enter the unit Price for the quotation shipment line. For amount based line types, the cursor does not enter this field, and the price is set to 1.
8. Enter the Last Accept Date.
9. Enter the Need-By date.
10. Select Firm to indicate that the bid is firmed.

The Approved check box indicates whether the shipment has been approved.

**To enter additional quotation shipment information:**

1. Select the More tabbed region in the Quotation Shipments window.
2. Enter the shipment number. Purchasing provides shipment numbers in increments of one.
3. Choose the Match Approval Level. The default is from the Purchasing Options window. See: Defining Default Options, page 1-38.
  - *Two-Way* - Purchase order and invoice quantities must match within tolerance.
  - *Three-Way* - Purchase order, receipt, and invoice quantities must match within tolerance.
  - *Four-Way* - Purchase order, receipt, inspection, and invoice quantities must match within tolerance.
4. Enter the Quantity Received Tolerance. The default is from the Receiving Options window. See: Defining Receiving Options, page 1-42.
5. Enter the Quantity Received Exception option. See: Defining Receiving Options, page 1-42.
  - *None* - Receipts may exceed the selected tolerance.
  - *Reject* - Receipts cannot exceed the selected tolerance.
  - *Warning* - The receiver gets a warning message, but receipts can exceed the tolerance.

**To approve the quotation:**

- Select the Approve button to open the Approve Entire Quotation window. See: Approving Entire Quotations, page 5-79.

## Related Topics

Entering Quotation Headers, page 5-62

## Entering Quotation Price Break Information

Use the Quotation Price Breaks window to enter pricing information for catalog quotations.

**To enter quotation pricing information:**

1. Select the Price Breaks button to open the Quotation Price Breaks window. This button is available only when the header Type has a Quotation Class of Catalog.

Quotation Price Breaks (Vision Operations) - 100112

Price Break | More

— Effective —

Num	UOM	Quantity	Price	Org	Ship-To	Discount (%)	From	To
1	Each	1	714.83	V1	V1- New York			

Item C1118 C1118

Approve...

2. In the Price Break tabbed region, enter the price break line Number. Purchasing supplies line numbers in increments of one.
3. Enter the Quantity for this price.
4. Enter the shipping UOM for the quotation price break. The supplier may ship the item in different units of measure depending on the quantity you order. Purchasing defaults the unit of measure from the quotation line.
5. Enter the unit Price for the quotation price break.
6. Enter the Organization.
7. Enter the Ship-To location for the quotation price break. Purchasing defaults the ship-to location from the quotation header.
8. Enter the Discount percentage from the unit price for the quotation price break. If you enter a unit price and break price for this shipment, Purchasing does not automatically calculate the discount. You should provide either a break price or a discount, not both. If you enter both values for the quotation, Purchasing prints only the break price on the quotation. If you provide a discount without providing

a break price, Purchasing prints the discount on the quotation.

9. Enter the Effective Date when you want to be able to start using this quotation. If you leave this field blank, Purchasing applies the quotation effective date from the Quotation Header window. You can also enter lead time information instead of date information.
10. Enter the Expiration Date when you no longer need the quotation. If you leave this field blank, Purchasing applies the expiration date from the quotation header.
11. Enter the Lead Time for this price break.
12. Enter the UOM you want to use to define the lead time.
13. Enter the Payment Terms for the quotation. Purchasing prints these terms on the quotation only if they are different from the terms on the quotation header. The default is the payment terms from the quotation header.
14. Enter the Freight Terms for the price break. Purchasing prints these terms on the quotation only if they are different from the freight terms on the quotation header. The default is the freight terms from the quotation header.
15. Enter the FOB point for the price break. Purchasing prints this FOB point on the quotation only if it is different from the FOB point on the quotation header. The default is the FOB name from the quotation header.
16. Enter the freight Carrier for the price break. Purchasing prints this carrier on the quotation only if it is different from the carrier on the quotation header. The default is the carrier from the header.

**To enter additional quotation pricing information:**

1. Select the More tabbed region in the Quotation Price Breaks window.
2. Enter the line number. Purchasing provides line numbers in increments of one.
3. Choose the Match Approval Level. The default is from the Purchasing Options window. See: Defining Default Options, page 1-38.
  - *Two-Way* - Purchase order and invoice quantities must match within tolerance.
  - *Three-Way* - Purchase order, receipt, and invoice quantities must match within tolerance.
  - *Four-Way* - Purchase order, receipt, inspection, and invoice quantities must match within tolerance.
4. Enter the Quantity Received Tolerance. The default is from the Receiving Options

window. See: Defining Receiving Options, page 1-42.

5. Enter the Quantity Received Exception option. See: Defining Receiving Options, page 1-42.
  - *None* - Receipts may exceed the selected tolerance.
  - *Reject* - Receipts cannot exceed the selected tolerance.
  - *Warning* - The receiver gets a warning message, but receipts can exceed the tolerance.

**To approve the quotation:**

- Select the Approve button to open the Approve Entire Quotation window. See: Approving Entire Quotations, page 5-79.

## Related Topics

Entering Quotation Headers, page 5-62

Entering Quotation Lines, page 5-66

## Copying Quotations from RFQs

Use the Copy Documents window to create quotations *directly* from RFQs. Quotations you receive in response to an RFQ usually match the format of your RFQ. To create a quotation from an RFQ, open the original RFQ and choose Copy Document from the Tools menu. You can copy the complete RFQ or part of it to your quotation. You can then edit the quotation to provide detailed quotation line information.

Project and task information, if any, is carried from an RFQ when you copy a quotation from it.

**To copy a quotation from an RFQ:**

1. In the RFQs window, open the RFQ you want to copy.
2. Navigate to the Copy Document window See: Entering RFQ Lines, page 5-53.
3. Enter the copy-from Action: Entire RFQ, RFQ Header Only, or RFQ Header and Lines.
4. Enter a quotation Number if you are using manual quotation number entry. Otherwise, Purchasing assigns a number for you when you save your work. See: Defining Numbering Options, page 1-41.
5. Enter the document Type. This is one of the document names defined for RFQs. The list of values lists the Document Type (Document Name) and Quotation Class from the Document Types window. See: Defining Document Types, page 1-67.



6. Enter the name of the active Supplier. The list of values displays the supplier name, Hold Status, 1099 Number, and VAT Registration Number. See: *Suppliers, Oracle iSupplier Portal Implementation Guide*.
7. Enter the Supplier Site.
8. Enter the name of the Contact for this site
9. Select Copy Attachments if you want to include the RFQ attachments on the quotation.
10. Select the OK button to copy the RFQ. Purchasing displays a confirmation message and opens the new quotation in the Quotations window.

**To clear your entries and return to the RFQs window:**

- Select the Cancel button to clear entries and return to the RFQs window.

## Related Topics

AutoCreate Documents Overview, page 6-1

Copying Purchase Orders, page 4-99

## Approving Quotations

### Finding Quotations for Approval

Use the Find Quotations window to enter search criteria for quotations that you want to approve.

**To enter search criteria:**

1. Navigate to the Find Quotations window by selecting Quote Analysis from the menu. Enter optional search criteria as described in the following steps:

The screenshot shows the 'Find Quotations' dialog box. The 'Operating Unit' is set to 'Vision Operations'. The 'Item' section includes fields for 'Item, Rev', 'Description', 'Category Set', and 'Category'. Below this are fields for 'RFQ', 'Supplier', 'Project', 'RFQ Line', 'Quotation', 'Quotation Approved' (a dropdown menu), and 'Task'. At the bottom right are 'Clear' and 'Find' buttons.

**Important:** Provide the item as part of the search criteria if you know it. If not, you can provide the appropriate purchasing category or description. Use the wildcard (%) to help your search for the item. For example, to search for all items that have Computer as part of the description, enter %Computer% in the Description field. Note that the Description is case sensitive.

2. Select the Operating Unit for this search.
3. Enter the Item number. If you enter an item, you can also further restrict the search by entering an item Revision number.
4. Enter the item Description.
5. Enter the Category Set. This is used to find predefined items associated with a specific category set. If you enter a category set, you can also further restrict the search by entering a Category.
6. Enter the RFQ number. If you enter an RFQ number, you can also enter an RFQ Line number.
7. Enter the Supplier.
8. Enter the Quotation number.
9. Enter the Quotation Approval status: Yes or No

**To clear existing search criteria:**

- Select the Clear button to clear any existing search criteria.

**To initiate the search:**

- Select the Find button to initiate the search and open the Analyze Quotations window.

**Related Topics**

Defining Categories, *Oracle Inventory User's Guide*

Defining Category Sets, *Oracle Inventory User's Guide*

Defining Items, *Oracle Inventory User's Guide*

Suppliers, *Oracle iSupplier Portal Implementation Guide*.

Entering Quotation Headers, page 5-62

Approving Quotation Shipments, page 5-77

**Approving Quotation Shipments**

Use the Analyze Quotations window to review and approve general or specific quotation information for an item or a purchasing category.

You need to approve quotation shipments if you want requestors or buyers to be able to reference the shipments on purchase orders or requisitions. Purchasing lets you approve quotation shipments for specific purposes so that you can control the use of your sourcing information.

**To approve quotation shipments:**

1. Navigate to the Analyze Quotations window by selecting the Find button in the Find Quotations window. Purchasing opens the Analyze Quotations window and displays in the Quotations tabbed region all shipment lines from active quotations.

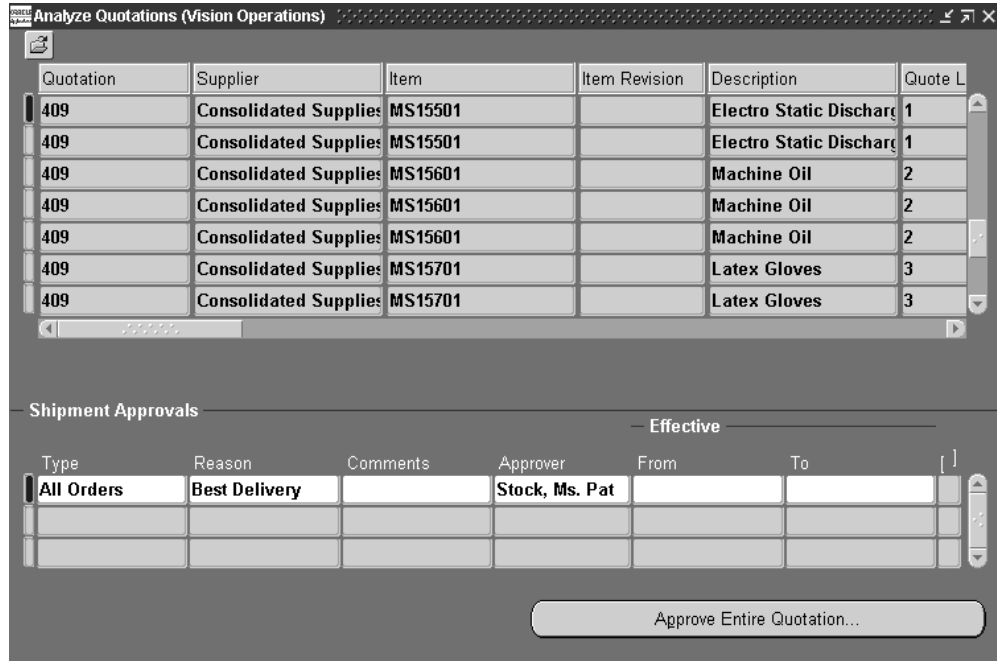

For each shipment line, Purchasing displays the following information: Quotation number, Supplier, Item Number, Item Description, Quotation Line, Unit Price, Freight Terms, Payment Terms, and Discount.

In the Shipment Approvals region, Purchasing displays all existing approvals for the current line. You can delete any of the existing approvals, or you can add approvals for the current line as described in the following steps.

2. Enter the approval Type. Approval types determine the types of documents on which you can use the approved shipment. The available types are: All Orders (all types of purchase orders and requisitions), Purchase Agreements, Requisitions, Standard Purchase Orders.
3. Enter an active approval reason. See: Defining Lookup Codes, page 1-55.
4. Enter comments about your approval.
5. Enter the name of the Approver. Purchasing defaults your name in this field.
6. Enter the Effective date range for your approval. You can use approved quotation shipments on your documents only if the quotation is active and if the current date is within the effectivity dates. If you do not provide an expiration date, you can always use the shipment for your documents while the quotation is active and approved.

**To approve entire quotations:**

- To approve/unapprove all shipments from a single quotation at one time, select the

Approve Entire Quotations button to open the Approve Entire Quotations window.  
See: Approving Entire Quotations, page 5-79.

## Related Topics

Entering Quotation Shipment Information, page 5-70

Entering Quotation Price Break Information, page 5-72

Finding Quotations for Approval page , page 5-75

## Approving Entire Quotations

Use the Approve Entire Quotations window to approve or unapprove all shipments for a single quotation. You simply provide an approval type and reason. Purchasing approves or unapproves all shipments on the quotation.

You need to approve quotation information if you want to let your requestors or buyers reference it on purchase orders or requisitions. You can approve quotation information for specific purposes so that you can control the use of your sourcing information.

Use the Quotations window to approve or unapprove individual quotation shipments.  
See: Approving Quotation Shipments, page 5-77.

### **To approve/unapprove entire quotations:**

1. Navigate to the Approve Entire Quotation window by selecting the Approve Entire Quotation button in the Quotations window. In this case, your approval action applies to all shipment lines on the quotation behind the current quotation shipment when you select the Approve Entire Quotation button. You can also navigate to this window by selecting the Approve button in the Quotations, Quotation Shipments, and Quotation Price Breaks windows.

The screenshot shows a dialog box titled "Approve Entire Quotation". At the top left, there are two radio buttons: "Unapprove" (which is selected) and "Approve". Below the radio buttons is a large rectangular area containing several input fields:
 

- "Type": an empty text box.
- "Reason": an empty text box.
- "Approver": a text box containing the text "Stock, Ms. Pat".
- "Effective": two date input boxes separated by a hyphen.
- "Comments": a large text area with a vertical scroll bar on the right.

 At the bottom of the dialog, there are two buttons: "OK" and "Cancel".

2. Select either Approve or Unapprove as the approval action. You can approve an entire quotation as often as you want. Each time you approve an entire quotation, Purchasing creates a new approval for each quotation shipment.  
 If you select Approve, you must enter an approval type and reason before you can save your changes. You can approve a specific quotation several times for different approval types and reasons. If you enter Unapprove, you will be unapproving all shipment lines for the current quotation.
3. Enter the approval Type for your quotation. Approval types determine the types of documents on which you can use the quotation. The available types are: All Orders (all types of purchase orders and requisitions), Purchase Agreements, Requisitions, Standard Purchase Orders.
4. Enter an active approval reason. You can enter this field only when you choose Approve as the action. See: Defining Lookup Codes, page 1-55.
5. Enter the name of the approver. Purchasing defaults your name in this field. You can enter this field only when you choose Approve as the action.
6. Enter the Effective date range for your approval. You can use approved quotation information on your documents only if the quotation is active and if the current date is within the effectivity dates. If you do not provide an expiration date, you can always use the quotation for your documents while the quotation is active and approved.

7. Enter comments about your approval. You can enter this field only when you choose Approve as the action.

8. Select OK to approve/unapprove the quotation.

**To cancel your entries:**

- Select the Cancel button to cancel your action and return to the window from which you accessed the Approve Entire Quotation window.

## **Related Topics**

Entering Quotation Shipment Information, page 5-70

Entering Quotation Price Break Information, page 5-72

Approving Quotation Shipments, page 5-77

## **Defining Supplier Lists**

Use the Supplier Lists window to enter and edit supplier lists. You can copy suppliers from the supplier lists onto the RFQ supplier list when you create an RFQ.

**To define supplier lists:**

1. Navigate to the Supplier Lists window from the menu.

Supplier Lists

List Name

Description

Inactive Date  [ ]

Suppliers

Name	Site	Operating Unit	Contact	[ ]

2. Enter the Supplier List Name of the list you want to create. Each supplier list name *must* be unique.
3. Enter a Description for your supplier list.
4. Enter the Inactive Date for the list
5. Enter the Supplier name you want to place on the supplier list. The list of values displays the supplier name, number, On Hold, Taxpayer ID, and VAT number. When you copy a supplier list onto your RFQ supplier list, Purchasing copies every unique combination of supplier and supplier site that does not already appear on the current RFQ supplier list.
6. Enter the supplier Site you want to place on the supplier list. Purchasing lets you send a request for quotation to different sites of a same supplier. You cannot enter the same combination of supplier and supplier site twice on the same supplier list.
7. Enter the name of the Contact at this supplier site.

## Related Topics

Entering RFQ Headers, page 5-49



# Managing Buyer Workload

## Finding Requisition Lines for Review or Assignment

Purchasing lets you suggest a buyer for each supplier-sourced requisition line you create. (See: *Entering Requisition Lines*, page 3-51.) When you assign requisitions or requisition lines to buyers, the buyers can choose the requisition lines assigned to them and place these lines on purchase orders.

Use the Find Requisition Lines window to choose whether to review requisition assignments or to assign/reassign requisition lines and to enter selection criteria for the lines. Choosing the Review action takes you to the Review Buyer Workload window, where you can review requisition assignments. You can identify requisition lines that reference the wrong buyer or that were not assigned to a buyer. You can also use this window to analyze buyers' workloads. (See: *Reviewing Buyer Workload*, page 5-85.) Choosing the Assign action takes you to the Assign Requisition Lines window, where you can assign or reassign requisition lines to buyers. See: *Assigning Requisition Lines*, page 5-86.

**To enter search criteria:**

1. Navigate to the Find Requisition Lines window by selecting Manage Buyer Workload from the menu.

Find Requisition Lines

Operating Unit: Vision Operations

Action: Assign

Requisition:

Requester:

Supplier Sourcing:

Supplier:

Buyer:

Supplier Site:

Ship-To:

Rate Type:

Currency:

Status | Line

Need-by:  -

Late:

Urgent:

Assigned: No

RFQ Required:

Approval Status: Approved

Clear Find

2. Select the Operating Unit for this search.
3. Select Assign or Review mode. Then enter desired search criteria as described in the following steps.
4. Enter the Requisition number.
5. Enter the Requestor.
6. Enter the Supplier Sourcing criterion (Sourced or Unsourced). If you leave this field blank, Purchasing displays both sourced and unsourced requisition lines. Requisitions have a suggested supplier either if the preparer entered a supplier when creating the requisition, or if Purchasing sourced the requisition. See: Automatic Sourcing, page 5-24.
7. Enter the Buyer name.
8. For sourced lines, enter the Supplier and Supplier Site
9. Enter the Ship To location to locate requisition lines for a specific location. When you set up Deliver-To Locations, you specify a Ship-To Location for each Deliver-To Location. If you enter a Ship-To Location, Purchasing displays all requisition lines for Deliver-To Locations that reference the Ship-To Location.
10. Enter the Rate Type.

11. Enter the Currency.
12. Use the tabbed regions to further restrict the search:
13. In the Status region, you can limit the search by Late status (Yes or No), Urgent status (Yes or No), Assigned status (Yes or No), RFQ Required status (Yes or No), Approval status (Approved, Incomplete, In Process, Pre-Approved, Rejected, Requires Reapproval, or Returned), or Need By date.
14. In the Line region, you can enter the following search criteria: Item number, Job (Oracle Services Procurement), Revision number, Category, item Description, and Line Type.
15. Select the Find button to initiate the search and open the Review Buyer Workload or the Assign Requisition Lines window, as chosen above.

**To clear existing search criteria:**

- Select the Clear button to clear any existing search criteria.

## Related Topics

Reviewing Buyer Workload, page 5-85

Assigning Requisition Lines, page 5-86

## Reviewing Buyer Workload

Use the Reviewing Buyer Workload window to review requisition assignments. You can identify requisition lines that reference the wrong buyer or that were not assigned to a buyer. You can also use this window to analyze buyers' workloads. Use the Assign Requisition Lines window to assign or reassign requisition lines to buyers.

**To review buyer workload:**

1. Navigate to the Review Buyer Workload window by selecting the Review action and then selecting the Find button in the Find Requisitions Line window.

Buyer	Assigned	Urgent	Late	Needed	Open POs
Abbott, Ms. Rachel	4	0	2		5
Adams, Mr. Brian	0	0	0		2
Anderson, Victoria	0	0	0		2
Anderson, Bob	0	0	0		3
Andretti, Mr. Evan	1	0	1		5
Armstrong, Mr. Billie	2	0	2		1
Badger, Mr. David	0	0	0		0
Baker, Ms. Catherine	0	0	0		30
Black, Mr. Chris	7	0	7		15
Brock, Mr. Kim	0	0	0		17

Unassigned

For each buyer, Purchasing displays information for the requisition lines that meet the search criteria entered in the Find Requisition Lines window.

- *Assigned* - The number of requisitions lines currently assigned to the buyer.
- *Urgent* - The number of urgent requisition lines.
- *Late* - The number of requisition lines for which the current date is later than the Need By date less the lead time.
- *Needed* - The number of requisition lines for which the Need By date is within the Need By search criteria entered in the Find Requisition Lines window.
- *Open POs* - The number of open purchase orders referencing the buyer.

At the bottom of the screen, Purchasing displays the total number of unassigned requisition lines, and the number of these that are Urgent, Late, and Needed (as defined above).

2. Close the window to return to the Find Requisition Lines window.

## Related Topics

Finding Requisition Lines for Review or Assignment, page 5-83

Assigning Requisition Lines, page 5-86

## Assigning Requisition Lines

Use the Assign Requisition Lines folder window to assign or reassign requisition lines to buyers.

**To assign requisition lines:**

1. Navigate to the Assign Requisition Lines window by selecting the Assign action and then selecting the Find button in the Find Requisitions Line window.

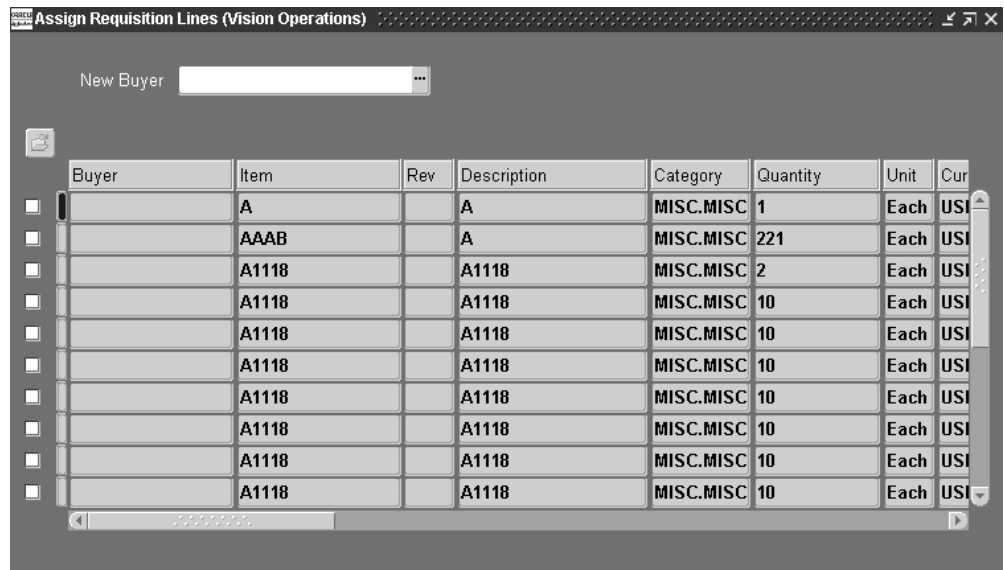

For each requisition line meeting the search criteria, Purchasing displays the Buyer, Item number, Revision number, item Description, Category, Quantity, Unit of Measure, Currency, Unit Price, Need By Date, Requisition number, requisition Line number, Line Type, Note to Buyer, Source Type, Supplier, Supplier Site, Requestor, Destination Type, Ship To location, Rate Type, Urgent status, RFQ Required status, and Encumbered status.

2. Enter the New Buyer to whom you want to assign or reassign the requisition line.
3. Select the requisition lines that you want to assign to the new buyer.

**Related Topics**

Finding Requisition Lines for Review or Assignment, page 5-83

Reviewing Buyer Workload, page 5-85



---

## AutoCreate

### AutoCreate Documents Overview

Purchasing provides automatic creation capabilities for documents. Buyers can quickly create standard purchase orders, planned purchase orders, blanket releases, RFQs, and Oracle Sourcing negotiations from any available standard (not internal) purchase requisition lines. The purchase requisition lines can be for predefined items or one-time items as well as outside processing items. AutoCreating documents can be as simple as selecting requisition lines and adding a supplier-and letting Purchasing do the rest. Use the AutoCreate Documents window to access the features of AutoCreate.

**Note:** For information on creating quotations directly from RFQs, see: Copying Quotations from RFQs, page 5-74.

AutoCreate provides you with the features you need to satisfy your automatic document creation needs. You should be able to:

- With a minimum number of keystrokes you can create new standard or planned purchase orders, blanket releases, RFQs, quotations, and if Oracle Sourcing is enabled, draft buyer's auctions or sourcing RFQs.
- Add to existing blanket releases, planned purchase orders, standard purchase orders, RFQs, and quotations
- Review all approved requisition lines before placing specific requisition lines on a purchase order or RFQ
- Review RFQ headers, lines, and shipments before creating a quotation from a specific RFQ
- Collect all requisition lines that meet a certain set of criteria that you establish
- Split one requisition line into several requisition lines

- Consolidate multiple like requisition lines into single purchase order lines
- Review or change your purchase orders, quotations, or RFQs immediately after creation
- Use document security to control whether buyers can add to certain document types
- Specify foreign currency details during autcreation.
- Review requisition lines by currency type

## Major Features

### Complete Search Criteria

You have flexible criteria by which you can search for unpurchased approved purchase requisition lines for inclusion on purchase orders and RFQs as well as unapproved requisition lines for inclusion on RFQs. When you are creating quotations from RFQs, you specify the RFQ number and lines from which you want to create the quotation. See: Copying Quotations from RFQs, page 5-74.

### Fast Purchase Order and RFQ Creation

All purchase requisition lines available for autcreation go into a single requisition pool. Buyers can retrieve any of the requisition lines from the pool and use the AutoCreate Documents window to create standard and planned purchase orders, blanket releases and RFQs. You can place a requisition line on as many RFQs as you want before you place it on a purchase order, after which it is no longer available in the requisition pool.

### Fast Quotation Creation

Buyers can use the Copy Documents window to create supplier quotations for each RFQ. Buyers can choose entire RFQs or specific RFQ lines and shipments. See: Copying Quotations from RFQs, page 5-74.

### Fast Oracle Sourcing Negotiations

If Oracle Sourcing is enabled, approved requisition lines in the requisition pool can be used to create buyer's auctions or sourcing RFQs . Buyers can use the AutoCreate Documents window to construct these negotiations and then view them in Oracle Sourcing.

### Automatic Creation Mode

Automatic Creation Mode lets you create purchasing documents with a minimum



number of keystrokes. You provide search criteria to locate the requisition lines you want to place on a purchase order or RFQ. After reviewing the requisition lines, you select all lines that you want. Then you select the Automatic button to create the purchase order or RFQ. You have the option to group requisition lines in a default manner based on the document type or you can autcreate documents that parallel the structure of the requisition from which they were created.

### **Manual Creation Mode**

Manual Creation Mode lets you specify which requisition lines you want to place on a document. You decide which requisition lines you want to combine and where you want them to appear on the document. Then you select the Manual button to create the document.

### **Foreign Currency Options**

When you autcreate new purchase orders, the requisition price is converted into a purchase order price based on specified currency and rate information. You cannot specify currency information in AutoCreate if you are adding requisition lines to an existing document. Purchasing performs price tolerance verification for all currencies.

When you autcreate Oracle Sourcing negotiations, they are always created in functional currency.

### **Related Topics**

Finding Requisition Lines for AutoCreate, page 6-9

Selecting AutoCreate Criteria, page 6-12

Entering Document Information and Completing AutoCreate, page 6-15

Using the Document Builder, page 6-17

Modifying Requisition Lines, page 6-19

Copying Quotations from RFQs, page 5-74

### **AutoCreate Document Options**

The AutoCreate Documents window has features that simplify purchase order and blanket release creation into a few steps:

- Enter selection criteria for your requisition lines in the Find Requisition Lines window. See: Finding Requisition Lines for AutoCreate, page 6-9.
- Choose whether to create a new document or add to an existing document. See: Selecting AutoCreate Criteria, page 6-12.
- In the AutoCreate Documents window, select the Document Type: Standard

Purchase Order, Planned Purchase Order, Blanket Release, RFQ, Buyer's Auction, or Sourcing RFQ. See: Selecting AutoCreate Criteria, page 6-12.

- Choose the Grouping method: *Default* - requisition lines are combined into individual lines based on Document Type. *Requisition* - the autocreated documents parallel the structure of the requisition from which they were created. See: Selecting AutoCreate Criteria, page 6-12.
- Choose Automatic or Manual creation mode to place the requisition lines onto a document. Based on the results of your search and on how you want the autocreated document to look, you can decide whether Automatic or Manual creation mode is more appropriate. Only Automatic mode can be used for creating Oracle Sourcing documents. See: Selecting AutoCreate Criteria, page 6-12.

### Selecting Requisition Lines

In the Find Requisition Lines window, enter search criteria to narrow the selection of requisition lines. Purchasing chooses all requisition lines from the requisition pool that meet your search criteria and displays them in the AutoCreate Documents window. Requisition lines for the same item and item category are grouped together, but they are not necessarily in order alphabetically. Within each grouping of item and item category, requisition lines are ordered by need-by date.

### Creating a Purchase Order, Release, or RFQ

In the AutoCreate Documents window, you can create a new planned purchase order, standard purchase order, blanket release, RFQ, or Oracle Sourcing buyer's auction or sourcing RFQ. Also, depending on your security criteria, you can add lines to an existing document. For example, if standard purchase orders have an access level of View Only, you cannot add lines to an existing standard purchase order unless you are the document owner. See: Defining Document Types, page 1-67. See: Selecting AutoCreate Criteria, page 6-12

- To create a new document, select Create New in the Action field.
- To add to an existing document, choose Add To and select the document number in the Document Number field.

### Using Automatic Creation Mode

Use the Automatic creation mode when any of the following conditions occur:

- A majority of the requisition lines that your search criteria located are items you want to place on the document
- You want Purchasing to determine where to place the requisition lines on the document

- You want Purchasing to combine similar requisition lines automatically onto a single document line
- You are creating or adding to a release
- You are using Requisition grouping

Automatic Creation Mode lets you create documents with a minimum number of keystrokes. If you want to place on a document all the requisition lines that you selected from those which met your search criteria, select the Automatic button. Purchasing creates in a new document or adds to an existing document all the requisition lines you selected, and these lines are removed from the requisition pool if you are placing them on a purchase order or Sourcing negotiation. Lines that you did not select and lines placed on an RFQ remain in the requisition pool.

**Note:** Purchasing also copies the notes from the requisition lines and the corresponding requisition headers, but *not* descriptive flexfields, to the document lines you create.

When creating a purchase order, Purchasing combines the quantities of all requisition lines that have the same item, item revision, line type, transaction reason, unit of measure, and supplier item number onto a single document line. For RFQs, quantities of all requisition lines that have the same item, revision, and line type are combined. The lowest unit price from the combined requisition lines becomes the actual price of the purchase order line. If the items on the requisition lines you combine have different prices, you may want to use Manual creation mode to ensure you get the price you want. See the discussion of Manual creation mode below.

For purchase orders and releases, Purchasing combines shipment information only if the requisition lines have the same need-by date, ship-to location, organization, Accrual type (period-end or on-line), and shipment type. Each purchase order distribution corresponds to only one requisition distribution. Purchasing does not add to an existing purchase order shipment if that shipment has been encumbered. For RFQs, Purchasing combines shipment information only if the requisition lines have the same ship-to location, need-by date, and unit of measure.

**Note:** You can autcreate releases against blanket purchase agreements only if the requisition lines match the lines on the agreement.

If Oracle Sourcing is enabled and you are creating a negotiation, Purchasing combines the quantities of all requisition lines based on line type, item number, item revision, item description, unit of measure, and ship-to location onto a single line.

For new documents, Purchasing places the items on document lines in the same order that they are displayed, and the shipments will be ordered by need-by date if all requisition lines share a common unit price. Additions to existing documents or document lines will be placed after any existing lines or shipments.

If the profile option PO: Display the Autocreated Document is set to Yes, Purchasing displays the Purchase Orders, Releases, RFQ window, or Sourcing Create Negotiations Documents page, as appropriate, after creating your document lines. See: Profile Options in Purchasing, page C-1. The AutoCreated document must be in your current operating unit to be displayed.

## Using Manual Creation Mode

Use Manual creation mode when any of the following conditions occur:

- You want to manually choose the requisition lines to combine onto a single document line
- You want to specify the location of the items on the document (for example, specify which purchase order lines the requisition lines will become)
- You want to ensure you get the negotiated price when combining multiple requisition lines with different prices

Manual creation mode lets you take control of the actual placement of requisition lines on purchase order lines. You move each line into the position you want it on the document by using the Document Builder. See: Using the Document Builder, page 6-17

You can combine requisition lines that have the same predefined item and lines that have one-time items onto a single document line. If you want to combine two requisition lines for the same item, one with an item number and one without, use Modify on the Tools menu to add the predefined item to the requisition line for the one-time item.

Purchasing copies only the notes from the remaining selected requisition lines (and their corresponding headers).

## Adding Lines to Existing Documents

You can add lines to existing documents only if your security criteria allow you to modify them. However, you can always create new releases against blanket purchase agreements - even if your security criteria do not permit you to access the document elsewhere in the system. To add lines to an existing planned or standard purchase order, specify the purchase order number:

If you use Automatic creation mode, Purchasing creates new lines beginning with the next available line number or combines your requisition lines with existing document lines.

If you use Manual creation mode, you can select any displayed line and place it onto a line in the Document Builder region

## Entering Document Information

Once you have completed specification of all criteria (and used the Document Builder for Manual creation mode), you add document information to complete the autcreate process. See: Entering Document Information and Completing AutoCreate, page 6-15.

## Additional AutoCreate Features

### Modifying Requisition Lines

Use the Modify feature when you want to split an existing requisition line into multiple requisition lines that represent the same or different items. For example, if the requisition line quantity is so large that a single supplier cannot fill the entire order by the need-by date, then you need to multi-source the order (that is, fill it from more than one supplier). On the other hand, if you have a requisition line item that contains parts that you want to order as unique items, you can explode the requisition line into several lines.

**Note:** Modifying encumbered requisition lines is restricted to quantity only.

On outside processing lines the only field you can modify is quantity. The sum of the new lines must equal the original line quantity.

- In the AutoCreate Documents window, select Modify on the Tools menu to display the Modify Lines window with the current requisition line selected. See: Modifying Requisition Lines, page 6-19.
- Enter as many new lines as you need to represent the original requisition line. Purchasing automatically creates new distribution lines and prorates quantities for the new distributions from the original requisition line distributions. Purchasing also backs out requisition supply for the original requisition line and creates new supply for the new lines.

When you return to the AutoCreate Documents window, Purchasing displays the new requisition lines that are now available for placement on a purchase order or RFQ. These lines do not appear, however, if the new requisition lines do not meet your original search criteria. The original requisition line is no longer available for purchase order or RFQ placement, but your requestor can easily review the modification status of a requisition line in the Requisitions window.

### Returning a Requisition

Purchasing lets you return a requisition line to the requisition preparer. You might want to return a requisition line if you are unable to obtain the requestor's price and want the requestor to resubmit the requisition for approval at a higher price.

Select Return Requisitions on the Tools menu to display the Return Requisitions window. Enter a reason for the return and select OK to return all requisition lines on the current requisition except any lines from the requisition already placed on a purchase order. When you return requisition lines, they are no longer available in the requisition pool.

Returning an encumbered requisition line reverses the funds reservation for that line with a date based on the setting of the PO: Document GL Date profile.

## Oracle iProcurement Requisitions

If you have Oracle iProcurement installed, note that, in addition to standard purchase requisitions, iProcurement requisitions include emergency requisitions and requisitions that use a procurement card for the purchase. You can use the PO Create Documents workflow or AutoCreate to create documents from iProcurement requisitions.

### Emergency Requisition Lines

An emergency requisition is created in Oracle iProcurement only, by requesters who can order from a supplier directly. Emergency requisitions have a purchase order number reserved for them in advance.

After the emergency requisition is entered in iProcurement, the PO Create Documents workflow creates a standard purchase order from the approved requisition lines automatically, if you use the workflow. If you don't, you can use AutoCreate.

You can view emergency requisition lines in the AutoCreate Documents folder window by displaying the hidden field Emergency PO Number. Or enter an Emergency PO Number in the Find Requisition Lines window.

Except for the following points, emergency requisition lines are autocreated like any other requisition line:

- Emergency requisition lines on a single purchase order must have the same Emergency PO Number.
- You can put emergency and non-emergency requisition lines on the same purchase order, but Purchasing will give you a warning message when you do.
- You can create only standard purchase orders from emergency requisition lines.

Emergency requisitions, and the purchase orders created from them, go through the same approval process as other documents (unless you modify the approval workflow to handle them differently).

### Procurement Card Requisition Lines

Requisition lines that use a corporate (or procurement) credit card for the purchase are created in iProcurement only.

After a procurement card requisition is entered in iProcurement, the PO Create Documents workflow creates a standard purchase order or release from the approved requisition lines automatically, if you use the workflow. If you don't, you can use AutoCreate.

In the AutoCreate Documents folder window, you can view requisition lines that use a corporate credit card by displaying the P-Card hidden field.

Note the following AutoCreate criteria for procurement card purchase orders and releases:

- You cannot combine requisition lines that use procurement card information with other requisition lines on the same document.
- Procurement card lines on a single document must have the same P-Card number, supplier, and supplier site.

See: Procurement Card Purchase Orders and Releases, page 4-118.

## Related Topics

Choosing Workflow Options, page 1-85

Selecting AutoCreate Criteria, page 6-12

*Oracle iProcurement Implementation Manual*

## Finding Requisition Lines for AutoCreate

Use the Find Requisition Lines window to specify search criteria for requisition lines that you will use to autcreate purchase orders and RFQs.

- Create online requisitions in the Requisitions window or in Oracle iProcurement. See: Entering Requisition Headers, page 3-48. Approve the requisitions. See: The Document Approval Process, page 2-32.
- Use Requisition Import to import requisitions generated by other products. See: Requisition Import Process, page 13-29.

### To enter search criteria:

1. Navigate to the Find Requisition Lines window by selecting AutoCreate from the menu. Then enter desired search criteria as described in the following steps.

The screenshot shows the 'Find Requisition Lines' window with the following fields and values:

- Operating Unit: Vision Operations
- Approved: Yes
- Requisition: (empty)
- Emergency PO Number: (empty)
- Supplier Sourcing: (dropdown)
- Supplier: (empty)
- Document Type: (empty)
- Global:
- VMI Only:
- Show External Locations:
- Ship-To: V1- New York City
- Buyer: Brown, Ms. Casey
- Requester: (empty)
- Preparer: (empty)
- Supplier List: (empty)
- Supplier Site: (empty)
- Document: (empty)
- Negotiation Number: (empty)
- Minimum Amount: (empty)
- Currency: (empty)
- Rate Type: (empty)

The table area contains the following fields:

- Item, Rev: (empty)
- Job: (empty)
- Category: (empty)
- Description: (empty)
- Line Type: (empty)

Buttons: Clear, Find

2. Select the Operating Unit for this search.
3. Select the Approved status: Yes or No. Only approved lines can be used when you autocreate purchase orders. Either status can be used on RFQs. If you do not make a selection, both approved and unapproved requisition lines will be included.  
*Yes* - You can autocreate purchase orders, releases, and RFQs.  
*No* - You can autocreate only RFQs.
4. The suggested Buyer from the Enter Person window is displayed as the default. If the PO: Allow Buyer Override in AutoCreate Find profile option is set to Yes, you can clear the default or enter a different buyer.
5. Enter the Requisition number.
6. Enter the Requestor.
7. Enter the Emergency PO Number.  
If you are autocreating a purchase order from an emergency requisition, enter the purchase order number that was reserved in advance for the requisition. An emergency requisition is created in iProcurement only.



8. Enter the Preparer.
9. Select the Supplier Sourcing criterion (Sourced or Unsourced).
10. Enter the Supplier List.
11. Enter the Supplier and Supplier Site.
12. Select the Document Type to indicate that you want to include requisition lines sourced to a Blanket purchase agreement or to a Quotation.
13. Enter the Document number.
14. Check the Global checkbox if you want to include only those requisition lines sourced to a global agreement.
15. If Oracle Sourcing is enabled, enter the Negotiation Number.
16. Check the VMI checkbox if you want to include only VMI requisition lines.  
**Note:** VMI requisition lines cannot be used for Oracle Sourcing negotiations.
17. Enter the Minimum Amount on the requisition line to include.
18. Check the External Locations checkbox if you want to include requisition lines from external locations.
19. Enter the Currency.
20. Enter the Ship-To location to include requisition lines with this Deliver To location. The default is the Ship-To Location for the buyer from the Enter Person window.
21. Enter the currency Rate Type.
22. Use the tabbed regions to further restrict the search:
  - In the Line region, you can enter the following search criteria: Item number, Revision number, Job (Oracle Services Procurement), Category, item Description, and Supplier Item number. The default Category is the category defined for the buyer from the Enter Person window. If the PO: Allow Category Override in AutoCreate Find profile option is set to Yes, you can clear the default or enter a different category.
  - In the Status region, you can limit the search by Late status (Yes or No), Urgent status (Yes or No), Assigned status (Yes or No), RFQ Required status (Yes or No), or the number of need by days from today (For example, enter 10 if you want to locate all requisition lines with a need-by date within the next ten calendar days.)

23. Select the Find button to initiate the search and open the AutoCreate Documents window. See: Selecting AutoCreate Criteria, page 6-12.

**To clear existing search criteria:**

- Select the Clear button to clear any existing search criteria.

**To enter requisition preferences:**

- Select Requisition Preferences on the Tools menu to open the Requisition Preferences window. See: Entering Requisition Preferences, page 3-44.

## Related Topics

Defining Buyers, page 1-20

Profile Options in Purchasing, page C-1

Enter Person, *Oracle HRMS Enterprise and Workforce Management Guide*

## Selecting AutoCreate Criteria

The AutoCreate Documents folder window displays the requisition lines that met the search criteria entered in the Find Requisition Lines window. Use this window to:

- Select whether you are creating a new document or adding to an existing document
- Select the type of document you are creating: Standard PO, Planned PO, Blanket Release, or RFQ
- Select the grouping method: Default or Requisition
- For Automatic creation mode, select which of the displayed requisition lines you will use on the autocreated document
- Select the creation mode: Manual or Automatic

**About Flexfields:** AutoCreate does not copy descriptive Flexfields from the requisition.

If your company uses iProcurement, see: iProcurement Requisitions, page 6-8 for information about autocreating iProcurement requisitions, including emergency and procurement card (P-Card) requisitions.

**To select AutoCreate criteria:**

1. Navigate to the AutoCreate Documents window by selecting the Find button in the Find Requisition Lines window. See: Finding Requisition Lines for AutoCreate, page 6-9.

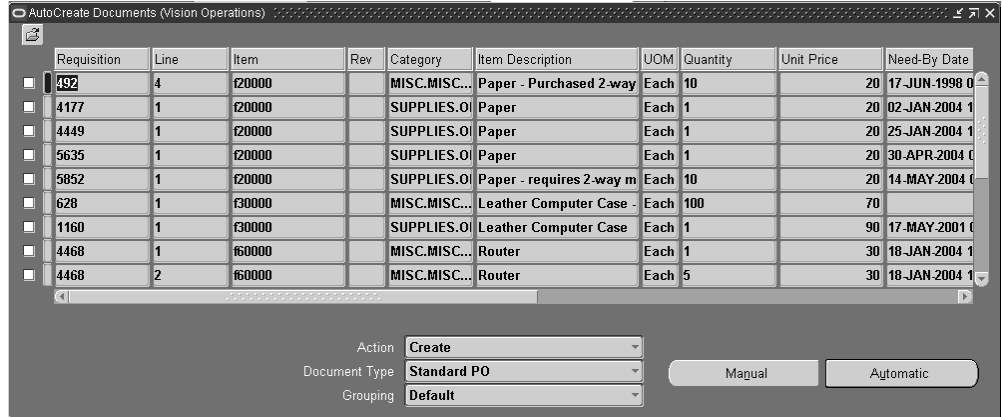

- In the Action field, select whether you want to Create a New document or Add To an existing document.

**Note:** Only Create is supported for Oracle Sourcing documents.

- Select the Document Type you want to create: Standard PO, Planned PO, Blanket Release, or RFQ. The Document Type can be only RFQ if you did not select Approved Requisitions in the Find Requisition Lines window.

You can choose only Standard PO for emergency requisition lines.  
See: Procurement Requisitions, page 6-8.

If Oracle Sourcing is enabled you may also select Buyer's Auction or Sourcing RFQ. See the "What are the differences between negotiation types?" topic in online help for details.

- Select the Grouping for requisition lines on the document:
  - Default:* Combine requisition lines for the same item, revision, line type, unit of measure, supplier item number, and transaction reason onto one purchase order line. Combine requisition lines for the same item, revision, supplier item number, and line type onto one RFQ line.

You can add need-by date or ship-to organization and location to the default grouping by using the profiles PO: Use Need-by Date for Default Autocreate grouping or PO: Use Ship-to Organization and Location for Default Autocreate grouping.

- Requisition:* Create document with one line for each requisition line. Used only when you select lines on a single requisition.

**Note:** If Oracle Sourcing is implemented; requisition lines with the

same item, revision, description, line type, UOM, and ship-to (based on deliver-to) will be grouped into individual negotiation document lines.

**Note:** If Oracle Services Procurement is implemented, only *Requisition* is supported for fixed price with temp labor requisition line types.

5. For Automatic creation mode, use the check boxes to select the requisition lines that you want to use on the document and then select the Automatic button. You can also use 'Select All' or 'Deselect All' in the Edit menu.

For Manual creation mode, select the Manual button. Manual creation mode is available only when you have chosen Default grouping for Standard and Planned Purchase Orders, Blanket Releases, and RFQs. See: Using the Document Builder, page 6-17.

For both creation modes, Purchasing displays the Add To Document, New Document Number, or New Document window, depending on the action you selected. See: Entering Document Information and Completing AutoCreate, page 6-15.

**Note:** Only automatic mode is supported when creating Oracle Sourcing documents.

**To return requisition lines:**

1. Select Return Requisitions on the Tools menu to display the Return Requisitions window.
2. Enter a Reason for the return.
3. Select OK to return to the requisition pool all unpurchased lines on the current requisition.

**To modify requisition lines:**

- Select Modify on the Tools menu to open the Modify Lines window. See: Modifying Requisition Lines, page 6-19

**To view action history:**

- Select View Action History on the Tools menu to open the Action History window and display action history for the current line. See: Viewing Action History, page 10-1.

**To view blanket purchase agreements:**

- Select View Blanket POs on the Tools menu to open the Purchase Order Lines

window and display all blanket purchase agreements for the item on the current line.

**To enter requisition preferences:**

- Select Requisition Preferences on the Tools menu to open the Requisition Preferences window. See: *Entering Requisition Preferences*, page 3-44.

## Related Topics

*Customizing the Presentation of Data in a Folder, Oracle Applications User's Guide*

## Entering Document Information and Completing AutoCreate

Use the Add To Document, New Document Number, New Document, and Negotiation Outcome modal windows to enter document information for documents you are AutoCreating. Which window displays is determined by your Action choice in the AutoCreate Documents window.

**Important:** If the PO: Warn RFQ Required before AutoCreate profile option is set to Yes, and one or more of the requisition lines selected for autocreation requires an RFQ and has not been placed on an RFQ, you will be given a warning message and can cancel the autocreate. See: *Profile Options in Purchasing*, page C-1

**To enter information in the Add To Document window:**

1. The Add To Document modal window appears when you have chosen the Add To action and selected either the Manual or the Automatic creation mode button in the AutoCreate Documents window.
2. Select the Document Number. For blanket releases, you must also enter the Release Number.

You can select Cancel to close the modal window.

3. Select OK to go to the next step.

If you are in Automatic creation mode, this completes all required steps. Purchasing autocreates the document and displays the document entry window appropriate for the selected criteria if the PO: Display the AutoCreated Document profile option is set to Yes. See: *Profile Options in Purchasing*, page C-1.

If you are in Manual creation mode, you go to the Document Builder. See: *Using the Document Builder*, page 6-17.

**To enter information in the New Document Number window:**

- The New Document Number window appears when you have chosen the Create New action and selected the Manual creation mode button in the AutoCreate

Documents window. This short version of the New Document window requires only that you enter the Document Number. Later, after you have entered information in the Document Builder, the New Document window will appear. See: Using the Document Builder, page 6-17.

**To enter information in the New Document window:**

1. The New Document window appears after you have selected the Create button in the Document Builder when you are creating a new document in Manual creation mode and in all cases when you are creating a new document in Automatic creation mode.

2. The Global Agreement field will be defaulted if all requisition lines are sourced from the same global agreement and a standard purchase order is being created. Autocreate will fail if all requisition lines are not from the global agreement. This field is greyed out if you are creating a blanket release or RFQ. You can select a different global agreement from the Global Agreement list of values providing all requisition lines can be sourced to that agreement.
3. Enter the Document Number. If automatic document numbering is enabled for the document type, this field is not enterable. See: Defining Numbering Options, page 1-41. For RFQs, you must enter the RFQ Type, and you can enter the Supplier List Name. For releases, you must enter the Release and the Release Date
4. For standard and planned purchase orders, you can enter the Supplier and Supplier Site. This is filled in for releases.

5. Enter the Currency Source:
  - *Default* - The currency is defaulted from the supplier site (if foreign currency), the supplier (if foreign currency), or the functional currency.
  - *First Requisition Line* - The currency from the first requisition line is used.
  - *Specify* - If you select a Requisition and Requisition Line, the currency from that line is autoselected; however, you can override this currency.

The Rate and Rate Date are enterable only when the Rate Type is User. A rate type of EMU Fixed means that if either your base currency (functional currency, defined in your ledger) or your foreign currency (transaction currency in a document entry window) is Euro and the other is another European currency, Purchasing automatically enters a conversion Rate Date and Rate for you that you cannot change.

6. Select Create to complete autocreation of the document. If the PO: Display the AutoCreated Document profile option is set to Yes, Purchasing displays the document entry window appropriate for the selected criteria. See: Profile Options in Purchasing, page C-1.

**To enter information in the Negotiation Outcome window:**

1. If you chose Buyer's Auction or Sourcing RFQ, the Negotiation Outcome window opens.
2. The Document field reflects your choice of Buyer's Auction or Sourcing RFQ from the main Autocreate window.
3. Select Standard Purchase Order or Blanket Purchase Agreement from the Negotiation Outcome list of values. This will determine the type of document that will be created when the Sourcing negotiation is complete.
4. Click the Create button and the Sourcing Create Negotiation Documents page is displayed. See the Oracle Sourcing online help for details.

## Using the Document Builder

Use the Document Builder region in the AutoCreate Documents window to build documents for automatic creation in Manual creation mode.

**To build documents when creating a new document:**

1. Navigate to the Document Builder by selecting the Manual button in the AutoCreate Documents window and entering a document number in the New Document Number window. See: Entering Document Information and Completing AutoCreate, page 6-15.

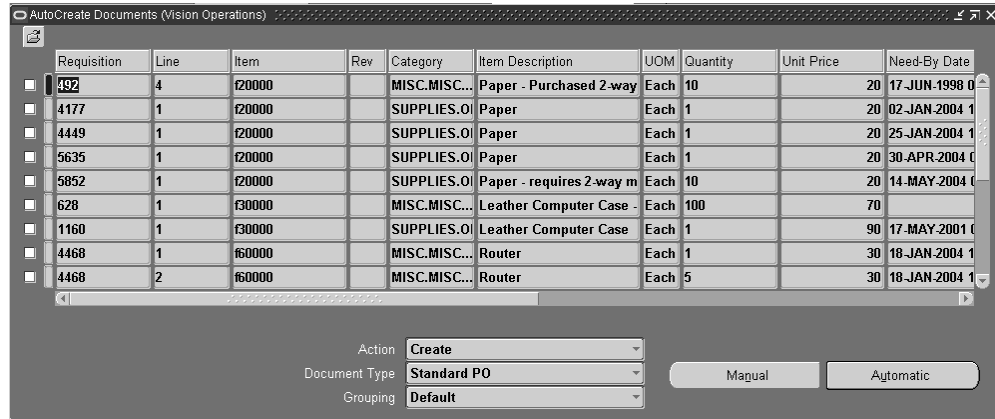

2. In the upper region, select one requisition line for build placement. This enables the Add to Document button.

3. Choose the Add to Document button.

This places the selected requisition line from the upper region into the Document Builder, highlights the upper region and positions the cursor in the next available Line field.

You can position the cursor anywhere in a *populated* line in the Document Builder to enable the Remove button. Choose the Remove button to return the line to the upper region and deselect the line.

4. You can select additional lines one at a time in the upper region and move them to the Document Builder.

To create a new purchase order line, select a requisition line in the upper region and choose the Add to Document button. Purchasing creates a new, corresponding purchase order line.

To add to an existing purchase order line, select a requisition line in the upper region, click in the Line field of an existing line below, and choose the Add to Document button. Purchasing places the requisition line on the next available open line below, but gives it the same Line number as the line you added it to. If the lines cannot be validly combined, Purchasing gives it a different Line number. (See: AutoCreate Document Options, page 6-3.)

You can change a Line number in the Document Builder region to any unused Line number.

**To build documents when adding to an existing document:**

1. If you are adding to an existing document, Purchasing displays all the existing document lines in the Document Builder, with the line disabled. You cannot remove any of these existing lines.

2. Follow steps 2 - 4 above.



3. Select Create to complete autocreation. If the PO: Display the AutoCreated Document profile option is set to Yes, Purchasing displays the document entry window appropriate for the selected criteria. See: Profile Options in Purchasing, page C-1.

**To cancel the current session in the Document Builder:**

- Select the Cancel Build button to remove any lines you have added to the Document Builder and return them to the upper region.

## Related Topics

AutoCreate Documents Overview, page 6-1

## Modifying Requisition Lines

Use the Modify Lines window to split an existing requisition line into multiple requisition lines that represent the same or different items. For example, if the requisition line quantity is so large that a single supplier cannot fill the entire order by the need-by date, then you need to fill this order from more than one supplier. On the other hand, if you have a requisition line item that contains parts that you want to order as unique items, you can explode the requisition line into several lines. These new requisition line(s) can then be modified as well.

**Note:** You cannot modify requisition lines with the following :

- Items under Enterprise Asset Management control
- Drop shipped orders
- Oracle Services Procurement fixed price or temp labor line types

**To modify requisition lines:**

1. Navigate to the Modify Lines window by selecting Modify on the Tools menu in the AutoCreate Documents window. Purchasing displays the current requisition line in the Lines tabbed region.

Num	Type	Item	Rev	Category	Description	UOM	Quant
3	Goods	f11000		CAPITAL_FURN&	Desk - Capitalizable, tax	Each	10

Deliver To	Expense	Source	Supplier
Requester	Brown, Ms. Casey	Supplier	Allied Manufacturing
Organization	Vision Operations	Site	DANVILLE-CTR
Location	V1- New York City	Contact	
Subinventory		Phone	

2. Enter as many new lines as you need to represent the original requisition line. Purchasing automatically creates new distribution lines and prorates quantities for the new distributions from the original requisition line distributions. Except that you cannot update destination information (destination type, organization, location, requester, and subinventory), the entry of information in the Lines, Source Details, Details, and Currency tabbed regions is identical to entry of this information in the Requisitions window. See: *Entering Requisition Lines*, page 3-51.

**Note:** You can only modify the quantity on outside processing requisition lines and the sum of the quantities on the new lines must match the quantity of the original line. You can only modify the quantity on encumbered requisition lines.

**Note:** If the profile option PO: Restrict Requisition Line Modify to Quantity Split is set to Yes you can only modify the quantity. See: *Profile Options in Purchasing*, page C-1.

**Note:** Changing the supplier for a line on a requisition with supplier p-card information will remove the p-card number.

**To cancel your entries:**

- Select Cancel to cancel your entries and return to the AutoCreate Documents window.

**To save your work:**

- Select OK to save your work and return to the AutoCreate Documents window, where Purchasing displays the new requisition lines that are now available for placement on a purchase order or RFQ. These lines do not appear, however, if the new requisition lines do not meet your original search criteria. The original requisition line is no longer available for purchase order or RFQ placement, but your requestor can easily review the modification status of a requisition line in the Requisition Lines Summary window.



---

# Professional Buyer's Work Center

## Buyer's Work Center Overview

Based on a web-based user interface, the Buyer's Work Center is a central desktop from which buyers can efficiently perform their daily tasks—such as viewing and acting upon requisition demand, creating and modifying orders and agreements, initiating negotiations if Oracle Sourcing is licensed and implemented, and managing the supply base.

The Buyer's Work Center provides you with the features you need to satisfy your document creation needs. You can:

- Access requisition demand in the Demand Workbench and create procurement documents
- Create a new standard purchase order, blanket purchase agreement, or contract purchase agreement
- Update an existing standard purchase order, blanket purchase agreement, or contract purchase agreement
- Create and maintain supplier information
- If Oracle Sourcing is licensed and implemented, create buyer's auctions or sourcing RFQs
- If Oracle Services Procurement is licensed and implemented, create and maintain purchase orders for complex work payments
- If Oracle Procurement Contracts is licensed and implemented, author contract terms and manage deliverables
- Use predefined document views

- Create and personalize your own document views including list of columns, where conditions, and sort sequences

## Major Features

### Varied Views of Demand

The Buyer's Work Center presents requisition demand in views that are easily customized to an individual buyer's way of working. These views allow buyers to quickly prioritize requisition demand based on a variety of factors, such as sourcing status or commodity.

### Improved Flows for Purchase Order and Agreement Creation

The Buyer's Work Center simplifies the purchase order and long-term agreement creation and management processes. The purchase order flow streamlines data entry by enabling buyers to enter shipment and distribution information at the line level. It also enables you to enter shipment or distribution information without having to drill down. A separate agreements flow is tailored specifically for the strategic buyer, who is responsible for agreement maintenance and compliance.

### Document Styles

Document styles allow procurement managers to control the look and feel of the application for different purchasing activities. For example, purchasing managers can create a document style for a specific commodity, such as temporary labor. This document style optimizes field labels and presentation for that commodity, simplifying purchase order entry.

### Easier Catalog Access with iProcurement-style Search

Oracle Purchasing builds on the popularity of Oracle iProcurement's search capabilities by offering buyers a similar search interface to easily find the items they need to procure. In addition, an improved catalog display shows all relevant attributes in a user-friendly list with the ability to drill-down to further details.

### Procurement for Complex Services

If your organization has licensed and implemented Oracle Services Procurement, the Buyer's Work Center supports a complete and integrated solution to procure complex work and manage the long-term contact execution. Services procurement often involves the definition and adherence of advanced payment terms when defining the contact. This solution is designed for fixed price contracts with either interim progress payments based on cost or milestones.

## Related Topics

Using the Demand Workbench, page 7-3

Orders in the Buyer's Work Center,

Agreements in the Buyer's Work Center,

Complex Work in the Buyer's Work Center,

Oracle Procurement Contracts: Manage Deliverables, *Oracle Procurement Contracts Administration and Implementation Manual*

Supplier Management: Suppliers and Supplier Sites, *Oracle iSupplier Portal Implementation Guide*

## Using the Demand Workbench: Requisitions

Demand Workbench allows you to access and aggregate requisition demand existing in Oracle Purchasing to create new procurement documents. Using the Demand Workbench, you can:

- Access requisition information from any organization to which you have security access
- Review all approved requisition lines before placing specific requisition lines on a document.
- Collect all requisition lines that meet a certain set of criteria that you establish
- Create a new or add to an existing standard purchase order
- If Oracle Sourcing is licensed and implemented, draft buyer's auctions or sourcing RFQs
- Review or change your purchase order immediately after creation
- Split one requisition line into several requisition lines
- Replace one requisition line with one or more items from the catalog or favorites list updating source information
- Consolidate multiple like requisition lines into single purchase order lines
- Return requisition lines to requester
- Maintain the relationships between the document lines and the backing requisitions
- Buyers can review and manage their workload

- Personal profile for saving default document type preference.
- Requisition grouping preferences and default document type to be created

### **To use the Demand Workbench:**

If you are new to Oracle Purchasing we recommend that you review the documentation referred to in the Related Topics section below.

1. Identify requisitions which you wish to fill. See: Searching for Requisitions, .
2. Use those requisitions to create a procurement document. See: Create Documents, .

### **Related Topics**

Overview of Requisitions,  
Reviewing Requisitions,

### **Requisitions: Demand Workbench**

1. Navigate to the Requisitions tab in the Buyer's Work Center. The initial page that opens is the Demand Workbench.



The screenshot displays the Oracle Purchasing Demand Workbench interface. At the top, there are navigation tabs for Requisitions, Orders, Agreements, Deliverables, Negotiations, and Suppliers. Below this, the 'Demand Workbench' section includes a 'Views' area with a dropdown menu set to 'My Requisitions' and a 'Search' button. A toolbar contains buttons for 'Add To Document Builder', 'Return Lines', 'Reassign', 'Cancel Split', 'Save Split', and pagination controls. The main area is a table of requisitions with columns for 'Select OU', 'Requisition', 'Item/Job', 'Qty Unit', 'Price Curr', 'Need-By', 'Source', and 'Actions'. The table lists ten requisitions, all from 'Vision Operations' with various requisition numbers (5551.9 to 5551.1 and 5550.4) and a source of 'Eastern Industrial Products, EIP MAIN' or 'Staples, STAPLES LA'. A second set of toolbar buttons is located below the table.

Select OU	Requisition	Item/Job	Qty Unit	Price Curr	Need-By	Source	Actions
<input type="checkbox"/>	Vision Operations 5551.9	z7445	4 Week	26000 USD	29-Dec-2003 00:00:00	Eastern Industrial Products, EIP MAIN	
<input type="checkbox"/>	Vision Operations 5551.8	z7445	4 Week	26000 USD	29-Dec-2003 00:00:00	Eastern Industrial Products, EIP MAIN	
<input type="checkbox"/>	Vision Operations 5551.7	z7445	4 Week	26000 USD	29-Dec-2003 00:00:00	Eastern Industrial Products, EIP MAIN	
<input type="checkbox"/>	Vision Operations 5551.6	z7445	4 Week	26000 USD	29-Dec-2003 00:00:00	Eastern Industrial Products, EIP MAIN	
<input type="checkbox"/>	Vision Operations 5551.5	z7445	4 Week	26000 USD	29-Dec-2003 00:00:00	Eastern Industrial Products, EIP MAIN	
<input type="checkbox"/>	Vision Operations 5551.4	z7445	4 Week	26000 USD	29-Dec-2003 00:00:00	Eastern Industrial Products, EIP MAIN	
<input type="checkbox"/>	Vision Operations 5551.3	z7445	4 Week	26000 USD	29-Dec-2003 00:00:00	Eastern Industrial Products, EIP MAIN	
<input type="checkbox"/>	Vision Operations 5551.2	z7445	4 Week	26000 USD	29-Dec-2003 00:00:00	Eastern Industrial Products, EIP MAIN	
<input type="checkbox"/>	Vision Operations 5551.1	z7445	4 Week	26000 USD	29-Dec-2003 00:00:00	Eastern Industrial Products, EIP MAIN	
<input type="checkbox"/>	Vision Operations 5550.4	z7235	4 Week	25000 USD	24-Dec-2003 00:00:00	Staples, STAPLES LA	

2. You can see all requisitions in the Oracle Purchasing requisition pool to which you have access based on your default view and your security profile.

- To select a different view, select from the View list. If you change views, only the requisitions for that view are displayed. See: Using Requisition Views, .
- If you would like to restrict the results to requisitions in a particular operating unit you need to navigate to the search region and specify the operating unit in the search region or create a personalized view for the operating unit.

3. Click Search to limit the requisitions displayed using Buyer, Requisition, Category, Supplier, or other conditions as criteria for search results. See: Using Advanced Search, .

You can also search for requisitions based on the content of their headers, lines, and distributions by clicking the Summary subtab. Note that you can save your search as a personalized view. See: Personalized Views, *Oracle Applications User Guide*.

4. When the page refreshes, you see all requisitions that matched the criteria for that view/search. For multiline requisitions, there is an entry for every requisition line (for example, you might see two entries: requisition 12345, line 1; and requisition 12345, line 2). If you see a requisition with multiple lines, but some of the lines are absent from the list, those lines have already been processed.

You can sort the results by clicking any column header.

You can see information for the requisition and requisition line by clicking the

Requisition and/or Line links. If the suggested supplier has a profile defined in Oracle iSupplier Portal, you can view the profile information by clicking the Source link. If the source document is a blanket purchase agreement, click on the source document link to view the source document.

5. Once you have identified the requisitions you are interested in you can:
  - View the requisition by clicking its number.
  - Create procurement documents. See: Create Documents, .
  - Manage requisitions. See: Manage Requisitions, .

## Using Requisition Views

There are predefined searches (views) that are available within the Demand Workbench. Additionally, there are any personalized views that you have created. To use a view, select the view from the View drop down menu and click Go.

You can use these views to search for requisitions as follows:

- *My Late Requisitions* - This view displays requisitions that are past the need-by date entered by the requester. That is, the need-by date on the requisition is prior to today's date.
- *My Requisitions* - This view displays all requisitions assigned to the buyer. Requisitions can be assigned to a particular buyer when the requisition was created.
- *My Requisitions for Goods* - This view displays requisitions for goods assigned to the buyer.
- *My Requisitions for Services* - This view displays requisitions for services assigned to the buyer.
- *My Requisitions Requiring a RFQ* - This view displays requisitions lines that require a RFQ.
- *My Requisitions with a New Supplier* - This view displays requisitions that suggest a supplier who has not yet been defined to the system (Oracle iProcurement can create requisitions and suggest a supplier that does not yet exist in the system).
- *My Requisitions with a Suggested Supplier* - This view displays requisitions that are sourced to a supplier.
- *My Urgent Requests* - This view displays requisitions that the requester marked as urgent.
- *Unassigned Requisitions* - This view displays requisitions that have not been assigned

to a sourcing buyer.

- *Personalized Views* You can create your own specialized views that displays only those requisitions in which you are interested. See: *Personalized Views, Oracle Applications User Guide*.

## Using Advanced Search

You can use the advanced search function to create a combination of search criteria that helps locate the appropriate requisitions. To use the advanced search function click Search.

Advanced search allows you to search for requisitions on a combination of values for Buyer, Requisition, Category, and/or Supplier. You can add additional search criteria by clicking Add. A list appears displaying all possible search criteria (for example, you may wish to also search on Item Description).

When performing advanced searches, you can choose to require entries to match all the search values or allow them to match any of the search values.

- *Search results where each must match all values entered* - Require entries to match all the search values you enter. For example, qualifying requisitions might be required to have the buyer be John Smith and the ship to location be New York. In this case, any qualifying requisitions must match both search values.
- *Search results where each may contain any value entered* - Allow entries to match any of the search values. For example, qualifying requisitions might be allowed to have the buyer be Patricia Stock or the ship to location be San Francisco. In this case, the qualifying requisitions can match either or both search values.

Use the Find icons to search for and select search values. When you have finished specifying your search, click Go (clicking Clear resets the search value fields).

## Create Documents

Once you have located the requisitions you wish to include in your document, use the Demand Workbench to create a new document.

### To create a new document:

1. Scroll the Demand Workbench page to the right.
2. Select a Document Builder document Type. This indicates the outcome you expect from the Document Builder.
3. Select an operating unit for your document by clicking the OU Find icon and selecting an entry from the OU results.

4. Scroll the page back to the left.
5. Select your requisition line(s):
6. Click Add to Document Builder to place the lines in your document.
7. To create the document, scroll right. Enter any additional information your document type requires and click Create.
  - If you wish to clear the document builder and start creating the document again from the beginning, click Clear.
  - If you would like to make updates to the document builder parameter, enter your changes and click Update.
8. The document type you selected is displayed:
  - If you selected New Order or Add to Order, the Update Standard Purchase Order page is displayed. See: Orders in the Buyer's Work Center, .
  - If Oracle Sourcing is licensed and implemented, and you selected New Auction or New RFQ, the Oracle Sourcing Negotiations page is displayed. Refer to the online help for that page for detail: Create New Negotiation, *Oracle Sourcing User Help*.

**Note:** By default the lines you selected are combined according to the rules below. See: Grouping Requisition Lines, .
9. Complete your document and click Create.

## Manage Requisitions

Once you have located the requisitions you wish to work on, use the Demand Workbench management tools.

### To return requisition lines;

If the requisition lines should not be used in a document, you can return them to the requester.

1. Select your requisition line(s).
2. Click Return Lines to remove the requisition lines from the requisition pool and change their status in Oracle Purchasing to Returned.
3. Enter a return Reason.

4. Click Apply.

**To reassign requisition lines:**

If the requisition lines should be assigned to a different buyer, you can reassign them.

1. Select your requisition line(s)
2. Click Reassign.
3. Identify the new buyer.
4. Click Apply.

**To update requisition lines from the catalog:**

1. Select your requisition line.
2. Click the Replace with items from catalog icon in the Actions column.
3. Find the new item in the catalog and click Add to Document.
4. Click Complete.

**To update requisition lines from your catalog favorites:**

1. Select your requisition line.
2. Click the Replace with items from favorites icon in the Actions column.
3. Find the new item in the catalog and click Add to Document.
4. Click Complete.

**To split requisition lines:**

1. Select your requisition line.
2. Click the Split icon in the Actions column.
3. Enter the new quantities in the Qty column for each requisition line.
4. Click Save Split.

**Grouping Requisition Lines**

If you select multiple requisitions or a requisition with multiple lines, Demand

Workbench consolidates multiple requisition lines with similar characteristics into a single sourcing document line. If you use default grouping multiple requisition lines are grouped together if they have the same values for the following characteristics:

- Item category
- Item number
- Item revision
- Item description
- UOM
- Ship-To address
- Line type

You can add need-by date or ship-to organization and location to the default grouping by using the profiles PO: Use Need-by Date for Default Autocreate grouping or PO: Use Ship-to Organization and Location for Default Autocreate grouping.

If you use requisition grouping the document builder creates a document with one line for each requisition line.

For more details about requisition grouping see: Using Automatic Creation Mode,

## Purchase Orders

The Buyer's Work Center Orders user interface optimizes the standard purchase order creation and management processes. Buyers can edit and view delivery schedules and account distributions across all order lines, thus eliminating the need to drilldown on individual lines. For simple purchase orders that do not require staged delivery schedules or multiple account distributions, buyers can quickly enter all necessary information for the order in the header and line sections, without having to navigate to the schedules and distributions sections.

### To use the Orders tab:

If you are new to Oracle Purchasing we recommend that you review the documentation referred to in the Related Topics section below.

1. Identify those existing purchase orders you wish to view, modify, duplicate, or delete. See: Finding Standard Purchase Orders, .
2. Identify the style of order which you wish to create and then create it. See: Creating Standard Purchase Orders, .

## Related Topics

Overview of Purchase Orders,  
Purchase Order Defaulting Rules,

## Finding Standard Purchase Orders

1. Navigate to the Orders tab in the Buyer's Work Center. This opens the Summary version of the Orders page. You can change the emphasis of the summary view by clicking Headers, Lines, Schedules, Pay Items, and Distributions.

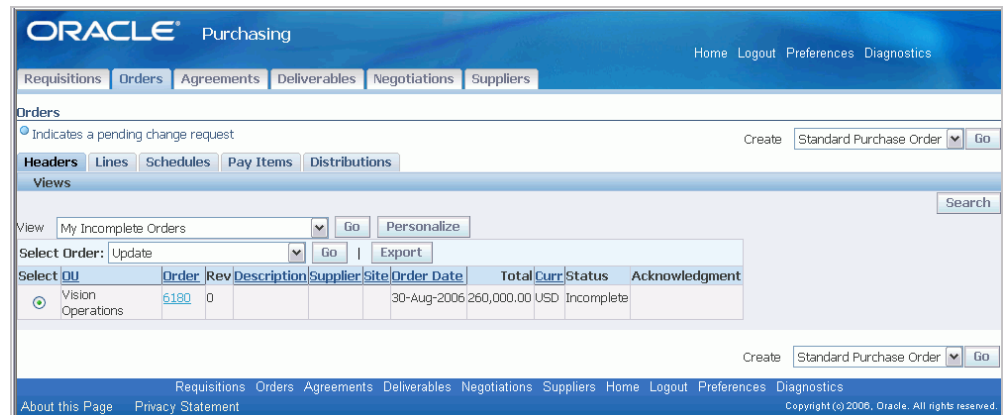

2. You can see all standard purchase orders to which you have access based on your default view and your security profile.

*View* - To select a different view, select the view from the menu. If you change the view, only the orders for that view are displayed. See: Using Order Views, .

*Export* - Exports the entire results of the search results. The results can be saved or viewed in a comma delimited file format.

3. Once you have found an order that you wish to work on:
  - *Take Action on a Standard Purchase Order* - Select the order, select an action from the Select Order list such as Update, and click Go.
  - *View Standard Purchase Order* - Click the order number and select Lines, Schedules, or Distributions using the tabs on the Standard Purchase Order page. View additional information about the order from the Action list and clicking Go. Click Update to switch to the Update Standard Purchase Order page.
4. If you want to create a new standard purchase order, select the style from the Create list and click Go. See: Entering Standard Purchase Orders, .

## Using Order Views

Views are predefined searches for orders. To use a view, select the view from the View list and click Go.

You can use the following views to search for orders:

- *My In Process Orders* - This view displays orders that have a status of *In Process*.
- *My Incomplete Orders* - This view displays orders that have a status of *Incomplete*.
- *My Open Orders* - This view displays all open orders assigned to the buyer.
- *My Orders with Pending Change Requests* - This view displays orders that have change requests associated with them..
- *My Orders with Rejected Acknowledgments* - This view displays orders that the supplier has rejected.
- *Personalized Views* You can create your own specialized views that displays only those orders in which you are interested. See: *Creating Personalized Views, Oracle Applications User Guide*.

## Entering Purchase Order Information

1. From the Orders page of the Buyer's Work Center navigate to the Create Standard Purchase Order page by selecting a style from the Create list and then clicking Go. If you are modifying an existing order it is displayed on the Update Standard Purchase Order page. You can change the emphasis of the page by clicking Headers, Lines, Schedules, and Distributions.

**Note:** Field names discussed below are assuming the Standard Purchase Order style was selected.



**2. Select the Order Header tab to enter general information about the entire order:**

- Enter order header information: Operating Unit, Supplier, Supplier Site, Supplier Contact, Communication Method, Currency, Buyer, Description, and Confirming Order.

For details see: Entering Purchase Order Headers,

- Enter order terms information: Bill-To Location, Payment Terms, Pay On Receipt, Required Acknowledgment, Acknowledge By, Default Ship-To, Ship Via, Freight Terms, FOB, and Transportation Arranger.

For details see: Entering Purchase Order Details Information, page 4-61

- Enter order attachments are entered by clicking Add Attachments.

See: Attaching Notes to Purchasing Documents, page 1-33

- Optionally enter a Note to Supplier or a Note to Receiver.

For details see: Entering Purchase Order Details Information, page 4-61

- For details on what you can do to your order, see: Using Order Actions, .

**3. Select the Orders Lines tab to enter details about the items on this order:**

- To add lines from the catalog, select From Catalog in the Add Lines list and click Go. To add lines from your favorites list, select From Favorites in the Add Lines list and click Go.

For details see the online help for the selection.

- Enter line details: Type, Item/Job, Description, Category, Quantity (Qty), Unit of Measure (Unit), Price, and Need-By/Start date. To expand the line to full page view click the Actions Update icon.

If this is a complex work order, see: Entering Complex Work Purchase Order Lines, .

For details see: Entering Purchase Order Lines, page 4-46

- In the Action column for each line you can click icons to Update, Split, or Delete.
- For details on what you can do to your lines, see: Using Order Actions, .

**4. Select the Orders Schedules tab to enter details about delivery of items on this order:**

- Enter schedule details: Schedule, Locations, Organization (Org), Quantity (Qty), and Need-By date. To expand the schedule to full page view click the Actions Update icon.

For details see: Entering Purchase Order Shipments, page 4-67

- In the Action column for each schedule line you can click icons to Update, Split, or Delete.
- For details on what you can do to your schedule, see: Using Order Actions, .

**5. If this is a complex work order, select the Pay Items tab to enter details about the progress payments for this order.** See: Entering Complex Work Purchase Order Pay Items, .

**6. Select the Distributions tab to enter details about the charge accounts for this order:**

- Enter distribution details: Distribution Type, Deliver-To, Quantity (Qty), and PO Charge Account. To expand the distribution to full page view click the Actions Update icon.

For details see: Entering Purchase Order Distributions, page 4-75

- For details on what you can do to your order, see: Using Order Actions, .

## Using Order Actions

- You can take the standard actions of Save, Approval Options, and Submit by

clicking one at the top or bottom of the page. .

**Note:** The Cancel button is used to return to the Summary page.

- From the Actions list at the top you can select (depending on the status of your order and which page you are viewing):
  - Cancel
  - Delete
  - Manage Tax
  - Place on Hold
  - Duplicate with Attachments
  - Duplicate without Attachments
  - Communicate
  - If the order is for complex services, you can select Create Work Confirmation
  - Check/Manage Funds
  - View Acknowledgments
  - View Acquisition Cost
  - View Action History
  - View Change History
  - View Invoices
  - If the PDF option is enabled, you can select View PDF to see the formatted purchase order as it will be communicated to the supplier.
  - View Payments
  - View Receipts
  - View Requisitions
  - View Revision History
  - If the order is for complex services, you can select View Work Confirmation

- If Oracle Procurement is enabled, you can select the following options:
  - Add Contract Terms
  - Update Contract Terms
  - Manage Deliverables
  - Manage Contract Documents
  - View Contract Terms

Click Go after your selection. For details regarding these actions see: [Purchase Order Tools Menu Options](#), and [Purchase Order Inquire Menu Options](#), .

## Entering Complex Work Purchase Order Pay Items

If Oracle Services Procurement has been licensed and implemented, you can take advantage of additional features for procuring complex services. Complex work procurement always creates a default pay item for the purchase order line. The type of Pay Item depends on the Pay Item types enabled on the document style and also the purchase order line type.

- For Lines with a value basis of Quantity, only Milestone Pay Items are possible, so you cannot create Rate or Lumpsum Pay Items for a Goods Line.
- For Fixed Price Services and Fixed Price Temp Labor Lines, you can create all three types of Pay Items: Rate, Lumpsum and Milestone. In this case, if all three types are enabled on the Document Style, a Lumpsum Pay Item is created by default.

### To enter pay items:

- Enter pay item details: Pay Item, Price, and Need-By Date.
- In the Action column for each pay item line you can click icons to Update, Split, or Delete.

See also: [Entering Purchase Order Information](#), .

## Entering Complex Work Purchase Order Lines

If Oracle Services Procurement has been licensed and implemented, you can take advantage of additional features for procuring complex services. Complex work procurement requires an integration between several Oracle Applications. The role that Oracle Purchasing plays is primarily in the authoring and monitoring portion of the Complex Work flow. In addition, the purchase order styles that dictate which of the complex work procurement attributes are available are created in Oracle Purchasing. See: [Defining Document Styles](#),

When you author a complex work procurement order there is some additional information required at the line level.

**Tip:** Remember to click the Update icon on the lines summary page to get the full page view of the line.

1. Line type must be Fixed Price Services.
2. In the Financing region, enter Advance Amount, Recoupment Rate, and Progress Payment % (per cent)>
3. In the Retainage region, enter Maximum Retainage Amount and Retainage Rate.
4. Add any drawings or specification documents using Add Attachments.

## Related Topics

Entering Purchase Order Headers,

Entering Purchase Order Lines, page 4-46

Entering Purchase Order Shipments, page 4-67

Entering Purchase Order Distributions, page 4-75

Entering Purchase Order Line Complex Services,

Overview of Purchase Orders,

Complex Work in the Procurement Suite, *Oracle Services User Guide*

## Purchase Agreements

The Professional Buyer's Work Center provides a dedicated user interface for creating and maintaining agreements, targeting the strategic buyer responsible for agreement maintenance and compliance.

### To use the Agreements tab:

If you are new to Oracle Purchasing we recommend that you review the documentation referred to in the Related Topics section below.

1. Identify those existing purchase agreements you wish to view, modify, duplicate, or delete. See: Finding Agreements, .
2. Identify the style of order which you wish to create and then create it. See: Creating Agreements, .

## Related Topics

- Overview of Purchase Orders,
- Purchase Order Defaulting Rules,

## Finding Agreements

1. Navigate to the Agreements tab in the Buyer's Work Center. This opens the Summary version of the Agreements page. You can change the emphasis of the summary view by clicking Headers or Lines.

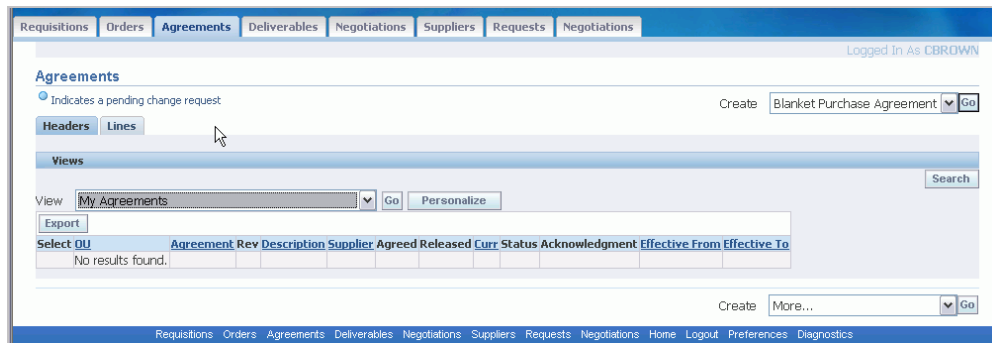

2. You can see all agreements to which you have access based on your default view and your security profile.
  - *View* - To select a different view, select the view from the menu. If you change the view, only the agreements for that view are displayed. See: Using Agreement Views, .
  - *Export* - Exports the entire results of the search results. The results can be saved or viewed in a comma delimited file format.
3. Once you have found an agreement that you wish to work on:
  - *View Agreement* - Click the Agreement number and select Lines using the tabs on the Agreement page. View additional information about the order from the Action list and clicking Go. Click Update to switch to the Update Agreement page.
  - *Take Action on an Agreement* - Select the agreement, select an action from the Select Agreement list such as Update, and click Go.
4. To create a new agreement select the style from the Create list and click Go. See: Entering Agreements, .

## Using Agreement Views

Views are predefined searches for agreements. To use a view, select the view from the View list and click Go.

You can use the following views to search for agreements:

- *My Agreements* - This view displays all open agreements assigned to the buyer.
- *My Agreements with Pending Change Requests* - This view displays agreements that have change requests associated with them.
- *My Agreements with Rejected Acknowledgments* - This view displays agreements that the supplier has rejected.
- *My Expiring Agreements* - This view displays agreements that are going to expire, based on notification controls.
- *My Incomplete Agreements* - This view displays agreements that have a status of *Incomplete*.
- *Personalized Views* You can create your own specialized views that displays only those agreements in which you are interested. See: *Creating Personalized Views, Oracle Applications User Guide*.

## Create And Update Agreements

The Agreements page of the Buyer's Work Center supports two basic Oracle Purchasing document types: the global blanket purchase agreement and the global contract purchase agreement. See: *Purchase Order Types*,

### Entering Purchase Agreement Information

1. From the Agreements page of the Buyer's Work Center navigate to the Create Blanket Purchase Agreements page or the Create Contract Purchase Agreements page by selecting a style from the Create list and then clicking Go.

If you need to modify an existing agreement click its Agreement number and it is displayed on the Blanket Purchase Agreements page or the Contract Purchase Agreements page. Click Update to make your changes. You can change the emphasis of page by clicking Headers, Lines, or Controls.

**2. Select the Agreement Header tab to enter general information about the entire agreement:**

- Enter agreement header information: Operating Unit, Supplier, Supplier Site, Supplier Contact, Communication Method, Buyer, Amount Agreed, Currency, Effective From and To dates, and Description.

For details see: Entering Purchase Order Headers,

- Enter agreement terms information: Bill-To Location, Payment Terms, Pay On Receipt, Required Acknowledgment, Acknowledge By, Amount Limit, Default Ship-To, Ship Via, Freight Terms, FOB, and Transportation Arranger.

For details see: Entering Purchase Order Details Information, page 4-61

- Enter agreement attachments are entered by clicking Add Attachments.

See: Attaching Notes to Purchasing Documents, page 1-33

- Optionally enter a Note to Supplier or a Note to Receiver.

For details see: Entering Purchase Order Details Information, page 4-61

- For details on what you can do to your agreement, see: Using Agreement Actions, .

**3. Select the Agreements Lines tab to enter details about the items on this**



**agreement:**

**Note:** There are no lines on a contract purchase agreement.

- To add lines from the catalog, select From Catalog in the Add Lines list and click Go. To add lines from your favorites list, select From Favorites in the Add Lines list and click Go.

For details see the online help for the selection.

- Enter line details: Type, Item/Job, Description, Category, Unit of Measure (Unit), Price, and Expiration date. To expand the line to full page view click the Actions Update icon.

For details see: Entering Purchase Agreement Information, page 4-55

- In the Action column for each line you can click icons to Update, Split, or Delete.

- For details on what you can do to your agreement, see: Using Agreement Actions, .

**4. Select the Agreements Control tab to enter control details for this agreement:**

- Define operating unit access by selecting a Purchasing OU and Purchasing Site for a Requesting OU.

For details see: Enable Organizations For A Global Agreement, page 4-56

- Enable Automatic Processes for your blanket purchase agreement by selecting:
  - Enable Automatic Sourcing
  - Update Sourcing Rules and Assignments

See: Enter Additional Options,

- Enable Retroactive Pricing for your blanket purchase agreement by selecting:
  - Apply Price Updates to Existing POs
  - Communicate Price Updates

See: Enter Additional Options,

- Enter Notification Controls for this agreement by entering Condition, Warning Delay, Percent, Amount, Effective From date, and Effective To date.

For details see: Entering Purchase Order Notification Controls, page 4-80

- For details on what you can do to your agreement, see: [Using Actions](#), .

## Using Agreement Actions

- You can take the standard actions of Cancel, Save, Approval Options, and Submit by clicking one at the top or bottom of the page. .

**Note:** The Cancel button is used to return to the Summary page.

- From the Actions list at the top you can select (depending on the status of your agreement and the page you are viewing):
  - Delete
  - Enable Catalog Administrator Authoring
  - Enable Supplier Authoring
  - Place on Hold
  - Duplicate with Attachments
  - Duplicate without Attachments
  - If the PDF option is enabled, you can select View PDF to see the formatted purchase order as it will be communicated to the supplier.
  - If Oracle Procurement Contracts is implemented you can select Add Contract Terms.

Click Go after your selection. For details regarding these actions see: [Purchase Order Tools Menu Options](#), and [Purchase Order Inquire Menu Options](#), .

## Related Topics

[Entering Purchase Order Headers](#),

[Entering Purchase Order Details Information](#), page 4-61

[Entering Purchase Agreement Information](#), page 4-55

[Enable Organizations For A Global Agreement](#), page 4-56

[Overview of Purchase Orders](#),

## Agreement

Pricing Transparency enables you to recalculate the purchase order price based on specific business processes. You can use the pricing modifier and a qualifier to recalculate the price for each PO line automatically. You can view the pricing transparency information in the Buyer Work Center.

Refer to the Creating a Modifier List and Creating Qualifiers sections in *Oracle Advanced Pricing User's Guide* for more details on setting up modifiers and qualifiers.

Pricing Transparency is enabled for Standard Purchase Order (SPO) and Global Blanket Purchase Agreement (GBPA) releases. You can apply pricing transparency only when you set the line type purchase basis as Goods.

You must define a document style for Standard Purchase Order and Global Blanket Purchase Agreement with Pricing Enhanced check box enabled to apply pricing transparency for a line item.

Refer to the Defining Document Styles, page 1-73 for more information.

Pricing Transparency is applicable for manual creation of Standard purchase orders without a source document, and Standard purchase orders with GBPA as the source document and the Global Blanket Purchase Agreement.

**Note:** Pricing Transparency is disabled when using Purchasing Document Open Interface (PDOI) and Create Releases.

## Viewing Price Structure

You can perform the following tasks in the View Price Structure page:

- View the pricing modifier information for a purchase order and GBPA line item
- View pre-calculated price adjustments applied by the system (price engine)
- Enter the manual modifier application; change modifier rate, and recalculate the price
- Query existing manual modifiers and apply it to the purchase order and GBPA unit price
- Change the modifier rate and apply changes to PO or GBPA Line. After you change the modifier rate, you are prompted to enter Change Reason and Change Reason Text values to apply rate modification

## Viewing Pricing Transparency for PO Lines with No Source Document

You can view pricing transparency for PO document with pricing enhanced check box enabled.

### To view pricing transparency information for the PO line:

1. Navigate to the Buyer Work Center –Orders page.
2. In the Orders page, select Create Standard Purchase Order Pricing Enhanced document style from the Create list and click Go.

**Note:** You must define a document style for Standard Purchase Order and Global Blanket Purchase Agreement with Pricing Enhanced check box enabled to apply pricing transparency for a line item.

Refer to the Defining Document Styles, page 1-73 for more information.

3. Select the Order Header tab to enter header, such as:
  - Operating Unit
  - Supplier
  - Supplier Site
  - Supplier Contact
  - Default Ship To Location
  - Currency
  - Buyer
  - Confirming Order
4. Select the Orders Lines tab to enter line details about the items on this order:
  - To add lines from the catalog, select From Catalog in the Add Lines list and click Go.
  - To add lines from your favorites list, select From Favorites in the Add Lines list and click Go.
  - Select an Item from the LOV.

- Click Save.
- Click the Update icon in the Action column.
- In the Update Line page, scroll down to view if the source document attached to this line. You can also select a source document from the LOV.
- Select the View Price Structure item from the Actions menu at the line level and click Go.
- Click Yes in the warning message, which states *You must save your changes before continuing. Do you want to save now?*

**Note:** Price is calculated based on the price list and the automatic modifier applied to the PO line by the system. If no modifier is applied to the line item in the PO line, then the unit price of the PO is updated manually. Apply the manual modifier to update the price always. If you update the unit price manually without manual modifiers, then pricing transparency is not applied for that PO line.

Refer to the Creating a Modifier List and Creating Qualifiers sections in *Oracle Advanced Pricing User's Guide* for more details on setting up modifiers and qualifiers.

5. In the View Price Structure page you can view the line item information and price request lines. You can view the pricing lines; modifier name, modifier number, modifier type, list line number, rate, application method, adjusted amount, adjusted unit price, change reason, and change reason text.

The screenshot shows the Oracle Purchasing interface. At the top, there is a navigation bar with 'ORACLE Purchasing' and various utility links like 'Navigator', 'Favorites', 'Home', 'Logout', 'Preferences', and 'Diagnostics'. Below this is a breadcrumb trail: 'Orders > Update Wild SPO > Update Line >'. A confirmation message states 'Your changes have been saved.' Below the message, the page title is 'Price Structure (PO 6934)'. The main content area is divided into two sections: 'Line' and 'Price Engine Request Lines'. The 'Line' section shows details for Line 1, including Item 591, Description 591, Quantity 100, Uom Each, Base Unit Price 10, and Ordering Price 8. The 'Price Engine Request Lines' section contains a table with the following data:

Modifier No	Name	Type	List Line No	Rate	Application Method	Adjusted Amount	Adjusted Unit Price	Change Reason	Change Reason Text	Delete
591	591	Discount	347872	2	Amount	-2	8			

At the bottom of the screenshot, there is a link: 'Return to Price Structure (PO 6934)'.

**Note:** If a purchase order has the GBPA as a source document with

modifiers, then you can view only those modifiers in the source document price structure section.

**Note:** If you copy the PO with Duplicate with Attachments and Duplicate with no Attachments action items, then the pricing enhanced information is copied from the source PO.

### Updating the Rate of an Automatic Modifier in a PO Line

To update the rate of an automatic modifier in a PO line item:

1. Navigate to the Buyer Work Center –Orders page.

**Note:** You can view all the standard purchase orders based on your default view and your security profile.

2. Select the desired Standard Purchase Order Pricing Enhanced document and select Update in the Select drop down list and click Go.
3. Select the Lines tab and click the Update icon in the Actions column for a line item.
4. From the Actions menu, select View Price Structure item and click Go.
5. Update the rate value in the Rate field.

**Note:** After you update the Rate, the system prompts you to enter the Change Reason and Change Reason Text field values. This action creates a Change Request for the purchase order line.

6. Select the Change Reason from the LOV. The Change Reason Text is defaulted based on your selection.
7. Click Save.
8. Return to the View Price Structure page using the Return to Price Structure link.
9. You can view the colored indicator beside the Price field. This indicates that the price is modified.

The screenshot displays the Oracle Purchasing interface for viewing the price structure of a specific line item. The breadcrumb trail shows 'Orders > Update Wild SPO > Update Line 1 (Wild SPO 6934)'. The main section is titled 'View Price Structure' and includes a 'Go' button and navigation links for 'Previous Line', 'Next Line', and 'Apply'. The line item details are as follows:

Operating Unit	Vision Operations	Currency	USD
* Indicates required field		Category	MISC.MISC
Line Type	Goods	* Quantity	100
Item	591	* Unit	Each
* Description	591	* Price	8.00
Supplier Item		Negotiated	No
		Amount	800.00

Below the line item details, there are sections for 'Shipping' and 'Delivery' information, each with searchable fields for location, organization, need-by date, and promised date.

**Note:** This indicator appears only when a manual modifier is applied or the rate of the modifier is updated (overridable modifier). If a modifier is not applied, then the Base Unit Price and Ordering Unit Price are equal.

10. In the View Price Structure page, click Add Manual Modifier to select the modifier manually from the LOV.

**Note:** You cannot edit, or delete the automatic modifiers; however, you can update the rate for the modifier.

### Viewing Pricing Transparency for GBPA Line

To create and update the Global Blanket Purchase Agreement with pricing transparency:

1. Navigate to the Buyer Work Centre – Agreements page.
2. In the Agreements page, select the Create Blanket Purchase Agreement Pricing Enhanced document style from the Create list and then click Go.
3. Select the Agreement Header tab to enter header information, such as:
  - Operating Unit
  - Supplier
  - Supplier Site
  - Supplier Contact

- Communication Method
- Buyer
- Amount Agreed
- Currency
- Effective From and To Dates
- Default Ship To Location
- Description

Refer to the Entering Purchase Order Headers, page 4-40 for more information.

4. Select the Agreements Lines tab to enter details about the items on this agreement:
  - To add lines from the catalog, select From Catalog in the Add Lines list and click Go.
  - To add lines from your favorites list, select From Favorites in the Add Lines list and click Go.
  - Select an Item from the LOV.
  - Click the Update icon in the Action column.
  - In the Update Line page, scroll down to see if the source document attached to this line. You can also select a source document from the LOV.
  - Enable the Allow Price Override check box.

**Note:** If Allow Price Override check box is disabled, then you cannot apply the manual modifiers or change the rate of the automatic modifier in a PO line with specific GBPA as a source document.

- Select the View Price Structure item from the Actions menu at the line level.
- Click Go.
- Click Yes in the warning message, which states *You must save your changes before continuing. Do you want to save now?*

**Note:** Pricing Transparency is applied only when you save the



Global Blanket Purchase Agreement and line item price is updated automatically.

5. In the View Price Structure page, you can view the line item information and price request lines. You can view the pricing lines; modifier name, modifier number, modifier type, list line number, rate, application method, adjusted amount, adjusted unit price, change reason, and change reason text.

**Note:** You cannot edit or delete the automatic modifiers; however, you can update the rate for the modifier.

6. Return to the Update Line page using the Return to Update Line link.
7. Click Submit to submit the agreement for approval.

#### **Updating the Rate of an Automatic Modifier in a GBPA Line**

To update the rate of an automatic modifier applied in a GBPA line item:

1. Navigate to the Buyer Work Centre – Agreements page.

**Note:** You can view blanket purchase agreements based on your default view and your security profile.

2. Click Search to search for a blanket agreement.
3. Enter the agreement number as the search criteria and click Go.
4. In the Search Results page, click the Details icon to view the agreement information.
5. Return to the Update Line page by clicking the Return to Update Line link.
6. Enter another line Item and click the Update icon in the Actions column.
7. From the Actions menu, select the View Price Structure item and click Go.
8. Click Yes in the warning message.

**Note:** If you copy a line item, then the pricing enhanced information is copied from the source line item.

9. In the View Price Structure page, enter the value for rate in the Rate field.

10. Click Add Manual Modifier to select the modifier manually from the LOV.
11. Click Save.

**Note:** You cannot edit or delete the automatic modifiers; however, you can update the rate for the modifier.

## Using View PDF

You can use the View PDF option to view the pricing modifier details that are applied at the Standard purchase order and GPBA line level. You can view the purchase order information in the Adobe Acrobat format.

### To view the enhanced pricing information using the View PDF option:

1. Navigate to the Buyer Work Centre – Agreements page.

**Note:** You can view blanket purchase agreements based on your default view and your security profile.

2. Click Search to search for a blanket agreement.
3. Enter the agreement number as the search criteria and click Go.
4. Click the Agreement Number link to view the agreement details.
5. From the Actions menu, select View PDF.

**Note:** The application generates a PDF file with complete purchase order information.

6. Open the PDF file and view the modifier information such as Modifier Type, Modifier Description, Rate, Application Method, Adjustment Unit Price, Base Unit Price, and Unit Price.

**Note:** You can also view the pricing information in the normal PO. If no modifier is applied to the GBPA or the PO line then that modifier information is not visible for that GBPA or PO line in the PDF.

## Converting the Purchase Requisition to PO

To convert the Purchase Requisition to PO:

1. Navigate to the Buyer Work Centre – Requisitions page.  
**Note:** You can view all the purchase requisitions based on your default view and your security profile.
2. Click Search to search for a purchase requisition.
3. Enter the Requisition number as the search criteria and click Go.
4. Select the Requisition and click Add.
5. In the Document Builder region, select the Style as Standard Purchase Order Pricing Enhanced.  
**Note:** Select a document style for which Pricing Enhanced check box is enabled.
6. Click Create. The pricing information is updated automatically.
7. Enter the required PO Header information.
8. Click the Lines tab and select the Update icon to view the pricing information.
9. From the Actions menu, select the View Price Structure, and then click Go.
10. Click Yes in the warning message, which states *You must save your changes before continuing. Do you want to save now?*
11. In the View Price Structure page, you can view the line item information and price request lines.  
**Note:** You cannot edit or delete the automatic modifier applied; however, you can update the rate for the modifier.



---

# Communication With Suppliers

## Overview of Supplier Communication

### Purchase Order Communication to Suppliers

In a business climate that is more global and electronic everyday, enterprises are being asked to produce procurement documents in a variety of different formats. Oracle Purchasing supports the following methods of communicating purchase orders:

- Print
- Facsimile (fax)
- Electronic mail (e-mail)
- Extensible Markup Language (XML)
- Electronic Data Interchange (EDI)
- Online Viewing

You can print, reprint, e-mail, or fax purchase orders as often as you want using the Submit Requests window (See: Submitting a Request, *Oracle Applications System Administrator's Guide*). You can choose from the following options:

- Print all new and changed purchase orders
- Print all changed purchase orders
- Print all new purchase orders
- Print a particular purchase order or range of purchase orders
- Print a test purchase order

- Landscape or portrait format

The communication method normally used by Oracle Purchasing is determined by the selection of Notification Method in the Supplier Site window and your application configuration. See: Setup Purchase Order Communication to Suppliers, page 1-75

**Important:** Your administrator must enable PDF output (described below) to activate the Communicate selection in the Tools menu of the Purchase Order Summary window.

## Print Purchase Orders

The traditional way to communicate purchase orders to your supplier is by printing them and sending a copy to the supplier in the mail. Your purchase order can be printed using text or PDF (Adobe Portable Document Format) formatting. If you use the text format, you can print at the time you approve the purchase order or when you submit the Printed Purchase Order and Printed Change Order reports. If you choose the PDF format, you can create the PDF at the time you approve the purchase order, from the Purchase Order Summary window, or the PO Output for Communication process. See: Purchase orders in PDF, page 8-3.

See: Printed Purchase Order Overview, page 8-3.

You can send facsimiles of purchase orders using text or PDF formatting. If you choose text format you can fax at the time you approve the purchase order or when you submit the Printed Purchase Order and Printed Change Order reports. If you choose PDF format, you can fax at the time you approve the purchase order, or from the Purchase Order Summary window. See: Purchase orders in PDF, page 8-3.

**Note:** This communication method requires that your system administrator configure your Oracle Application to support fax transmission.

## E-mail Purchase Orders

You can send e-mail copies of purchase orders using HTML or PDF formatting. If you are using HTML format, you can e-mail at the time you approve the purchase order. For the PDF format, you can e-mail at the time you approve the purchase order or from the Purchase Order Summary window. Note that the PDF format purchase orders are sent as attached files. See: Purchase orders in PDF, page 8-3.

**Note:** This communication method requires that your system administrator configure your Oracle Application Notification Mailer workflow to support e-mail transmission.

## XML Purchase Orders

Purchase orders and change orders can be communicated to the supplier using XML if the Oracle XML Gateway is implemented. Your XML documents are sent at the time you approve the purchase order.

## EDI Purchase Orders

Purchase orders and change orders can be communicated to the supplier using EDI if the Oracle e-Commerce Gateway is implemented. Your EDI documents are sent at the time you approve the purchase order.

## Online Viewing

Purchase orders and change orders can be viewed by suppliers through the Oracle iSupplier Portal application. This application enables suppliers to view and take action on their purchase orders through a secure, Internet-based portal.

## Purchase Orders in PDF

Purchase orders can be viewed, e-mailed, and faxed to suppliers in Adobe Portable Document Format (PDF). A style sheet template is specified to control the appearance and layout of the formatted PDF file. If you have implemented Oracle Procurement Contracts, there is a separate style sheet template which controls the appearance and layout of the contract terms as part of the purchase order PDF file. These templates are managed using Oracle XML Publisher. See the *Oracle XML Publisher User's Guide*.

Purchase orders in PDF can be viewed online by buyers from the Enter Purchase Order window, the Purchase Order Summary window, and the PO Output for Communication report.

**Note:** This feature requires configuration of your Oracle Applications by your system administrator.

## Printed Purchase Orders Overview

Oracle Purchasing formats your purchase orders to be communicated to suppliers on a standard purchase order form. This section explains how Oracle Purchasing formats the purchase order information. You can use the standard format or customize the report to meet your needs.

**Note:** Some of the titles described in this section (related to specific functionality) may vary slightly depending on whether your organization is using text or PDF report format.

## Multilingual Support

If you use Multilingual Support (MLS), you can print most of the fields on the following reports in another language:

- Printed Purchase Order Report (Landscape)
- Printed Purchase Order Report (Portrait)
- Printed RFQ Report (Landscape)
- Printed RFQ Report (Portrait)
- Printed Change Orders Report (Landscape)
- Printed Change Orders Report (Portrait)
- PO Output for Communication Report

See: Submitting a Request, *Oracle Applications User's Guide*.

**Note:** You can print item descriptions in other languages only for inventory items for which translations have been entered. If you change the item description on the document, it does not print in the translated language.

## Major Features

### Portrait and Landscape Formats

Purchasing lets you print your purchase orders in portrait or landscape format. Use the Submit Requests window to choose either the Printed Purchase Order Report (Landscape) or the Printed Purchase Order Report (Portrait). The explanations that follow describe both portrait and landscape characteristics. See: Submitting a Request, *Oracle Applications User's Guide*.

### Printed Change Orders Report

In addition to the Printed Purchase Order Report, you can also use the Submit Requests window to choose the Printed Change Orders Report in portrait or landscape formats. This prints only the changes between revisions of purchase orders, but is otherwise *identical* to the Printed Purchase Order Report. When you have purchase orders with many lines, you can print only pertinent change information to send to the supplier. If a modification to the purchase order shipment causes the purchase order revision to change, the Printed Change Orders Report prints the revised shipment, line, and header. If the modification is to the line, the report prints the revised line and header. If only the header is modified, the report prints only the header. Note that the report does



not include purchase orders for which only the distribution is modified.

### **Brief Notes**

Purchasing prints the brief notes to supplier that you attach to the purchase order header or line. These notes can contain up to 240 characters. Purchasing automatically wraps the notes after 103 characters per line for landscape orientation and 75 for portrait. These notes may wrap in the middle of a word to ensure the correct line count for each page.

### **Attachments**

Purchasing prints all text attachments with a usage of Supplier on the purchase order. These notes contain up to 64K characters per note. You can attach as many notes as you want to the purchase order headers and lines. Purchasing also prints text attachments to the items. Purchasing prints 78 characters per line and automatically wraps to the next line. The note appears on the purchase order exactly as you enter it. See: Attaching Notes to Purchasing Documents, page 1-33.

The PDF version of the purchase order displays the non-text attachment filenames at the appropriate level. The header level non-text attachments are displayed in the Notes section as "Attachments." The line and shipment or price break level non-text attachments appear at the lines or shipments or price breaks they reference. Besides the non-text files, hyperlinks of HTML attachments and web pages are included in the PDF in this way. Clicking on these hyperlinks would cause the HTML attachments to open in a new window.

**Note:** When communicating PDF purchase orders using e-mail, all File type attachments are zipped into a single zip file named "Attachments.zip."

### **Purchase Agreements**

Purchasing prints an appropriate document title on all your purchase agreements and releases.

If you provide effective dates on your contract or blanket purchase agreements, Purchasing also prints titles appropriate for those effective dates and your choice of formatting. See: Agreement/Release Components, page 8-15.

### **Cancelled Orders**

Purchasing automatically indicates whether you cancelled any part of your purchase order. If you cancel the purchase order header, Purchasing prints the following cancellation message at the top of the purchase order and does not print cancellation messages for lines or shipments:

- **This purchase order CANCELLED on:** [date]

If you cancel a purchase order release, Purchasing prints the following cancellation

message:

- **This release CANCELLED on:** [date]

If you cancel a purchase order line without cancelling the corresponding header, Purchasing prints the following cancellation messages:

- **This line CANCELLED on:** [date]
- **Original quantity ordered:** [quantity]
- **Quantity CANCELLED:** [quantity]

If you cancel a purchase order shipment without cancelling the corresponding purchase order line, Purchasing prints the following messages. Purchasing also prints these messages for each shipment if you cancel the corresponding purchase order line.

- **This shipment CANCELLED on:** [date]
- **Original shipment quantity:** [quantity]
- **Quantity CANCELLED:** [quantity]

See: Controlling Documents, page 2-57.

### Confirming Orders

You designate whether a purchase order is a confirming order when you enter the purchase order header information. If you select Confirming Order in the Purchase Order Details window, Purchasing automatically prints **CONFIRMATION -- DO NOT DUPLICATE**. See: Entering Purchase Order Details Information, page 4-61.

### Foreign Currency

For the text report format, when you designate that a purchase order is in a different currency than your base currency Purchasing prints **All prices and amounts on this order are expressed in** [foreign currency]. The PDF report format always indicates the currency. You designate the currency when you create the purchase order.

### Acceptances

If you require an acceptance from your supplier, Purchasing prints the following message: **Please formally accept this order by:** [acceptance date]. You designate whether you require an acceptance when you create the purchase order. When you indicate that you require an acceptance, you also provide an acceptance date by which you expect your supplier to respond. See: Entering and Viewing Purchase Order Acceptances, page 4-82.

### Purchase Agreement References

Purchasing prints the following message for each standard purchase order line that

references an agreement number: **This PO line references contract PO#** [agreement number]. You associate a purchase agreement number with a standard purchase order line when you create the purchase order.

### Quotation References

Purchasing prints the following message for each purchase order line that references a quotation number: **This PO line references Quotation #:** [supplier quotation number] **Line:** [line number] **Your Quotation #:** [purchase order quotation number]. You associate a quotation number with a purchase order line when you create the purchase order.

### Automatic Table Update

Purchasing automatically updates the item history table when you print your purchase order for each revision. Purchasing records the item, supplier, quantity, unit of measure, price, and purchase order number. This information is available when you view last price and history information. See: Overview of the Supplier Item Catalog, page 5-5.

### Printed Purchase Order Diagram Descriptions

The following table includes both portrait and landscape explanations for the text and PDF formats.

**Tip:** N/A indicates not available. P/L indicates differences between portrait and landscape versions, see the description for details.

Field	Description	Text PO	PD F PO
PO Number (PDF: Order)	Purchasing prints the purchase order number. If the order is a release, Purchasing prints a dash ('-') after the purchase order number followed by the release number.	12	12
Revision	Purchasing prints the purchase order revision.	4	4
Page	Purchasing prints the page number.	3	3

Field	Description	Text PO	PD F PO
Ship To	The ship to information contains up to 3 lines of address. After the address, Purchasing prints the city, state (or province), and zip code on line 4. On line 5, Purchasing prints the country. Purchasing prints the ship to location even if it is the same as the bill to location. (portrait - 28 characters for line 1 through 4 lines, 25 characters for line 5; landscape - 30 characters for lines 1 through 4, 25 characters for line 5)	P/L	P/L
Bill To	The bill to information contains up to 3 lines of address. After the address, Purchasing prints the city, state (or province), and zip code on line 4. On the line 5, Purchasing prints the country. (portrait - 28 characters for line 1 through 4 lines, 25 characters for line 5; landscape - 30 characters for lines 1 through 5)	P/L	P/L
Supplier	Purchasing prints the supplier name on line 1. Purchasing then prints up to 3 lines of address. On line 5, Purchasing prints the city, state (or province), and zip code. Purchasing prints the country on line 6. (portrait - 40 characters for line 1, 35 characters for lines 2 through 4, 42 characters for line 5; landscape - 42 characters for line 1, 35 characters for lines 2 through 6)	P/L	P/L
Customer Account	Purchasing prints the number your supplier associates with your company. You provide this number in the Supplier window. (portrait - 13 characters, landscape - 9 characters) See: Suppliers, <i>Oracle iSupplier Portal Implementation Guide</i> .	P/L	P/L
Supplier No.	Purchasing prints the number for your supplier. (portrait - 13 characters; landscape - 9 characters)	P/L	P/L
Date Of Order/ Buyer	Purchasing prints the original buyer and creation date. (portrait - first initial of first name and 10 characters of last name; landscape - first initial of first name and 11 characters of last name)	P/L	N/ A
Order Date	Purchasing prints the creation date.	N/A	10
Created By	Purchasing prints the original buyer's name.	N/A	

<b>Field</b>	<b>Description</b>	<b>Text PO</b>	<b>PD F PO</b>
Revised Date/ Buyer	If you revise the purchase order and do not change the name of the original buyer, Purchasing prints the original buyer's name and the date of the revision. If you change the buyer's name, the new name is printed. If you have not yet revised the purchase order, Purchasing leaves this field blank. (portrait - first initial of first name and 10 characters of last name; landscape - first initial of first name and 11 characters of last name)	P/L	N/ A
Revision Date	If you revise the purchase order, Purchasing prints the revision date.	N/A	10
Revised By	If you revise the purchase order, the buyer's name is printed.	N/A	
Payment Terms	Purchasing prints the payment terms for your purchase order. (portrait - 27 characters; landscape - 21 characters)	P/L	P/L
Ship Via	Purchasing prints the mode of transportation for the items on the purchase order. (portrait - 22 characters; landscape 22 characters)	P/L	P/L
FOB (PDF: F.O.B.)	Purchasing prints the free on board terms. (portrait - 28 characters; landscape 20 characters)	P/L	P/L
Freight Terms	Purchasing prints the freight terms code that explains the condition of the freight charges and the party responsible for the freight. (portrait - 27 characters; landscape - 21 characters)	P/L	P/L
Requestor/ Deliver To (PDF: Deliver To/Requester)	If the standard purchase order is for one requestor only, Purchasing prints the full first and last name of the requestor. For multiple requestors, Purchasing prints Many. (portrait - 22 characters; landscape - 52 characters)	P/L	P/L
Confirm/ Telephone (PDF: Confirm To/Telephone)	Purchasing prints the contact name and contact phone number. (portrait - first initial of first name, up to 10 characters of last name, 15 characters for the phone number; landscape - 37 characters for first and last name combined, 16 characters for the phone number)	P/L	P/L

Field	Description	Text PO	PDF PO
Timezone Note	Purchasing prints a note identifying the timezone that applies to this purchase order.	N/A	
Transportation Arranged (PDF: Transportation)	If Oracle Transportation is implemented, Purchasing prints the party responsible for transportation.	N/A	

### Standard/Planned Purchase Order Components

Purchasing prints the main text underneath the Item title on the purchase order. Purchasing first prints header information followed by line, shipment, and distribution information.

**Note:** Planned purchase orders are not supported in PDF format.

For single shipments with the same ship-to address as the header, Purchasing pulls all information up to the line level and blanks out the shipment level entirely, regardless of other factors. For multiple shipments or a single shipment with a different ship-to address from the header, Purchasing prints information at both shipment and line levels.

In the PDF format, if all the shipments have the same ship-to address, but the address is different from the header, Purchasing suppresses the address at the shipment level and instead prints the ship-to address in the header.

### Standard and Planned Purchase Order Header

Standard and planned purchase orders print the following header information if it pertains to the purchase order:

- Brief Supplier Note
- Long Supplier Note
- **This purchase order CANCELLED on:** [date].
- **CONFIRMATION -- DO NOT DUPLICATE**
- Foreign Currency Information

## Standard and Planned Purchase Order Lines

After printing the header information, Purchasing prints the following line information:

**Tip:** N/A indicates not available. P/L indicates differences between portrait and landscape versions, see the description for details.

Field	Description	Text PO	PDF PO
Line	Purchasing prints the purchase order line number.		
Item Number/ Description (PDF: Part Number/Description)	Purchasing prints your item number first. If you have an item revision number, Purchasing prints [revision number]. If you specify a supplier item number, Purchasing prints (Your #: [supplier item number]) for text or (Supplier Item: [Supplier item number]) for PDF on the next line. Purchasing then prints the item description on the following line. (portrait - wraps after 23 characters per line, landscape - wraps after 45 characters per line) (For PDF Purchasing also includes the Supplier Configuration ID: [Config ID])	P/L	P/L
Delivery Date	Purchasing prints dates only for single shipments. If you provided a promised date, Purchasing prints the promised date. If you provided a need by date, Purchasing prints the need by date. Otherwise, this space is blank.	10	N/A
Delivery Date/Time	Purchasing prints the promised date and need by date, labeled PROMISED: and NEEDED:.	N/A	
Quantity	Purchasing prints the quantity of the item you are ordering if the line type is quantity-based (in number format 99999999 with any existing decimal places, portrait and landscape).	P/L	P/L
Unit (PDF: UOM)	Purchasing prints the item unit of measure for quantity-based items.	4	4
Unit Price (PDF: Unit Price (Curr))	Purchasing prints the item unit price if the line type is quantity-based (in number format 99999999999 with any existing decimal places in the precision associated with the currency, portrait and landscape)	P/L	P/L

Field	Description	Text PO	PDF PO
Extension (PDF: Amount (Curr))	Purchasing prints the total amount of the line. This number is the product of the quantity and unit price. (in number format 999999999999 with any existing decimal places in the precision associated with the currency, portrait and landscape). For amount-based line types, Purchasing prints the price extension only for single shipments.	P/L	P/L
Tax	For single shipments, Purchasing prints Y or N to indicate whether this is a taxable item.	1	1
UN Number	If you associate a UN number with a purchase order line, Purchasing prints <b>UN Number:</b> [UN number and description]. The UN number and description can contain up to 240 characters. Purchasing prints 87 characters per line for landscape orientation (60 for portrait) and automatically wraps to the next line. See: Purchasing Hazardous Materials, page 1-50.	P/L	P/L
Hazard Class	If you associate a hazard class with a purchase order line, Purchasing prints <b>Hazard Class:</b> [hazard class name]. Purchasing prints up to 87 characters per line for landscape orientation (60 for portrait). See: Purchasing Hazardous Materials, page 1-50.	P/L	P/L
Contractor Name	For temporary labor orders; the contractor's name, start date, and end date.	N/A	
Price Differentials	For temporary labor orders, the price differentials for this purchase order.	N/A	

After printing the first line of the purchase order, Purchasing prints the following if they pertain to the purchase order:

- Brief Supplier Line Note
- Long Supplier Line Notes
- Agreement Number References
- **This PO line references your Quotation #:** [quotation number]



## Standard and Planned Purchase Order Shipments

After printing each line, Purchasing prints the following shipment information:

- **o** (In the text format, this symbol indicates a distinct shipment)
- **SHIP TO:** [ship to address]. If the ship to address is the same as the one for the purchase order header, Purchasing prints **Address at top of page** directly below the **SHIP TO:** note without printing the address again. This address contains up to 3 lines of address. On line 4, Purchasing prints the city, state (or province), state, and zip code. On line 5, Purchasing prints the country. (35 characters for lines 1 through 5, portrait and landscape)

After printing the bullet and address to signify a new shipment, Purchasing prints the following information:

**Tip:** N/A indicates not available. P/L indicates differences between portrait and landscape versions, see the description for details.

Field	Description	Text PO	PDF PO
Delivery Date	If you provided a promised date, Purchasing prints the promised date. If you provided a need by date, Purchasing prints the need by date. Otherwise, this space is blank.	10	N/A
Delivery Date/Time	Purchasing prints the promised date and need by date, labeled PROMISED: and NEEDED:.	N/A	A
Quantity	Purchasing prints the quantity of the item you are ordering for quantity-based items (in number format 999999999 with any existing decimal places, portrait and landscape).	P/L	P/L
Unit (PDF: UOM)	Purchasing prints the item unit of measure for quantity-based items.	4	4
Extension (PDF: Amount (Curr))	For multiple shipments of amount-based line types, Purchasing prints the total amount of the line. This number is the product of the quantity and item price override. (in number format 9999999999999 with any existing decimal places in the precision associated with the currency, portrait and landscape)	P/L	P/L

Field	Description	Tax t PO	PD F PO
Tax	Purchasing prints Y or N to indicate whether this is a taxable item. For amount-based line types, Purchasing prints the tax flag only for multiple shipments.	1	1
Customer Name	For drop ship orders, the customer name. Purchasing prints this as: Contractor Name: [Last Name, Title First Name], Start Date: [DD-MMM-YYYY] End Date: [DD-MMM-YYYY].	N/ A	
Customer Contact	For drop ship orders; the customer contact name, phone number, fax number, and e-mail address.	N/ A	

If you cancelled a shipment, Purchasing prints the following information:

- **This shipment CANCELLED on:** [date]
- **Original shipment quantity:** [quantity]
- **Quantity CANCELLED:** [quantity]

### Standard and Planned Purchase Order Distributions

After printing each shipment, Purchasing prints the following distribution information:

- **DELIVER TO:**
- [Last Name], [First Name] [Middle Initial] ([quantity ordered]) if you provided a requestor name on your purchase order distribution and if there is more than one distribution. (54 characters, portrait and landscape)

For temp labor and service line types, Purchasing prints [Last Name, Title First Name] [E-mail]

Field	Description	Te xt PO	PD F PO
Ship Method	For drop ship orders, the shipping method.	N/ A	

Field	Description	Text PO	PDF PO
Shipping Instructions	For drop ship orders, the shipping instructions.	N/A	
Packing Instructions	For drop ship orders, the packing instructions.	N/A	
Customer PO	For drop ship orders; Purchasing prints: Customer PO Number: [customer's purchase order number], Line Number: [customer's line number], Shipment Number: [customer's shipment number].	N/A	
Customer Item Description	For drop ship orders, the customer's item description.	N/A	

## Agreement/Release Components

### Blanket/Contract Purchase Agreement Header

Purchasing prints the following header information if it pertains to the purchase order:

- Brief Supplier Note
- Long Supplier Notes
- Document Title
- Effective Dates:
  - For the text format Purchasing prints **EFFECTIVE FROM** [start effective date] **TO** [end effective date]. If you provide an effective start date without an effective end date, Purchasing prints only **EFFECTIVE FROM** [start effective date]. If you provide an effective end date without an effective start date, Purchasing prints only **EFFECTIVE TO** [end effective date].
  - For the PDF format Purchasing prints Effective Start Date and Effective End Date in the header.
- Amount Agreed:
  - Text is Total agreement amount: [amount agreed]
  - PDF is Amount Agreed (Curr)

- **This purchase order CANCELLED on:** [date]
- **CONFIRMATION -- DO NOT DUPLICATE**
- **All prices and amounts on this order are expressed in** [foreign currency].

**Blanket Purchase Agreement Lines**

After printing the header information, Purchasing prints the following line information:

**Tip:** N/A indicates not available. P/L indicates differences between portrait and landscape versions, see the description for details.

Field	Description	Text PO	PDF PO
Line	Purchasing prints the purchase agreement line number		
Item Number/ Description (PDF: Part Number/Description)	Purchasing prints your item number first. If you have an item revision number, Purchasing prints [revision number]. If you specify a supplier item number, Purchasing prints (Your #: [supplier item number]) on the next line. Purchasing then prints the item description on the following line. (portrait - wraps after 23 characters per line, landscape - wraps after 45 characters per line) (In PDF Purchasing also includes the Supplier Configuration ID: [Config ID])	P/L	P/L
Quantity	Purchasing prints the quantity committed of the item you are ordering for quantity-based items (in number format 999999999 with any existing decimal places, portrait and landscape)	P/L	P/L
Unit (PDF: UOM)	Purchasing prints the item unit of measure for quantity-based items.	4	4
Unit Price	Purchasing prints the item unit price for quantity-based items (in number format 999999999999 with any existing decimal places in the precision associated with the currency, portrait and landscape)	P/L	P/L

Field	Description	Text PO	PDF PO
Extension (PDF: Amount (Curr))	Purchasing prints the total amount committed for the line. This number is the product of the quantity and unit price. (in number format 999999999999 with any existing decimal places in the precision associated with the currency, portrait and landscape). For amount-based line types, Purchasing prints the price extension only for single shipments.	P/L	P/L
Expires On	Purchasing prints the Expiration Date.	N/A	12

After printing the first line of the purchase order, Purchasing prints the following information if it pertains to the purchase order:

- **UN Number:** [UN number and description, page 8-12]
- **Hazard Class:** [hazard class name, page 8-12]
- **This purchase order line CANCELLED on:** [date]
- Brief Supplier Line Note
- Long Supplier Line Notes
- **This PO line references your Quotation #:** [quotation number]

#### Blanket Purchase Agreement Price Breaks

After printing each line, Purchasing prints the following price break information:

- For the text version Purchasing prints the price break information on a single line beginning with **o SHIP TO:** followed by the unit price, the unit of measure, and the price break quantity. For details on how these are formatted see: Purchase Order Shipments, page 8-13.

Purchasing then prints the ship to address directly below the SHIP TO: note without printing the address again. This address contains up to 3 lines of address. On line 4, Purchasing prints the city, state (or province), state, and zip code. On line 5, Purchasing prints the country. (35 characters for lines 1 through 5, portrait and landscape)

- For the PDF version Purchasing prints the price break information starting with the title Price Break: followed by the price break quantity, unit of measure, and unit

price. For details on how these are formatted see: Purchase Order Shipments, page 8-13.

Purchasing then prints the ship to address directly below the Price Break: note without printing the address again. This address contains up to 3 lines of address. On line 4, Purchasing prints the city, state (or province), state, and zip code. On line 5, Purchasing prints the country. (35 characters for lines 1 through 5, portrait and landscape)

### Blanket Purchase Agreement Release Header

Purchasing prints the following header information if it pertains to the release:

- Brief Supplier Note from Blanket Purchase Agreement
- Long Supplier Note from Blanket Purchase Agreement
- **BLANKET AGREEMENT RELEASE** (for blanket releases)
- **PLANNED PURCHASE ORDER RELEASE** (for scheduled releases)
- **This release CANCELLED on:** [date]
- **All prices and amounts on this order are expressed in** [foreign currency].

**Note:** Planned purchase orders are not supported in PDF format.

### Blanket Purchase Agreement Release Lines

After printing the header information, Purchasing prints the following line information:

**Tip:** N/A indicates not available. P/L indicates differences between portrait and landscape versions, see the description for details.

Field	Description	Text	PD
		PO	PO
Line	Purchasing prints the purchase order line number		

Field	Description	Text PO	PDF PO
Item Number/ Description (PDF: Part Number/Description)	Purchasing prints your item number first. If you have an item revision number, Purchasing prints [revision number]. If you specify a supplier item number, Purchasing prints (Your #: [supplier item number]) for text or (Supplier Item: [Supplier item number]) for PDF on the next line. Purchasing then prints the item description on the following line. (portrait - wraps after 23 characters per line, landscape - wraps after 45 characters per line) (For PDF Purchasing also includes the Supplier Configuration ID: [Config ID])	P/L	P/L
Unit Price	Purchasing prints the item unit price for quantity-based items (in number format 999999999999 with any existing decimal places in the precision associated with the currency, portrait and landscape)	P/L	P/L

After printing the first line of the purchase order, Purchasing prints the following information if it pertains to the purchase order:

- **UN Number:** [UN number and description, page 8-12]
- **Hazard Class:** [hazard class name, page 8-12]
- **This purchase order line CANCELLED on:** [date]
- **Original quantity ordered:** [quantity]
- **Quantity CANCELLED** [quantity]
- Brief Supplier Line Note
- Long Supplier Line Notes
- **This PO line references your Quotation #:** [quotation number]

#### Blanket Purchase Agreement Release Shipments

After printing each line, Purchasing prints the following shipment information:

- **o** (This symbol indicates a distinct shipment)
- **SHIP TO:** [ship to address]. If the ship to address is the same as the purchase order header address, Purchasing prints **Address at top of page** directly below the **SHIP**

**TO:** note without printing the address again. This address contains up to 3 lines of address. On line 4, Purchasing prints the city, state (or province), and zip code. On line 5, Purchasing prints the country. (35 characters for lines 1 through 3, 74 characters for line 4, and 25 characters for line 5, portrait and landscape)

After printing the bullet and address to signify a new shipment, Purchasing prints the following information:

**Tip:** N/A indicates not available. P/L indicates differences between portrait and landscape versions, see the description for details.

Field	Description	Te xt PO	PD F PO
Delivery Date	If you provided a promised date, Purchasing prints the promised date. If you provided a need by date, Purchasing prints the need by date. Otherwise, this space is blank.		N/ A
Delivery Date/Time	Purchasing prints the promised date and need by date, labeled PROMISED: and NEEDED:.	N/ A	
Quantity	Purchasing prints the quantity of the item you are ordering for quantity-based items (in number format 999999999 with any existing decimal places, portrait and landscape)	P/L	P/L
Unit (PDF: UOM)	Purchasing prints the item unit of measure for quantity-based items.	4	4
Unit Price	Purchasing prints the item price override for quantity-based items (in number format 999999999999 with any existing decimal places in the precision associated with the currency, portrait and landscape)	P/L	P/L
Extension	Purchasing prints the total amount of the line. This number is the product of the quantity and item price override. (in number format 99999999999999 with any existing decimal places in the precision associated with the currency, portrait and landscape)	P/L	P/L
Tax	Purchasing prints Y or N to indicate whether this is a taxable item.	1	1
Customer Name	For drop ship orders, the customer name.	N/ A	



Field	Description	Text PO	PDF PO
Customer Contact	For drop ship orders; the customer contact name, phone number, fax number, and e-mail address.	N/A	
Ship Method	For drop ship orders, the shipping method.	N/A	
Shipping Instructions	For drop ship orders, the shipping instructions.	N/A	
Packing Instructions	For drop ship orders, the packing instructions.	N/A	
Customer PO	For drop ship orders; the customer's purchase order number, line number, and shipment number.	N/A	
Customer Item Description	For drop ship orders, the customer's item description.	N/A	

If you cancelled a shipment, Purchasing prints the following information:

- **This shipment CANCELLED on:** [date]
- **Original shipment quantity:** [quantity]
- **Quantity CANCELLED** [quantity]

#### Blanket Purchase Agreement Release Distributions

After printing each shipment, Purchasing prints the following distribution information:

- **DELIVER TO:**
- [Last Name], [First Name] [Middle Initial] ([quantity ordered]) if you name the requestor. **Unspecified** ([quantity ordered]) otherwise. (45 characters, portrait and landscape)

#### Total

Purchasing prints **Continued** at the bottom of every page except for the last page of the purchase order for the text version and **Page x of y** for the PDF version. Purchasing prints the sum total of the purchase order lines on the bottom of the last page.



---

# Receiving

## Overview of Receiving

Purchasing lets you control the items you order through receiving, inspection, transfer, and internal delivery. You can use these features to control the quantity, quality, and internal delivery of the items you receive.

Purchasing provides you with the features you need to satisfy your receipt, inspection, transfer, and delivery needs. You should be able to:

- Use routing controls at the organization, supplier, item, or order level to enforce material movement through receiving. For example, you can require inspection for some items and dock-to-stock receipt for others. See: Receiving Controls, Options, and Profiles, page 9-7.
- Define receiving tolerances at the organization, supplier, item, and order level, with the *lowest* level overriding previous levels. You can define tolerances for receipt quantity, on-time delivery, and receiving location. You can assign looser tolerances to low-value items that you consume at high volumes. You can set enforcement options to ignore, warn the user, or reject transactions that violate the tolerances. See: Receiving Controls, Options, and Profiles, page 9-7.
- Use blind receiving to improve accuracy in the receiving process. With this option, the quantity due for each shipment does not show and quantity control tolerances are ignored. Also, the quantity is not visible in view windows or in reports. However, if you choose to have visible receiving, then your receiving staff can see the quantity due. See: Receiving Controls, Options, and Profiles, page 9-7.
- Use Express Receipt to receive an entire purchase order with a few keystrokes. You can exclude certain lines for express transactions. See: Express Receipts and Receiving Transactions, page 9-23
- Use Advance Shipment Notices (ASNs) to enter receipts in the Enter Receipts

window, reducing data entry time. See: Advance Shipment Notices, page 9-15.

- Use the Cascade function to distribute a given quantity of an item from a single supplier across multiple shipments and distributions. This function is enabled by a Receiving Options checkbox, Allow Cascade Transactions, and is available only when you have specified a source and an item in the Find Expected Receipts window. See: Cascading Receipts and Receiving Transactions, page 9-23.
- Specify match approval levels. You can specify two-, three-, and four-way match approval levels on a purchase order line. Purchasing uses your receiving and inspection information to ensure that you only accept and pay for the items you order, receive, or inspect. Choose the three-way match approval level if you want to receive items before you allow payment. Choose the four-way match approval level if you require inspection and acceptance of receipts before authorizing payment. See: Receiving Controls, Options, and Profiles, page 9-7.
- Print the receiving and inspection documentation you need. For example, you can print Receipt Travelers. Also, you can prepare for incoming receipts by printing the Expected Receipts Report to help you identify items and quantities you expect to receive. You can use this report to plan your work, identify receipts satisfying an urgent demand, and control unexpected receipts. Finally, you can produce summary and detail receiving transaction reports by item, supplier, purchase order number, and/or receiving date range. See: Receiving Reports, page 9-85.
- Import receipts from other Oracle Applications, other non-Oracle systems, barcoded and other electronic receiving sources, and advanced shipment notices (ASN). See Receiving Open Interface, *Oracle Manufacturing APIs and Open Interfaces Manual*.
- Track, update, and record the receipt of intransit and inter-organization shipments.
- Enter different types of receipt transactions based on your organization's needs. For example, you should be able to record in one transaction a direct receipt of inventory items into inventory.
- Record receipt of unordered items based on your item, supplier, or organization defaults. For example, if your organization does not allow receipt of unordered items, you should not be able to enter a receipt unless it is matched to an order shipment. See: Unordered Receipts, page 9-34.
- Record receipt of predefined substitute items if you set your receiving options to allow this feature. You define the acceptable substitutes during setup for the items you purchase. See: Receiving Controls, Options, and Profiles, page 9-7.
- Automatically update related supply information, inventory balances, WIP operations, requisition details, and purchase order details while entering a single receiving transaction.

- You can record transfers of inventory items from receiving and inspection to inventory or to the shop floor. You can also record transfers of items to different locations in the receiving and inspection area. For example, you might need to move refrigerated items from the receiving dock into a cold storage area while you are waiting to inspect them. Purchasing lets you record these types of transfers in the same window you use to deliver to stock or expense.
- Record receipts against services and labor. You can enter either the total value of services received, or the amount of services tied to an invoice. For example, you might receive 40 hours of consulting services.
- Receive services, inventory, expense, and outside processing items using one screen. You acknowledge receipt of services by receiving amounts of the service, generally related to receipt of an invoice. You receive inventory items to expense or asset subinventories, you receive expense items to the requestor, and you receive outside processing to the shop floor (designated operations in your manufacturing process).
- Distinguish closed for invoicing from closed for receiving. Purchasing automatically closes your purchase order for receipt when it is fully received. You can manually close partially received purchase orders if you no longer expect any more receipts against them. Close for invoicing and close for receiving are managed using tolerances. You can specify that when you have received a certain percentage of a shipment, Purchasing will close the receipt. This is a soft close, and you can reopen the receipt. Purchasing rolls up closing to the line and header level, and "Closed" information does not show in the Open Purchase Orders Report. Also, if there is a remaining balance, closed quantities are no longer visible as supply scheduled receipts to MRP/ATP.
- Decide how you accrue un-invoiced receipts. For instance, you can accrue receipts perpetually or at period-end for expense items. Purchasing uses perpetual accrual for your inventory and shop floor item receipts. Purchasing and Inventory together provide you with perpetual visibility and control on your accrued liabilities for inventory items. Inventory lets you maintain the value of your inventories on a perpetual basis. And Purchasing automatically records your accrued liability in your general ledger as you enter receiving transactions. Purchasing also provides you with complete visibility and control of your inventories values, accrued liabilities for inventory and non-inventory items, purchase price variances, and invoice price variances. And Purchasing provides you with the information you need to facilitate your period close and your inventory, purchasing, and payables reconciliation process. See: Overview of Receipt Accounting, page 9-86.
- Identify and handle hazardous materials. You can use attachments to provide detailed handling instructions. Purchasing displays hazardous material information in the receiving, transfer, and inspection windows as well as on the Receipt Traveler. See: Purchasing Hazardous Materials, page 1-50.

- Track the quantity and destination of internally delivered items. You know exactly what items you receive and where to deliver them within your organization.
- Define detailed rules for locator within subinventories for the disposition of inventory receipts. See: *Defining Stock Locators, Oracle Inventory User's Guide*
- Track lot and serially controlled items. See: *Control Numbers, page 9-83.*
- Define which of your items require inspection. Purchasing lets you inspect received items before you move the items into stock or deliver them to the requestor. You can accept or reject items and provide detailed information about your inspection results. Purchasing lets you review your inspection results on-line. You can review your inspection results by receipt number, purchase order number, supplier, item, and/or transaction date range. Purchasing also provides summary and detail reports to help you analyze your suppliers' performance. You can produce supplier quality reports by buyer, supplier, and item. You can use the receiving inspection register to review your inspections by receipt. See: *Inspections, page 9-63.*
- Record returns to suppliers. You can return items that are damaged on receipt or that fail your inspection process. If you return items that you have already delivered to inventory, Purchasing automatically updates the inventory stock levels. See: *Returns, page 9-66.*
- Enable the automatic creation of debit memos for Return to Supplier transactions. See: *Debit Memos, page 9-14.*
- Correct receiving transaction errors. Purchasing automatically updates the inventory balances if you correct the quantities of items that have already been moved into inventory. See: *Corrections, page 9-73.*
- Use flexible search criteria to choose receipts for review.
- View receipts details. You should be able to view all the details of your receipt, including matching purchase order and shipment information.
- Perform transactions with minimal effort. For example, you can record a complete receipt with only a few mouse clicks.
- Use attachments throughout the receiving process to more completely identify transactions and to inform users of special requirements. See: *Attaching Notes to Purchasing Documents, page 1-33.*
- Record drop shipments as receipts once the supplier informs you that the drop shipment has been delivered to the customer. See: *Drop Shipments, page 4-114.*
- Receive purchase orders for kanban replenishment requests that were generated from Oracle Inventory. Once you record delivery of a kanban item through the

Receipts or Receiving Transactions windows, Inventory automatically receives a status of Full for the order, indicating that the inventory supply has been replenished. See: Demand for Internal Requisitions, page 3-16.

- Capture exchange rate information on the receipt. See: Entering Receipt Lines, page 9-30.
- Capture and update an item's country of origin on the receipt. See: Entering Receipt Lines, page 9-30.
- Capture movement statistics at the time of receipt. See: Movement Statistics, page 9-6.
- Provide support for electronic signatures for receipts and inspections. See; Inspecting Received Items, page 9-65.
- Enable inventory items to display shortage messages upon receipt, if a shortage exists, so that the responsible person can make the item available with a high priority. See: Material Shortage Alerts and Shortage Notifications, *Oracle Inventory User's Guide*.
- Receive items returned by a customer. See: Return Material Authorizations (RMAs), page 9-13.
- View inbound shipment details using the waybill number.

## Centralized Purchasing for Multiple Receiving Organizations

Purchasing provides complete centralized procurement support. You can leverage your purchasing power by consolidating the requirements from different plants, warehouses, and office sites; yet retain receiving support. You can define separate, autonomous receiving organizations for each of these sites.

Use the Change Organization window (See: Changing Your Organization, *Oracle Master Scheduling/MRP and Supply Chain Planning User's Guide*) to choose your receiving organization. With the Receipts window, you can receive goods only for your current organization. The current organization code is displayed in the title bar of the Receipts window. (See: Entering Receipt Lines, page 9-30.) For supplier shipments, you specify the receiving organization on the purchase order shipment. For intransit inventory shipments, you specify the receiving organization when you create the intransit shipment. For internal requisitions, you use the destination organization to specify the receiving organization. For customer returns, the sales representative specifies the organization on the return material authorization (RMA) in Order Management.

All other receiving windows can access receiving only in your current organization. You also must deliver to the same organization in which you received the goods.

Use the Manage Shipments window to update intransit information to provide accurate

expected delivery date information to better plan your production processes. See: *Managing Shipments*, page 9-81.

## Receiving Locations

Receiving locations are designated areas in which you temporarily store items before you deliver them to their final destinations. Your receiving dock and the area in which items are inspected are receiving locations. See: *Defining Locations*, page 1-18.

Receiving locations are not required when the routing is Direct Receipt, when you are delivering goods to their final locations. However, when the routing is Standard Receipt, you initially receive the items into a receiving location, and you must specify the receiving location. If the routing is Inspection Required, you could transfer the items to an inspection location before delivering them to their destination. If necessary, you can create additional receiving locations, such as a cold storage area where items can be held pending inspection.

## Related Topics

Entering Receipt Header Information, page 9-29

Receiving Transactions, page 9-39

Inspections, page 9-63

## Movement Statistics

You can automate the collection of movement statistics-or information associated with the movement of goods-by following the instructions in: *Setting Up Movement Statistics, Oracle Inventory User's Guide*. (You can set up this functionality in Purchasing even if Inventory is not fully installed.) Once you set up the automatic collection of movement statistics and start the Movement Statistics Processor, the system records movement statistics automatically from the purchase order, internal requisition, return-to-supplier, and drop shipment receipt transactions.

You can also update movement statistics in the Movement Statistics window, which is accessible through the Receiving menu in Purchasing. For example, if the Movement Statistics Exceptions Report shows missing information, you can query and update the movement statistics record in the Movement Statistics window. For information on this window, see: *Entering and Maintaining Movement Statistics, Oracle Inventory User's Guide*.

Once you have set up the automatic collection of movement statistics, run the Movement Statistics Processor to compile all of the material transactions for a defined period to automatically create Intrastat and Extrastat records. Then run the movement statistics reports. See: *Automatically Generating Movement Statistics, Oracle Inventory User's Guide*.

Use e-Commerce Gateway to report the information to government agencies. See: *Running the Movement Statistics Extract Program, Oracle e-Commerce Gateway User's*



*Guide.*

## Related Topics

Overview of Movement Statistics, *Oracle Inventory User's Guide*

## Receiving Controls, Options, and Profiles

Purchasing provides you with all the necessary functionality to set up flexible purchasing and receiving controls, control options, and profile options. The profile options can be set at the site, application, responsibility, or user level. The receiving controls and options can be set at one or more of the following levels: order, item, supplier, organization, and system. Controls at any level override those at a higher level. For example, item level controls override supplier controls but are overridden by order controls.

Use the Profile Options window to set profile options for receiving. Use the Receiving Controls window (See: Entering Purchase Order Receiving Controls, page 4-71.) and the More tabbed region in the PO Shipments window (See: Entering Purchase Order Shipments, page 4-67.) to set receiving options at the order level. Use the Item window (See: .Defining Items, *Oracle Inventory User's Guide*) to set receiving options at the item level. Use the Supplier window (See: Suppliers, *Oracle iSupplier Portal Implementation Guide*.) to set receiving options at the supplier level. Use the Receiving Options window (See: Defining Receiving Options, page 1-42.) to set receiving options at the organization level. Use the Purchasing Options window (See: Defining Purchasing Options, page 1-33.) to set receiving options at the system level. You can set the following receiving options:

- Match approval level, which determines whether the items on a purchase order line must be received and/or inspected before the corresponding invoice can be paid. See: Defining Default Options, page 1-38. You can override this option for specific suppliers, items, and orders.
- The Invoice Close % tolerance for your shipments. Purchasing automatically closes a shipment for invoicing if it is within the invoicing closing tolerance at billing, when Payables matches invoices to purchase orders or receipts. See: Defining Default Options, page 1-38. You can override this option for specific items and orders.
- The Receipt Close % tolerance for your shipments. Purchasing automatically closes a shipment for receiving if it is within the receiving closing tolerance at the receiving close point. See: Defining Default Options, page 1-38. Note also that in the Find Expected Receipts form you have the option to include closed purchase orders when you are entering search criteria. You can override this option for specific items and orders. See: Finding Expected Receipts, page 9-25.
- The Receipt Close Point, when the shipment is closed for receiving: Accepted

(passed inspection), Delivered, or Received. See: Defining Control Options, page 1-34.

- Whether expense accrual is on receipt or at period end. See: Defining Accrual Options, page 1-40.
- The default expense AP accrual account. See: Defining Accrual Options, page 1-40.
- Automatic or manual receipt numbering. If you choose Automatic, you can also set the start of the receipt number sequence. This is used with manual receipt numbering for inter-organization direct receipts. See: Defining Numbering Options, page 1-41.
- Alphanumeric or numeric receipt numbering. See: Defining Numbering Options, page 1-41.
- Whether you can receive a defined substitute item instead of the originally ordered item. See: Defining Receiving Options, page 1-42. You can override this option for specific suppliers, items, and orders.
- Whether you can receive unordered items. See: Defining Receiving Options, page 1-42. You can override this option for specific suppliers and items.
- Whether you allow express transactions. See: Defining Receiving Options, page 1-42

Express receipt/delivery allows you to receive/deliver the entire quantity of all selected shipments (except those you specifically omit) without entering specific quantities for each shipment and distribution

- Whether you allow cascade transactions. See: Defining Receiving Options, page 1-42.  
The cascade function lets you distribute a quantity of an item from a single supplier across multiple shipments and distributions.
- Blind receipt. If you choose this option, Purchasing does not enforce quantity tolerances, nor does it display the Quantity Due or the Quantity Ordered for shipments on line or on receiving worksheets. See: Defining Receiving Options, page 1-42.
- Whether goods can be received only to the receiving location that was defined as the ship-to location on the purchase order and whether Purchasing prohibits the transaction, displays a warning message while permitting the transaction, or permits the transaction without a warning. See: Defining Receiving Options, page 1-42. You can override this option for specific suppliers, items, and orders.
- The maximum acceptable over-receipt percentage and whether Purchasing

prohibits the transaction, displays a warning message while permitting the transaction, or permits the transaction without a warning. See: Defining Receiving Options, page 1-42. You can override this option for specific suppliers, items, and orders.

- The number of calendar days before and after the purchase order delivery date that you allow receipt and whether Purchasing prohibits the transaction, displays a warning message while permitting the transaction, or permits the transaction without a warning. See: Defining Receiving Options, page 1-42. You can override this option for specific suppliers, items, and orders.
- The receiving account for your accrual entries. See: Defining Receiving Options, page 1-42.
- The default receipt routing that you assign goods: Direct Delivery, Standard Receipt, or Inspection Required. See: Defining Receiving Options, page 1-42. You can override this option for specific suppliers, items, and orders.
- Whether you can override the destination type at receipt time. This is a profile option (RCV: Allow Routing Override) that you can set at the application, responsibility, or user level. See: Profile Options in Purchasing, page C-1.
- Whether receipt travelers are automatically printed when you perform a receipt or receiving transaction, and match an unordered receipt. This is a profile option (RCV: Print Receipt Traveler) that you can set at the site, application, responsibility, or user level. See: Profile Options in Purchasing, page C-1.
- The processing mode for receiving transactions: Batch, Immediate, or Online. (See Receiving Transaction Processor, page 13-28.) This is a profile option (RCV: Processing Mode) that you can set at the site, application, responsibility, or user level. See: Profile Options in Purchasing, page C-1.
- Whether or not you receive an error message-or are prevented by Purchasing-when you attempt to receive against a purchase order shipment for which an Advance Shipment Notice (ASN) already exists. This is done through an option (ASN Control) in the Receiving Options window. See: Defining Receiving Options, page 1-42. See also: Advance Shipment Notices (ASNs), page 9-15.
- Whether to reject an entire Advance Shipment Notice (ASN) if any ASN line fails validation or processing, or to accept an ASN if at least one ASN line is successful. This is a profile option (RCV: Fail All ASN Lines if One Line Fails). See: Profile Options in Purchasing, page C-1. See also: Advance Shipment Notices (ASNs), page 9-15.
- Whether to automatically receive and deliver an ASN for a drop shipment order. This is a profile option (PO: Automatically Deliver Drop Ship ASNs). See: Profile Options in Purchasing, page C-1. See also: Advance Shipment Notices (ASNs),

**Receiving Controls Matrix**

<b>Control</b>	<b>Purchasing Options Window</b>	<b>Receiving Options Window</b>	<b>Supplier Window</b>	<b>Item Window</b>	<b>PO Shipments Window *</b>	<b>User Profile Window</b>
Match Approval Level (2-, 3-, or 4-way)	X		X	X	X	
Invoice Close Tolerance	X			X	X	
Receipt Close Tolerance	X			X	X	
Receipt Close Point	X					
Expense Accrual Point	X					
Expense AP Accrual Account	X					
ASN Control - None, Reject, Warning		X				

Control	Purchasing Options Window	Receiving Options Window	Supplier Window	Item Window	PO Shipment*s Window	User Profile Window
Receipt Numbering - Auto or manual / alpha or numeric		X				
Allow Substitute Items		X	X	X	X	
Allow Unordered Items		X	X	X		
Allow Express Transactions		X				
Allow Cascade Transactions		X				
Allow Blind Receiving		X				
Enforce Ship-To Location		X	X	X	X	
Overreceipt Tolerance		X	X	X	X	
Early/Late Receipt Tolerance		X	X	X	X	

Control	Purchasing Options Window	Receiving Options Window	Supplier Window	Item Window	PO Shipments Window *	User Profile Window
Receiving Account		X				
Receipt Routing		X	X	X	X	
Allow Routing Override						X
Fail All ASN Lines if One Line Fail						System Profile
Print Receipt Traveler						X
Processing Mode						X

\* Note: Controls are entered through the More tabbed region in the PO Shipments window (See: Entering Purchase Order Shipments, page 4-67) or through the Receiving Controls window (See: Entering Purchase Order Receiving Controls, page 4-71), which is accessible only through the PO Shipments window.

## Receipt Tolerances

You may want to allow over-receipts on items that you use frequently within your organization, and you can prevent misallocation of shipments to incorrect destinations by setting tolerance levels and the control action. You can over-receive for a particular item if the over-receipt quantity is within tolerance, and you can set the control action to allow all over-receipts, permit over-receipts outside the tolerance but issue a warning message, or reject over-receipts outside the tolerance. See: Receiving Controls, Options, and Profiles, page 9-7.

### Example

You order 100 boxes of shelf braces and indicate on the purchase order that this order requires a receipt. You decide to relax the restriction on the receiving tolerance for shelves since shelves are a low cost/high turnover item. You define the receiving

tolerance level for shelves to be 10% but choose to allow receipts over this tolerance level after displaying a warning.

At the receiving dock, the receiving agent receives 111 boxes of shelf braces and enters a receipt for all of them. The receiving agent can accept them all because your system setup allows receipt over tolerance for this item.

Later, you determine that you are not using all the shelf braces you had predicted, and you decide to change the tolerance level to 3% and to not allow receipts over tolerance. In the next shipment, you receive another 111 boxes of shelf braces. Again, the purchase order was for 100 boxes. The receiving agent attempts to receive 111, but Purchasing displays an error message stating that the receipt quantity is over tolerance and does not let the receiving agent record the over receipt. So, this time the receiving agent can receive only 103 and must reject the additional 8.

## Return Material Authorizations (RMAs)

You can use Purchasing's receiving functionality to receive goods returned by your customers. These are goods for which a sales order in Oracle Order Management was created. If the customer wishes to return the goods, the sales representative creates a return material authorization (RMA) authorizing the return. When the return arrives at your receiving dock, you can create a receipt against the RMA as you would any other receipt, inspect the return, return the repaired goods to the customer, and make receiving corrections. Use the Customer tabbed region of the receiving Find windows to search by customer name, item number, or RMA number. See: Finding Expected Receipts, page 9-25.

If an RMA does not exist for a customer return, you can create an unordered receipt while you find out from the sales representative which RMA to use. See: Unordered Receipts, page 9-34. Use the Receiving Returns window to return the item to the customer if a return is not authorized or after the goods have been repaired.

RMAs use the default receipt routing defined in the Receiving Options window. They use the receipt tolerance that was defined in Order Management when the RMA line was created. The RMA reflects the received, or partially received, quantity while the remaining quantity remains open.

Lot and serial numbers are handled for RMAs as they are for any other item or receipt.

You cannot cascade RMA receipts.

### Example

Your company makes computer boards. A sales representative creates sales orders using Order Management and ships the boards to customers. One of your customers receives a shipment of 20 boards, which do not work properly, and calls the sales representative. The sales representative creates an RMA in Order Management authorizing the return of the boards. The RMA line is created with a line type of Return with Receipt of Goods.

When the boards arrive at your receiving dock, you enter the customer name, item number, or RMA number in the Find Expected Receipts window and create a receipt.

Purchasing automatically updates the RMA to reflect the quantity received.

You use the Inspection window to record your inspection of the boards. Inspection confirms that all 20 of the returned boards are defective. You use the Receiving Transactions window to deliver the boards to their final destination. Purchasing automatically updates the RMA with the quantity fulfilled.

See: Overview of Returns, *Oracle Order Management User's Guide*.

## Debit Memos

You can automatically generate debit memos for Return To Supplier transactions if an invoice has been created. To enable this functionality, enable the supplier site as a Pay Site (or indicate an Alternate Pay Site) and select Create Debit Memo from RTS Transaction in the Supplier Sites window. See: Entering Supplier Information, *Oracle iSupplier Portal Implementation Guide*. When you create the return, make sure the Create Debit Memo Option is selected in the Returns window. Once you enable this functionality, a debit memo is created for each return line you enter in the Returns window.

- The debit memo number contains the original receipt number. Self-Billing Invoice numbering affects debit memos. See: Self-Billing Invoices, page 13-19.
- The debit memo is dated with the return transaction date. If this date does not fall within an open period in Oracle Payables, the date defaults to the first open date available in Payables.
- The payment schedule on the debit memo is based on the purchase order payment terms (in the Terms and Conditions window) and the invoice terms defined in Payables.
- The debit memo is calculated by multiplying the returned quantity by the purchase order item unit price. If the purchase order is in a foreign currency, and you perform invoice matching to receipts, Purchasing uses the currency conversion rate at the time of receipt to calculate the unit price.
- The debit memo does not include tax and freight charges.
- If the unit of measure (UOM) on the return in the Returns window differs from the purchase order UOM, Purchasing restates the return quantity on the debit memo in terms of the purchase order UOM.
- If an Advance Shipment Notice (ASN) or an ASN with billing information (ASBN) exists for the receipt, the unit price from the ASN or ASBN is used.
- Purchasing does not automatically include corrections to returns in debit memos; in this case, you need to adjust the debit memo manually. See: Entering Debit/Credit Memos, *Oracle Payables User's Guide*. Purchasing does not create debit memos for



returns against unordered receipts.

- If an invoice has not yet been created for the receiving transaction or if Payment on Receipt already accounted for the return using the Aging Period functionality, a debit memo will not be created. Whenever a debit memo cannot be created, you will receive a notification in the Notifications Summary window.
- Similarly, the Aging Period functionality in Payment on Receipt does not include returns for which a debit memo was already created, so that duplicate debits are not made. See: Payment on Receipt, page 13-16.

You can match the debit memo to the purchase order or receipt. See: Matching Credit/Debit Memos in the Invoices chapter/section of the *Oracle Payables User's Guide*.

## Drop Shipment Receipts

Drop shipment orders are always received with a receipt routing of direct delivery, ignoring the routing indicated on the original purchase order. The receipt and delivery are processed immediately for these orders.

You can have drop shipment ASNs received automatically by setting the profile PO: Automatically Deliver Drop Ship ASNs to Yes. See: Profile Options in Purchasing, page C-1 See also: Advance Shipment Notices (ASNs), page 9-15.

## Receiving Open Interface

Using the receiving open interface, you can import receipts from other Oracle Applications or from non-Oracle systems. The receiving open interface lets you integrate Oracle Purchasing with new or existing applications such as Oracle Warehouse Management. See: Receiving Open Interface, *Oracle Manufacturing APIs and Open Interfaces Manual*.

To use the receiving open interface, your application must load the receiving information into the interface tables and then the Receiving Transaction Processor is run. See: Receiving Transaction Processor, page 13-28.

## Advance Shipment Notices (ASNs)

An Advance Shipment Notice (ASN) is transmitted using Electronic Data Interchange (EDI) or Extensible Markup Language (XML) from a supplier to let the receiving organization know that a shipment is coming. The ASN contains details including shipment date, time, and identification number; packing slip data; freight information; item detail including cumulative received quantities; country of origin; purchase order number; and returnable container information.

Once an ASN is successfully validated, you can use it in the Receipts window to create receipts, reducing data entry time. (A validated ASN is one that contains no errors during data validation in the Receiving Open Interface.)

Suppliers can also send ASNs with billing information. These contain the same information as ASNs plus invoice and tax information. Once an ASN with billing information (also known as an ASBN) is validated in the receiving open interface and imported into Purchasing, an invoice for the shipment is created automatically.

A supplier creates an ASN based on the demand conveyed by the purchasing organization's Purchase Order, Planning Schedule, or Shipping Schedule. If Purchasing detects errors or discrepancies in the ASN at any time, from the time the ASN is sent to the time it is entered as received, an Application Advice, transmitted via EDI, is sent automatically to the supplier. The supplier can then send a corrected ASN.

**Important:** ASNs come from external suppliers only. They cannot be used for internal sales orders sourced from your inventory and generated by internal requisitions.

You can view or cancel an accepted ASN as an intransit shipment in the Manage Shipments window.

You can match invoices to receipts created from ASNs. You can also match ASBN invoices to receipts.

## ASN Process

The ASN process, shown in the next figure, includes the following:

- **A shipment authorization is made** to the supplier in the form of a Purchase Order, Planning Schedule, or Shipping Schedule.
- **The supplier sends the ASN** to the receiving organization at the time of shipment.
- **The ASN is verified in the Receiving Open Interface.** Intransit and purchasing supplies are updated for ASN lines that are successfully validated. For each accepted line on the ASN, intransit supply is increased and purchasing supply is reduced. If the data isn't accepted or if there is an error or discrepancy in the data, an Application Advice, containing the most likely cause of the error, is sent to the supplier. The supplier can then send a corrected (New) ASN.
- **The goods arrive.** You can use the ASN in the Receipts window to create receipts.
- **Shipment-vs.-receipt quantities are compared** during the receipt transaction process. (As an optional step, CUM quantities can be compared if Oracle Supplier Scheduling is installed.) If discrepancies are detected in shipment-vs.-receipt or CUM quantity comparisons, an Application Advice is sent to the supplier.

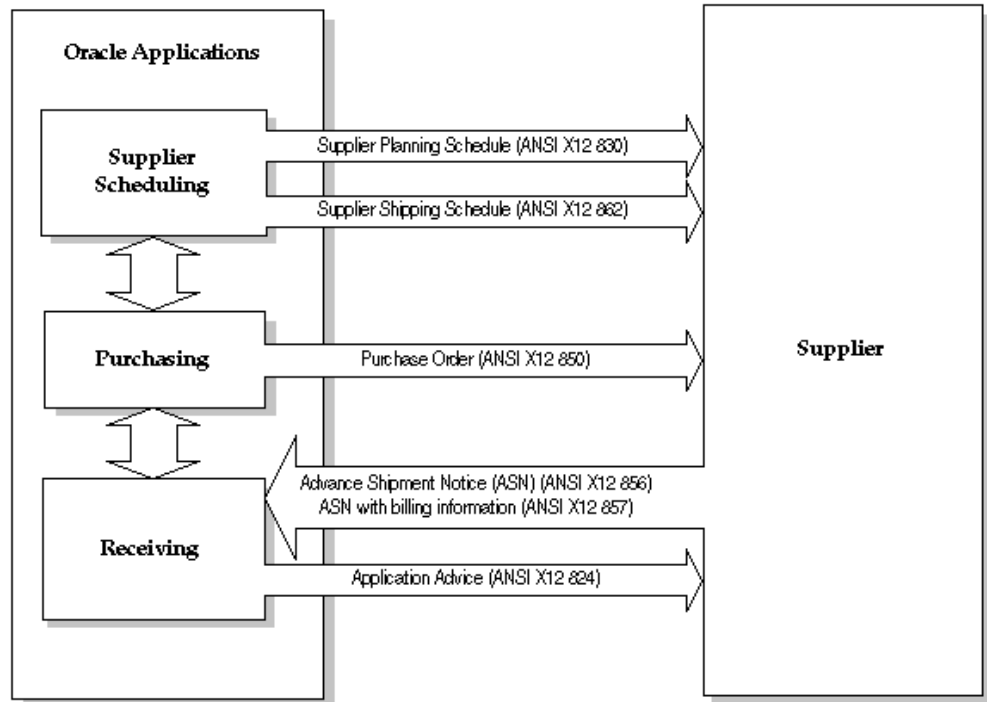

## ASN Receiving Options

There are several receiving options related to ASNs:

- ASN Control option in the Receiving Options window - With this option, you can choose whether or not you receive an error message-or are prevented by Purchasing-when you attempt to receive against a purchase order shipment for which an ASN already exists. See: Defining Receiving Options, page 1-42.
- RCV: Fail All ASN Lines if One Line Fails - With this profile option, you can choose to reject an entire ASN if any ASN line fails validation or processing, or to accept an ASN if at least one ASN line is successful. See: Profile Options in Purchasing, page C-1.
- ASNs for drop shipment orders can be received and delivered automatically with the profile PO: Automatically Deliver Drop Ship ASNs. See: Profile Options in Purchasing, page C-1.

## Application Advices

If an ASN is not accepted or is only partially accepted, errors and discrepancies are electronically conveyed to the supplier in an Application Advice. The Application Advice transmits to the supplier the status (acceptance with errors or rejection) of the ASN, and the severity and description of the errors.

An Application Advice can be sent at several points during the receiving process:

- When the ASN is first sent and contains header or line errors.
- When the quantity received does not match the quantity shipped indicated by the ASN.
- When the receiving organization's newly updated cumulative received quantities do not match the supplier's cumulative shipped quantities.

**Note:** CUM quantity comparisons can be performed only if Oracle Supplier Scheduling is installed.

The supplier can respond to an Application Advice by sending a Cancellation ASN followed by a corrected (New) ASN. The receiving organization can also cancel an ASN manually in the Manage Shipments window.

The following table indicates the appropriate supplier response to particular Application Advices.

ASN Header	ASN Lines	Transaction Status	Supplier Action
Fatal Error	Not Validated	Transaction Rejected	Send New ASN before goods arrive.
Warning or Valid	All lines Warning or Valid (no fatal errors)	Transaction Accepted	Do not send a New ASN, but correct indicated problems on future ASNs.
Warning or Valid	Some Warning Some Valid Some Fatal Error	Transaction Accepted with Some Lines Rejected	Send Cancellation ASN, then send a New (corrected) ASN.
Warning or Valid	All lines had a Fatal Error	Transaction Rejected	Send a New (corrected) ASN before goods arrive.

## Types of ASNs

There are three types of ASNs:

- A **New** ASN is the initial ASN.

An ASN can also contain substitute item information. To accurately handle substitutions, the supplier must indicate both the buyer's original item number and

the buyer's substitute item number on the ASN. With both identifiers available, substitutes can be validated as allowed, and a valid substitute item is referenced against valid purchasing document information.

- A **Cancellation** ASN, once validated, cancels the original (New) ASN *if the original (New) ASN has not yet had a receipt created against it*. The shipment number on the Cancellation ASN is matched to the shipment number on the validated, original (New) ASN.
- A **Test** ASN is sent by the supplier usually to make sure the ASN transmission works between you and your supplier. A Test ASN is verified as if it were a New ASN and generates an outbound Application Advice if necessary. A Test ASN is not available for creating a receipt against it and is not visible as inbound supply.

**Note:** A validated ASN, as described above, is one that contains no errors during data validation in the Receiving Open Interface.

## ASNs and CUM Management

You can perform CUM management under the following conditions:

- Oracle Supplier Scheduling is installed and CUM Accounting is enabled for the ship-to organization.
- The ASN item or items are defined in the Approved Supplier List.
- The items are sourced from the supplier using a Supply Agreement Blanket Purchase Order.

The CUM is the total quantity received from a supplier site, for a particular item, within a CUM period. When an ASN is used during receiving and Supplier Scheduling is installed, the updated CUM is compared to the supplier's CUM. Any discrepancy transmits an Application Advice to the supplier. For more information about CUM management, see: CUM Management, *Oracle Supplier Scheduling User's Guide*.

## ASNs and Supply

For each accepted line on the accepted ASN, intransit supply quantity is automatically increased and purchasing supply quantity is automatically reduced by the shipment quantity specified in the ASN.

When an accepted ASN is cancelled or a corrected ASN is sent, corresponding changes are also made to purchasing and intransit supply. (A supplier can send a Cancellation ASN or you can cancel the ASN in the Manage Shipments window.)

The table below shows, for each action you perform with an ASN, the movement of the quantity on the ASN between the various categories of supply.

<b>ASN Action</b>	<b>Purchasing Supply</b>	<b>Intransit Supply</b>	<b>Inventory</b>
Accept the New ASN	Reduced for accepted lines only	Increased for accepted lines only	
Accept the Cancellation ASN	Increased for all accepted lines on New ASN	Reduced for all accepted lines on New ASN	
Receive item when the item is indicated on an ASN line		Reduced	Increased
Receive item when the item is not indicated on an ASN line	Reduced		Increased
Increase receipt quantity before the ASN is closed		Reduced	Increased
Increase receipt quantity after the ASN is closed	Reduced		Increased
Decrease receipt quantity before the ASN is closed		Increased	Reduced
Decrease receipt quantity after the ASN is closed	Increased		Reduced
Return item(s) to the supplier before the ASN is closed		Increased	Reduced
Return item(s) to the supplier after the ASN is closed	Increased		Reduced

ASN Action	Purchasing Supply	Intransit Supply	Inventory
Close the Purchase Order while an ASN for that purchase order is open	Reduced	Reduced	

## Related Topics

Entering Receipt Lines, page 9-30

Managing Shipments, page 9-81

Profile Options in Purchasing, page C-1

Advanced Shipment Notice Discrepant Receipts Report, page 11-3

Receiving Interface Errors Report, page 11-67

*Oracle Manufacturing, Distribution, Sales and Service Open Interfaces Manual*

*Oracle e-Commerce Gateway Implementation Manual*

## Managing Receipts

### Using the Find Expected Receipts Window

When you enter a receipt, you first use the Find Expected Receipts window to locate the source document for the receipt: a shipment from a supplier based on a purchase order, a shipment from inventory backed by an internal sales order generated by an internal requisition, an intransit shipment within your inventory, or a return from a customer based on a return material authorization (RMA).

### Receiving Shipments

Once you have entered your search criteria, you move to the Receipts window, where all the supplier shipments and inter-organization shipments corresponding to your search criteria are displayed. You can receive goods into a receiving location or to their final destination. When you receive goods into a receiving location, you then use the Receiving Transactions window to optionally inspect and/or transfer receipts between receiving locations before you deliver the receipts to their final destination specified on the source document. You can also receive and deliver to a final destination in one transaction using the Receipts window. You can either use Express Receipt to receive all quantities as shipped, or you can enter specific receipt quantities for shipments. You can modify information, such as the receipt number and packing slip number. When suppliers have consolidated orders onto a single shipment, you can use the Cascade

function to allocate the shipment across orders during entry of receipts.

If the RCV: Print Receipt Travelerprofile option is set to Yes, receipt travelers are printed automatically when you perform receipts or receiving transactions. See: Profile Options in Purchasing, page C-1.

You can also record the receipt of substitute and unordered items. Purchasing records the shipment for the unordered items when you enter the receipt. You cannot perform receiving transactions upon the receipt until you match it to an order. See: Matching Unordered Receipts, page 9-36

## Related Topics

Finding Expected Receipts, page 9-25

Express Receipts and Receiving Transactions, page 9-23

Cascading Receipts and Receiving Transactions, page 9-23

Unordered Receipts, page 9-34

Receiving Transactions, page 9-39

Return Material Authorizations (RMAs), page 9-13

## Multiple Distributions

If you're familiar with the previous release of Purchasing, you may remember you had to use a separate screen when entering receipts for purchase orders with multiple distributions. In the current release of Purchasing, you can explode a single shipment into its component distributions in the Receipts window.

When you initially query up a shipment line that has multiple distributions, there will be a + icon to the right of the UOM field for all lines with a Destination Type of Multiple. Shipment lines for which there is only a single distribution will not have the + icon. You can click on the + icon to expand the line into multiple lines, one for each distribution. The original shipment line will appear grey and will not be updatable. The + icon on that line will change to a - icon. Click on the - icon to end the display of the expanded lines.

You can distribute the available quantity across the expanded lines, but you cannot distribute more than the available quantity shown in the parent shipment quantity column. Also, you can enter and maintain line information only in the expanded lines.

If the default routing is direct receipt and routing override is not enabled, you can explode the line and transact the receipt at the distribution level, but you cannot change any of the values on that line. If the default routing is standard receipt and routing override is enabled and there are multiple destinations, Purchasing displays the destination type Receiving and the + icon is not present. If you want to override the routing and send it to final, you must first change the destination type to Multiple. Then the + icon will appear, and you can expand to see all of the distribution lines and change any or all to have a destination type of final.



## Cascading Receipts and Receiving Transactions

The Cascade function facilitates the distribution of a given quantity of an item from a single supplier across multiple shipments and distributions. This function is available in the Receipts window if you have specified a Supplier and Item in the Find Expected Receipts window and if Allow Cascade Transactions is enabled in the Receiving Options window. In the Receiving Transactions window, the cascade function is available for deliveries if you have specified an Item in the Find Receiving Transactions window. Performing any manual transaction in a line disables the Cascade button, and it is not enabled until you have again selected the Find button in the appropriate Find window.

When you select the Cascade button, Purchasing displays the Cascade Details window in which you must enter the cascade quantity and the unit of measure. When you select the OK button, the cascade process begins.

The process starts at the first displayed line and allocates the supply available to receive/deliver to that line from the cascade quantity you entered. The process continues to the next line and again allocates the quantity available to receive/deliver, continuing until either the process reaches the last queried line or the cascade quantity is exhausted. Since the lines are displayed in order by promised date/need-by date, the process operates as a First In/First Out procedure. If you entered a cascade quantity larger than the quantity available to receive/deliver, Purchasing displays a dialog window explaining that the process could allocate only so many. If the quantity available to receive/deliver is greater than the cascade quantity, the last receipt/delivery may be partial. To clearly indicate that the cascade quantity has been exhausted, Purchasing displays a transaction quantity of 0 for the remaining lines.

The cascade function does not modify any destination information; it uses the information defined by the routing and defaulted from the shipment.

If a given shipment line has multiple distributions and the default routing for that line is direct receipt, the cascade process explodes the line and allocates the quantity available on the shipment line to the component distributions based on the supply available for the distribution. If you have over distributed a given line, Purchasing allocates all remaining supply for the shipment to the last distribution. If you have over delivered the transactions with prior receipts or transactions, then the process may fill the lines with undesired values, but you can reallocate in this situation once the cascade process is complete.

Record validation is disabled during the cascade process to facilitate the running of the process, but all lines are validated when you save them. Quantities are applied to lines in the expectation that you will transact the line as the default routing intended. However, you can manually override these values.

## Express Receipts and Receiving Transactions

The express function is a quick method of entering receipts and receiving transactions.

This function is available in the Receipts window if you have specified or inferred a source in the Find Expected Receipts window. (The source would be inferred if you entered, for example, a purchase order number.) In the Receiving Transactions window, the express function is available for deliveries regardless of your search criteria in the Find Receiving Transactions window. Performing any manual action in a line disables the Express button, and it is not enabled until you have again selected the Find button.

When you select the Express button in the Receipts window, Purchasing displays the Express Details window in which you must enter the destination: Final Destination or Receiving location. Note that this action is dependent on the profile RCV: Allow Routing Override. When you select the OK button in the Express Details window, all lines are selected and the Express button changes to Unexpress. When you select the Express button in the Receiving Transactions window, all lines are selected and the Express button changes to Unexpress. In either case, you can select the Unexpress button to return to manual mode. Otherwise, you can deselect lines to omit them from express processing and then save your work to initiate express processing.

- You cannot perform data collection using Oracle Quality when you select the Express button in the Receiving Transactions window. See: Receiving Transactions, page 9-39.
- Express receiving does not support entering Descriptive Flexfield segment values.

The express processor performs validation and rejects lines based on the following criteria:

- the item revision/subinventory/locator is required and not obtainable as a default from the item definition and the destination is Final
- the early/late receipt date tolerance is exceeded and the exception control is Reject
- lot/serial information is required
- ship-to location is not available and the destination is Receiving
- location is not available for Expense destination type and the destination is Final Destination
- purchase order supplier and receipt header supplier do not match
- other receipts are pending for the specified shipment

When validation processing is complete, Purchasing displays a dialog telling you how many lines passed validation and how many failed and are still available to receive manually.

## Related Topics

Entering Express Receipts, page 9-25

## Entering Express Receipts

Use the Receipts window to enter express receipts.

### To find source documents:

1. Navigate to the Find Expected Receipts window.
2. Enter search criteria to find the source documents for which you want to enter express receipts. You must include the supplier or organization in the source criteria.
3. Select the Find button to display the Receipts window with line(s) available for receipt displayed in the Lines tabbed region.

### To enter express receipts:

1. Select the Express button to open the Express Details window.
2. Select the Destination Type: Final Destination or Receiving location.
3. Select the OK button. This changes the Express button to Unexpress and selects all the lines for express receipt.
4. Optionally deselect individual lines to omit them from the express receipt.
5. Save your work to begin express receipt validation processing.

## Related Topics

Express Receipts and Receiving Transactions, page 9-23

Finding Expected Receipts, page 9-25

Entering Receipt Lines, page 9-30

## Finding Expected Receipts

Use the Find Expected Receipts window to find source documents for which you can enter receipts. Use the Supplier and Internal tabbed region to search for Purchasing documents. If Order Management is installed, use the Customer tabbed region to search for customer return material authorizations (RMAs).

### To find expected receipts in the Supplier and Internal tabbed region:

1. Navigate to the Find Expected Receipts window by selecting Receipts from the menu.

2. Select the Supplier and Internal tabbed region.
3. Select the Operating Unit for this search.
4. Specify any of the following, optional search criteria:
  - Select the receipt Source Type for the search:
    - Internal:* An internal order generated from an internal requisition and sourced from your inventory, or an intransit inventory shipment. If you choose this option, the following fields are disabled: PO Number, Release, Line, Shipment, and Include Closed POs.
    - Supplier:* A purchase order sourced from a supplier. If you choose this option, the Requisition Number and requisition Line number fields are disabled.
    - All:* Internal- and supplier-sourced documents.
  - For a Supplier source type, enter the Purchase Order number. To be available, a purchase order must have at least one approved shipment for which the ship-to organization is the same as the current active organization. If you enter a purchase order number, you can also enter a Release number, Line number, and/or Shipment number for the purchase order. The Release field is applicable

only when you have entered a purchase order number associated with a planned purchase order or a blanket purchase agreement. The list of values in the Release field includes all releases for the specified purchase order that are not final closed.

- For an Internal source type, enter the Requisition Number. If you enter a requisition number, you can also enter a Line number. Available lines are those with the same ship-to organization as the current active organization.
  - In the second Shipment field, enter the shipment number of the Advance Shipment Notice (ASN). See: Advanced Shipment Notices (ASNs), page 9-15.
  - Enter the Supplier. For Source Type Internal, this is the organization. For Source Type Supplier, this is the supplier name, and you can also enter the Supplier Site.
  - Select Include Closed POs to include soft closed purchase orders in the search. By *not* checking Include Closed POs, you exclude purchase orders that have a status of Closed or Closed for Receiving.
  - Enter the Receiving Location.
  - Use the lower tabbed regions to further restrict the search.  
See: To further restrict the search, page 9-28.
5. Select the Find button to initiate the search and display the selected source documents in the Receipts window. Purchasing first opens the Receipt Header window.

**To find expected returns in the Customer tabbed region:**

1. Select the Customer tabbed region in the Find Expected Receipts window.  
  
This region is used for finding items that a customer has returned to your company. When a sales representative creates a sales order in Order Management and ships the item to the customer, you can find and create receipts if the customer returns the item. You create the receipt against a return material authorization (RMA) document, which the sales representative uses to authorize the return.
2. Specify any of the following, optional search criteria:
  - Line type, such as Return with Receipt of Goods, on the RMA. There are different return line types. Search by RMA line type if you want to see all RMA lines with that line type in your receiving organization.
  - RMA Number, which corresponds to the Order Number field on the sales order
  - Line number from the RMA

- Customer returning the item
  - Customer Number
  - Customer Item Number that the customer used to order the item
  - The lower tabbed regions. See: To further restrict the search, page 9-28.
3. Select the Find button to initiate the search and display the selected source documents in the Receipts window.

**To further restrict the search:**

1. Specify any of the following, optional search criteria:
  - In the Item region, you can enter the following search criteria: Item number, Revision number, Category, item Description, and Supplier Item Number. Since the supplier item number is generally the best way you can identify purchase order lines when your supplier does not reference your purchase order number on its shipping documents, you should provide a supplier item number on your purchase order lines.
  - In the Date Ranges region, you can select Due Today to limit the search to receipt lines due on the current date. Otherwise, you can enter a Due By date range. These dates correspond to the Promised Date (or Need-by Date if there is no Promised Date) on the Purchasing document or to the Promise Date (or Request Date if there is no Promise Date) on the RMA.
  - In the Shipment region, you can enter the Container, Truck Number, or Bar Code Label indicated on an Advance Shipment Notice (ASN). See: Advance Shipment Notices (ASNs), page 9-15.
  - In the Destination region, you can select the Requestor, Project, Kanban Card, Task, Deliver-to location, or Job. Using these fields will limit your search results at the distribution level of the order.

**To enter unordered receipts:**

- Select the Unordered button to open the Receipt Header window to enter unordered receipts. See: Entering Unordered Receipts, page 9-36.

**To remove existing search criteria:**

- Select the Clear button in any of the source document search windows to remove existing search criteria.

## Related Topics

Entering Receipt Header Information, page 9-29

Return Material Authorizations (RMAs), page 9-13

## Entering Receipt Header Information

Use the Receipt Header window to enter header information for all types of receipts.

**Note:** If you are entering a receipt against an Advance Shipment Notice (ASN), the header information may already be entered for you if the supplier sending the ASN provided that information. See: *Advanced Shipment Notices (ASNs)*, page 9-15.

### To enter receipt header information:

1. Navigate to the Receipt Header window. Purchasing opens this window when you select Find or Unordered in the Find Expected Receipts window. You can also get to this window by selecting the Header button in the Receipts window.

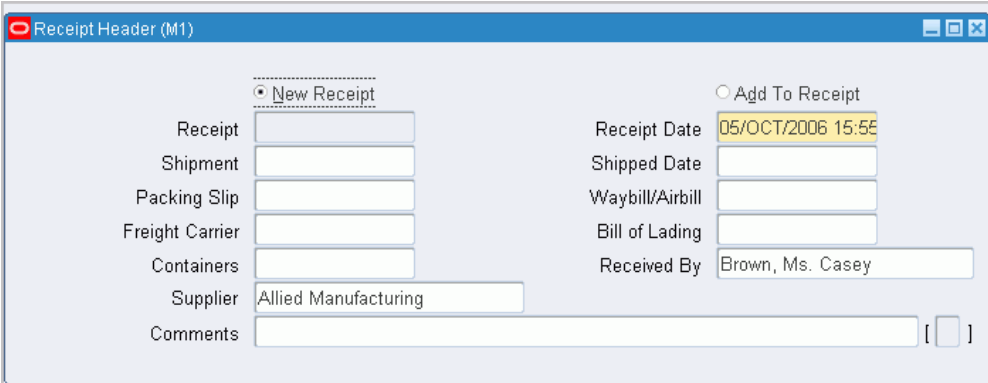

The screenshot shows the 'Receipt Header (M1)' window. It has a title bar with a red close button and window control buttons. The window contains two radio buttons: 'New Receipt' (selected) and 'Add To Receipt'. Below these are two columns of input fields. The left column includes: Receipt (empty), Shipment (empty), Packing Slip (empty), Freight Carrier (empty), Containers (empty), Supplier (Allied Manufacturing), and Comments (empty). The right column includes: Receipt Date (05/OCT/2006 15:55), Shipped Date (empty), Waybill/Airbill (empty), Bill of Lading (empty), and Received By (Brown, Ms. Casey). There are also small square icons at the bottom right of the Comments field.

2. Enter the Receipt number. If automatic receipt numbering is enabled, this field is not enterable when you are creating a new receipt. Purchasing displays the receipt number if the shipment has been partially received.
3. Enter the Receipt date.
4. Enter the Shipment number.
5. Enter the Shipped Date.
6. Enter the Packing Slip number.
7. Enter the Waybill/Airbill number.
8. Enter the Freight Carrier. See: *Defining Freight Carriers, Oracle Shipping Execution Guide*

**Note:** Only the *active* freight carriers are displayed.

9. Enter the Bill of Lading.
10. Enter the number of Containers.
11. Enter the Received By person.
12. Enter the Supplier or Customer. For supplier-sourced shipments, this is the supplier. For inventory-sourced shipments, this is the organization. If the field says Customer, this is the customer returning an item ordered from your company.
13. Enter Comments.
14. Navigate to the Receipts window.

**Note:** You can save the header separately from the lines except for ASN receipts.

**To add lines to an existing receipt:**

- Select the Add To Receipt button to open a list of values showing the receipts to which you can add lines. When you select the receipt to add to, Purchasing displays values from that receipt in the remaining header fields. You can also change the date when the action is Add To Receipt.

## Related Topics

Entering Receipt Lines, page 9-30

## Entering Receipt Lines

Use this window to enter receipt line information.

**To enter receipt line information:**

1. Purchasing opens the Receipts window and displays all shipments that meet the search criteria when you choose the Find button in the Find Expected Receipts window. See: Finding Expected Receipts, page 9-25.



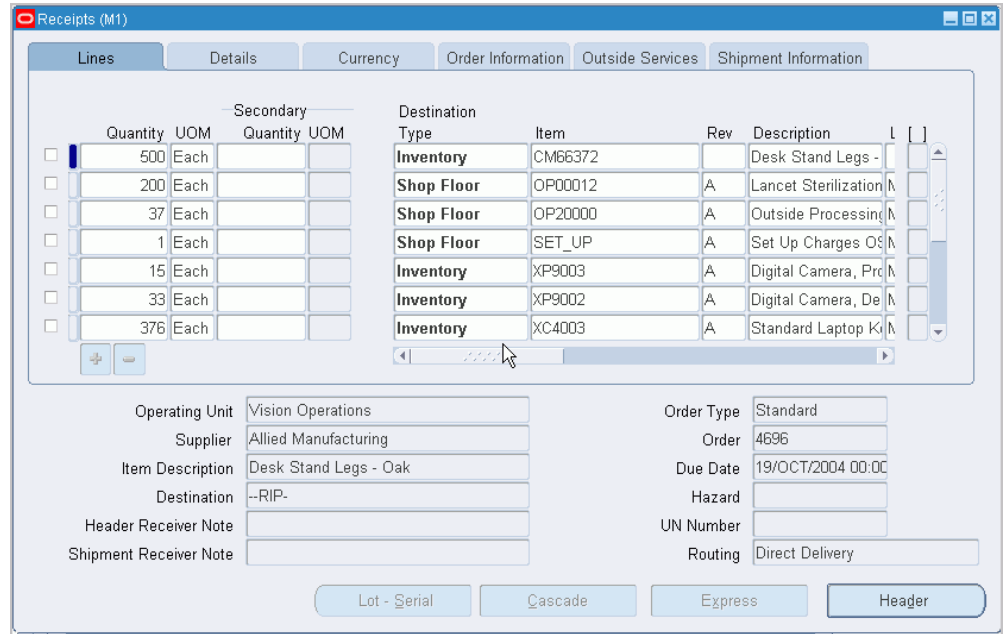

In the lower part of the screen, Purchasing displays the following detail information for the current shipment line: Order Type, Order number, the Supplier or internal organization shipping the item or the Customer returning the item, Due Date, Item Description, Hazard class, Destination, UN Number, Header Receiver Note (from order document header), Shipment Receiver Note, and Routing.

2. Select the line you want to receive.

If the line you select contains information in the ASN Type field, then an Advance Shipment Notice (ASN) exists for that shipment. (You can set an ASN Control option in the Receiving Options window to prevent you from receiving against a purchase order shipment for which an ASN exists. See: Defining Receiving Options, page 1-42.)

If a material shortage exists for the item, a message appears. Displaying shortage messages for certain items is a setup option. From the message, you can view details of where in your organization the demand exists for the item. You can then make the item available with a high priority. See: Viewing Potential Shortages, *Oracle Inventory User's Guide*. See: Material Shortage Alerts and Shortage Notifications, *Oracle Inventory User's Guide*.

3. Purchasing displays the Quantity due for the shipment. If you change the unit of measure, the receipt quantity is adjusted to reflect the new unit of measure. You can override this value if you are recording a partial receipt or an over-receipt. Depending on your receiving options, Purchasing either ignores over-receipts, displays a warning message when you try to receive more items than you ordered, or prevents you from receiving quantities over your receipt tolerance. If you specify blind receiving at the system option level, Purchasing neither performs over-receipt

checking nor displays a Quantity To Receive. If you have fully received a shipment, the receipt quantity displayed is zero, but over-receipt checking will reveal whether you have exceeded the over-receipt tolerance on this shipment.

The information described above applies to an ASN line as well as a purchase order shipment line.

The quantity received on the corresponding purchase order or return material authorization (RMA) is updated to reflect the received quantity.

4. Enter the UOM of the item you are receiving.
5. Enter the Destination Type: Receiving, Expense, Inventory, or Shop Floor. This determines the final destination of the received items.

You can change the Destination Type if the profile option RCV: Allow Routing Override is set to Yes.

6. If the item is under revision control, you must enter a Revision.
7. Enter the receiving Location.
8. Enter the Requestor.
9. For the Inventory destination type, enter the Subinventory into which the goods will be delivered.
10. When the destination type is Inventory and when the item and/or the subinventory have locator control enabled, enter the stock Locator.
11. Optionally choose or change the Country of Origin.

The Country of Origin is the country in which an item is manufactured. The Country of Origin defaults from the ASN if there is one. Otherwise, it defaults from the purchase order shipment.

12. If Oracle Process Manufacturing (OPM) has been implemented, you are a process manufacturing user, and the selected receiving organization is a process organization, then the process fields are enabled. The two process fields are Secondary UOM and Secondary Quantity.

See: Entering OPM process fields, page 3-57.

**Note:** If your organization uses Skip Lot controls, the receipt routing may be automatically changed from inspection required to standard.

**To enter receipt line detail information:**

1. Navigate to the Details tabbed region.

2. Enter the Packing Slip number.
3. Enter the Supplier Lot number.
4. Enter the transaction Reason Code. See: *Defining Transaction Reasons, Oracle Inventory User's Guide*.
5. Enter any comments.
6. Select Receipt Exception if you want to enter a release exception for this receipt.

**To modify exchange rate information:**

1. Navigate to the Currency tabbed region.

You can update exchange rate information on the receipt only if you perform invoice-to-receipt matching (an Invoice Match Option of Receipt is chosen for the shipment in the purchase order Shipments window).

These fields are blank and disabled if there is no exchange rate—that is, if the purchase order is not in a foreign currency.

2. Modify the Rate Date.

If the Invoice Match Option on the purchase order shipment is Purchase Order, the default is the purchase order creation date, and you cannot change it. If the Invoice Match Option is Receipt, the default is today's date. You can change the Rate Date to one that better captures the cost of the item at the appropriate exchange rate. For example, if you are creating a receipt for an item that was actually received into inventory a few days earlier, you could enter the earlier date to apply the rate from that day. You can enter a different Rate Date for different receipt lines. For User rate types, changing the Rate Date does not affect the Rate.

Once you complete the receipt transaction, you cannot correct this exchange rate information later.

3. If the Rate Type is User and the profile option *PO: Allow Rate Override for User Rate Type* is set to Yes, optionally modify the Rate.

The Rate defaults from the purchase order.

**Note:** The Currency and the Rate Type also default from the purchase order, but cannot be changed.

**To view order information:**

- Navigate to the Order Information tabbed region to view the following information for the shipment: Order Type, Number, Release number, order Line number, Shipment number, Project, Task, Kanban Card Number, Charge Account, Supplier, Quantity Ordered, UOM, Due Date, Supplier Item number, Customer Item number, Manufacturer Name, and Source Inspected.

**To view outside processing information:**

- Navigate to the Outside Services tabbed region to view the Job or repetitive Schedule number, the repetitive schedule Line number, the Operation Sequence, and the Department number.

**To view shipment (ASN) information:**

- Navigate to the Shipment Information tabbed region to view information from the Advance Shipment Notice (ASN), if one exists for the shipment. See: Advance Shipment Notices (ASNs), page 9-15.

**To enter control number information:**

- For controlled items, you can select the Lot-Serial button to navigate to the Lot Number and Serial Number windows. See: Lot Control, *Oracle Inventory User's Guide*. See: Serial Number Control, *Oracle Inventory User's Guide*.

**To cascade quantities across shipments and distributions:**

- If you specified a Supplier and Item in the Find Expected Receipts window, and if Allow Cascade Transactions is selected in the Receiving Options window, choose the Cascade button. See: Cascading Receipts and Receiving Transactions, page 9-23.

**To perform an express receipt:**

- Select the Express button to perform an express receipt. See: Entering Express Receipts, page 9-25.

## Related Topics

Entering Receipt Header Information, page 9-29

Cascading Receipts and Receiving Transactions, page 9-23

Express Receipts and Receiving Transactions, page 9-23

Entering Express Receipts, page 9-25

Defining Conversion Rate Types, *Oracle General Ledger User's Guide*

Return Material Authorizations (RMAs), page 9-13

## Unordered Receipts

You can receive items from a supplier when you do not have a corresponding purchase order but want to receive the items so you can track them on the system while you wait for a buyer to decide which purchase order to use. You can receive returned items from a customer that were issued on a sales order in Order Management while you find out from the sales representative which return material authorization (RMA) to use.

First receive the items as Unordered Receipts in the Receipts window. You can create a new receipt or add to an existing receipt for the supplier or customer who shipped the unexpected items. Then perform a standard receipt for the unordered item shipment quantity.

Use the Find Unordered Receipts window to find the receipts or RMAs that are available for matching. Then use the Match Unordered Receipts window to specify the purchase order or RMA number, release, line, and shipment schedule to which you want to match the unordered receipt. Purchasing restricts the list of possible matching purchase orders/releases as follows:

- The purchase order must have the same supplier as the unordered receipt (when matching to RMAs, the RMA must have the same customer as the unordered receipt)
- The purchase order cannot be final closed or cancelled
- The purchase order must have at least one approved shipment in the same organization where you performed the unordered receipt (when matching to RMAs, the receiving organization on the RMA must be the same organization where you performed the unordered receipt)
- Except for receipts for one-time items, the item and the purchasing category on the purchase order (or the item on the RMA) must be the same as the item and purchasing category on the unordered receipt
- The purchase order must have a receipt routing of Standard Receipt, Inspection Required, or none (blank). If the purchase order shipment has a routing of Direct Delivery, the profile option RCV: Allow Routing Override must be set to Yes. This routing requirement also applies to RMAs, which use the routing specified in the Receiving Options window.

You can match *only* to approved shipments. If you cannot locate a valid matching document for your unordered receipt, you can modify and approve an existing purchase order/release or you can create and approve a new purchase order. You can then match to this new, approved shipment. For RMAs, you can ask the sales representative to create one in Order Management, and then you can match to the new RMA or RMA line.

When you choose a shipment or RMA line, Purchasing performs receiving control checks of the quantity received tolerance and due date threshold.

If the RCV: Print Receipt Traveler profile option is set to Yes, receipt travelers are printed automatically when you match unordered receipts.

## Related Topics

Entering Unordered Receipts, page 9-36

Matching Unordered Receipts, page 9-36

Profile Options in Purchasing, page C-1

Return Material Authorizations (RMAs), page 9-13

## Entering Unordered Receipts

### To enter unordered receipts:

1. Select Receipts on the menu to open the Find Expected Receipts window. See: Finding Expected Receipts, page 9-25.
2. Choose the appropriate tabbed region.

Choose the Supplier and Internal tabbed region to create an unordered receipt that will later be matched to a purchase order or release. Choose the Customer tabbed region to create an unordered receipt that will later be matched to a return material authorization (RMA). An RMA is created in Order Management to authorize a customer's returning an item to your company.

**Important:** It is important to choose the correct tabbed region. For example, if the Customer tab is selected, later when you enter the receipt you will see only customer information in the lists of values.

3. Select the Unordered button to open the Receipt Header window.
4. Enter receipt header information. See: Entering Receipt Header Information, page 9-29.
5. Enter receipt line information. See: Entering Receipt Lines, page 9-30.
6. Save your work.

## Related Topics

Unordered Receipts, page 9-34

Matching Unordered Receipts, page 9-36

Return Material Authorizations (RMAs), page 9-13

## Matching Unordered Receipts

Use this window to match unordered receipts to purchase order shipments.

### To select unordered receipts for matching:

1. Navigate to the Find Unordered Receipts window by selecting Match Unordered Receipts on the menu.

The screenshot shows a software window titled "Find Unordered Receipts (V1)". It features a list of search criteria on the left, each with an adjacent text input field:

- Receipt
- Supplier
- Customer
- Item (with a dropdown arrow)
- Description
- Category
- Supplier Item
- Receiver
- Receiving Location
- Transaction Dates (with a date range selector)

At the bottom right of the window, there are two buttons: "Clear" and "Find".

2. Enter any of the following as selection criteria for the receipts you want to match to purchase orders or return material authorizations (RMAs): Receipt Number, Supplier or Customer name, Item, Category, Supplier Item Number, Receiver, Transaction Date, Receiving Location, Item Description.
3. Select the Find button. If your selection criteria produce any receipts for matching, the Item Number, Revision, Category, and Supplier or Customer are displayed in the Unordered Receipts block in the Match Unordered Receipts window. The Receipt Number, Quantity Received, Receiving UOM, Deliver To, Receiver, Item Description, Quantity Ordered, Order UOM, Destination, and Supplier Item Number for the current receipt are displayed in the lower part of the window.

**To match unordered receipts:**

1. Navigate to the Match Unordered Receipts window by selecting the Find button in the Find Unordered Receipts window.

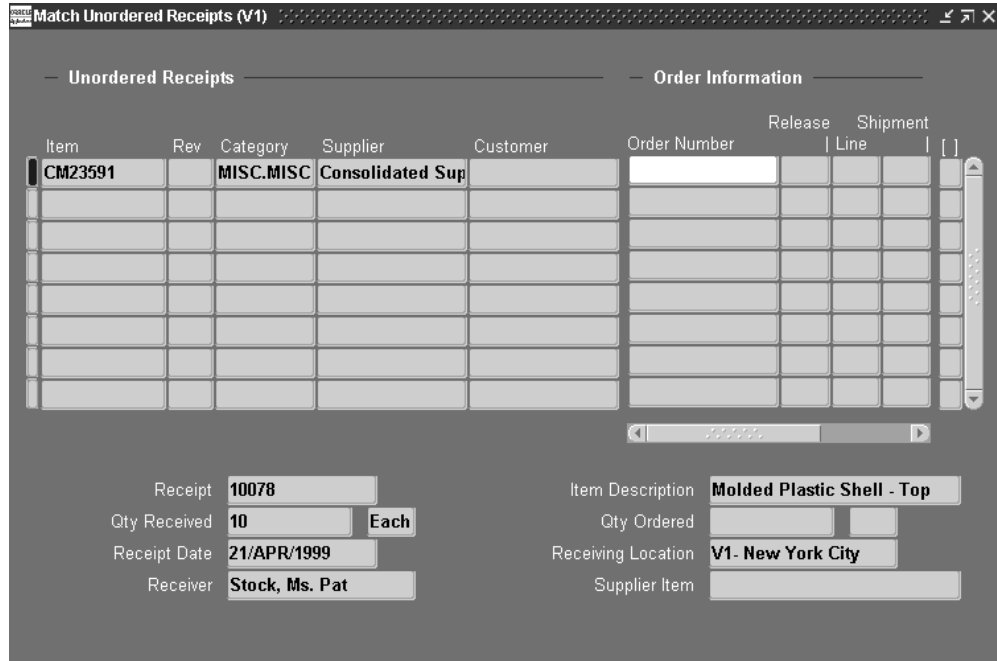

2. In the Order Information block in the Match Unordered Receipts window, enter a purchase order number in the Order Number field. For customer-returned items (a Customer is displayed rather than a Supplier), enter the return material authorization (RMA) number in the Order Number field. You can also choose List of Values from the tool bar to query the purchase order shipments or RMA lines available to match the current unordered receipt. This displays the Order Number, Release, Line, and Shipment for all shipments appropriate for matching. See: Unordered Receipts., page 9-34

**To display receipt header information:**

- Select the View Receipt Header on the Tools menu to display receipt header information.

**To display receipt line information:**

- Select the View Receipt Line on the Tools menu to display receipt line information.

**To display purchase order information:**

- If an Order Number is entered, select View Purchase Orders on the Tools menu to display purchase order header information.

**Related Topics**

Unordered Receipts, page 9-34

Return Material Authorizations (RMAs), page 9-13



## Receiving Transactions

You record inspections, deliveries, and material movements within receiving and inspection by entering receiving transactions. These transactions provide a history that allows you to track an item from its source to its destination.

From the time of receipt, many transactions may be required to record the movement of an item through the receiving and inspection process. For example, after being received, an item can be transferred, inspected, and then delivered. To help you keep track of an item within receiving and inspection, these transactions are linked to each other. You can use the Receiving Transaction Summary (See: Finding Receiving Transactions (Summary), page 9-41) to view an item's transaction history as if it were a family tree with parent and child transactions. A parent transaction can have one or more child transactions, but a child transaction has *only* one parent transaction. In the above example, the receipt transaction is the parent of the transfer transaction, while the transfer transaction is the child of the receipt transaction. Purchasing displays parent transaction information to help you determine the status of the item for which you are entering a transaction. For example, if you are about to transfer an item from Receiving Dock 1 to Inspection Area A, you should verify that the parent transaction's location is Receiving Dock 1. Purchasing also displays the parent transaction's unit of measure and available quantity. Available quantity is significant because you cannot enter a quantity for a current transaction that is greater than the parent transaction's available quantity. For example, if you have received 10, you can inspect only up to a quantity of 10. Purchasing also displays the inspection result for a parent transaction if the given material has been accepted or rejected as part of an inspection. For delivery transactions, you must enter lot/serial/locator information for controlled items. See: Lot Control, *Oracle Inventory User's Guide*. See: Serial Number Control, *Oracle Inventory User's Guide*. See: Defining Stock Locators, *Oracle Inventory User's Guide*.

## Search Criteria

The first step in entering a new receiving transaction is to choose the receipt involved in this transaction. In the Find Receiving Transactions window (See: Finding Receiving Transactions, page 9-55), you can enter a variety of search criteria such as receipt number, current location, various item details, shipment number, purchase order number, and requisition number. Once you have specified search criteria, Purchasing displays the receipts (and previous transactions) in the Receiving Transactions window for which you can process transactions. Information for receipts is based on information from parent transactions that meet your search criteria.

## Express and Cascade Transactions

Purchasing offers two functions to facilitate transaction entry: Express and Cascade. In Express mode, you cannot modify default quantities, but you can record the delivery of many receipts at once. See: Express Receipts and Receiving Transactions, page 9-23. Cascade mode is applicable only for receipts for the same item. In cascade mode,

Purchasing starts with the first receipt and enters deliveries for each subsequent receipt for this item until the cascade quantity is met. See: Cascading Receipts and Receiving Transactions, page 9-23.

## Receiving Transactions Window

You enter all transfer and delivery transactions in the Receiving Transactions window. If you want to perform an inspection transaction, you can open the Inspections window to specify accepted and rejected quantities. See: Inspections, page 9-63.

## Deliveries

Purchasing ensures that you can record deliveries quickly and easily. If you know the purchase order number (or shipment number for internal transactions or RMA number for customer returns to your company), you can simply record the quantity delivered for the appropriate item. If you do not know the purchase order number, you can search using what you know, such as Receipt Number, Supplier, Packing Slip, Category, Item Number or Inspection Required. Purchasing automatically tracks the total quantity delivered to date for a particular receipt.

You can deliver only as many items as you receive. Purchasing lets you easily correct any delivery information.

### Example

Both Jane Tims and Juliet Cunningham submit a requisition for 50 chairs each. The buyer places both requisitions on one purchase order line and indicates that the items require receipt. You receive the 100 chairs and record the receipt in the Receipts window. You see that 50 chairs are for Jane Tims in Building 1, and the other 50 chairs are for Juliet Cunningham in Building 2. In the Transactions window, you deliver 50 chairs to each requestor and record the quantity delivered.

## Oracle Quality

There are two entry points to Oracle Quality from Purchasing if Oracle Quality is installed. Both entry points are in the Receiving Transactions window: the Enter Quality Results option in the Tools menu (or the Quality button on the menu bar) and the Inspect button. The Enter Quality Results menu option and button are available only if a quality collection plan or plans exist for the receiving transaction. When a mandatory collection plan exists for the receiving transaction, quality results data must be entered and saved before you can save your receiving transaction line information. (You optionally define a collection plan as mandatory when you create the collection plan in Oracle Quality. See also: Using Oracle Quality with Oracle Purchasing, *Oracle Quality User's Guide* and Purchasing Versus Quality Inspections, *Oracle Quality User's Guide*.)

You cannot perform data collection using Oracle Quality when you select the Express button in the Receiving Transactions window.

For more information on Oracle Quality and the Inspect button, see: Inspections, page

9-63.

See also: Entering Receiving Transactions, page 9-58.

## Inspection Electronic Signatures

Oracle E-Records is used to provide FDA CFR 21 Part 11 compliance. If this feature is implemented, you can electronically capture signatures regarding inspection acceptance or rejection. See: 21 CFR Part 11 Compliance, ,

## Finding Receiving Transactions (Summary)

Use the Find Receiving Transactions (Summary) window to:

- Access the Receiving Headers Summary window.
- Access the Receiving Transaction Summary window.
- Perform purchase order inquiries at header and line levels.

Use the Supplier and Internal tabbed region to search for Purchasing documents. If Order Management is installed, use the Customer tabbed region to search for customer return material authorizations (RMAs).

### **To enter search criteria in the Supplier and Internal tabbed region:**

1. Navigate to the Receiving Transactions Summary window. The Find Receiving Transactions Summary window appears.

2. Select the Supplier and Internal tabbed region.
3. Select the Operating Unit for this search.
4. Enter the Source Type: Internal, Supplier, or All.
5. Specify any of the following, optional search criteria:
  - Enter the Receipt Number.
  - For source type Supplier, enter the Purchase Order number. If you enter a purchase order number, you can also enter a Release (for blanket purchase agreements), Line, and/or Shipment (for purchase orders) number. For source type Internal, enter the Requisition Number. If you enter a requisition number, you can enter a requisition Line number.
  - In the second Shipment field, enter the shipment number of the Advance Shipment Notice (ASN). See: Advanced Shipment Notices (ASNs), page 9-15.
  - Enter the Supplier. For Source Type Internal, this is the organization. For Source Type Supplier, this is the supplier name, and you can also enter the Supplier Site.

- Use the lower tabbed regions to further define the search. See: To further restrict the search, page 9-43, below.
6. Choose Results Headers (to go to the Receiving Headers Summary window) or Results Transactions (to go to the Receiving Transaction Summary window). Choose Find.

**To enter search criteria in the Customer tabbed region:**

1. Select the Customer tabbed region in the Find Receiving Transactions summary window.

This region is used for finding items that a customer has returned to your company. When a sales representative creates a sales order in Order Management and ships the item to the customer, you can find, create, and view receipt transactions if the customer returns the item. The receipt is created against a return material authorization (RMA) document, which the sales representative uses to authorize the return.

2. Specify any of the following, optional search criteria:
3. Line type, such as Return with Receipt of Goods, on the RMA. There are different return line types. Search by RMA line type if you want to see all RMA lines with that line type in your receiving organization.
4. Receipt Number
5. RMA Number, which corresponds to the Order Number field on the sales order
6. Line number from the RMA
7. Customer returning the item
8. Customer Number
9. Customer Item Number that the customer used to order the item
10. The lower tabbed regions. See: To further restrict the search, page 9-43, below.
11. Choose Results Headers (to go to the Receiving Headers Summary window) or Results Transactions (to go to the Receiving Transaction Summary window). Choose Find.

**To further restrict the search:**

1. Specify any of the following, optional search criteria:
2. In the Item region, you can enter the following search criteria: Item, Rev, Category, Description, and Supplier Item.

3. In the Receipt Details region, you can limit the search by Packing Slip, Receiver, Freight Carrier, and Bill of Lading number.
4. In the Transaction Details region, you can limit the search by entering a range of Transaction Dates and Transaction Type.
5. In the Shipments region, you can enter the Container, Truck Number, or Bar Code Label indicated on an Advance Shipment Notice (ASN). See: Advance Shipment Notices (ASNs), page 9-15.
6. In the Destination region, you can select the Requestor, Project, Kanban Card, Task, Deliver-to location, or Job. Using these fields will limit your search results at the distribution level of the order.

## Related Topics

Using the Receiving Headers Summary Window, page 9-44

Using the Receiving Transaction Summary Window, page 9-45

Return Material Authorizations (RMAs), page 9-13

## Using the Receiving Headers Summary Window

Use the Receiving Headers Summary folder window to:

- View receipt header information.
- Access the Receiving Transaction Summary window to display all receiving transactions for the current header line.

### To display receiving headers information:

1. Navigate to the Receipt Header Details window.
2. Enter or choose information from one of the available fields to locate the record from the Find Receiving Transactions window.
3. Choose Results Headers, then choose Find.

Receipt	Date	Supplier	Supplier Site	Shipment Number	Ship Date	Ship To
114	18-MAR-1998 15	Advanced Network I				
130	04-JUN-1998 14	Star Gate Ltd				
131	16-JUN-1998 13	Consolidated Suppli				
138	03-AUG-1998 16	Consolidated Suppli				
143	04-AUG-1998 11	Office Supplies, Inc.				
146	04-AUG-1998 14	Office Supplies, Inc.				
147	05-AUG-1998 14	Office Supplies, Inc.				
148	05-AUG-1998 14	Office Supplies, Inc.				
149	05-AUG-1998 15	Office Supplies, Inc.				
150	04-FEB-1999 13	Advanced Network I				

- Optionally choose Transactions to view all the records pertaining to the current search criteria.

## Related Topics

Finding Receiving Transactions, page 9-55

Using the Receiving Transaction Summary Window, page 9-45

Customizing the Presentation of Data in a Folder, *Oracle Applications User's Guide*

## Using the Receiving Transaction Summary Window

Use the Receipt Transaction Summary folder window to:

- View receiving transaction information.
- View order information backing the receipt.
- Access the Receipt Header Details window to view receipt header details.

**To display receiving transactions navigate to the Receiving Transaction Summary window:**

- In the Receipt Headers Summary window, select the Transactions button to open the Receipt Transaction Summary window and display all receiving transactions for the receipt on the current line. Alternatively, in the Find Receiving Transactions window, you can select Transactions in the Results region and then select the Find button to display all receiving transactions that meet the search criteria.

Transaction Type	Amount	Unit	Date	Item	Rev	Destination	Receipt	Source
Receive	10	Each	18-MAR	80000		Receiving	114	Supplier
Deliver	10	Each	18-MAR	80000		Inventory	114	Supplier

Order Type	Purchase Order	Order	1076
Source	Advanced Network De	Transaction Date	18-MAR-1998 00:00
Description	Sentinal Multimedia	Hazard	
Destination	Stock, Ms. Pat-Drop Ship-FGI-	UN Number	
Header Receiver Note		Routing	Direct Delivery
Shipment Receiver Note			

Header

As installed, Purchasing can display the following information for each receiving transaction: Transaction Type, transaction Amount, Unit (UOM), transaction Date, Item number, item Revision, Destination type, Location, Person, Subinventory, Locator, Receipt number, Source type, Order Number, order Release, order Line number, Order Shipment, Supplier, Country of Origin, Supplier Site, Order Quantity, Order UOM, Supplier Item Number, Supplier Lot Number, Packing Slip, Reason, Hazard class, UN Number, Secondary UOM, Secondary Quantity, Category, Job, Line, Assembly, Operation Sequence Department, and Receipt Exception.

In the lower part of the screen, Purchasing displays the following information for the purchase order, sales order (for internal requisitions), or return material authorization (RMA) behind the receipt: Order Type (Purchase Order, Inventory, or Return Material Authorization), Source, Item Description, Destination, Header Receiver Note, Shipment Receiver Note, Order number, Transaction Date, Hazard class, UN Number, and Routing.

**To view transaction detail information:**

- Select the record indicator to the left of the transaction to view the transaction details.

**To view receipt header detail information:**

- Select the Header button to open the Receipt Header Details window. See: Using the Receipt Header Details Window, page 9-50.

**To view detail accounting lines:**

- Choose View Accounting from the Tools menu to open the View Receiving



Accounting window. In this window, you can view the detail accounting lines for the transaction in the form of a balanced accounting entry (where debits equal credits). You can also choose to view the detail accounting as t-accounts. See: *Viewing Accounting Lines*, page 9-47.

## Related Topics

*Finding Receiving Transactions*, page 9-55

*Using the Receiving Headers Summary Window*, page 9-44

*Customizing the Presentation of Data in a Folder*, *Oracle Applications User's Guide*

*Return Material Authorizations (RMAs)*, page 9-13

## Viewing Accounting Lines

When you query a receiving transaction in Purchasing, you can choose to view the detail accounting lines for the queried transaction in the form of a balanced accounting entry (where debits equal credits). You can also choose to view the detail accounting as t-accounts. Use these features to see how a transaction will affect the account balances in your general ledger.

### To view accounting lines:

1. Navigate to the Receipt Transaction Summary window.
2. Select the receiving transaction for which you want to view accounting lines.

You can view accounting lines for the following transaction types:

- Receive
- Deliver (to Expense)
- Return to Receiving (from Expense)
- Return to Supplier
- Correct (Receiving Transaction)
- Correct (Return to Receiving from Expense)
- Match

For each transaction type above, you can view accounting lines for the expense items (with a Destination Type of Expense) only if you accrue the expense items upon receipt. You can view accounting lines for inventory items (with a Destination Type of Inventory) from within Oracle Inventory only, not Purchasing. You can view accounting lines for shop floor items (with a Destination Type of Shop Floor) from within Oracle Work in Process only.

**Note:** You cannot view accounting information for receiving transactions created against return material authorizations (RMAs).

3. Choose View Accounting from the Tools menu to open the View Receiving Accounting window.

Credit and Debit are the credit and debit entries from your General Ledger journal entries. Entered Credit and Entered Debit are the credits and debits from the purchase order, if the purchase order is in a foreign currency. Entered Currency is also the purchase order currency, if it differs from the functional currency.

When you select a detailed accounting line, the system displays additional information at the bottom of the View Receiving Accounting window.

See: View Accounting Windows, below.

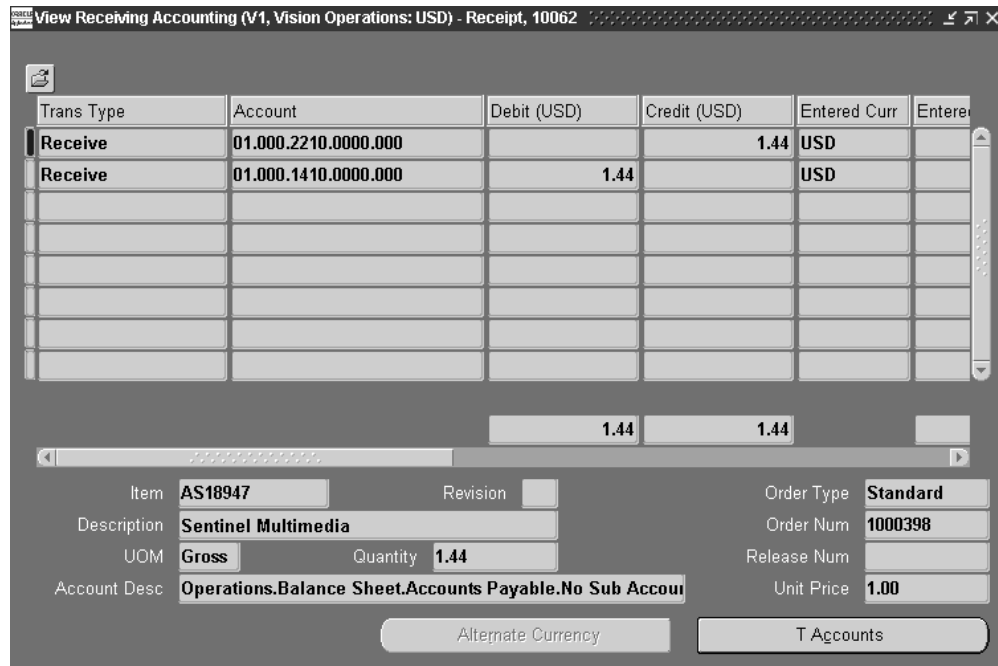

4. (Optional) If your organization uses Multiple Reporting Currencies, choose the Alternate Currency button to view the accounting using an alternate currency. For example, if you are viewing the accounting in your primary functional currency (for example, BEF), you can switch to EUR (reporting functional currency).

From the poplist that appears after you choose the Alternate Currency button, choose the primary or reporting ledger whose transactions you want to view. The View Receiving Accounting window will change to reflect amounts in the appropriate currency for the chosen ledger.

5. (Optional) To view the accounting detail as t-accounts, choose the T-Accounts

button.

See: Viewing T-Accounts, *Oracle General Ledger User's Guide*.

## View Accounting Windows

The first time you open the View Receiving Accounting window, the following information is displayed for the detailed accounting lines:

---

Transaction Type	Entered Credit
Account	Currency Conversion Rate
Debit	Order Line
Credit	Order Shipment
Entered Currency	Order Distribution
Entered Debit	Accounting Date

---

Credit and Debit are the credit and debit entries from your general ledger journal entries, stated in your functional currency. Entered Credit and Entered Debit are the credits and debits in the purchase order currency.

When you select a detailed accounting line, the system displays the following information at the bottom of the View Receiving Accounting window:

---

Item	Account Description
Revision	Order Type
Description	Order Num
UOM	Release Num
Quantity	Unit Price

---

## Customizing the View Accounting Window

The View Receiving Accounting window is a *folder*. You can easily customize the information that is displayed in the window. See: Customizing the Presentation of Data in a Folder, *Oracle Applications User's Guide*.

When customizing the View Receiving Accounting window, you can hide the columns that normally appear in the window and you can choose to display any additional columns that are available.

Following is a list of all the hidden columns that you can choose to display:

---

Account Description	Receipt Num
Comments	Release Num
Currency Conversion Date	Subinventory
Currency Conversion Type	Supplier
Item	Supplier Num
Item Description	Supplier Site
Line Reference	Transaction Date
Order Num	Transferred to GL
Order Type	UOM
Price Override	Unit Price
Quantity	

---

## Related Topics

[Drilling Down to Purchasing from Oracle General Ledger, page 9-61](#)

[Return Material Authorizations \(RMAs\), page 9-13](#)

## Using the Receipt Header Details Window

Use the Receipt Header Details window to:

- View detail information for receipt headers

### To navigate to the Receipt Header Details window:

- In the Receiving Transaction Summary window, select the Header button to open the Receipt Header Details window.

The following information is displayed: Receipt Number, Receipt Date, Shipment Number, Shipped Date, Packing Slip, Waybill/Airbill, Freight Carrier, Bill of

Lading, Number of Containers, Received By, Supplier, and Comments.

**To return to the Receiving Transaction Summary window:**

- Select the Transactions button to return to the Receiving Transaction Summary window.

## **Related Topics**

Using the Receiving Transaction Summary Window, page 9-45

## **Finding Transaction Status Information**

Use the Find Transaction Status window to access the Transaction Status window. You can use this window to review pending transactions before they are processed by the Receiving Transaction Processor. Use the Supplier and Internal tabbed region to search against Purchasing documents. If Order Management is installed, use the Customer tabbed region to search against customer return material authorizations (RMAs).

**To enter search criteria in the Supplier and Internal tabbed region:**

1. Navigate to the Transaction Statuses window. The Find Transaction Statuses window appears.

2. Select the Supplier and Internal tabbed region.
3. Select the Operating Unit for this search.
4. Enter the Source Type: Internal, Supplier, or All.
5. Specify any of the following, optional search criteria:
  - Enter the Receipt Number.
  - For source type Supplier, enter the Purchase Order number. If you enter a purchase order number, you can also enter a Release (for blanket purchase agreements), Line, and/or Shipment (for purchase orders) number for the purchase order.
  - For source type Internal, enter the Requisition Number. If you enter a requisition number, you can enter a requisition Line number.
  - In the second Shipment field, enter the shipment number of the Advance Shipment Notice (ASN). See: Advanced Shipment Notices (ASNs), page 9-15.
  - Enter the Supplier. For Source Type Internal, this is the organization. For Source

Type Supplier, this is the supplier name, and you can also enter the Supplier Site.

- Enter the Current Location.
  - Use the lower tabbed regions to further restrict the search. See: To further restrict the search, page 9-53, below.
6. Select the Find to initiate the search and open the Transaction Status window.

**To enter search criteria in the Customer tabbed region:**

1. Select the Customer tabbed region in the Find Transaction Statuses window.

This region is used for finding the receipt transaction status for items that a customer has returned to your company. When a sales representative creates a sales order in Order Management and ships the item to the customer, you can find, create, and view receipt transactions if the customer returns the item. The receipts are created against a return material authorization (RMA) document, which the sales representative uses to authorize the return.

2. Specify any of the following, optional search criteria:
- Line type, such as Return with Receipt of Goods, on the RMA. There are different return line types. Search by RMA line type if you want to see all RMA lines with that line type in your receiving organization.
  - Receipt Number
  - RMA Number, which corresponds to the Order Number field on the sales order
  - Line number from the RMA
  - Customer returning the item
  - Customer Number
  - Customer Item Number that the customer used to order the item
  - The lower tabbed regions. See: To further restrict the search, page 9-53, below.

3. Select the Find to initiate the search and open the Transaction Status window.

**To further restrict the search:**

- Specify any of the following, optional search criteria:
  - In the Item region, you can enter the following search criteria: Item, Rev, Category, Description, and Supplier Item.

- In the Receipt Details region, you can limit the search by Packing Slip, Receiver, Freight Carrier, and Bill of Lading number.
- In the Transaction Details region, you can limit the search by entering a range of Transaction Dates and Transaction Type.
- In the Shipments region, you can enter the Container, Truck Number, or Bar Code Label indicated on an Advance Shipment Notice (ASN). See: Advance Shipment Notices (ASNs), page 9-15.
- In the Destination region, you can select the Requestor, Project, Kanban Card, Task, Deliver-to location, or Job. Using these fields will limit your search results at the distribution level of the order.

**To clear existing search criteria:**

- Select the Clear button to clear any existing search criteria.

## **Related Topics**

Viewing Transaction Status Information, page 9-54

Return Material Authorizations (RMAs), page 9-13

## **Viewing Transaction Status Information**

**To view transaction status information:**

1. Navigate to the Transaction Statuses window.



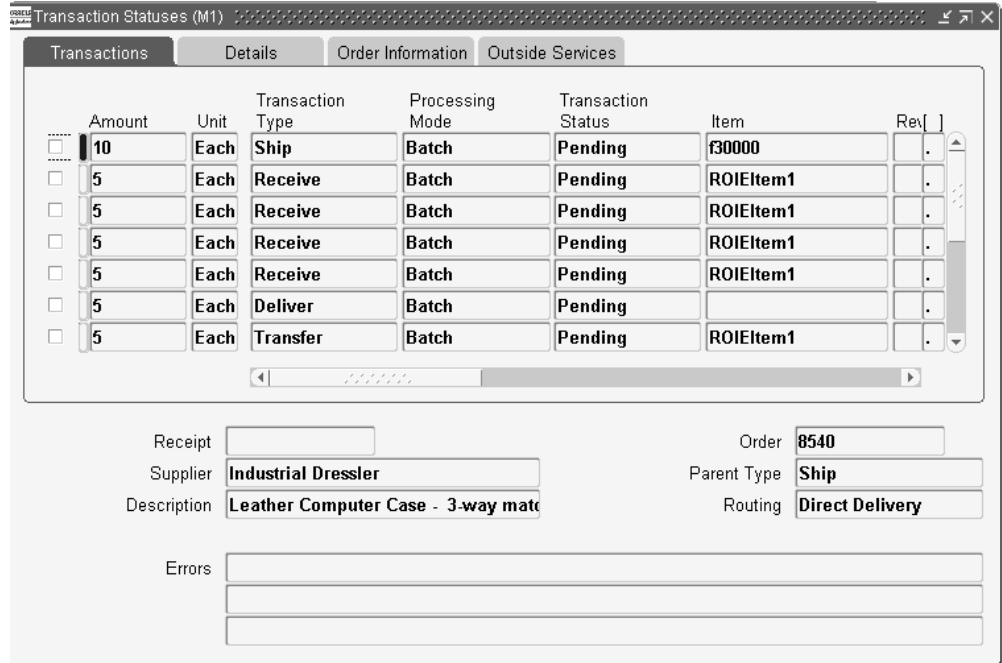

2. Based upon the information you entered in the Find Transaction Statuses window, you see the following regions:
3. In the Transactions region you can view: Transaction Type, Processing Mode, Transaction Status, Item, Rev, Item Description, Destination Type, Location, Person, Subinventory, Locator, Secondary UOM, and Secondary Quantity.
4. In the Details region you can view: Transaction Date, Reason, Comments, Packing Slip, Supplier Lot, Hazard, UN Number, and Receipt Exception.
5. In the Order Information region you can view: Order Type, Order Num, Rel, Line, Shipment, Project, Task, Charge Account, Kanban Card Number, Supplier, Qty Ordered, UOM, and Due Date.
6. In the Order Processing region you can view: Job/Schedule, Line, Operation Sequence, and Department.

## Finding Receiving Transactions

Use the Find Receiving Transactions window to find source documents for which you can enter receiving transactions. Use the Supplier and Internal tabbed region to search for Purchasing documents. If Order Management is installed, use the Customer tabbed region to search for customer return material authorizations (RMAs).

**To enter search criteria in the Supplier and Internal tabbed region:**

1. Navigate to the Find Receiving Transactions window by selecting Receiving

Transactions from the menu. Enter desired search criteria as described in the following steps.

The screenshot shows the 'Find Receiving Transactions (M1)' window. The 'Supplier and Internal' tab is active. The 'Operating Unit' is set to 'Vision Operations'. The 'Source Type' is set to 'All'. There are several empty input fields for 'Purchase Order', 'Line', 'Requisition', 'Supplier', 'Receipt', 'Release', 'Shipment', 'Shipment', 'Supplier Site', and 'Current Location'. Below this, the 'Item' tab is active, showing fields for 'Item, Rev', 'Category', 'Description', and 'Supplier Item'. At the bottom, there are 'Clear' and 'Find' buttons.

2. Select the Supplier and Internal tabbed region.
3. Select the Operating Unit for this search.
4. Enter the Source Type: Internal, Supplier, or All.
5. Specify any of the following, optional search criteria:
  - Enter the Receipt Number.
  - For source type Supplier, enter the Purchase Order number. If you enter a purchase order number, you can also enter a Release (for blanket purchase agreements), Line, and/or Shipment (for purchase orders) number for the purchase order.
  - For source type Internal, enter the Requisition Number. If you enter a requisition number, you can enter a requisition Line number.
  - In the second Shipment field, enter the shipment number of the Advance

Shipment Notice (ASN). See: Advanced Shipment Notices (ASNs), page 9-15.

- Enter the Supplier. For Source Type Internal, this is the organization. For Source Type Supplier, this is the supplier name, and you can also enter the Supplier Site.
  - Use the lower tabbed regions to further restrict the search. See: To further restrict the search, page 9-57, below.
6. Select the Find button to initiate the search and open the Receiving Transactions window.

**To enter search criteria in the Customer tabbed region:**

1. Select the Customer tabbed region in the Find Receiving Transactions window.

This region is used for finding items that a customer has returned to your company. When a sales representative creates a sales order in Order Management and ships the item to the customer, you can find and create receipts and delivery transactions if the customer returns the item. You create the transaction against a return material authorization (RMA) document, which the sales representative uses to authorize the return.

2. Specify any of the following, optional search criteria:

- Line type, such as Return with Receipt of Goods, on the RMA. There are different return line types. Search by RMA line type if you want to see all RMA lines with that line type in your receiving organization.
- Receipt Number
- RMA Number, which corresponds to the Order Number field on the sales order
- Line number from the RMA
- Customer returning the item
- Customer Number
- Customer Item Number that the customer used to order the item
- The lower tabbed regions. See: To further restrict the search, page 9-57, below.

3. Select the Find button to initiate the search and open the Receiving Transactions window.

**To further restrict the search:**

- Specify any of the following, optional search criteria:

- In the Item region, you can enter the following search criteria: Item number, Revision number, Category, item Description, and Supplier Item Number.
- In the Receipt Details region, you can limit the search by Packing Slip, Receiver, Freight Carrier, and Bill of Lading number.
- In the Transaction Detail region, you can limit the search by entering a range of Transaction Dates.
- In the Shipments region, you can enter the Container, Truck Number, or Bar Code Label indicated on an Advance Shipment Notice (ASN). See: Advance Shipment Notices (ASNs), page 9-15.
- In the Destination region, you can select the Requestor, Project, Kanban Card, Task, Deliver-to location, or Job. Using these fields will limit your search results at the distribution level of the order.

**To clear existing search criteria:**

- Select the Clear button to clear any existing search criteria.

## Related Topics

Receiving Transactions, page 9-39

Entering Receiving Transactions, page 9-58

Return Material Authorizations (RMAs), page 9-13

## Entering Receiving Transactions

Use the Receiving Transactions window to enter receiving transactions.

**Important:** If Oracle Quality is installed and at least one qualified collection plan exists, both the Enter Quality Results option on the Tools menu and the Quality button on the button bar are enabled. Only collection plans that have been associated with the Receiving Transaction are qualified. Please note that when mandatory collection plans are used, quality results data must be entered and saved before you can save your receiving transaction line information. Data collection for Inspection Transaction collection plans have no bearing on whether the Enter Quality Results Tools menu option and the Quality button are enabled. See: Using Oracle Quality with Oracle Purchasing, *Oracle Quality User's Guide* and Purchasing Versus Quality Inspections, *Oracle Quality User's Guide*.

**To enter receiving transaction line information:**

1. Purchasing opens the Receiving Transactions window and displays all receipts that

meet your search criteria when you select the Find button in the Find Receiving Transactions window. See: Finding Receiving Transactions, page 9-55.

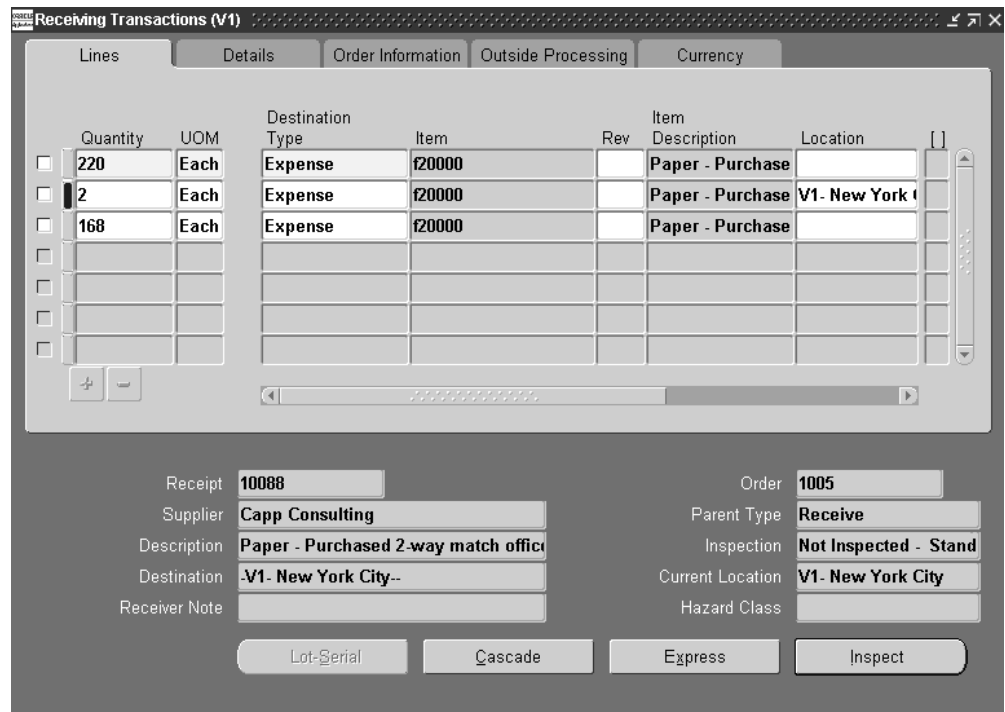

In the lower part of the screen, Purchasing displays the following receipt information for the current line: Receipt Number, Order Number, the Supplier or internal organization shipping the item or the Customer returning the item, Parent Type, Description, Inspection, Destination, Current Location, Receiver Note, and Hazard Class.

2. Select the line for which you want to enter a receiving transaction.

If a material shortage exists for the item, a message appears. Displaying shortage messages for certain items is a setup option. From the message, you can view details of where in your organization the demand exists for the item. You can then make the item available with a high priority. See: Viewing Potential Shortages, *Oracle Inventory User's Guide*. See: Material Shortage Alerts and Shortage Notifications, *Oracle Inventory User's Guide*.

3. Purchasing displays the Quantity due for the shipment. If you change the unit of measure, the receipt quantity is adjusted to reflect the new unit of measure.
4. Enter the UOM of the transaction.
5. Enter the Destination Type: Expense, Inventory, Receiving, or Shop Floor. This determines the final destination of the received items.

6. Enter the Location for the transaction.
7. Enter the Person performing the transaction.
8. For Inventory transactions, enter the Subinventory.
9. If the item is under locator control, enter the stock Locator.
10. If you are a process manufacturing user and have implemented Oracle Process Manufacturing (OPM), then the Oracle Purchasing for Process Inventory functionality is enabled. If the selected receiving organization is a process organization, then the two process fields Secondary UOM and Secondary Quantity are enabled. For more information about these fields, see: *Entering Receiving Lines*, page 9-30.

**To enter receiving transaction detail information:**

1. Navigate to the Details tabbed region.
2. Enter the Packing Slip number.
3. Enter the Transaction Date.
4. Enter the Supplier Lot number.
5. Enter the transaction Reason Code. See: *Defining Transaction Reasons*, *Oracle Inventory User's Guide*.
6. Enter the Hazard class. See: *Defining Hazard Classes*, page 1-53.
7. Enter the UN Number. See: *Defining UN Numbers*, page 1-54.
8. Select Receipt Exception if you want to enter a release exception for this receipt.
9. If Oracle Quality is installed and one or more qualified collection plans exist, you can enter quality results by choosing the Quality button from the button bar or Enter Quality Results from the Tools menu. If mandatory collection plans exist, you must enter Quality results in the Enter Quality Results window before you can save the transaction line. See *To enter quality results*, page 9-61 below. See also: *Entering Quality Data for Receiving Transactions*, *Oracle Quality User's Guide*.

**To view order information:**

- Navigate to the Order Information tabbed region to view the following information for the shipment: Order Type, Number, Release number, order Line number, Shipment number, Supplier, Quantity Ordered, UOM, Due Date, and Supplier Item number.

**To view outside processing information:**

- Navigate to the Outside Services tabbed region to view the Job or repetitive

Schedule number, the repetitive schedule Line number, the Operation Sequence, and the Department number.

**To enter control number information:**

- For controlled items, you can select the Lot-Serial button to navigate to the Lot Number and Serial Number windows. See: Lot Control, *Oracle Inventory User's Guide*. See: Serial Number Control, *Oracle Inventory User's Guide*.

**To enter inspection information:**

- Select the Inspect button to open the Inspection Details window. See: Inspecting Received Items, page 9-65.

**To enter quality results:**

- Choose the Quality button from the button bar or Enter Quality Results from the Tools menu.

The system selects the first-based on the alphanumeric order of collection plan names-of these collection plans in the Enter Quality Results window that appears.

You can only choose to enter quality results after entering all required receiving transaction line information. If the collection plan you select is mandatory, you must enter quality results data before you can save the transaction line. If the collection plan is a background data collection plan, it is not mandatory to enter data. The plan picks up data you enter in the receiving transaction line, according to the data it is configured to pick up. (A mandatory collection plan is optionally defined as mandatory when it was created in Oracle Quality. If it is mandatory and you don't enter quality results data for it, you'll receive a message when you save the receiving transaction line or move to the next line, telling you which collection plan was mandatory and requires quality results data.) See: Entering Quality Data for Move Transactions, *Oracle Quality User's Guide*.

**To view exchange rate information:**

- Navigate to the Currency tabbed region.

This exchange rate information is based on the receipt. These fields are viewable only. See: Entering Receipt Lines, page 9-30.

## Related Topics

Receiving Transactions, page 9-39

Cascading Receipts and Receiving Transactions, page 9-23

Express Receipts and Receiving Transactions, page 9-23

Return Material Authorizations (RMAs), page 9-13

## Drilling Down to Purchasing from Oracle General Ledger

From General Ledger, you can drill down to subledger details from the Account

Inquiry, Journal Entry Inquiry, or Enter Journals windows for journals that have specific journal sources assigned to them. For example, if a journal source is Purchasing, you can drill down to the transaction details in Oracle Purchasing.

For instructions on accessing Purchasing subledger details from General Ledger, see: *Drilling Down to Subledger Detail, Oracle General Ledger User's Guide*.

When you drill down from General Ledger, the Purchasing Receiving Accounting lines window will open. The first time you open this window, the following information will be displayed:

---

Transaction Date	Entered Debit
Receipt Num	Entered Credit
Transaction Type	Currency Conversion Rate
Supplier	Order Line
Debit	Order Shipment
Credit	Order Distribution
Entered Currency	Accounting Date

---

Credit and Debit are the credit and debit entries from your general ledger journal entries, stated in your functional currency. Entered Credit and Entered Debit are the credits and debits in the purchase order currency.

When you select a detailed accounting line, the system displays the following information at the bottom of the window:

---

Item	Order Type
Revision	Order Num
Description	Release Num
UOM	Unit Price
Quantity	

---

When you drill down from General Ledger, the Purchasing Receiving Accounting lines window will open. When you select a detailed accounting line, the system displays



additional information at the bottom of the window.

**Note:** The Credit and Debit fields are the credit and debit entries from your general ledger journal entries, stated in your functional currency. The Entered Credit and Entered Debit fields are the credits and debits in the purchase order currency.

## Drilling Down Further

From the Purchasing Receiving Accounting lines window, you can drill down even further to view detail transactions or you can choose to view the underlying transaction accounting.

### To drill down to detail transactions or to view transaction accounting:

1. From the Purchasing Receiving Accounting lines window, select a detail accounting line.
2. Choose the Show Transaction button to view detail transactions.
3. Choose the Show Transaction Accounting button to view the transaction accounting.

The View Receiving Accounting window opens. See: Viewing Accounting Lines, page 9-47.

## Customizing the Drilldown Window

The drilldown window is a *folder*. You can easily customize the information that is displayed in the window, as described in the *Oracle E-Business Suite User's Guide*.

The drilldown window is a *folder*. You can easily customize the information that is displayed in the window.

See: Customizing the Presentation of Data in a Folder,

When customizing the drilldown window, you can hide the columns that normally appear in the window and you can choose to display any additional columns that are available.

## Related Topics

T-Accounts, *Oracle General Ledger User's Guide*

## Inspections

Purchasing lets you inspect items you receive from suppliers or customers before internal delivery. You can inspect any item or set up certain items to require inspection.

The buyer can use the Note to Receiver field when preparing the purchase order to

indicate where items that *require* inspection should go. The inspector or requestor can record the inspection results in the Inspections window. See: Inspecting Received Items, page 9-65.

You can review in the Receiving Transactions window what items require inspection, and the quantity accepted after inspection. If items require inspection, but the quantity accepted for the receipt is zero, then you know the items are still in inspection. Requestors can review the status of their requisitions in the Requisitions window. In the Purchase Orders window, you can view whether items require inspection and the quantities received and accepted.

If you choose to let requestors inspect items, they can enter the results of their inspections and then record the quantity delivered in the Receiving Transactions window.

If Oracle Quality is installed, you can inspect items through Quality, if the profile option QA: PO Inspection is set to Oracle Quality. (By default, it is set to Oracle Purchasing.) See: Profile Options (in Oracle Quality), *Oracle Quality User's Guide*. You cannot use Oracle Quality to inspect customer returns.

You may also use Oracle E-Records to provide electronic signatures for inspections. See 21 CFR Part 11 Compliance, .

### **Example**

At the receiving dock, you receive a shipment of 200 glass vials that require inspection. You record receipt and send the items to inspection. As the inspector of the 200 glass vials, you accept 195 and reject 5. You send the 5 rejected glass vials back to the supplier and deliver the 195 glass vials to the requestor.

In the Receiving Transactions window, Purchasing displays 195 in the Quantity Accepted field. This shows you how many items you can deliver to the requestors.

## **Returns of Rejected Goods**

Purchasing lets you identify returns to a supplier or customer. There may be many receipt numbers associated with a particular purchase order or RMA number. If, after inspection, you find damaged goods and reject these, you can send the goods back to Receiving to return to the supplier or customer. The receiving agent records the quantity returned to the supplier using the Receiving Returns window. See: Entering Returns, page 9-71.

### **Example**

After inspecting 15 computer boards, you reject 5 boards and want to return them to the supplier. You can reference the purchase order on the receipt traveler that you attach to the board boxes. This number lets the receiving agent locate the receipt, and enter the quantity returned for this receipt.

Your company has sold items to a customer that the customer has returned. Inspection shows that the items are not damaged as the customer claims. You return the items to the customer. You can reference the RMA on the receipt traveler that you attach to the items. This number lets the receiving agent locate the receipt, and enter the quantity

returned for this receipt.

Purchasing keeps an audit trail of returned items, so you can track returns to suppliers and customers and maintain accurate receipt information.

## Inspecting Received Items

Use the Inspection Details window to enter inspection information for received items.

**Note:** If Oracle Quality is installed, you can inspect items through Quality, if the profile option QA: PO Inspection is set to Oracle Quality. (By default, it is set to Oracle Purchasing.) See: Profile Options (in Oracle Quality), *Oracle Quality User's Guide*.

### To enter inspection information:

1. Navigate to the Inspection Details window by selecting the Inspect button in the Receiving Transactions window.

**Note:** If you use Oracle Quality to inspect the items, when you choose the Inspect button the system selects the first-based on the alphanumeric order of inspection plan names-of the inspection plans to display. See: Entering Quality Results for Receiving Inspections, *Oracle Quality User's Guide*.

Status	Quantity	UOM	Quality Code	Reason Code	Supplier Lot	Date
Accept	4	Each	Excellent			18/JAN

2. Select Accept or Reject to describe the action you are taking in a line.
3. Enter the Quantity accepted or rejected. Purchasing displays the uninspected quantity as the default.
4. Enter the UOM for the inspected item.

5. Enter the Quality Code. See: Defining Quality Inspection Codes, page 1-57
6. Enter a Reason Code for the transaction. See: Defining Transaction Reasons, *Oracle Inventory User's Guide*.
7. Enter the Supplier Lot number.
8. Enter the inspection Date. The system date is the default.
9. If you are a process manufacturing user and have implemented Oracle Process Manufacturing (OPM), then the Oracle Purchasing for Process Inventory functionality is enabled. If the selected receiving organization is a process organization, then the two process fields Secondary UOM and Secondary Quantity are enabled. For more information about these fields, see: Entering Receiving Lines, page 9-30.
10. Enter a Comment.
11. Save your work.

**To cancel inspection entry:**

- Select the Cancel button to cancel inspection entry and return to the Receiving Transactions window.

**To save your work:**

- Select OK to save your inspection entries and return to the Receiving Transactions window. You can use Inspection to return to this line for additional inspection entries until you have saved your work. After this time, the receipts will no longer be available for inspection.

If you want to enter more inspection results for a receipt after you've saved your work, requery the receiving transaction line using the Find Receiving Transactions window, and then enter more inspection results.

## Returns

Purchasing allows you to perform returns to suppliers and returns to customers in the Receiving Returns window.

Use the Receiving Returns window to return delivered items to receiving and to return received or delivered externally sourced items to the supplier if the purchase order has neither been cancelled nor final closed. For controlled items, you must specify lot numbers, serial numbers or locators, as appropriate. If the Quality module is installed, you can enter quality information.

Use the Receiving Returns window to return items back to a customer. For example, a customer returns to your company a part that does not work properly. You receive and fix the part, then return the part to the customer.

- You cannot enter returns for internal shipments.
- RMAs cannot be returned to the customer if the material has been delivered to Inventory.

When you are entering a return, the first step is to identify the purchase order or return material authorization (RMA) number and/or item that you want to return. You can choose among various selection criteria when searching for items in the Find Returns window. Use the Supplier and Internal tabbed region to search for receipts created against external suppliers. Use the Customer tabbed region to search for receipts created for customer returns to your company.

You can return to the supplier or customer unordered receipts that have not been matched.

To return items to receiving, enter the return quantity in the Receiving Returns window. If you originally performed a direct receipt, you must specify a Return To receiving location. Otherwise, Purchasing routes all returned items to the receiving location from which you delivered them. For Inventory (but not Expense or Shop Floor) deliveries, you can update the Return From subinventory. You can also optionally specify additional return information such as Reason Code and RMA number (the number your supplier issues to you to track your return to the supplier).

To return items to the supplier or customer, enter the return quantity in the Receiving Returns window. Purchasing provides the source supplier or customer for the items. For Inventory (but not Expense or Shop Floor) deliveries, you can update the Return From subinventory. You can also optionally specify additional return information such as Reason Code and RMA number (the number your supplier issues to you to track your return to the supplier). When you return items to the supplier or customer, Purchasing creates both a Return To Receiving and a Return To Supplier transaction. Purchasing also reopens the associated purchase order for the return quantity by reducing the original receipt quantity. For customer returns, if you return the item back to the customer, Purchasing updates the RMA to reflect the returned quantity.

You can automatically generate debit memos for Return To Supplier transactions once an invoice has been created. When you create the return make sure the Create Debit Memo option is selected. To enable this functionality, enable the supplier site as a Pay Site (or indicate an Alternate Pay Site) and select Create Debit Memo from RTS Transaction in the Supplier Sites window. See: Debit Memos, page 9-14.

## Related Topics

Finding Returns, page 9-68

Entering Returns, page 9-71

## Finding Returns

Use the Find Returns window to find source documents for which you can enter returns. Use the Supplier and Internal tabbed region to search for Purchasing documents. If Order Management is installed, use the Customer tabbed region to search for customer return material authorizations (RMAs).

**Note:** You cannot enter returns for internal shipments (that is, shipments with a Source Type of Internal).

### To find source documents for Supplier and Internal returns:

1. Navigate to the Find Returns window by selecting Returns from the menu. The following steps describe ways in which you can specify search criteria to limit the search for source documents. All of the search criteria are optional.

The screenshot shows the 'Find Returns (M1)' window with the 'Supplier and Internal' tab selected. The window contains several input fields for search criteria:

- Operating Unit: Vision Operations (dropdown menu)
- Source Type: Supplier (dropdown menu)
- Purchase Order: [Empty text box]
- Line: [Empty text box]
- Requisition: [Empty text box] Line: [Empty text box]
- Supplier: [Empty text box]
- Receipt: [Empty text box]
- Release: [Empty checkbox]
- Shipment: [Empty checkbox]
- Shipment: [Empty text box]
- Supplier Site: [Empty text box]
- Current Location: [Empty text box]

Below these fields are tabs for 'Item', 'Date Ranges', 'Transaction Details', 'Shipments', and 'Destination'. The 'Item' tab is selected, showing:

- Item, Rev: [Empty text box]
- Category: [Empty text box]
- Description: [Empty text box]
- Supplier Item: [Empty text box]

At the bottom of the window are 'Clear' and 'Find' buttons.

2. Select the Supplier and Internal tabbed region.
3. Select the Operating Unit for this search.
4. Select a receipt Source Type of Supplier for the search:

The Requisition Number and requisition Line number fields are disabled.

You cannot do returns for documents with a Source Type of Internal.

5. Specify any of the following, optional search criteria:
  - Enter the Receipt Number.
  - Enter the Purchase Order number. To be available, a purchase order must have at least one approved shipment for which the ship-to organization is the same as the current active organization. If you enter a purchase order number, you can also enter a Release number, Line number, and/or Shipment number for the purchase order. The Release field is applicable only when you have entered a purchase order number associated with a planned purchase order or a blanket purchase agreement. The list of values in the Release field includes all releases for the specified purchase order that are not final closed.
  - Enter the Supplier name. You can also enter the Supplier Site.
  - Enter the Current Location.
  - Use the lower tabbed regions to further restrict the search. See: To further restrict the search, page 9-70, below.
6. Select the Find button to initiate the search and display the selected source documents in the Receiving Returns window.

**To find source documents for Customer returns:**

1. Select the Customer tabbed region in the Find Returns window.

This region is used for finding items that a customer has returned to your company. When a sales representative creates a sales order in Order Management and ships the item to the customer, you can find and create receipts if the customer returns the item. The receipts are created against a return material authorization (RMA) document, which the sales representative uses to authorize the return. You can then return the item (for example, after it has been repaired) back to the customer, using the Receiving Returns window.
2. Specify any of the following, optional search criteria:
  - Line type, such as Return with Receipt of Goods, on the RMA. There are different return line types. Search by RMA line type if you want to see all RMA lines with that line type in your receiving organization.
  - Receipt Number
  - RMA Number, which corresponds to the Order Number field on the sales order

- Line number from the RMA
  - Customer returning the item
  - Customer Number
  - Customer Item Number that the customer used to order the item
  - The lower tabbed regions. See: To further restrict the search, page 9-70, below.
3. Select the Find button to initiate the search and display the selected source documents in the Receiving Returns window.

**To further restrict the search:**

- Specify any of the following, optional search criteria:
  - In the Item region, you can enter the following search criteria: Item number, Revision number, Category, item Description, and Supplier Item Number. Since the supplier item number is generally the best way you can identify purchase order lines when your supplier does not reference your purchase order number on its shipping documents, you should provide a supplier item number on your purchase order lines.
  - In the Date Ranges region, you can select Due Today to limit the search to receipt lines due on the current date. Otherwise, you can enter a Due By date range. These dates correspond to the Promised Date (or Need-by Date if there is no Promised Date) on the Purchasing document or to the Promise Date (or Request Date if there is no Promise Date) on the RMA.
  - In the Transaction Detail region, you can enter a Transaction Date range.
  - In the Shipment region, you can enter the Container, Truck Number, or Bar Code Label indicated on an Advance Shipment Notice (ASN) or Advance Shipment and Billing Notice (ASBN). See: Advance Shipment Notices (ASNs), page 9-15.
  - In the Destination region, you can select the Requestor, Project, Kanban Card, Task, Deliver-to location, or Job. Using these fields will limit your search results at the distribution level of the order.

**To remove existing search criteria:**

- Select the Clear button in any of the source document search windows to remove existing search criteria.

## Related Topics

Returns, page 9-66



Entering Returns, page 9-71

Return Material Authorizations (RMAs), page 9-13

## Entering Returns

Use the Receiving Returns window to enter returns against receipts, deliveries, transfers, acceptances, and rejections.

**Note:** You cannot enter returns for internal shipments (that is, shipments with a Source Type of Internal).

### To enter returns:

1. Navigate to the Find Returns window by selecting Returns on the menu. Enter search criteria and choose Find. See: Finding Returns, page 9-68.

The Receiving Returns window appears. In the Transactions tabbed region of this window, Purchasing displays transactions that meet your search criteria. The Order Information tabbed region displays information about the purchase order against which the receipt was made. The Outside Services tabbed region displays pertinent information for outside processing receipts.

The screenshot shows the 'Receiving Returns (V1)' window with the 'Transactions' tab selected. The table below is a representation of the data shown in the window.

	Quantity	UOM	Return To	Supplier/Customer/ Location	RMA Number	Item	Parent Qty
<input checked="" type="checkbox"/>	2	Each	Supplier	Consolidated Sup		CM18759	4
<input type="checkbox"/>							
<input type="checkbox"/>							
<input type="checkbox"/>							
<input type="checkbox"/>							
<input type="checkbox"/>							

Receipt	10466	Order	1003659
Supplier	Consolidated Supplies	Parent Type	Receive
Description	Keyboard - 101 Key	Routing	Standard Receipt
Destination	-V1- New York City--	Current Location	V1- New York City
Receiver Note		Hazard Class	

Lot - Serial

2. Enter the return Quantity. Purchasing selects the line and places a check in the line selector checkbox.

For Return To Supplier transactions, Purchasing reopens the associated purchase order for the return quantity by reducing the original receipt quantity. For customer

returns that you return back to the customer, Purchasing updates the RMA to reflect the returned quantity.

3. Enter the Return Unit of Measure. Purchasing displays the unit of measure conversion.
4. Note that Create Debit Memo is selected if Create Debit Memo from RTS Transaction is selected for this supplier site in the Supplier Sites window.

If Create Debit Memos is selected, Purchasing creates a debit memo for the returned quantity once you save the transaction. You can then view or edit the debit memo in Payables. Debit memo creation is enabled for Return to Supplier transactions only. If you do not want a debit memo to be created automatically for this transaction, deselect this option.

If you enter a return and an invoice has not yet been created for the original receipt, or if Payment on Receipt already accounted for the return using the Aging Period functionality, Purchasing does not create a debit memo. (See: Payment on Receipt, page 13-16.) You will receive a notification in the Notifications Summary window for any debit memo that could not be created. Purchasing does not create debit memos for returns against unordered receipts. Tax or freight is not included in the debit memo amount.

5. In the Transactions tabbed region, you can update the RMA Number used by your supplier for returns to that supplier. For Inventory (but not Expense or Shop Floor) deliveries, you can update the Return From subinventory.

**Important:** The RMA number in the Customer tabbed region of the Find Returns window is the number you and your customer use to track returns to you. The RMA number here is the number you and your supplier use to track your return to the supplier.

6. In the Details tabbed region, you can enter a Reason Code, update the Transaction Date, and view whether a Receipt Exception has been placed. See: Defining Quality Inspection Codes, page 1-57.

**To enter control number information:**

- For controlled items, you can select the Lot & Serial button to navigate to the Lot Number and Serial Number windows. See: Lot Control, *Oracle Inventory User's Guide*. See: Serial Number Control, *Oracle Inventory User's Guide*.

**To move to the Quality module:**

- If the Quality module is installed and if a quality plan applies to the transaction, you can navigate to the Quality module by selecting the Quality button.

## Related Topics

Returns, page 9-66

Corrections, page 9-73

Finding Returns, page 9-68

Return Material Authorizations (RMAs), page 9-13

Debit Memos, page 9-14

## Corrections

Use the Receiving Corrections window to modify receiving transactions to correct errors. You can correct receiving transactions other than another Correction transaction or an internal shipment delivered to inventory. For controlled items, you must specify lot and/or serial numbers, as appropriate. For corrections to customer return transactions, the return material authorization (RMA) in Order Management is updated to reflect the new quantity.

**Note:** You cannot perform a correction to a drop shipment purchase order receipt.

When you are entering a correction, the first step is using the Find Corrections window to identify the transaction that you want to correct. See: Finding Corrections, page 9-74.

You can enter positive or negative corrections to any receiving transaction. Purchasing allows you to enter correction quantities greater than the outstanding receiving supply quantity.

You can also make corrections to quantities that you *return* to a supplier. For example, you receive 100 items, and you use a Return To Supplier transaction to return 10 items to the supplier because they were damaged. Then you realize that only 9 items were damaged. This means that, in the Corrections window, you must enter a correction of -1 for the Return to Supplier transaction. Purchasing moves the item from the supplier to your receiving supply. If you additionally want to move the item from your receiving supply to your on-hand supply, you must *additionally* enter a correction of +1 for the Return to Receiving transaction.

The table below illustrates this process, using a correction of -1 and +1 as examples.

---

In the Corrections window, in the Quantity field, when you enter ...	Purchasing ...
--	----------------

---

---

-1 for the Return to Supplier transaction	Returns the item to receiving supply: <b>Supplier --&gt; Receiving</b>
-1 for the Return to Receiving transaction	Returns the item to on-hand supply: <b>Supplier Receiving --&gt; Supply</b>
+1 for the Return to Receiving transaction	Returns the item to receiving supply: <b>Receiving &lt;-- Supply</b>
+1 for the Return to Supplier transaction	Returns the item to the supplier: <b>Supplier &lt;-- Receiving Supply</b>

---

When you make corrections to a receipt created against an Advance Shipment Notice (ASN), your purchasing, in-transit, and inventory supplies are automatically updated. See: ASNs and Supply, page 9-19.

## Related Topics

- Returns, page 9-66
- Entering Returns, page 9-71
- Finding Corrections, page 9-74
- Entering Corrections, page 9-78
- Return Material Authorizations (RMAs), page 9-13

## Finding Corrections

Use the Find Corrections window to find source documents for which you can enter corrections. Use the Supplier and Internal tabbed region to search for Purchasing documents. If Order Management is installed, use the Customer tabbed region to search for customer return material authorizations (RMAs).

**Note:** You can also make corrections to quantities that you *return* to a supplier. For instructions, see: Corrections, page 9-73.

### To find Supplier and Internal source documents for corrections:

1. Navigate to the Find Corrections window by selecting Corrections from the menu. The following steps describe ways in which you can specify search criteria to limit the search for source documents. All of the search criteria are optional.

2. Select the Supplier and Internal tabbed region.
3. Select the Operating Unit for this search.
4. Select the receipt Source Type for the search:
  - *Internal*: An internal order generated from an internal requisition and sourced from your inventory, or an intransit inventory shipment. If you choose this option, the following fields are disabled: PO Number, Release, Line, Shipment, and Include Closed POs.
  - *Supplier*: A purchase order sourced from a supplier. If you choose this option, the following fields are disabled: Requisition Number, requisition Line number, and Shipment Number.
  - *All*: Internal- and supplier-sourced documents.
5. Specify any of the following, optional search criteria:
  - Enter the Receipt Number.
  - For source type Supplier, enter the Purchase Order number. To be available, a

purchase order must have at least one approved shipment for which the ship-to organization is the same as the current active organization. If you enter a PO Number, you can also enter a Release number, Line number, and/or Shipment number for the purchase order. The Release field is applicable only when you have entered a purchase order number associated with a planned purchase order or a blanket purchase agreement. The list of values in the Release field includes all releases for the specified PO that are not final closed.

- For source type Internal, enter the Requisition Number. If you enter a requisition number, you can also enter a Line number. Available lines are those with the same ship-to organization as the current active organization.
  - In the second Shipment field, enter the shipment number of the Advance Shipment Notice (ASN). See: Advanced Shipment Notices (ASNs), page 9-15.
  - Enter the Supplier. For Source Type Internal, this is the organization. For Source Type Supplier, this is the supplier name, and you can also enter the Supplier Site.
  - Enter the Current Location.
  - Use the lower tabbed regions to further restrict the search. See: To further restrict the search, page 9-77, below.
6. Select the Find button to initiate the search and display the selected source documents in the Receiving Corrections window.

**To find Customer returns for corrections:**

1. Select the Customer tabbed region in the Find Corrections window.

This region is used for finding items that a customer has returned to your company. When a sales representative creates a sales order in Order Management and ships the item to the customer, you can find and create receipts and corrections if the customer returns the item. The receipt is created against a return material authorization (RMA) document, which the sales representative uses to authorize the return.

2. Specify any of the following, optional search criteria:
- Line type, such as Return with Receipt of Goods, on the RMA. There are different return line types. Search by RMA line type if you want to see all RMA lines with that line type in your receiving organization.
  - Receipt Number
  - RMA Number, which corresponds to the Order Number field on the sales order

- Line number from the RMA
  - Customer returning the item
  - Customer Number
  - Customer Item Number that the customer used to order the item
  - The lower tabbed regions. See: To further restrict the search, page 9-77, below.
3. Select the Find button to initiate the search and display the selected source documents in the Receiving Corrections window.

**To further restrict the search:**

- Specify any of the following, optional search criteria:
  - In the Item region, you can enter the following search criteria: Item number, Revision number, Category, item Description, and Supplier Item number. Since the supplier item number is generally the best way you can identify purchase order lines when your supplier does not reference your purchase order number on its shipping documents, you should provide a supplier item number on your purchase order lines.
  - In the Receipt Details region, you can restrict the search by Packing Slip number, Receiver, Freight Carrier, or Bill of Lading.
  - In the Transaction Detail region, you can enter a Transaction Date range.
  - In the Shipment region, you can enter the Container, Truck Number, or Bar Code Label indicated on an Advance Shipment Notice (ASN). See: Advance Shipment Notices (ASNs), page 9-15.
  - In the Destination region, you can select the Requestor, Project, Kanban Card, Task, Deliver-to location, or Job. Using these fields will limit your search results at the distribution level of the order.

**To remove existing search criteria:**

- Select the Clear button in any of the source document search windows to remove existing search criteria.

## Related Topics

Corrections, page 9-73

Entering Corrections, page 9-78

Return Material Authorizations (RMAs), page 9-13

## Entering Corrections

Use the Receiving Corrections window to record correction transactions against prior receiving transactions.

### To enter corrections:

1. Navigate to the Receiving Corrections window by selecting the Find button in the Find Corrections window. See: Finding Corrections, page 9-74.

If your selection criteria produce any transactions, the Transaction Type (Expense, Inventory, Shop Floor, or Receiving), Quantity, Destination, Item, Revision, and Item Description are displayed in the Transactions tabbed region. The Order Type, Order number, the Supplier or internal organization shipping the item or the Customer returning the item, and the Due Date are displayed in the Order Information region. The Item Description, Hazard Class, Destination, UN Number, Receiver Note, and Routing for the current line are displayed in the lower part of the window.

The screenshot shows the 'Receiving Corrections (V1)' window with the 'Transactions' tab selected. The table below shows the data displayed in the Transactions tabbed region:

Quantity	UOM	Transaction Type	Parent Qty	Item	Rev	Item Description
<input checked="" type="checkbox"/> 2	Each	Receive	10	AS54888		Sentinel Standard D
<input type="checkbox"/>	Each	Unordered receipt	5	AS54888		Sentinel Standard D
<input type="checkbox"/>						
<input type="checkbox"/>						
<input type="checkbox"/>						
<input type="checkbox"/>						
<input type="checkbox"/>						

Below the table, the summary section displays the following information:

Receipt	10457	Order	1003585
Supplier	BAT	Parent Type	Receive
Description	Sentinel Standard Desktop	Routing	Standard Receipt
Destination	HYDE--	Current Location	HYDE
Receiver Note		Hazard Class	

A 'Lot - Serial' button is located at the bottom right of the window.

2. Use the remaining tabbed regions to display additional information about the transactions:
  - In the Transactions tabbed region, you can view the following: Destination Type, Item number, Revision number, Item Description, Location, Person, Subinventory, and stock Locator.
  - In the Details tabbed region, you can view the following: Packing Slip number, Supplier Lot number, Reason code, Hazard class, and UN Number.



- In the Currency tabbed region, you can view exchange rate information if the purchase order was created in a foreign currency.
  - In the Order Information tabbed region, you can view the following: Order Type, Order number, Release number, Line number, Shipment number, Supplier or Customer, Quantity Ordered, UOM, and Due Date.
  - In the Outside Services tabbed region, you can view the Job/Schedule, Line, Operation Sequence, and Department.
3. If you are a process manufacturing user and the Oracle Process Manufacturing (OPM) application is installed, then the Oracle Purchasing for Process Inventory functionality is enabled. If the selected receiving organization is a process organization, then the two process fields Secondary UOM and Secondary Quantity are enabled. For more information about these fields, see: *Entering Receiving Lines*, page 9-30.
  4. In the Quantity field, enter the positive or negative correction quantity for the current line. Making any entry on the line automatically selects the line. You can also use the line selector to select and deselect lines.

You can also make corrections to quantities that you *return* to a supplier. For instructions, see: *Corrections*, page 9-73.

**To enter control number information:**

- For controlled items, you can select the Lot & Serial button to navigate to the Lot Number and Serial Number windows. See: *Lot Control*, *Oracle Inventory User's Guide*. See: *Serial Number Control*, *Oracle Inventory User's Guide*.

**To view exchange rate information:**

- Navigate to the Currency tabbed region.

This exchange rate information is based on the receipt. See: *Entering Receipt Lines*, page 9-30. These fields are viewable only. Any correction you make is made using the exchange rate information you see here.

**To move to the Quality module:**

- If the Quality module is installed and if a quality plan applies to the transaction, you can navigate to the Quality module by selecting the Quality button. See: *Using Oracle Quality with Oracle Purchasing*, *Oracle Quality User's Guide*

## Related Topics

Returns, page 9-66

Entering Returns, page 9-71

Corrections, page 9-73

Finding Corrections, page 9-74

Return Material Authorizations (RMAs), page 9-13

## Finding Intransit Shipments

Use the Find Intransit Shipments window to find source documents for which you can enter shipment information. You can also use the Find Intransit Shipments window to view validated Advance Shipment Notices (ASNs).

### To find source documents for intransit shipments:

1. Navigate to the Find Intransit Shipments window.

The screenshot shows the 'Find In-Transit Shipments (M1)' window. It features two main tabs: 'Supplier and Internal' and 'Customer'. The 'Supplier and Internal' tab is active, displaying several input fields: 'Operating Unit' (set to 'Vision Operations'), 'Source Type' (set to 'All'), 'Purchase Order', 'Line', 'Requisition', 'Supplier', 'Receiving Location', 'Release', 'Shipment', and 'Supplier Site'. Below these fields is a section with four sub-tabs: 'Item', 'Date Ranges', 'Receipt Details', and 'Shipments'. The 'Item' sub-tab is selected, showing fields for 'Item, Rev', 'Category', and 'Description'. At the bottom of the window are 'Clear' and 'Find' buttons.

2. Select the Operating Unit for this search.
3. Specify any of the following, optional search criteria:
  - Select a Source Type of Internal, Supplier, or All. 'Internal' searches for inventory intransit shipment information. 'Supplier' searches for external suppliers' shipment information, such as ASNs. 'All' searches for both internal and external shipment information.

- For a Supplier source type, enter the Purchase Order Number. If you enter a purchase order number, you can also enter a Release number, Line number, and/or Shipment number for the purchase order.
  - For an Internal source type, enter the Requisition Number. If you enter a requisition number, you can also enter a Line number.
  - In the second Shipment field, enter the shipment number of the Advance Shipment Notice (ASN). See: Advanced Shipment Notices (ASNs), page 9-15.
  - Enter the Supplier. For Source Type Internal, this is the organization. For Source Type Supplier, this is the supplier name, and you can also enter the Supplier Site.
  - Enter the Receiving Location.
  - Use the tabbed regions to further restrict the search.
    - In the Item region, you can enter the following search criteria: Item number, Revision number, Category, and item Description.
    - In the Date Ranges region, you can select Due Today to limit the search to receipt lines due on the current date. Otherwise, you can enter a Due By date range.
    - In the Receipt Details region, you can restrict the search by Packing Slip number, Receiver, Freight Carrier, or Bill of Lading.
    - In the Shipment region, you can enter the Container, Truck Number, or Bar Code Label indicated on an ASN.
4. Select the Find button to initiate the search and display the selected source documents in the Manage Shipments window.
- To remove existing search criteria:**
- Select the Clear button in any of the source document search windows to remove existing search criteria.

## Related Topics

Managing Shipments, page 9-81

Advanced Shipment Notices (ASNs), page 9-15

## Managing Shipments

Use the Manage Shipments window to view and update inventory intransit shipment

information. Also use the Manage Shipments window to view or cancel Advance Shipment Notices (ASNs).

You can view a wide variety of information about an inventory intransit shipment, including internal requisition information backing the intransit shipment. You can enter or change selected header information including packing slip and bill of lading numbers, the expected receipt date, the freight carrier, the ship-to location, and the number of containers. You can also enter or change some information at the shipment line level: the packing slip number, receipt routing, and reason code.

For an ASN, you can also view a wide variety of information, including truck and container numbers. You can also cancel an ASN by choosing Cancel from the Tools menu. (The supplier can also send a Cancellation ASN.) See: Advanced Shipment Notices (ASNs), page 9-15.

**Note:** Before you can use this window to view and update inventory intransit shipment information, you must transfer material between organizations that use intransit inventory. See: Transferring Between Organizations, *Oracle Inventory User's Guide*.

**To select shipments:**

1. Navigate to the Find Intransit Shipments window. See: Finding Intransit Shipments, page 9-80.
2. Enter any of the following as selection criteria: Purchase Order or Requisition number, requisition Line number, ASN Shipment number, Supplier, Supplier Site and Receiving Location. In the tabbed regions in the lower part of the screen, you can specify additional selection criteria for the item, and date ranges.
3. Select the Find button to move to the Manage Shipments window.

**To manage shipments:**

1. Navigate to the Manage Shipments window. In this window Purchasing displays Shipment Header information for the first shipment that meets the criteria. Use the down arrow on your keyboard to display information for subsequent shipments that meet your search criteria.

**Note:** For inventory intransit shipments, you will see Shipment Lines information only when you view the shipments from within the receiving organization.

Manage Shipments (M1)

Shipment Header

Shipment Number: 1021146  
 Supplier: Boston Manufacturing  
 Expected Receipt Date: 03/FEB/2006 00:00  
 Freight Carrier: DHL  
 Ship-to Location: M1- Seattle  
 Comments: [ ]

Shipped Date: 02/FEB/2006 02:19  
 Waybill / Airbill: [ ]  
 Bill Of Lading: [ ]  
 Packing Slip: [ ]  
 Number Of Containers: [ ]

Shipment Lines

Shipment Line	Qty Shipped	UOM	Item Number	Rev	Item Description	Hazard Class
1	5	Each	IRO-101		Lot Item	

2. You can maintain data only in the following Shipment Header fields: Expected Receipt Date, Bill of Lading, Freight Carrier, Packing Slip, Ship-to Location, Number of Containers, and Comments.
3. In the Shipment Lines region, only the item Revision, stock Locator, Packing Slip, Comments, Transaction Reason Code, and Receipt Routing are maintainable.

**To cancel an Advanced Shipment Notice:**

- Select the shipment line and choose Cancel from the Tools menu.

## Control Numbers

Purchasing uses *three* types of control numbers: lot numbers, serial numbers, and stock locators.

Purchasing provides you the ability to assign lot and serial numbers to items as they are transacted to their destinations by direct receipt or delivery and to track these items by lot and serial number.

You assign lot and serial numbers to items as you are entering individual deliveries or performing direct receipts. You can access the Lot and Serial Numbers window directly from each transaction that you enter, and assign lot and/or serial numbers to each unit of the item in the transaction.

Stock Locators are used for deliveries to inventory destinations. Purchasing uses the locator controls defined in Inventory.

## Entering Lot Numbers

In the Lot Numbers window, there may or may not be existing lot number information corresponding to your transaction. If such information exists, you can pick the lot number that you want to assign to your receiving transaction. If you are entering a supplier receipt, you have to enter a lot number that has not been previously assigned to an item. If you are entering any other type of receiving transaction, you have to pick a lot number from the list of lot numbers that are valid for the given item. For example, if you enter an intransit receipt or a transfer, you cannot assign a completely new lot number, but rather you must choose the appropriate lot number that has been previously assigned to the item.

Based on the lot number you enter, Purchasing automatically enters the expiration date if you defined shelf life control for the item and specified a number of shelf life days. If you defined the item by specifying lot control with shelf life control that is user definable, then you can enter an expiration date that is the same as or later than the current date. Purchasing displays the quantity of each lot number that is available for assignment, and you cannot assign more units to a lot number than are available.

## Entering Serial Numbers

For deliveries, you must enter serial number information if the item is under serial number control. Purchasing displays a running total of the number of units that have been assigned to serial numbers.

There may be existing serial number information corresponding to the item in this transaction. For example, if you were receiving an item from intransit and the sending organization had assigned serial numbers to the item at the time of shipment, these numbers would be available in a list of values. On the other hand, if you were entering a supplier receipt, you would have to assign new serial numbers.

You enter serial numbers by assigning a range of numbers for each item or lot quantity. Purchasing then assigns each unit of the item or lot quantity to a serial number within your selected range. When you enter a beginning serial number, Purchasing automatically defaults the ending serial number to the same value. You can override this default if you want to specify a range of serial numbers rather than just one serial number.

## Lot and Serial Numbers in Inter-organization Transfers

When you perform an inter-organization transfer, the source and destination organization may have different lot/serial controls. Purchasing handles this situation as follows:

- When the source organization uses controls and the destination organization does not, the control numbers are recorded as being issued from the source organization. Lot/serial transactions are recorded for the destination organization.

- When the source organization does not use controls and the destination organization does, the transaction is processed normally.
- When both source and destination organizations use controls, the control numbers are recorded as being issued from the source organization. These control numbers are tracked to insure that the same control numbers that were shipped are the ones that are received. When items are returned from inventory to receiving or to the supplier, only the control numbers originally recorded for the delivery transaction can be used.

## Entering Stock Locators

When you enter a receiving transaction that will result in a delivery to an inventory destination, and when locator control is required for the organization/item/subinventory, Purchasing displays the Stock Locator flexfield during entry of the destination information in the Receipts, Receiving Transactions, Returns, and Corrections windows.

## Related Topics

Lot Control, *Oracle Inventory User's Guide*

Serial Number Control, *Oracle Inventory User's Guide*

Defining Stock Locators, *Oracle Inventory User's Guide*

## Receiving Reports

Purchasing provides summary and detail reports on your receipts. You can produce receiving transaction reports by item, supplier, purchase order number, receipt number and/or receiving date range.

Purchasing also provides summary and detail reports to help you analyze your suppliers' performance. You can produce supplier quality reports by buyer, supplier, and item. You can use the receiving inspection register to review your inspections by receipt.

Use the Submit Requests window to run Receiving reports. See: Submitting a Request, *Oracle Applications System Administrator's Guide*.

## Printing an Expected Receipts Report

Purchasing helps you organize your work by generating an Expected Receipts Report using the setup options you specify. You can use setup options such as Ship-To Location, Promised Dates, Category, and Item Number. For example, you can review all expected computer equipment receipts, or you can review all receipts for the next two days.

**Example**

You want to print an Expected Receipts Report for the current week. You are primarily interested in the furniture receipts for the week, so you specify a date range for the current week and the purchasing category Furniture in the Category field. See: Expected Receipts Report, page 11-17.

**Using Receipt Travelers**

Purchasing makes it easy to route goods in your organization by letting you print a receipt traveler that you can place on the goods. You can use the Submit Requests window to print as many travelers as you need. See: Submitting a Request, *Oracle Applications System Administrator's Guide*

**Example**

You receive 5 personal computers and you want to show the final destination for each. In the Submit Requests window, you can generate a Receipt Traveler for each box. See: Receipt Traveler, page 11-63.

**Important:** If the RCV: Print Receipt Travelerprofile option is set to Yes, Purchasing automatically prints the Receipt Traveler when you perform a standard or direct receipt and when you match unordered receipts.

**Related Topics**

Profile Options in Purchasing, page C-1

Submitting a Request, *Oracle Applications System Administrator's Guide*

**Overview of Receipt Accounting****Inventory Accruals**

Inventory and Purchasing provide you with visibility and control of your accrued liabilities for inventory items. Purchasing automatically records the accrued liability for your inventory items at the time of receipt as perpetual accruals. This transaction is automatically recorded in your general ledger at the time of receipt (unless you specified otherwise when setting up periodic costing). The inventory expense is recorded at delivery if you use Standard Delivery and at receipt if you use Direct Delivery. You have options to determine whether Purchasing and Inventory reverse encumbrances. The option used is dependent on how you compare encumbrance to budget balances in inventory for your organization.



## Expense Period-End Accruals

Purchasing optionally accrues uninvoiced receipts of non-inventory items when you close a period. You can choose which uninvoiced receipts are accrued. At period end, Purchasing automatically creates a balanced journal entry for each uninvoiced receipt. Purchasing creates a reversing entry for the encumbered amount corresponding to the expense while creating an accrual entry for the receipt in the general ledger if you are using encumbrance at your site.

**Important:** When using Cash Basis Accounting, you will not normally run the Receipt Accrual - Period End process. However, you must use the Purchasing Options window and set the Accrue Expense Items flag to Period End. See: Receipt Accruals - Period End Process, page 13-25.

## Expense Perpetual Accruals

Purchasing optionally provides you with the ability to accrue non-inventory liabilities at the time of receipt. If you choose at time of receipt, Purchasing records an accrued liability and charges your receiving inspection account for each non-inventory receipt. This transaction is automatically recorded in your general ledger at the time of receipt. Purchasing creates a reversing entry for the encumbered amount at the time you deliver the goods to the final inventory or expense destination. When an invoice is matched to a purchase order and approved in Payables, it is not necessary for Payables to record an encumbrance for the expense. However, Payables will record an encumbrance for invoice price variance or exchange rate variance, if the variance exists.

## Purchase Price Variance

Purchasing and Inventory provide you with visibility and control of your purchase price variances. When you use standard costing, Purchasing and Inventory automatically calculate and record purchase price variances as you receive your inventory items into inventory. If desired, Purchasing and Inventory automatically calculate and record purchase price variances for your outside processing receipts into work in process. You can use the Purchase Price Variance Report to review the accuracy of the standard costs for your purchased items and services. See: Purchase Price Variance Report, page 11-53.

## Invoice Price Variance (IPV) and Exchange Rate Variance

Purchasing and Inventory provide you with visibility and control of your invoice price and exchange rate variances. When Payables accounts for invoices, it automatically creates accounting entries for price and exchange rate variances. You can use the Invoice Price Variance Report to review the accuracy of your purchase order prices. See: Invoice Price Variance Report, page 11-21.

## Foreign Currencies

If the purchase order uses a foreign currency, Purchasing converts the purchase order price to the inventory functional currency. Inventory uses this converted value for receiving accounting purposes. Payables allows you to record exchange rate invoice variance to separate accounts.

## Nonrecoverable Tax

If you use nonrecoverable or partially recoverable tax, the nonrecoverable tax amount is included in your period-end or perpetual accrual accounting. Nonrecoverable tax is also included in the invoice and exchange rate variances. Changing the exchange rate on the receipt may affect the nonrecoverable tax amount. See: Tax Information in Purchasing, page 4-116. See: Entering Receipt Lines, page 9-30.

## Accrual Reconciliation and Write-Off

Purchasing and Inventory provide you with a complete reconciliation report of all of your accounts payable accrual transactions. You can quickly identify any mismatched items and write-off accrual transactions from your receiving, accounts payable, inventory, and work in process subledgers. See: Reconciling A/P Accrual Accounts Balance, page 9-102.

## Expense Accrual Reporting

You can use the Uninvoiced Receipts Report to analyze your uninvoiced receipt liabilities for non-inventory purchases when you create accrual entries for them in your general ledger. You can control the amount of expenses you accrue by supplier and purchasing category. You can obtain detailed information about the purchase order receipts you accrued during your accounting period. See: Uninvoiced Receipts Report, page 11-90.

## Period-End Accruals and Encumbrance

For period-end accruals when using encumbrances, Purchasing creates a reversing entry for the encumbered amount corresponding to an expense while creating an accrual entry for the receipt in the general ledger. When you accrue your receipts, Purchasing ensures that you do not duplicate entries for the period. At the beginning of the following period, you reverse the accrual entry for the expense and recreate the encumbrance entry you reversed in the previous period using General Ledger. See: Receipt Accruals - Period End Process, page 13-25.

If you use nonrecoverable or partially recoverable tax, the nonrecoverable tax amount is included in your encumbrances.

## Inventory and Perpetual Expense Accruals and Encumbrance

For perpetual expense and inventory accruals, Purchasing and Inventory create a reversing entry for the encumbered amount at the time you deliver the goods to the final inventory or expense destination. When an invoice is matched to a purchase order and approved in Payables, it is not necessary for Payables to record an encumbrance for the expense. However, Payables will record an encumbrance for invoice price variance or exchange rate variance, if the variance exists.

If you use nonrecoverable or partially recoverable tax, the nonrecoverable tax amount is included in your encumbrances.

### Related Topics

Setting Up Inventory Accruals, page 9-89

Accrual Process for Perpetual Accruals, page 9-94

Monitoring Price variances, page 9-101

Reconciling A/P Accrual Accounts Balance, page 9-102

Accrual Process for Period End Accruals, page 9-104

Identifying Journal Entry Batches in General Ledger, page 9-108

### Setting Up Inventory Accruals

If you use Purchasing and Inventory together, use the following steps to implement perpetual accruals for inventory item purchases:

#### Defining Expense Accrual Option

You need to specify whether you want to use period-end or perpetual accruals for your expense destination receipts. Set the Accrue Expense Items option in the Purchasing Options window to At Receipt if you want to accrue your expense receipts perpetually. Specify Period End if you want to accrue your receipts at period end. See: Defining Accrual Options, page 1-40.

#### Defining Default Accounts

You need to define the following accounts before entering transactions in Purchasing and Inventory.

#### Receiving Account

Enter the general ledger account to record the current balance of material in receiving and inspection.

Use the Define Organization or Receiving Options window to set up this account. See:

### Inventory A/P Accrual Account

Enter a general ledger account to accumulate the inventory accounts payable accrual for this organization. This is the account used by Purchasing to accrue your payable liability when you receive your items. This account represents your uninvoiced receipts and is usually part of your accounts payable liabilities in the balance sheet. Payables relieves this account when the invoice is matched and approved. See: Defining Other Account Parameters, *Oracle Inventory User's Guide*.

### Expense A/P Accrual Account

Enter a general ledger account to accumulate the expense accounts payable accrual for your purchasing installation. This is the account used by Purchasing to accrue your accounts payable liability for expense items at time of receipt when your Expense Accrual Option is At Receipt, or at period-end when your Expense Accrual Option is Period End. This account represents your uninvoiced receipts and is usually part of your accounts payable liabilities in the balance sheet.

Use the Purchasing Options window to set up this account. See: Defining Accrual Options, page 1-40.

### Purchase Price Variance Account

Enter a general ledger account to accumulate purchase price variance for this organization. The purchase price variance account is usually an expense account. This is the variance that you record at the time you receive an item in inventory, and is the difference between the purchase order cost and an item's standard cost. Purchasing calculates purchase price variance as:

---

$$\text{PPV} = (\text{PO unit price} - \text{standard unit cost}) \text{ quantity received}$$

---

**Note:** Cost Management includes nonrecoverable tax with the PO unit price if tax and a recovery rate are set up for the item. If the purchase order is in a foreign currency, the purchase price variance is calculated using the exchange rate from the receipt if the Invoice Match Option in the purchase order Shipments window is Receipt and from the purchase order if the Invoice Match Option is Purchase Order.

Purchase price variance is not used for average costing.

Use the Organization Parameters window to set this account. See: Inter-Organization Transfer Accounts, *Oracle Inventory User's Guide*.

## Invoice Price Variance Account

Enter a general ledger account to accumulate invoice price variance for this organization. This is usually an expense account.

Invoice price variance is the difference between the purchase order price for an inventory item and the actual invoice price multiplied by the quantity invoiced: Invoice Quantity x (Invoice Price - PO Price) x Invoice Exchange Rate. Purchasing uses this account on the PO distribution when the requisition or purchase order is created. When Payables creates accounting entries for the invoice, it uses the invoice price variance account from the purchase order to record invoice price variance entries.

Use the Organization Parameters window to set this account. See: *Inter-Organization Transfer Accounts, Oracle Inventory User's Guide*.

## Exchange Rate Gain or Loss Accounts

Enter general ledger accounts to accumulate exchange rate gains or losses for this organization. These are usually expense accounts.

Exchange rate gain or loss accounts are used to record the difference between the exchange rate used for the purchase order and the exchange rate used for the invoice. The exchange rate is taken from the purchase order only if the Invoice Match Option in the purchase order Shipments window is Purchase Order. If the Invoice Match Option is Receipt, the exchange rate is taken from the receipt.

These accounts can also be used in Payables to record gains and losses at payment time and clearing time.

Use the Accounting region of the Financials Options window to set up these accounts. See: *Defining Financials Options, Oracle Payables User's Guide*.

## Using the Account Generator to build accounts

In addition to the standard default accounts listed above, you can use the Account Generator to predefine a set of rules that allow Purchasing to build the following accounts for each purchase order distribution automatically:

- Charge Account
- Budget Account
- Accrual Account
- Invoice Variance Account

See: *Using the Account Generator in Oracle Purchasing, page E-6*.

## Setting Up Your Period End Date

For the accrual report to balance to the general ledger, the last transaction (or

accounting) date of each fiscal period has to be the same in Inventory, Purchasing, and Payables.

### Creating Purchase Orders for Inventory Items

Some of the purchase orders you create are for items you want to move directly into your inventories. Some other purchase orders are for items you simply want to expense.

Purchasing ensures that you charge all inventory items you purchase to the Inventory A/P accrual account for the receiving organization. Each time you enter an item on a purchase order, Purchasing defaults the Inventory A/P accrual account corresponding to the organization you are ordering this item for on your distributions. You cannot override the distribution accrual account.

Purchasing also ensures that you use the correct invoice price variance account for the receiving organization. Each time you enter an item on a purchase order, Purchasing defaults the invoice price variance account corresponding to the organization you are ordering this item for on your distributions. You cannot override the distribution invoice variance account.

### Inventory Funds Checking Methods

One way in which you can budget and funds check the inventory purchases you make for a given subinventory is by setting up an encumbrance (i.e. budget) account for the subinventory, and not reversing the encumbrance on receipt/delivery. This way, the encumbrance will accumulate as an actual and can be compared with the account budget for actual purchases to budget analysis. You cannot use the subinventory asset account in the funds available calculation ( $FA = Budget - Enc - Actuals$ ), because this account will only contain the current value of the subinventory or the net of received and delivered items currently in the subinventory, and will not track to the accumulated purchases for the subinventory. To use this method of funds checking, you must set the Reverse Encumbrance flag in the Organization Parameters window to *No*. See: *Inter-Organization Transfer Accounts, Oracle Inventory User's Guide*.

An alternative method of funds checking inventory purchases is by setting up a summary account and performing a funds check against that summary account. To provide an accurate picture of the funds available, you need to take into account:

- The outstanding commitments/obligations for inventory and expense purchases
- The current value of inventory
- The amounts purchased for inventory, but already issued out of the subinventory to either expense accounts within the "department" (summary account) or to other "departments" (other summary accounts)

Funds available = Budget

less amount on open commitments/obligations (either for inventory, or for expense accounts within the department)

less current inventory value

less value of material 'expensed' to accounts with the department

The following example illustrates some of the transactions and their impact on the funds available:

---

Summary (Department X)					
Subinventory Asset Account 'x1'	Subinventory Encumbrance Account 'x2'	Budget Account 'xbud'	Department Expense 'xA'	Department Expense 'xB'	Department Expense 'xC'

Summary (Department Y)					
Subinventory Asset Account 'y1'	Subinventory Encumbrance Account 'y2'	Budget Account 'ybud'	Department Expense 'yA'	Department Expense 'yB'	Department Expense 'yC'

---

- Requisitions and purchase orders for expense purchases will create commitments/obligations against expense accounts (xA, xB, xC), *decreasing* the funds available for Department X
- Receipt and Delivery of expense purchase orders (or invoicing for period end accruals) will create the actuals to the department expense accounts (xA, xB, xC), and reverse the encumbrance in those same accounts
- Requisitions and purchase orders for inventory purchases will create commitments/obligations against the encumbrance account (x2, y2). We use a different account than the asset account to ensure that we do not distort the value in the asset account (which should only contain the value of the material in the given subinventory). The requisitions and purchase orders will *decrease* funds available for the department.
- Receipt and Delivery of inventory purchase orders will reverse the encumbrance against x2/y2 and create actuals to the subinventory asset account, having *no net impact* against funds available
- Inventory issues from x1 to xA, xB, or xC will not be funds checked and will have *no net impact* on funds available
- Inventory issues from x1 to Department Y expense accounts (yA, yB, or yC) will *increase* Department X's funds available and *decrease* Department Y's funds available
- Inventory transfers from x1 to y1 will also *increase* Department X's funds available, and *decrease* Department Y's funds available.

**Note:** If you want to use encumbrances and budgetary control for inventory transfers or issues to expense accounts, you can use internal requisitions.

If you are using Period End Accruals, the encumbrance reversals are created with the accrual entries for the month end. You should reverse these journal entries in the beginning of the next period.

If you are accruing At Receipt, the delivery transaction reverses the encumbrances (and creates the debit to the charge account and the credit to the receiving/inspection account).

**Note:** A direct receipt in purchasing performs both the debit and credit transactions.

## Accrual Process for Perpetual Accruals

Use perpetual accruals for expense purchases when you want to record uninvoiced receipt liabilities *immediately* upon receipt of goods. Receipts for inventory purchases are always accrued upon receipt. Other key points of perpetual accruals include:

- Actual journal entries are created for the amount of the receipt liabilities, debiting the receiving inspection account and crediting the expense accrual liability account.
- Accrual journal entries are created when you enter receiving transactions. Purchasing creates adjusting journal entries if you correct your receiving transactions.
- Perpetual accrual entries do not need to be reversed at the start of a new accounting period.
- If you are using encumbrance accounting, purchase order encumbrance is relieved when the goods are delivered to their final destination, either by a delivery or a direct receipt.

**Important:** If you accrue expense purchases at the time of receipt, you must reconcile the entries in the A/P accrual accounts. In addition, if you also receive inventory, you need to use the Receiving Value By Destination Account Report to break out your receiving/inspection value by asset and expense.

## Purchase Order Receipt to Receiving Inspection

When you receive material from a supplier into receiving inspection, Purchasing uses



the quantity received; the purchase order price; nonrecoverable tax if any; and, if the purchase order is in a foreign currency, exchange rate, to update the accrual and the receiving inspection account. (If the purchase order is in a foreign currency, the exchange rate comes from the receipt if the Invoice Match Option in the purchase order Shipments window is Receipt and from the purchase order if the Invoice Match Option is Purchase Order.) The accounting entries for inventory receipts are:

Account	Debit	Credit
Receiving Inspection account at PO price	XX	
Inventory A/P Accrual account at PO price		XX

The accounting entries for expense destination receipts are:

Account	Debit	Credit
Receiving Inspection account at PO price	XX	
Expense A/P Accrual account at PO price		XX

**Important:** For clarity, the accounting entries in this section refer to the Inventory A/P Accrual Account and the Expense A/P Accrual Account. These are the accounts you typically use as your purchase order distribution accrual accounts for inventory and expense destinations. You can use the Account Generator to define the business rules you want Purchasing to use to determine the actual purchase order distribution accrual account. Purchasing uses the accrual account on the purchase order distribution for all receipt accrual entries.

For expense destinations, the PO distribution accrual account is the Expense A/P Accrual Account set in the Purchasing Options window. For inventory destinations, the purchase order distribution accrual account is the Inventory A/P accrual account for the receiving organization. The accrual accounts are the liability accounts that offset the material and expense charge accounts. They represent all inventory and expense receipts not matched in Payables.

### Delivery From Receiving Inspection to Inventory

With the Receiving Transactions window, you can move material from receiving inspection to inventory. See: Receiving Transactions, page 9-39.

For standard costing, when you enter a delivery transaction in Purchasing and move

the items to inventory, Inventory generates a purchase price variance transaction. Inventory books this transaction as a period expense for the current accounting period. If the standard cost is greater than the purchase order price, then the purchase price variance is favorable. Inventory records the expense as a credit (negative expense). If the standard cost is less than the purchase order price, then the variance is unfavorable. Inventory records the expense as a debit (positive expense).

For average costing, when you enter a delivery transaction in Purchasing, the system recalculates the average cost for the inventory organization with the incoming purchase order value. You do not have any purchase price variance for average costing.

For periodic costing, when you enter a delivery transaction in Purchasing, the system recalculates the periodic average cost for the period based on the periodic acquisition cost. See: Processing Periodic Acquisition Costs, *Oracle Cost Management User's Guide*.

Inventory uses the quantity; the purchase order price; nonrecoverable tax if any; and, if the purchase order is in a foreign currency, exchange rate, of the delivered item to update the receiving inspection account and the quantity. Inventory uses the standard cost of the delivered item to update the subinventory balances. The standard cost is in the functional currency. The accounting entries are:

Account	Debit	Credit
Subinventory accounts at standard cost	XX	
Receiving Inspection account at PO price		XX
Debit/Credit Purchase Price Variance		

### Delivery From Receiving Inspection to Expense Destinations

With the Receiving Transactions window, you can also move material from receiving inspection to expense destinations. See: Receiving Transactions, page 9-39.

When you enter a delivery transaction in Purchasing and move the items to an expense location, Purchasing uses the transaction quantity; the purchase order price; nonrecoverable tax if any; and, if the purchase order is in a foreign currency, exchange rate, of the delivered item to update the receiving inspection and expense charge account. (If the purchase order is in a foreign currency, the exchange rate comes from the receipt if the Invoice Match Option in the purchase order Shipments window is Receipt and from the purchase order if the Invoice Match Option is Purchase Order.) The accounting entries are:

<b>Account</b>	<b>Debit</b>	<b>Credit</b>
PO distribution charge accounts at PO price	XX	
Receiving Inspection account at PO price		XX
Encumbrance at PO price	XX	
Reserve for Encumbrance at PO price		XX

### **Purchase Order Receipt to Inventory**

You can use the Receipts window to receive material directly from a supplier to inventory. See: *Managing Receipts*, page 9-21. Please note that this section addresses inventory destinations only.

When you receive material from a supplier directly to inventory, Purchasing and Inventory perform the receipt and delivery transactions in one step.

Purchasing uses the quantity received; the purchase order price; nonrecoverable tax if any; and, if the purchase order is in a foreign currency, exchange rate, to update the accrual and the receiving inspection account. (If the purchase order is in a foreign currency, the exchange rate comes from the receipt if the Invoice Match Option in the purchase order Shipments window is Receipt and from the purchase order if the Invoice Match Option is Purchase Order.) The accounting entries are:

<b>Account</b>	<b>Debit</b>	<b>Credit</b>
Receiving Inspection account at PO price	XX	
Inventory A/P Accrual account at PO price		XX

Inventory uses the quantity and standard cost of the received item to update the receiving inspection and subinventory balances. The accounting entries are:

<b>Account</b>	<b>Debit</b>	<b>Credit</b>
Subinventory accounts at standard cost	XX	
Receiving Inspection account at PO price		XX

Account	Debit	Credit
Debit/Credit Purchase Price Variance		

If you use average costing, the system recalculates the average cost at receipt, and you do not have any purchase price variance.

The Inventory A/P Accrual account is the liability account that offsets the material accounts, and represents all inventory receipts not matched in Payables.

### Purchase Order Receipt to Expense Destinations

You can use the Receipts window to receive material directly from a supplier to the expense destination. See: Managing Receipts, page 9-21. Please note this section addresses expense destinations only.

When you receive material from a supplier directly to expense destinations, Purchasing performs the receipt and delivery transactions in one step.

Purchasing uses the quantity received; the purchase order price; nonrecoverable tax if any; and, if the purchase order is in a foreign currency, exchange rate, to update the accrual and the receiving inspection account. (If the purchase order is in a foreign currency, the exchange rate comes from the receipt if the Invoice Match Option in the purchase order Shipments window is Receipt and from the purchase order if the Invoice Match Option is Purchase Order.) The accounting entries are:

Account	Debit	Credit
Receiving Inspection account at PO price	XX	
Expense A/P Accrual account at PO price		XX

Purchasing uses the quantity received; the purchase order price; nonrecoverable tax if any; and, if the purchase order is in a foreign currency, exchange rate, to update the receiving inspection and expense accounts. (If the purchase order is in a foreign currency, the exchange rate comes from the receipt if the Invoice Match Option in the purchase order Shipments window is Receipt and from the purchase order if the Invoice Match Option is Purchase Order.) The accounting entries are:

Account	Debit	Credit
PO distribution charge accounts at PO price	XX	

Account	Debit	Credit
Receiving Inspection account at PO price		XX
Reserve for Encumbrance at PO price	XX	
Encumbrance at PO price		XX

### Match, Approve, and Create Accounting Entries for an Invoice

In Payables, when you are matching an invoice to a purchasing document, if the Invoice Match Option in the purchase order Shipments window is Purchase Order, then you match each invoice distribution to a purchase order distribution. If the Invoice Match Option is Receipt, then you match each invoice distribution to a purchase order distribution for the received transaction. You can set up Payables to ensure that you pay only for the quantity you received.

If you accrue at receipt, and if you use encumbrance, then during the Payables Approval process, Payables makes any encumbrance adjustments for price and exchange rate variances, including nonrecoverable tax, between the invoice and the purchase order (or receipt, if the invoice is matched to a receipt). Also, if your encumbrance types are different for purchase orders and invoices, then Payables creates appropriate entries. For details on how Payables calculates variance amounts, see: Invoice Variances, *Oracle Payables User's Guide*. To see the accounts that Payables uses to record the variances, see: Variance Accounts, *Oracle Payables User's Guide*

When Payables records the accounting entries for the invoice, any variances are recorded as actuals and the encumbrances are reversed. Payables then credits the Liability account for the full amount of the invoice, and debits the accrual account for the remaining amount (invoice price - invoice price variance - exchange rate variance).

**Important:** Normally, you charge the original expense account for any invoice price variances. Purchasing uses the Account Generator to set your purchase order distribution variance account to be the same as your purchase order charge account. If you want to record your invoice price variances to a separate account, use the Account Generator to define the business rules you use to determine the correct invoice price variance account.

### Invoice Exchange Rate Variances

Note that Purchasing uses the functional currency for your ledger in all receiving accounting entries. Purchasing converts foreign currency purchase order prices to the functional currency using the currency conversion rate from the purchase order.

Payables uses the currency and the conversion rate of the invoice when it creates accounting entries for the invoice. If the conversion rate differs between the purchase order (or the receipt, if the Invoice Match Option in the purchase order Shipments window is Receipt) and the invoice, then the conversion difference is recorded as an Exchange Rate Variance. Separate accounts are defined for exchange rate gains and losses, which record currency gains and losses within Payables, for example, between invoice time and payment time.

### **Return to Supplier From Receiving**

You use the Returns window to return material from receiving inspection or from inventory to a supplier. If you use receiving inspection and you have delivered the material into inventory, you must first return the goods to receiving before you can return to your supplier. For a return from inspection, Purchasing decreases the receiving inspection balance, and reverses the accounting entry created for the original receipt. See: Returns, page 9-66.

### **Return To Supplier From Inventory or Expense Destinations**

When you do not use receiving inspection, the return to supplier transaction updates the same accounts as the direct receipt to the inventory or expense destination, with reverse transaction amounts.

### **Period-End Reconciliation Tasks**

When you use perpetual inventories, you should balance your inventory accounts to your inventory value report. You should also review the general ledger journal transactions for inventory Purchase Price Variance and A/P Accrual Accounts. You should look for potential problems or errors such as transactions charged to the wrong account and duplicate transactions. This process is called the Inventory Reconciliation and Period Close Review. Purchasing and Inventory provide you with a set of reports you can use to reconcile your transactions with your general ledger account balances quickly and easily.

### **Period-End Checklist**

Before reconciling your transactions with your general ledger account balances, you should perform the following steps:

1. Identify the period you want to reconcile and close.
2. Enter all receiving transactions for goods and services you received during the period.
3. Enter and match all invoices you received during the period for your receipt accrual entries.
4. Perform the GL Transfer in Inventory and reconcile your Inventory Purchase Price

Variance and A/P Accrual entries.

5. Identify the period-end balances of the following accounts in your general ledger:
6. Purchase Price Variance
7. A/P Accrual Account
8. Inventory Accounts
9. Reconcile the balance of the Purchase Price Variance account using the Purchase Price Variance Report (detailed below).
10. Identify the Invoice Price Variances amount and Accrued Receipts amounts in the A/P Accrual Account (detailed below).
11. Manually remove the Invoice Price Variance amount from the A/P Accrual Account using your general ledger (prior release IPV only).
12. Close your accounts payable period corresponding to the purchasing period for your receipts accrual entries. See: Controlling the Status of AP Accounting Periods, *Oracle Payables User's Guide*.
13. Perform period-end accruals steps for purchasing and one-time items as described in the following section.
14. Close the period in Purchasing, (You do not need to reverse any journal entry batch in the following period). See: Controlling Purchasing Periods, page 1-82.
15. Close your Inventory period after review. See: Maintaining Accounting Periods, *Oracle Inventory User's Guide*.
16. Close your General Ledger period after review.

## Monitoring Price Variances

Purchasing provides you with reports you can use to review the purchase and invoice price variances. You should run the Purchase Price Variance Report weekly to review the accuracy of standard costs and purchase price variance. The Purchase Price Variance Report is also a good indicator of buyer's performance. However, you should make sure to include in your analysis any fluctuation of market prices beyond buyer control or changes in standard costs. At the end of a period, you should run the Purchase Price Variance Report for the entire period. See: Purchase Price Variance Report, page 11-53.

You should run the Invoice Price Variance Report monthly to review the accuracy of standard costs and purchase order prices. The Invoice Price Variance Report is also a good indicator of buyers' performance. However, you should make sure to include in

your analysis any pricing fluctuations beyond buyer control.

You can sort the Invoice Price Variance Report by Category or Supplier, and you can restrict your report to invoice price variances for a specific Category, Supplier, or Period Name.

At the end of a period, you should run the Invoice Price Variance Report for this period. Identify the invoice price variance for all purchase orders charged to the Inventory A/P Accrual Account and compare it with the balance of the Invoice Price Variance account in your general ledger. See: Invoice Price Variance Report, page 11-21.

## Reconciling AP Accrual Accounts Balance

At any given time, the balance of the AP (Accounts Payable) accrual accounts can account for the following transactions:

- Uninvoiced Receipts
- Over-invoiced Receipts
- Errors (Invoices or inventory transactions charged to this Account by mistake)

You need to analyze the balance of the AP accrual accounts, distinguish accrued receipts from invoice price variances, and identify errors.

## Analyzing the AP Accrual Account Balance

You need to monitor potential problems with purchasing and receiving activities that can affect the accuracy of your AP accrual accounts. You can use the Accrual Reconciliation Report to identify the following problems in receiving, purchasing, inventory, work in process, or accounts payable transactions:

- Quantities differ between receipts and invoices
- Incorrect purchase order or invoice unit prices (previous releases only)
- Discrepancies in supplier billing
- Invoice matched to the wrong purchase order distribution (or for receipt-matched invoices, the wrong purchase order distribution for the receipt transaction)
- Received against the wrong purchase order or order line
- Miscellaneous inventory or work in process transactions that do not belong to the accrual accounts
- Payables entries for tax and freight that do not belong to the accrual accounts



## Using the Accrual Reconciliation Reports

Use the accrual reconciliation reports to analyze the balance of the AP accrual accounts. To submit this report, you must have Oracle Purchasing and Payables installed. You can accrue both expense and inventory purchases as you receive them. When this happens, you temporarily record an accounts payable liability to your Expense or Inventory AP accrual accounts. When Oracle Payables creates accounting entries for the invoice, Payables clears the AP accrual accounts and records the liability from the supplier site. There are three accrual reconciliation reports:

- Summary Accrual Reconciliation Report, page 11-82
- AP and PO Accrual Reconciliation Report,
- Miscellaneous Accrual Reconciliation Report,

Typically, you run the accrual reconciliation reports at month end. After you have entered your receipt transactions and matched your invoices, you can run the accrual reconciliation reports for any transaction date range and identify any differences between your PO Receipts and AP Invoices. The reports display any miscellaneous transactions recorded in error to your accrual accounts. These miscellaneous transactions or transactions unrelated to purchase order receipts may be from Payables, Inventory, or Work in Process (depending on your installation). After you have researched the reported accrual balances, you can use the Accrual Write-Off form to indicate which entries you wish to remove and write off from this report. And, after you have written off these entries, you can use the Accrual Write-Off Report as supporting detail for your manual journal entry.

## Resolving Quantity Differences

The accrual reconciliation reports let you easily identify quantity differences (i.e., when the quantity received for a purchase order shipment is smaller than the quantity invoiced). Such differences leave residual balances that never clear from the AP accrual accounts. You should investigate the cause of these differences and take corrective actions before closing your period.

Common causes of quantity differences include late inventory receipts, incorrect receipt quantities, and supplier overbilling. To correct late receipts, ensure that receivers enter all receipts into inventory. To correct receipt quantities, enter receipt corrections. To correct overbilling errors, follow your standard procedure for supplier debit memos to clear the difference.

## Resolving Price Differences

The accrual reconciliation reports lets you determine how much you should have paid and whether the PO or invoice is correct. Such differences leave residual balances that never clear from the AP accrual accounts. You should investigate the cause of these differences and take corrective actions before closing your period.

## Accrual Process for Period-End Accruals

Key points for accruing expense purchases at period-end include:

- You record the total uninvoiced receipt liabilities accrued during the accounting period.
- Actual journal entries are created for the amount of the receipt liabilities, debiting the charge account and crediting the PO distribution accrual account (normally the Expense A/P Accrual Account defined in the Define Purchasing Options form).
- You reverse accrual journal entries manually at the start of the new accounting period. The accrual entries are reversed through complete multi-period accounting request on the first day of the next period.
- If you are using encumbrance accounting, purchase order encumbrance is relieved when the invoice(s) matched to the purchase order are posted to the general ledger.

## Receiving Transactions

Purchasing does not record any accounting entries for expense during a receiving transaction if you use period-end accruals. You record all of your uninvoiced liabilities at month end using the Receipt Accruals - Period-End process. See: Receipt Accruals - Period End Process, page 13-25.

## Receipts Accruals-Period End

Use the Receipt Accruals - Period End process to create period-end accruals for your uninvoiced receipts for expense distributions. Purchasing creates an accrual journal entry in your general ledger for each expense distribution having uninvoiced receipt you choose using this form. If you use encumbrance or budgetary control, Purchasing reverses your encumbrance entry when creating the corresponding accrual entry.

Purchasing never accrues an uninvoiced receipt twice. Each time you create accrual entries for a specific purchase order distribution, Purchasing marks this purchase order distribution as accrued and ignores it the next time you run the Receipt Accrual - Period-End process. Purchasing creates accrual entries only up to the quantity the supplier did not invoice for partially invoiced receipts.

Purchasing creates the following accounting entries for each distribution you accrue using the Receipt Accruals - Period-End process:

Account	Debit	Credit
PO charge account at Uninvoiced Quantity x PO unit Price	XX	

Account	Debit	Credit
Expense A/P accrual account at Uninvoiced Quantity x PO price		XX

As soon as you open the next period, Purchasing reverses the accrual entries using the following accounting entries. The Complete Multiperiod Accounting program reverses the actual entries on the first day of the next period.

Account	Debit	Credit
Expense A/P accrual account at Uninvoiced Quantity x PO unit price	XX	
PO charge account at Uninvoiced Quantity x PO Price		XX

**Note:** Purchasing adds nonrecoverable tax, if any, to the unit price and includes the exchange rate if the purchase order is in a foreign currency. The exchange rate comes from the receipt if the Invoice Match Option in the purchase order Shipments window is Receipt, from the purchase order if the Invoice Match Option is Purchase Order.

### Match, Approve, and Create Accounting Entries for an Invoice

When you enter an invoice in Payables, you match each invoice distribution to a specific purchase order distribution or to a purchase order distribution for a receipt transaction in Purchasing. You can set up Payables to ensure that you pay only for the quantity you received. If you accrue your uninvoiced receipts at period-end, Payables records the expense transactions part of the accounting transactions.

**Important:** Normally, you charge the original expense account for any invoice price variances, so your PO distribution variance account is the same as the PO distribution charge account. You do not record invoice price variances for expense purchases. Purchasing uses the Account Generator to set your purchase order distribution variance account to be the same as your purchase order charge account. If you want to record your invoice price variances to a separate account, use the Account Generator to define the business rules you use to determine the correct invoice price variance account.

## Complete Period Transactions

If you use encumbrance or budgetary control, Purchasing creates encumbrance journal entries in your general ledger each time you approve a purchase order. Similar to accrual journal entries, encumbrance journal entries recognize a liability towards your supplier before any invoicing transactions occur. Unlike accrual journal entries, encumbrance journal entries are not actual transactions. General Ledger tracks actual and encumbrance journal entries and balances separately.

## Period-End Checklist

Purchasing provides you with complete flexibility and control for your period-end accruals. You can use the Uninvoiced Receipts Report to analyze your uninvoiced non-inventory receipts before you accrue these receipts. You can then use the Receipt Accruals - Period-End process as many times as you want to generate accrual entries for the vendor or category you choose.

For your period-end reconciliation, you should perform the following steps:

1. Identify the purchasing period you want to reconcile and close.
2. Enter all receiving transactions for goods and services you received during the period. Purchasing automatically creates receipt accruals for all receipts you entered up to the end of this period. To prevent any period-end disruption, Purchasing lets you provide a receipt date that is different from the date you enter the receipts. You never have to enter all the receipts for a period before the end of this period. You can enter these receipts later. You simply need to back date the receipt date.
3. Enter and match all invoices you received during the period for your receipt accrual entries. You should make sure that you solve all posting holds problems in Payables before accruing receipts. Purchasing creates accrual journal entries for all purchase orders you received and did not match to an invoice. If you matched a purchase order or receipt to an invoice, Purchasing does not accrue the corresponding receipts. Purchasing does not accrue any purchase order that you closed on or before the end of the accrual period you choose. If the invoice is on posting hold, Payables has not yet accounted for the liability corresponding to the invoice. Under these conditions, the liability corresponding to this invoice would not appear in your books for the period. Payables lets you recognize this liability in the following period.
4. Close your accounts payable period corresponding to the purchasing period for your receipt accrual entries.

**Note:** The List of Values for period end accruals does not require the Accounts Payable period to be closed, however it's strongly

recommended that closed periods are used, as the receipt accruals process will not pick up invoices entered after the accruals process is run for the period.

5. For period-end accruals of expense purchases, run the Uninvoiced Receipts Report. Use this report to analyze your uninvoiced receipts. The Uninvoiced Receipts Report lets you use the same selection criteria for your uninvoiced receipts as the Receipt Accruals - Period-End process. You always know exactly what you accrue and for what amount.
6. For period-end accruals of expense purchases, use the Receipt Accruals - Period-End process as many times as you need. You can use the search criteria to choose what you want to accrue and accrue your receipts step by step. You create accruals for a specific purchasing period. Purchasing automatically accrues all uninvoiced receipts you entered up to the end of the accrual period you specify. See: Receipt Accruals - Period End Process, page 13-25.

Each time you use the Receipt Accruals - Period-End process, Purchasing creates a batch in Receiving Subledger for your receipt accruals. It also creates accounting events in SLA. If you are using encumbrance, Purchasing creates another set of accounting events in SLA in your general ledger corresponding to the encumbrance reversal entries for the uninvoiced receipts you accrued.

Purchasing never accrues your uninvoiced receipt twice. Each time you create accrual entries for a specific uninvoiced receipt, Purchasing marks this receipt as accrued and ignores it the next time you use the Receipt Accruals - Period-End process. Purchasing creates accrual entries only up to the quantity your supplier did not invoice for your partially invoiced receipts.

7. Post Accrual and Encumbrance Reversal journal entry batches in your general ledger. (See the following section to identify Accrual and Encumbrance Reversal journal entry batches.) Run Create Accounting - Cost Management for process category receiving to create accounting in SLA.

**Note:** If you are using encumbrance then you don't need to run the Create Accounting - Cost Management as Receipt Accruals - Period-End creates the accounting in SLA automatically.

8. Transfer to general ledger from SLA using Transfer Journal Entries to GL - Cost Management for Process Category Receiving. You can provide the general ledger batch name while transferring to general ledger so that you can identify the batch in general ledger.
9. Post Accrual and Encumbrance Reversal journal entry batches in your general ledger.

10. Perform all the steps you need to close your accounting period and generate your period-end reports and financial statements in your general ledger.  
Use your general ledger system to reverse all the receipt accrual and encumbrance reversal batches you created for your period-end accruals.
11. Close the purchasing period for your receipt accruals. When you close a purchasing period, Purchasing automatically un-marks all the receipts you previously accrued to make sure you can accrue these receipts again if they are still uninvoiced in the next period. See: Uninvoiced Receipts Report, page 11-90.
12. Run Complete Multiperiod accounting which automatically reverses the accrual entries on the first day of next period

## Identifying Journal Entry Batches in General Ledger

Purchasing creates accrual journal entries in your general ledger when you accrue receipts. If you use encumbrance, Purchasing also creates encumbrance reversal journal entries corresponding to the receipts you accrued. Purchasing automatically names journal entry batches, headers, and lines for you. The names Purchasing uses to create batches are the following:

### Period-End Accruals

Purchasing creates one batch each time you run the Receipt Accruals - Period-End process. Purchasing creates one header for each purchase order you accrue. See: Receipt Accruals - Period End Process, page 13-25.

### Journal Entry Batches

- Batch Name: PO/Accruals/[current date and time]/Batch: [JE\_BATCH\_ID of the Accruals Batch]
- Batch Type: Actual
- Batch Status: Unposted
- Period: [Accrual Period]
- Debits: [Sum of all debits for all headers]
- Credits: [Sum of all credits for all headers]

### Journal Entry Headers

- Header Name: Accrue/PO [PO Number-Release Number]

- Category: Accrual
- Source: Purchasing
- Currency: [PO Currency]
- Reverse: Yes
- Reverse to Period: [Next Period]
- Debits: [Sum of all debits for all lines]
- Credits: [Sum of all credits for all lines]

Purchasing creates two types of journal entry lines for each accrued receipt:

- Distribution Lines (one for each distribution of an accrued purchase order line)
- Accrued Receipt Lines (one for each accrued purchase order line)

Purchasing creates one line for each purchase order distribution you accrued on the purchase order. Purchasing charges each line to the charge account on the purchase order distribution. Purchasing computes the accrual amount by prorating the quantity accrued for the purchase order shipment of the distribution to the quantity ordered on the distribution.

Purchasing creates one journal entry line charged to the PO distribution accrual account (normally the expense A/P accrual account). This line corresponds to the amount accrued for a purchase order. The amount accrued for a purchase order equals the sum of all uninvoiced receipts for this purchase order multiplied by the price for the corresponding purchase order shipments. The accrued receipt journal entry line balances all the distribution journal entry lines.

### **Distribution Journal Entry Lines**

- Account: [Charge Account for PO Distribution]
- Amount: [Shipment Price x Quantity Received for Shipment x Quantity Ordered on Distribution/Quantity Ordered on Shipment]
- Dr/Cr: Dr
- Description: Purchase Order Line Description

### **Accrued Receipt Journal Entry Lines**

- Account: [Accrual Account for PO Distribution]

- Amount: [Sum of all amounts for Distributions Journal Entry Lines for the same Header]
- Dr/Cr: Dr
- Description: Accrued Liability Account

### **Encumbrance Reversal**

Purchasing creates one batch each time you use the Receipt Accruals - Period-End process if you use encumbrance.

Note that Encumbrance Journal Entry Batches are unbalanced in General Ledger. General Ledger automatically offsets the Reserve for Encumbrance account with the balance of your encumbrance batch. You set up your Reserve for Encumbrance account when defining your ledgers. See: *Defining Ledgers, Oracle General Ledger User's Guide*.

Purchasing creates one header for each purchase order you accrue.

### **Journal Entry Batches**

- Batch Name: PO/Accruals/[current date and time]/Batch: [JE\_BATCH\_ID of the Encumbrance Batch]
- Batch Type: Encumbrance
- Batch Status: Unposted
- Period: [Accrual Period]
- Debits: 0.00
- Credits: [Sum of all credits for all headers]

### **Journal Entry Headers**

- Header Name: Rev Enc/PO [PO Number-Release Number]
- Category: Purchases
- Source: Purchasing
- Encumbrance Type: Obligation
- Currency: [PO Currency]
- Reverse: Yes



- Reverse to Period: [Next Period]
- Debits: 0.00
- Credits: [Sum of all credits for all lines]

Purchasing creates one line for each purchase order distribution you accrued on the purchase order. Purchasing charges each line to the account on the purchase order distribution. Purchasing computes the line amount by prorating the quantity accrued for the purchase order shipment of the distribution to the quantity ordered on the distribution.

### **Distribution Journal Entry Lines**

- Account: [Charge Account for PO Distribution]
- Amount: [Shipment Price x Quantity Received for Shipment x Quantity Ordered on Distribution/Quantity Ordered on Shipment]
- Dr/Cr: Cr
- Description: Purchase Order Line Description

### **Accrual Write Off**

If you choose the Perpetual Accrual Method within Purchasing, Purchasing records an accounts payable liability to an AP accrual account for goods received but not invoiced. When Payables matches and approves the invoice for the received goods, Payables clears the accounts payable accrual account and records the actual liability amount to the invoice accounts payable liability account.

You might want to reconcile those transactions that leave some balance (liability) in accrual accounts. This can be done with accrual reconciliation process. The following flow diagram illustrates the flow for the accrual reconciliation and the accrual write off process.

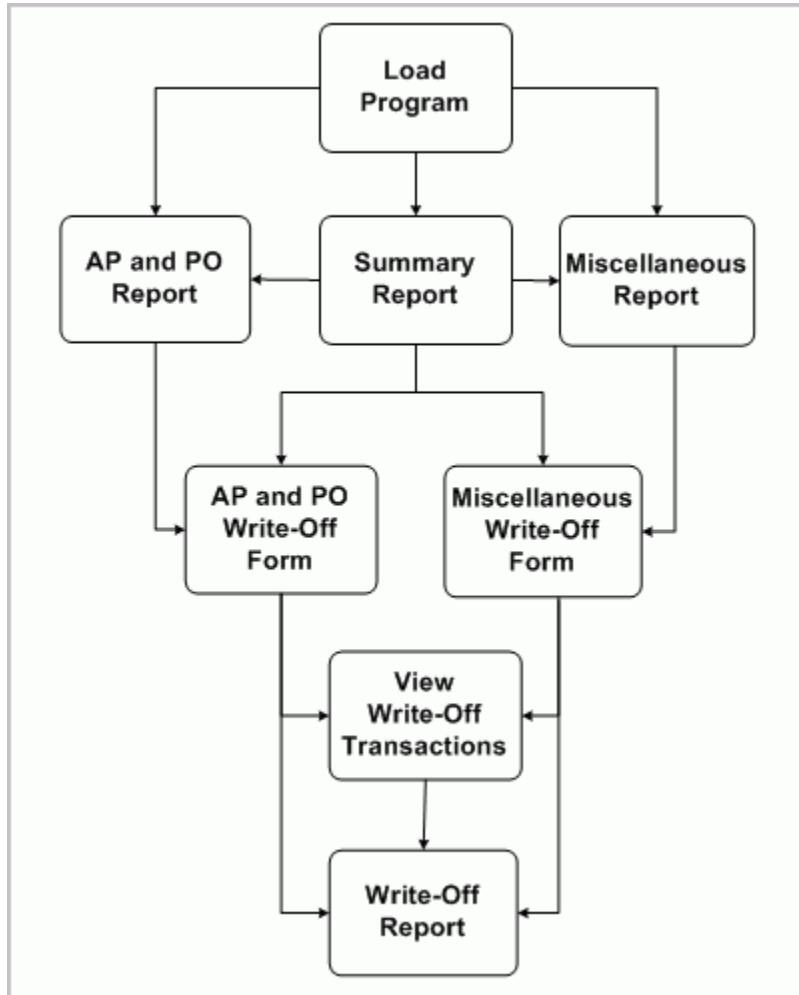

After you have entered your receipt transactions, matched and approved your accounts payable (AP) invoices, you will need to run the accounting process that creates the accounting for these transactions in the final mode and subsequently transfer these transactions to the general ledger. You can then begin the accrual reconciliation process by running the Accrual Reconciliation Load program. This program is used to populate the accrual reconciliation table with all the necessary transaction data for you to perform the reconciliation process. The load program can be run for an operating unit incrementally. The program requires the two parameters from date and to date. These two dates represent the transaction dates that are used to fetch the transaction information from the transaction tables. All the affected purchase order (PO) distributions (in the case of AP/PO transactions and individual transactions in the case of miscellaneous transactions) will be deleted first and the transaction information for these distributions are loaded into the accrual reconciliation tables. See: Accrual Reconciliation Load, .

Next you would run the Summary Accrual Reconciliation report to identify any differences between your Oracle Purchasing (PO) receipts and Oracle Payables (AP) invoices. This report shows which accounts have balances in them provides a partial

breakdown of the balance source. You can see whether related AP and PO transactions and/or miscellaneous AP and Oracle Inventory transactions are contributing to the balance. Furthermore, the report shows the amount of write-offs already performed against the accrual account. See: Summary Accrual Reconciliation Report, .

In addition, to aid in your analysis you can run the AP and PO Accrual Reconciliation Report and Miscellaneous Accrual Reconciliation Report. Each of the three reports can be run independently of each other as well as independent of the load program once the load program has been run and the data in the accrual reconciliation load tables is current.

The AP and PO Accrual Reconciliation Report provides a transactional breakdown of each accrual account with a net balance greater than zero in a summarized or full transaction details version. In summarized mode, for each accrual account, only the distribution information and PO, AP, WO (Write-Off) and Total Balances are displayed. For detailed mode, the individual transaction details for each distribution are also shown. You can also see the age of the distribution on this report. The report is first grouped by accrual account, then by aging bucket and then by purchase order distribution ID. Aging bucket is calculated depending on user specified value of "Aging period days" while submitting the report. Transactions are grouped according to their age into aging buckets. See: AP and PO Accrual Reconciliation Report, .

The Miscellaneous Accrual Reconciliation Report provides reporting of all the miscellaneous AP (not matched to PO or PO receipts) and Oracle Inventory transactions hitting accrual accounts. The report is first grouped by accrual account, then by each accrual code that hits the specific accrual account and then by purchase order distribution id. See: Miscellaneous Accrual Reconciliation Report,

After you have researched the reported accrual balances, you can use the AP and PO Accrual Write-Offs window to indicate which AP and PO transactions you wish to write off and remove from the AP and PO Accrual Reconciliation Report. You can use the Miscellaneous Accrual Write-Offs window to indicate which miscellaneous AP (not matched to PO) and Oracle Inventory transactions you wish to write off and remove from the Miscellaneous Accrual Reconciliation Report. See: AP and PO Accrual Write-Offs window, and Miscellaneous Accrual Write-Offs window, .

To complete the procedure you would review your write-offs using the View Write-Off Transactions window and then submit the Accrual Write Off Report. See: Accrual Write Off Report, .

## **Writing Off Accrual Transactions**

### **Prerequisites:**

- Oracle Payables and Purchasing are installed.
- Define your transactions reasons in Oracle Inventory's Transaction Reasons window. This gives you a means of classifying your write-offs so you can record them in separate accounts when you record a manual journal entry to write off these transactions. The Accrual Write Off Report provides a summary by

transaction reason. See: *Defining Transaction Reasons, Oracle Inventory User's Guide.*

- If you use Oracle Inventory and Work in Process, transfer to your general ledger transactions from these two sources.
- Transfer your Oracle Payables invoices to your general ledger. See: *Payables Transfer to General Ledger Program, Oracle Payables User's Guide.*

**To write off a transaction from an accrual account:**

1. Use the Select Accrual Accounts window to verify or define all the accrual accounts to be used when loading accrual data. See: *Select Accrual Accounts, .*
2. Run the Accrual Reconciliation Load Run program. See: *Accrual Reconciliation Load, .*
3. Run the Summary Accrual Reconciliation Report for the desired operating unit to find out which accounts have balances and the amount of those balances. See: *Summary Accrual Reconciliation Report, page 11-82.*
  - If a balance is in AP and PO transactions where AP is matched to PO or a PO receipt, run the AP and PO Accrual Reconciliation Report. See: *AP and PO Accrual Reconciliation Report, .*
  - If a balance is in other types of transactions, run the Miscellaneous Accrual Reconciliation Report. See: *Miscellaneous Accrual Reconciliation Report, .*
4. Examine the transactions.
  - If AP and PO transactions where AP matched to PO or a PO receipt, use the AP and PO Accrual Write-Offs window to view transactions by PO distribution. See: *AP and PO Accrual Write-Offs, .*
  - Otherwise, use the Miscellaneous Accrual Write-Offs window to view the transactions. See: *Miscellaneous Accrual Write-Offs, .*
5. Choose those transactions that are candidates for write-off and perform the write off.
6. Use the View Write-Off Transactions window to see the write-off transactions. You may also reverse the write-off transactions from this window. See: *View Write-Off Transactions, .*
7. [Optional] Run the Accrual Write-Off Report to see the history of write-off transactions See: *Accrual Write-Off Report, page 11-1.*
8. [Optional] Run the Summary Accrual Reconciliation Report to make sure that the balanced accounts do not appear in the report

## Select Accrual Accounts

Use this window to select the accounts to be evaluated by the Accrual Load program to select transactions for possible write off.

1. Navigate to the Select Accrual Accounts window.

Operating Unit: Vision Operations Find

Accrual Account

<input checked="" type="checkbox"/>	01-000-1210-0000-000
<input type="checkbox"/>	01-000-2210-0000-000
<input type="checkbox"/>	01-000-2215-0000-000
<input type="checkbox"/>	01-000-2220-0000-000
<input type="checkbox"/>	01-000-2225-0000-000
<input type="checkbox"/>	01-520-5210-0000-000
<input type="checkbox"/>	01-520-5220-0000-000
<input type="checkbox"/>	01-520-5360-0000-000
<input type="checkbox"/>	01-580-7740-0000-000
<input type="checkbox"/>	01-535-5220-0000-000

Get Default Accounts

2. Select the operating unit for the accrual accounts you are working on.
3. Click Get Default Accounts.

Clicking this button fetches the accrual accounts that were setup as accrual accounts in the prior releases in addition to the accrual accounts setup for each organization and the default accrual accounts from the Purchasing Options window for that operating unit.

4. Add or delete any accounts to be included in this write off analysis.
5. If you made any changes, click Save.

## AP and PO Accrual Write-Offs

Use this window to "write off" the selected AP matched to PO transactions, which will automatically generate an accounting event.

1. Navigate to the AP and PO Accrual Write-Offs window.
2. Use the Find window to narrow the number of transactions displayed in the write-off window.

Enter the operating unit for write offs. You can optionally enter the following search criteria: Account number, Balancing Segment range, Item number, item Description, PO Number, PO Release, PO Line, PO Shipment, PO Distribution, Destination Type, Age range, and a Balance range.

If you are confident of your search results, check Auto-Select Results for Write-Off to have all your results selected for write off.

3. Click Find.
4. Select the transactions you wish to write off.
5. Select the transactions that you want to write off.
6. Save your work. A pop-up window will appear for you to enter:

**Caution:** When the form is saved/committed, all write-off transactions selected will be written off and are cleared from this window.

- Enter a Write Off Date that is in the same accounting period as the journal entry you would prepare to write off selected transactions.
- [Optional] Enter a Reason why the selected transactions are being written off.
- [Optional] Enter a comment to provide more clarity to the reason for the write off.

AP and PO Accrual Reconciliation Report. They will appear on the Accrual Write Off Report.

AP/PO transactions are reconciled at purchase order distribution accrual account level. Hence write offs for these transactions are also performed at purchase order distribution accrual account level. The offset account for these transactions is defaulted from the distribution. The following set of rules determines the default offset account that is used to write the transaction off:

1. If the destination type on the PO distribution that is being written off is

expense, the default offset account used is the charge account on the PO distribution.

2. If the destination type on the PO distribution is inventory or shopfloor, the default offset account used is the variance account on the PO distribution.

### Miscellaneous Accrual Write-Offs

Use this window to "write off" the selected miscellaneous transactions, which will automatically generate an accounting event.

1. Navigate to the Miscellaneous Accrual Write-Offs window.
2. Use the Find window to narrow the number of transactions displayed in the write-off window.

Enter the operating unit for write offs. You can optionally enter the following search criteria: Account number, Balancing Segment range, Item number, item Description, Invoice Number, Invoice Line, PO Number, PO Release, PO Shipment, PO Distribution, Inventory Transaction Id, Date range, Amount range, and a Transaction Type. If the transaction type selected for filtering data is "Consignment" , then you can also specify an age range for these transactions.

If you are confident of your search results, check Auto-Select Results for Write-Off to have all your results selected for write off.

3. Click Find.
4. Select the transactions you wish to write off.
5. Save your work. A pop-up window will appear for you to enter:

**Caution:** When the form is saved/committed, all write-off transactions selected will be written off and the transactions are cleared from this window.

- Enter a Write Off Date that is in the same accounting period as the journal entry you would prepare to write off selected transactions.
- Enter an Offset account. This account will be used as an offset account to write off the transaction balance.
- [Optional] Enter a Reason why the selected transactions are being written off.
- [Optional] Enter a comment to provide more clarity to the reason for the write off.

Transactions that you selected to write off in this window will no longer appear on the Miscellaneous Accrual Reconciliation Report. They will appear on the Accrual Write Off Report.

In addition to the inventory transactions and non-matched AP invoices, Invoice Price Variance Distributions (IPV), Exchange Rate Variance distributions (ERV), Tax Invoice Price Variance (TIPV), Tax Exchange rate Variances (TERV), Tax Rate Variance distributions (TRV) are treated as miscellaneous transactions and need to be written off like any other miscellaneous transaction.

The accrual reconciliation also attempts to group the consigned transfer transactions in inventory with the accounts payable invoice that may have been matched to the consumption advice. If there is no balance in the accrual account as a result of the AP invoice clearing the accrual created by the consigned ownership transfer, these transactions are automatically deleted and they will not appear in the reconciliation tables, forms and reports.

### **View Write-Off Transactions**

Use this window to view the selected write-off transactions.

1. Navigate to the View Write-Off Transactions window.
2. Use the Find window to narrow the number of transactions displayed in the window.

Select the operating unit for write offs. You can also enter Account number, Balancing Segment range, Date range and Reason.

Optionally if you check AP-PO Write-Offs Only check box you can also enter PO Number, PO Release, PO Shipment and PO Distribution. If you check Miscellaneous Write-Offs Only check box, you can also enter Inventory Transaction Id, Invoice Number and Invoice Line.

AP-PO Write-Offs Only and Miscellaneous Write-Offs Only check boxes restrict data queried for to AP-PO write offs or Miscellaneous write offs respectively.

3. Click Find.
4. Review your write-off transaction and optionally select the transactions you wish to reverse.

A reverse write-off transaction reverses the accounts used by the write-off transaction that is being reversed. If you have customized any of the accounts that are being used on the write off transaction, the same account needs to be customized on the reverse write off transaction as well to make sure that the accounts stay cleared after the write off.

5. Save your work.



**Caution:** When the form is saved/committed, all write-off transactions selected will be reversed. A write off transaction can be reversed only once. If you want to write these transactions off again, you will need to create a new write-off transaction.

**To view the accounting:**

- From the Tools menu select View Accounting to view sub-ledger journal entry lines associated with the write-off transaction. This option is disabled if accounting has not been created for write-off transactions using the Create Accounting program in SLA .

**To view the accounting events:**

- From the Tools menu select View Accounting Events to view accounting entry lines associated with a write-off transaction.

## **Accounting for the Write Off transactions**

Accounting for the write off transactions includes journal entries for the accrual account and offset account. When the invoice is matched to receipt, the write off variance may be generated due to the exchange rate difference between the write-off date and various receipt dates. In some cases, there might be a balance left over in the accrual account due to rounding inconsistencies. If the Write off is performed in such a case, the accrual account is cleared by the write off transaction and the write off variance is generated against the write off variance account.

The following rules determine the default write off variance account that is used:

1. If the invoice is matched to purchase order, the write off variance account used is the variance account on the purchase order distribution.
2. If the invoice is matched to receipt and the destination type on the purchase order distribution is expense, the write off variance account used is the charge account on the distribution. If the destination type is non-expense, the write off variance account used is the exchange rate gain or loss account that has been setup for that operating unit.

## **Related Topics**

Defining Accrual Options, page 1-40

Setting Up Inventory Accruals, page 9-89

Defining Purchase Order Receipt Accruals, page 9-120

Overview of Receipt Accounting, page 9-86

Reconciling A/P Accrual Accounts Balance, page 9-102

## Automatic Offsets in Oracle Purchasing

### Receipt Accruals

The default Account Generator configuration in Oracle Purchasing builds a charge, budget, accrual, and variance account for each purchase order, release, and requisition distribution based on the distribution's Expense, or Inventory, destination type. Oracle Purchasing always builds these accounts using the Account Generator; you cannot disable this feature.

To populate the Accrual account for distributions with an Expense destination type, the Account Generator locates the Expense AP Accrual Account that you specify in Define Purchasing Options as part of your application setup and copies it into the Accrual Account in your document. The Account Generator then overlays the balancing segment of the AP Accrual Account with the balancing segment of the charge account so that your transactions always balance by fund.

### Defining Purchase Order Receipt Accruals

You can create balanced offsets for receipt accrual accounts in Oracle Purchasing by customizing the default configuration of the Account Generator to overlay the balancing segment of the AP Accrual Account with the balancing segment of the charge account so that your transactions always balance by balancing segment.

#### Prerequisites:

- Establish your Chart of Accounts. See: *Defining Your Chart of Accounts, Oracle General Ledger User's Guide*.
- See Prerequisites to Using the Account Generator in: *Decide How To Use the Account Generator*, page E-7.

#### To build Purchase Order Receipt Accrual Accounts:

1. Use the same Chart of Accounts you used to build the purchase order charge accounts by balancing segment, substituting the receipt accrual liability account for the expense account.

The Account Generator function is called from the Purchase Orders window to automatically create the receipt accrual liability accounts by balancing segment on each purchase order distribution.

**Important:** Use the same balancing segment for the charge account and the receipt accrual account so the receipt transactions will balance by balancing segment.

2. Customize your Account Generator process. See: Customizing the Account Generator for Oracle Purchasing, page E-24.

## Related Topics

Automatic Offsets in Oracle Purchasing, page 9-120

Defining Purchase Order Receipt Accruals, page 9-120

Defining Transaction Reasons, *Oracle Inventory User's Guide*

Accrual Reconciliation Report, page 11-82

Accrual Write Off Report, page 11-1

Overview of Receipt Accounting, page 9-86

## Integration with Landed Cost Management

Landed Cost Management (LCM) helps you capture all the costs related to a purchase such as freight, insurance, taxes (country, state, local etc). Landed Cost Management enables you to calculate landed cost of the item, which is taken into consideration for costing and accounting purposes. This helps customers to value goods at actual cost and also helps in complying with the country's fiscal/legal requirements.

There are two distinct types of Landed Cost Management practices followed by customers:

- All fiscal & commercial documents (e.g.: invoices) are received together with the goods. It is a legal requirement that all documents must be carried by the truck driver and delivered to the addressee along with the goods/products. In case of electronic documentation (e-invoices), the driver carries a report print-out referencing the e-invoice number that can be tracked by any tax authority in case of in-transit audits.
- In other situations you can define charge templates (freight, duty, insurance, etc) by vendor/item. When goods are received in the Receiving module, Landed cost is calculated based on the receipt quantity, charges in the template and item price, and then costing is carried out using the landed cost. In this scenario, charges are captured and landed cost is calculated in the background, without user intervention.

For information on Landed Cost Management with Purchasing, please refer to the Integration with Other Applications chapter, Landed Cost Management, page 12-4 section.

### Integration with Receiving

You can calculate landed costs in either of the following two methods:

- You can configure Oracle Inventory/WMS with LCM as a pre-receiving application,

to allow receipts of goods only after the landed cost is calculated in the Landed Cost Management module.

- You can configure Landed Cost Management not as a pre-receiving application, allowing the user to receive the goods without cost knowledge; this triggers Landed Cost Management in the background to capture costs from pre-defined templates and to calculate landed costs.

In both the cases Receiving captures unit landed cost from LCM for the corresponding receipt line and passes the information to Costing / Accounting modules based on the landed cost instead of purchase price. Landed Cost Management supports PO receipts with Destination type Inventory. For PO receipts with destination type OSP and Expense, RMA and internal requisition receipts are made without landed cost even in the LCM enabled organizations.

In Inventory > Setup > Organization > Organization Parameters, you can define Landed Cost integrations and in Receiving Parameters optionally define Landed cost as a pre-receiving application. LCM enabled flag indicates that PO receipts with destination type Inventory (PO shipments will be marked as LCM) in this organization are made with landed cost and all other receipts with PO price. The Find Expected Receipts window enables you to query an expected receipt with reference to its landed cost records in LCM by shipment ID or Supplier and create receipts in Oracle Inventory. Oracle Inventory takes the landed cost and uses it for the inventory cost calculations instead of purchase price. You can also use Mobile receiving to receive the goods vis-a-vis landed cost records in Landed Cost Management.

Alternatively, if Landed Cost Management is not pre-receiving, then you can receive the goods without landed cost; landed cost is calculated in the background before creating receipt transactions. Receipt transactions with Landed cost are identified with Landed cost Shipment Line ID in Oracle Inventory for cross reference at a later point of time.

If the Inventory Organization is integrated with Landed Cost Management and Landed Cost Management is a pre-receiving application: You cannot receive goods directly using Desktop/Mobile Receiving without referring to its landed cost records in Landed Cost Management. You can query expected shipments by PO, Line, Shipment, Supplier and LCMshipment to receive these receipts with reference to LCM shipments.

If the Inventory Organization is integrated with Landed Cost Management and Landed Cost Management is not a pre-receiving application then landed cost is calculated in the background and receiving transactions are created with LCM shipment ID reference.

You can perform standard inventory functions like Inspections, corrections, RTV etc using existing desktop and mobile functionality. If the original receipt is made with reference to landed cost records (Receipt transaction will have LCM Shipment line stamped) then Landed cost is used for costing these transactions otherwise regular purchase price is used.

### Viewing Action History

Use this window to review the action history-such as approvals, cancellations, and returns-for specific purchasing documents or document lines.

**To view action history:**

- Navigate to the Action History window by selecting View Action History from the Tools menu in the following windows:
  - Releases
  - Purchase Orders
  - Purchase Order Shipments
  - Purchase Order Distributions
  - Purchase Order Headers (Summary)
  - Purchase Order Lines (Summary)
  - Purchase Order Shipments (Summary)
  - Purchase Order Distributions (Summary)
  - Requisition Headers Summary
  - Requisition Lines Summary
  - Requisition Distributions Summary

Seq	Date	Rev	Action	Performed By	Note
1	16/JAN/2001	0	Approve	Stock, Ms. Pat	
0	16/JAN/2001	0	Submit	Stock, Ms. Pat	

Purchasing displays the document approval action Sequence number, the Date of the approval action, the Revision number, the Action performed (Accept, Approve, Approve and Reserve, Cancel, Forward, Import, Reject, Reserve, or Submit), the user whom the action was Performed By, and any Notes.

The Action History window displays only those actions that occurred at the document header or that affected the header. For example, if you changed a line, which incremented the document Revision number in the header, the Action History window displays the new document Revision number, not the line-level change that caused it.

When the Action field is empty, the Performed By field displays the name of the *employee* in whose approval queue the document currently resides.

## Related Topics

Using the Requisition Headers Summary Window, page 3-39

Using the Requisition Lines Summary Window, page 3-40

Using the Requisition Distributions Summary Window, page 3-42.

Using the Purchase Order Headers Summary Window, page 4-26.

Using the Purchase Order Lines Summary Window, page 4-30

Using the Purchase Order Shipments Summary Window, page 4-32.

Using the Purchase Order Distributions Summary Window, page 4-35

Using the Receiving Headers Summary Window, page 9-44

Using the Receiving Transaction Summary Window, page 9-45

Using the Receipt Header Details Window, page 9-50

Viewing Transaction Status Information, page 9-54

## Viewing Purchase Order Changes

The PO Change History menu item in the Oracle Purchasing Navigator gives you even more, at-a-glance detail about all past revisions made to archived purchase orders. This menu item uses a Web browser to display the archived revisions. You can then compare the current purchase order with a previous revision or view all past changes to the purchase order. You can see what fields changed and what the fields were before and after the change. This menu item is also part of Oracle iSupplier Portal, if you have access to the Purchasing responsibility within iSupplier Portal.

You can navigate to this window by selecting Change History in the Tools menu of the Purchase Order Summary window. If your organization has implemented the standard Oracle Purchasing menu, you can navigate to this window from the Purchasing responsibility, choose Purchase Orders and then PO Change History.





## Accrual Write-Off Report

The Accrual Write-Off Report to provide supporting detail for your write-off journal entries. The process is as follows. First, you analyze the Accrual Reconciliation Report for transactions that you should expense out of the accrual accounts. After you have researched the reported accrual balances, you then use the Accrual Write-Off window to indicate which entries you wish to remove and write off from this report. And, after you have written off these entries, you use the Accrual Write-Off Report as supporting detail for your manual journal entry.

For example, you may want to write off a miscellaneous inventory transaction that debited your Inventory AP accrual account. After you write off the transaction with the Accrual Write-Off window, the Accrual Write-Off Report displays a positive amount for your write-off. If you go back to the Accrual Write-Off window and reverse the write-off, the Accrual Write-Off Report displays a negative amount for your reversal, and a positive amount for the initial write-off.

Once you have completed the accrual reconciliation process, you can use this report to display written off transactions for the following problems in receiving, purchasing, inventory, work in process, or accounts payable transactions:

- Quantities differ between receipts and invoices
- Incorrect purchase order or invoice unit prices (previous releases only)
- Discrepancies in supplier billing
- Accounts payable matched invoice to wrong purchase order or purchase order line, or wrong receipt or receipt line
- Receiving clerk received against the wrong purchase order or wrong purchase order line

- Miscellaneous inventory or work in process transactions that do not belong to the accrual accounts
- Payables entries for sales tax and freight that do not belong to the accrual accounts. See: Overview of Receipt Accounting, page 9-86.

In addition, the Accrual Write-Off Report supports multiple AP accrual accounts in Purchasing. When you define your purchase order requisitions or orders, the Account Generator processes create your AP accrual accounts. Typically, you only use one AP accrual account for all of your inventory organizations. However, for certain situations you may want to use more.

## Prerequisites

Since this report displays transactions from purchase order receipts and accounts payable invoices, you must install Purchasing and Payables to run this report. If you have Inventory or Work in Process, the Accrual Write-Off Report also displays any inventory or work in process transactions you have written off.

## Report Submission

In the Submit Requests window, select Accrual Write-Off Report in the Name field.

## Report Parameters

### Operating Unit

Select the operating unit for this report.

### Title

Enter your title for this run of the report.

### Balancing Segment From

Lower limit of balancing segment range to use for this report.

### Balancing Segment To

Upper limit of balancing segment range to use for this report.

### Minimum Write-Off Amount

Lower limit of amount range to use for this report.

### Maximum Write-Off Amount

Upper limit of amount range to use for this report.

### Write-Off Dates From

Enter the beginning general ledger date. Usually, this is the beginning date of the accounting period.

### Write-Off Dates To

Enter the ending general ledger date. Usually, this is the ending date of the accounting period.

### Write-Off Reason

Enter a specific write-off reason.

### Print Comments

Enter Yes or No to indicate whether you want to print your write-off comments on the report.

### Sort By

Select a value to determine how to sort write-off transaction data

**Valid Values** Date (Default), Amount, Reason, Offset Account

### Related Topics

Overview of Receipt Accounting, page 9-86

## Advanced Shipment Notice Discrepant Receipts Report

For each Advance Shipment Notice (ASN) sent to you by your supplier, the Advanced Shipment Notice Discrepant Receipts report checks for overshipped or unfulfilled shipments. It looks for discrepancies between what the ASN said was shipped and what you actually received. In addition, these discrepancies are sent to the Oracle e-Commerce Gateway process responsible for generating Application Advices. (For example, Application Advices are sent back to suppliers detailing errors that occurred when the suppliers sent ASNs.)

**Note:** Goods returned to a supplier are considered shipped. For example, if a supplier promised to ship 200 items and you received 200 items but returned 40, this is not considered a discrepant receipt.

### Report Submission

In the Submit Requests window, select Advanced Shipment Notice Discrepant Receipts

in the Name field.

## Report Parameters

### Start Date / End Date

The report evaluates discrepancies for expected receipt dates that fall within the date range you enter. It also sends information to e-Commerce Gateway for the generation of Application Advices, if the expected receipt date of the shipment falls within the date range you enter.

## Related Topics

Submitting a Request, *Oracle Applications User's Guide*

Advance Shipment Notices (ASNs), page 9-15

## AP and PO Accrual Reconciliation Report

The purpose of this report is to show all Oracle Payables (AP) and Oracle Purchasing (PO) transactions where the AP transactions are matched to PO (could be receipt as well). The AP and PO Accrual Reconciliation Report provides a transactional breakdown of each accrual account with a net balance not equal to zero in a summarized or full transaction details version. In summarized mode, for each accrual account, only the distribution information and PO, AP, WO (Write-Off) and Total Balances are displayed. For detailed mode, the individual transaction details for each distribution are also shown.

You can also see the age of the distribution on this report. Age of the distribution is calculated based on the value of a system profile "CST: Age in Days". If this profile is set to "Last Receipt Date", then age is calculated based on the date of the latest receipt transaction corresponding to this distribution. If the profile is set to "Last Activity Date" then age is calculated based on date of the latest invoice or receipt transaction corresponding to this distribution.

The report is first grouped by accrual account, then by aging bucket and then by purchase order distribution ID. Aging bucket is calculated depending on user specified value of "Aging period days" while submitting the report. Transactions are grouped according to their age into aging buckets

Usually this report is run in conjunction with the Summary Accrual Reconciliation Report as part of your period end accrual reconciliation process. See: Overview of Receipt Accounting,

## Prerequisites

If you install Purchasing and Oracle Payables, you can run this report. If you accrue

expense purchases on receipt, you can reconcile your expense AP accrual account using this report. If you accrue expense purchases at period end and you do not perform inventory receipts, no information will be available to report.

**Important:** Most commercial installations accrue expense receipts at period end because this information is not required as the receipt occurs. If you accrue expense purchases on receipt, you have more entries to reconcile in the AP accrual accounts.

## Report Submission

In the Submit Requests window, select AP and PO Accrual Reconciliation Report in the Name field.

## Report Parameters

### Operating Unit

Select the operating unit for the report.

### Title

Enter your title for the report.

### Sort By

Parameter to specify how to sort the data at the distribution level (independent of summarization parameter)

**Valid Values:** Item, Age in Days, Total Balance, Vendor, PO Number (default).

### Aging Period Days

The number of days by which to group transactions sorted in descending order. (For example, if age group days is 60 which translates into 10 groupings for your transactions, then all distributions whose age in days is less than 60 days from the current date are in group 10. If the age in days is greater than 60 days, but less than 120, then they will be in group 9.).

### Item From

Lower limit of item range to consider for this report.

### Item To

Upper limit of item range to consider for this report.

**Vendor From**

Lower limit of vendor range to consider for this report.

**Vendor To**

Upper limit of vendor range to consider for this report.

**Min Outstanding Balance**

Lower limit of distribution balance to display.

**Max Outstanding Balance**

Upper limit of distribution balance to display.

**Balancing Segment From**

Lower limit of balancing segment range to consider for this report.

**Balancing Segment To**

Upper limit of balancing segment range to consider for this report.

**Related Topics**

Inventory Standard Cost Transactions, *Oracle Cost Management User's Guide*

Overview of Standard Costing, *Oracle Cost Management User's Guide*

Overview of Average Costing, *Oracle Cost Management User's Guide*

Overview of Work in Process Costing, *Oracle Work in Process User's Guide*

Overview of Receipt Accounting, page 9-86

Accrual Write-Off Report, page 11-1

Using the Account Generator in Oracle Purchasing, page E-6

Submitting a Request, *Oracle Applications User's Guide*

**Backordered Internal Requisitions Report**

The Backordered Internal Requisitions Report details information on your backordered *internally-sourced* requisition lines. You can run this report only if Order Management is installed.

**Submission**

In the Submit Requests window, select Backordered Internal Requisitions Report in the

Name field.

## Parameters

### Creation Dates From/To

Enter the beginning and ending creation dates.

### Requestor

Enter a requestor name.

### Subinventories From/To

Enter the beginning and ending subinventories.

### Dynamic Precision Option

Enter the decimal precision for quantities on the report.

## Related Topics

Submitting a Request, *Oracle Applications User's Guide*

## Blanket and Planned PO Status Report

The Blanket and Planned PO Status report can be used to review purchase order transactions for items you buy, using blanket purchase agreements and planned purchase orders. For each blanket purchase agreement and planned purchase order you create, Purchasing provides you with the detail of the releases you created against these orders. Purchasing prints the blanket agreement or planned purchase order header information, if no release exists.

## Submission

In the Submit Requests window, select Blanket and Planned PO Status Report in the Name field.

## Parameters

### PO Numbers From/To

Enter the beginning and ending purchase order numbers.

## Buyer

Enter a buyer name.

## Suppliers From/To

Enter the beginning and ending supplier numbers.

## Categories From/To

Enter the beginning and ending categories.

## Expired Date

Enter an expiration date to restrict the report to purchase orders with earlier expiration dates.

## Sort By

Use the Sort By feature to produce a report customized to your specific needs. Choose one of the following options:

**Purchase Order Number**            Sort the report by purchase order number.

**Supplier**                                Sort the report by supplier.

## Dynamic Precision Option

Enter the decimal precision for quantities on the report.

## Related Topics

Submitting a Request, *Oracle Applications User's Guide*

## Buyer Listing

The Buyer Listing shows the buyer name, default purchasing category, ship-to location, and effective dates of all buyers or a selected set of buyers. You can also use the report to isolate buyers who are assigned to a category of procurement items. See: Defining Buyers, page 1-20.

## Submission

In the Submit Requests window, select Buyer Listing in the Name field.



## Parameters

### Active/Inactive

Choose one of the following options:

- |                 |   |
|-----------------|---|
| <b>Active</b>   | List only active buyers on the report.              |
| <b>Both</b>     | List both active and inactive buyers on the report. |
| <b>Inactive</b> | List only inactive buyers on the report.            |

### Categories From/To

Enter the beginning and ending category names.

### Location

Enter a ship-to location.

### Sort By

Use the Sort By feature to produce a report customized to your specific needs. Choose one of the following options:

- |                   |   |
|-------------------|---|
| <b>Buyer Name</b> | Sort the report by buyer name. This is the default if you do not choose a sort by option. |
| <b>Category</b>   | Sort the report by purchasing category.   |
| <b>Location</b>   | Sort the report by location.  |

## Related Topics

Submitting a Request, *Oracle Applications User's Guide*

## Buyer's Requisition Action Required Report

The Buyer's Requisition Action Required Report identifies all or specific approved requisition lines that buyers have not placed on purchase orders. Later, you can use the AutoCreate Documents window to modify a requisition line, return a requisition, or place a requisition line onto a purchase order.

The report includes suggested document types *Blanket*, *Agreement*, *Catalog*, and *Quotation*.

## Report Submission

In the Submit Requests window, select Buyer's Requisition Action Required Report in the Name field.

## Report Parameters

### Suggested Suppliers From/To

Enter the beginning and ending suggested supplier names.

### Categories From/To

Enter the beginning and ending category from the purchasing category set. The report breaks and prints by categories.

### Need By Dates From/To

Enter the beginning and ending need-by dates.

### Location

Enter a location.

### Requestor

Enter a requestor name.

### Requisition Numbers From/To

Enter the beginning and ending requisition numbers.

### Print Price History

Enter Yes or No to indicate whether you want to print the price history on the report. If you leave this field blank, the default is Yes.

### Dynamic Precision Option

Enter the decimal precision for quantities on the report.

## Related Topics

Submitting a Request, *Oracle Applications User's Guide*

## Cancelled Purchase Orders Report

The Cancelled Purchase Orders Report can be used to review information on *cancelled* purchase orders.

### Report Submission

In the Submit Requests window, select Cancelled Purchase Orders Report in the Name field.

### Report Parameters

#### Suppliers From/To

Enter the beginning and ending supplier names.

#### Buyer

Enter the buyer name.

#### Cancelled Dates From/To

Enter the beginning and ending cancelled dates.

### Related Topics

Submitting a Request, *Oracle Applications User's Guide*

## Cancelled Requisitions Report

### Report Submission

In the Submit Requests window, select Cancelled Requisitions Report in the Name field.

### Report Parameters

#### Preparers From/To

Enter the beginning and ending preparer names.

#### Requisition Creation Dates From/To

Enter the beginning and ending creation dates to restrict the report to a range of dates.

## Requestors From/To

Enter the beginning and ending requestor names to restrict the report to a range of requestors.

## Sort By

Use the Sort By feature to produce a report customized to your specific needs. Choose one of the following options:

**Preparer** Sort the report by preparer. This is the default if you do not choose a sort by option.

**Requisition Number** Sort the report by requisition number.

## Dynamic Precision Option

Enter the decimal precision for quantities on the report.

## Related Topics

Submitting a Request, *Oracle Applications User's Guide*

## Contract Status Report

The Contract Status Report can be used to review the status of your contracts and list purchase order information for each contract. Purchasing prints the contract information *if* there are standard purchase order lines that reference that contract.

## Report Submission

In the Submit Requests window, select Contract Status Report in the Name field.

## Report Parameters

### PO Numbers From/To

Enter the beginning and ending purchase order numbers.

### Suppliers From/To

Enter the beginning and ending supplier names.

## Related Topics

Submitting a Request, *Oracle Applications User's Guide*

## Country of Origin Report (by Item)

This report lists, by item, all suppliers and their countries of origin as follows:

- Item
  - Supplier
    - Country of origin on the purchase order shipment
    - Country of origin on the receipt
    - Country of origin on the purchase order shipment
    - Country of origin on the receipt
  - Supplier
    - Country of origin on the purchase order shipment
    - Country of origin on the receipt
- Item
  - Supplier
    - Country of origin on the purchase order shipment
    - Country of origin on the receipt

The country of origin is the country in which an item is manufactured. This report displays the countries of origin specified on the purchase order shipment and the receipt. This report also displays the purchase order and receipt number for the item.

## Report Submission

In the Submit Requests window, select Country of Origin Report (by Item) in the Name field.

## Report Parameters

### Items From/To

Enter the beginning and ending system item numbers.

### Category From/To

Enter the beginning and ending purchasing categories.

## Ship To Organization

Select the ship-to organization for which to display the country of origin information. To see information from all ship-to organizations, leave this field blank.

## Date From/To

Enter the beginning and ending document creation dates. The report includes all purchase orders or receipts that fall between these dates.

## Country of Origin

If you want to see a list of all items belonging to just one country of origin, enter that country. To see all countries of origin, leave this field blank.

## Related Topics

Submitting a Request, *Oracle Applications User's Guide*

Entering Purchase Order Shipments, page 4-67

Entering Receipt Lines, page 9-30

## Country of Origin Report (by Supplier)

This report lists, by supplier, all countries of origin and their items as follows:

- Supplier
  - Country of origin
    - Item
    - Item
  - Country of origin
    - Item
- Supplier
  - Country of origin
    - Item
    - Item

The country of origin is the country in which an item is manufactured. This report displays the Country of Origin specified in the Approved Supplier List (ASL). It also includes the supplier item information, the ASL status, and unit of measure for each item. See: *Defining the Supplier/Item Attributes*, page 5-43.

## Report Submission

In the Submit Requests window, select Country of Origin Report (by Supplier) in the Name field.

## Report Parameters

### Ship To Organization

Enter a ship-to organization.

### Country of Origin Code

If you want to see a list of all suppliers and items belonging to just one country of origin, enter that country. To see all countries of origin, leave this field blank.

### Supplier From/To

Enter the beginning and ending supplier names.

### Supplier Site

To display countries of origin for just one site, enter the supplier site.

## Related Topics

Submitting a Request, *Oracle Applications User's Guide*

## Encumbrance Detail Report

The Encumbrance Detail Report can be used to review requisition and purchase order encumbrances for a range of accounts if you have enabled the encumbrance option for requisitions or purchase orders, and have entered and approved requisitions and purchases. You use this report to review the accounts encumbered.

The Encumbrance Detail Report reflects activity from General Ledger, not Purchasing or Oracle Payables. Therefore, use the Encumbrance Detail Report in a way that matches the accounting method:

- *Receipt accrual:* You can generate the Encumbrance Detail Report as needed when the Accrue at Receipt option is used for expense destinations. Upon entering receipt delivery information, an automated process transfers the receipt information to General Ledger using the Journal Import Process. For inventory destinations, you must first run the Oracle Inventory Transfer to General Ledger process before the encumbrance activity can be shown in this report.

- *Period-end accrual:* Encumbrance reversals created from the period-end accrual process are not reflected in the Encumbrance detail report. Only encumbrance reversals from invoices are reflected in the report, and the timing depends on encumbrance type setup in Oracle Purchasing and Oracle Accounts Payable:
  - If Accounts Payable and Purchasing use different encumbrance types, the report reflects the encumbrance reversals at the time of validation of a matched invoice.
  - If Accounts Payable and Purchasing use the same encumbrance type, the report reflects encumbrance reversals at the time of either invoice posting (for Accrual basis accounting) or payment posting (for Cash basis accounting). If posting is required, you must first run the Oracle Accounts Payable Transfer to General Ledger process (for invoices or payments, as needed).

Purchasing prints the purchase order and release number for purchase order encumbrances. The heading Requisition Number or PO#-Release prints if the charge account had distributions to requisitions and to purchase orders.

## Report Submission

In the Submit Requests window, select Encumbrance Detail Report in the Name field.

## Report Parameters

### Accounts From/To

Enter the beginning and ending accounts.

### Cost Centers From/To

Enter the beginning and ending cost centers.

### Encumbrance Dates From/To

Enter the beginning and ending encumbrance dates.

## Document Type

Enter a document type to restrict the report to a specific document type. Leave this field blank if you want the report to include both document types. Otherwise, choose one of the following options.

**Requisition** list only requisitions.

**Purchase order** list only purchase orders and blanket agreements.



## Suppliers From/To

Enter the beginning and ending supplier names.

## Dynamic Precision Option

Enter the decimal precision for quantities on the report.

## Related Topics

Submitting a Request, *Oracle Applications User's Guide*

## Expected Receipts Report

The Expected Receipts Report can be used to review all or specific supplier sourced expected receipts or expected customer returns that have not yet been received for a particular date or a range of dates. The report excludes purchase orders that are cancelled, closed, or closed for receiving at the header, release, line, or shipment level. You can specify the expected receipts you want to review.

For *Supplier* source type the Due Date is the promised date. If the promised date is not entered, this is the need by date. For internally sourced requisition lines, the Due Date is the need by date. For a *Customer* source, the Due Date is the request date on the return material authorization (RMA) document.

The Quantity/Amount Ordered and Quantity/Amount Due are not printed on the report if you are using blind receiving.

Use this report to improve or speed up your receiving operations. Your receivers may sometimes not have access to Oracle Applications when they need to enter receiving transactions. They can use the report of expected receipts to record receiving transactions and later enter them. There is space at the end of each shipment for you to record comments, the receipt date, and the quantity/amount you received.

## Report Submission

In the Transaction Reports (for Inventory) or Submit Requests window, select Expected Receipts Report in the Name field.

## Report Parameters

### Purchase Order Numbers From/To

Enter the beginning and ending purchase order numbers.

**Requisition Numbers From/To**

Enter the beginning and ending requisition numbers.

**Supplier**

Enter the supplier name.

**Items From/To**

Enter the beginning and ending item numbers.

**Categories From/To**

Enter the beginning and ending categories.

**Due Dates From/To**

Enter the beginning and ending promised dates.

**Ship-To Location**

Enter a location to restrict the report to that location.

**Note:** This parameter cannot be used to restrict the report for RMAs.

**Organization Name**

Enter an organization name to restrict the report to that organization.

**RMA Numbers From/To**

Enter the beginning and ending return material authorization (RMA) document numbers. An RMA is created in Order Management to authorize a customer return to your company.

**Customer From/To**

Enter a beginning and ending customer name if you want to review all expected returns from a specific customer or customers. These returns are authorized through an RMA document, which is created in Order Management.

**Dynamic Precision Option**

Enter the decimal precision for quantities on the report.

## Related Topics

Submitting a Request, *Oracle Applications User's Guide*

## Financials/Purchasing Options Listing

The Financials/Purchasing Options Listing can be used to review the *options* set for your system in the Financials Options and Purchasing Options windows. This report also displays your receipt numbering options in the Receiving Options window, for each organization.

## Report Submission

In the Submit Requests window, select Financials/Purchasing Options Listing in the Name field.

## Related Topics

Submitting a Request, *Oracle Applications User's Guide*

## Internal Requisition Status Report

Use the Internal Requisition Status Report to print status information for internal requisitions.

## Report Submission

In the Submit Requests window, select Internal Requisition Status Report in the Name field.

## Report Parameters

### Creation Dates From/To

Enter the beginning and ending creation dates.

### Items From/To

Enter the beginning and ending item numbers.

### Requestor

Enter a requestor name to restrict the report to a specific requestor.

**Subinventories From/To**

Enter the beginning and ending subinventories.

**Status**

Enter the status to restrict the report to a specific status.

**Requisition Numbers From/To**

Enter the beginning and ending requisition numbers.

**Sort By**

Use the Sort By feature to produce a report customized to your specific needs. Choose one of the following options:

<b>Creation Date</b>	Sort the report by creation date.
<b>Requestor</b>	Sort the report by requestor.
<b>Subinventory</b>	Sort the report by source subinventory.

**Dynamic Precision Option**

Enter the decimal precision for quantities on the report.

**Related Topics**

Submitting a Request, *Oracle Applications User's Guide*

**Internal Requisitions/Deliveries Discrepancy Report**

The Internal Requisitions/Deliveries Discrepancy Report lists requisition documents with items whose source type is inventory. Internal requisitions are typically for transfers of material from your inventories. Use this report to identify goods that have been shipped and have a delivery discrepancy. This report can be run only if Order Management is installed.

The Quantity Variance is the difference between the quantity shipped and the quantity delivered. If the quantity shipped is less than the quantity received, the result displays with a negative sign.

The Cost Variance is the variance in cost between the quantity shipped and the quantity delivered. The calculation for the cost variance is the quantity delivered times the requisition unit price, minus quantity shipped, times the sales order price.

## Report Submission

In the Submit Requests window, select Internal Requisitions/Deliveries Discrepancy Report in the Name field.

## Report Parameters

### Requisition Numbers From/To

Enter the beginning and ending requisition numbers.

### Requestor

Enter a requestor name to restrict the report to a specific requestor.

### Requisition Creation Dates From/To

Enter the beginning and ending creation dates.

### Sort By

Choose one of the following options:

<b>Creation Date</b>	Sort the report by creation date. This is the default if you leave this field blank.
<b>Requestor</b>	Sort the report by requestor.
<b>Subinventory</b>	Sort the report by item source organization subinventory.

### Dynamic Precision Option

Enter the decimal precision for quantities on the report.

## Related Topics

Submitting a Request, *Oracle Applications User's Guide*

## Invoice Price Variance Report

The Invoice Price Variance Report shows the variance between the invoice price and the purchase price for all inventory and work in process related invoice distributions. Payables records invoice price variances when the invoices are matched, approved, and posted.

The report includes invoice Entry Types *Adjustment*, *Entry*, and *Reversal*.

The invoice price variance is the quantity invoiced multiplied by the difference between the invoice unit price and the purchase order unit price.

If the invoice price and the purchase order unit price are in the same currency but the exchange rates differ, the exchange rate variance is also displayed in this report. For example, if the report displays an invoice price variance of -9.5 and an exchange rate variance of -6, the total invoice price variance of -9.5 includes the exchange rate variance of -6.

## Prerequisites

Payables records invoice price variance only when you have inventory or work in process related invoices. Use this report only if you use Inventory by itself or with Work in Process.

## Report Submission

In the Cost and Period Close Reports (for Inventory) or Submit Requests windows, select Invoice Price Variance Report in the Name field.

## Report Parameters

### Categories From/To

Enter the beginning and ending purchasing categories.

### Suppliers From/To

Enter the beginning and ending supplier numbers.

### Period Name

Enter an accounting period to restrict the report to a specific period.

### Dynamic Precision Option

Enter the decimal precision for quantities on the report.

## Related Topics

Submitting a Request, *Oracle Applications User's Guide*

## Invoice Price Variance by Supplier Report

The Invoice Price Variance Report shows the variance between the invoice price and the purchase price for all inventory and work in process related invoice distributions. Payables records invoice price variances when the invoices are matched, approved, and

posted.

The report includes invoice Entry Types *Adjustment*, *Entry*, and *Reversal*.

The invoice price variance is the quantity invoiced multiplied by the difference between the invoice unit price and the purchase order unit price.

If the invoice price and the purchase order unit price are in the same currency but the exchange rates differ, the exchange rate variance is also displayed in this report. For example, if the report displays an invoice price variance of -9.5 and an exchange rate variance of -6, the total invoice price variance of -9.5 includes the exchange rate variance of -6.

## Prerequisites

Payables records invoice price variance only when you have inventory or work in process related invoices. Use this report only if you use Inventory by itself or with Work in Process.

## Report Submission

In the Cost and Period Close Reports (for Inventory) or Submit Requests windows, select Invoice Price Variance by Supplier Report in the Name field.

## Report Parameters

### Categories From/To

Enter the beginning and ending purchasing categories.

### Suppliers From/To

Enter the beginning and ending supplier numbers.

### Period Name

Enter an accounting period to restrict the report to a specific period.

### Dynamic Precision Option

Enter the decimal precision for quantities on the report.

## Related Topics

Submitting a Request, *Oracle Applications User's Guide*

## Item Detail Listing

The Item Detail Listing shows detail information for items defined as Purchasing Items in the Item window as well as unit of measure conversion, notes, manufacturer part numbers, and dispositions assigned to the item. Purchasing lets you isolate items by limiting the items, categories, or buyer you want to review. For example, if your categories reflect purchased commodities, you can use the listing to review what manufactured items are for a commodity.

## Report Submission

In the Submit Requests window, select Item Detail Listing in the Name field.

## Report Parameters

### Active/Inactive

Choose one of the following options:

<b>Active</b>	List only active items on the report.
<b>Both</b>	List both active and inactive items on the report.
<b>Inactive</b>	List only inactive items on the report.

### Categories From/To

Enter the beginning and ending purchasing categories.

### Items From/To

Enter the beginning and ending item numbers.

### Buyer

Enter the buyer name to restrict the report to a specific buyer.

### Sort By

Use the Sort By feature to produce a report customized to your specific needs. Choose one of the following options:

<b>Category</b>	Sort the report by purchasing category.
<b>Item</b>	Sort the report by item number.



## Dynamic Precision Option

Enter the decimal precision for quantities on the report.

## Related Topics

Submitting a Request, *Oracle Applications User's Guide*

Defining Items, *Oracle Inventory User's Guide*

## Item Summary Listing

The Item Summary Listing shows the inactive or active status of items. You can also use the report to review the commodities of items that are inactive. And, finally, you can use the report as a listing of all items defined as Purchasing Items in the Items window.

## Report Submission

In the Submit Requests window, select Item Summary Listing in the Name field.

## Report Parameters

### Active/Inactive

Choose one of the following options:

**Active** List only active items on the report.

**Both** List both active and inactive items on the report.

**Inactive** List only inactive items on the report.

## Related Topics

Submitting a Request, *Oracle Applications User's Guide*

Defining Items, *Oracle Inventory User's Guide*

## Location Listing

The Location Listing shows internal organizations locations and addresses. Purchasing lets you specify which locations you want to review: Ship To, Bill To, Office, Internal, and Receiving. Use this report to isolate locations which are only for a specific function, such as locations where receiving is permitted. This document can be used as a resource when entering purchase order receiving locations.

## Report Submission

In the Submit Requests window, select Location Listing in the Name field.

## Report Parameters

### Site

Choose one of the following options:

<b>All</b>	List locations regardless of site criteria. This is the default if you do not choose a sort by option.
<b>Bill-To</b>	List only locations that are bill-to sites.
<b>External</b>	List only locations that are not internal sites.
<b>Office</b>	List only locations that are office sites.
<b>Receiving</b>	List only locations that are receiving sites.
<b>Ship-To</b>	List only locations that are ship-to sites.

### Active/Inactive

Choose one of the following options:

<b>Active</b>	List only active locations on the report.
<b>Both</b>	List both active and inactive locations on the report.
<b>Inactive</b>	List only inactive locations on the report.

### Sort By

Choose one of the following options:

<b>Country</b>	Sort the listing by country.
<b>Location</b>	Sort the listing by location. This is the default if you do not choose a sort by option.
<b>State</b>	Sort the listing by state.

## Related Topics

Submitting a Request, *Oracle Applications User's Guide*

## Matching Holds by Buyer Report

The Matching Holds by Buyer Report can be used to review all or selected invoices that Purchasing or your accounts payable system placed on matching hold. You can review price holds, quantity ordered holds, quantity received holds, and quality holds. You can review the matching holds for one or more buyers. After printing all of a particular buyer's matching holds, Purchasing prints summary matching hold information for this buyer. At the end of the report, Purchasing prints summary matching hold information for all of the buyers that you selected. This report helps you understand why an invoice is on hold and provides you with the information you need to solve the problem. You can also monitor the performance for suppliers or buyers using this report.

**Tip:** Use this report carefully when monitoring the performance of a supplier or buyer. This report summarizes the matching holds information and provides the reason why invoices are on hold. The buyer may have no control over some of the problems.

### Submission

In the Submit Requests window, select Matching Holds by Buyer Report in the Name field.

### Parameters

#### Buyer

Enter a buyer name to restrict the report to a specific buyer.

#### Suppliers From/To

Enter the beginning and ending supplier names.

#### Invoice Dates From/To

Enter the beginning and ending invoice dates.

#### Categories From/To

Enter the beginning and ending purchasing categories.

#### Items From/To

Enter the beginning and ending item numbers.

### **Price Hold**

Enter Yes or No to indicate whether the report includes purchase orders on price hold. If you leave this field blank, the default is Yes.

### **Quantity Ordered Hold**

Enter Yes or No to indicate whether the report includes purchase orders on quantity ordered hold. If you leave this field blank, the default is Yes.

### **Quantity Received Hold**

Enter Yes or No to indicate whether the report includes purchase orders on quantity received hold. If you leave this field blank, the default is Yes.

### **Quantity Accepted Hold**

Enter Yes or No to indicate whether the report includes purchase orders on quantity accepted hold. If you leave this field blank, the default is Yes.

### **Dynamic Precision Option**

Enter the decimal precision for quantities on the report.

### **Related Topics**

Submitting a Request, *Oracle Applications User's Guide*

## **Miscellaneous Accrual Reconciliation Report**

The purpose of this report is to show all inventory and AP (not matched to PO) transactions that have hit the accrual accounts. Transactions are grouped by accrual code. The report can be run either in summary where only the distribution information and balance is shown or in detail where all the transaction that make up a particular distribution are shown as well.

Usually this report is run in conjunction with the Summary Accrual Reconciliation Report as part of your period end accrual reconciliation process. See: Overview of Receipt Accounting,

### **Prerequisites**

If you install Oracle Purchasing and Oracle Payables, you can run this report. If you accrue expense purchases on receipt, you can reconcile your expense AP accrual account using this report. If you accrue expense purchases at period end and you do not perform inventory receipts, no information will be available to report.

**Important:** Most commercial installations accrue expense receipts at period end because this information is not required as the receipt occurs. If you accrue expense purchases on receipt, you have more entries to reconcile in the AP accrual accounts.

## Report Submission

In the Submit Requests window, select Miscellaneous Accrual Reconciliation Report in the Name field.

## Report Parameters

### Operating Unit

Select the operating unit for the report.

### Title

Enter your title for the report.

### Sort By

Parameter to specify how to sort the data at the distribution level (independent of summarization parameter)

**Valid Values:** Item, Transaction Date (default), Amount.

### Date From

Starting date of time period to display for this report.

### Date To

Ending date of time period to display for this report.

### Item From

Lower limit of item range to consider for this report.

### Item To

Upper limit of item range to consider for this report.

### Min Amount

Lower limit of transaction amount to display.

**Max Amount**

Upper limit of transaction amount to display.

**Balancing Segment From**

Lower limit of balancing segment range to consider for this report.

**Balancing Segment To**

Upper limit of balancing segment range to consider for this report.

**Related Topics**

Inventory Standard Cost Transactions, *Oracle Cost Management User's Guide*

Overview of Standard Costing, *Oracle Cost Management User's Guide*

Overview of Average Costing, *Oracle Cost Management User's Guide*

Overview of Work in Process Costing, *Oracle Work in Process User's Guide*

Overview of Receipt Accounting, page 9-86

Accrual Write-Off Report, page 11-1

Using the Account Generator in Oracle Purchasing, page E-6

Submitting a Request, *Oracle Applications User's Guide*

**New Supplier Letter Report**

The New Supplier Letter Report prints letters you send to your suppliers to ask for information about the nature of their businesses. Purchasing prints the New Supplier Letter Report together with the corresponding supplier letters. The report gives you a listing of the supplier names, sites, and addresses to which you can send your letters, and prints the letters for each supplier on the listing.

**Submission**

In the Submit Requests window, select New Supplier Letter Report in the Name field.

**Parameters****Supplier Type**

Enter the supplier type from the Enter Lookup Codes window to restrict the report to a specific supplier type.

### Suppliers From/To

Enter the beginning and ending supplier names.

### Supplier Site

Enter the supplier site to restrict the report to a specific supplier site.

### Creation Dates From/To

Enter the beginning and ending creation dates.

### Active/Inactive

Choose one of the following options:

- |                 |  |
|-----------------|--|
| <b>Active</b>   | List only active suppliers on the report.              |
| <b>Both</b>     | List both active and inactive suppliers on the report. |
| <b>Inactive</b> | List only inactive suppliers on the report.            |

### Sort By

Use the Sort By feature to produce a report customized to your specific needs. Choose one of the following options:

- |                      |  |
|----------------------|--|
| <b>Supplier</b>      | Sort the report by supplier name and supplier site. This is the default if you do not enter an option. |
| <b>Supplier Site</b> | Sort the report by supplier site and supplier name.  |
| <b>ZIP Code</b>      | Sort the report by postal code, supplier name, and supplier site.                                      |

### Related Topics

Submitting a Request, *Oracle Applications User's Guide*

## Open Purchase Orders Report (by Buyer)

The Open Purchase Orders Report (by Buyer) lists all or specific open purchase orders that relate to *buyers*. Purchasing lets you specify the open purchase orders you want to review. An open purchase order is one that references an item that your supplier has not yet fully billed or received. The report excludes closed, final closed, and cancelled orders.

## Submission

In the Submit Requests window, select Open Purchase Orders Report (by Buyer) in the Name field.

## Parameters

### Buyer

Enter a buyer name to restrict the report to a specific buyer.

### Suppliers From/To

Enter the beginning and ending supplier names.

### Dynamic Precision Option

Enter the decimal precision for quantities on the report.

## Related Topics

Submitting a Request, *Oracle Applications User's Guide*

## Open Purchase Orders Report (by Cost Center)

The Open Purchase Orders Report (by Cost Center) can be used to review all or specific open purchase orders relating to one or more cost centers. An open purchase order is one that references an item that your supplier has not yet *fully* billed or received. The report excludes closed, final closed, and cancelled orders.

## Submission

In the Submit Requests window, select Open Purchase Orders Report (by Cost Center) in the Name field.

## Parameters

### Companies From/To

Enter the beginning and ending company names.

### Cost Centers From/To

Enter the beginning and ending cost centers.



### **Dynamic Precision Option**

Enter the decimal precision for quantities on the report.

### **Sort By**

This parameter indicates the sequence of the information on the report. Select COMPANY to sort by company or COST CENTER to sort by cost center.

### **Related Topics**

Submitting a Request, *Oracle Applications User's Guide*

## **Overdue Supplier Shipments Report**

This report can be used to follow-up with suppliers. The report includes the supplier contact and the phone number along with percentage delivery and the due date. The report also includes purchase orders that do not have a supplier contact assigned. By limiting the report to only one buyer, you can do follow-up by buyer. And, finally, by limiting the report by categories, you can do purchasing follow-up for a range of commodities.

The Due Date is the date the supplier promised delivery for the items you ordered on the shipment, or the date you indicated that you needed the goods by.

### **Submission**

In the Transaction Reports (for Inventory) or Submit Requests windows, select Overdue Supplier Shipments Report in the Name field.

### **Report Parameters**

#### **Overdue as of**

Enter a date to restrict the report to purchase orders not fully received where the promised date is less than or equal to this date. If you do not enter a date, the report prints all purchase orders that you have not yet fully received where the promised date is less than or equal to the current date. If the promised date is not provided, the need by date is used.

#### **Buyer**

Enter a buyer to restrict the report to a specific buyer.

**Suppliers From/To**

Enter a beginning and ending supplier.

**Ship-to Location**

Enter a ship-to location to restrict the report to overdue shipments for a specific location.

**Categories From/To**

Enter a beginning and an ending category from the purchasing category set.

**Organization Name**

Enter the organization name to restrict the report to a specific organization.

**Dynamic Precision Option**

Enter the decimal precision for quantities on the report.

**Related Topics**

Submitting a Request, *Oracle Applications User's Guide*

**Overshipments Report**

The Overshipments Report lists purchase order receipts with a quantity received greater than the quantity ordered. You can also use the Overshipments Report to identify service overcharges or suppliers who deliver more than the requested quantity.

**Submission**

In the Submit Requests window, select Overshipments Report in the Name field.

**Parameters****Receipt Location**

Enter the receipt location to restrict the report to overshipments to a specific internal location.

**Receiver**

Enter the name of the employee to restrict the report to overshipments to a specific receiver.

**Receipt Date From/To**

Enter the beginning and ending receipt dates to restrict the report to a range of receipt dates.

**Supplier From/To**

Enter the beginning and ending supplier names to restrict the report to a range of suppliers.

**Supplier Site**

Enter the supplier site to restrict the report to overshipments to a specific supplier site.

**Organization Name**

Enter the organization name to restrict the report to a specific organization.

**Sort By**

Use the Sort By feature to produce a report customized to your specific needs. Choose one of the following options:

**Purchase Order Number**

Sort the report by document number. This is the default if you do not choose an option.

**Supplier**

Sort the report by supplier.

**Quantity Precision Option**

Enter the decimal precision for quantities on the report.

**Related Topics**

Submitting a Request, *Oracle Applications User's Guide*

**Printed Change Orders Report (Landscape)**

The Printed Change Orders Report (Landscape) prints changed purchase orders. The change purchase orders are the hard copy document you print on a preprinted form and distribute through the mail or fax to confirm changed orders you have requested or confirmed with your suppliers. Purchasing provides a default format for the preprinted form. Contact your Oracle Consultant for information regarding the forms. See: Printed Purchase Order Overview, page 8-3.

A purchase order will not print or fax if the supplier site on the purchase order is already set up to receive purchase orders through Electronic Data Interchange (EDI).

The Printed Change Orders Report (Landscape) prints changed purchase orders. The change purchase orders are the hard copy document you print on a preprinted form and distribute through the mail or fax to confirm changed orders you have requested or confirmed with your suppliers. Purchasing provides a default format for the preprinted form. Contact your Oracle Consultant for information regarding the forms. See: . Printed Purchase Order Overview.,

You can print most fields on this report in another language, if you use Multilingual Support (MLS). See: Submitting a Request, *Oracle Applications User's Guide*.

**Note:** You can print item descriptions in other languages only for inventory items for which translations have been entered. If you change the item description on the document, it does not print in the translated language.

## Submission

In the Submit Requests window, select Printed Change Orders Report (Landscape) in the Name field.

## Parameters

### Buyer

Select a buyer name to restrict the report to a specific buyer.

### Purchase Order Numbers From/To

To restrict the report to a range of purchase orders, select the beginning and ending numbers.

### Release Numbers From/To

To restrict the report to a range of releases, select the beginning and ending numbers.

### Release Dates From/To

To restrict the report to a release date range, enter the beginning and ending dates.

### Print Releases Option

Enter Y or N to indicate whether you want Blanket and Planned Purchase Order releases to be automatically printed with the Blanket and Purchase Order Agreements.

### Sort By

Select one of the following options:

<b>Buyer Name</b>	Sort the report by buyer name. This is the default if you leave the field blank.
<b>Purchase Order Number</b>	Sort the report by purchase order number.

### Dynamic Precision Option

Enter the decimal precision for quantities on the report.

### Fax Enabled / Fax Number

Select Fax Enabled and enter a Fax Number to automatically send a facsimile of the document. CommercePath, or any facsimile software that is compatible with the CommercePath Fax Command Language (FCL), must be installed to use this functionality.

**Important:** If you entered a Purchase Order Numbers From/To range, all of the purchase orders in that range must use the same supplier site. Otherwise, the purchase orders will be sent to the same facsimile number you enter here. (The Fax fields will be disabled if the purchase orders aren't from the same supplier site.)

Selecting Fax Enabled without entering a Fax Number sends the document to your facsimile server once it is approved. Depending on your CommercePath setup, you can choose where or when to send the documents that are stored on your facsimile server.

### Related Topics

Submitting a Request, *Oracle Applications User's Guide*

Viewing Requests, *Oracle Applications User's Guide*

## Printed Change Orders Report (Portrait)

The Printed Change Orders Report (Portrait) prints changed purchase orders to send to your suppliers. The change purchase orders are the hard copy document you print on a preprinted form and distribute through the mail or fax to confirm changed orders you have requested or confirmed with your suppliers. Purchasing provides a default format for the preprinted form. Contact your Oracle Consultant for information regarding the forms. See: Printed Purchase Order Overview, page 8-3.

A purchase order will not print or fax if the supplier site on the purchase order is already set up to receive purchase orders through Electronic Data Interchange (EDI).

The Printed Change Orders Report (Portrait) prints changed purchase orders to send to your suppliers. The change purchase orders are the hard copy document you print on a preprinted form and distribute through the mail or fax to confirm changed orders you

have requested or confirmed with your suppliers. Purchasing provides a default format for the preprinted form. Contact your Oracle Consultant for information regarding the forms. See: Printed Purchase Order Overview.,

You can print most fields on this report in another language, if you use Multilingual Support (MLS). See: Submitting a Request, *Oracle Applications User's Guide*.

**Note:** You can print item descriptions in other languages only for inventory items for which translations have been entered. If you change the item description on the document, it does not print in the translated language.

## Submission

In the Submit Requests window, select Printed Change Orders Report (Portrait) in the Name field.

## Report Parameters

### Buyer

Select a buyer name to restrict the report to a specific buyer.

### Purchase Order Numbers From/To

To restrict the report to a range of purchase orders, select the beginning and ending numbers.

### Release Numbers From/To

To restrict the report to a range of releases, select the beginning and ending numbers.

### Release Dates From/To

To restrict the report to a release date range, enter the beginning and ending dates.

### Print Releases Option

Enter Y or N to indicate whether you want Blanket and Planned Purchase Order releases to be automatically printed with the Blanket and Purchase Order Agreements.

### Sort By

Select one of the following options:

**Buyer Name** Sort the report by buyer name. This is the default if you leave the field blank.

**Purchase Order Number**

Sort the report by purchase order number.

### **Dynamic Precision Option**

Enter the decimal precision for quantities on the report.

### **Fax Enabled / Fax Number**

Select Fax Enabled and enter a Fax Number to automatically send a facsimile of the document. Facsimile software that is compatible with the CommercePath Fax Command Language (FCL), must be installed to use this functionality.

**Important:** If you entered a Purchase Order Numbers From/To range, all of the purchase orders in that range must use the same supplier site. Otherwise, the purchase orders will be sent to the same facsimile number you enter here. (The Fax fields will be disabled if the purchase orders aren't from the same supplier site.)

Selecting Fax Enabled without entering a Fax Number sends the document to your facsimile server once it is approved. Depending on your facsimile system, you can choose where or when to send the documents that are stored on your facsimile server.

### **Related Topics**

Submitting a Request, *Oracle Applications User's Guide*

Viewing Requests, *Oracle Applications User's Guide*

## **Printed Purchase Order Report (Landscape)**

The Printed Purchase Order Report (Landscape) prints your purchase orders. Purchasing lets you specify the purchase orders you want to review or print on your preprinted form. The printed purchase orders are the hard copy document you print on a preprinted form and distribute through the mail or fax to confirm orders you have requested or confirmed with your suppliers. Purchasing provides a default landscape format for the preprinted form. Contact your Oracle Consultant for information regarding the forms. See: Printed Purchase Order Overview, page 8-3.

A purchase order will not print or fax if the supplier site on the purchase order is already set up to receive purchase orders through Electronic Data Interchange (EDI).

The Printed Purchase Order Report (Landscape) prints your purchase orders. Purchasing lets you specify the purchase orders you want to review or print on your preprinted form. The printed purchase orders are the hard copy document you print on a preprinted form and distribute through the mail or fax to confirm orders you have requested or confirmed with your suppliers. Purchasing provides a default landscape format for the preprinted form. Contact your Oracle Consultant for information

regarding the forms. See: Printed Purchase Order Overview,

You can print most fields on this report in another language, if you use Multilingual Support (MLS). See: Submitting a Request, *Oracle Applications User's Guide*.

**Note:** You can print item descriptions in other languages only for inventory items for which translations have been entered. If you change the item description on the document, it does not print in the translated language.

## Submission

In the Submit Requests window, select Printed Purchase Order Report (Landscape) in the Name field.

## Parameters

### Print Selection

Select one of the following options:

<b>All</b>	Print the report for all purchase orders. This is the default for no entry.
<b>Changed</b>	Print the report only for changed purchase orders.
<b>New</b>	Print the report only for new purchase orders.

### Buyer

Select a buyer name to restrict the report to a specific buyer.

### Purchase Order Numbers From/To

To restrict the report to a range of purchase orders, select the beginning and ending numbers.

### Release Numbers From/To

To restrict the report to a range of releases, select the beginning and ending numbers.

### Release Dates From/To

To restrict the report to a release date range, enter the beginning and ending dates.



## Approved

Select Yes or No to indicate whether the report is restricted to approved purchase orders.

## Test

Select Yes or No to indicate whether the report is a test.

## Print Releases Option

Enter Y or N to indicate whether you want Blanket and Planned Purchase Order releases to be automatically printed with the Blanket and Purchase Order Agreements.

## Sort By

Select one of the following options:

- |                              |  |
|------------------------------|--|
| <b>Buyer Name</b>            | Sort the report by buyer name and purchase order number. |
| <b>Purchase Order Number</b> | Sort the report by purchase order number.                |

## Dynamic Precision Option

Enter the decimal precision for quantities on the report.

## Fax Enabled / Fax Number

Select Fax Enabled and enter a Fax Number to automatically send a facsimile of the document. CommercePath, or any facsimile software that is compatible with the CommercePath Fax Command Language (FCL), must be installed to use this functionality.

**Important:** If you entered a Purchase Order Numbers From/To range, all of the purchase orders in that range must use the same supplier site. Otherwise, the purchase orders will be sent to the same facsimile number you enter here. (The Fax fields will be disabled if the purchase orders aren't from the same supplier site.)

Selecting Fax Enabled without entering a Fax Number sends the document to your facsimile server once it is approved. Depending on your CommercePath setup, you can choose where or when to send the documents that are stored on your facsimile server.

## Related Topics

Submitting a Request, *Oracle Applications User's Guide*

Viewing Requests, *Oracle Applications User's Guide*

## Printed Purchase Order Report (Portrait)

The Printed Purchase Orders Report (Portrait) prints the purchase orders you specify. The printed purchase orders are the hard copy document you print on a preprinted form and distribute through the mail or fax to confirm orders you have requested or confirmed with your suppliers. Purchasing provides a default portrait format for the preprinted form. Contact your Oracle Consultant for information regarding the forms. See: Printed Purchase Order Overview, page 8-3.

A purchase order will not print or fax if the supplier site on the purchase order is already set up to receive purchase orders through Electronic Data Interchange (EDI) or Extensible Markup Language (XML).

The Printed Purchase Orders Report (Portrait) prints the purchase orders you specify. The printed purchase orders are the hard copy document you print on a preprinted form and distribute through the mail or fax to confirm orders you have requested or confirmed with your suppliers. Purchasing provides a default portrait format for the preprinted form. Contact your Oracle Consultant for information regarding the forms. See: Printed Purchase Order Overview.,

You can print most fields on this report in another language, if you use Multilingual Support (MLS). See: Submitting a Request, *Oracle Applications User's Guide*.

**Note:** You can print item descriptions in other languages only for inventory items for which translations have been entered. If you change the item description on the document, it does not print in the translated language.

### Submission

In the Submit Requests window, select Printed Purchase Order Report (Portrait) in the Name field.

### Parameters

#### Print Selection

Select one of the following options:

- |                |   |
|----------------|---|
| <b>All</b>     | Print the report for all purchase orders. This is the default for no entry. |
| <b>Changed</b> | Print the report only for changed purchase orders.                          |
| <b>New</b>     | Print the report only for new purchase orders.                              |

**Buyer**

Select a buyer name to restrict the report to a specific buyer.

**Purchase Order Numbers From/To**

To restrict the report to a range of purchase orders, select the beginning and ending numbers.

**Release Numbers From/To**

To restrict the report to a range of releases, select the beginning and ending numbers.

**Release Dates From/To**

To restrict the report to a release date range, enter the beginning and ending dates.

**Approved**

Select Yes or No to indicate whether the report is restricted to approved purchase orders.

**Test**

Select Yes or No to indicate whether the report is a test.

**Print Releases Option**

Enter Y or N to indicate whether you want Blanket and Planned Purchase Order releases to be automatically printed with the Blanket and Purchase Order Agreements.

**Sort By**

Select one of the following options:

**Buyer Name** Sort the report by buyer name and purchase order number.

**Purchase Order Number** Sort the report by purchase order number.

**Dynamic Precision Option**

Enter the decimal precision for quantities on the report.

**Fax Enabled / Fax Number**

Select Fax Enabled and enter a Fax Number to automatically send a facsimile of the document. CommercePath, or any facsimile software that is compatible with the CommercePath Fax Command Language (FCL), must be installed to use this functionality.

**Important:** If you entered a Purchase Order Numbers From/To range, all of the purchase orders in that range must use the same supplier site. Otherwise, the purchase orders will be sent to the same facsimile number you enter here. (The Fax fields will be disabled if the purchase orders aren't from the same supplier site.)

Selecting Fax Enabled without entering a Fax Number sends the document to your facsimile server once it is approved. Depending on your CommercePath setup, you can choose where or when to send the documents that are stored on your facsimile server.

## Related Topics

Submitting a Request, *Oracle Applications User's Guide*

Viewing Requests, *Oracle Applications User's Guide*

## Printed RFQ Report (Landscape)

The Printed RFQ Report (Landscape) prints in landscape format RFQs with a Status of Active. Purchasing lets you specify the RFQs you want to review or print. Purchasing provides a default landscape format for preprinted landscape forms. Contact your Oracle Consultant for information regarding the forms.

You can print most fields on this report in another language, if you use Multilingual Support (MLS). See: Submitting a Request, *Oracle Applications User's Guide*.

**Note:** You can print item descriptions in other languages only for inventory items for which translations have been entered. If you change the item description on the document, it does not print in the translated language.

## Submission

In the Submit Requests window, select Printed RFQ Report (Landscape) in the Name field.

## Parameters

### Report Type

Choose one of the following options:

**All** Print the report for all RFQs.

**Changed** Print the report only for changed RFQs.

**New** Print the report only for new RFQs.

### **Buyer**

Enter a buyer name to restrict the report to a specific buyer.

### **RFQ Numbers From/To**

Enter the beginning and ending RFQ numbers.

### **Test**

Enter Yes or No to indicate whether the report is a test.

### **Sort By**

Choose one of the following options:

**Buyer Name** Sort the report by buyer name.

**RFQ Number** Sort the report by RFQ number.

### **Dynamic Precision Option**

Enter the decimal precision for quantities on the report.

### **Related Topics**

Submitting a Request, *Oracle Applications User's Guide*

## **Printed RFQ Report (Portrait)**

The Printed RFQ Report (Portrait) prints in portrait format RFQs with a Status of Active. Purchasing lets you specify the RFQs you want to review or print. Purchasing provides a default portrait format for preprinted portrait forms. Contact your Oracle Consultant for information regarding these forms.

You can print most fields on this report in another language, if you use Multilingual Support (MLS). See: Submitting a Request, *Oracle Applications User's Guide*.

**Note:** You can print item descriptions in other languages only for inventory items for which translations have been entered. If you change the item description on the document, it does not print in the translated language.

## Submission

In the Submit Requests window, select Printed RFQ Report (Portrait) in the Name field.

## Parameters

### Report Type

Choose one of the following options:

- |                |   |
|----------------|---|
| <b>All</b>     | Print the report for all RFQs.          |
| <b>Changed</b> | Print the report only for changed RFQs. |
| <b>New</b>     | Print the report only for new RFQs.     |

### Buyer

Enter a buyer name to restrict the report to a specific buyer.

### RFQ Numbers From/To

Enter the beginning and ending RFQ numbers.

### Test

Enter Yes or No to indicate whether the report is a test.

### Sort By

Choose one of the following options:

- |                   |                                |
|-------------------|--------------------------------|
| <b>Buyer Name</b> | Sort the report by buyer name. |
| <b>RFQ Number</b> | Sort the report by RFQ number. |

### Dynamic Precision Option

Enter the decimal precision for quantities on the report.

## Related Topics

Submitting a Request, *Oracle Applications User's Guide*

## Printed Requisitions Report

The Printed Requisitions Report prints the requisitions which have the following status:

Approved, Rejected, In Process, Pre-Approved, and Returned. The report does not include requisitions with status Incomplete or cancelled. You can circulate the printed requisitions for signature approvals and notes.

**Note:** In the Approver field the report prints the name of the last person who performed an action on the requisition. This is not necessarily the approver.

## Submission

In the Submit Requests window, select Printed Requisitions Report in the Name field.

## Parameters

### Requisition Numbers From/To

Enter the beginning and ending requisition numbers.

### Dynamic Precision Option

Enter the decimal precision for quantities on the report.

## Related Topics

Submitting a Request, *Oracle Applications User's Guide*

## Purchase Agreement Audit Report

You can use this report to review purchase order transactions for items you normally buy using blanket purchase agreements. Purchasing lets you determine if you are efficiently using the blanket purchase agreements you negotiate with your suppliers. For each item you buy using blanket purchase agreements, Purchasing provides you with the detail of the existing purchase orders for this item and the detail of the agreement lines- blanket or standard- you created for this item. Purchasing shows you when you purchased items using a standard purchase order where you could have used a blanket purchase agreement.

The Opportunity Cost is calculated as the sum of the amount of the purchase order subtracted from the sum of the amount of the blankets.

## Submission

In the Submit Requests window, select Purchase Agreement Audit Report in the Name field.

## Parameters

### Buyer

Enter a buyer name to restrict the report to a specific buyer.

### Blanket PO Numbers From/To

Enter the beginning and ending blanket purchase agreement numbers.

### Creation Dates From/To

Enter the beginning and ending creation dates.

### Categories From/To

Enter the beginning and ending purchasing categories.

### Items From/To

Enter the beginning and ending item numbers.

### Sort By

Use the Sort By feature to produce a report customized to your specific needs. Choose one of the following options:

**Category** Sort the report by purchasing category.

**Item** Sort the report by item number.

### Dynamic Precision Option

Enter the decimal precision for quantities on the report.

## Related Topics

Submitting a Request, *Oracle Applications User's Guide*

## Purchase Order Commitment by Period Report

The Purchase Order Commitment By Period Report shows the monetary value of your purchased commitments for a specified period and the next five periods. You can use the report sorted by buyer to monitor buyer performance. You can also use the report when negotiating with a supplier by limiting the commitments to a specific supplier.



## Submission

In the Submit Requests window, select Purchase Order Commitment by Period Report in the Name field.

## Parameters

### Period

Enter the beginning period to be covered by the report. If the purchase order number shipment promise date falls within the period start and end date, the monetary value is included in the report. For orders which do not include a promise date, the need-by date is considered.

### PO Numbers From/To

Enter the beginning and ending purchase order numbers.

### Suppliers From/To

Enter the beginning and ending supplier names.

### Buyer

Enter the buyer name to restrict the report to a specific buyer.

### Categories From/To

Enter the beginning and ending purchasing categories.

### Sort By

Use the Sort By feature to produce a report customized to your specific needs. Choose one of the following options:

**Supplier** Sort the report by supplier.

**Buyer Name** Sort the report by buyer.

## Related Topics

Submitting a Request, *Oracle Applications User's Guide*

## Purchase Order Detail Report

The Purchase Order Detail Report lists all, specific standard, or planned purchase

orders. Purchasing displays the quantity you ordered and received so you can monitor the status of your purchase orders. You can also review the open purchase orders to determine how much you still have to receive and how much your supplier has *already* billed you.

## Submission

In the Submit Requests window, select Purchase Order Detail Report in the Name field.

## Report Parameters

### Buyer

Enter the buyer name to restrict the report to a specific buyer.

### Items From/To

Enter the beginning and ending item numbers.

### Categories From/To

Enter the beginning and ending purchasing categories.

### Suppliers From/To

Enter the beginning and ending supplier names.

### PO Numbers From/To

Enter the beginning and ending purchase order numbers.

### Status

Enter the purchase order status to restrict the report to a specific status. Choose one of the following options: Approved, In Process, Incomplete, Pre-Approved, Rejected, Requires Reapproval, Reserved, or Returned.

### Dynamic Precision Option

Enter the decimal precision for quantities on the report.

## Related Topics

Submitting a Request, *Oracle Applications User's Guide*

## Purchase Order Distribution Detail Report

The Purchase Order Distribution Detail Report shows account distributions for a range of purchase orders. If you use Purchase Order Encumbrance Control and you set the failure funds only report option to Yes, Purchasing prints only those accounts that fail funds reservation.

The Quantity Ordered is the uncanceled shipment quantity. For planned purchase order shipments, this quantity excludes cancelled quantities and any scheduled release quantities associated with the shipment.

### Submission

In the Submit Requests window, select Purchase Order Distribution Detail Report in the Name field.

### Parameters

#### Ledger Currency

Select the reporting currency for the report.

#### PO Numbers From/To

Enter the beginning and ending purchase order numbers.

#### Creation Dates From/To

Enter the beginning and ending creation dates.

#### Suppliers From/To

Enter the beginning and ending supplier numbers.

#### Buyer

Enter a buyer name to restrict the report to a specific buyer.

#### Failed Funds Only

Enter Yes or No to indicate whether you want to restrict the report to purchase orders that failed funds checking.

#### Sort By

Use the Sort By feature to produce a report customized to your specific needs. Choose one of the following options:

<b>Purchase Order Number</b>	Sort the report by purchase order number.
<b>Supplier</b>	Sort the report by supplier.

## Related Topics

Submitting a Request, *Oracle Applications User's Guide*

## Purchase Order and Releases Detail Report

The Purchase Order and Releases Detail Reports show detail information for your blanket purchase agreements and planned purchase orders. Purchasing displays the quantity that you ordered, received, billed, and that is due to be received so you can *monitor* the status of your purchase orders. You can review releases to determine how much is remaining to be received and invoiced.

## Submission

In the Submit Requests window, select Purchase Order and Releases Detail Report in the Name field.

## Parameters

### Buyer

Enter the buyer name to restrict the report to a specific buyer.

### Categories From/To

Enter a beginning and an ending value.

### Items From/To

Enter the beginning and ending item numbers.

### Suppliers From/To

Enter the beginning and ending supplier names.

### PO Numbers From/To

Enter the beginning and ending purchase order numbers.

## Related Topics

Submitting a Request, *Oracle Applications User's Guide*

## Purchase Price Variance Report

The Purchase Price Variance Report shows the variance between the purchase price on the purchase order and standard cost for all items you receive and deliver into inventory and work in process. Inventory records purchase price variance on delivery into a subinventory. Work in Process records purchase price variance on delivery into a job or repetitive schedule. For internal requisitions, the purchase order ship to location is associated with the organization in the Customers window. See: *Creating and Updating Customers, Oracle Receivables User's Guide*.

The purchase price variance is calculated as the quantity received multiplied by the difference between the purchase order price and the standard cost.

### Prerequisites

Since this report displays purchase price variances for standard costing, this report is appropriate only for organizations using Inventory and standard costing. If you use Work in Process, this report also displays the outside processing purchase price variance.

### Submission

In the Cost and Period Close Reports (for Inventory) or Submit Requests windows, select Purchase Price Variance Report in the Name field.

### Parameters

#### Categories From/To

Enter the beginning and ending purchasing categories.

#### Transaction Dates From/To

Enter the beginning and ending transaction dates.

#### Suppliers From/To

Enter the beginning and ending suppliers.

#### Organization Name

Enter the organization name. The ship to location is associated with the organization in the Location Association window.

## Sort By

Choose one of the following options:

<b>Buyer Name</b>	Sort the report by buyer name.
<b>Category</b>	Sort the report by item category.
<b>Item</b>	Sort the report by item number.
<b>Supplier</b>	Sort the report by supplier.

## Dynamic Precision Option

Enter the decimal precision for quantities on the report.

## Related Topics

Submitting a Request, *Oracle Applications User's Guide*

## Purchase Requisition Status Report

The Purchase Requisition Status Report can be used to review the approval status of the requisitions you create. You can use the report as a tool to plan and monitor the buyer workload. You can also use the report to monitor requisitions in the approval process or returned and requiring further attention.

The report can include requisitions with the following statuses:

<b>Approved</b>	An approver with sufficient authority approved the requisition. A buyer can now place the corresponding requisition lines onto purchase orders.
<b>Cancelled</b>	A requisition preparer cancelled the requisition.
<b>In Process</b>	The preparer completed the requisition and submitted to the approval process. However, no one with sufficient authority has approved the requisition.
<b>Incomplete</b>	The requisition is incomplete and the preparer has not yet submitted the requisition to an approver.
<b>Pre-Approved</b>	At least one person with sufficient authority approved the requisition. The status is not Approved either because the approver forwarded the requisition to someone else, or the approver has not yet reserved the funds.

<b>Rejected</b>	The approver rejected the requisition. Purchasing returns the entire requisition to the preparer.
<b>Returned</b>	A buyer returned the requisition. Purchasing returns to the preparer all requisition lines within the same requisition that are not on a purchase order.

## Submission

In the Submit Requests window, select Purchase Requisition Status Report in the Name field.

## Parameters

### Requisition Numbers From/To

Enter the beginning and ending requisition numbers.

### Creation Dates From/To

Enter the beginning and ending creation dates.

### Requestor

Enter a requestor name to restrict the report to a specific requestor.

### Location

Enter a deliver to location to restrict the report to a specific location.

### Dynamic Precision Option

Enter the decimal precision for quantities on the report.

## Related Topics

Submitting a Request, *Oracle Applications User's Guide*

## Purchase Summary Report by Category

The Purchase Summary Report by Category shows the amount of orders you place with suppliers for a *given* category of item. Use the report to monitor the purchase documents included in a range of categories.

## Submission

In the Submit Requests window, select Purchase Summary Report by Category in the Name field.

## Parameters

### Categories From/To

Enter the beginning and ending categories assigned to the item from the purchasing category set.

### Buyers From/To

Enter the beginning and ending buyer names.

### Suppliers From/To

Enter the beginning and ending supplier names.

### Creation Dates From/To

Enter the beginning and ending creation dates.

## Related Topics

Submitting a Request, *Oracle Applications User's Guide*

## Purchasing Activity Register

The Purchasing Activity Register shows purchase order monetary activity carried out for a time interval, such as a day or month. The report excludes all fully cancelled purchasing documents. The report includes blanket and contract purchase agreements and planned purchase orders for reference. However, since these documents do not represent actual purchase activity, their amounts are not shown in the PO Amount and Functional Amount columns and are not included in the Total amount.

## Submission

In the Submit Requests window, select Purchasing Activity Register in the Name field.



## Parameters

### Ledger Currency

Select the reporting currency for the report.

### Creation Dates From/To

Enter the beginning and ending document creation dates.

### PO Type

Enter the purchase order type to restrict the report to a specific type.

### Supplier

Enter the supplier name to restrict the report to a specific supplier.

### Buyer

Enter the buyer name to restrict the report to a specific buyer.

### Sort By

Use the Sort By feature to produce a report customized to your specific needs. Choose *Buyer Name* or *Creation Date*.

### Dynamic Precision Option

Enter the decimal precision for quantities on the report.

## Related Topics

Submitting a Request, *Oracle Applications User's Guide*

## Purchasing Interface Errors Report

The Purchasing Interface Errors Report shows you what errors occurred, if any, while running the following programs:

- Receiving Open Interface - ASBN transactions
- Pay on Receipt - Receipt transactions
- Purchasing Documents Open Interface

For each row in the interface tables that fails validation, the above programs create one or more rows with error information that appears in the Purchasing Interface Errors

Report.

## Submission

In the Submit Requests window, select Purchasing Interface Errors Report in the Name field. A batch ID number is generated that you can refer to when you choose View My Requests from the Help menu.

## Parameters

### Source Program

Select the program whose errors you want reported.

<b>Receiving Open Interface</b>	Shows what errors occurred when the Receiving Open Interface tried creating an invoice from an Advance Shipment and Billing Notice (ASBN).
<b>Pay on Receipt - Receipt transactions</b>	Shows what errors occurred when the Pay on Receipt program tried creating an invoice from a receipt. Since Pay on Receipt also initiates the Payables Open Interface Import program to finish creating the invoices, also check the error report for the Payables Open Interface Import program. See: <i>Payables Open Interface Import, Oracle Payables User's Guide</i> .
<b>Purchasing Documents Open Interface</b>	Shows what errors occurred when the Purchasing Documents Open Interface program ran. The Purchasing Documents Open Interface program processes blanket purchase agreements, catalog quotations, or standard purchase orders that are in the Oracle Applications interface tables to ensure that the data is valid before importing it into Purchasing.

### Purge Data

Choose Yes to purge the data in the Purchasing Interface Errors table after the report runs. The errors you see in the report will not reappear the next time you run it. Only the data for the Source Program you chose will be deleted. Choose No to keep the errors in the table and in the report, listed along with any new errors.

## Related Topics

Submitting a Request, *Oracle Applications User's Guide*

Receiving Price/Sales Catalog Information Electronically, page 5-18

## Purge Purchasing Open Interface Processed Data

The Purge Purchasing Open Interface Processed Data process purges data in the Purchasing Documents Open Interface tables. You can purge this data after you have imported the data into Purchasing. This process purges only accepted or rejected data, not data that is still pending.

### Submission

1. In the Submit Requests window, select Purge Purchasing Open Interface Processed Data in the Name field.
2. Optionally specify the following information:
  - *Document Type* - Purges only documents of the document type you select.
  - *Document Subtype* - Purges only documents of the document subtype you select.
  - *Purge Accepted Data* - Purges only those documents that did not produce errors in the interface tables.
  - *Purge Rejected Data* - Purges only those documents that produced errors in the interface tables.
  - *Start Date / End Date* - Purges only those documents between the start and end dates you enter.
  - *Batch ID* - Purges only those documents imported under the Batch ID you enter.

If you leave all of these fields blank, this process purges all of the data in the interface tables.

3. Choose OK and Submit to begin the process.

### Related Topics

Submitting a Request, *Oracle Applications User's Guide*

Receiving Price/Sales Catalog Information Electronically, page 5-18

Purchasing Documents Open Interface, page 13-25

### Quality Code Listing

The Quality Code Listing shows inspection quality codes. You can use this listing to

help assign quality codes when inspections are performed. See: Defining Quality Inspection Codes, page 1-57.

## Submission

In the Submit Requests window, select Quality Code Listing in the Name field.

## Parameters

### Active/Inactive

Choose one of the following options:

<b>Active</b>	List only active codes on the report.
<b>Both</b>	List both active and inactive codes on the report.
<b>Inactive</b>	List only inactive codes on the report.

### Sort By

Use the Sort By feature to produce a report customized to your specific needs. Choose one of the following options:

<b>Quality Code</b>	Sort the report by quality code.
<b>Ranking</b>	Sort the report by ranking.

## Related Topics

Submitting a Request, *Oracle Applications User's Guide*

## Quotation Action Required Report

The Quotation Action Required report lists quotations that require follow-up action. This report provides you with all of the information you need to take *immediate* action on the quotation. Purchasing lets you specify the quotations you want to review. If you do not specify a date range, all quotations are displayed.

This report prints quotations that are about to expire. For each of these quotations, Purchasing prints the quotation number, the supplier name, the supplier site, the supplier quotation number, and the expiration date. Purchasing displays the quotation line details so you can quickly review the purpose of the quotations. See: Entering Quotation Headers, page 5-62.

## Submission

In the Submit Requests window, select Quotation Action Required Report in the Name field.

## Parameters

### Suppliers From/To

Enter the beginning and ending supplier names.

### Buyer

Enter a buyer name to restrict the report to a specific buyer.

### Quotation Expiration Dates From/To

Enter the beginning and ending expiration dates to limit the quotations to the ones with expiration dates during the date range. Note that if you enter a date range, the quotation warning delay is considered but quotations without an expiration date are excluded from the report.

### Categories From/To

Enter the beginning and ending purchasing categories.

### Dynamic Precision Option

Enter the decimal precision for quantities on the report.

## Related Topics

Submitting a Request, *Oracle Applications User's Guide*

## Receipt Adjustments Report

The Receipt Adjustments Report lists purchase order shipments, internal requisition lines, or return material authorization (RMA) lines with corrections or returns to supplier (or customer).

For supplier sourcing, the Source column lists the name of the supplier and supplier source for whom you make the adjustment. For inventory sourcing, the Source is the organization and subinventory. For returns from a customer, the Source is the customer name.

## Submission

In the Transaction Reports (for Inventory) or Submit Requests window, select Receipt Adjustments Report in the Name field.

## Parameters

### Receipt Location

Enter the receipt location to restrict the report to a specific location.

### Receiver

Enter the receiver name to restrict the report to a specific receiver.

### Receipt Date From/To

Enter the beginning and ending receipt dates.

### Supplier From/To

Enter the beginning and ending supplier names.

### Supplier Site

Enter the supplier site to restrict the report to a specific supplier site.

### Customer From/To

Enter a beginning and ending customer name if you want to review all expected returns from a specific customer or customers. These returns are authorized through an RMA document, which is created in Order Management.

### Organization Name

Enter the organization name to restrict the report to a specific organization.

### Sort By

Use the Sort By feature to produce a report customized to your specific needs. Choose one of the following options:

**Document Number**                      Sort the report by document number.

**Supplier**                                      Sort the report by supplier name.

## Dynamic Precision Option

Enter the decimal precision for quantities on the report.

## Related Topics

Submitting a Request, *Oracle Applications User's Guide*

## Receipt Traveler

The Receipt Traveler facilitates receiving inspection and delivery of goods you receive within your organization. After you receive the goods, you can print receipt travelers and attach these tickets to the goods. You can enter selection criteria to specify the receipt travelers you want to print. One receipt traveler prints per distribution, and each traveler has space for you to record delivery comments.

The report includes the document type. For the Supplier source type: *Standard Purchase Order, Blanket Release, or Scheduled Release*. For the Internal Order source type: *Internal Requisition*. For the Inventory source type: *Inventory*. For a return from a customer: *Return Material Authorization*.

The report also includes the source for the item you deliver. For source type *Supplier*, this is the supplier name. For source type *Inventory*, this is the Organization name. For source type *Internal Order*, this is the source subinventory. For source type *Customer*, this is the customer name.

If the RCV: Print Receipt Traveler profile option is set to *Yes*, the receipt traveler automatically prints when you perform a receipt or a receiving transaction, and when you match unordered receipts.

## Submission

In the Transaction Reports (for Inventory) or Submit Requests window, select Receipt Traveler in the Name field.

## Parameters

### Delivery Location

Enter a delivery location to restrict the report to a specific delivery location.

### Receipt Numbers From/To

Enter the beginning and ending receipt numbers.

**Items From/To**

Enter the beginning and ending item numbers.

**Categories From/To**

Enter a beginning and an ending category.

**Ship to Location**

Enter a ship-to location to restrict the report to a specific location.

**Organization Name**

Enter the organization name for this report.

**Dynamic Precision Option**

Enter the decimal precision for quantities on the report.

**Related Topics**

Submitting a Request, *Oracle Applications User's Guide*

Profile Options in Purchasing, page C-1

## Receiving Account Distribution Report

The Receiving Account Distribution Report lists the accounting distributions for your receiving transactions. This report supports the distributions created for the following transactions:

- Purchase Order Receipts
  - Purchase Order Receipt Adjustments
  - Purchase Order Returns to Supplier
  - Deliver to Expense Destinations
  - Return to Receiving from Expense Destinations
  - Match Unordered Receipts

This feature helps you reconcile your receiving accounting to your general ledger.

**Note:** The accounting distributions for Deliver to and Return from



both Inventory and Shop Floor (WIP) destinations are transferred to the General Ledger Interface by Inventory. When you reconcile your receiving inspection account, you need to include these transactions from the Material Account Distribution Reports as well as the WIP Account Distribution Reports.

## Submission

In the Transaction Reports (for Inventory) or Submit Requests windows, select Receiving Account Distribution Report in the Name field.

## Parameters

### Title

Enter your title for the report.

### Sort Option

Use the Sort By parameter to produce a report customized to your specific needs. Choose one of the following options:

- |                             |  |
|-----------------------------|--|
| <b>Account and Item</b>     | Sort the report by account and item.           |
| <b>Account and Receipt</b>  | Sort the report by account and receipt number. |
| <b>Account and Supplier</b> | Sort the report by account and supplier name.  |

### Organization Name

Enter the organization name to restrict the report to a specific organization. If you leave this field blank, the report prints distributions for all organizations.

### Date From/To

Enter the beginning and ending receipt dates.

### Item From/To

Enter the beginning and ending item numbers.

### Category Set

Enter the category set for which you want to print the report.

**Category From/To**

Enter the beginning and ending categories.

**Supplier From / Supplier To**

Enter the beginning and ending supplier names.

**Receipt Number From / Receipt Number To**

Enter the beginning and ending receipt numbers.

**Account From / Account To**

Enter the beginning and ending accounts.

**Dynamic Precision Option**

Enter the decimal precision for quantities on the report.

**Related Topics**

Submitting a Request, *Oracle Applications User's Guide*

## Receiving Exceptions Report

Use the Receiving Exceptions Report to review receipts for which there is a receipt exception. These receipts cannot be automatically closed for receiving or invoicing. You can enter a receipt exception when you receive the item.

**Submission**

In the Transaction Reports (for Inventory) or Submit Requests window, select Receiving Exceptions Report in the Name field.

**Parameters****Receipt Location**

Enter the receipt location to restrict the report to a specific location.

**Receiver**

Enter the receiver name to restrict the report to a specific receiver.

**Receipt Date From/To**

Enter the beginning and ending receipt dates.

**Supplier From/To**

Enter the beginning and ending supplier names.

**Supplier Site**

Enter the supplier site to restrict the report to a specific supplier site.

**Organization Name**

Enter the organization name to restrict the report to a specific organization.

**Sort By**

Use the Sort By feature to produce a report customized to your specific needs. Choose one of the following options:

**Purchase Order Number**                      Sort the report by purchase order number.

**Supplier**    Sort the report by supplier name.

**Dynamic Precision Option**

Enter the decimal precision for quantities on the report.

**Related Topics**

Submitting a Request, *Oracle Applications User's Guide*

**Receiving Interface Errors Report**

This report shows you what warnings or errors occurred while the Receiving Transaction Processor was processing rows in the Receiving Open Interface tables. Rows processed in the Receiving Open Interface include Advance Shipment Notices (ASNs), receipts, and deliveries. Any errors that occur during this process are displayed in the Receiving Interface Errors report when you run the report. At the same time, the errors are also sent to the Oracle e-Commerce Gateway process responsible for generating Application Advices. (For example, Application Advices are sent back to suppliers detailing errors that occurred when the suppliers sent ASNs.)

**Submission**

In the Submit Requests window, select *Receiving Interface Errors Report* in the Name

field.

## Parameters

### Start Date / End Date

Enter the Start and End dates of the period in which the Receiving Open Interface information was processed and the errors were generated.

### Purge Data

Enter Yes to purge the error records retrieved during this run.

## Related Topics

Submitting a Request, *Oracle Applications User's Guide*

Advance Shipment Notices (ASNs), page 9-15

## Receiving Transactions Register

The Receiving Transactions Register lists *detail* information about your receiving transactions. The register is sorted by item, category, receipt number, document number, and transaction date. The three-part document number represents purchase order number, purchase order line number, and purchase order shipment number. For receiving transactions created against customer returns, the two-part document number represents the return material authorization (RMA) number and RMA line number.

Note that the register does not include information for transactions that are awaiting processing when the receiving transaction processor is in Batch or Immediate mode.

## Submission

In the Transaction Reports (for Inventory) or Submit Requests window, select Receiving Transactions Register in the Name field.

## Parameters

### Organization

Enter the organization name to restrict the report to a specific organization.

### Transaction Type

Enter the transaction type to restrict the report to a specific transaction type.

**Transaction Dates From/To**

Enter the beginning and ending transaction dates.

**Receipt Numbers From/To**

Enter the beginning and ending receipt numbers.

**Receiver**

Enter the receiver to restrict the report to a specific receiver.

**Items From/To**

Enter the beginning and ending items.

**Categories From/To**

Enter the beginning and ending purchasing categories.

**Suppliers From/To**

Enter the beginning and ending suppliers.

**Purchase Order Numbers From/To**

Enter the beginning and ending purchase order numbers.

**Buyer**

Enter the buyer to restrict the report to a specific buyer.

**Internal Requisition Numbers From/To**

Enter the beginning and ending internal requisition numbers.

**Shipment Numbers From/To**

Enter the beginning and ending shipment numbers.

**Exception**

Enter Yes or No to indicate whether to print only transactions with a receiving exception or only transactions with no receiving exception. Leave this field blank to print transactions regardless of exception status.

**Detail**

Enter Yes or No to indicate whether to print detail.

### **Include Lot/Serial**

Enter Yes or No to indicate whether to print lot/serial number information.

### **RMA Numbers From/To**

Enter the beginning and ending return material authorization (RMA) document numbers. An RMA is created in Order Management to authorize a customer return to your company.

### **Customer From/To**

Enter a beginning and ending customer name if you want to review all receiving transactions that were created against returns from a specific customer or customers. These returns are authorized through an RMA document, which is created in Order Management.

### **Related Topics**

Submitting a Request, *Oracle Applications User's Guide*

## **Receiving Value Report**

The Receiving Value Report shows item quantity, valuation, and detailed receipt information for your receiving inspection location.

**Note:** If you choose a currency other than your functional currency, all value fields are multiplied by the exchange rate.

The Average Unit Price is calculated by dividing the total receiving value by the total receiving quantity on hand, using the primary unit of measure.

The Total Purchase Value is the quantity times the average unit price.

The Current Value is the sum of the quantity times the supplier cost for the cost type. This is the total cost of the item less any material overheads for the item. If material overheads are included, then the Purchase Price Difference column would be incorrect.

The Purchase Price Difference is the difference between the Total Purchase Value and the Current Value columns. You see this column only for inventory and shop floor (outside processing) destinations. This report also displays Outside Processing items with no associated resource value. You can use this information to manually accrue potential purchase price variances, before you deliver into inventory or work in process.

### **Submission**

In the Cost and Period Close Reports (for Inventory) or Submit Requests (for Cost

Management) window, select Receiving Value Report in the Name field.

## Parameters

### Organization Name

Enter the organization to restrict the report to a specific organization.

### Cost Type

Optionally, enter a cost type to change the reported values for the *Current Value* column. If you do not enter a cost type, the report uses the *Frozen* or *Average* cost type, depending on your costing method. If you specify a cost type, the report values the items at this cost type, for the respective supplier cost. This is the total cost of the item less any material overheads for the item. If the item is not in the specified cost type, the report values the item at the default cost type. For example, if you choose Quarter1 as the cost type and Quarter1 has Frozen as the default cost type, the report values the item at the Quarter1 cost. If Quarter1 is not available, it values the items at the *Frozen* cost type.

### Report Option

Choose one of the following options:

<b>Detail</b>	Include detail receipt information, such as receipt date, receipt number, shipment number, current location, deliver-to location, packing slip, document type, document number, and item revision.
<b>Summary</b>	Include only summary information for the item, such as item description, quantity, average unit price, and total purchase value.

### Sort

Choose one of the following options:

<b>Category</b>	Sort the report by category set and category.
<b>Destination</b>	Sort the report by purchase order destination and then by item.
<b>Destination and Category</b>	Sort the report by destination, by category set/category and then by item.
<b>Item</b>	Sort the report by item.
<b>Location</b>	Sort the report by current receiving location and then by

item.

**Supplier**

Sort the report by supplier and then by item.

**Item From / Item To**

Enter a beginning and an ending item to restrict the report to a range of items.

**Category Set**

Enter a category set to restrict the report to that category set.

**Category From / Category To**

Enter a beginning and an ending category to restrict the report to a range of categories.

**Currency**

Enter a currency. When you enter a currency other than your functional currency, item costs are converted to the selected currency using the *End of period rate* you choose in the Exchange Rate field.

**Exchange Rate**

Choose an exchange rate. If you choose a currency other than your functional currency, the default is the most recent *End of period rate*. However, you can choose any prior *End of period rate*. See: *Entering Period Rates, Oracle General Ledger Implementation Guide*.

**Quantities by Revision**

Enter *Yes* or *No* to indicate whether you want to display item quantities by the revision of the item on the report. You can see revision quantities only when you choose *Detail* for the Report Option.

**Display Zero Costs Only**

Enter *Yes* or *No* to indicate whether you want to display items with zero costs only on the report. You use this option to identify any items that have a zero standard cost, before you deliver into inventory.

**Document Type**

Enter *Purchase Order* or *Requisition* to limit the reported information. If you do not enter a document type, the report displays both document types.

**Related Topics**

Submitting a Request, *Oracle Applications User's Guide*



## Receiving Value Report by Destination Account

The Receiving Value Report by Destination Account lists received items by purchase order destination and distribution account. If you accrue both inventory and expense at the time of receipt, you may have both inventory and expense as part of your receiving valuation account. The Receiving Value Report by Destination Account allocates your receiving balances by the purchase order line inventory, expense accounts, and quantities. You can then use this report to manually reclass the receiving valuation account to the appropriate expense accounts.

### Submission

In the Cost and Period Close Reports (for Inventory) or Submit Requests windows, select Receiving Value Report by Destination Account in the Name field.

### Parameters

#### Items From / Items To

Enter the beginning and ending item numbers.

#### Categories From / Categories To

Enter the beginning and ending purchasing categories.

#### Destination Type

Enter a destination type to restrict the report to a specific destination type, such as Expense, Inventory, or Shop Floor.

#### Accounts From / Accounts To

Enter the beginning and ending accounts.

#### Organization Name

Enter the organization name to restrict the report to a specific organization.

#### Exclude One-time Items

Enter Yes or No to indicate whether you want to exclude one-time items from the report.

#### Dynamic Precision Option

Enter the decimal precision for quantities on the report.

## Related Topics

Submitting a Request, *Oracle Applications User's Guide*

## ReqExpress Templates Listing

The ReqExpress Templates Listing shows requisition template detail information.

The report lists *sourcing* information appropriate for the source type. For the Inventory source type, this is the organization and subinventory. For the Supplier source type, this is the buyer, supplier, supplier site, contact, supplier item number, and RFQ Required flag value.

## Submission

In the Submit Requests window, select ReqExpress Templates Listing in the Name field.

## Parameters

### Express Name

Enter the template name to restrict the report to a specific template.

## Related Topics

Submitting a Request, *Oracle Applications User's Guide*

## Requisition Activity Register

The Requisition Activity Register shows requisition activity and monetary values. Purchasing prints the requisitions in order of *creation* date and prepared name.

## Submission

In the Submit Requests window, select Requisition Activity Register in the Name field.

## Parameters

### Creation Dates From/To

Enter the beginning and ending requisition creation dates.

### Preparer

Enter the preparer name to restrict the report to a requisitions from a specific preparer.

## Requisition Type

Enter the requisitions document type (Purchase Requisition or Inventory Requisition) to restrict the report to a specific type.

## Related Topics

Submitting a Request, *Oracle Applications User's Guide*

## Requisition Distribution Detail Report

The Requisition Distribution Detail Report lists requisitions, distributions, and charge account information. You can also use the report to review requisitions that failed funds reservation if you have enabled encumbrance. Totals print *only* if encumbrance has been enabled.

## Submission

In the Submit Requests window, select Requisition Distribution Detail Report in the Name field.

## Parameters

### Requisition Numbers From/To

Enter the beginning and ending requisition numbers.

### Requisition Creation Dates From/To

Enter the beginning and ending creation dates.

### Preparer

Enter a preparer name to restrict the report to a specific preparer.

### Failed Funds Only

Enter Yes or No to indicate whether you want to restrict the report to purchase orders that failed funds checking.

### Dynamic Precision Option

Enter the decimal precision for quantities on the report.

## Related Topics

Submitting a Request, *Oracle Applications User's Guide*

## Requisition Import Exceptions Report

The Requisition Import Exceptions Report shows *errors* from the Requisition Import process. If the Requisition Import process finds any requisitions that it cannot create, Purchasing records the errors in the PO Interface Errors Table.

### Submission

In the Submit Requests window, select Requisition Import Exceptions Report in the Name field.

### Parameters

#### Import Source

Enter the interface source to restrict the report to a specific import source.

#### Import Batch ID

Enter the name of a Requisition Import batch to restrict the report to a specific batch within your Import Source.

### Delete Exceptions

Enter Yes or No to indicate whether you want to delete the exceptions from the PO interface errors table. If you enter Yes, Purchasing prints the report and deletes the items printed from the PO Interface Errors Table. If you enter No, Purchasing Prints the report and leaves the errors in the error table. Each time Requisition Import process is generated, new transaction id numbers are created for errors. If the errors are not deleted, they remain in the Errors Table and are listed along with new error messages generated by the Requisition Import process for the same Import Source and Import Batch ID.

## Related Topics

Submitting a Request, *Oracle Applications User's Guide*

Requisition Import Process, page 13-29

## Requisitions on Cancelled Sales Order Report

The Requisitions on Cancelled Sales Order Report shows information on *internally* sourced requisition lines for which a sales order has been generated and subsequently cancelled. You can run the report only if Order Management is installed.

### Submission

In the Submit Requests window, select Requisitions on Cancelled Sales Order Report in the Name field.

### Parameters

#### Items From/To

Enter the beginning and ending item numbers.

#### Requestor

Enter a requestor name to restrict the report to a specific requestor.

#### Categories From/To

Enter the beginning and ending purchasing categories.

#### Dynamic Precision Option

Enter the decimal precision for quantities on the report.

### Related Topics

Submitting a Request, *Oracle Applications User's Guide*

## RFQ Action Required Report

The RFQ Action Required report lists RFQs that require follow-up action. This report provides you with all of the information you need to take immediate action on RFQs approaching the reply due date. Purchasing lets you specify which RFQs you want to review.

This report prints your RFQs for which you have not received complete responses. For each RFQ, Purchasing prints the RFQ description and the reply due date. To help you contact the supplier that requires action, Purchasing prints the supplier, supplier site, supplier contact, and telephone number of the contact. See: Entering RFQ Headers, page 5-49.

## Submission

In the Submit Requests window, select RFQ Action Required Report in the Name field.

## Parameters

### Buyer

Enter a buyer name to restrict the report to a specific buyer.

### RFQ Reply Date From/To

Enter the beginning and ending reply dates. Purchasing breaks and prints on the reply date.

### Suppliers From/To

Enter the beginning and ending supplier names.

### Categories From/To

Enter the beginning and ending purchasing categories.

### Sort By

Choose one of the following options:

**Buyer Name** Sort the report by buyer name.

**RFQ Reply Date** Sort the report by RFQ reply date.

## Related Topics

Submitting a Request, *Oracle Applications User's Guide*

## Savings Analysis Report (by Buyer)

The Savings Analysis Report (By Buyer) shows buyer performance by purchase order.

The Negotiated Amount is the product of the price on the quotation and the quantity ordered. If a quote is not defined, Purchasing prints the product of the market price of the item ordered and the quantity ordered. If the market price is not defined, Purchasing uses the list price.

The report includes a price type Legend at the bottom of each page for the price type. If the line price type is Q, the line price was from the Quote. If the line price type is M, the line price was from Market Price, and if the line price type is L, the line price was from

List Price.

The Actual Amount is the product of the actual price listed on the purchase order line and the quantity ordered.

The Amount Saved is the negotiated amount less the actual amount, with negative figures in parentheses.

## Submission

In the Submit Requests window, select Savings Analysis Report (By Buyer) in the Name field.

## Parameters

### Creation Date From/To

Enter the beginning and ending creation dates.

### Buyer

Enter the buyer name to restrict the report to a specific buyer.

### Sort By

Use the Sort By feature to produce a report customized to your specific needs. Choose one of the following options:

**PO Type** Sort the report by buyer name and purchase order type.

**Purchase Order Number** Sort the report by buyer name and purchase order number.

### Dynamic Precision Option

Enter the decimal precision for quantities on the report.

## Related Topics

Submitting a Request, *Oracle Applications User's Guide*

## Savings Analysis Report (by Category)

The Savings Analysis Report (By Category) shows buyer performance by category. Use the report to compare the market, quote, or list price to the actual price.

The Negotiated Amount is the product of the price on the quotation and the quantity ordered. If a quote is *not* defined, Purchasing prints the product of the market price of the item ordered and the quantity ordered. If the market price is not defined,

Purchasing uses the list price.

The report includes a price type Legend at the bottom of each page for the price type. If the line price type is Q, the line price was from the Quote. If the line price type is M, the line price was from Market Price, and if the line price type is L, the line price was from List Price.

The Actual Amount is the product of the actual price listed on the purchase order line and the quantity ordered.

The Amount Saved is the negotiated amount less the actual amount, with negative figures in parentheses.

## Submission

In the Submit Requests window, select Savings Analysis Report (By Category) in the Name field.

## Parameters

### Buyer

Enter the buyer name to restrict the report to a specific buyer.

### Creation Dates From/To

Enter the beginning and ending document creation dates.

### Categories From/To

Enter the beginning and ending categories from the purchasing category set.

### Dynamic Precision Option

Enter the decimal precision for quantities on the report.

## Related Topics

Submitting a Request, *Oracle Applications User's Guide*

## Standard Notes Listing

The Standard Notes Listing shows your standard notes and their start and end dates.

The report lists standard notes *alphabetically* by usage and name.



## Submission

In the Submit Requests window, select Standard Notes Listing in the Name field.

## Parameters

### Usages From/To

Enter the beginning and ending usages. Standard usages are the following: Approver, Buyer, Invoice Internal, Item Internal, PO Internal, Payables, Quote Internal, RCV Internal, RFQ Internal, Receiver, Req Internal, and Supplier.

When you enter a note for an invoice, you can assign a use of Invoice Internal or Supplier.

### Names From/To

Enter the beginning and ending note names.

Purchasing includes notes whose names fall alphabetically, within the range you enter, including the notes with the beginning and end names you specify.

## Related Topics

Submitting a Request, *Oracle Applications User's Guide*

## Substitute Receipts Report

The Substitute Receipts Report lists all or specific substitute receipts. To prevent disruption in your receiving process, Purchasing lets you receive items which a supplier has delivered as a *substitute* for the ordered item. You need to predefine the items you accept as substitute for other items. See: Defining Item Revisions, *Oracle Inventory User's Guide*.

The report includes sourcing information appropriate for the source type. For the Inventory source type, this is the organization and subinventory. For the Supplier source type, this is the supplier and supplier site.

## Submission

In the Submit Requests window, select Substitute Receipts Report in the Name field.

## Parameters

### Transaction Dates From/To

Enter the beginning and ending transaction dates.

### Organization Name

Enter the organization name to restrict the report to a specific organization.

### Dynamic Precision Option

Enter the decimal precision for quantities on the report.

## Related Topics

Submitting a Request, *Oracle Applications User's Guide*

## Summary Accrual Reconciliation Report

The Summary Accrual Reconciliation Report can be used to analyze the balance of the Accounts Payable (AP) accrual accounts. You can accrue both expense and inventory purchases as you receive them. When this happens, you temporarily record an accounts payable liability to your Expense or Inventory AP accrual accounts. When Oracle Payables creates the accounting for the matched and approved invoice, Oracle Payables clears the AP accrual accounts and records the liability from the supplier site. See: Overview of Receipt Accounting, .

The Accrual Reconciliation Report helps you monitor potential problems with purchasing and receiving activities that can affect the accuracy of your A/P accrual accounts. It displays the balance of each accrual account as well as partial representation of source of the balance

## Prerequisites

If you install Purchasing and Oracle Payables, you can run this report. If you accrue expense purchases on receipt, you can reconcile your expense A/P accrual account using this report. If you accrue expense purchases at period end and you do not perform inventory receipts, no information will be available to report. If you have installed Oracle Inventory or Work in Process, the Accrual Reconciliation Report also displays any inventory or work in process transactions for the accrual accounts.

**Important:** Most commercial installations accrue expense receipts at period end because this information is not required as the receipt occurs. If you accrue expense purchases on receipt, you have more

entries to reconcile in the A/P accrual accounts. In addition, if you also receive inventory, you need to use the Receiving Value By Destination Account Report to break out your receiving/inspection value by asset and expense.

## Report Submission

In the Submit Requests window, select Summary Accrual Reconciliation Report in the Name field.

## Report Parameters

### Operating Unit

Select the operating unit for the report.

### Title

Enter your title for the report.

### Balancing Segment From

Lower limit of the balancing segment range you want the report to consider.

### Balancing Segment To

Upper limit of the balancing segment range you want the report to consider.

## Related Topics

Inventory Standard Cost Transactions, *Oracle Cost Management User's Guide*

Overview of Standard Costing, *Oracle Cost Management User's Guide*

Overview of Average Costing, *Oracle Cost Management User's Guide*

Overview of Work in Process Costing, *Oracle Work in Process User's Guide*

Overview of Receipt Accounting, page 9-86

Accrual Write-Off Report, page 11-1

Using the Account Generator in Oracle Purchasing, page E-6

Submitting a Request, *Oracle Applications User's Guide*

## Supplier Affiliated Structure Listing

The Supplier Affiliated Structure Listing shows information about your supplier's

parent-child relationships. Your list of suppliers includes suppliers who are *subsidiaries* of larger companies. The Supplier Affiliated Structure Listing allows you to review the relationships established. The subsidiary company is the child supplier to the parent supplier.

## Submission

In the Submit Requests window, select Supplier Affiliated Structure Listing in the Name field.

## Parameters

### Suppliers From/To

Enter the beginning and ending supplier names.

## Related Topics

Submitting a Request, *Oracle Applications User's Guide*

## Supplier Price Performance Analysis Report

Use the Supplier Price Performance Analysis Report to compare the price of an item from different suppliers.

## Submission

In the Submit Requests window, select Supplier Price Performance Analysis Report in the Name field.

## Parameters

### Suppliers From/To

Enter the beginning and ending supplier names.

### Period From/To

Enter the beginning and ending periods.

### Creation Date From/To

Enter the beginning and ending purchase order creation dates.

**Categories From/To**

Enter the beginning and ending purchasing categories.

**Items From/To**

Enter the beginning and ending system item numbers.

**Sort By**

Choose one of the following options:

<b>Category</b>	Sort the report by purchasing category. If you do not make an entry, this is the default.
<b>Item</b>	Sort the report by item number.

**Dynamic Precision Option**

Enter the decimal precision for quantities on the report.

**Related Topics**

Submitting a Request, *Oracle Applications User's Guide*

## Supplier Purchase Summary Report

The Supplier Purchase Summary report lists the numbers and amount of orders you have placed with various suppliers during a particular period. You can use this information to analyze and manage your purchasing volume with your suppliers. You can also use the Small Business Sort By option to get the statistics you need to complete the Cumulative Commitments section of Form 295 as required for compliance with the Federal Acquisition Regulation (FAR) (U.S.). In addition, with the New Supplier Listing you can update the information provided by your suppliers.

**Submission**

In the Submit Requests window, select Supplier Purchase Summary Report in the Name field.

**Parameters****Creation Dates From/To**

Enter the beginning and ending creation dates.

## Supplier Type

Enter the supplier type from the Lookup Codes window to restrict the report to a specific supplier type. See: *Defining Lookup Codes*, page 1-55.

## Small Business

Enter Yes to restrict the report to small business suppliers.

## Minority Owned

Enter Yes to restrict the report to minority owned suppliers.

## Women Owned

Enter Yes to restrict the report to women owned suppliers.

## Sort By

Use the Sort By feature to produce a report customized to your specific needs. Choose one of the following options:

<b>Supplier</b>	Sort the report by supplier name, supplier site, and PO number
<b>Supplier Type</b>	Sort the report by supplier type, supplier name, supplier site, and PO number

## Related Topics

Submitting a Request, *Oracle Applications User's Guide*

Suppliers, *Oracle iSupplier Portal Implementation Guide*.

New Supplier Listing, page 11-30

## Supplier Quality Performance Analysis Report

The Supplier Quality Performance Analysis Report can be used to review your suppliers' *quality* performance. You can review supplier quality performance for percents accepted, rejected, and returned. You can use this report to identify suppliers with quality performance issues.

## Submission

In the Submit Requests window, select Supplier Quality Performance Analysis Report in the Name field.

## Parameters

### Items From/To

Enter the beginning and ending item numbers.

### Suppliers From/To

Enter the beginning and ending supplier names.

### Categories From/To

Enter the beginning and ending purchasing categories.

### Buyer

Enter a buyer name to restrict the report to a specific buyer.

### Creation Dates From/To

Enter the beginning and ending creation dates.

### Detail

Enter Yes or No to indicate whether you want to print detail information on the report.

### Dynamic Precision Option

Enter the decimal precision for quantities on the report.

### Related Topics

Submitting a Request, *Oracle Applications User's Guide*

## Supplier Service Performance Analysis Report

The Supplier Service Performance Analysis Report lists late shipments, early shipments, rejected shipments, and shipments to *wrong* locations. You can use this report to derive a supplier service penalty by multiplying the days variance quantity by a percentage of the price.

The % Open Current is the percentage of the ordered quantity not yet received, but within the receipt tolerance days or not past due.

The % Open Past Due is the percentage of the ordered quantity not received by the

promise date and beyond the receipt tolerance days.

The % Received On Time is the percentage of the ordered quantity received on the promise date or within the receipt tolerance days.

The % Received Late is the percentage of the ordered quantity received after the promise date and outside the receipt tolerance days.

The % Received Early is the percentage of the ordered quantity received before the promise date and outside the receipt tolerance days.

The Days Variance is calculated as the summation of the date differential (transaction date subtracted from promise date) multiplied by the corrected received quantity (the received quantity plus or minus corrections) for each shipment, all divided by the total corrected received quantity. The result is the quantity per day the supplier is in variance.

## **Submission**

In the Submit Requests window, select Supplier Service Performance Analysis Report in the Name field.

## **Parameters**

### **Items From/To**

Enter the beginning and ending item numbers.

### **Suppliers From/To**

Enter the beginning and ending supplier names.

### **Categories From/To**

Enter the beginning and ending purchasing categories.

### **Buyer**

Enter a buyer name to restrict the report to a specific buyer.

### **Creation Dates From/To**

Enter the beginning and ending creation dates.

### **Detail**

Enter Yes or No to indicate whether you want to print detail information for each purchase order on the report.



### Dynamic Precision Option

Enter the decimal precision for quantities on the report.

### Related Topics

Submitting a Request, *Oracle Applications User's Guide*

## Supplier Volume Analysis Report

The Supplier Volume Analysis Report shows the dollar value of items you purchase from a supplier. The report prints the items that are assigned sourcing rules. Use the report to compare your actual purchase percentages with your sourcing percentage.

The Expenditure is the *sum* of the item line amounts for standard purchase orders for the supplier.

The Actual Percentage is the items expenditure as a percentage of the total expenditure for the date range of the report.

The Intended Commitment is the total expenditure multiplied by the split percentage entered in the sourcing rules.

### Submission

In the Submit Requests window, select Supplier Volume Analysis Report in the Name field.

### Parameters

#### Items From/To

Enter the beginning and ending item numbers.

#### Creation Dates From/To

Enter the beginning and ending purchase order creation dates.

### Related Topics

Submitting a Request, *Oracle Applications User's Guide*

## Suppliers on Hold Report

The Suppliers on Hold Report lists all suppliers with purchase orders that are on hold. This report also prints all purchase orders you still have outstanding with the suppliers

on hold.

## Submission

In the Submit Requests window, select Suppliers on Hold Report in the Name field.

## Parameters

### Supplier Names From/To

Enter the beginning and ending supplier names.

### PO Numbers From/To

Enter the beginning and ending purchase order numbers.

## Sort By

Use the sort by feature to produce a report customized to your specific needs. Choose one of the following options:

<b>Purchase Order Number</b>	Sort the report by purchase order number
<b>Supplier</b>	Sort the report by supplier

## Dynamic Precision Option

Enter the decimal precision for quantities on the report.

## Related Topics

Submitting a Request, *Oracle Applications User's Guide*

## Uninvoiced Receipts Report

The Uninvoiced Receipts Report should be run before the Receipt Accrual - Period-End process. With this report, you can review all or specific uninvoiced receipts for both period end and online accruals. Uninvoiced receipts are goods and services you have received that your supplier did not invoice yet. This report indicates exactly what you have to accrue and for what amount, and helps you analyze your receipt accrual entries. The accrual amount is the difference between the quantity received and the quantity billed multiplied by the unit price of the item.

## Submission

In the Submit Requests window, select Uninvoiced Receipts Report in the Name field.

## Parameters

### Title

Enter your title for the report.

### Accrued Receipts

Enter Yes to indicate that you want to include accrued receipts on the report. Otherwise, the report includes only unaccrued receipts.

### Include Online Accruals

Enter Yes to indicate that you want to include online accruals on the report. Typically, you use the Accrual Reconciliation Report rather than this report to analyze your online accruals.

### Include Closed POs

Enter Yes to indicate that the report should include purchase orders with a status of closed. Otherwise, the report excludes all the purchase orders in a closed status.

### Categories From/To

Enter the beginning and ending purchasing categories.

### Minimum Extended Value

Enter the minimum extended value for the report.

### Period Name

Enter a period name to restrict the report to the periods up to and including the specified period.

### Suppliers From/To

Enter the beginning and ending supplier names.

### Sort By

Choose one of the following options:

**Category** Sort the report by purchasing category.

**Supplier** Sort the report by supplier name.

## Dynamic Precision Option

Enter the decimal precision for quantities on the report.

## Related Topics

Receipt Accruals - Period End Process, page 13-25

Accrual Reconciliation Report, page 11-82

Submitting a Request, *Oracle Applications User's Guide*

## Unit of Measure Class Listing

The Unit Of Measure Class Listing shows the classes of measurement you have defined. A unit of measure class is a grouping of common units of measurement. For example, the standard measurement for distance is inch, yard, foot, or mile. Units of distance are assigned to the class Distance. The units assigned to a class are reviewed in the Unit Of Measure Listing.

## Submission

In the Submit Requests window, select Unit of Measure Class Listing in the Name field.

## Parameters

### Active/Inactive

Choose one of the following options:

- |                 |  |
|-----------------|--|
| <b>Active</b>   | List only active unit of measure classes on the report.              |
| <b>Both</b>     | List both active and inactive unit of measure classes on the report. |
| <b>Inactive</b> | List only inactive unit of measure classes on the report.            |

## Related Topics

Defining Unit of Measure Classes, *Oracle Inventory User's Guide*

Submitting a Request, *Oracle Applications User's Guide*

## Unit of Measure Listing

The Unit of Measure Listing shows the unit conversions you have defined in the Unit of

Measure Conversions window. A unit of measure is assigned to a class. The class is a common grouping of units based on a common denominator. For example, distance is a class of measurement; where inch, foot, yard and mile are units of distance measurement. The base unit would be foot. The unit of measure inch would have a conversion of .08333, which is multiplied by the base unit foot to create the conversion from inch to foot. The conversion for mile would be 5280. A unit is assigned to a class to ensure that it has a common denominator of conversion. In other words, gallons are in a different class than miles. Gallons are a unit of volume, and miles are a unit of distance. You can assign items an interclass conversion.

Use this report to review the units of measure conversions when you create purchase orders or requisitions, or enter receiving, delivery, or inspection transactions

## Submission

In the Submit Requests window, select Unit of Measure Listing in the Name field.

## Parameters

### Active/Inactive

Choose one of the following options:

- |                 |   |
|-----------------|---|
| <b>Active</b>   | List only active units of measure on the report.              |
| <b>Both</b>     | List both active and inactive units of measure on the report. |
| <b>Inactive</b> | List only inactive units of measure on the report.            |

### Dynamic Precision Option

Enter the decimal precision for quantities on the report.

## Related Topics

Submitting a Request, *Oracle Applications User's Guide*

Defining Unit of Measure Conversions, *Oracle Inventory User's Guide*

## Unordered Receipts Report

The Unordered Receipts Report lists all or selected *unordered* receipts. Unordered receipts refer to received items that receivers could not match to purchase orders or return material authorizations (RMAs). You can enter unordered receipt transactions only if you set up your system options accordingly. Purchasing lets you specify which unordered receipts you want to review. See: Defining Purchasing Options, page 1-33.

## Submission

In the Submit Requests window, select Unordered Receipts Report in the Name field.

## Parameters

### Transaction Dates From/To

Enter the beginning and ending transaction dates.

### Organization Name

Enter the organization to restrict the report to a specific organization.

### Source

Choose Supplier to view unordered receipts that will be matched to purchase orders.

Choose Customer to view unordered receipts that will be matched to return material authorization (RMA) documents. An RMA is created in Order Management to authorize a customer return to your company.

If you want to view all unordered receipts (for suppliers and customers), run the report twice, once with a Customer source and once with a Supplier source.

### Dynamic Precision Option

Enter the decimal precision for quantities on the report.

## Related Topics

Defining Unit of Measure Conversions, *Oracle Inventory User's Guide*

---

## Integration with Other Applications

### Integration for Engineering and Construction Industry

#### Business Processes in the Engineering and Construction Industry

1. The project/contract manager negotiates the terms and conditions of the subcontract, which often contains a Pay when Paid clause in the Engineering and Construction industry.
2. As work is performed, the subcontractor organization submits applications for payment, which are processed and passed through an appropriate approval process. The applications for payment often go to the project manager who reviews them against the progress and quality of the work done by the subcontractor.
3. The approved work confirmations are placed on hold in line with the Pay when Paid subcontract clause. As well as reviewing the applications for payment on hold, the project manager is also responsible for reviewing all costs related to the project, along with owner invoices, etc.
4. The project accountant/billing administrator distributes and adjusts costs, reviews expenditures, milestones and deliverables for billing eligibility, then generates the owner invoices and revenue.
5. In some cases, a link between the subcontractor applications for payment, and the corresponding owner invoices, may be made. This can assist with the subsequent removal of the Pay when Paid holds, when the owner receipt comes in.
6. The owner organization processes the invoice and pays the general contractor. Upon receipt of the payment, the billing administrator applies the amounts to the owner invoices.
7. The project manager reviews the payment applied to the owner invoice and

determines the list of subcontractor applications for payment to be removed from hold, and approves them. A variety of other checks may also be carried out before agreeing to pay the application for payment.

8. There may also be one or more additional levels of approval after the project manager approval. For example, there is often a review carried out by the accounting staff, which may wish to review the payment being made to the subcontractor from an overall cash flow perspective.
9. The Payables organization can now process the subcontractor invoices that have been released and issue payment to the subcontractor as appropriate.

In the Engineering and Construction industry, subcontracts frequently require subcontractors to maintain specified insurance coverage or work-related certifications. The subcontractor must submit all of the subcontractor requirements, and submittals must be tracked and managed for each project. Proof of insurance, lien waivers and other certificates are also often required before payment is made, for example, insurance certificates should be checked for expiration before payment. If the subcontractor allows documents such as insurance certificates to expire without renewal, invoices may need to be placed on hold automatically. The Project/Contract Manager is responsible for reviewing individual sub-contractor invoices for processing and payment, against these pre-determined contract criteria, and for managing the holds that result when the subcontractors documents are not compliant.

Subcontractor requirements may be one-time requirements, such as a bond, which requires approval once only; alternatively, they may be iterative requirements, which require periodic renewal through the life of the project/contract. In some instances, submissions of requirements lower down in the subcontractor chain need to be tracked. An example would be the case where the general contractor's subcontractor has further subcontracted out their portion of the work. In this scenario, the general contractor may need to track and ensure that the subcontractor's subcontractor has submitted lien waivers, before the general contractor pays their subcontractor.

The term Pay When Paid refers to the situation when the Project Manager would be able to pay subcontractor only when paid by customer.

A Pay when Paid LOV is seeded in Purchase Orders in Oracle Purchasing. The LOV is available on standard purchase orders as well as procurement contracts. The profile option PA: Pay When Paid is used to control the display of the payment term on purchasing documents. The Project Manager sets the value of the profile option in Oracle Projects. The profile option supports site level and Operating Unit level values. The default value is Disabled. When the profile option is Enabled, the Pay when Paid LOV is displayed on complex work purchase orders for the given site or operating unit. When the Pay When Paid LOV is selected as Yes, all invoices matched to the purchase order will be placed on payment hold by the invoice validation routine. The buyer can set the Pay When Paid LOV to Yes.

Oracle Purchasing displays the Pay When Paid LOV in the Terms region, with a default value of No. This LOV displays only if the profile option PA: Pay When Paid in Oracle



Projects is enabled. When you select Yes then all Payables invoices created with a reference to this contract would be put on a Pay when Paid hold. Once the order has been completed and approved the users should not be able to update the value of the LOV. This LOV is available for Standard Purchase Orders and with the document style, which uses Complex work details like Progress payments, Contract financing etc.

### **Initiate Payment Holds**

During invoice validation, the purchase order is matched with the invoice. The PO program is called to check the value of the Pay When Paid LOV. If the value of the Pay When Paid LOV is Yes, then a hold is applied to the invoice.

The OKC (Contracts) program is called when the Pay When Paid LOV has a value of Yes. The OKC program provides the information of the hold to be applied to Purchasing. Purchasing passes this hold information to the Payables module. The deliverable hold is applied to the invoice.

The region Initiate Payment Holds is displayed when the Pay when Paid LOV is selected as Yes for this complex work purchase order. The region Initiate Payment Holds on the Deliverables Page has five new attributes as shown in the figure:

- Prior to Due Date
- Value (text field)
- Choice field with seeded values of Days, Weeks, Months and Years
- Deliverable Overdue checkbox
- Initiate Holds – System type Look up code with 2 seeded values - All Invoices and new Invoices

If the Prior to Due date check box is checked you need to provide a value in the field next to it (Days, Weeks, Months or Years) and also choose a UOM for time. Only one option should be active at a single point of time. If you have checked Prior to due date or Deliverable Overdue checkbox , only then can you select a value from the Apply Holds LOV.

### **Integration with Oracle Projects**

Projects Workbench enables you to track and monitor subcontract deliverables. In case of non-compliance of subcontract deliverables, automatic holds could be placed on the subcontract invoices. The Project Manager can also view a check list of all subcontract deliverables that assists in evaluating the subcontractor status prior to releasing monthly Progress payments.

Using the Projects Workbench, Project Managers with the appropriate security privileges can update existing deliverables or define new deliverables to track future subcontractor obligations. Project Managers can directly update the Contract Deliverables, Deliverable Status, add notes and attachments without having to go

through the Purchasing re-approval process.

Project Managers can also perform the following: creating a new deliverable or creating a new repeating deliverable, removing a deliverable, updating Deliverable Name, Deliverable Description, Requestor, Supplier Contact, Internal Contact Deliverable, Deliverable Due Date, repeating attributes, initiate payment hold.

In project-centric industries such as Engineering and Construction, buyers are usually assigned to projects, rather than to commodities or item categories. Buyers only have the authority to transact on behalf of the projects to which they are assigned. To help enforce this business rule, project level security is implemented in Oracle Purchasing. If a user has access to a project, he also has access to the POs associated with that project.

### **Integration with iSupplier Portal**

Buyers and suppliers can track and view the progress of the Work Confirmation (of the complex work order) using the Work Confirmation page in iSupplier Portal. They can enter and view the absolute and percentage values for both incremental and cumulative progress. For more information on the Work Confirmation page, please refer to the *iSupplier Portal User's Guide*.

## **Landed Cost Management**

Landed Cost Management (LCM) helps you capture all the costs related to a purchase such as freight, insurance, taxes (country, state, local etc). Landed Cost Management enables you to calculate landed cost of the item, which is taken into consideration for costing and accounting purposes. This helps customers to value goods at actual cost and also helps in complying with the country's fiscal/legal requirements.

Receipts with landed cost are supported only for Inventory Items with Shipment destination type Inventory. PO shipments are flagged as LCM. Landed cost support is not available for Consigned and Outsourced assembly receipts. All other PO receipts with in LCM enabled organizations are costed, based on the PO price as it is done in the existing functionality There is no impact of Landed Cost Management calculation on Internal order receipts, RMA receipts LCM integration.

For a PO if the LCM flag (in Inventory) is Y, then the Invoice match option is set to Receipt as per the default option and the destination type on PO Distributions will be set to Inventory; the field is updatable. The LCM Flag Check takes place at the time of Document Approval Submission. For a release, if the LCM Flag is Y then Invoice match option is set to Receipt as per the default option and the destination type on PO Distributions is set to Inventory; the field is updatable. For Landed Cost Management Purchase Orders, the validation takes place only if the invoice match option is set to Receipt and the destination type is Inventory. If not, the submission check will display an error message.

For information on Landed Cost Management's integration with Receiving, please refer to the Receiving chapter, Integration with Landed Cost Management, page 9-121 section.

## Landed Cost Simulation

Simulating costs when creating the purchase orders enables buyers to take better sourcing decisions by comparing the overall landed costs including all applicable costs instead of relying on the item price only.

If integration with LCM is enabled, then buyers can request a landed cost estimation calculation for *unapproved* purchase documents. They can perform the following activities:

- Create a standard purchase order, blanket release, or planned purchase order
- Simulate landed costs
- Review simulated landed cost information for purchasing and firm the best simulation version

For more information on simulating landed cost, refer to the Managing Simulated Landed Cost topic in the *Oracle Landed Cost Management Process Guide*

### Navigating to the Landed Cost Simulations Page from Purchasing:

To simulate charges, the Manage Landed Costs action is available from Buyer Worker Center.

1. Follow this navigation path: Buyer Work Center > Orders > Create Order.
2. After creating the purchase order details, select the Manage Landed Costs action and click Go.

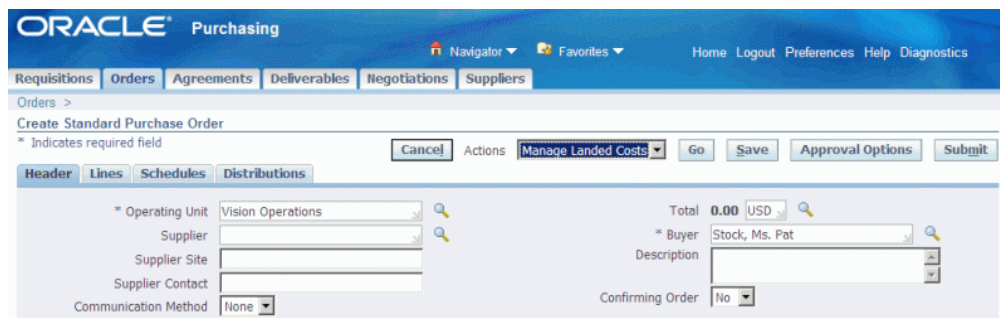

The Landed Cost Simulations page appears to simulate costs.

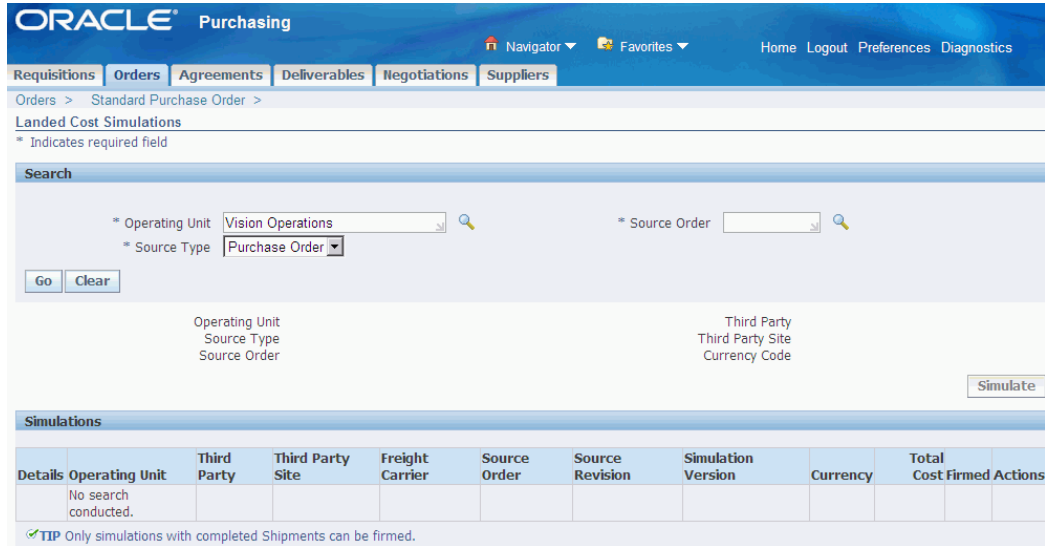

The buyer can also simulate cost when updating a purchase order.

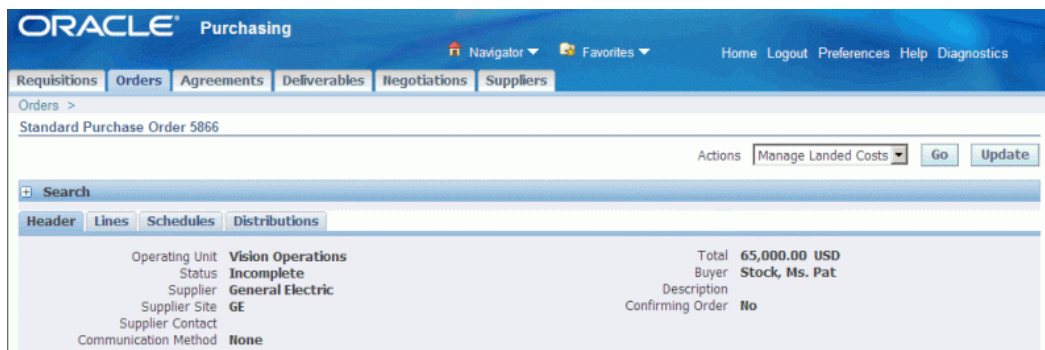

## Pricing Transparency

The pricing transparency enables you to recalculate the PO price based on specific business processes. The following products are integrated to provide the pricing transparency functionality:

### iProcurement Integration

When a requisition created in iProcurement for an item with GBPA reference is converted to a Purchase Order in the Buyers Work Center, the price and the modifiers (automatic and manual) applied to the GBPA will appear in the View Price structure page of the created Purchase Order.

### iSupplier Portal Integration

- With the Pricing Transparency functionality, the buyer can change the price by

adding modifiers to both GBPA and PO.

- Whenever a PO or GBPA is created the Supplier can see the PO and GBPA in iSupplier Portal.
- When the supplier changes the Price for the PO or GBPA, a change order is created and a notification is sent to the supplier with the price change details.
- When the buyer approves the change order, the change order will be implemented over the PO or GBPA with the changed price.
- In the above process, the PO or GBPA has a modifier applied to it, the supplier changes the price and change gets reflected in the purchasing document. This change is treated as a manual change by the buyer and the buyer will not be able to use the Pricing transparency functionality for the PO line (View Price structure option at the PO actions) once the manual change from the supplier is entered by the buyer using change order.



---

## Processes

### Accrual Load

This program is used in the accrual reconciliation process to populate the accrual reconciliation table with all the necessary transaction data. Running this program is normally the first step in that reconciliation process. See: Accrual Write-Offs, .

After you have entered your receipt transactions, matched and approved your accounts payable invoices, you will need to run the accounting process that creates the accounting for these transactions in the final mode and subsequently transfer these transactions to the general ledger. You can then begin the accrual reconciliation process by running the Accrual Reconciliation Load program. This program is used to populate the accrual reconciliation table with all the necessary transaction data for you to perform the reconciliation process. The program can be run for an operating unit incrementally.

The program parameters, from date and to date, can be used to run the load incrementally. These two dates represent the transaction dates that are used to fetch the transaction information from the transaction tables. All the affected PO distributions (in the case of AP/PO transactions and individual transactions in the case of miscellaneous transactions) will be deleted first and the transaction information for these distributions will be fetched and loaded into the accrual reconciliation tables. The data in the accrual reconciliation table will be regenerated only for the specified date range; the rest of the data will remain as is.

When the accrual load program is run for the first time for a given operating unit, old write off transactions for that operating unit (write offs from prior releases) are upgraded and loaded into the new accrual reconciliation tables. The "from date" for this very first run is ignored and the load runs from the start of transaction history to the current system date (or the "to date" provided by the user). Additionally, you cannot reverse write off transactions that were written off in prior releases.

## Prerequisites

Since this process loads transactions from purchase order receipts and accounts payable invoices, you must install Oracle Purchasing and Payables to run this report.

## Report Submission

In the Submit Requests window, select Accrual Reconciliation Load Run in the Name field.

## Parameters

### Operating Unit

Select the operating unit for which you want to load accrual data.

### Date From

This is the first date from which the data will be rebuilt. You can schedule this program to run on a repeated basis, which will automatically update the from and to date parameters. If the program is scheduled to run every month, then the from and to date parameters will be automatically updated to reflect the first and last date of that month.

### Date To

This is the last date from which the data will be rebuilt.

## Related Topics

Overview of Receipt Accounting, page 9-86

## ASL Upgrade Process

The ASL Upgrade process performs the same upgrade of AutoSource rules as AutoInstall, when you upgrade from Release 10.7. AutoSource rules in Release 10.7 and earlier have been replaced by enhanced sourcing rules and Approved Supplier List (ASL) entries in this release. Both AutoInstall and the ASL Upgrade process are designed to upgrade old AutoSource rules.

Run this process only if AutoInstall failed to upgrade your AutoSource rules automatically.

## Report Submission

In the Submit Requests window, select ASL Upgrade in the Name field.



## Report Parameters

### Supplier Status

Select a Supplier Status of *New*. This Supplier Status appears next to all of your suppliers in the Approved Supplier List window once the ASL Upgrade process upgrades your ASL entries. *New* is the only Supplier Status supported by the ASL Upgrade process.

### Upgrade Documents From

Select *Current and future rules*. This option upgrades source documents with current effectivity dates as well as effectivity dates that don't begin until the future. *Current and future rules* is the only option supported by the ASL Upgrade process.

## Related Topics

Submitting a Request, *Oracle Applications User's Guide*

*Oracle E-Business Suite Upgrade Manual*

## Confirm Receipts Workflow Select Orders Process

The Self-Service Purchasing Confirm Receipts Workflow Select Orders process in Purchasing must be running in order to use the Confirm Receipts workflow. The Confirm Receipts workflow sends notifications through the Web, e-mail, or Notification Details Web page (accessible through the Notifications Summary menu in Purchasing) to requestors or buyers who create requisitions in Purchasing or iProcurement. It lets people know they should have received an item.

The Confirm Receipts workflow sends notifications for items with a Destination or Deliver-To Type of Expense, a Routing of Direct Delivery, and a Need-By date that is equal to or later than today's date.

## Prerequisites

Submit the Workflow Background Engine before you submit the Confirm Receipts Workflow Select Orders process. In the Submit Requests window, in the System Administrator responsibility, select Workflow Background Engine in the Name field. See: To Schedule Background Engines, *Oracle Workflow Guide*.

## Submission

To submit the Confirm Receipts Workflow Select Orders process:

1. Navigate to the Submit Requests window and select Confirm Receipts Workflow

Select Orders in the Request Name field.

2. Choose Schedule.
3. Choose how often you want the process to run.

For example, choose Periodically if you want the process to run periodically. If you set it to run one or two times a day, the Confirm Receipts workflow will query for purchase orders that meet the criteria described above and send notifications (if required) one or two times a day.

4. Choose OK, or select other options and then choose OK.
5. Choose Submit to begin the process.

## Related Topics

Confirm Receipts Workflow, page E-184

Submitting a Request, *Oracle Applications User's Guide*

## Create Internal Sales Orders Process

Use the Create Internal Sales Orders process to send requisition information from approved, inventory-sourced requisition lines to the Order Management interface tables. Then the OrderImport process is run from within Order Management to generate the *internal* sales orders. You can set the Create Internal Sales Orders and OrderImport processes to run automatically at specified intervals.

The Create Internal Sales Orders process automatically schedules internal orders by setting the Schedule Ship Date on the order to the request date. If a subinventory is specified on the internal requisition line, Order Management reserves the goods and uses only the specified subinventory for allocation. If the goods do not exist at the specified subinventory, Order Management backorders them, even if they do exist in another subinventory.

The Create Internal Sales Orders process loads the Order Management open interface, OrderImport, using the order type you define in the Purchasing Options window. OrderImport creates internal sales orders from the records in the interface table, and determines the order cycle and defaults values based on the order type.

### **To run the Create Internal Sales Orders process:**

1. Navigate to the Submit Requests window.
2. Select Requests in the first field.
3. Select Create Internal Sales Orders in the Name field.

4. Choose Submit to begin the process.

## Related Topics

Creation of Internal Sales Orders, page 3-19

Submitting a Request, *Oracle Applications User's Guide*

Defining Internal Requisition Options, page 1-38

## Create Releases Process

Use the Create Releases process to create releases for requisition lines that meet the following criteria:

- Approved (and Reserved, if requisition encumbrance is active)
- Requisition is already sourced to an existing blanket purchase agreement (not a global agreement)
- Item is populated on the requisition line (one-time items not released)
- The Approved Supplier List entry for the item, supplier, and blanket indicate that the Release Generation method is either Automatic Release or Automatic Release/Review
- The requisition line is *not* already on a purchase order
- The source blanket is still active and the release will not put the blanket over the amount limit.

If the release generation method is Automatic Release, the process sets the status to Approved.

You can set the Create Releases process to run automatically at specified intervals.

### **To run the Create Releases process:**

1. Navigate to the Submit Requests window.
2. Select Requests in the first field.
3. Select Create Releases in the Name field.
4. Choose Submit to begin the process.

## Related Topics

Submitting a Request, *Oracle Applications User's Guide*

## Fill Employee Hierarchy Process

Use the Fill Employee Hierarchy process to create a direct mapping between the defined position hierarchies and the employees holding positions in each hierarchy. When you run this process, it checks each position hierarchy and updates each employee, his supervisor, the level of supervision (a direct supervisor is level 1), the employee's position, and the supervisor's position.

The process creates an error log which lists all positions to which no employee is assigned, but having such positions is a benign error that does not hamper system operation.

If you do *not* use hierarchical security for any of your documents and do *not* use position hierarchies for your approvals, you do not need to run this process. Otherwise, you must run this process before any of the following changes can take effect:

- add or delete an employee
- change an employee name or an employee position. See: Enter Person, *Oracle HRMS Enterprise and Workforce Management Guide*.
- add, delete, or modify a position. See: Representing Jobs and Positions, .
- add, delete, or modify a position hierarchy. See: Representing Jobs and Positions, *Oracle HRMS Enterprise and Workforce Management Guide*.

### To run the Fill Employee Hierarchy process:

1. Navigate to the Submit Requests window.
2. Select Requests in the first field.
3. Select Fill Employee Hierarchy in the Name field.
4. Choose Submit to begin the process.

## Related Topics

Submitting a Request, *Oracle Applications User's Guide*

## Generate Sourcing Rules And ASLs From Blanket Agreements

This program automatically creates or updates Sourcing Rules and ASLs (Approved Supplier List) for a blanket purchase agreement. The program acts upon documents which have the archival option set to Archive on Approve.

### Features:

- Can specify the default assignment set and the blanket agreement, supplier and supplier site for which the sourcing rules or ASLs need to be created or updated.
- Create global or local sourcing rules and ASLs:
  - Global: Create a sourcing rule that is enabled in all organizations and is assigned at the item level. Create a global ASL.
  - Local: Create a sourcing rule that is specific to the inventory organization selected. Create a Local ASL and associate the blanket agreement to the specific inventory organization.
- Create or update sourcing rules or ASLs for all lines or for new lines (entered since the previous archive) only.

**Exceptions:**

The program inserts all Blanket Lines for which a Sourcing Rule or ASL was not created into the Purchasing Document Interface Errors table, with the appropriate reason. This enables the buyer to identify and fix the errors if required before resubmitting the program. The buyer can submit the Purchasing Document Interface Errors Report for source type of PO\_DOCS\_OPEN\_INTERFACE to view the errors.

## Process Submission

Navigate to the Submit Requests window and select Document Sourcing Rules Creation Process in the Name field.

## Process Parameters

### Supplier

Select an active supplier who has at least one valid purchasing site in the current operating unit.

### Blanket Agreement Number

Select a blanket purchase agreement for the selected supplier that is approved and is not cancelled, closed, finally closed, frozen or on hold. Global agreements must be owned by the current operating unit or the current operating unit must be the procuring organization.

### Purchasing Organization

If you selected a global blanket agreement, select an organization listed as Purchasing Organization on the agreement.

**Select Blanket Lines**

Select either: All Lines or New Lines.

**Supplier Site**

Select a Purchasing Site for the global blanket agreement.

**Assignment Set**

Select an Assignment Set.

**Sourcing Level**

Select either: Item or Item-Organization.

**Inventory Organization**

If you selected a Sourcing Level of Item-Organization, select an Inventory Organization.

**Sourcing Rule Name**

Enter a name to update the sourcing rule name or for the given supplier, supplier site and item combination.

**Release Generation Method**

Select one of: Automatic Release/Review, Automatic Release, or Release Using Autocreate.

**Related Topics**

Overview of Approved Supplier List,

Submitting a Request, *Oracle Applications User's Guide*

**Import Price Catalog**

The Import Price Catalogs process imports price/sales catalog information and responses to requests for quotation (RFQs) electronically from suppliers in the form of blanket purchase agreements or catalog quotations. There are several ways you can import agreements and quotations into Oracle Purchasing.

Use the e-Commerce Gateway to import the electronic catalog information into the Purchasing Documents Open Interface. The Import Price Catalogs program then validates the information before importing it into Purchasing. When using the e-Commerce Gateway (EDI 832 or EDI 843 transactions) you have the option of running the Import Price Catalogs program either from within the gateway by choosing Import

Programs from the menu, and entering the parameters or running the Import Price Catalogs program from Oracle Purchasing.

The other way to import agreements and quotations is to use a custom program to import the electronic catalog information into the Purchasing Documents Open Interface and then run the Import Price Catalogs program from Oracle Purchasing.

## **Submission**

In the Submit Requests window, select Import Price Catalogs in the Name field.

## **Parameters**

### **Default Buyer (Required)**

Enter the default buyer name to be associated with the incoming documents.

### **Document Type (Required)**

Valid options are Blanket and Quotation. The option of Blanket directs Purchasing to create a blanket agreement from the price/sales catalog or quotation to be imported. The option of Quotation directs Purchasing to create a catalog quotation for the information to be imported.

### **Document Sub Type (Optional)**

Used with document type of Quotation to indicate a document sub type of Catalog for Response to RFQ to be imported. The document sub type of Bid Quotation is invalid for the transaction.

### **Create or Update Item (Required)**

Used with the Price/Sales Catalog or Response to RFQ to indicate whether to update the item master with catalog item changes or add catalog items to the item master.

### **Create Sourcing Rules (Required)**

Indicate Yes or No on whether supplier sourcing rules should be created automatically during the Price/Sales Catalog and Response to RFQ import process. Yes means that Purchasing creates sourcing rules and Approved Supplier List entries from the supplier, item, and document information that the supplier sends.

If you choose Yes, make sure the Approval Status field for the submitted documents is Approved. Sourcing rules can be created only when the Purchasing documents have a status of Approved.

### **Approval Status (Required)**

Enter desired status of Approved or Incomplete for the Blanket Agreements and

Quotations to be created.

The following table shows the effects of the Approval Status you choose here on an agreement's or quotation's current status, when you import an Update price/sales catalog.

Current Document Status	Import as Incomplete	Import as Approved
Incomplete	Document remains Incomplete	Document changes to Approved
Approved	Document remains Approved	Document remains Approved

### Release Generation Method (Optional)

Used when Document Type is set to Blanket and Create Sourcing Rules is set to Yes. Select from the following three blanket release methods:

Automatic Release/Review: Purchasing automatically generates releases and forwards them for approval.

Release Using AutoCreate: Enables you to use AutoCreate to convert purchase requisitions into blanket releases for blanket purchase orders.

Automatic Release: Purchasing automatically generates approved blanket releases for items that are sourced to a single supplier.

### Batch ID (Optional)

Enter a valid batch ID, that is a unique identifier for the group of documents in this submission. If you don't enter a Batch ID, one is generated for you when the process runs.

### Global (Optional)

Enter Yes here to indicate that you wish to create global agreements from the blanket agreements that you are importing.

### Related Topics

Receiving Price/Sales Catalog Information Electronically, page 5-18

Running the EDI Price/Sales Catalog Inbound Program, *Oracle e-Commerce Gateway User's Guide*

Running the EDI Response to Request for Quotation Inbound Program, *Oracle e-Commerce Gateway User's Guide*

Submitting a Request, *Oracle Applications User's Guide*



## Import Standard Purchase Orders

The Import Standard Purchase Orders program enables you to import standard purchase orders from legacy systems into Oracle Purchasing. Oracle Purchasing provides an open interface that validates the purchase order information, and then the Import Standard Purchase Orders concurrent program imports it into Purchasing.

To use this feature, you must first use a custom import program to load the data into the interface tables. Once the data is loaded, the Import Standard Purchase Orders program is run from within Oracle Purchasing to validate and create standard purchase orders.

The PO Approval workflow can be initiated automatically from the Import Standard Purchase Orders concurrent program. This eliminates the need to individually query each imported purchase order and submit it for approval. Additionally, Oracle Purchasing supports importing standard purchase orders of an approved status from legacy systems. This eliminates the need for any further approval processing for imported standard purchase orders.

### Submission

In the Submit Requests window, select Import Standard Purchase Orders in the Name field.

### Parameters

#### Default Buyer (Optional)

Enter the default buyer name to be associated with the incoming documents that are not assigned to a buyer..

If a default buyer is not specified and the imported purchase order also does not have buyer information, the program will use the normal Purchasing defaulting mechanism to generate buyer information. If the buyer name provided in the interface is not valid, then the record will error out and the default buyer name will not be supplemented.

#### Create or Update Item (Required)

The valid response is Yes or No. If Yes, the program will also create items in the item master from those buyer part numbers in the interface data where there is no corresponding item master entry. If No, the program will not create new item master entries.

#### Approval Status (Required)

For purchase orders, you must choose either Approved, Incomplete, or Initiate Approval. The impact of this parameter on the import logic is explained in the table

below:

---

Document Status in Interface Table	Concurrent Program Approval Status Parameter	Resulting Document Status
Null	INCOMPLETE	INCOMPLETE
Null	APPROVED	APPROVED
Null	INITIATE APPROVAL	INITIATE APPROVAL
INCOMPLETE	INCOMPLETE	INCOMPLETE
INCOMPLETE	APPROVED	INCOMPLETE
INCOMPLETE	INITIATE APPROVAL	INITIATE APPROVAL
APPROVED	INCOMPLETE	APPROVED
APPROVED	APPROVED	APPROVED
APPROVED	INITIATE APPROVAL	APPROVED

---

You can import Standard purchase orders with an INCOMPLETE status and then automatically initiate the PO Approval Workflow for these imported documents. Specifying a status of Incomplete or leaving the status Null in the interface data, and specifying a value of Initiate Approval for the Approval Status runtime parameter can achieve this.

Standard purchase orders can also be imported with an APPROVED status. Specifying a status of Approved in the interface data or leaving the status Null in the interface data, and specifying a value of Approved for the Approval Status runtime parameter can achieve this. The PO Approval Workflow is not initiated.

### Batch ID (Optional)

Enter a valid batch ID, that is a unique identifier for the group of documents in this submission. If you don't enter a Batch ID, one is generated for you when the process runs.

### Related Topics

Submitting a Request, *Oracle Applications User's Guide*

## Mass Update of Purchasing Documents

This program has been designed to streamline the process of maintaining organizational changes. You may have to change the person name (buyer, approver, deliver-to) on existing purchasing documents. The Mass Update of Purchasing Documents program updates person information on Oracle Purchasing documents from a previous (old) person to a new person.

The following Purchasing documents will be updated:

- Standard Purchase Order
- Blanket Purchase Agreements
- Blanket Releases
- Planned Purchase Orders
- Planned Releases
- Contract Agreements

You can run the Mass Update of Purchasing Documents program from within Purchasing. Documents will remain in the same status after the person name update. Document revision and archival will not take place.

Mass updates can be done for documents with the following statuses: Approved, Requires Approval, Pre-Approved, Incomplete, Rejected, and In-Process. You cannot perform mass update for documents with a status of Cancelled, Finally Closed, Closed POs and Frozen POs.

A report is produced as output from the concurrent program. This report lists the document number and document type of the Oracle Purchasing documents that were updated by the program.

### Submission

In the Submit Requests window, select Mass Update of Purchasing Documents in the Name field.

### Parameters

#### Update Person (Required)

Select from All, Approver, Buyer, Deliver To.

**Old Person (Required)**

Enter or select the person name that needs to be changed. This must be a person name that is currently in the system (active or inactive).

**New Person (Required)**

Enter or select the person name that is to be updated on all the documents that match the old person. This will show all the current persons except the one entered as the old person.

**Document Type (Optional)**

Select one of the following document types: All, Blanket Purchase Agreement, Contract Purchase Agreement, Planned Purchase Order, Standard Purchase Order. If Blanket Purchase Agreement is selected, then the updates are applicable for all the releases associated to the Blanket Purchase Agreement.

**Document Number From and Document Number To (Optional)**

Enter the range of the document numbers for the documents that you want updated.

**Date From and Date To (Optional)**

Enter the date range for which you want the documents to be updated.

**Vendor Name (Optional)**

Enter the Vendor (Supplier) Name. If this field is left blank, then the person name is updated for all suppliers.

**Include Close PO (Optional)**

Enter Yes or No, depending on whether you want to include closed Purchase Orders or Requisitions in the mass update.

**Commit Interval (Optional)**

Specify how many records should be updated before they are committed.

**Note:** This program is not intended to update action history or archive the information it is expected to change.

**Related Topics**

Submitting a Request, *Oracle Applications User's Guide*

## Mass Update of Requisitions

You can perform mass update of purchase requisitions for Purchase Requisitions or Internal Requisitions that have the following statuses: Approved, Requires Approval, Pre-Approved, Incomplete, Rejected and In Process. You cannot perform mass updates of requisitions that have a status Cancelled.

A report is produced as output from the concurrent program. This report lists the document number and document type of the Oracle Purchasing documents that were updated by the program.

The parameters for the Mass Update of Requisitions are:

### Update Person

Select from the following persons in the dropdown LOV: All, Approver, Preparer, Requester.

### Old Person (Required)

Enter or select the person name that needs to be changed. This must be a person name that is currently in the system (active or inactive).

### New Person (Required)

Enter or select the person name that is to be updated on all the documents that match the old person. This will show all the current persons except the one entered as the old person.

### Document Type

Select one of the following document types: All, Blanket Purchase Agreement, Contract Purchase Agreement, Planned Purchase Order, Standard Purchase Order. If Blanket Purchase Agreement is selected, then the updates are applicable for all the releases associated to the Blanket Purchase Agreement.

### Document Number From and To

Enter the range of the document numbers for the documents that you want updated.

### Date From and Date To

Enter the date range for which you want the documents to be updated.

## Commit Interval

Specify how many records should be updated before they are committed.

## Mass Close of Purchasing Documents

The Mass Close of Purchasing Documents concurrent program enables you to change the status of purchase orders to Closed. This is applicable to purchase orders that have been fully processed but which do not have a status of Closed. When you run the concurrent program, the purchase orders are mass closed completely (this includes headers, lines, shipments).

You can mass close purchase orders with the following statuses: Frozen, On Hold, Approved, Reserved, Requires Reapproval, Closed for Invoicing and Closed for Receiving.

You can mass close the following documents: Standard Purchase Orders, Blanket Purchase Agreements, Planned Purchase Orders and Contract Agreement and Blanket Releases. The parameters for running the concurrent programme are Document Type, Document number, Date range and Supplier Name.

A report is produced as output from the concurrent program. This report lists the document number and document type of the Oracle Purchasing documents that were updated by the program.

## Payment on Receipt

Payment on Receipt enables you to automatically create standard, unapproved invoices for payment of goods based on receipt transactions. Invoices are created using a combination of receipt and purchase order information, eliminating duplicate manual data entry and ensuring accurate and timely data processing. Payment on Receipt is also known as Evaluated Receipt Settlement (ERS) and Self Billing.

You can automatically create invoices with multiple items and distribution lines, and include tax.

You define which supplier sites participate in Payment on Receipt and enforce matching rules to ensure the proper payments are made to the suppliers.

Payment on Receipt builds invoices with the following information:

<b>Amount</b>	Determined by multiplying the Quantity received by the Purchase Order Item Unit Price.
<b>Payment Terms</b>	Defaulted from the purchase order payment terms or from the supplier site payment terms, depending on your Oracle Payables setup.

**Tax** Based on Tax Codes on each purchase order shipment, or the default tax hierarchy in Payables.

If the purchase order currency and the supplier site Payment Currency (in the Supplier Sites window) are not fixed-rate currencies (for example, not euro-related currencies), Payment on Receipt builds the invoices this way, regardless of the supplier site Invoice Currency:

**Invoice Currency** Defaulted from the purchase order Currency.

**Payment Currency** Defaulted from the purchase order Currency.

If the purchase order currency and the supplier site Payment Currency are fixed-rate currencies (for example, euro-related currencies), Payment on Receipt builds the invoices this way, regardless of the supplier site Invoice Currency:

**Invoice Currency** Defaulted from the purchase order Currency.

**Payment Currency** Defaulted from the supplier site Payment Currency. For example, if the purchase order Currency is francs and the supplier site Payment Currency is the euro, the Payment Currency on the invoice is the euro.

Defaulted from the supplier site Invoice Currency if no supplier site Payment Currency is defined and the supplier site Invoice Currency is a fixed-rate currency.

Defaulted from the purchase order Currency if the supplier site Invoice Currency is not a fixed-rate currency.

If the Alternate Pay Site is populated for the Supplier Site used on the Purchase Order, the invoice created is for the Alternate Pay Site, otherwise the Supplier Site on the Purchase Order is used. The Supplier Site used for the invoice must be defined as a Pay Site.

## Debit Memos

You can choose to automatically generate debit memos for Return To Supplier transactions once Payment on Receipt creates the invoice. To enable this functionality, enable the supplier site as a Pay Site (or indicate an Alternate Pay Site) and select Create Debit Memo from RTS Transaction in the Supplier Sites window. Once you enable this functionality, a debit memo is created for each return line you enter in the Returns window. When you create the return, make sure the Create Debit Memo option is selected in the Returns window. (The Aging Period profile option and field in Payment on Receipt do not account for returns for which a debit memo was already created, so that duplicate debits are not made. Likewise, a debit memo will not be created if the Aging Period functionality already handled the debit.) See: Debit Memos, page 9-14.

## Match Payment on Receipt Invoices to Purchase Orders or Receipts

When Payment on Receipt runs, it automatically performs invoice matching to the purchase order or receipt, depending on which Invoice Match Option was chosen in the purchase order Shipments window. (The Invoice Match Option on the shipment defaults from the Supplier Sites window, but you can change it on the shipment.) See: Entering Purchase Order Shipments, page 4-67.

If matching invoices to receipts, Payment on Receipt uses the exchange rate information on the receipt. If matching invoices to purchase orders, Payment on Receipt uses the exchange rate information on the purchase order.

## Enable Payment on Receipt for Individual Purchase Orders and Releases

You can enable Payment on Receipt for individual purchase orders and releases, for any purchase order or release type, by using the Pay On field in the Terms and Conditions window. (The Pay On value on a blanket purchase agreement is defaulted onto all the releases created against it.) The Pay On field defaults to Receipt for all documents whose supplier site is set up as a Payment on Receipt site in the Supplier Sites window, meaning that Payment on Receipt creates the invoices. Changing the Pay On field to Null means that Payment on Receipt does not create an invoice for that document, even if the supplier site is a Payment on Receipt site. If the supplier site is not a Payment on Receipt site, the Pay On field is disabled. See: Entering Purchase Order Detail Information, page 4-61.

The Pay On field also shows up on the Printed Purchase Orders Report, so your supplier knows that you will create an invoice upon receipt, and the supplier does not need to submit an invoice.

## Delay Payment on Receipt

You may want to allow time for corrections or returns against the receipts before using Payment on Receipt to automatically convert the receipts into invoices. The profile option *PO: ERS Aging Period* enables you to specify this delay period between the receipt date and the invoice creation date.

When you run Payment on Receipt, it processes only those receipts whose dates are past the aging period. Payment on Receipt invoices include the sum of all corrections or returns made against a receipt during that aging period. Any adjustments you make after that aging period, you must process manually-by adjusting the invoice itself, or creating a debit memo.

The aging period does not include returns for which debit memos have already been automatically created. See: Debit Memos, page 9-14.

### Example

Your aging period is two days. You receive 100 items on Monday, but on Tuesday discover that two items were missing from the shipment. You enter a correction to



adjust the amount received to 98. When run on Wednesday (or later), Payment on Receipt generates an invoice for 98 items.

See: Purchasing Profile Options, page C-1.

## Control Invoice Prefixes

You can find Payment on Receipt invoices by using the Find Invoices window in Oracle Payables to search for any invoice in your system containing the prefix 'ERS-.' However, you can change this prefix, using the profile option *PO: ERS Invoice Number Prefix*. For example, shortening this prefix allows extra spaces for longer packing slip or receipt numbers. See: Purchasing Profile Options, page C-1.

## Self-Billing Invoices

Self-billing invoices (SBI) is an automated invoicing process where the buying company creates an invoice on behalf of the supplier. Oracle Purchasing supports gapless invoice numbering for all self-billing invoice types including: payment on receipt, debit memos, and purchase price adjustment. See: Define Document Control Options, page 1-34.

## Create Invoices with Multiple Items and Multiple Distribution Lines

You can create a single invoice for one or more items on a single purchase order as long as the items have not been previously invoiced and matched to a purchase order or a receipt. If you are creating an invoice from the receipt transaction and purchase order, you are able to create an invoice for all ordered and received items. In the event of a partial shipment or multiple delivery dates, you are able to create multiple invoices for a single purchase order.

In addition, if your purchase order contains multiple distribution lines, you can create an invoice in Oracle Payables with the same multiple distribution lines.

When creating multiple distribution lines for invoices with partial receipt quantities, the Pay on Receipt AutoInvoice program will either prorate the charges across all your purchase order distribution lines (for the received item) or use the FIFO method if you utilize Cascading Receipts. After the invoice has been created, you are able to make changes to the invoice distribution in accordance with the current Oracle Payables system functionality.

## Enforce Match Approval Levels to Ensure Proper Payment

Invoices created automatically are subject to the same match approval levels as standard invoices to ensure proper payment. Two-, three- and four-way match approval levels are enforced by Oracle Payables if you specify two-, three-, or four-way for the supplier site Match Approval Level. Two-way match approval is the process of verifying that the purchase order and invoice information match within accepted tolerance levels. Three-way match approval is the process of verifying that the purchase order, invoice, and receiving information matches within accepted tolerance levels. The

three-way match approval level is available with the Receipt Required option.

Four-way match approval is the process of verifying that the purchase order, receipt, inspection, and invoice information matches within accepted tolerance levels. The four-way match approval level is available with the Inspection Required purchasing option.

Oracle Payables requires that you approve invoices before you create accounting entries for them or pay them. Approvals can be submitted for selected invoices in the Invoice Workbench or by batch process. All discrepancies and/or adjustments must be handled manually using the appropriate online Oracle Purchasing, Receiving, and/or Payables windows.

## **Create Invoices which Include Tax**

Payment on Receipt invoices include tax, which is based on each purchase order shipment and the setup in Oracle E-Business Tax. See: Tax Information in Purchasing, page 4-116.

Tax on Payment on Receipt invoices is not calculated until invoice approval in Oracle Payables, or until tax calculation is performed in the Invoice Distributions window in Oracle Payables.

## **Create Scheduled Payments**

Oracle Payables creates scheduled payments for each invoice based on the payment terms and the invoice terms date. After the invoice has been created, you can use the Scheduled Payments window to modify information such as due dates, and to change payment and discount amounts.

## **Define Payment on Receipt Supplier Information**

You can enter supplier information in the Suppliers and Supplier Sites windows to identify which of your suppliers are eligible for Payment on Receipt and can have their invoices automatically created using the Pay on Receipt AutoInvoice program. In addition, you can specify an alternate Payment on Receipt pay site if the supplier's pay site address is different from the purchasing address. For invoices created based on receipt transactions, you can set up invoice consolidation levels for an individual pay site. You also define the default Payment Currency in the Suppliers and Supplier Sites windows.

See: Defining Standard Suppliers, *Oracle iSupplier Portal Implementation Guide*.

## **Create Invoices with Different Invoice Summary Levels Based on the Supplier Site Setup**

The level of invoice consolidation determines how an invoice will be created for each run of Pay on Receipt AutoInvoice program. For invoices created based on receipt transactions, you set up invoice consolidation levels for an individual pay site in the

Supplier Sites window. The levels are:

**'Pay Site'** -- one invoice is created per supplier pay site for all the transactions that have the same transaction date.

**'Packing Slip'** -- one invoice is created per packing slip per supplier pay site for all the transactions that have the same transaction date.

**'Receipt'** -- one invoice is created per receipt per supplier pay site.

Invoice numbers are created based on the summary level. The invoice number is of the following format:

**'ERS'< X >< Seq# >**

where:

- ERS is the default prefix for Pay On Receipt invoices or any prefix you specify in the profile option *PO: ERS Invoice Number Prefix*. See: Profile Options in Purchasing, page C-1.

- Seq# is a unique system generated number.

- X depends on the summary level:

- if summary level = Pay Site then X = Invoice Date

- if summary level = Packing Slip then X = Packing Slip Number

- if summary level = Receipt then X = Receipt Number

If gapless self-billing invoice (SBI) numbering is enabled, the SBI buying company identifier and selling company identifier are included in the invoice number following the prefix as shown below. See: Self-Billing Invoices, page 13-19.

<Prefix><SBI Buying Company Identifier><Selling Company Identifier><Invoice Type Code><Seq #>

## Submit Pay on Receipt AutoInvoice Program

The Pay on Receipt AutoInvoice program automatically creates an invoice batch depending on the options in the Payables Options window. Invoice count and invoice total are calculated automatically.

### Prerequisites:

- The supplier and supplier site must be set up correctly. Specifically, the supplier site must be set up as a Pay on Receipt site.

**Important:** Check that the receipts that you are interested in have been created successfully before running this program. You can do this by locating the receipt in the Receiving Transactions Summary window.

See: Defining Standard Suppliers, *Oracle iSupplier Portal Implementation Guide*

- Enter an Invoice Currency and a Payment Currency in the Supplier Sites window.
- If you need to calculate tax on the invoices, enable Automatic Tax Calculation and set the Calculation Level to Line or Tax Code in the Supplier Sites window.
- If the profile option *Sequential Numbering* is set to Partially Used or Always Used, ensure that document sequences have been defined for your invoices and have been set to automatic numbering. Otherwise, Payment on Receipt may not be able to complete because it cannot generate document numbers for the invoices. See: Common User Profile Options, *Oracle Applications User's Guide*. See: Voucher Numbers, *Oracle Payables User's Guide*.

**To run Payment on Receipt:**

1. Navigate to the Submit Requests window.
2. Choose Requests as the Type.
3. Choose **Pay on Receipt AutoInvoice** as the Name.
4. Choose the Transaction Source **ERS**.
5. Enter a Commit Interval. The Commit Interval is a numeric representation of the number of invoices evaluated before they are committed. For example, if you have a Commit Interval of 10, after 10 invoices have been processed, they are committed. If you then process another 5, and the process fails, only 5 will not be committed.
6. Optionally enter a Receipt Number.

**Note:** If the Receipt Number is null, the program will try to process all the receipts that have not been invoiced successfully. If you enter a Receipt Number, *only* that receipt will be processed.

7. Optionally enter an Aging Period.  
The Aging Period defaults from the *PO: ERS Aging Period* profile option, but you can change it here. For example, an Aging Period of 2 means that Payment on Receipt processes only those receipts that are 2 or more days old.
8. Choose OK and then Submit Request to begin the process.
9. Make sure the Payment on Receipt process and the Payables Open Interface Import process complete successfully.

After this process completes, it calls the Payables Open Interface Import process to complete invoice creation. Therefore, note the following in the View Output screen for the Pay on Receipt process:

10. The Request ID for the Payables Open Interface Import process. Use this ID to check the status of the Payables Open Interface Import process to be sure it also completes successfully. If not, fix the errors in the Open Interface Invoices window and resubmit the Payables Open Interface Import process. See: Payables Open Interface Import, *Oracle Payables User's Guide*. See: Open Interface Invoices Window, *Oracle Payables User's Guide*.
11. The Group ID for the invoice batch number. If you need to query this invoice batch to fix errors, use the Group ID to query this invoice batch.

## PO Output for Communication

The PO Output for Communication process creates an Adobe Portable Document Format (PDF) of the purchase orders you specify. The PDF version of purchase orders are an electronically viewable format that you can share with your suppliers. Oracle Purchasing provides a default layout which can be customized. See: Printed Purchase Order Overview, page 8-3.

### Submission

In the Submit Requests window, select PO Output for Communication in the Name field.

### Parameters

#### Print Selection

Select one of the following options:

<b>All</b>	Print the report for all purchase orders. This is the default for no entry.
<b>Changed</b>	Print the report only for changed purchase orders.
<b>New</b>	Print the report only for new purchase orders.

### Buyer Name

Select a buyer name to restrict the report to a specific buyer.

### Purchase Order Numbers From/To

To restrict the report to a range of purchase orders, select the beginning and ending numbers.

### Release Numbers From/To

To restrict the report to a range of releases, select the beginning and ending numbers.

### Release Dates From/To

To restrict the report to a release date range, enter the beginning and ending dates.

### Approved

Select Yes or No to indicate whether the report is restricted to approved purchase orders.

### Test

Select Yes or No to indicate whether the report is a test.

### Print Releases Option

Enter Y or N to indicate whether you want blanket and planned purchase order releases to be automatically reported with the blanket and purchase order agreements.

### Sort By

Select one of the following options:

**Buyer Name** Sort the report by buyer name and purchase order number.

**Purchase Order Number** Sort the report by purchase order number.

### Include Blanket

Enter Y or N to indicate whether you want backing blanket purchase orders printed with standard purchase orders.

### Related Topics

Submitting a Request, *Oracle Applications User's Guide*

Viewing Requests, *Oracle Applications User's Guide*

## Purchasing Database Administration

Use the Purchasing Database Administration process to initiate concurrent processes that *purge* obsolete records in Purchasing interface tables and other temporary tables. The purging of obsolete data helps reduce memory load and improve system performance. You need to run this process only once because the AutoSubmit process resubmits itself daily after you submit it the first time.

**To run the Purchasing Database Administration process:**

1. Navigate to the Submit Requests window.
2. Select Requests in the first field.
3. Select Purchasing Database Administration in the Name field.
4. Choose Submit Request.

## Related Topics

Submitting a Request, *Oracle Applications User's Guide*

Viewing and Responding to Notifications, page 2-29

## Purchasing Documents Open Interface

The Purchasing Documents Open Interface process has been replaced with two separate processes.

Import Price Catalogs, page 13-8

Import Standard Purchase Orders, page 13-11

## Receipt Accruals - Period-End Process

Use the Receipt Accruals - Period-End process to create period-end accruals for your uninvoiced receipts for Expense distributions. Purchasing creates an accrual journal entry in your general ledger for each expense distribution uninvoiced receipt you choose using this form. If you use encumbrance or budgetary control, Purchasing reverses your encumbrance entry when creating the corresponding accrual entry.

**Important:** When using Cash Basis Accounting, you should use the Purchasing Options window to set the Accrue Expense Items flag to Period End, but you will not normally run the Receipt Accrual - Period-End process. See: Defining Accrual Options, page 1-40.

Purchasing provides you with complete flexibility and control for your period-end accruals. You can use the Uninvoiced Receipts Report to analyze your uninvoiced receipts before you accrue them. You can then run the Receipt Accruals - Period-End process as many times as you want to generate accruals entries for the receipts (Vendor or Category) you choose. Purchasing does not accrue receipts for purchase orders on or before the last date of the Accrual Period.

You create accruals for a specific purchasing period. Purchasing automatically accrues all uninvoiced receipts you entered up to the end of the accrual period you specify. Each time you run the Receipt Accruals - Period-End process, Purchasing creates a

batch in receiving subledger. It also creates accounting events in SLA. If you are using encumbrance, Purchasing creates another set of accounting events in SLA. Purchasing creates an unposted journal entries batch in your general ledger for your receipt accruals. If you are using encumbrance or budgetary control, Purchasing creates another journal entries batch in your general ledger corresponding to the encumbrance reversal entries for the uninvoiced receipts you accrued.

Each time you create accrual entries for a specific purchase order, Purchasing marks this purchase order as accrued and ignores it the next time you run the Receipt Accrual - Period-End process. Purchasing creates accrual entries only up to the quantity the supplier did not invoice for partially invoiced receipts.

Follow the steps listed below:

- Identify the purchasing period for your receipt accrual entries. Purchasing creates receipt accruals for all receipts you entered up to the end of this period. To prevent any period-end disruption, Purchasing lets you provide a receipt date that is different from the date you enter the receipts. You never have to enter all the receipts for a period before the end of this period. You can enter these receipts later. You simply need to backdate the receipt date. Of course, you should make sure you entered all receipts for a specific period before you create receipt accruals for that period.

If you perform additional receiving activity to an item after a period is closed-for example, you return an item received in a previous period and re-receive it using a date in the current period-encumbrance and accrual entries for the item are made for the current, open period.

- Enter and match all invoices you received during the period for your receipt accrual entries.
- Close the accounts payable period corresponding to the purchasing period for your receipts accrual entries.
- Run the Uninvoiced Receipts Report and analyze your uninvoiced receipts that are accrued at period end.
- Run the Receipt Accrual - Period-End process as many times as you need. You can use the search criteria to choose what you want to accrue and accrue your receipts step by step. This process creates accounting accrual entries using the journal source 'Purchasing' and the journal category 'Accrual' in Receiving subledger.
- Run Create Accounting – Cost Management for process category Receiving to create accounting in SLA.

**Note:** If you are using encumbrance then you don't need to run the Create Accounting – Cost Management as Receipt Accruals – Period-End creates the accounting in SLA automatically.



- Run Journal Import in General Ledger to import the receipt accruals journals from General Ledger into Purchasing. See: Importing Journals, *Oracle General User's Guide*.
- Transfer to general ledger from SLA using Transfer Journal Entries to GL - Cost Management for Process Category Receiving. You can provide the general ledger batch name while transferring to general ledger.
- Post Accrual and Encumbrance Reversal journal entry batches in your general ledger.
- Perform all the steps you need to close your accounting period and generate period-end reports and financial statements in your general ledger.
- Run the Accrual Reconciliation Report after period close to analyze your receipts accrued on receipt.
- Use your general ledger system to reverse all the receipt accrual and encumbrance reversal batches for your period-end accruals.
- Close the purchasing period for your receipt accruals. When you close a purchasing period, Purchasing automatically un-marks all the receipts you previously accrued to make sure you can accrue these receipts again if they are still uninvoiced in the next period.
- Make sure the Close Purchasing Periods process completes before you open the next period. When you close a period in the Open and Close Periods window and then save, the Close Purchasing Periods process runs automatically. Make sure this process completes before opening the next period.
- After you have opened your next period in General Ledger and have either closed the previous general ledger period or have completed all previous month receipt accruals, you can reverse the previous month's receipt accruals in the new month. You perform this by reversing each general ledger journal batch in General Ledger.

Run Complete Multiperiod accounting which automatically reverses the accrual entries on the first day of next period.

**To run the Receipt Accruals - Period End process:**

1. Navigate to the Submit Requests window.
2. Select Requests in the first field.
3. Select Receipt Accruals - Period-End in the Name field.
4. Enter the Minimum Accrual Amount.

For example, if you do not want to accrue amounts less than \$.10, enter .10. In this

example, an accrual of .09 or less will not be created. Any accrual amount of .10 or greater will still be accrued. The default minimum accrual amount is 0, meaning all amounts are accrued.

5. Enter the Supplier to restrict period-end receipt accruals to a single supplier.
6. Enter the item Category to restrict period-end receipt accruals to a single category.
7. Enter the Period for which you want to perform period-end receipt accruals. Purchasing automatically provides you with a list of acceptable accrual periods. This list contains periods that you closed in your accounts payable system and either opened or did not use in your general ledger system.
8. Choose Submit to begin the process.

## Related Topics

Submitting a Request, *Oracle Applications User's Guide*

## Receiving Transaction Processor

Use the Receiving Transaction Processor to process your pending or unprocessed receiving transactions. How the Receiving Transaction Processor handles these transactions depends on the processing mode, which is a profile option that you can set at the site, application, responsibility, and user levels.

In On-line processing mode, Purchasing calls the Receiving Transaction Processor when you save your work.

In Immediate processing mode, when you save your work, the receiving forms call the Receiving Transaction Processor for the group of transactions you have entered since you *last* saved your work. Note that this is a specific group of transactions. Transactions belonging to other groups (for example, those entered by another user in Batch processing mode) are not included.

In Batch processing mode, the receiving forms insert transaction information into the receiving interface tables. These transactions remain in the interface table until you run the Receiving Transaction Processor. The receiving forms take into account all pending transactions, but Purchasing does not update the transaction history, source documents, and supply information until the transactions are processed.

You can set Standard Report Submission parameters to run the Receiving Transaction Processor at specified intervals so that your pending transactions are processed as often as required.

The Receiving Transaction Processor performs the following functions:

- validates Advance Shipment Notice (ASN) and Advance Shipment and Billing and

Notice (ASBN) information in the receiving open interface

- derives and defaults values into the receiving interface tables (For example, if a particular value or field is not received, the receiving open interface tries to derive the value using defaulting and derivation rules.)
- creates receipt headers for intransit shipments
- creates receipt lines for all receipts
- maintains transaction history information
- maintains lot and serial transaction history
- accrues uninvoiced receipt liabilities
- maintains the following purchase order quantities: quantity received, quantity delivered, quantity accepted, and quantity rejected
- closes purchase orders for receiving
- maintains the following requisition quantities: quantity received, quantity delivered
- maintains supply information
- maintains inventory information (for Inventory destination type)
- maintains outside processing information (for Shop Floor destination type)

**To run the Receiving Transaction Processor:**

1. Navigate to the Submit Requests window.
2. Select Requests in the first field.
3. Select Receiving Transaction Processor in the Name field.
4. Choose Submit to begin the process.

## Related Topics

Profile Options in Purchasing, page C-1

Submitting a Request, *Oracle Applications User's Guide*

## Requisition Import Process

Use the Requisition Import process to import requisitions from other Oracle or non-Oracle systems. Work in Process, Master Scheduling/MRP, Order Management,

and Inventory (as well as custom systems) can provide requisition information for the Purchasing requisition interface table. For example, drop-ship orders from Order Management and Kanban orders from Inventory are sent to the requisition interface table and converted into requisitions. Also, project and task information from Master Scheduling/MRP are imported through the Requisition Import process. Requisition Import creates a requisition line and one or more requisition distributions for each row it finds in the interface table. It then groups these lines on requisitions according to parameters you define below.

You can set the profile PO: Release During ReqImport to create releases each time you run the Requisition Import process. For example, when you implement planned orders as requisitions in the MRP Planner Workbench, you can automatically create the releases at the same time you create the requisitions. Purchasing automatically creates (and optionally approves) the releases for *all* blanket-sourced, approved requisitions as part of the Requisition Import process, not just those created by the Requisition Import run.

You can place requisitions you imported on purchase orders just as you would any other requisition. Purchasing automatically sources your requisition line to a blanket agreement or catalog quotation number if the supplier for the item is in the Approved Supplier List and if sourcing rules are set up for the item.

## Requisition Import Approvals

Each requisition you create using Requisition Import enters Purchasing with the approval status that was specified when the row in the interface table was created. However, if you are using requisition encumbrance (the Use Requisition Encumbrance field in the Encumbrance Information region of the Financials Options window is set to Yes), Requisition Import changes the Approved status to Pre-Approved, and you must approve the requisitions.

**Note:** A Pre-Approved requisition does not show up as supply until its status changes to Approved. See: Approved Documents and Supply, page 2-21.

For Incomplete and Pre-Approved requisitions, Requisition Import calls the PO Requisition Approval workflow to submit the requisitions to the approval process unless you specify not to when you submit Requisition Import. For Approved requisitions, Requisition Import calls the PO Create Documents workflow in Purchasing to automatically create corresponding purchase orders, and the PO Create Documents workflow then calls the PO Approval workflow to approve the purchase orders, if you've enabled automatic creation and approval. See: Choosing Document Creation Options, page 1-85.

## Submission

When you submit the Requisition Import process, Purchasing automatically prints the

Requisition Import Run Report. You can view this report by using the View Requests window and choosing the Report option in the View field for the Requisition Import process you submitted. If there were no records in the transaction interface table, the report has two lines:

- No records were processed
- Number of records in error = 0

Otherwise, the report normally has three lines:

- Number of approved requisitions created = n
- Number of unapproved requisitions created = n
- Number of records in error = n

When there are transaction records that cannot be processed, the report includes a fourth line:

- Number of records pending = n.

## Parameters

1. Enter the Import Source. Leave this field blank for all import sources.  
If you do not see a particular import source in the list of values, there are currently no requisitions from that source.
2. Enter the Import Batch Identification for the batch that you want to import. Leave this field blank to import all batches.
3. Use the Group By feature to determine how requisition lines are grouped on the requisitions you create. The default in this field is set in the Purchasing Options window. Choose one of the following options:
  - *All*: Group all requisition lines on one requisition
  - *Buyer*: Group requisition lines for each buyer name on a separate requisition
  - *Category*: Group requisition lines for each purchasing category on a separate requisition
  - *Item*: Group requisition lines for each item on a separate requisition
  - *Location*: Group requisition lines for each location on a separate requisition
  - *Supplier*: Group requisition lines for each supplier name on a separate requisition

4. Enter the Last Requisition Number that exists in your system. Purchasing increments this number by one to calculate the next requisition number. If the calculated number is already in use, Purchasing selects the next available requisition number. Leave this field blank to automatically get the next available requisition number.
5. Choose No for Multiple Distributions.  

In a previous release, the Import Source of ICX (for Web Requisitions) required you to choose Yes. This release supports iProcurement, which saves its requisitions directly to the Purchasing tables rather than using Requisition Import. Therefore, Yes is no longer a valid option for Multiple Distributions.
6. Choose whether to initiate approval automatically for the requisitions after they are imported.  

*Yes:* The PO Requisition Approval workflow is launched automatically for requisitions imported with a status of Pre-Approved or Incomplete.

*No:* The PO Requisition Approval workflow is not automatically launched for Pre-Approved or Incomplete requisitions. You can submit these to the approval process later, when you select the Approve button on the requisition.
7. Choose Submit to begin the process.

## Related Topics

- Profile Options in Purchasing, page C-1
- Defining Purchasing Options, page 1-33
- Automatic Release Generation, page 4-96
- Submitting a Request, *Oracle Applications User's Guide*
- Viewing Requests, *Oracle Applications User's Guide*
- Automatic Sourcing, page 5-24
- Drop Shipments, page 4-114
- Demand for Internal Requisitions, page 3-16
- Workflow for Creating Purchase Orders and Releases, page E-161
- Purchase Order Approval Workflow, page E-89
- Requisition Approval Workflow, page E-50

## Reset Period End Accrual Flags

The Reset Period End Accrual Flags program resets the accrued flag on purchase order distributions preparing them for the next run of the Period End Accrual process. This

program can be run for specific operating units to reset their accrued flags.

The Reset Period End Accrual Flags program is to be used by organizations that have a multi-org setup. The Close Purchasing Period program only updates the accrued flag for the operating unit it is run in. With the Reset Period End Accrual Flags program you can update the accrued flag for the other operating units within the organization.

For organizations using a single operating unit, the Close Purchasing Period program itself resets the accrued flag and would be the only program you need to run.

## Submission

In the Submit Requests window, select Reset Period End Accrual Flags in the Name field.

## Parameters

None.

## Related Topics

Submitting a Request, *Oracle Applications User's Guide*

## Reschedule Requisitions Process

Use the Reschedule Requisitions process to *update* requisition information for the rows that Master Scheduling/MRP has inserted into the rescheduling interface table. This information can include changes to need-by dates recommended by MRP as well as changes to requisition quantities made by means of the Planner's Workbench.

### To run the Reschedule Requisition process:

1. Navigate to the Submit Requests window.
2. Select Requests in the Type field.
3. Select Reschedule Requisitions in the Name field.
4. Choose Submit to begin the process.

## Related Topics

Submitting a Request, *Oracle Applications User's Guide*

Overview of Implementing Planning Recommendations, *Oracle Master Scheduling/MRP and Supply Chain Planning User's Guide*

## Retrieve Time from Oracle Time and Labor (OTL)

If Oracle Services Procurement is implemented and contract workers enter their time through Oracle Time and Labor, use this process to generate receipts for the recorded time. You can complete the procure-to-pay flow by running the Pay on Receipt process.

This process loads the time transactions into the Receiving Open Interface and then the Receiving Transaction Processor is automatically launched to import the receipts.

### Submission

In the Submit Requests window, select Retrieve Time from OTL in the Name field.

### Parameters

### Related Topics

Submitting a Request, *Oracle Applications User's Guide*

## Retroactive Price Update on Purchasing Documents

Over the life of purchasing documents prices can change. The Retroactive Price Update on Purchasing Documents concurrent program automatically updates existing blanket releases and standard purchase orders retroactively with price changes from the parent blanket agreement or global purchase agreement. Other changes can include updates to price breaks quantities, ship-to organization or location, new price breaks, and deletion of existing price breaks.

#### Considerations:

- The Retroactive Price Update on Purchasing Documents concurrent program updates the prices of your purchase orders or releases based on the profile PO: Allow Retroactive Pricing.
- It does not update the prices if your purchase orders or releases have any encumbrances associated with them.
- It does not process documents associated with blanket agreement lines that are cumulatively priced.
- When buyers with edit access to global agreements execute this concurrent program, it updates documents in all enabled operating units.
- It only considers price updates from lines of blanket agreements that are currently in the following statuses:



- Approved
- Closed
- Blanket releases or standard purchase orders in the following document statuses are not considered for update:
  - In Process
  - Pre-Approved
  - Reserved
  - Frozen
  - Finally Closed
  - Canceled
- It updates following Oracle Purchasing documents:
  - Standard Purchase Orders against Global Agreements
  - Blanket Releases

The Retroactive Price Update on Purchasing Documents program uses your parameter values to retrieve blanket agreement lines that have undergone price changes (it ignores cumulatively priced lines) as well as the release shipments created against these lines. It then updates shipments with any new prices from the blanket agreement and update the timestamp information on release shipments with that of the blanket agreement line. For standard purchase orders against global agreements, the timestamp information is stored at the purchase order line level and is updated with that of the global agreement line. Purchasing documents that were in an approved status prior to the update can be automatically submitted for re-approval.

**Prerequisites:**

- Set the profile option *PO: Allow Retroactive Pricing of POs* to Open Release Only or All Releases. See: Profile Options and Security Functions, page C-1.
- The PO Change Order Workflow must be configured to allow automatic re-approval of the updated releases and purchase orders. See: Workflow Processes for Approving Change Orders, page E-133.

## Submission

In the Submit Requests window, select Retroactive Price Update on Purchasing

Documents in the Name field.

## Parameters

### Supplier (Required)

Enter or select the supplier whose pricing needs to be updated. This must be a supplier that is currently in the system.

### Supplier Site (Optional)

Enter or select the supplier site.

### Agreement Number (Optional)

Enter a specific blanket or contract agreement number for which you want the pricing updated.

### Item Range (Optional)

Enter a range (from and to) of item numbers for which you want the pricing updated.

### Category Range (Optional)

Enter a range (from and to) of categories for which you want the pricing updated.

### Date From (Optional)

Specify a date to identify releases or standard purchase orders to be updated. The release shipment need-by date should be on or after the specified date. If need-by date is not available, the release shipment creation date will be used.

### Communicate Updates (Optional)

Indicate if you want the updated releases or purchase orders communicated to the supplier. The communication method is determined by the Supplier Notification Method setting of the supplier site. See: *Communicating Purchase Orders to Suppliers*, page 4-6

## Related Topics

Submitting a Request, *Oracle Applications User's Guide*

Self-Billing Invoices, page 13-19.

## Send Notifications for Purchasing Documents

The workflow process, Send Notifications for Purchasing Documents, looks for

documents that are incomplete, rejected, or in need of reapproval and sends notifications to the appropriate people of the document's status. You can view and respond to these notifications through the Notifications Summary window. In order for these notifications to be sent, you need to start this concurrent program process, Send Notifications for Purchasing Documents, and choose how frequently you want the process to run. (The workflow definition itself, Send Notifications for Purchasing Documents, which is initiated by this concurrent program process, is viewable through the Oracle Workflow Builder.)

For information on the kinds of notifications sent by the Send Notifications for Purchasing Documents process, see: Viewing and Responding to Notifications, page 2-29.

**To run the Send Notifications for Purchasing Documents process:**

1. Navigate to the Submit Requests window and select Send Notifications for Purchasing Documents in the Request Name field.
2. Choose Schedule.
3. Choose how often you want the process to run.

For example, choose Periodically if you want the process to run periodically. You can then choose to run the process every so many month(s), week(s), day(s), hour(s), or minute(s). For example, choose On Specific Days if you want the process to run on specific days of the month or week.

4. Choose OK.
5. Choose Submit Request once you've selected your options and are ready to run the process.

## Related Topics

Send Notifications Workflow, page E-195

*Oracle Workflow Guide, Oracle Workflow Guide*

Submitting a Request, *Oracle Applications User's Guide*



---

## Windows and Navigator Paths

### Oracle Purchasing Windows and Navigator Paths

See also: Oracle Purchasing Character Mode Forms and Corresponding GUI Windows, *Oracle Purchasing User's Guide, Release 11i*.

#### Referenced Windows:

Although your system administrator may have customized your navigator, typical navigational paths include the following:

**Note:** Text in brackets ([ ]) indicates a button.

---

Window Name	Navigation Path
Acceptances, page 4-82	Purchase Orders > Purchase Orders > Tools menu > Acceptances
Account Generator Processes, page E-24	Setup > Flexfields > Key > Accounts
Accounting Calendar, <i>Oracle General Ledger User's Guide</i>	Setup > Financials > Accounting > Calendar
Accrual Options, page 1-40	Setup > Organizations > Purchasing Options > Accrual

---

Window Name	Navigation Path
Action History, page 10-1	From the following windows: Releases, Purchase Order Headers, Purchase Order Lines, Purchase Order Shipments, Purchase Order Distributions, Requisition Headers, Requisition Lines, Requisition Distributions > View Requisitions > Tools menu > View Action History
Agreements,	Buyer Work Center > Agreements
Analyze Quotations, page 5-77	RFQs and Quotations > Quote Analysis > [Find]
AP and PO Accrual Write-Offs, page 9-116	Accounting > Accrual Write Offs > AP and PO Accrual
Approval Assignments, page 1-24	Setup > Approvals > Approval Assignments
Approval Groups, page 1-21	Setup > Approvals > Approval Groups
Approve Entire Quotation, page 5-79	RFQs and Quotations > Quotations > [Approve] RFQs and Quotations > Quotations > [Price Breaks] > [Approve] RFQs and Quotations > Quote Analysis > [Find] > [Approve Entire Quotation]
Approve Document, page 2-32	Requisitions > Requisitions > [Approve] Purchase Orders > Purchase Orders > [Approve] Purchase Orders > Releases > [Approve] Buyer Work Center > Orders > Create > [Submit] Buyer Work Center > Agreements > Create > [Submit]
Approved Supplier List, page 5-35	Supply Base > Approved Supplier List
Approved Supplier List Statuses, page 5-37 Approved Supplier List Statuses, <i>Oracle Supplier Scheduling User's Guide</i>	Supply Base > Supplier Statuses

<b>Window Name</b>	<b>Navigation Path</b>
Approved Supplier List Summary, page 5-48 Approved Supplier List Summary, <i>Oracle Supplier Scheduling User's Guide</i>	Supply Base > Summary Approved Supplier List
Assign Cross References, <i>Oracle Inventory User's Guide</i>	Items > Cross References > [Assign]
Assign Requisition Lines, page 5-86	Management > Manage Buyer Workload > [Find]
Assign Security Rules, <i>Oracle Applications System Administrator's Guide</i>	Setup > Flexfields > Descriptive > Security > Assign Setup > Flexfields > Key > Security > Assign Setup > Flexfields > Validation > Security > Assign
AutoCreate Documents, page 6-12	Autocreate > [Find]
Buyers, page 1-20	Setup > Personnel > Buyers
Buyer Workload, page 5-85	Management > Manage Buyer Workload > [Find]
Categories, <i>Oracle Inventory User's Guide</i>	Setup > Items > Categories > Category Codes
Category Assignment, <i>Oracle Inventory User's Guide</i>	Items > Master Items > Tools menu > Categories Items > Organization Items > Tools menu > Categories
Category Sets, <i>Oracle Inventory User's Guide</i>	Setup > Items > Categories > Category Sets
Change Organization (MRP),	Change Organization
Common Lookups (SYS),	Setup > Items > Item Types
Concurrent Requests Summary (User),	Requests

Window Name	Navigation Path
Control Document, page 2-57	<p>Requisitions &gt; Requisition Summary &gt; [Headers] &gt; [Find] &gt; Tools menu &gt; Control</p> <p>Requisitions &gt; Requisition Summary &gt; [Lines] &gt; [Find] &gt; Tools menu &gt; Control</p> <p>Purchase Orders &gt; Purchase Order Summary &gt; [Headers] &gt; [Find] &gt; Tools menu &gt; Control</p> <p>Purchase Orders &gt; Purchase Order Summary &gt; [Lines] &gt; [Find] &gt; Tools menu &gt; Control</p> <p>Purchase Orders &gt; Purchase Order Summary &gt; [Shipments] &gt; [Find] &gt; Tools menu &gt; Control</p>
Control Options, page 1-34	Setup > Organizations > Purchasing Options > Control
Control Purchasing Periods, page 1-82	Setup > Financials > Accounting > Control Purchasing Periods
Copy Document, page 4-99	<p>Purchase Orders &gt; Purchase Orders &gt; Tools menu &gt; Copy Document</p> <p>Purchase Orders &gt; Purchase Order Summary &gt; Tools menu &gt; Copy Document</p> <p>RFQs and Quotations &gt; Quotations &gt; Tools menu &gt; Copy Document</p>
Copy Document, page 5-74	RFQs and Quotations > RFQs > Tools menu > Copy Document
Corrections, page 9-78	<p>Receiving &gt; Corrections</p> <p>Receiving &gt; Corrections &gt; [Find]</p>
Cross Reference Types, <i>Oracle Inventory User's Guide</i>	Items > Cross References
Cross-Validation Rules, <i>Oracle Applications Flexfields Guide</i>	Setup > Flexfields > Key > Cross-Validation
Currencies, <i>Oracle General Ledger User's Guide</i>	Setup > Financials > Currency > Currencies



<b>Window Name</b>	<b>Navigation Path</b>
Currency, page 4-60	Purchase Orders > Purchase Orders > [Currency] RFQs and Quotations > RFQs > [Currency] RFQs and Quotations > Quotations > [Currency]
Daily Rates, <i>Oracle General Ledger User's Guide</i>	Setup > Financials > Currency > Currencies > Daily Rates
Daily Conversion Rate Type, <i>Oracle General Ledger User's Guide</i>	Setup > Financials > Currency > Daily Conversion Rate Type
Default Category Sets, <i>Oracle Inventory User's Guide</i>	Setup > Items > Categories > Default Category Sets
Define Catalog Server for External Suppliers, page 1-89	Setup > E-Catalog Admin > External Suppliers
Define Catalog Server Loader Values, page 1-89	Setup > E-Catalog Admin > Loader Values
Define Information Template, page 1-89	Setup > Information Templates
Define MassCancel, page 2-61	Accounting > MassCancel
Define Security Rules, <i>Oracle Applications Flexfields Guide</i>	Setup > Flexfields > Descriptive > Security > Define Setup > Flexfields > Key > Security > Define Setup > Flexfields > Validation > Security > Define
Deletion Constraint, <i>Oracle Bills of Material User's Guide</i>	Setup > Items > Delete Constraints
Deletion Groups, <i>Oracle Bills of Material User's Guide</i>	Items > Delete Items
Deliverables, <i>Oracle Procurement Contracts Implementation and Administration Guide</i>	Buyer Work Center > Deliverables
See also: Manage Deliverables	

<b>Window Name</b>	<b>Navigation Path</b>
Demand Workbench,	Buyer Work Center > Requisitions
Descriptive Flexfield Segments, <i>Oracle Applications Flexfields Guide</i>	Setup > Flexfields > Descriptive > Segments
Distributions, page 4-75	Purchase Orders > Purchase Orders > [Shipments] > [Distributions]  Purchase Orders > Releases > [Distributions]  Requisitions > Requisitions > [Distributions]  Buyer Work Center > Orders > [Order] > [Distributions]  Buyer Work Center > Requisitions > [Summary] > [Distributions]
Document Types, page 1-62	Setup > Purchasing > Document Types
Economic Zones, <i>Oracle Inventory User's Guide</i>	Setup > Movement Statistics > Economic Zones
Enter Person, <i>Oracle HRMS Enterprise and Workforce Management Guide</i>	Setup > Personnel > Employees
Exceeded Price Tolerances, page 5-21	Purchase Orders > Exceeded Price Tolerances  Notifications Summary > Price tolerance exceeded notification > [Open Document]
Express Receipts, page 9-25	Receiving > Receipts > [Find] > [Express]
Find Corrections, page 9-74	Receiving > Corrections
Find Expected Receipts, page 9-25	Receiving > Receipts
Find Intransit Shipments, page 9-80	Receiving > Manage Shipments
Find Item Information, <i>Oracle Inventory User's Guide</i>	Items > Item Information

<b>Window Name</b>	<b>Navigation Path</b>
Find Purchase Orders, page 4-23	Purchase Orders > Purchase Order Summary
Find Quotations, page 5-75	RFQs and Quotations > Quote Analysis
Find Receiving Transactions, page 9-55	Receiving > Receiving Transactions
Find Receiving Transactions (Summary), page 9-41	Receiving > Receiving Transactions Summary
Find Requisitions, page 3-36	Requisitions > Requisition Summary
Find Requisition Lines, page 6-9	Autocreate
Find Requisition Lines, page 5-83	Management > Manage Buyer Workload
Find Returns, page 9-68	Receiving > Returns
Find Unordered Receipts, page 9-36	Receiving > Match Unordered Receipts
Forward Documents, page 2-39	Management > Forward Documents
Freight Carriers, <i>Oracle Shipping Execution User's Guide</i>	Setup > Purchasing > Freight Carriers
GL Accounts, <i>Oracle General Ledger User's Guide</i>	Setup > Accounting > Accounts
Hazard Classes, page 1-53	Setup > Purchasing > Hazard Classes
Import Items, <i>Oracle Inventory User's Guide</i>	Items > Import Items
Inspect Received Items, page 9-65	Receiving > Receiving Transactions > [Inspect]
Item Assignment, <i>Oracle Inventory User's Guide</i>	Setup > Items > Categories > Category Sets > [Assign]

<b>Window Name</b>	<b>Navigation Path</b>
Internal Requisition Options, page 1-38	Setup > Organizations > Purchasing Options > Internal Requisitions
Item Attribute Controls, <i>Oracle Inventory User's Guide</i>	Setup > Items > Attribute Controls
Item Attributes, <i>Oracle Inventory User's Guide</i>	Items > Item Information > [Attributes]
Item Catalog, <i>Oracle Inventory User's Guide</i>	Items > Master Items > Tools menu > Catalog
Item Catalog Groups, <i>Oracle Inventory User's Guide</i>	Setup > Items > Catalog Groups Setup > Items > Catalog Groups > [Details]
Item Categories, <i>Oracle Inventory User's Guide</i>	Items > Item Information > [Categories]
Item Cross Reference Assignment, <i>Oracle Inventory User's Guide</i>	Items > Master Items > Tools menu > Cross References
Item Flexfield View, <i>Oracle Inventory User's Guide</i>	Setup > Items > Item Flexfield View
Item Relationships, <i>Oracle Inventory User's Guide</i>	Items > Item Relationships Items > Master Items > Tools menu > Item Relationships
Item Revisions, <i>Oracle Inventory User's Guide</i>	Items > Master Items > Tools menu > Revisions Items > Organization Items > Tools menu > Revisions
Item Revisions,	Items > Item Information > [Revisions]
Item Search, <i>Oracle Inventory User's Guide</i>	Items > Item Search
Item Source, page 1-89	Setup > E-Catalog Admin > Item Sources
Item Status History, <i>Oracle Inventory User's Guide</i>	Items > Master Items > Tools menu > Pending Status

<b>Window Name</b>	<b>Navigation Path</b>
	Items > Organization Items > Tools menu > Pending Status
Item Subinventories, <i>Oracle Inventory User's Guide</i>	Items > Master Items > Tools menu > Item Subinventories Items > Organization Items > Tools menu > Item Subinventories
Item Template, <i>Oracle Inventory User's Guide</i>	Setup > Items > Templates > [New]
Item Templates Summary, <i>Oracle Inventory User's Guide</i>	Setup > Items > Templates
Item Type QuickCodes, <i>Oracle Inventory User's Guide</i>	Setup > Items > Item Types
Key Flexfield Segments, <i>Oracle Applications Flexfields Guide</i>	Setup > Flexfields > Key > Segments
Key Segment Values, <i>Oracle Applications Flexfields Guide</i>	Setup > Flexfields > Key > Values
Line Types, page 1-62	Setup > Purchasing > Line Types
Locations, page 1-18	Setup > Organizations > Locations
Lookup Codes, page 1-55	Setup > Purchasing > Lookup Codes
Lot Entry, <i>Oracle Inventory User's Guide</i>	[Lot/Serial] various locations
Manage Deliverables, <i>Oracle Procurement Contracts Implementation and Administration Guide</i>	Purchase Orders > Manage Deliverables
Manage Shipments, page 9-81	Receiving > Manage Shipments > [Find]
Manage Tax, page 4-117	From the following windows: Requisitions, Purchase Orders, and Releases, and their corresponding Shipments and Distributions windows > Tools menu > Manage Tax

<b>Window Name</b>	<b>Navigation Path</b>
Manufacturer Part Numbers, <i>Oracle Inventory User's Guide</i>	Items > Manufacturers' Part Numbers > By Items
	Items > Manufacturers' Part Numbers > By Manufacturers > [Parts]
	Items > Master Items > Tools menu > Manufacturer Part Numbers
	Items > Organization Items > Tools menu > Manufacturer Part Number
Manufacturers, <i>Oracle Inventory User's Guide</i>	Items > Manufacturers' Part Numbers > By Manufacturers
Master Items, <i>Oracle Inventory User's Guide</i>	Items > Master Items > [New]
	Items > Master Items > [Open]
Mass Forwarding Documents, page 2-39	Management > Forward Documents
Master Items Summary, <i>Oracle Inventory User's Guide</i>	Items > Master Items
Match Unordered Receipts, page 9-36	Receiving > Match Unordered Receipts > [Find]
Miscellaneous Accrual Write-Offs, page 9-117	Accounting > Accrual Write Offs > Miscellaneous
Modify Lines, page 6-19	Autocreate > [Find] > Tools menu > [Modify]
Movement Statistics, <i>Oracle Inventory User's Guide</i>	Receiving > Update Movement Statistics
Movement Statistics Parameters, <i>Oracle Inventory User's Guide</i>	Setup > Movement Statistics > Parameters
New Document, page 6-15	Autocreate > [Find] > [Automatic]
New Document Number, page 6-17	Autocreate > [Find] > [Manual]

<b>Window Name</b>	<b>Navigation Path</b>
Notification Controls, page 4-80	Purchase Orders > Purchase Orders > Tools menu > Notification Control
Notifications, page 2-29	Notifications Summary > [Open]
Notifications Summary, page 2-29	Notifications Summary
Numbering Options, page 1-41	Setup > Organizations > Purchasing Options > Numbering
Order Pad Options, page 5-16	Supplier Item Catalog > [Find] > [Options] Requisitions > Requisitions > [Catalog] > [Options] Purchase Orders > Purchase Orders > [Catalog] > [Options]
Orders, page 7-10	Buyer Work Center > Orders
Organization Assignment, <i>Oracle Inventory User's Guide</i>	Items > Master Items > Tools menu > Organization Assignment
Organization Items, <i>Oracle Inventory User's Guide</i>	Items > Organization Items > [Open]
Organization Items Summary, <i>Oracle Inventory User's Guide</i>	Items > Organization Items
Organization, <i>Oracle HRMS Enterprise and Workforce Management Guide</i>	Setup > Organizations > Organizations
Outside Processing page , page 4-79	Purchase Orders > Purchase Orders > [Shipments] > [Distributions] > [Outside Processing] Requisitions > Requisitions > [Distributions] > [Outside Processing]
Pending Status, <i>Oracle Inventory User's Guide</i>	Items > Pending Status Items > Master Items > Tools menu > Pending Status Items > Organization Items > Pending Status

<b>Window Name</b>	<b>Navigation Path</b>
Period Types, <i>Oracle General Ledger User's Guide</i>	Setup > Financials > Accounting > Period Types
Personal Profile Values, <i>Oracle Applications User's Guide</i>	Personal Profiles
Purchase Agreement Price Break , page 4-73	Purchase Orders > Purchase Order Summary > [Find] > [Open] > Price Reference  Buyer Work Center > Agreements > [Agreement] > [Lines] > [Update]
Purchase Order Distributions, page 4-35	Purchase Orders > Purchase Order Summary > [Distributions] > [Find]  Purchase Orders > Purchase Order Summary > [Headers] > [Find] > [Lines] > [Shipments] > [Distributions]  Buyer Work Center > Orders > [Order] > [Distributions] > [Go]
Purchase Order Headers, page 4-26	Purchase Orders > Purchase Order Summary > [Headers] > [Find]  Buyer Work Center > Orders > [Order] > [Headers] > [Go]
Purchase Order Lines, page 4-30	Purchase Orders > Purchase Order Summary > [Lines] > [Find]  Purchase Orders > Purchase Order Summary > [Headers] > [Find] > [Lines]  Buyer Work Center > Orders > [Order] > [Lines] > [Go]
Purchase Order Shipments, page 4-32	Purchase Orders > Purchase Order Summary > [Shipments] > [Find]  Purchase Orders > Purchase Order Summary > [Headers] > [Find] > [Lines] > [Shipments]  Buyer Work Center > Orders > [Order] > [Shipments] > [Go]
Purchase Order Preferences, page 4-37	Purchase Orders > Purchase Orders > Tools menu > Preferences  Purchase Orders > Purchase Order Summary > Tools menu > Preferences



<b>Window Name</b>	<b>Navigation Path</b>
Purchase Orders, page 4-40	Purchase Orders > Purchase Orders Purchase Orders > Purchase Order Summary > [New PO]
Purchasing Options, page 1-33	Setup > Organizations > Purchasing Options
Purchasing Receiving Accounting, page 9-61	In General Ledger, navigate to this window from the Account Inquiry, Enter Journals, or View Journals windows
Quality Inspection Codes, page 1-57	Setup > Purchasing > Quality Inspection Codes
Quotation Price Breaks, page 5-72	RFQs and Quotations > Quotations > [Price Breaks]
Quotations, page 5-62	RFQs and Quotations > Quotations
Quotation Shipments, page 5-70	RFQs and Quotations > Quotations > [Shipments]
Quotation Terms, page 5-69	RFQs and Quotations > Quotations > [Terms]
Realms, page 1-89	Setup > E-Catalog Admin > Realms
Receipts, page 9-30	Receiving > Receipts > [Find]
Receipt Header, page 9-29	Receiving > Receipts > [Find] > [Header]
Receipt Header Details, page 9-50	Receiving > Receiving Transactions Summary > [Find] > [Transactions] > [Header]
Receipt Lines, page 9-30	Receiving > Receipts
Receiving Controls, page 4-71	Purchase Orders > Purchase Orders > [Shipments] > [Receiving Controls] Purchase Orders > Releases > [Receiving Controls]
Receiving Corrections,	Receiving > Corrections > [Find]
Receiving Headers Summary, page 9-44	Receiving > Receiving Transactions Summary > [Find]

<b>Window Name</b>	<b>Navigation Path</b>
Receiving Options, page 1-42	Setup > Organizations > Receiving Options
Receiving Returns, page 9-71	Receiving > Returns > [Find]
Receiving Transactions, page 9-58	Receiving > Receiving Transactions > [Find]
Receiving Transaction Summary, page 9-45	Receiving > Receiving Transactions Summary > [Find] > [Transactions]
Releases, page 4-40	Purchase Orders > Releases  Purchase Orders > Purchase Order Summary > [NewRelease]
Requisition Headers Summary, page 3-39	Requisitions > Requisition Summary > [Headers] > [Find]  Buyer Work Center > Requisitions > Summary > [Requests] > [Go]
Requisition Lines Summary, page 3-40	Requisitions > Requisition Summary > [Lines] > [Find]  Requisitions > Requisition Summary > [Headers] > [Find] > [Lines]  Buyer Work Center > Requisitions > Summary > [Lines] > [Go]
Requisition Distributions Summary, page 3-42	Requisitions > Requisition Summary > [Distributions] > [Find]  Requisitions > Requisition Summary > [Headers] > [Find] > [Lines] > [Distributions]  Buyer Work Center > Requisitions > Summary > [Distributions] > [Go]
Requisition Preferences, page 3-44	Requisitions > Requisitions > Tools menu > Preferences  Requisitions > Requisition Summary > Tools menu > Preferences
Requisitions, page 3-48	Requisitions > Requisitions

<b>Window Name</b>	<b>Navigation Path</b>
Requisition Templates, page 1-46	Setup > Purchasing > Requisition Templates Requisitions > Requisitions > Items > [Catalog] > Requisition Templates tabbed region Requisitions > Requisition Summary > [Headers] > [Find] > [New] Requisitions > Requisition Summary > [Headers] > [Find] > [Open]
RFQ Lines, page 5-49	RFQs > Quotations > RFQs
RFQ Price Breaks, page 5-60	RFQs and Quotations > RFQs > [Price Breaks]
RFQs, page 5-49	RFQs and Quotations > RFQs
RFQ Shipments, page 5-55	RFQs and Quotations > RFQs > [Shipments]
RFQ Suppliers, page 5-55	RFQs and Quotations > RFQs > [Suppliers]
RFQ Terms, page 5-57	RFQs and Quotations > RFQs > [Terms]
Rollup Groups, <i>Oracle Applications Flexfields Guide</i>	Setup > Flexfields > Key > Groups
Run MassCancel, page 2-67	Accounting > Run MassCancel
Search Supplier Item Catalog, page 5-9	Supplier Item Catalog
Select Accrual Accounts, page 9-115	Accounting > Accrual Write Offs > Select Accrual Accounts
Segment Values, <i>Oracle Applications Flexfields Guide</i>	Setup > Flexfields > Descriptive > Values Setup > Flexfields > Validation > Values
Serial Numbers, <i>Oracle Inventory User's Guide</i>	[Lot/Serial] various locations
Ledger, <i>Oracle General Ledger User's Guide</i>	Setup > Organizations > Ledger

<b>Window Name</b>	<b>Navigation Path</b>
Shipments, page 4-67	Purchase Orders > Purchase Orders > [Shipments]
Shorthand Aliases, <i>Oracle Applications Flexfields Guide</i>	Setup > Flexfields > Key > Aliases
Sourcing Rule, <i>Oracle Master Scheduling/MRP and Supply Chain Planning User's Guide</i>	Supply Base > Sourcing Rules
Sourcing Rule/Bill of Distribution Assignments, <i>Oracle Master Scheduling/MRP and Supply Chain Planning User's Guide</i>	Supply Base > Assign Sourcing Rules
Status, <i>Oracle Inventory User's Guide</i>	Setup > Items > Status Codes
Suppliers, <i>Oracle iSupplier Portal Implementation Guide.</i>	Supply Base > Suppliers Buyer Work Center > Suppliers
Supplier-Item Attributes, page 5-43	Supply Base > Approved Supplier List > [Attributes]
Supplier Item Catalog, page 5-13	Supplier Item Catalog > [Find]
Supplier Lists, page 5-81	Supply Base > Define Supplier Lists
System Profile Values, <i>Oracle Applications System Administrator's Guide</i>	Setup > Profiles > System
Tax, <i>Oracle Payables User's Guide</i>	Setup > Tax > Tax
Terms and Conditions, page 4-61	Purchase Orders > Purchase Orders > [Terms]
Transaction Reasons, <i>Oracle Inventory User's Guide</i>	Setup > Transactions > Reasons

<b>Window Name</b>	<b>Navigation Path</b>
Unit of Measure Classes, <i>Oracle Inventory User's Guide</i>	Setup > Units of Measure > Classes
Unit of Measure Conversions, <i>Oracle Inventory User's Guide</i>	Setup > Units of Measure > Conversions Setup > Units of Measure > Classes > [Conversions] Setup > Units of Measure > Units of Measure > [Conversions]
Units of Measure, <i>Oracle Inventory User's Guide</i>	Setup > Units of Measure > Units of Measure Setup > Units of Measure > Classes > [Units of Measure]
UN Numbers, page 1-54	Setup > Purchasing > UN Numbers
Value Sets, <i>Oracle Applications Flexfields Guide</i>	Setup > Flexfields > Validation > Sets
View Write-Off Transactions, page 9-118	Accounting > Accrual Write Offs > View Write-Off
View Receiving Accounting, page 9-47	Receiving > Receiving Transactions Summary > [Find] > [Transactions] > Tools menu > View Accounting



---

## Oracle Purchasing Alerts

### Using Oracle Alert in Oracle Purchasing

Several Oracle Applications products, including Purchasing, include the functionality of Oracle Alert to provide you with on-line exception reporting capability.

Oracle Alert is a customizable exception control application that:

- Notifies you automatically when a user performs a specific form transaction
- Notifies you automatically when a specific database transaction occurs
- Provides key information to you on a periodic basis
- Monitors critical activity in your Purchasing database
- Acts automatically according to your specifications

Purchasing supplies you with several *pre-coded* alerts that you can use with or without customizing. These alerts help you identify forecast overconsumption. See: Using Predefined Alerts, *Oracle Alert User's Guide*.

You get the alerts described in the following pages if you have Oracle Alert. You can also create your own alerts to notify you when a user takes a specific action, or notify you about specific exceptions found in your Purchasing database. You can also create alerts that send messages about key indicators, according to a delivery schedule you define. See: Overview of Oracle Alert, *Oracle Alert User's Guide*.

#### **Expiration and Release Control Alerts**

For planned purchase orders, blanket purchase agreements, and contracts, you can establish expiration and release control notification conditions and specify the number of days before the condition is met that you want to be notified. By selecting Notification Controls on the Tools menu in the Purchase Orders window, you can specify the following notification conditions:

- Amount released by date
- Amount not released by date
- Amount not released
- Amount released
- Expiration date

When the notification conditions are met, Purchasing sends you one of the following Oracle Alerts so that you can take appropriate action:

<b>Amount Not Released</b>	Alerts you that the total planned amount released to date against a planned purchase order, blanket purchase agreement, or contract purchase agreement is insufficient.
<b>Amount Released</b>	Alerts you that the total amount released to date against a planned purchase order, blanket purchase agreement, or contract purchase agreement meets or exceeds specified amounts.
<b>Expiration</b>	Alerts you that a planned purchase order, blanket purchase agreement, or contract purchase agreement is about to expire.

See Also: Entering Purchase Order Notification Controls, page 4-80

## Predefined Purchasing Alerts

Oracle Alert supplies you with the following predefined alerts for Purchasing that you can use with or without customizing. For each pre-coded alert, we include:

- A brief explanation of what the alert does
- Information about the alert's periodicity, inputs, and distribution
- An example of the message Oracle Alert sends when you use the alert

## Approved Standard Purchase Orders

This alert shows the number of approved purchase orders created by each buyer during the past N days.

<b>Alert Type</b>	Periodic
<b>Periodicity</b>	On Demand
<b>Inputs</b>	Number of days



Distribution	User defined
--------------	--------------

### **Blanket Notification Expiration**

This alert shows the blanket purchase agreements that are about to expire.

Alert Type	Periodic
Periodicity	On Demand
Inputs	None
Distribution	Buyer

### **Blanket Notification Not Released**

This alert shows the blanket purchase agreements for which an insufficient amount has been released.

Alert Type	Periodic
Periodicity	On Demand
Inputs	None
Distribution	Buyer

### **Blanket Notification Released**

This alert shows the blanket purchase agreements for which the desired amount has been released.

Alert Type	Periodic
Periodicity	On Demand
Inputs	None
Distribution	Buyer

### **Blanket Purchase Releases over Threshold**

This alert looks for blanket purchase releases that exceed a certain dollar amount.

Alert Type	Periodic
Periodicity	On Demand
Inputs	Number of days

	Dollar amount
Distribution	User defined

### **Contract Notification Expiration**

This alert shows the contract purchase agreements that are about to expire.

Alert Type	Periodic
Periodicity	On Demand
Inputs	None
Distribution	Buyer

### **Contract Notification Not Released**

This alert shows the contract purchase agreements for which an insufficient amount has been released.

Alert Type	Periodic
Periodicity	On Demand
Inputs	None
Distribution	Buyer

### **Contract Notification Released**

This alert shows the contract purchase agreements for which the desired amount has been released.

Alert Type	Periodic
Periodicity	On Demand
Inputs	None
Distribution	Buyer

### **No Receipt Required on Purchase Order Shipment**

This alert looks for purchase order shipments where two-way matching is allowed.

Alert Type	Periodic
Periodicity	On Demand

<b>Inputs</b>	Number of days
<b>Distribution</b>	User defined

### **Planned Notification Expiration**

This alert shows the planned purchase orders that are about to expire.

<b>Alert Type</b>	Periodic
<b>Periodicity</b>	On Demand
<b>Inputs</b>	None
<b>Distribution</b>	Buyer

### **Planned Notification Not Released**

This alert shows the planned purchase orders for which an insufficient amount has been released.

<b>Alert Type</b>	Periodic
<b>Periodicity</b>	On Demand
<b>Inputs</b>	None
<b>Distribution</b>	Buyer

### **Planned Notification Released**

This alert shows the planned purchase orders for which the desired amount has been released.

<b>Alert Type</b>	Periodic
<b>Periodicity</b>	On Demand
<b>Inputs</b>	None
<b>Distribution</b>	Buyer

### **Small Business Suppliers**

This alert shows your suppliers who are identified as small businesses.

<b>Alert Type</b>	Periodic
<b>Periodicity</b>	On Demand

<b>Inputs</b>	None
<b>Distribution</b>	Buyer

### **Standard Purchase Orders over Threshold**

This alert looks for standard purchase orders created in the past N days that exceed a certain dollar amount.

<b>Alert Type</b>	Periodic
<b>Periodicity</b>	On Demand
<b>Inputs</b>	Number of days Dollar total
<b>Distribution</b>	User defined

### **Suppliers on Hold**

This alert shows the suppliers that you have placed on hold.

<b>Alert Type</b>	Periodic
<b>Periodicity</b>	On Demand
<b>Inputs</b>	None
<b>Distribution</b>	User defined

---

# Oracle Purchasing Profile Options and Profile Option Categories

## Profile Options and Profile Option Categories Overview

During implementation, set a value for each Oracle Purchasing profile option to specify how Purchasing controls access to and processes data.

See: Setting User Profile Options, *Oracle Applications System Administrator's Guide - Maintenance*

Profile options are grouped into one or more profile option categories enabling you to view only the profile options that pertain to your application or function.

### **Purchasing Categories**

- Approvals,
- AutoCreate,
- AutoCreate Security,
- AutoCreate UI,
- Automatic Sourcing,
- Catalog Import,
- Consigned and VMI,
- Create Releases,
- Debug,
- Deployment,

- Document Builder Security,
- Document Builder UI,
- Document Security,
- Encumbrance,
- Enterprise Asset Management Setup,
- iProcurement Setup,
- Notifications,
- Notifications UI,
- PO Communication,
- PO/Releases/Requisitions UI,
- Procurement Contracts Setup,
- Receiving,
- Requisition Import,
- Self-Billing,
- Services Procurement Setup,
- Sourcing Setup,
- Supplier Item Catalog Forms UI,

**Purchasing Profile Options**

- PO: Allow Autocreation of Oracle Sourcing Documents, page C-9
- PO: Allow Auto-generate Sourcing Rules, page C-20
- PO: Allow Buyer Override in Autocreate Find, page C-9
- PO: Allow Category Override in Autocreate Find, page C-9
- PO: Allow Rate Override For User Rate Type, page C-20
- PO: Allow Referencing CPA Under Amendment, page C-28
- PO: Allow Requisition Approval Forward Action, page C-6

- PO: Allow Retroactive Pricing of POs, page C-21
- PO: Amount Billed Threshold Percentage, page C-24
- PO: Approval Timeout Value, page C-16
- PO: Archive Catalog on Approval, page C-6
- PO: Auto Apply Default Contract Template, page C-10
- PO: AutoCreate GL Date Option, page C-7
- PO: Automatic Document Sourcing, page C-11
- PO: Automatically Deliver Drop Ship ASNs, page C-29
- PO: Cache Time To Live, page C-16
- PO: Change Supplier Site, page C-21
- PO: Check open periods, page C-27
- PO: Contractor Assignment Completion Warning Delay, page C-24
- PO: Contracts Enabled, page C-16
- PO: Convert Requisition UOM to Source Document UOM, page C-8
- PO: Custom Measure Precedence, page C-17
- PO: cXML From Domain, page C-25
- PO: cXML From Identity, page C-25
- PO: Default Need-By Time, page C-27
- PO: Default PO Promise Date from Need By Date, page C-8
- PO: Default Requisition Grouping, page C-19
- PO: Default Supplier Item Catalog Option, page C-32
- PO: Display the Autocreated Document, page C-10
- PO: Display the Autocreated Quotation, page C-10
- PO: Display VMI Warning, page C-27

- PO: Document Builder Default Document Type, page C-19
- PO: Enable Direct Delivery To Shop Floor, page C-21
- PO: Enable Services Procurement, page C-17
- PO:Enable Sql Trace for Receiving Processor, page C-14
- PO: ERS Aging Period, page C-30
- PO: ERS Invoice Number Prefix, page C-31
- PO:Fax Output Directory for the PO Document, page C-25
- PO: Generate Amendment Documents, page C-25
- PO: In File Path, page C-26
- PO: Item Cross Reference Warning, page C-32
- PO: Legal Requisition Type, page C-21
- PO: MFG Organization ID, page C-17
- PO: Notification Lines Display Limit, page C-24
- PO: Override Approved Supplier List Status - OBSOLETE
- PO:Override Funds Reservation, page C-22
- PO: Price Tolerance (%) for Catalog Updates, page C-12
- PO: Release During ReqImport, page C-30
- PO: Restrict Requisition line modify to quantity split, page C-9
- PO: Secondary Email address, page C-26
- PO: Set Debug Concurrent ON, page C-14
- PO: Set Debug Workflow ON, page C-15
- PO: Supplier Consigned Enabled, page C-13
- PO: Supplier Pricing Method - OBSOLETE
- PO: Terms and Conditions filename, page C-26



- PO: UOM Class for Temp Labor Services, page C-31
- PO: Use Document GL Date to Unreserve, page C-22
- PO: Use P-Cards in Purchasing, page C-27
- PO: Use Requisition Line Numbers on Autocreated Purchase Order Lines, page C-8
- PO: Use Ship-to for Default Autocreate grouping, page C-8
- PO: VMI Enabled, page C-13
- PO: Warn if RFQ Required before Autocreate, page C-10
- PO: Workflow Processing Mode, page C-17
- PO: Write Server Output to File, page C-15
- RCV: Allow routing override, page C-21
- RCV: Debug Mode, page C-15
- RCV: Default Include Closed PO Option, page C-29
- RCV: Fail All ASN Lines if One Line Fails, page C-29
- RCV: Print Receipt Traveler, page C-29
- RCV: Processing Mode, page C-17

## Profile Option Category and Profile Options Descriptions

This section describes profile options by category.

The tables in this section provide profile option information as follows:

- The Default column displays either the default profile option value in italics, or No Default if none exists.
- The User Access column indicates whether you can view or update the profile option.
- The System Administration: Site, Application, Responsibility, and User columns indicate at which levels the system administrator can update these profile options.

The key for each table is:

- Update: You can update the profile option.
- View Only: You can view the profile option but cannot change it.
- No Access: You cannot view or change the profile option.

## Approvals Category

The table below lists the profile options that impact document approvals.

### Approvals Profile Options

Profile Option	Default	User Access	System Administration: Site	System Administration: Application	System Administration: Responsibility	System Administration: User
PO: Allow Requisition Approval Forward Action,	Yes	View Only	Update	View Only	View Only	View Only
PO: Archive Catalog on Approval,	No	Update	Update	Update	Update	Update

### PO: Allow Requisition Approval Forward Action

Yes indicates that the *Forward* and the *Approve and Forward* actions are active in a requisition approval notification.

### PO: Archive Catalog on Approval

Yes or No indicates whether Purchasing archives blanket purchase agreements in a price/sales catalog submission upon approval. You need to consider this profile option only if you receive price/sales catalog submissions from your suppliers through the Purchasing Documents Open Interface. This profile option comes into effect only if Archive on Approval is chosen in the Document Types window in Purchasing and you import the documents with a status of Approved; if you then choose No for this profile option, Purchasing does not archive the price/sales catalog agreements.

**Note:** If a document update is pending review in the Exceeded Price Tolerances window, the revision of that document is not updated until you accept all line updates.

For more information, see the *Oracle Manufacturing, Distribution, Sales and Service Open Interfaces Manual*.

## AutoCreate Category

The table below lists the profile options that control AutoCreate functionality options.

### *AutoCreate Profile Options*

Profile Option	Default	User Access	System Administration: Site	System Administration: Application	System Administration: Responsibility	System Administration: User
PO: AutoCreate GL Date Option,	<i>AutoCreate Date</i>	Update	Update	Update	Update	Update
PO: Convert Requisition UOM to Source Document UOM,	No Default	Update	Update	Update	Update	Update
PO: Default PO Promise Date from Need By Date,	No Default	Update	Update	Update	Update	Update
PO: Use Need-by Date for Default Autocreate Grouping,	No Default	Update	Update	Update	Update	Update
PO: Use Requisition Line Numbers on Autocreated Purchase Order Lines,	No Default	Update	Update	Update	Update	Update
PO: Use Ship-to for Default Autocreate grouping,	No Default	Update	Update	Update	Update	Update
PO: Warn if RFQ Required before Autocreate,	No	Update	Update	Update	Update	Update

### **PO: AutoCreate GL Date Option**

Indicates the date used on purchase orders generated by AutoCreate:

- *AutoCreate Date*: The autocreate date is used as the purchase order date.
- *Requisition GL Date*: The GL date on the requisition distribution is used as the purchase order date.

### PO: Convert Requisition UOM to Source Doc UOM During Release Creation

A Null setting (default value) indicates that the functionality continues as in the past (AutoCreate of releases from a requisition will fail with different UOMs, but the Create Releases concurrent program will convert UOMs and create a release). If set to Yes, users can create requisitions in a different UOM from the UOM on the blanket agreement line and the conversion will be done by Purchasing when the release is created. No means the UOM on the requisition must match the UOM on the blanket purchase agreement for a release to be created by any process.

### PO: Default PO Promise Date from Need By date

Yes indicates that the promise date is defaulted from the requisition need-by date when a purchase order or release is automatically created.

### PO: Use Need-by Date for Default Autocreate grouping

Yes indicates that the need-by date on the requisition is included with the defaults to group requisition lines.

### PO: Use Requisition Line Numbers on Autocreated Purchase Order Lines

Yes indicates that the requisition line numbers are used on autocreated purchase order lines. Note that this only applies when creating a new purchase order.

### PO: Use Ship-to for Default Autocreate grouping

Yes indicates that the ship-to organization and location on the requisition is included with the defaults to group requisition lines.

## AutoCreate Security Category

The table below lists the profile options that control security for AutoCreate functionality.

#### *AutoCreate Security Profile Options*

Profile Option	Default	User Access	System Administration: Site	System Administration: Application	System Administration: Responsibility	System Administration: User
PO: Allow Autocreation of Oracle Sourcing Documents,	No	View Only	Update	View Only	View Only	View Only

Profile Option	Default	User Access	System Administration: Site	System Administration: Application	System Administration: Responsibility	System Administration: User
PO: Allow Buyer Override in Autocreate Find,	Yes	Update	Update	Update	Update	Update
PO: Allow Category Override in Autocreate Find,	Yes	Update	Update	Update	Update	Update
PO: Restrict Requisition line modify to quantity split,	No	View Only	Update	Update	Update	View Only

### PO: Allow Autocreation of Oracle Sourcing Documents

Yes or No indicates whether the buyer can create Oracle Sourcing documents from the AutoCreate window. The default is No.

### PO: Allow Buyer Override in AutoCreate Find

Yes or No indicates whether the suggested buyer (from the Enter Person window) defaulted into the Find Requisition Lines window can be cleared or overridden. The default is Yes.

### PO: Allow Category Override in AutoCreate Find

Yes or No indicates whether the category (from the Buyers window) defaulted into the Find Requisition Lines window can be cleared or overridden.

### PO: Restrict Requisition line modify to quantity split

Yes or No indicates whether Purchasing restricts requisition line modify in AutoCreate to only splitting the quantity of a line. No means that the standard AutoCreate requisition line modify logic applies.

## AutoCreate UI Category

The table below lists the profile options that control the UI (user interface) aspects of AutoCreate.

### AutoCreate UI Profile Options

Profile Option	Default	User Access	System Administration: Site	System Administration: Application	System Administration: Responsibility	System Administration: User
PO: Auto Apply Default Contract Template,	No Default	Update	Update	Update	Update	Update
PO: Display the Autocreated Document,	Yes	Update	Update	Update	Update	Update
PO: Display the Autocreated Quotation,	Yes	Update	Update	Update	Update	Update
PO: Warn if RFQ Required before AutoCreate,	No	Update	Update	Update	Update	Update

#### PO: Auto Apply Default Contract Template

Oracle Procurement Contracts: Yes indicates to use the default defined for the document type contract template in Contract Terms Library.

#### PO: Display the Autocreated Document

Yes or No indicates whether Purchasing should automatically display the AutoCreated purchase order.

#### PO: Display AutoCreated Quotation

Yes or No indicates whether Purchasing should automatically display the AutoCreated quotation.

#### PO: Warn if RFQ Required before AutoCreate

Yes or No indicates whether you are given a warning message and an opportunity to cancel autocreate if one or more of the requisition lines selected for inclusion requires an RFQ and has not been placed on an RFQ.

If you use the PO Create Documents workflow to create purchase orders automatically from approved requisition lines, note that setting this profile option to Yes can affect the workflow. If it is set to Yes and the requisition line is not on an RFQ (but RFQ Required is checked for the requisition line), the workflow stops automatic document creation because it is unable to issue the warning. (The requisition line will still be available in

the AutoCreate Documents window.) Even if an RFQ is required for the requisition line, as long as this profile option is set to No, the workflow will continue creating the document.

## Automatic Sourcing Category

The table below lists the profile options that control automatic sourcing.

### Automatic Sourcing Profile Options

Profile Option	Default	User Access	System Administration: Site	System Administration: Application	System Administration: Responsibility	System Administration: User
PO: Automatic Document Sourcing,	No	View Only	Update	Update	No Access	No Access

### PO: Automatic Document Sourcing

Yes means that Oracle Purchasing automatically defaults source document and pricing information for an item from the most recently created purchase agreement or quotation. No means that this source document information comes from the Approved Supplier List window, where you must specify which source documents to use.

**Note:** If an item on a requisition is associated with both a blanket purchase agreement and a quotation, Oracle Purchasing may use the blanket purchase agreement even if the quotation was created more recently (depending on your sourcing settings).

See: Setting Up Automatic Sourcing, page 5-27.

## Catalog Import Category

The table below lists the profile options that control catalog import functionality.

### Catalog Import Profile Options

Profile Option	Default	User Access	System Administration: Site	System Administration: Application	System Administration: Responsibility	System Administration: User
PO: Archive Catalog on Approval,	No	Update	Update	Update	Update	Update
PO: Price Tolerance (%) for Catalog Updates,	No Default	Update	Update	Update	Update	Update

### PO: Price Tolerance (%) for Catalog Updates

A value in this profile option specifies the maximum percentage increase allowed to an item's price when your supplier sends updated price/sales catalog information through the Purchasing Documents Open Interface. This profile option affects only blanket purchase agreements and catalog quotations imported through the Purchasing Documents Open Interface. If the tolerance is exceeded, the buyer receives a notification and can accept or reject the price increase in the Exceeded Price Tolerances window.

This profile option is used only if price tolerances are not already defined at lower levels, in the purchase agreement Terms and Conditions window or the Supplier-Item Attributes window.

See: Receiving Price/Sales Catalog Information Electronically, page 5-18.

### Consigned and VMI Category

The table below lists the profile options that control consigned inventory and VMI functionality.

#### Consigned and VMI Profile Options

Profile Option	Default	User Access	System Administration: Site	System Administration: Application	System Administration: Responsibility	System Administration: User
PO: Display VMI Warning,	Yes	No Access	Update	No Access	No Access	No Access



Profile Option	Default	User Access	System Administration: Site	System Administration: Application	System Administration: Responsibility	System Administration: User
PO: Supplier Consigned Enabled,	No	No Access	Update	No Access	No Access	No Access
PO: VMI Enabled,	No	No Access	Update	No Access	No Access	No Access

### PO: Supplier Consigned Enabled

Yes or No indicates whether inventory consignment from supplier features are enabled in Oracle Purchasing

### PO: VMI Enabled

Oracle Vendor Managed Inventory: Yes or No indicates whether Vendor Managed Inventory (VMI) is enabled in Oracle Purchasing.

## Create Releases Category

The table below lists the profile options that control Purchasing create releases functionality.

### Create Releases Profile Options

Profile Option	Default	User Access	System Administration: Site	System Administration: Application	System Administration: Responsibility	System Administration: User
PO: Convert Requisition UOM to Source Document UOM,	No Default	Update	Update	Update	Update	Update
PO: Default PO Promise Date from Need By Date,	No Default	Update	Update	Update	Update	Update
PO: Release During ReqImport,	No	Update	Update	Update	Update	Update

## Debug Category

The table below lists the profile options that control debug features usually used by technical support staff.

### Debug Profile Options

Profile Option	Default	User Access	System Administration: Site	System Administration: Application	System Administration: Responsibility	System Administration: User
PO:Enable Sql Trace for Receiving Processor,	No	Update	Update	Update	Update	Update
PO: Set Debug Concurrent ON,	No	Update	Update	Update	Update	Update
PO: Set Debug Workflow ON,	No	Update	Update	Update	Update	Update
PO: Write Server Output to File,	No Default	Update	Update	Update	Update	Update
RCV: Debug Mode,	No	Update	Update	Update	Update	Update

### PO: Enable Sql Trace for Receiving Processor

Yes means that when you run the Receiving Transaction Processor to import data from another system using the Receiving Open Interface, the View Log screen displays the receiving transaction pre-processor's actions, including errors, as it processed the receipt data from start to finish. (The profile option RCV: Processing Mode must also be set to Immediate or Batch for the Yes option to work.) Yes also generates a database trace file; if you need help with an error that occurs while the Receiving Transaction Processor runs, Oracle Support Services may ask you for this trace file. This profile option should be set to Yes only while debugging the Receiving Open Interface or for generating a trace file. The Receiving Open Interface validates receipt transactions from other systems and uses the Receiving Transaction Processor to import the validated data into Purchasing. See the *Oracle Manufacturing, Distribution, Sales and Service Open Interfaces Manual, Release 11i*.

### PO: Set Debug Concurrent ON

This profile option is used, *usually by technical support staff only*, for finding problems

with Requisition Import.

**Caution:** For performance reasons, it is very important that this profile option *always* be set to No, unless you are instructed otherwise by Oracle for debugging purposes.

### **PO: Set Debug Workflow ON**

This profile option is used, *usually by technical support staff only*, for finding problems with Purchasing workflow processes.

**Caution:** For performance reasons, it is very important that this profile option *always* be set to No, unless you are instructed otherwise by Oracle for debugging purposes.

### **PO: Write Server Output to File**

Yes or No indicates whether log details are written to a flat file rather than to the standard concurrent manager details log viewable through the View Log button in the Submit Request window when running the Purchasing Documents Open Interface program.

Yes means log details are written to a flat file. No means log details are written to the concurrent manager log screen, which can cause overflow problems for large catalogs. Leaving this profile option blank means log details are not written at all, which improves performance.

You need to consider a value for this profile option only when debugging a price/sales catalog submission from your supplier through the Purchasing Documents Open Interface.

See the *Oracle Manufacturing APIs and Open Interfaces Manual, Release 11i*.

### **RCV: Debug Mode**

If set to Yes, and RCV: Processing Mode set to Immediate or Batch, debug messages will be printed to the concurrent log file.

## **Deployment Category**

The table below lists the profile options that control Deployment.

### Deployment Profile Options

Profile Option	Default	User Access	System Administration: Site	System Administration: Application	System Administration: Responsibility	System Administration: User
PO: Approval Timeout Value,	No Default	No Access	Update	No Access	No Access	No Access
PO: Cache Time To Live,	No Default	Update	Update	No Access	No Access	No Access
PO: Contracts Enabled,	No Default	No Access	Update	No Access	No Access	No Access
PO: Custom Measure Precedence,	No Default	Update	Update	No Access	No Access	No Access
PO: Enable Services Procurement,	No	Update	Update	Update	Update	Update
PO: MFG Organization ID,	No Default	No Access	Update	No Access	No Access	No Access
PO: View receipt mode,	No Default	No Access	No Access	No Access	No Access	No Access
PO:Workflow Processing Mode,	<i>Background</i>	Update	Update	Update	Update	Update
RCV: Processing Mode,	<i>Online</i>	Update	Update	Update	Update	Update

#### PO: Approval Timeout Value

Indicates Approval Timeout to wait for the Doc Manager to return. Value is in seconds.

#### PO: Cache Time To Live

Specifies the duration that data is cached in memory. A value of 0 disables caching. Value is in minutes.

**PO: Contracts Enabled**

Oracle Procurement Contracts: Yes indicates that Oracle Procurement Contracts is installed, implemented, and active in Oracle Purchasing.

**PO: Custom Measure Precedence**

This profile is used by Oracle Purchasing Intelligence. It determines the survey matching precedence.

**PO: Enable Services Procurement**

Oracle Services Procurement: Yes indicates that Services Procurement is installed, implemented, and active in Oracle Purchasing.

**PO: MFG Organization ID**

Latin America Localization: Indicates Inventory Organization used for Ledger.

**PO: View receipt mode**

OBSOLETE

**PO: Workflow Processing Mode**

Affects the performance of the Purchasing approval workflow processes:

- *Online*: Completes an entire approval workflow process before letting you proceed to the next activity, but provides you with an updated Status (for purchase orders) as soon as it finishes.
- *Background*: Enables you to proceed to the next activity while the approval process completes in the background.

Whichever option you choose, you can always view the current status of a requisition or purchase order through the Requisitions Summary or Purchase Orders Summary windows.

The default value is *Background*.

**Note:** When this profile option is set to *Background*, you must start the Workflow Background Engine, which you access through the System Administrator responsibility. It is recommended that you set this process to run frequently, if you are using it for *Background* mode approvals. See: To Schedule Background Engines, *Oracle Workflow Guide*.

## RCV: Processing Mode

Indicates the processing mode used after you save your work for receiving transactions:

- *Batch*: The transaction goes to the interface table, where it will be picked up the next time the Receiving Transaction Processor runs.
- *Immediate*: The transaction goes to the interface table, and the Receiving Transaction Processor is called for the group of transactions that you entered since you last saved your work.
- *On-line*: The Receiving Transaction Processor is called directly.

## Document Builder Security Category

The table below lists the Document Builder Security profile options.

### Document Builder Security Profile Options

Profile Option	Default	User Access	System Administration: Site	System Administration: Application	System Administration: Responsibility	System Administration: User
PO: Allow Autocreation of Oracle Sourcing Documents,	No	View Only	Update	View Only	View Only	View Only
PO: Allow Buyer Override in Autocreate Find,	Yes	Update	Update	Update	Update	Update
PO: Allow Category Override in Autocreate Find,	Yes	Update	Update	Update	Update	Update

## Document Builder UI Category

The table below lists the Document Builder UI profile options.

### Document Builder UI Profile Options

Profile Option	Default	User Access	System Administration: Site	System Administration: Application	System Administration: Responsibility	System Administration: User
PO: Auto Apply Default Contract Template,	No Default	Update	Update	Update	Update	Update
PO: Default Requisition Grouping,	No Default	Update	Update	Update	Update	Update
PO: Display the Autocreated Document,	Yes	Update	Update	Update	Update	Update
PO: Document Builder Default Document Type,	No Default	Update	Update	Update	Update	Update

### PO: Default Requisition Grouping

Indicates the default grouping method used when aggregating requisition demand to create a new document. Values are Default or Requisition.

- *Default* - combine lines from multiple requisitions to create a single line if possible.
- *Requisition* - create a separate line for each requisition line.

### PO: Document Builder Default Document Type

This profile option specifies the default target document type that is defaulted into the document builder region within the demand workbench. Values are: Add to PO, New Auction, New PO, New RFQ.

### Document Security Category

The table below lists the profile options that control Purchasing Document Security.

## Document Security Profile Options

Profile Option	Default	User Access	System Administration: Site	System Administration: Application	System Administration: Responsibility	System Administration: User
PO: Allow Auto-generate Sourcing Rules,	No	View Only	Update	View Only	View Only	View Only
PO: Allow Rate Override For User Rate Type,	No	View Only	Update	Update	Update	Update
PO: Allow Retroactive Pricing of POs,	No Default	View Only	Update	Update	Update	View Only
PO: Change Supplier Site,	No Default	View Only	Update	Update	Update	View Only
PO: Enable Direct Delivery To Shop Floor,	No	Update	Update	Update	Update	Update
PO: Legal Requisition Type,	Both	View Only	Update	Update	Update	View Only
RCV: Allow routing override,	No	Update	Update	Update	Update	Update

### PO: Allow Auto-generate Sourcing Rules

Create Only indicates whether the buyer can create new sourcing rules, sourcing assignments, and approved supplier list entries while approving a blanket purchase agreement. Create and Update enables the buyer to update sourcing rules and assignments as well as create new sourcing rules. The default is None.

### PO: Allow Rate Override for User Rate Type

Yes or No indicates whether the Rate in the Currency tabbed region of the Receipts window can be changed. Even if the Rate Type is User, you cannot change the Rate if this profile option is set to No. This profile option affects the Rate on the receipt only, not in the Currency window of a purchase order, RFQ, or quotation. (In the Currency window, you can modify the Rate if the Rate Type is User.)



### **PO: Allow Retroactive Pricing of POs**

Used to determine if blanket releases and standard purchase orders can be mass updated with retroactive price change(s) entered on their corresponding blanket agreement.

- *Never*: If this profile is not set or is set to Never, the Apply Retroactive Price Update to Existing PO/Releases checkbox will be disabled in the Blanket Agreement Approval window and the Mass Update Price on Open Releases concurrent program will not update any blanket releases or global agreement sourced standard purchase orders.
- *Open Releases Only*: The Mass Update Price on Open Releases concurrent program will only process releases which have no receipts (if accruing at time of receipt) or invoices matched to them.
- *All Releases*: Perform retroactive pricing on all releases (including those which have accrued receipts or invoices), if the archive mode for that operating unit is set to Approve.

### **PO: Change Supplier Site**

Yes or No indicates whether users can change the supplier site on approved purchase orders.

### **PO: Enable Direct Delivery to Shop Floor**

If Enterprise Asset Management has been implemented and this profile is set to Yes, Outside Services items can be delivered directly to the shop floor. See the *Oracle Enterprise Asset Management User's Guide*.

### **PO: Legal Requisition Type**

Indicates whether users can enter internal requisitions sourced from stock by means of an internal sales order, purchase requisitions sourced from a purchase order, or both types. Available values are Both, Internal, and Purchase.

### **RCV: Allow routing override**

Yes or No indicates whether the destination type assigned during requisition or purchase order entry can be overridden at receipt time.

### **Encumbrance Category**

The table below lists the Encumbrance profile options for Oracle Purchasing.

### Encumbrance Profile Options

Profile Option	Default	User Access	System Administration: Site	System Administration: Application	System Administration: Responsibility	System Administration: User
PO: AutoCreate GL Date Option,	<i>AutoCreate Date</i>	Update	Update	Update	Update	Update
PO:Override Funds Reservation,	No Default	Update	Update	Update	Update	Update
PO:Use Document GL Date to Unreserve,	No	View Only	Update	Update	Update	No Access

#### PO: Override Funds Reservation

Indicates whether the GL Funds Override capability should be utilized. If set to Yes and the Oracle General Ledger (GL) setup allows it, absolute funds checking will succeed even if funds are exceeded, up to the amount limit defined for a given account.

This profile determines the default value for funds reservation in the Approval window and the behavior for funds reservation in Oracle Purchasing workflows.

#### PO: Use Document GL date to Unreserve

Yes or No indicates whether the GL date of the document is used for encumbrance reversal actions that do not support entry of a GL date (Reject/Return) and as a default for actions that do allow entry of a date (Cancel/Final Close/Unreserve).

### Enterprise Asset Management Setup Category

The table below lists the Oracle Purchasing profile options for Enterprise Asset Management (EAM) setup.

### **Enterprise Asset Management Setup Profile Options**

<b>Profile Option</b>	<b>Default</b>	<b>User Access</b>	<b>System Administration: Site</b>	<b>System Administration: Application</b>	<b>System Administration: Responsibility</b>	<b>System Administration: User</b>
PO: Enable Direct Delivery To Shop Floor,	No	Update	Update	Update	Update	Update

### **iProcurement Setup Category**

The table below lists the iProcurement Setup profile options in Oracle Purchasing.

#### ***iProcurement Setup Profile Options***

<b>Profile Option</b>	<b>Default</b>	<b>User Access</b>	<b>System Administration: Site</b>	<b>System Administration: Application</b>	<b>System Administration: Responsibility</b>	<b>System Administration: User</b>
PO: Use P-Cards in Purchasing,	No	View Only	Update	Update	Update	Update

### **Notifications Category**

The table below lists the profile options that control Oracle Purchasing Notifications.

#### ***Notifications Profile Options***

<b>Profile Option</b>	<b>Default</b>	<b>User Access</b>	<b>System Administration: Site</b>	<b>System Administration: Application</b>	<b>System Administration: Responsibility</b>	<b>System Administration: User</b>
PO: Amount Billed Threshold Percentage,	No Default	View Only	Update	View Only	View Only	View Only

Profile Option	Default	User Access	System Administration: Site	System Administration: Application	System Administration: Responsibility	System Administration: User
PO: Contractor Assignment Completion Warning Delay,	No Default	View Only	Update	View Only	View Only	View Only

### PO: Amount Billed Threshold Percentage

Oracle Services Procurement: Indicates the amount above which the amount billed exceeded threshold notification will be sent to the requester.

### PO: Contractor Assignment Completion Warning Delay

Oracle Services Procurement: Yes indicates that the contractor assignment completion notification is sent to the requester when the assignment is complete.

## Notifications UI Category

The table below lists the profile options that control the Notifications UI.

### Notifications UI Profile Options

Profile Option	Default	User Access	System Administration: Site	System Administration: Application	System Administration: Responsibility	System Administration: User
PO: Notification Lines Display Limit,	No Default	Update	Update	Update	Update	Update

### PO: Notification Lines Display Limit

Indicates the number of purchase order or release lines to be displayed in approval notifications. Oracle recommends a maximum of 30 lines.

## PO Communication Category

The table below lists the profile options that controls communication of purchasing documents with suppliers.

### **PO Communication Profile Options**

<b>Profile Option</b>	<b>Default</b>	<b>User Access</b>	<b>System Administration: Site</b>	<b>System Administration: Application</b>	<b>System Administration: Responsibility</b>	<b>System Administration: User</b>
PO: cXML From Domain,	No Default	View Only	Update	View Only	View Only	View Only
PO: cXML From Identity,	No Default	View Only	Update	View Only	View Only	View Only
PO:Fax Output Directory for the PO Document,	No Default	Update	Update	Update	Update	Update
PO: Generate Amendment Documents,	No	Update	Update	Update	Update	Update
PO: In File Path,	No Default	View Only	Update	No Access	Update	Update
PO: Secondary Email address,	No Default	Update	Update	No Access	No Access	Update
PO: Terms and Conditions filename,	No Default	View Only	Update	No Access	Update	No Access

#### **PO: cXML From Domain**

Indicates buyer's domain.

#### **PO: cXML From Identity**

Indicates buyer's identity on the cXML From Domain.

#### **PO: Fax Output Directory for the PO Document**

The operating system directory name where the document publisher will store the generated purchase order PDF file for faxing.

#### **PO: Generate Amendment Documents**

Oracle Procurement Contracts: Yes displays the amendments made to the contract terms and conditions in a separate section in the purchase order PDF. The purchase

order PDF cover page then displays summary of changes entered by the user at the time of submitting the purchase order for approval.

**PO: In File Path**

For e-mailed purchase orders this indicates the absolute path of the directory where the optional terms and conditions file is stored. This directory must also be specified in the UTL\_FILE parameter in the INIT.ORA file.

**PO: Secondary E-mail Address**

When using e-mail purchase orders (PO), enter an e-mail address to send a copy of the e-mail PO to someone in your company. If it is necessary to resend the e-mail, you could log into this secondary e-mail account and resend it from there.

**PO: Terms and Conditions File Name**

For e-mailed purchase orders this profile identifies the name of the optional terms and conditions file. This text file needs to be placed in one of the directories specified in the UTL\_FILE parameter in the INIT.ORA file and the file path indicated by the profile PO: In File Path.

**PO/Releases/Requisitions UI Category**

The table below lists the profile options that control the PO/Releases/Requisitions UI.

***PO/Releases/Requisitions UI Profile Options***

<b>Profile Option</b>	<b>Default</b>	<b>User Access</b>	<b>System Administration: Site</b>	<b>System Administration: Application</b>	<b>System Administration: Responsibility</b>	<b>System Administration: User</b>
PO: Auto Apply Default Contract Template,	No Default	Update	Update	Update	Update	Update
PO: Check open periods,	No Default	Update	Update	Update	Update	Update
PO: Default Need-By Time,	No Default	Update	Update	Update	Update	Update
PO: Display VMI Warning,	Yes	No Access	Update	No Access	No Access	No Access

Profile Option	Default	User Access	System Administration: Site	System Administration: Application	System Administration: Responsibility	System Administration: User
PO: Use P-Cards in Purchasing,	No	View Only	Update	Update	Update	Update

### PO: Check Open Periods

Yes indicates that the need by date and the promise by date must be in an open Purchasing period when entering purchase orders. Any other setting provides no validation against Purchasing periods.

### PO: Default Need-By Time

Indicates the time used to default for the entry of need-by date when a requisition, purchase order, or release is created.

### PO: Display VMI Warning

Yes or No indicates whether a warning will be displayed when Vendor Managed Inventory (VMI) item is being placed on a Purchasing document. Default is Yes, the warning will be displayed.

### PO: Use P-Cards in Purchasing

Set this profile option to Yes if you use procurement card-also known as P-Card or corporate credit card-numbers on requisitions in Oracle iProcurement. Set this profile option to Yes to display the procurement card number in the Purchase Orders, Releases, and Purchase Order Headers summary windows.

Set this profile option to No if you do not have Oracle iProcurement installed or do not want to display the procurement card field to buyers. Purchasing windows can physically display the procurement card field even if Oracle iProcurement is not installed and procurement cards aren't used. Therefore, set this profile option to No if you are not using procurement cards.

## Procurement Contracts Setup Category

The table below lists the Procurement Contracts Setup profile options in Oracle Purchasing.

### Procurement Contracts Setup Profile Options

Profile Option	Default	User Access	System Administration: Site	System Administration: Application	System Administration: Responsibility	System Administration: User
PO: Allow Referencing CPA Under Amendment, page C-28	No		Update			User
PO: Auto Apply Default Contract Template,	No Default	Update	Update	Update	Update	Update
PO: Contracts Enabled,	No Default	No Access	Update	No Access	No Access	No Access
PO: Generate Amendment Documents,	No	Update	Update	Update	Update	Update

### Allow Referencing CPA Under Amendment

If this profile option is set to Yes, then GCPA reference on Requisitions or Standard Purchase Orders (both in Oracle iProcurement and Oracle Purchasing) is allowed during GCPA amendment, provided the GCPA has been approved once referencing the CPAs in Amendment state.

### Receiving Category

The table below lists the profile options that controls Receiving functionality in Oracle Purchasing.

#### Receiving Profile Options

Profile Option	Default	User Access	System Administration: Site	System Administration: Application	System Administration: Responsibility	System Administration: User
PO: Automatically Deliver Drop Ship ASNs,	No Default	Update	Update	Update	Update	Update



Profile Option	Default	User Access	System Administration: Site	System Administration: Application	System Administration: Responsibility	System Administration: User
RCV: Default Include Closed PO Option,	No	Update	Update	Update	Update	Update
RCV: Fail All ASN Lines if One Line Fails,	No	View Only	Update	Update	Update	No Access
RCV: Print Receipt Traveler,	No	Update	Update	Update	Update	Update

### PO: Automatically Deliver Drop Ship ASNs

Yes indicates that you want Oracle Purchasing to automatically perform a receipt and deliver action for drop ship ASNs. See: Advance Shipment Notices (ASNs), page 9-15.

### RCV: Default Include Closed PO Option

If it is set to Yes, a search in the Enter Receipts window and the Receiving Transactions window automatically select the Include Closed POs checkbox. Your search results will then include closed orders.

The Receiving Open Interface (including ASN) will allow a receipt against orders with the status of Closed for Receiving if this profile is set to Yes. Any setting other than Yes prevents receiving against orders using the Receiving Open Interface with the status of Closed for Receiving.

### RCV: Fail All ASN Lines if One Line Fails

If you choose Yes, you can reject an entire Advance Shipment Notice (ASN) if any ASN line fails validation or processing. If you choose No, then you can accept an ASN if at least one ASN line is successful.

### RCV: Print Receipt Traveler

Yes or No indicates whether Purchasing automatically prints the receipt traveler when you perform a receipt or a receiving transaction, and when you match unordered receipts. You can always print receipt travelers from the Submit Requests window.

## Requisition Import Category

The table below lists the profile options that control Requisition Import.

### Requisition Import Profile Options

Profile Option	Default	User Access	System Administration: Site	System Administration: Application	System Administration: Responsibility	System Administration: User
PO: Archive Catalog on Approval,	No	Update	Update	Update	Update	Update
PO: Release During ReqImport,	No	Update	Update	Update	Update	Update

### PO: Release During ReqImport

Yes or No indicates whether Purchasing can automatically create releases during the Requisition Import process.

### Self-Billing Category

The table below lists the Self-Billing profile options.

### Self-Billing Profile Options

Profile Option	Default	User Access	System Administration: Site	System Administration: Application	System Administration: Responsibility	System Administration: User
PO: ERS Aging Period,	0	View Only	Update	Update	Update	No Access
PO: ERS Invoice Number Prefix,	ERS-	View Only	Update	Update	Update	No Access

### PO: ERS Aging Period

The value in this profile option indicates the number of days between the receipt date and the Payment on Receipt automatic invoice creation date. For example, a value of 2 means that Payment on Receipt creates invoices only for receipts that are 2 or more days old. Any corrections or returns you make against a receipt during that 2-day period are included on the Payment on Receipt invoice.

## PO: ERS Invoice Number Prefix

'ERS-' is the prefix that appears before all invoices that you create automatically using Payment on Receipt. This profile option allows you to change this prefix. For example, shortening this prefix allows extra spaces for longer packing slip or receipt numbers.

## Services Procurement Setup Category

The table below lists the Services Procurement Setup profile options in Oracle Purchasing.

### *Services Procurement Setup Profile Options*

Profile Option	Default	User Access	System Administration: Site	System Administration: Application	System Administration: Responsibility	System Administration: User
PO: Amount Billed Threshold Percentage,	No Default	View Only	Update	View Only	View Only	View Only
PO: Contractor Assignment Completion Warning Delay,	No Default	View Only	Update	View Only	View Only	View Only
PO: Enable Services Procurement,	No	Update	Update	Update	Update	Update
PO: UOM Class for Temp Labor Services,	No Default	Update	Update	Update	Update	Update

## PO: UOM Class for Temp Labor Services

Oracle Services Procurement: For a rate based temp labor line type, entry of unit of measure (UOM) is restricted to those in this UOM class.

## Sourcing Setup Category

The table below lists the profile options in Oracle Purchasing used to control document sourcing features.

### Sourcing Setup Profile Options

Profile Option	Default	User Access	System Administration: Site	System Administration: Application	System Administration: Responsibility	System Administration: User
PO: Allow Autocreation of Oracle Sourcing Documents,	No	View Only	Update	View Only	View Only	No Access
PO: Display the Autocreated Document,	Yes	Update	Update	Update	Update	Update

### Supplier Item Catalog Forms UI Category

The table below lists the profile options that controls the Oracle Purchasing Supplier Item Catalog Forms UI.

#### Supplier Item Catalog Forms UI Profile Options

Profile Option	Default	User Access	System Administration: Site	System Administration: Application	System Administration: Responsibility	System Administration: User
PO: Default Supplier Item Catalog Option,	Negotiated Sources	Update	Update	Update	Update	Update
PO: Item Cross Reference Warning,	Disposition	View Only	Update	Update	Update	No Access

#### PO: Default Supplier Item Catalog Option

Indicates the *default* source tabbed region in the supplier item catalog: Negotiated Sources, Prior Purchases, Sourcing Rules, or Requisition Templates.

#### PO: Item Cross Reference Warning

Indicates the Item Cross Reference Type that you want to use as a disposition warning message for requisitions.

## Pricing Transparency Profile Options

The following are profile options are required for Pricing Transparency:

### Application level:

- QP: Licensed for Product --Purchasing
- QP: Pricing Perspective Request Type-- Purchase Order
- QP: QP: Pricing Transaction Entity --Procurement
- QP: Source System Code -- Oracle Purchasing
- PO: Price Enhancement --Yes

**Note:** You need to enable Pricing Enhanced checkbox for the Document style using the PO: Price Enhancement profile option.

### System / Responsibility Level:

QP: Item validation Organization

### System Level:

QP: Security Control

**Note:** Refer to the Oracle Advanced Pricing User's Guide for more information on the aforementioned profile options.



---

## Function Security for Purchasing

### Function Security for Purchasing

Function Security defines the specific access to individual forms and the business functions of each form. A form can have several business functions associated with it, however some forms and functions may not be appropriate for each user. Purchasing provides the following basic responsibilities: Requestor, Receiver, Buyer, and PO Superuser. You can create new responsibilities or modify the existing ones. A responsibility defines an application user's current privileges while working with Oracle Applications.

You can use Function Security to control access to forms (windows) and functions within windows, thereby tailoring each responsibility to the needs of an individual user. However, if you grant a user access to a window, all the functions within that window are automatically included in the user's access. If you want the user to have access to the window but not to all the window's functions, you must exclude access to each function individually.

For example, if you want a user to be able to view the Purchase Orders Summary window but not have access to the functions associated with the New Release, New PO, and Open buttons within that window, you would grant access to the Purchase Orders Summary window but disable access to the New Release, New PO, and Open functions.

The following table lists examples of functions available in common Oracle Purchasing windows.

<b>Window</b>	<b>Function</b>	<b>Requestor</b>	<b>Receiver</b>	<b>Buyer</b>	<b>PO Superuser</b>
<b>Requisition Summary Tools Menu</b>	<i>View Lines</i> Distributions Purchase Orders Sales Orders Action History Preferences Control	X		X	X
<b>Requisition Summary window</b>	New	X		X	X
<b>Purchase Order Summary window</b>	New Release New PO <i>Open Buttons</i>			X	X
<b>Purchase Order Summary Inquire Menu</b>	<i>View Lines</i> Shipments Distributions Action History Invoices Receipts	X	X	X	X
<b>Purchase Order Summary Tools Menu</b>	Acceptances Control Preferences Manage Global Agreements			X	X
<b>Supplier Summary window</b>	Open			View Only	X
<b>Supplier Summary window</b>	New				X



<b>Window</b>	<b>Function</b>	<b>Requestor</b>	<b>Receiver</b>	<b>Buyer</b>	<b>PO Superuser</b>
<b>Exceeded Price Tolerances window</b>	Accept/Reject	View Only	View Only	View Only	View Only

## Related Topics

Overview of Function Security, *Oracle Applications System Administrator's Guide*

Forms and Subfunctions, *Oracle Applications System Administrator's Guide*

Overview of Oracle Application Security, *Oracle Applications System Administrator's Guide*



---

# Procurement Workflows

## Overview of Procurement Workflows

Purchasing uses Oracle Workflow technology to handle requisition and purchase order approvals, automatic creation of purchase orders and releases, purchase order changes (specifically, any additional approvals those changes require), notifications, and receipt confirmation. Workflow is an underlying technology that automates these procurement activities. Workflow comes with a graphical user interface that enables you to modify these procurement workflow processes to suit your business needs.

Purchasing comes with the following workflows:

- **PO Account Generator** workflow for automatically generating accrual, budget, charge, and variance accounts on purchase orders and releases. See: *Using the Account Generator in Oracle Purchasing*, page E-6.
- **PO Requisition Account Generator** workflow for automatically generating accrual, budget, charge, and variance accounts on requisitions. See: *Using the Account Generator in Oracle Purchasing*, page E-6.
- **PO Requisition Approval** workflow for approving requisitions. See: *Requisition Approval Workflow*, page E-50.
- **PO Approval** workflow for approving purchase orders. See: *Purchase Order Approval Workflow*, page E-89.
- **Change Order** workflow for controlling which changes to purchase orders require a manual reapproval and which are automatically reapproved; the change order workflow is really a group of workflow processes contained in the PO Approval workflow. See: *Workflow Processes for Approving Change Orders*, page E-133.
- **PO Create Documents** workflow for automatically creating purchase orders and releases. See: *Workflow for Creating Purchase Orders and Releases*, page E-161.

- **PO Confirm Receipts** workflow for sending receipt notifications to requesters or buyers notifying them that they should have received their order. Confirm Receipts Workflow, page E-184.
- **PO Send Notifications for Purchasing Documents** workflow for looking for documents that are incomplete, rejected, or in need of reapproval, and sending notifications to the appropriate people of the document's status. See: Send Notifications Workflow, page E-195.
- **PO Catalog Price Tolerance Exceeded Notifications** workflow for sending a notification to the buyer when the price/sales catalog information sent through the Purchasing Documents Open Interface includes price increases that exceed a price tolerance that you set. Price/Sales Catalog Notification Workflow, page E-206.
- **Procurement Processes** workflow for guiding you through procurement processes by launching the appropriate windows in Purchasing. See: Process Navigator Workflows, page E-216.
- **PO Approval Error** workflow for troubleshooting errors that occur when using the PO Approval workflow. See: PO Approval Error Workflow, page E-217

## Related Topics

Customization Guidelines, page E-2

## Customization Guidelines

Following are some of the important guidelines you should follow when customizing any workflow in Purchasing.

## Access Levels

In the Workflow Builder, some of activities in the procurement workflows are locked, or protected against customization, and some are unlocked, or available for modification to suit your business needs. You should not change your access level to modify locked activities.

For more, important information on access levels, see *Overview of Workflow Access Protection*, *Oracle Workflow Developer's Guide* and *Allowing Access to an Object*, *Oracle Workflow Administrator's Guide*.

## Backups and Testing

Always make a backup and test your customized workflow on a test database before uploading it to your actual database. The sections in this documentation describing each workflow in Purchasing let you know if you should modify the default workflow

that Purchasing provides or if you can create a new one. For more, important information on saving, backing up, and uploading customized workflows, see the *Oracle Workflow Developer's Guide*.

## Upgrade Support

Future upgrades of Purchasing can include upgrades to the Purchasing workflows. As you customize workflows, think about whether to protect your customizations against future upgrades. For complete information, see the *Oracle Workflow Developer's Guide*.

## Workflow Monitor

You can use the Workflow Monitor to monitor a workflow's progress. See: Overview of Workflow Monitoring, *Oracle Workflow User's Guide*.

## Guidelines

It is important to use these guidelines in conjunction with information in the Oracle Workflow documentation. In addition, refer to the documentation for each workflow in Oracle Purchasing for a list of activities you can and cannot customize, and other recommendations particular to the workflow. You can also use the Item Type Definitions Web page to extract detailed information about each activity in a workflow. See: Item Type Definitions, *Oracle Workflow Developer's Guide*.

See also: Oracle Workflow Support Policy, *Oracle Workflow Developer's Guide*.

## Attributes

You can modify only the attributes listed as customizable in the documentation for each Purchasing workflow.

## Processes

If you modify a customizable process, it is essential that the basic flow remain intact to maintain data integrity in the database. For example, you should not remove or bypass the function activity Is Document Complete? in the Verify Document subprocess in the approval workflows because this may allow incomplete data to be inserted into the database tables. However, you could add additional checks (processes or function activities) before allowing data to be inserted into the tables.

If you modify a customizable process, either by replacing a portion of its flow or by adding additional function activities, keep in mind:

- Attributes that are set by default function activities in the default processes must also be set if you replace the default function activities with ones of your own. If a function activity uses a SetItemAttr statement, then that function activity is setting an attribute to be used by another function activity later. Therefore, your new

function activity must do the same. You should also preserve SetItemUserKey and SetItemOwner statements, if any. (Depending on your customizations, you may also want to preserve GetItemAttr statements.)

- Any database state maintained by the default process must also be maintained by the processes you customize. If a function activity in a process uses an Update or Insert Into statement, then that function activity is updating or inserting rows in the database. Therefore, your new function activity must maintain the same database state.

To get a list of the workflow function activities that use SetItemAttr, GetItemAttr, SetItemUserKey, SetItemOwner, Insert Into, or Update statements, run the PL/SQL script powfcust.sql.

**Important:** This script gives you an idea of the impact of removing a function activity; however, before you customize a process, always conduct your own analysis of the impact.

**To run powfcust.sql:**

1. Change to the directory where the PL/SQL-stored procedures are kept:

```
cd $PO_TOP/sql
```

2. At the SQL prompt, start the following script:

```
@powfcust.sql
```

3. When prompted, enter the internal name for the workflow item type for which you want to run the script, or enter ALL to run the script for all of the Purchasing workflows.

The internal workflow names for Purchasing are as follows:

---

<b>Workflow</b>	<b>Internal Name</b>
PO Account Generator	POWFPOAG
PO Requisition Account Generator	POWFRQAG
PO Approval	POAPPRV
PO Requisition Approval	REQAPPRV
PO Create Documents	CREATEPO

---

<b>Workflow</b>	<b>Internal Name</b>
PO Confirm Receipts	PORCPT
PO Send Notifications for Purchasing Documents	APVRMDER
PO Catalog Price Tolerance Exceeded Notifications	POPRICAT

The script displays every function activity in the workflow that uses a SetItemAttr, GetItemAttr, SetItemUserKey, SetItemOwner, Insert Into, or Update statement.

Recall that this script gives you an idea of the impact of removing a function activity. Before you customize a process, always conduct your own analysis of the impact.

## Notifications

If a notification has a reply code, make sure that the Result Type of your customized notification matches the transitions in the workflow diagram. See: To Create a Notification Activity, *Oracle Workflow Developer's Guide*. See also: Message Result, *Oracle Workflow Developer's Guide* and To Create a Message, *Oracle Workflow Developer's Guide*.

## Function Activities

Usually, you cannot modify a function activity, but can replace it with one of your own, unless the documentation for the workflow advises against removing default function activities.

When you replace a function activity, you are effectively modifying the process in which it is contained. If you substitute default function activities in a process with function activities that you create, you must remember the following:

- The result type of your new function activity must match the result type of the default activity. That is, the Result Type of the function activity in the Workflow Builder—for example, a Result Type of Yes/No—needs to match the result type that you specify in that function activity's corresponding PL/SQL procedure. In addition, if you have, for example, two results (such as Yes and No) in your function activity and corresponding PL/SQL procedure, make sure that there are two corresponding transitions in the workflow diagram (one for Yes and one for No). If you alter the result types and transitions in a process, be careful that you aren't deleting or bypassing any special transitions or checks.
- Just as in the section **Processes** above, any attributes that were set by the default

function activity must also be set by your customized function activity.

- Just as in the section **Processes** above, any database state maintained by the default function activity must also be maintained by the customized function activity.

## Lookup Types

If you change a customizable lookup type, be sure that all activities that use the lookup type allow for the change. For example, if you change a lookup type from Yes/No to something else, the activities that use that lookup type should also change their Result Type from Yes/No to whatever new lookup type you created. See: *Lookup Types, Oracle Workflow Developer's Guide*.

## Related Topics

Using the Account Generator in Oracle Purchasing, page E-6

Purchase Order Approval Workflow, page E-89

Requisition Approval Workflow, page E-50

Workflow Processes for Approving Change Orders, page E-133

Workflow for Creating Purchase Orders and Releases, page E-161

Confirm Receipts Workflow, page E-184

Send Notifications Workflow, page E-195

Price/Sales Catalog Notification Workflow, page E-206

Using the Workflow Monitor for the Account Generator, page E-49

Using the Workflow Monitor for the PO Create Documents Workflow, page E-182

Process Navigator Workflows, page E-216

## Using the Account Generator in Oracle Purchasing

This essay describes how to use and customize the default Account Generator process in Oracle Purchasing.

The Account Generator in Oracle Purchasing utilizes Oracle Workflow. You can view and customize Account Generator processes through the Oracle Workflow Builder. You can also monitor account generation through the Oracle Workflow Monitor. See: *Oracle Workflow User's Guide*.

All purchase orders, requisitions, and releases require accounting distributions. Oracle Purchasing automatically builds a charge, budget (if using budgetary control), accrual, and variance account for each document distribution.

Oracle Purchasing provides you with the features you need to:



- Improve accuracy and speed document generation by automatically constructing accounting distributions.
- Relieve buyers, requestors, and document preparers from the responsibility of specifying which accounts should be charged for their purchases.
- Customize Account Generator account construction rules to match your business rules.
- For public sector installations, perform fund accounting.

See also: Overview of Account Generator, *Oracle Applications Flexfields Guide*.

## Decide How to Use the Account Generator

Use the following sections to help you evaluate whether the default Account Generator process meets your accounting requirements.

This decision determines which setup steps your implementation team needs to perform.

### Decide How to Use the Account Generator

In Release 10, several Oracle Applications products used FlexBuilder to derive account code combinations for certain account transactions. In Release 11, FlexBuilder is replaced by the Account Generator to provide implementation teams with even greater flexibility and a better user interface with Oracle Workflow.

If you customized FlexBuilder in a previous release to generate account combinations, you can use the Generate Accounts Using FlexBuilder Rules process to replicate your FlexBuilder setup automatically, without changing any of your predefined FlexBuilder Rules, and without customizing the Account Generator. To build accounts, the Generate Accounts Using FlexBuilder Rules process calls the appropriate functions that were generated during your upgrade

**Note:** If you used FlexBuilder in Release 10 but did not customize the default configuration, you can use the default Account Generator process in Release 11, which gives you the same result as the default assignments in FlexBuilder.

If you are implementing Oracle Purchasing for the first time, you need to review how Purchasing uses the Account Generator to build Accounting Flexfield code combinations. See: What the Account Generator Does in Oracle Purchasing, page E-9, below. Consider whether the default Account Generator process is appropriate for each ledger that uses a unique Accounting Flexfield structure. For each structure and ledger, you can choose one of the following:

- Use the default Account Generator processes:

- Generate Default Accrual Account
  - Generate Default Budget Account
  - Generate Default Charge Account
  - Generate Default Variance Account
  - Generate Default Destination Charge Account
  - Generate Default Destination Variance Account
- Customize the default Account Generator processes

No setup steps are required to use the default. The default processes can also be updated later as your needs change.

### **Prerequisites to Using the Account Generator**

Before using the Account Generator on a production database in Oracle Purchasing to build accounts for purchase order, release, and requisition distributions, you must complete the following steps:

**Important:** These steps need to be performed for each operating unit.

1. Define your Accounting Flexfield structure for each ledger.
2. Define flexfield segment values and validation rules.
3. Set up Oracle Workflow.
4. Choose whether you want to use the default Account Generator processes, or if you need to customize them to meet your accounting needs.
5. Then do one of the following for each ledger:
  - Choose to use the default Account Generator processes.
  - Customize the default Account Generator processes, test your customizations, and choose the processes for a flexfield structure, if necessary.

### **Related Topics**

The Default Account Generator Processes for Oracle Purchasing, page E-30

Customizing the Account Generator for Oracle Purchasing, page E-24

## What the Account Generator Does in Oracle Purchasing

The default Account Generator processes in Oracle Purchasing build a charge, budget, accrual, and variance account for each purchase order, release, and requisition distribution based on the distribution's Expense, Inventory, or Shop Floor destination type. Oracle Purchasing always builds these accounts using the Account Generator; you cannot disable this feature.

If you utilize the centralized procurement functionality, the Account Generator will also create two new accounts to record accounting transactions between the procuring organization and the destination organization: the destination charge account and the destination variance account. These accounts will be created and used only when the destination organization is in a different operating unit than the Procuring organization, and there is a transaction flow defined between the two organizations. (Note that if the two operating units are in different sets of books, there must be a transaction flow defined.) For example: In the centralized procurement scenario a user may create a purchase order in one operating unit, but require shipment to a different operating unit. In this case, there will be an accounting transaction (created at the time of receipt of goods) to record the transfer of ownership between the two organizations (operating units). If these accounts are not required they will be not be built.

For Inventory charge account construction, the Account Generator further distinguishes between asset and expense purchases based on the item and subinventory that you provide for the distribution. If you select an expense item, the Account Generator disregards the subinventory and builds an expense charge account. If you select an asset item, the Account Generator evaluates the subinventory to decide whether to build an expense or asset charge account.

**Note:** You classify a subinventory as expense or asset by selecting the Asset Subinventory check box in the Oracle Inventory Subinventories window. You classify an item as expense or asset by selecting the Inventory Asset Value check box in the Costing section of the Master Item window. (This window is accessible through Inventory or Purchasing.)

When the Account Generator locates a source account based on the distribution destination type, it copies complete code combinations (full Accounting Flexfields) from designated fields to destination Accounting Flexfields. The default Oracle Purchasing processes do not build individual flexfield segments.

For example, to populate the Accrual account for distributions with an Expense destination type, the Account Generator locates the Expense AP Accrual Account that you specify in the Purchasing Options window as part of your application setup, and copies it into the Accrual Account Flexfield in your document.

An exception is when the account generator is unable to derive a charge account in the first two steps. Then an account is retrieved from the HR employee record and

individual segments are replaced based on the item category. This is a typical scenario when using one-time items in Oracle Purchasing.

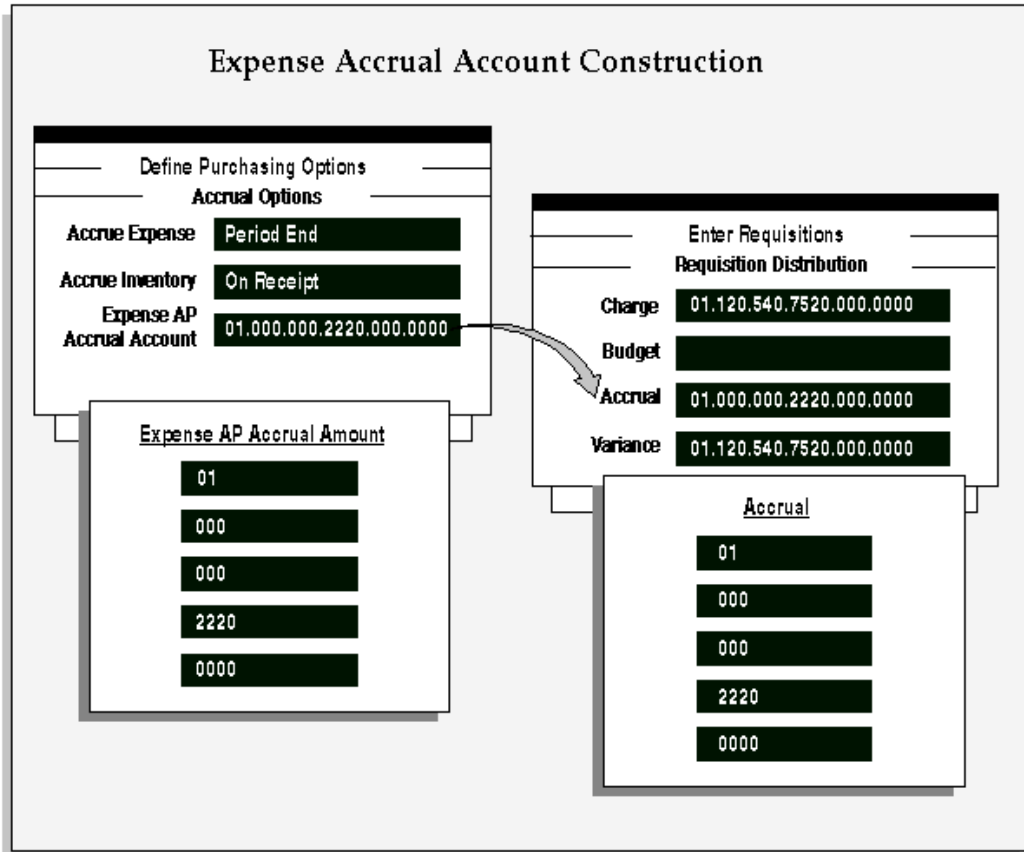

The following matrix describes the source fields that the Account Generator references to build the charge, budget, accrual, and variance account based on the distribution destination type.

The horizontal axis lists the windows you use to specify the source accounts that the Account Generator references in Oracle Purchasing. The vertical axis lists the possible destination types for each account type the Account Generator constructs. In addition, the Additional Conditions are applied as part of the vertical access. The body of the matrix lists the fields you use to enter the reference accounts.

When more than one option is indicated for a particular account/destination type combination, the Account Generator attempts to locate the primary source account identified in the matrix (Seq) with a **1** as long as any Additional Conditions listed are met. This means that there may be several source accounts with a **1**, since there may be multiple Additional Conditions. The first additional condition met will be the source attempted. If this reference account is unavailable or not appropriate for the distribution information you provide, the Account Generator tries the source indicated as **2** and so on until it either successfully locates a reference account, or fails. When an account has been located, or the Account Generator has failed to find an account, the matrix may

indicate that an Override condition may apply. These entries are indicated by an **O** instead of a numeric value. In the case of an Override, a built account may be superceded.

**Default Charge Account Sources**

<b>Destina tion Types</b>	<b>Additio nal Consid er- ations</b>	<b>Seq</b>	<b>WIP Accoun ting Classes</b>	<b>Sub- invento ries</b>	<b>Organiz at- ion Parame ters</b>	<b>Items (INV or PO)</b>	<b>Purcha sing Options</b>	<b>Other</b>
All Destinat ion Types	Cross OU case and One-Ti me Item or a Shop Floor enabled Item	1			Cost of Sales Account for Transact ion Flow default org			
All Destinat ion Types	Cross OU case and Expense item	1				Expense		
All Destinat ion Types	Cross OU case and Expense item	2			Expense			
All Destinat ion Types	Cross OU case and Asset item	1			Material			
All Destinat ion Types	PO auto-cre ated from requisiti on	1						Copied from requisiti on

Destination Types	Additional Considerations	Seq	WIP Accounting Classes	Sub-inventories	Organization Parameters	Items (INV or PO)	Purchasing Options	Other
Expense	Not a PO autocreated from req and not prevented by PA override profile	1						Preferences
Expense	Project related	2						Customized Project rules
Expense	Project Related and not prevented by PA override profile	0						User entered
Expense	Not a PO autocreated from a req. Not Project.	1						Preferences
Expense	Non-Project	2				Expense		

Destination Types	Additional Considerations	Seq	WIP Accounting Classes	Sub-inventories	Organization Parameters	Items (INV or PO)	Purchasing Options	Other
Expense	Non-Project	3						Employee Profile for Assignment in Purchasing OU's SOB
Expense	Non-Project Account not built before HR Employee Profile step	30						Item Category Segment substitutions
Expense	Non-Project	0						User entered
Inventory	Expense item	1		Expense				
Inventory	Expense item	2				Expense		
Inventory	Expense item	3			Expense			
Inventory	Asset item	1		Material				
Inventory	Asset item	2			Material			

Destination Types	Additional Considerations	Seq	WIP Accounting Classes	Sub-inventories	Organization Parameters	Items (INV or PO)	Purchasing Options	Other
Shop Floor		1						Enterprise Asset Mgmt (EAM) rules
Shop Floor		2a	Material					
Shop Floor		2b	Mat. Overhead					
Shop Floor		2c	Resource					
Shop Floor		2d	Outside Processing					
Shop Floor		2e	Overhead					

**Default Accrual Account Sources**

Destination Types	Additional Considerations	Seq	WIP Accounting Classes	Sub-inventories	Organization Parameters	Items (INV or PO)	Purchasing Options	Other
All Destination Types	Cross OU case (No additional sources are used)	1					Expense AP Accrual Account for PO OU	



<b>Destination Types</b>	<b>Additional Considerations</b>	<b>Seq</b>	<b>WIP Accounting Classes</b>	<b>Sub-inventories</b>	<b>Organization Parameters</b>	<b>Items (INV or PO)</b>	<b>Purchasing Options</b>	<b>Other</b>
All Destination Types	OPM is installed . Not Project related.	1						OPM API
Expense	Project related	1						Customized Project rules
Expense	OPM is not installed . Not Project related.	1					Expense AP Accrual Account	
Inventories, Shop Floor	OPM is not installed . One-time item.	1					Expense AP Accrual Account for PO OU	
Inventories, Shop Floor	OPM is not installed . Not one-time item.	1						Inventories AP Accrual for Ship-to org

**Default Budget Account Sources**

Destination Types	Additional Considerations	Seq	WIP Accounting Classes	Sub-inventories	Organization Parameters	Items (INV or PO)	Purchasing Options	Other
Expense or Inventory	PO auto-created from requisition	1						Copied from requisition
Expense		1						Charge Account
Expense		0						User entered
Inventory		1		Encumbrance				
Inventory		2				Encumbrance		
Inventory		3			Encumbrance for ship-to org			
Shop Floor	No encumbrance is done for Shop Floor	1	n/a	n/a	n/a	n/a	n/a	n/a

**Default Variance Account Sources**

<b>Destina tion Types</b>	<b>Additio nal Consid er- ations</b>	<b>Seq</b>	<b>WIP Accoun ting Classes</b>	<b>Sub- invento ries</b>	<b>Organiz ation Parame ters</b>	<b>Items (INV or PO)</b>	<b>Purcha sing Options</b>	<b>Other</b>
All Destinat ion Types	Cross OU case (No addition al sources are used)	1						Charge Account
All Destinat ion Types	PO auto-cre ated from requisiti on	1						Copied from requisiti on
Expense	Project-r elated	1						Customi zed Project rules
Expense	Project-r elated	2						Customi zed Project rules
Expense	Non-Pr oject	1						Charge Account
Inventor y		1			Inventor y Price Variance for Ship-to org			
Shop Floor	One-tim e Item	1						Charge Account

Destination Types	Additional Considerations	Seq	WIP Accounting Classes	Sub-inventories	Organization Parameters	Items (INV or PO)	Purchasing Options	Other
Shop Floor		1						Inventory Price Variance for Ship-to org

**Default Destination Charge Account Sources**

Destination Types	Additional Considerations	Seq	WIP Accounting Classes	Sub-inventories	Organization Parameters	Items (INV or PO)	Purchasing Options	Other
All Destination Types	PO auto-created from requisition	1						Copied from requisition charge account
Expense	Project related	2						Customized Project rules
Expense	Project Related and not prevented by PA override profile	0						User entered

Destination Types	Additional Considerations	Seq	WIP Accounting Classes	Sub-inventories	Organization Parameters	Items (INV or PO)	Purchasing Options	Other
Expense	Not a PO autocreated from a req. Not Project.	1						Preferences
Expense	Non-Project	2				Expense		
Expense	Non-Project	3						Employee profile for deliver-to-person's HR assignment in destination OU SOB
Expense	Non-Project Account not built before HR Employee Profile step	30						Item Category Segment substitutions
Expense	Non-Project	0						User entered
Inventory	Expense item	2		Expense				

Destination Types	Additional Considerations	Seq	WIP Accounting Classes	Sub-inventories	Organization Parameters	Items (INV or PO)	Purchasing Options	Other
Inventories	Expense item	3				Expense		
Inventories	Expense item	4			Expense			
Inventories	Asset item	2		Material				
Inventories	Asset item	3			Material			
Shop Floor		2						Enterprise Asset Mgmt (EAM) rules
Shop Floor		3a	Material					
Shop Floor		3b	Mat. Overhead					
Shop Floor		3c	Resource					
Shop Floor		3d	Outside Processing					
Shop Floor		3e	Overhead					

**Default Destination Variance Account Sources**

<b>Destina tion Types</b>	<b>Additio nal Consid er- ations</b>	<b>Seq</b>	<b>WIP Accoun ting Classes</b>	<b>Sub- invento ries</b>	<b>Organiz ation Parame ters</b>	<b>Items (INV or PO)</b>	<b>Purcha sing Options</b>	<b>Other</b>
Expense	PO auto-cre ated from requisiti on	1						Copied from requisiti on Variance Account
Expense	Project related	1						Customi zed Project rules
Expense	Project related	2						Destinat ion Charge Account
Expense	Non-Pr oject	1						Destinat ion Charge Account
Inventor y		1				Inventor y Price Variance for Ship-to org		
Shop Floor	One-tim e Item	1						Destinat ion Charge Account

Destination Types	Additional Considerations	Seq	WIP Accounting Classes	Sub-inventories	Organization Parameters	Items (INV or PO)	Purchasing Options	Other
Shop Floor		1			Inventory Price Variance for Ship-to org			

**Tip:** Minimize your setup by specifying source accounts at the appropriate level of detail for your business. For example, you can specify the charge account source for Inventory (expense) destination types at the subinventory, item, or organization level. If an organization level account is sufficient for your business needs, it is not necessary to specify item or subinventory accounts.

For Shop Floor destination types, if no WIP accounting class (WAC) encumbrance account is found, then the Costing API searches from Item and if at the Item level the account is not defined, Costing API selects the encumbrance account defined in Organization parameters. For such distributions, the Account Generator calls the Costing API, which gets encumbrance account from WIP accounting class encumbrance field. The Account Generator does construct a budget account for Shop Floor distributions if linked work order is an EAM job. Oracle Purchasing does encumber outside processing purchases for EAM work orders.

**Important:** If the Account Generator is unable to build a charge account you can either manually specify a charge account in your document or you can design a custom Account Generator function to build Expense destination charge accounts based on your own business rules.

While you cannot edit the accrual, budget, or variance accounts that the Account Generator constructs, you can override or specify the charge account for uncommitted Expense distributions. In this case, you can either edit the charge account that the Account Generator constructs for you, or you can specify a default charge account in the Defaults region of your document. When you specify a default charge account, it always overrides any expense charge account that the Account Generator tries to provide.

## Account Build Timing and Logistics

For Expense and Inventory destinations in the Requisitions, Purchase Orders, and



Releases windows, the Account Generator constructs the account when you navigate into the distribution Charge Account field, or when an explicit or implicit commit anywhere in the window provides enough information for Oracle Purchasing to create a distribution. For Shop Floor destinations, the code is constructed when you enter all required data in the Outside Processing region and either return to the document distributions region or commit.

For all windows, the build sequence is:

1. Charge
2. Budget
3. Accrual
4. Variance
5. Destination Charge
6. Destination Variance

Each account is provided as a possible source value to the subsequent builds. For example, the budget rules accept the charge account as a possible value, and for Expense destination types the charge account value is copied into the Budget Account field. The accrual account rules accept both the charge and budget account values. Finally, the variance account rules accept the charge, budget, and accrual account values as possible sources.

If the Account Generator is unable to construct accrual, variance, or budget accounts you cannot enter these fields to manually provide the missing values. You must identify and resolve the problem that is causing the Account Generator to fail. If the Account Generator is unable to construct a charge or budget account, you can manually specify the missing values if the destination type is Expense. Since budget and variance account rules take the charge account value for Expense destination types, the Account Generator tries to construct these accounts as soon as you manually provide a charge account if it was unable to find one during the initial build attempt.

### **The Account Generator Does Not Rebuild After You Update a Document**

Consistent with prior release's functionality, once the Account Generator successfully builds accounts for a document, it does not attempt to rebuild when you update the document. For example, if you build a custom process to generate the requisition charge account for Expense purchases based on requestor, and change the requestor after the Account Generator constructs the charge account, it will not attempt to rebuild.

Requisition Import does not use the Account Generator to construct charge, budget, accrual, or variance accounts. Any custom process that you create cannot be used by this utility.

## Related Topics

Customizing the Account Generator for Oracle Purchasing, page E-24

The Default Account Generator Processes for Oracle Purchasing, page E-30

Using the Workflow Monitor with the Account Generator, page E-49

## Customizing the Account Generator for Oracle Purchasing

Oracle Purchasing provides default Account Generator processes for you to use. If the defaults do not satisfy your accounting requirements, you can use the Oracle Workflow Builder to customize the default processes.

Before you use or modify any of the workflows in Purchasing, read the setup information at the beginning of this document.

For more information on the generic features and functions of the Account Generator, see the Customizing the Account Generator section of the *Oracle E-Business Suite Flexfields Guide*.

Use the Oracle Workflow Builder to customize workflows. When you customize a workflow, only those documents that you create after you customize it are affected by the customized workflow.

You can use the Workflow Monitor to follow where certain documents are in a workflow process. If you encounter problems while the Account Generator builds accounts, set the profile option *Account Generator: Run in Debug Mode* to Yes to help you locate the problem. (Always set it back to No after you are finished, to maintain performance.) See: Using the Workflow Monitor with the Account Generator, page E-49.

### To display the workflow in the Oracle Workflow Builder:

1. Choose Open from the File menu, and connect to the database.

See: Opening and Saving Item Types, *Oracle Workflow Developer's Guide*.

The Display name of the Account Generator workflow for purchase orders is *PO Account Generator*. The name of its Workflow definition file is *poxwfpag.wft*.

The Display name of the Account Generator workflow for requisitions is *PO Requisition Account Generator*. The name of its Workflow definition file is *poxwfrag.wft*.

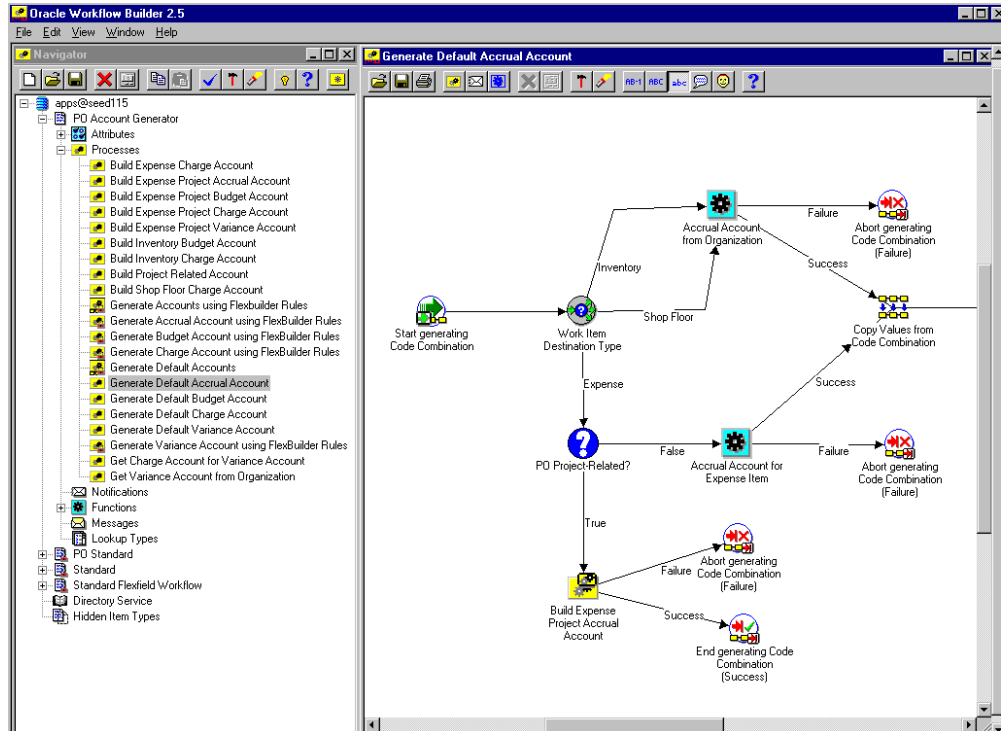

2. Expand the data source, then the Account Generator item type branch within that data source.
3. Expand the Processes branch within the Account Generator branch, then double-click on a process activity to display its diagram.

## Creating a New Custom Process

If you want to customize the PO Account Generator or the PO Requisition Account Generator workflows, you must customize the default (original) workflows that Purchasing provides. Unlike the PO Approval, PO Requisition Approval, and PO Create Documents workflows in Purchasing, only one Account Generator workflow can be called from the application itself, through the Account Generator Processes window. You can't select a separate customization, like you can with the other workflows in the Document Types window. Therefore, you need to make your customizations to the default Account Generator workflows. Have your backup to revert to, if you need, while you are testing your customizations.

## Required Modifications

There are no required modifications you need to make to the PO Account Generator or the PO Requisition Account Generator workflows, unless you need to customize them to suit your business requirements. See: *Decide How to Use the Account Generator*, page E-7.

## Supported and Unsupported Customizations

Following is a discussion of what you can and definitely cannot modify in both the PO Account Generator and PO Requisition Account Generator workflows. For those things you can modify, the discussion includes important guidelines that you need to be careful of when making customizations.

For important information on how to customize workflows, see the *Oracle Workflow Developer's Guide*.

To further help you with your customizations, refer to the sections later in this document, starting with The Default Account Generator Processes for Oracle Purchasing, page E-30. These sections describe the components of the main processes in the PO Account Generator and the PO Requisition Account Generator workflows. If you haven't already, see also: Customization Guidelines, page E-2.

**Important:** If a particular Workflow object does not appear in the following sections on the lists of things you can customize, do not modify it, regardless of its access level.

## Attributes

You cannot modify any attributes in the PO Account Generator or the PO Requisition Account Generator.

## Processes

If you modify a process, it is essential that the basic flow be maintained. For example, the Get Expense Account ID function activity in the Build Expense Charge Account subprocess sets the item attribute Temp Account ID with the code combination identification number (CCID) of the account being built. This attribute is used by the function activity Copy Values from Account ID to fetch the concatenated segments. Therefore, if you replace the function activity Get Expense Account ID with one of your own, your new function activity must also set the item attribute Temp Account ID.

If you modify any process, either by replacing a portion of its flow or by adding additional function activities, remember the following:

- Attributes that are set by default function activities in the default processes must also be set if you replace default function activities with ones of your own. That is, if a function activity in that process uses a SetItemAttr statement, then that function activity is setting an attribute to be used by another function activity later. Therefore, your new function activity must do the same. You should also preserve SetItemUserKey and SetItemOwner statements, if any. Depending on your customizations, you may also want to preserve GetItemAttr statements.
- Any database state maintained by the default processes must also be maintained by processes you customize. That is, if a function activity in that process uses an

Update or Insert Into statement, then that function activity is updating or inserting rows in the database. Therefore, your new function activity must maintain the same database state.

To get a list of the workflow function activities that use SetItemAttr, GetItemAttr, SetItemUserKey, SetItemOwner, Insert Into, or Update statements, run the PL/SQL script powfcust. For instructions on running this script, see: Customization Guidelines, page E-2.

You can modify the following processes in both the PO Account Generator and the PO Requisition Account Generator, as your business needs require:

- Generate Default Accrual Account
- Generate Default Budget Account
- Generate Default Charge Account
- Generate Default Variance Account
- Build Expense Charge Account
- Build Inventory Budget Account
- Build Inventory Charge Account
- Build Expense Project Accrual Account
- Build Expense Project Budget Account
- Build Expense Project Charge Account
- Build Expense Project Variance Account
- Build Shop Floor Charge Account
- Get Charge Account for Variance Account
- Get Variance Account from Organization

You cannot modify the following processes in the PO Account Generator or the PO Requisition Account Generator:

- Generate Default Accounts
- Generate Accounts Using FlexBuilder Rules
- Generate Charge Account Using FlexBuilder Rules

- Generate Budget Account Using FlexBuilder Rules
- Generate Accrual Account Using FlexBuilder Rules
- Generate Variance Account Using FlexBuilder Rules

## Function Activities

You cannot modify any function activities in the PO Account Generator or PO Requisition Account Generator. However, you can modify the Set Encoded Error Message function activity by changing its attributes in the Workflow Builder. See: *To use the Set Encoded Error Message function activity*, below.

You can replace some function activities with function activities of your own. When you replace a function activity, you are modifying the process in which it is contained. See the guidelines for customizing the Account Generator processes in the section Processes, page E-26.

If you substitute default function activities in a process with function activities that you create, remember the following:

- The result type of your new function activity must match the result type of the default activity. That is, the Result Type of the function activity in the Workflow Builder needs to match the result type specified by that function activity's corresponding PL/SQL procedure—for example, a Result Type of Yes/No. It also means that if you have, for example, two results (such as Yes and No) in your function activity and corresponding PL/SQL procedure, make sure that there are two corresponding transitions in the workflow diagram (one for Yes and one for No). If you alter the result types and transitions in a process, be careful that you aren't deleting or bypassing any special transitions or checks.
- Just as with Processes, page E-26 above, any attributes that were set by the default function activity must also be set by your customized function activity.
- Just as with Processes, page E-26 above, any database state maintained by the default function activity must also be maintained by the customized function activity.

This function activity is not used by any process in the workflow, but is provided if you need to create a customized error message. To use this function activity to send a customized error message, do the following:

### **To use the Set Encoded Error Message function activity:**

1. Create the message in the Oracle Applications Message Dictionary.

You must first define the error message in the Oracle Applications Message Dictionary before it can be used by this function activity. For instructions, see the online help for the Messages window in the Application Developer responsibility, or see the *Oracle E-Business Suite Developer's Guide*.

2. Drag and drop the Set Encoded Error Message function activity into the process diagram of the process you want to modify.
3. Select the activity in the process diagram and choose Properties from the Edit menu.
4. In the Node Attributes region, enter the Message Name of the message you defined in the Message Dictionary and optionally enter one or more tokens to provide dynamic text for the error message.

The Application Code defaults to PO (Purchasing), but you can change it if you are displaying the error message in another application.

## Lookup Types

The PO Account Generator and PO Requisition Account Generator use the following two Lookup Types provided by the PO Standard workflow; you cannot modify these Lookup Types:

- PO Work Item Destination Type
- PO WIP Type

For information on the default lookup types provided by the Standard Flexfield Workflow, see the Account Generator section/chapter of the *Oracle E-Business Suite Flexfields Guide*.

## Implementing a Customized Account Generator Process

Use the Account Generator Processes window to choose either the Generate Default Accounts process or the Generate Accounts Using FlexBuilder Rules process and associate the process with the appropriate Accounting Flexfield structure and item type.

If you customize any of the customizable processes belonging to the Generate Default Accounts process, and you make sure the Generate Default Accounts process is associated with the appropriate Accounting Flexfield structure and item type in the Account Generator Processes window, your customizations will take effect.

## Choosing the Process for a Flexfield Structure

1. Navigate to the Account Generator Processes window by switching to the System Administrator responsibility and choosing Application > Flexfield > Key > Accounts.
2. With your cursor in the Application field, choose View > Find and select the combination of Application, Flexfield Title, and Structure that you need.

Or, perform a Query > Run and locate the PO Account Generator and PO Requisition Account Generator item types in the Item Type column.

3. In the Process field, specify the process-Generate Default Accounts or Generate Accounts Using FlexBuilder Rules-that you want to use to generate these accounts. The default process, Generate Default Accounts, will default in.

## Related Topics

Using the Account Generator in Oracle Purchasing, page E-6

The Default Account Generator Processes for Oracle Purchasing, page E-30

Using the Workflow Monitor with the Account Generator, page E-49

## The Default Account Generator Processes for Oracle Purchasing

Oracle Purchasing comes with the following Account Generator workflow item types-the first for purchase orders and releases, and the second for requisitions:

- PO Account Generator
- PO Requisition Account

Each Account Generator workflow contains the following top-level processes:

- Generate Accounts Using FlexBuilder Rules, page E-49
- Generate Default Accounts, page E-37

Generate Default Accounts consists of four main subprocesses:

- Generate Default Accrual Account, page E-43
- Generate Default Budget Account, page E-43
- Generate Default Charge Account, page E-44
- Generate Default Variance Account, page E-44

Other subprocesses are as follows:

- Build Expense Charge Account, page E-45
- Build Inventory Charge Account, page E-45
- Build Shop Floor Charge Account, page E-46
- Build Inventory Budget Account, page E-46
- Build Expense Project Accrual Account, page E-47
- Build Expense Project Budget Account, page E-47



- Build Expense Project Charge Account, page E-47
- Build Expense Project Variance Account, page E-47
- Get Charge Account for Variance Account, page E-48
- Get Variance Account from Organization, page E-48

Each Account Generator contains a number of item attributes. These attributes correspond to all the raw parameters and some derived parameters that were used in FlexBuilder. Each account ID is provided as a possible source value, in the form of an item attribute, to the subsequent account being built.

The item type attributes in both account generator item types are listed below.

### Account Generator Workflow Item Type Attributes

Display Name	Description	Type	Length/Format/ Lookup Type
Accrual Account ID	Unique identifier for the accrual account	Number	
Blanket PO Header ID	Unique identifier for the suggested source blanket agreement or catalog quotation header	Number	
BOM Cost Element ID	Unique identifier for the Bill of Materials cost element	Number	
BOM Resource ID	Unique identifier for the Bills of Material resource	Number	
Budget Account ID	Unique identifier for the budget account	Number	
Category ID	Unique identifier for the item category	Number	
Charge Account ID	Unique identifier for the charge account	Number	

<b>Display Name</b>	<b>Description</b>	<b>Type</b>	<b>Length/Format/ Lookup Type</b>
Chart of Accounts ID	Unique identifier for the chart of accounts	Number	
Deliver to Location ID	Unique identifier for the deliver-to location	Number	
Destination Organization ID	Unique identifier for the final destination organization	Number	
Destination Subinventory	Subinventory for inventory purchases	Text	
Destination Type Code	Final destination of the purchased items	Text	
Distribution att1-15	Descriptive flexfield segment	Text	
Document Type Code	Document type	Text	
Error Message	Oracle Applications message name	Text	
Expenditure Category	Expenditure category	Text	30
Expenditure Item Date	Project accounting expenditure item date	Date	
Expenditure Organization ID	Unique identifier for the project accounting expenditure organization	Number	
Expenditure Organization Name	Name of the expenditure organization	Text	60
Expenditure Type	Project accounting expenditure type	Text	

<b>Display Name</b>	<b>Description</b>	<b>Type</b>	<b>Length/Format/ Lookup Type</b>
Header att1-15	Descriptive flexfield segment	Text	150
Item ID	Unique identifier for the item	Number	
Line att1-15	Descriptive flexfield segment	Text	150
Line Type ID	Unique identifier for the line type	Number	
PA Billable Flag	Indicator of whether an item charged to a task can accrue revenue	Text	
PO Encumbrance Flag	Indicator of whether the distribution is encumbered	Text	4
Preparer ID	Unique identifier for the document preparer	Number	
Project Class Code	Class code for the project	Text	30
Project ID	Unique identifier for the project to which the item is charged	Number	
Project Number	Project number to which the item is charged	Text	25
Project Organization ID	Unique identifier for the organization responsible for the project work	Number	

<b>Display Name</b>	<b>Description</b>	<b>Type</b>	<b>Length/Format/ Lookup Type</b>
Project Organization Name	Organization responsible for the project work	Text	60
Project Type	Project type that classifies the project	Text	20
Public Sector Flag	Indicator of whether the project is in the public or private sector	Text	1
Revenue Category	Classifier of the expenditure type into a revenue group	Text	30
Shipment att1-15	Descriptive flexfield segment	Text	150
Source Document Header ID	Unique identifier for the source document header	Number	
Source Document Line ID	Unique identifier for the source document line	Number	
Source Document Type Code	Source document type	Text	
Source Organization ID	Unique identifier for the inventory source organization	Number	
Source Subinventory	Inventory source subinventory name	Text	
Suggested Vendor ID	Unique identifier for the suggested supplier	Number	

<b>Display Name</b>	<b>Description</b>	<b>Type</b>	<b>Length/Format/ Lookup Type</b>
Source Type Code	Source type of the item	Text	
Supplier Employee Number	Number used by Oracle Projects to identify the person associated with a supplier		
Supplier Person ID	Unique identifier used by Oracle Projects to identify the person associated with a supplier		
Supplier Type	Supplier type, such as Employee or Supplier	Text	25
Task ID	Unique identifier for the task	Number	
Task Number	Task number	Text	25
Task Organization ID	Unique identifier of the organization responsible for the task work	Number	
Task Organization Name	Organization responsible for the task work	Text	60
Task Service Type	Type of work performed for the task	Text	30
Temp Account ID	Unique identifier for the code combination of the account being built	Number	

<b>Display Name</b>	<b>Description</b>	<b>Type</b>	<b>Length/Format/ Lookup Type</b>
To Person ID	Unique identifier for the deliver-to person	Number	
Top Task ID	Unique identifier for the top task to which a task rolls up	Number	
Top Task Number	Number of the top task to which a task rolls up	Text	25
Type Lookup Code	Type of the document	Text	
Vendor ID	Unique identifier for the supplier	Number	
WIP Entity ID	Unique identifier for the Work in Process job or repetitive assembly	Number	
WIP Entity Type	Work in Process entity type code	Text	
WIP Line ID	Unique identifier for the Work in Process line	Number	
WIP Operation Seq Num	Work in Process operation sequence number within a routing	Number	
WIP Repetitive Schedule ID	Unique identifier for the Work in Process repetitive schedule	Number	
WIP Resource Seq Num	Work in Process resource sequence number	Number	

## Summary of the Generate Default Accounts Process

To view the properties of the Generate Default Accounts process, select the process in the navigator tree, then choose Properties from the Edit menu. The Generate Default Accounts process has a result type of Flexfield Result, indicating that when the process completes, it has a result of Failure or Success. These results correspond to the lookup codes in the Flexfield Result lookup type in the Standard Flexfield Workflow item type.

This process activity is also runnable, indicating that it can be initiated as a top level process to run by making calls to the Workflow Engine *CreateProcess* and *StartProcess* APIs.

The Details property page of the process activity indicates that the Generate Default Accounts process has an error process called DEFAULT\_ERROR associated with it, which gets initiated only when an error is encountered in the process. This error would initiate DEFAULT\_ERROR, which is associated with the System:Error item type. Currently the process simply executes the standard Default Error Notification activity to provide information associated with the error. You can customize the process further to suit your needs. See: Oracle Workflow Guide Default Error Process, *Oracle Workflow Developer's Guide*.

For more information on when the Account Generator process is initiated, see the subsection **Account Build Timing and Logistics** in: What the Account Generator Does in Oracle Purchasing, page E-9.

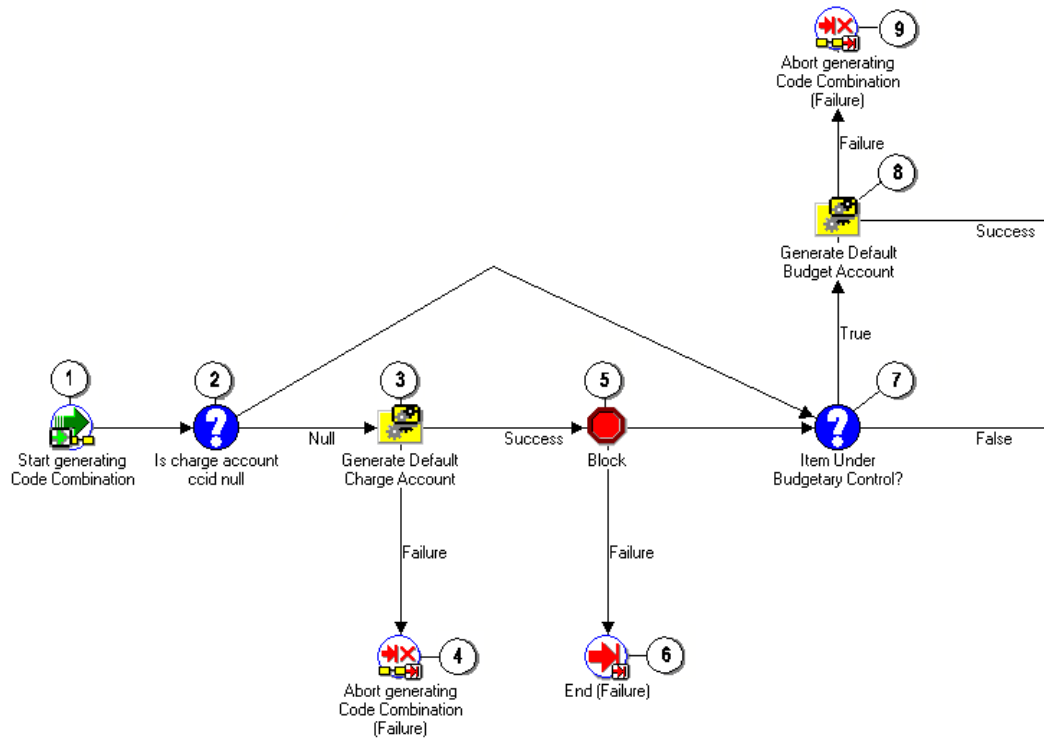

Generate Default Accounts is the default workflow process in Purchasing that builds the accounts.

Node 2 checks if a charge account has already been manually entered on the document. (For example, you can override or specify the charge account for uncommitted Expense distributions.) If a charge account already exists, this process skips the charge account generation process at node 3 and proceeds to node 7, which determines whether a budget account is needed.



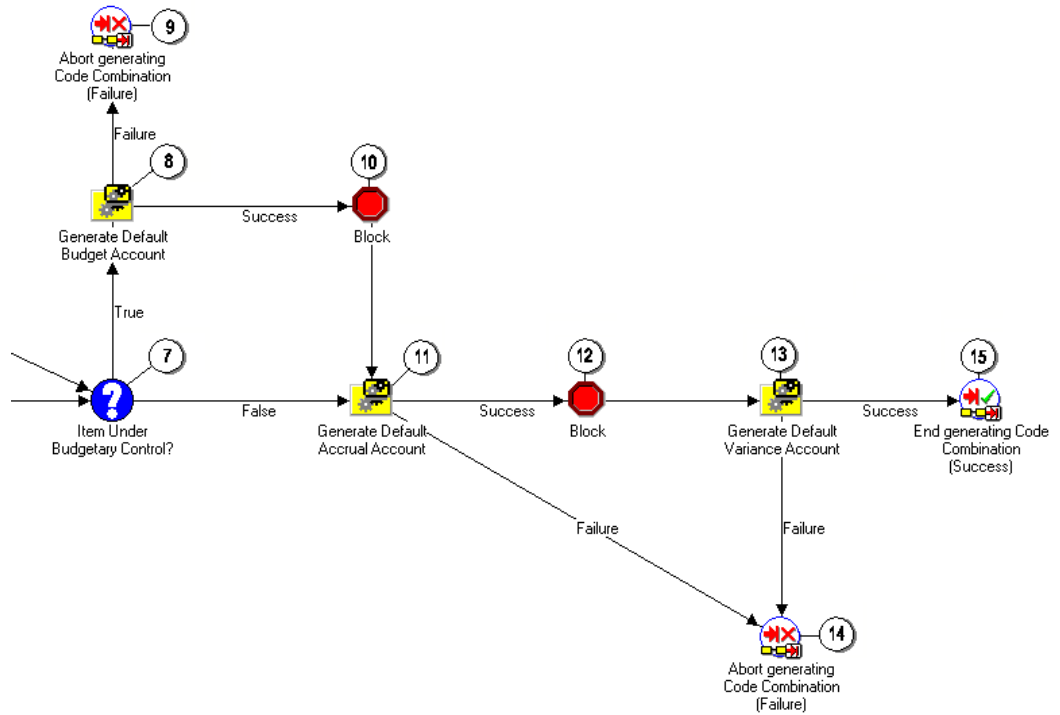

Nodes 3, 8, 11, and 13 build the charge, budget (if node 7 finds that budgetary control is used), accrual, and variance accounts. These nodes end in failure at nodes 4, 9, or 14, if the account could not be created—for example because not all account segments were provided, or a disabled segment was used. (In these cases, you receive an error in the document window.)

Nodes 5 and 12 suspend execution of the workflow until the previous account has completed generating the account segment values. Node 5 allows a failure option in case the charge account fails to generate a code combination identifier (CCID). In this case only, the workflow ends at node 6.

## Generate Default Accounts Process Activities

The following is a description of each activity used in all of the processes and subprocesses in the PO Account Generator and the PO Requisition Account Generator, listed by the activity's display name. You can create all the components for an activity in the graphical Workflow Builder except for the PL/SQL stored procedures that the function activities call. All function activities execute PL/SQL stored procedures which you must create and store in the Oracle RDBMS. The naming convention for the PL/SQL stored procedures is:

`<PACKAGE>.<PROCEDURE>`

`<PACKAGE>` is the name of the package that groups all of the procedures.

`<PROCEDURE>` represents the name of the procedure.

You can use the Item Type Definitions Web page to view `<PACKAGE>.<PROCEDURE>`

names. See: [Item Type Definitions Web Page](#), *Oracle Workflow Developer's Guide*.

Some function activities are not listed here, such as Start and End function activities. These are standard function activities provided in the Standard Flexfield Workflow item type. These also include the function activities Copy Values from Code Combination and Validate Code Combination. For information on how to use these function activities, see: *Standard Flexfield Workflow, Oracle Applications Flexfields Guide*.

Most of the function activities described here perform the same functions as described in the table in the section Using the Account Generator in Oracle Purchasing, page E-6.

### **Accrual Account For Expense Item**

This function activity gets the accrual account for the expense item.

### **Accrual Account From Organization**

This function activity gets the accrual account for inventory and shop floor items from the organization.

### **Build Inventory Charge Account**

This function activity gets the appropriate charge account for inventory items based on whether the item is an expense or asset item.

### **Expense Account**

This function activity gets the charge expense account for expense items.

### **Get Budget Account From Item/Sub**

This function activity gets the budget account for inventory items from the subinventory.

### **Get Charge Account**

This function activity gets the charge account.

### **Get Item Level Budget Account**

This function activity gets the budget account for inventory items from the item.

### **Get Org Level Budget Account**

This function activity gets the budget account for inventory items from the organization.

**Is Charge Account CCID Null?**

This is a standard Workflow comparison activity. Here, it is used to check if the Charge Account field on the document is null. See: Comparison Activities, *Oracle Workflow Developer's Guide*.

**Item Under Budgetary Control?**

This function activity checks if encumbrance accounting is being used.

**Job WIP Account**

For an outside processing job, this function activity gets the charge account based on the resource cost element associated with the job.

**PO Accrual Acc Flexbuilder Upgrade**

In the PO Account Generator, this function activity replicates your accrual account FlexBuilder rules in the Account Generator. It calls the appropriate functions that were generated during your upgrade from Release 10.7.

**PO Budget Acc Flexbuilder Upgrade**

In the PO Account Generator, this function activity replicates your budget account FlexBuilder rules in the Account Generator. It calls the appropriate functions that were generated during your upgrade from Release 10.7.

**PO Charge Acc Flexbuilder Upgrade**

In the PO Account Generator, this function activity replicates your charge account FlexBuilder rules in the Account Generator. It calls the appropriate functions that were generated during your upgrade from Release 10.7.

**PO Requisition Accrual Acc Flexbuilder Upgrade**

In the PO Requisition Account Generator, this function activity replicates your accrual account FlexBuilder rules in the Account Generator. It calls the appropriate functions that were generated during your upgrade from Release 10.7.

**PO Requisition Budget Acc Flexbuilder Upgrade**

In the PO Requisition Account Generator, this function activity replicates your budget account FlexBuilder rules in the Account Generator. It calls the appropriate functions that were generated during your upgrade from Release 10.7.

**PO Requisition Charge Acc Flexbuilder Upgrade**

In the PO Requisition Account Generator, this function activity replicates your charge

account FlexBuilder rules in the Account Generator. It calls the appropriate functions that were generated during your upgrade from Release 10.7.

### **PO Requisition Variance Acc Flexbuilder Upgrade**

In the PO Requisition Account Generator, this function activity replicates your variance account FlexBuilder rules in the Account Generator. It calls the appropriate functions that were generated during your upgrade from Release 10.7.

### **PO Project-Related?**

In the PO Account Generator, this function activity checks if the purchase order item is for a project in Oracle Projects.

### **Requisition Project-Related?**

In the PO Requisition Account Generator, this function activity checks if the requisition item is for a project in Oracle Projects.

### **PO Variance Flexbuilder Upgrade**

In the PO Account Generator, this function activity replicates your variance account FlexBuilder rules in the Account Generator. It calls the appropriate functions that were generated during your upgrade from Release 10.7.

### **Schedule Account**

For an outside processing schedule, this function activity gets the charge account based on the resource cost element associated with the schedule.

### **Type of WIP**

For shop floor items, this function activity checks if the outside processing type is Job or Schedule.

### **Variance Account From Organization**

This function activity gets the variance account for inventory and shop floor items from the organization.

### **Work Item Destination Type**

This function activity checks if the destination type of the item is Inventory, Shop Floor, or Expense.

### **Set Encoded Error Message**

This function activity is not used by any process in the workflow, but is provided to aid in customizing the workflow. It can be used to create a customized error message. You

must first define the message in the Oracle Applications Message Dictionary before it can be used by this function activity.

For instructions, see **To use the Set Encoded Error Message function activity** in the section Customizing the Account Generator for Oracle Purchasing, page E-24.

## Summary of the Generate Default Accrual Account Subprocess

To view the properties of this process, select the process in the navigator tree, then choose Properties from the Edit menu. This process has a result type of Flexfield Result, indicating that when the process completes, it has a result of Failure or Success. These results correspond to the lookup codes in the Flexfield Result lookup type in the Standard Flexfield Workflow item type.

This process activity is not runnable, indicating that it cannot be initiated as a top-level process to run, but rather can be run only as a subprocess when called by a higher-level process.

The subprocess begins at node 1.

Node 2 checks if the destination type for the item is Inventory, Shop Floor, or Expense.

For expense items, node 8 first checks if the item is project-related. If it is, the subprocess at node 11 builds a project-related account, if you have customized that subprocess to do so.

If the item is not project-related, node 9 gets the accrual account. For inventory and shop floor items, node 3 gets the accrual account from the organization. See the table in the section Using the Account Generator in Oracle Purchasing, page E-6.

Nodes 5 and 6 are standard flexfield workflow activities. See: Standard Flexfield Workflow, *Oracle Applications Flexfields Guide*.

## Summary of the Generate Default Budget Account Subprocess

To view the properties of this process, select the process in the navigator tree, then choose Properties from the Edit menu. This process has a result type of Flexfield Result, indicating that when the process completes, it has a result of Failure or Success. These results correspond to the lookup codes in the Flexfield Result lookup type in the Standard Flexfield Workflow item type.

This process activity is not runnable, indicating that it cannot be initiated as a top-level process to run, but rather can be run only as a subprocess when called by a higher-level process.

The subprocess begins at node 1.

Node 2 checks if the item is project-related. If it is, the subprocess at node 3 builds a project-related account, if you have customized that subprocess to do so.

Node 6 checks if the destination type for the item is Inventory, Expense, or Shop Floor.

For shop floor items, the subprocess checks whether the job is EAM job and builds a

shop floor related account only if the job is EAM job. The workflow will stop the budget account generation if the job is not a EAM job.

For expense items, node 10 gets the budget account from the charge account.

For inventory items, the subprocess at node 8 builds the inventory budget account. See: Summary of the Build Inventory Budget Account Subprocess, page E-46.

Nodes 12 and 13 are standard flexfield workflow activities. See: Standard Flexfield Workflow, *Oracle Applications Flexfields Guide*.

## Summary of the Generate Default Charge Account Subprocess

To view the properties of this process, select the process in the navigator tree, then choose Properties from the Edit menu. This process has a result type of Flexfield Result, indicating that when the process completes, it has a result of Failure or Success. These results correspond to the lookup codes in the Flexfield Result lookup type in the Standard Flexfield Workflow item type.

This process activity is not runnable, indicating that it cannot be initiated as a top-level process to run, but rather can be run only as a subprocess when called by a higher-level process.

The subprocess begins at node 1.

Node 2 checks if the destination type for the item is Shop Floor, Inventory, or Expense.

For shop floor items, node 3 builds the shop floor charge account. See: Summary of the Build Shop Floor Charge Account Subprocess, page E-46. For inventory items, node 5 builds the inventory charge account. See: Summary of the Build Inventory Charge Account Subprocess, page E-45. For expense items, node 9 builds the expense charge account. See: Summary of the Build Expense Charge Account Subprocess, page E-45.

If node 9 successfully builds the charge account for expense items, the workflow does not validate the code combination right away. Instead, since you can enter your own charge account on the document for expense items, node 10 first checks if all segments were provided:

- If so, node 12 uses the function attribute Generate Code Combination ID to generate the complete code combination identifier (CCID).
- If not, node 11 uses the function attribute Validate Segment With Values Only to validate just those segments that were provided.

Nodes 6, 10, 11, and 12 are standard flexfield workflow activities. See: Standard Flexfield Workflow, *Oracle Applications Flexfields Guide*.

## Summary of the Generate Default Variance Account Subprocess

To view the properties of this process, select the process in the navigator tree, then choose Properties from the Edit menu. This process has a result type of Flexfield Result,

indicating that when the process completes, it has a result of Failure or Success. These results correspond to the lookup codes in the Flexfield Result lookup type in the Standard Flexfield Workflow item type.

This process activity is not runnable, indicating that it cannot be initiated as a top-level process to run, but rather can be run only as a subprocess when called by a higher-level process.

The subprocess begins at node 1.

Node 2 checks if the destination type is Shop Floor, Inventory, or Expense.

For shop floor or inventory items, node 5 gets the variance account from the organization. For expense items, node 3 gets the charge account. See the table in the section Using the Account Generator in Oracle Purchasing, page E-6.

Node 7 is a standard flexfield workflow activity. See: Standard Flexfield Workflow, *Oracle Applications Flexfields Guide*.

## Summary of the Build Expense Charge Account Subprocess

To view the properties of this process, select the process in the navigator tree, then choose Properties from the Edit menu. This process has a result type of Flexfield Result, indicating that when the process completes, it has a result of Failure or Success. These results correspond to the lookup codes in the Flexfield Result lookup type in the Standard Flexfield Workflow item type.

This process activity is not runnable, indicating that it cannot be initiated as a top-level process to run, but rather can be run only as a subprocess when called by a higher-level process.

The subprocess begins at node 1.

For expense items, this subprocess first checks at node 2 if the item is project-related. If it is, the subprocess at node 3 builds a project-related account, if you have customized that subprocess to do so.

If the expense item is not project-related, node 5 gets the charge expense account. See the table in the section Using the Account Generator in Oracle Purchasing, page E-6.

Node 6 is a standard flexfield workflow activity. See: Standard Flexfield Workflow, *Oracle Applications Flexfields Guide*.

## Summary of the Build Inventory Charge Account Subprocess

To view the properties of this process, select the process in the navigator tree, then choose Properties from the Edit menu. This process has a result type of Flexfield Result, indicating that when the process completes, it has a result of Failure or Success. These results correspond to the lookup codes in the Flexfield Result lookup type in the Standard Flexfield Workflow item type.

This process activity is not runnable, indicating that it cannot be initiated as a top-level

process to run, but rather can be run only as a subprocess when called by a higher-level process.

The subprocess begins at node 1.

For an inventory items, this subprocess, at node 2, gets the appropriate charge account based on whether the item is an expense or asset item. See the table in the section Using the Account Generator in Oracle Purchasing, page E-6.

Node 4 is a standard flexfield workflow activity. See: Standard Flexfield Workflow, *Oracle Applications Flexfields Guide*.

## Summary of the Build Shop Floor Charge Account Subprocess

To view the properties of this process, select the process in the navigator tree, then choose Properties from the Edit menu. This process has a result type of Flexfield Result, indicating that when the process completes, it has a result of Failure or Success. These results correspond to the lookup codes in the Flexfield Result lookup type in the Standard Flexfield Workflow item type.

This process activity is not runnable, indicating that it cannot be initiated as a top-level process to run, but rather can be run only as a subprocess when called by a higher-level process.

The subprocess begins at node 1.

For shop floor items, this subprocess, at node 2, checks if the item is for an outside processing job or schedule. For a job, node 3 gets the charge account based on the resource cost element associated with the job. For a schedule, node 7 gets the charge account based on the resource cost element associated with the schedule. See the table in the section Using the Account Generator in Oracle Purchasing, page E-6.

Node 5 is a standard flexfield workflow activity. See: Standard Flexfield Workflow, *Oracle Applications Flexfields Guide*.

## Summary of the Build Inventory Budget Account Subprocess

To view the properties of this process, select the process in the navigator tree, then choose Properties from the Edit menu. This process has a result type of Flexfield Result, indicating that when the process completes, it has a result of Failure or Success. These results correspond to the lookup codes in the Flexfield Result lookup type in the Standard Flexfield Workflow item type.

This process activity is not runnable, indicating that it cannot be initiated as a top-level process to run, but rather can be run only as a subprocess when called by a higher-level process.

The subprocess begins at node 1.

For inventory items, this subprocess, at node 2, gets a budget account first from the subinventory. If no account is specified there, node 4 looks for the budget account for the item. If no account is specified there, node 5 looks for the budget account for the



organization. If no account is specified there, node 6 gets the charge account for the budget account. See the table in the section Using the Account Generator in Oracle Purchasing, page E-6.

## Summary of the Build Project Account Subprocesses

To view the properties of the Build Project Account subprocesses, select the process in the navigator tree, then choose Properties from the Edit menu. The Build Project Account subprocesses each have a result type of Flexfield Result, indicating that when the process completes, it has a result of Failure or Success. These results correspond to the lookup codes in the Flexfield Result lookup type in the Standard Flexfield Workflow item type.

These subprocess activities are not runnable, indicating that they cannot be initiated as a top-level process to run, but rather can be run only as a subprocess when called by a higher-level process.

There are four Build Project Account subprocesses, one for each account being built:

- Build Expense Project Accrual Account
- Build Expense Project Budget Account
- Build Expense Project Charge Account
- Build Expense Project Variance Account

The Build Project Account subprocesses are dummy processes, available for you to customize an account-building process if Oracle Projects is installed. To use this process, you provide your own rules to the process, in the form of workflow process definitions, to build the account.

Shown below, the function activity Requisition Project-Related? by default always returns a value of False. This is what is meant by the Build Project Related Account process's being a dummy process. It isn't used until you replace the function activity Requisition Project-Related? with one of your own that checks a document for a Project ID.

You can use the Standard workflow function activity Compare Number in place of PO Project-Related. You can use Compare Number to compare the Project ID on a document with a value that you define, or to check if a Project ID exists. If there is no Project ID, then Compare Number transitions to the Expense Account activity and builds the default expense account. If there is a Project ID, then Compare Number transitions to the Build Project Related Account process to build the account. See: Comparison Activities, *Oracle Workflow Developer's Guide*.

If you want to bill items to a project account, you must do the following:

- Replace Requisition Project-Related? (or PO Project-Related?) with your own function activity that branches to Build Project Account subprocess if a document

has a Project ID.

- Customize the appropriate Build Project Account subprocess. In the example above, you would customize the Build Expense Project Charge Account subprocess. If you wanted to use your project-related account for all accounts-accrual, budget, charge, and variance-you would customize all four of the Build Project Account subprocesses.

For more information about using the Account Generator when you integrate Oracle Purchasing with Oracle Projects, read the following essay: "Using the Account Generator in Oracle Projects" in the *Oracle Projects User's Guide*.

## Summary of the Get Charge Account for Variance Account Subprocess

To view the properties of this process, select the process in the navigator tree, then choose Properties from the Edit menu. This process has a result type of Flexfield Result, indicating that when the process completes, it has a result of Failure or Success. These results correspond to the lookup codes in the Flexfield Result lookup type in the Standard Flexfield Workflow item type.

This process activity is not runnable, indicating that it cannot be initiated as a top-level process to run, but rather can be run only as a subprocess when called by a higher-level process.

The subprocess begins at node 1.

For expense items, this subprocess first checks at node 2 if the item is project-related. If it is, the subprocess at node 3 builds a project-related account, if you have customized that subprocess to do so.

If the item is not project-related, node 5 gets the charge account for building the variance account.

Node 7 is a standard flexfield workflow activity. See: Standard Flexfield Workflow, *Oracle Applications Flexfields Guide*.

## Summary of the Get Variance Account from Organization Subprocess

To view the properties of this process, select the process in the navigator tree, then choose Properties from the Edit menu. This process has a result type of Flexfield Result, indicating that when the process completes, it has a result of Failure or Success. These results correspond to the lookup codes in the Flexfield Result lookup type in the Standard Flexfield Workflow item type.

This process activity is not runnable, indicating that it cannot be initiated as a top-level process to run, but rather can be run only as a subprocess when called by a higher-level process.

The subprocess begins at node 1.

For inventory and shop floor items, node 2 gets the variance account from the

organization. See the table in the section Using the Account Generator in Oracle Purchasing, page E-6.

Node 3 is a standard flexfield workflow activity. See: Standard Flexfield Workflow, *Oracle Applications Flexfields Guide*.

## Summary of the Generate Accounts Using FlexBuilder Rules Process

To view the properties of this process, select the process in the navigator tree, then choose Properties from the Edit menu. This process has a result type of Flexfield Result, indicating that when the process completes, it has a result of Failure or Success. These results correspond to the lookup codes in the Flexfield Result lookup type in the Standard Flexfield Workflow item type.

This process activity is also runnable, indicating that it can be initiated as a top-level process to run by making calls to the Workflow Engine *CreateProcess* and *StartProcess* APIs.

If you customized FlexBuilder in a previous release to generate account combinations, you can use the Generate Accounts Using FlexBuilder Rules process to replicate your FlexBuilder setup automatically, without changing any of your predefined FlexBuilder Rules, and without customizing the Account Generator. This top-level process consists of the following processes:

- (Node 3) Generate Charge Account Using FlexBuilder Rules replicates your charge account FlexBuilder rules in the Account Generator.
- (Node 8) Generate Budget Account Using FlexBuilder Rules replicates your budget account FlexBuilder rules in the Account Generator (if the activity at node 7 finds that the item is under budgetary control).
- (Node 11) Generate Accrual Account Using FlexBuilder Rules replicates your accrual account FlexBuilder rules in the Account Generator.
- (Node 13) Generate Variance Account Using FlexBuilder Rules replicates your variance account FlexBuilder rules in the Account Generator.

To build accounts, Generate Accounts Using FlexBuilder Rules process calls the appropriate functions that were generated during your upgrade from Release 10.7.

If you are upgrading from Release 10, follow the guidelines in the FlexBuilder chapter of the *Oracle E-Business Suite Upgrade Preparation Manual*.

## Using the Workflow Monitor with the Account Generator

If you are using the Workflow Monitor to view account generation results during testing or diagnosing a problem, set the profile option *Account Generator: Run in Debug Mode* to Yes. This ensures that runtime data is saved. After you finish testing, always set this profile option to No, to maintain performance. Use the Purge Obsolete Workflow

Runtime Data process, accessible through the System Administrator responsibility, to periodically purge the runtime data.

To monitor a document as it proceeds through a workflow, you need to provide the Workflow Monitor with an item key, which is specific both to the document you are monitoring and the process in which you're monitoring it.

For information on how to use the Workflow Monitor, see *Monitoring Workflow Processes, Oracle Workflow User's Guide*.

**To determine the item key for the Account Generator workflows:**

1. In Purchasing, open the document you want to monitor and choose Tools > Examine from the Help menu.  
  
Tools > Examine is sometimes controlled by a password. If you don't have access to it, see your system administrator.
2. Select the down-arrow box to the right of the Block field.
3. In the list of values that appears, choose PARAMETER and choose OK.
4. In the Field field, enter charge\_acc\_wf\_itemkey.  
  
The item key appears in the Value field. Use this item key when you are prompted by the Workflow Monitor to enter the item key.

## Requisition Approval Workflow

Whenever you submit a requisition for approval or take an action in the Notifications Summary window, Purchasing uses Oracle Workflow technology in the background to handle the approval process. Workflow uses the approval controls and hierarchies you define according to the setup steps in the section *Setting Up Document Approval and Security*, page 2-1 to route documents for approval. You can use the Workflow Builder to modify your approval process.

The requisition approval workflow consists of processes, which are viewable in the Workflow Builder as a diagram, some of whose objects and properties you can modify. Each workflow process, in turn, consists of individual function activities.

The PO Requisition Approval workflow is initiated at the following points in Purchasing:

- When you choose Submit for Approval (and then choose OK) in the Approve Document window in Purchasing or submit a requisition for approval in Oracle iProcurement.
- When you respond to a reminder in the Notifications Summary window reminding you to submit a document for approval that has not yet been submitted.
- When you run Requisition Import. If the requisitions are incomplete or

preapproved, Requisition Import launches the PO Requisition Approval workflow to approve the requisitions, unless you specify not to.

For information on the purchase order approval workflow, see: Purchase Order Approval Workflow, page E-89.

## Customizing the PO Requisition Approval Workflow

Use the Oracle Workflow Builder to customize workflows. When you customize a workflow, only those documents that are submitted for approval *after* you customize it are affected by the customized workflow.

You can also use the Workflow Builder to create unique approval workflows for each document type in your organization. You associate particular workflows with certain document types in the Document Types window. See: Defining Document Types, page 1-67.

You can use the Workflow Monitor to follow where certain documents are in a workflow process. See: Monitoring Workflow Processes, *Oracle Workflow User's Guide*.

### **To display the workflow in the Oracle Workflow Builder:**

1. Choose Open from the File menu, and connect to the database.

See: Opening and Saving Item Types, *Oracle Workflow Developer's Guide*.

The Display name of the PO Requisition Approval workflow is *PO Requisition Approval*. The name of its Workflow definition file is *poxwfrqa.wft*.

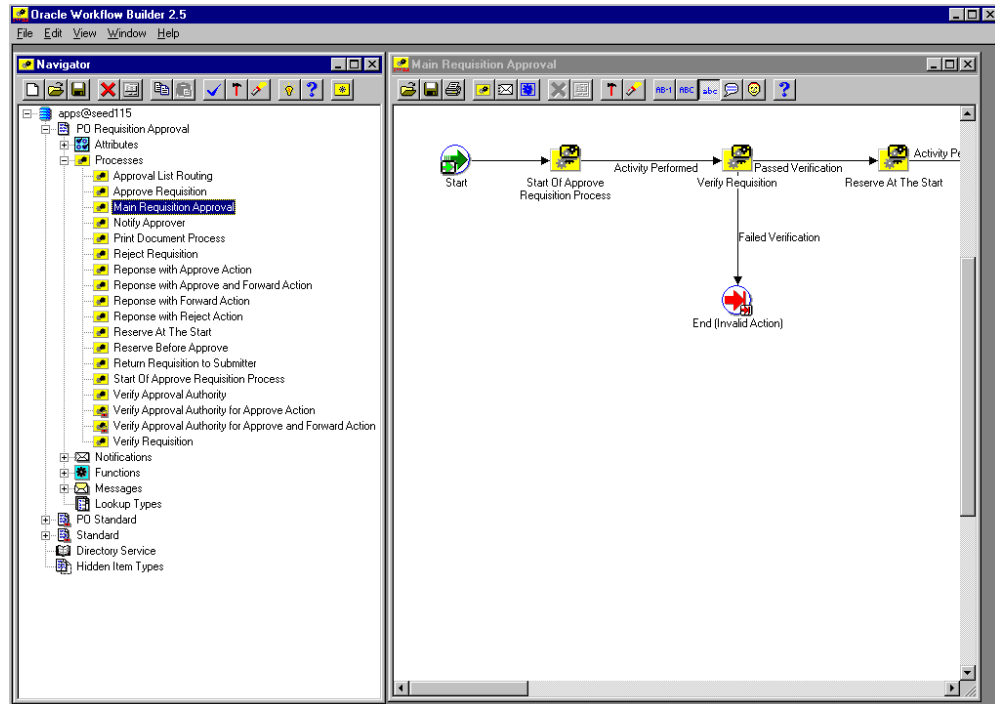

2. Expand the data source, then the PO Requisition Approval item type branch within that data source.
3. Expand the Processes branch within the PO Requisition Approval branch, then double-click on a process activity to display its diagram.

### Creating a New Custom Process

You can either modify the default PO Requisition Approval workflow that Purchasing provides, or copy it and create a whole new workflow. You can use the Document Types window to select a custom PO Requisition Approval Workflow Startup Process for specific document types or operating units.

If you create different workflows for different documents or operating units, the recommended practice is not to copy and rename the item type (such as PO Requisition Approval 1), but to copy and rename the Workflow Startup Process, which you will modify to call your own custom subprocesses. All of your operating units will point to the same item type, and will use the default item attributes and other activities that the item type requires, but one operating unit will also use your custom startup process.

**Important:** Creating a new workflow process with a new Internal Name affects the implementation of future upgrades. See: Upgrade Support, page E-3.

## Required Modifications

There are no required modifications you need to make to the PO Requisition Approval workflow. However, this documentation assumes that you have already set up Purchasing and performed the Workflow setup steps described in *Workflow Setup Options*, page 1-85.

## Supported and Unsupported Customizations

The following is a discussion of what you can and *definitely cannot* modify in the PO Requisition Approval workflow. For those things you *can* modify, the discussion includes important guidelines that you need to be careful of when making customizations.

For important information on how to customize workflows, see the *Oracle Workflow Developer's Guide*.

To further help you with your customizations, refer to the sections later in this document, starting with *The PO Requisition Approval Item Type*, page E-56. These sections describe the components of the main processes in the PO Requisition Approval workflow. If you haven't already, see also: *Customization Guidelines*, page E-2.

**Important:** If a particular Workflow object does not appear in the following sections on the lists of things you can customize, do not modify it, regardless of its access level.

## Attributes

You can modify the following attribute only, by changing its Default Value:

- Send PO Autocreate to Background

Its Default Value is Y for Yes, to send automatic document creation to Background mode, but you can change it to N for No, to operate in Online mode. See: *Choosing Workflow Options*, page 1-85.

## Processes

If you modify a process, it is essential that the basic flow remain intact to maintain data integrity in the database. For example, you should not remove or bypass the function activity *Is Document Complete?* in the *Verify Requisition* subprocess because this may allow incomplete data to be inserted into the database tables. However, you could add additional checks (processes or function activities) before allowing data to be inserted into the tables.

If you modify any process, either by replacing a portion of its flow or by adding additional function activities, remember the following:

- Attributes that are set by default function activities in the default processes must also be set if you replace default function activities with ones of your own. That is, if a function activity in that process uses a SetItemAttr statement, then that function activity is setting an attribute to be used by another function activity later. Therefore, your new function activity must do the same. You should also preserve SetItemUserKey and SetItemOwner statements, if any. (Depending on your customizations, you may also want to preserve GetItemAttr statements.)
- Any database state maintained by the default processes must also be maintained by processes you customize. That is, if a function activity in that process uses an Update or Insert Into statement, then that function activity is updating or inserting rows in the database. Therefore, your new function activity must maintain the same database state.

To get a list of the workflow function activities that use SetItemAttr, GetItemAttr, SetItemUserKey, SetItemOwner, Insert Into, or Update statements, run the PL/SQL script powfcust. For instructions on running this script, see: Customization Guidelines, page E-2.

The process listed below may be modified as your business processes require; however, remember that after your customizations, the attributes that were set and the database states that were maintained by the default process must also be set or maintained by your customized process.

- Print Document Process

You may add your own additional function activities to the processes listed below, but do not remove any default function activities from them:

- Approve Requisition
- Reject Requisition
- Reserve at the Start
- Reserve Before Approve
- Return Requisition to Submitter
- Verify Approval Authority
- Verify Approval Authority for Approve Action
- Verify Approval Authority for Approve and Forward Action
- Verify Requisition
- Approval List Routing



- Main Requisition Approval
- Notify Approver
- Response with Approve Action
- Response with Approve and Forward Action
- Response with Forward Action
- Response with Reject Action
- Reserve Before Approve
- Start of Approve Requisition Process

## Notifications

All of the notifications can be modified to meet your individual business needs. However, if the notification has a reply code, make sure that the Result Type of your customized notification matches the transitions in the workflow diagram. See: *To Create a Notification Activity, Oracle Workflow Developer's Guide*. See also: *Message Result, Oracle Workflow Developer's Guide* and *To Create a Message, Oracle Workflow Developer's Guide*.

## Function Activities

You cannot modify any functions in the PO Requisition Approval workflow.

However, you can replace some function activities with function activities of your own. When you replace a function activity, you are modifying the process in which it is contained. See the guidelines for customizing the PO Requisition Approval processes in the section **Processes** above.

If you substitute default function activities in a process with function activities that you create, you must remember the following:

- The result type of your new function activity must match the result type of the default activity. That is, the Result Type of the function activity in the Workflow Builder needs to match the result type specified by that function activity's corresponding PL/SQL procedure—for example, a Result Type of Yes/No. It also means that if you have, for example, two results (such as Yes and No) in your function activity and corresponding PL/SQL procedure, you need to make sure that there are two corresponding transitions in the workflow diagram (one for Yes and one for No). If you alter the result types and transitions in a process, be careful that you aren't deleting or bypassing any special transitions or checks.
- Just as with **Processes** above, any attributes that were set by the default function

activity must also be set by your customized function activity.

- Just as with **Processes** above, any database state maintained by the default function activity must also be maintained by the customized function activity.

## Messages

All of the messages can be modified to meet your individual business needs.

## Lookup Types

All of the lookup types can be modified to meet your individual business needs.

**Note:** If you change a lookup type, be sure that all activities that use the lookup type allow for the change. For example, if you change the lookup type from Yes/No to something else, the activities that use that lookup type should also change their Result Type from Yes/No to whatever new lookup type you created. See: Lookup Types, .

## The PO Requisition Approval Workflow Item Type

The Requisition Approval process is associated with an item type called PO Requisition Approval. This item type identifies all requisition approval workflow processes available. The following workflow processes are associated with PO Requisition Approval:

- Main Requisition Approval, page E-62
- Start of Approve Requisition Process, page E-67
- Verify Requisition, page E-69
- Reserve At The Start, page E-71
- Verify Approval Authority, page E-72
- Approval List Routing, page E-74
- Reject Requisition, page E-75
- Return Requisition to Submitter , page E-77
- Notify Approver, page E-78
- Response with Approve Action, page E-80
- Response with Approve and Forward Action, page E-81

- Response with Forward Action, page E-82
- Response with Reject Action, page E-83
- Reserve Before Approve, page E-83
- Approve Requisition, page E-85
- Print Document Process, page E-87
- Verify Approval Authority for Approve Action, page E-88
- Verify Approval Authority for Approve and Forward Action, page E-88

The PO Requisition Approval item type also has many attributes associated with it. These attributes reference information in the Purchasing application tables. The attributes are used and maintained by function activities as well as notification activities throughout the process.

### PO Requisition Approval Workflow Item Type Attributes

Display Name	Description	Type	Length/ Format / Lookup Type
Action history of the document	Action history of the document as displayed in the approval notification	Document	
Application ID	Unique identifier for the application (such as Purchasing)	Number	
Approval List ID	Unique identifier for the list of approvers that the requester sees or modifies in iProcurement	Number	
Approval Path ID	Unique identifier for the approval hierarchy	Number	
Approver Employee ID	Unique identifier for the approver	Number	
Approver Display Name	Approver's name as displayed in Purchasing	Text	
Approver User Name	User name of the approver	Text	

<b>Display Name</b>	<b>Description</b>	<b>Type</b>	<b>Length/ Format / Lookup Type</b>
Approve Requisition Message	Message header that indicates the specific document requiring approval	Document	
Authorization Status	Status of the document, such as Approved or Incomplete	Text	25
Authorization Status Display	Document status as displayed in Purchasing	Text	25
Closed Code	Indicator that the document is closed	Text	25
Closed Code Display	Closed status as displayed in Purchasing	Text	25
Concurrent Request ID	Request ID for the Document Approval Manager	Number	
Context ORG_ID	Unique identifier for the organization	Number	
Document ID	Unique identifier for the document	Number	
Document Manager Error Number	Error number for the Document Manager Failed notification	Number	
Document Subtype	Document subtype, such as Purchase or Internal	Text	25
Document Subtype Display	Document subtype as displayed in Purchasing	Text	25
Document Type	Document type, such as Requisition	Text	25
Document Type Display	Document type as displayed in Purchasing	Text	25
Emergency PO Number	Purchase order number reserved in advance for a requisition created in iProcurement	Text	20

<b>Display Name</b>	<b>Description</b>	<b>Type</b>	<b>Length/ Format / Lookup Type</b>
Forward From Display Name	Name of the forward-from person as displayed in Purchasing	Text	60
Forward From ID	Unique identifier for the forward-from person	Number	
Forward From User Name	User name for the forward-from person	Text	60
Forward To Display Name	Name of the forward-to person as displayed in Purchasing	Text	60
Forward To ID	Unique identifier for the forward-to person	Number	
Forward-To ID Old Value	Item attribute for internal use that keeps track of the previous forward-to person	Number	
Forward To User Name	User name for the forward-to person	Text	60
Functional Currency	Functional currency	Text	
Interface Source	Source of the requisition, such as ICX or POR	Text	25
"Invalid Forward To" Translated Message	Message used when approving the document if the forward-to user name is invalid	Text	
No Approver Found Message	Message header that indicates the specific document for which the approver was not found	Document	
Note	Note to the approver	Text	240
Online Report ID For Doc Complete Check	Unique identifier for the error message displayed after saving a document that is in error	Number	

<b>Display Name</b>	<b>Description</b>	<b>Type</b>	<b>Length/ Format / Lookup Type</b>
Online Report Text For Doc Complete Check	Text of the error message displayed after saving a document that is in error	Text	2000
Open From Command	Command that Purchasing sends to open the document from the notification	Form	
Original Authorization Status	Status of the document before it was submitted for approval	Text	25
PL/SQL Error Document	The document that was being approved when a PL/SQL error occurred	Text	2000
PL/SQL Error Location	Where an internal, PL/SQL error occurred	Text	2000
PL/SQL Error Message	Text for the notification sent when a PL/SQL error occurs	Text	2000
Preparer Display Name	Name of the person who created the document, as displayed in Purchasing	Text	80
Preparer ID	Unique identifier for the person who created the document	Number	
Preparer User Name	User name for the person who created the document	Text	60
Print Document	Indicator of whether Print Document was selected when submitting the requisition for approval	Text	
"Requires Approval" Translated Message	Message text used to indicate the document requires approval	Text	
Requisition Amount Display	Total amount, without tax, as displayed in Purchasing	Text	

<b>Display Name</b>	<b>Description</b>	<b>Type</b>	<b>Length/ Format / Lookup Type</b>
Requisition Approved Message	Message header that indicates the specific document requiring approval	Document	
Requisition Detail	Used in iProcurement to enable you to view requisition details	URL	
Requisition Description	Header description	Text	240
Requisition line details	Requisition line details displayed in the approval notification	Document	
Requisition Number	Requisition number	Text	20
Requisition Rejected Message	Message header that indicates the specific document that was rejected	Document	
Responder Display Name	Name of the approver as displayed in Purchasing	Text	
Responder ID	Unique identifier for an approver's response to a notification	Number	
Responder User Name	User name of the approver	Text	
Response Forward-To	Forward-to name as entered by the person forwarding the document	Text	100
Responsibility ID	Unique identifier for the requester's user responsibility	Number	
Resubmit Requisition	Used in iProcurement to enable you to resubmit a requisition	URL	
Send PO Autocreation to Background	Indicator of whether to send automatic documentation creation to online or background modes	Text	1
System Administrator Error Message	Document Approval Manager failed message	Text	2000

Display Name	Description	Type	Length/ Format / Lookup Type
Tax Amount Display	Tax amount displayed in the approval notification	Text	30
Total Amount Display	Total document amount, with tax, displayed in the approval notification	Text	30
Update Requisition	Used in iProcurement to enable you to update a requisition	URL	
User ID	Unique identifier for the requester	Number	

## Summary of the Main Requisition Approval Process

To view the properties of the Main Requisition Approval process, select the process in the navigator tree, then choose Properties from the Edit menu. The Main Requisition Approval process has a result type of PO Main Requisition Approval Process Result, indicating that when the process completes, it has a result of Approved, Invalid Action, No Approver Available, or Rejected. These results correspond to the lookup codes in the PO Main Requisition Approval Process Result lookup type in the PO Standard item type.

This process activity is also runnable, indicating that it can be initiated as a top-level process to run by making calls to the Workflow Engine *CreateProcess* and *StartProcess* APIs.

The Main Requisition Approval workflow begins when you submit a requisition in Purchasing or iProcurement. This workflow handles both kinds of requisitions—those created in iProcurement and those created in Purchasing.

The first part of the process diagram, through node 16, is shown below:

The rest of the process diagram, starting with node 16, is shown below:

Node 2 sets all startup values, sets the requisition status to In Process, obtains the approval mode used, and retrieves requisition attributes.

If the requisition passes verification at node 3, node 5 attempts to reserve funds at the start of the approval process, for iProcurement requisitions, if you use encumbrance.

Node 6 checks if the requester in iProcurement created or modified an approval list. If not—or if the requisition was created in Purchasing—node 7 builds a default approval list based on the approval hierarchy setup in Purchasing.



If node 7 cannot build a default approval list (for example, because of a system failure or a problem in the approval hierarchy), the requisition is returned to the requester at node 8.

Node 10 checks if Owner Can Approve is enabled for the document type, and node 15 verifies the owner's approval authority. If the owner cannot approve the document, node 11 routes the requisition according to the approval list.

If an approver responds with Reject, node 12 rejects the requisition, and node 13 sends a notification of the rejection to the requester. If there is a problem with the requisition, it is returned at node 8.

If an approver responds with Approved, the workflow begins to approve the document, starting at node 18. At node 18, the workflow reserves funds for the document if encumbrance accounting is being used and if funds for the document aren't already reserved, before approving the document at node 20.

If the requisition is forwarded, node 19 rebuilds the approval list to include that forward-to person. Then node 11 forwards the requisition to that approver.

If node 10 and 15 confirm that the requester can approve the document, the requisition status is set to Pre-Approved at node 16. Then, if no more approvers are indicated by node 17, the workflow approves the document: node 18 makes sure funds are reserved if encumbrance is used, and node 20 approves the document and sets its status to Approved.

Finally:

- Node 23 turns iProcurement information templates into attachments, if information templates were used in iProcurement.
- Node 24 sends a notification to the document owner that the requisition was approved.
- Node 25 prints the document if Print was selected when the requisition was submitted.
- Node 26 looks to the item attribute Send PO Autocreation to Background, which sets the processing mode to Background (if the item attribute is set to Y) or Online (if the item attribute is set to N) specifically for automatic document creation. How this mode is set affects system performance. For definitions of Background and Online modes, see: Profile Options in Purchasing, page C-1.
- Node 28 automatically starts the PO Create Documents workflow, which creates purchase orders and releases from the approved requisition lines, if you've allowed this in the Purchasing setup. See: Choosing Workflow Options, page 1-85.

## **Main Requisition Approval Process Activities**

The following is a description of each activity in the Main Requisition Approval

process.

### **Start of Approve Requisition Process (Node 2)**

See: Start of Approve Requisition Process, page E-67.

### **Verify Requisition (Node 3)**

See: Verify Requisition, page E-69.

### **Reserve At The Start (Node 5)**

See: Reserve At The Start, page E-71.

### **Does Approval List Exist? (Node 6)**

This activity checks if a requester in iProcurement created or modified an approval list.

### **Build Default Approval List (Node 7)**

If a requester in iProcurement did not create or modify the approval list, or if the requisition was submitted in Purchasing, this activity builds an approval list based on the approval hierarchy setup in Purchasing.

### **Can Owner Approve? (Node 10)**

This function activity checks if Owner Can Approve is enabled for the specific document type in the Document Types window. See: Defining Document Types, page 1-67. If the owner can approve, the subprocess Verify Approval Authority verifies the owner's approval authority. If not, the subprocess Approval List Routing begins.

### **Verify Approval Authority (Node 15)**

See: Verify Approval Authority, page E-72.

### **Set Req Status to Pre-Approved (Node 16)**

If the requester has the approval authority to approve the document, this function activity sets the requisition's status to Pre-Approved. The status is set to Pre-Approved until the subprocess Approve Requisition or the subprocess Reserve Before Approve explicitly sets the status to Approved.

This activity updates the document status only, not the action history. Later another activity, Update Action History, updates the Action History window.

### **Is Approval List Empty? (Node 17)**

This activity makes sure there are no more approvers. If there are not, the workflow begins approving the requisition. If there are, the workflow routes the document for their approval.

### **Approval List Routing (Node 11)**

See: Approval List Routing, page E-74.

### **Reject Requisition (Node 12)**

See: Reject Requisition, page E-75.

### **Requisition Rejected (Node 13)**

This activity sends a notification to the requester that the requisition has been rejected.

### **Return Requisition to Submitter (Node 8)**

See: Return Requisition to Submitter , page E-77.

### **Rebuild Approval List After Forward Action (Node 19)**

If the requisition is forwarded, this activity rebuilds the approval list to include that forward-to person.

### **Oracle iProcurement Example:**

- Approver A
- Approver B
- Approver C

A requester in iProcurement adds Approvers X and Y:

- Approver A
- Approver B
- Approver C
- Approver X
- Approver Y

Approver C, however, forwards the document to Approver D, who is part of another branch in the hierarchy:

- Approver D
- Approver E
- Approver F

The approval routing will then be as follows, assuming Approver D does not have final approval authority:

- Approver A
- Approver B
- Approver C
- Approver X
- Approver Y
- Approver D
- Approver E
- Approver F

### **Reserve Before Approve (Node 18)**

See: Reserve Before Approve, page E-83.

### **Approve Requisition (Node 20)**

See: Approve Requisition, page E-85.

### **Is Requisition Created Through the Web? (Node 22)**

This activity checks if the requisition was created through iProcurement.

### **Create Information Template Attachment (Node 23)**

This activity turns iProcurement information templates, if used, into attachments. The Define Information Template window in Purchasing lets you define these templates for iProcurement. For example, you can create a template for ordering business cards in iProcurement. The template used to gather the business card information is converted into an attachment in Purchasing by this activity.

**Note:** Information templates in iProcurement are not the same as requisition templates in Purchasing. See the *Oracle iProcurement Implementation Manual*.

### **Requisition Approved (Node 24)**

This function activity sends a notification to the appropriate individual that the requisition has been approved.

This notification's message uses Document type item attributes to call two PL/SQL functions, one that retrieves all of the lines in the document and displays them in the notification, and another that retrieves the action history of the document and displays that in the notification.

### **Print Document Process (Node 25)**

See: Print Document Process, page E-87.

### **Get AutoCreate PO Mode (Node 26)**

While the function activity Get Workflow Approval Mode sets the processing mode for the entire approval workflow in Purchasing, based on how the profile option *PO: Workflow Processing Mode* is set, this function activity looks to the item attribute Send PO Autocreation to Background, which enables you to change the processing mode specifically for automatic purchase order creation. Background mode enables you to proceed to your next Purchasing activity while the approval process for this document completes in the background.

### **Wait for Background Process (Node 27)**

If the item attribute Send PO Autocreation to Background is set to Yes, this function activity waits for the Workflow Background Engine to pick up this document for processing by the workflow. This activity enables you to proceed to your next Purchasing activity while the approval process for this document completes in the background.

### **Launch Create PO Workflow (Node 28)**

After a requisition is approved, the Main Requisition Approval process launches a workflow for the automatic creation of purchase orders if you've allowed automatic approval for approved requisition lines. Automatic approval is allowed for approved requisition lines when the item attribute Is Automatic Creation Allowed? is set to Y for Yes. (By default, this item attribute is set to Y.)

## **Summary of the Start of Approve Requisition Process**

To view the properties of the Start of Approve Requisition Process, select the process in the navigator tree, then choose Properties from the Edit menu. This subprocess has a result type of PO Activity Performed, indicating that when the subprocess completes, it has a result of Activity Performed. This result corresponds to the lookup code in the PO Activity Performed lookup type in the PO Standard item type.

This process activity is not runnable, indicating that it cannot be initiated as a top-level process to run, but can be run only when called by another higher-level process.

This subprocess begins at node 1.

Node 2 removes previous notifications for this document if previous versions of the

document that were sent to the workflow were incomplete or rejected. Node 3 sets startup values. Node 4 sets the requisition status to In Process.

Node 5 looks for an approval list created in iProcurement. (Here, node 5 finds the approval list and updates the Purchasing approval list tables. The activity Does Approval List Exist? in the Main Requisition Approval Process simply checks again for the approval list to determine how to branch in the Main process.)

Node 6 determines whether the requisition approval process is set up to run in Online or Background performance modes according to the profile option *PO: Workflow Processing Mode*, and if it is, node 7 waits for the background engine to begin. Node 8 retrieves requisition attributes (requisition information and internal Workflow attributes).

## **Start of Approve Requisition Process Activities**

The following is a description of each activity in the Start of Approve Requisition Process, listed by the activity's display name.

### **Remove All Notifications For This Document (Node 2)**

This function activity removes previous notifications for a requisition previously submitted to workflow that was not completed because of an error or because of an action such as rejection.

### **Set Workflow Startup Values (Node 3)**

This function activity sets all initial values necessary to identify a unique requisition.

### **Set Req Status to In-Process and Update with Item Type & Key (Node 4)**

This function activity sets the document status to In Process and updates the document header with the item type and item key, which indicate that this requisition has been submitted to Workflow.

### **Find Approval List (Node 5)**

This activity looks for an approval list created in iProcurement.

### **Get Workflow Approval Mode (Node 6)**

This function activity retrieves the value from the profile option *PO: Workflow Processing Mode*, which lets you choose whether you want the approval process to run in Online or Background modes. For definitions of Background and Online modes, see: Profile Options in Purchasing, page C-1.

### **Wait for Background Process (Node 7)**

If the profile option *PO: Workflow Processing Mode* is set to Background, this function

activity waits for the Workflow Background Engine to pick up this document for processing by the workflow. This activity enables you to proceed to your next Purchasing activity while the approval process for this document completes in the background. See: To Schedule Background Engines, *Oracle Workflow Developer's Guide*.

### **Get Requisition Attributes (Node 8)**

This function activity retrieves key values from the requisition header and lines, and assigns them to Workflow attributes.

## **Summary of the Verify Requisition Subprocess**

To view the properties of the Verify Requisition subprocess, select its process activity in the navigator tree, then choose Properties from the Edit menu. The Verify Requisition subprocess has a result type of PO Document Verification, indicating that when the subprocess completes, it has a result of Failed Verification or Passed Verification. These results correspond to the lookup codes in the PO Document Verification lookup type, in the PO Standard item type.

This process activity is not runnable, indicating that it cannot be initiated as a top-level process to run, but rather can only be run when called by another higher level process as a subprocess.

This subprocess activity makes sure the requisition is complete and the information is valid.

The subprocess begins at node 1.

Node 2 checks that the document status is compatible with an approval action (for example, its status is not closed, frozen, or on hold). Node 4 verifies that the document is complete, such as ensuring that it contains at least one line and one distribution.

If the document state does not allow an approval action at node 2 or the document is incomplete at node 4, a notification of such at node 8 or 9 respectively is sent to the requester. Then, at node 10, the requisition status is set back to what it was before it entered this subprocess, and the workflow ends at node 11. If you modify and resubmit the requisition or create a new one, the PO Requisition Approval workflow starts over again when you submit the requisition for approval.

If the document passes validation at nodes 2 and 4, node 6 records in the Action History window that the document has been submitted for approval.

If the Document Approval Manager fails at node 2 or 4, the notification activity at node 3 or 5 sends a notification of the failure to the requester. Once the Document Approval Manager is restarted successfully, the workflow continues if the requester or system administrator responds to the notification with Retry.

See: Document Status Checks, page 2-21. See: Document Submission Checks, page 2-22.

## Verify Requisition Subprocess Activities

The following is a description of each activity in the Verify Requisition subprocess, listed by the activity's display name.

### Start (Node 1)

This is a Standard function activity that simply marks the start of the subprocess.

### Does Document State Allow Approval Action? (Node 2)

This activity checks if the document status is compatible with the approval action. Examples of document statuses that allow an approval action are Incomplete, In Process, and Pre-Approved.

### Is Document Complete? (Node 4)

This activity verifies that the requisition is complete—for example, verifying that all the quantities match, and at least one line and one distribution exist.

### Record Submit In Action History (Node 6)

This activity inserts a Submit Action row into the PO\_ACTION\_HISTORY table to record that the document has been submitted for approval. It also inserts an additional row with a null ACTION\_CODE to simulate a forward-to action, since the document status is In Process. The document manager looks for this row.

### Document Manager Failed (Nodes 3 and 5)

If the Document Approval Manager fails, the requester receives this notification that it failed. Once a system administrator successfully restarts the Document Approval Manager, the requester must respond to the notification by choosing Retry, so that the workflow can continue.

### Document Failed State Check (Node 8)

This activity sends a notification to the requester that the document failed the state check. See: Document Status Checks, page 2-21.

### Document Failed Correctness Check (Node 9)

This activity sends a notification to the requester that the document failed the correctness check. See: Document Submission Checks, page 2-22.

### Set Req Status to Original Status (Node 10)

This function activity sets the document back to its status before it entered this process activity, if the document has failed state or correctness checks.



## End (Nodes 7 and 11)

This function activity marks the end of the process. Although the activity itself does not have a result type, each node of this activity in the process must have a process result assigned to it. The process result is assigned in the property page of the activity node. Since the Verify Requisition subprocess activity has a result type of PO Document Verification, each End activity node must have a process result matching one of the lookup codes in the PO Document Verification lookup type.

## Summary of the Reserve At The Start Subprocess

To view the properties of the Reserve At The Start subprocess, select its process activity in the navigator tree, then choose Properties from the Edit menu. The Reserve At The Start subprocess has a result type of PO Activity Performed, indicating that when the subprocess completes, it has a result of Activity Performed. This result corresponds to the lookup code in the PO Activity Performed lookup type, in the PO Standard item type.

This process activity is not runnable, indicating that it cannot be initiated as a top-level process to run, but rather can only be run when called by another higher level process as a subprocess.

The subprocess begins at node 1.

This subprocess, at node 7, tries to reserve funds at the start of the approval process for those requisitions created in iProcurement, if encumbrance is used.

First, node 2 checks if the requisition was created specifically in iProcurement. If it was, there is no need to check for an interface source of Requisition Import because iProcurement requisitions don't use Requisition Import but are saved directly to the Oracle internal tables.

Node 3 checks specifically for requisitions created in Web Requisitions releases prior to iProcurement (if you still have some Web Requisitions requisitions in your system). These requisitions still pass through Requisition Import. See: Requisition Import, page 13-29.

If the Document Approval Manager fails at node 7, node 10 sends a notification of the failure to the requester. Once the Document Approval Manager is restarted successfully, the workflow continues if the requester or system administrator responds to the notification with Retry.

## Reserve At The Start Subprocess Activities

The following is a description of each activity in the Reserve At The Start subprocess, listed by the activity's display name.

### **Start (Node 1)**

This is a Standard function activity that simply marks the start of the subprocess.

### **Is Requisition Created Through the Web? (Node 2)**

This activity determines if the requisition was created through iProcurement.

### **Is Interface Source Req Import? (Node 3)**

This activity checks if the requisition sent through Requisition Import was created in Web Requisitions Release 11.

### **Is Encumbrance On and Is Document Not Reserved? (Node 5)**

This function activity checks whether you are using encumbrance accounting, and whether the document is already reserved.

### **Reserve Document (Node 7)**

This activity tries to reserve funds for the document.

### **Document Manager Failed (Node 10)**

If the Document Approval Manager fails, the requester receives this notification that it failed. Once a system administrator successfully restarts the Document Approval Manager, the requester must respond to the notification by choosing Retry, so that the workflow can continue.

### **End (Nodes 4, 6, 8, and 9)**

This function activity marks the end of the process. Although the activity itself does not have a result type, each node of this activity in the process must have a process result assigned to it. The process result is assigned in the property page of the activity node. Since the Reserve at the Start subprocess activity has a result type of PO Activity Performed, each End activity node must have a process result matching one of the lookup codes in the PO Activity Performed lookup type.

## **Summary of the Verify Approval Authority Subprocess**

To view the properties of the Verify Approval Authority subprocess, select its process activity in the navigator tree, then choose Properties from the Edit menu. The Verify Approval Authority subprocess has a result type of Yes/No, indicating that when the subprocess completes, it has a result of Yes or No. This result corresponds to the lookup codes in the Yes/No lookup type, in the Standard item type.

This process activity is not runnable, indicating that it cannot be initiated as a top-level process to run, but rather can only be run when called by another higher level process

as a subprocess.

The subprocess begins at node 1.

Node 2 checks the approver's approval authority limits defined in the Approval Groups and Assign Approval Groups windows. (See: Defining Approval Groups, page 1-21. See: Assigning Approval Groups, page 1-24.)

If the person has enough authority to approve the document, the function activity Is Forward-To Provided? (which is outside this subprocess, in the overall workflow) begins. If not, then the process activity Find Approver (outside this subprocess) begins.

If the Document Approval Manager fails at node 2, node 3 sends a notification of the failure to the approver. Once the Document Approval Manager is restarted successfully, the workflow continues if the approver or system administrator responds to the notification with Retry.

## **Verify Approval Authority Subprocess Activities**

The following is a description of each activity in the Verify Approval Authority subprocess, listed by the activity's display name.

### **Start (Node 1)**

This is a Standard function activity that simply marks the start of the subprocess.

### **Does Approver Have Authority? (Node 2)**

This function activity verifies the approver's authority based on the authority limits defined in the Approval Groups and Assign Approval Groups windows. See: Defining Approval Groups, page 1-21. See: Assigning Approval Groups, page 1-24.

### **Document Manager Failed (Node 3)**

If the Document Approval Manager fails, the approver receives this notification that it failed. Once a system administrator successfully restarts the Document Approval Manager, the approver must respond to the notification by choosing Retry, so that the workflow can continue.

### **End (Nodes 4 and 5)**

This function activity marks the end of the process. Although the activity itself does not have a result type, each node of this activity in the process must have a process result assigned to it. The process result is assigned in the property page of the activity node. Since the Verify Approval Authority subprocess activity has a result type of Yes/No, each End activity node must have a process result matching one of the lookup codes in the Yes/No lookup type.

## Summary of the Approval List Routing Subprocess

To view the properties of the Approval List Routing subprocess, select the process in the navigator tree, then choose Properties from the Edit menu. The Approval List Routing subprocess has a result type of PO Approval List Routing Result, indicating that when the process completes, it has a result of Document Approved, Reject, or Return. These results correspond to the lookup codes in the PO Approval List Routing Result lookup type in the PO Standard item type.

This process activity is not runnable, indicating that it cannot be initiated as a top-level process to run, but rather can be run only when called by another higher-level process.

This subprocess begins at node 1.

This subprocess starts when a requisition requires additional approval. Node 2 finds the first (or next) approver in the approval list. If that approver is invalid (for example, the approver left the company shortly after the requisition was submitted), node 3 rebuilds the approval list without that approver. If node 3 cannot rebuild the approval list (for example, because of a system failure or a problem with the approval hierarchy), this subprocess ends at node 4, and the workflow returns the requisition to the requester.

At node 5, this subprocess branches differently depending on the approver's response: a rejection branches to node 6, a Forward action branches to node 8, an approval branches to node 9, and an Approve And Forward action branches to node 10. Each of these nodes records the approver's response in the PO\_APPROVAL\_LIST\_HEADERS and PO\_APPROVAL\_LIST\_LINES tables and updates the action history accordingly.

Node 11 checks if the approval list is empty before attempting to finish the approval routing. Node 12 checks if the requisition is Pre-Approved. (If the requisition has been approved, its status is set to Pre-Approved until the Approve Requisition subprocess or Reserve Before Approve subprocess later sets its status to Approved.)

## Approval List Routing Subprocess Activities

The following is a description of each activity in the Approval List Routing subprocess, listed by the activity's display name.

### Get Next Approver (Node 2)

This activity finds the first (or next) approver in the approval list.

### Rebuild Approval List for Invalid Approver (Node 3)

If an approver is invalid (for example, the approver left the company shortly after the requisition was submitted), this activity rebuilds the approval list without that approver.

**Note:** If the approver does not have a logon user name, this activity

does *not* rebuild the approval list in that instance.

### **Notify Approver (Node 5)**

See: Notify Approver, page E-78.

### **Response with Reject Action (Node 6)**

See: Response with Reject Action, page E-83.

### **Response with Approve Action (Node 9)**

See: Response with Approve Action, page E-80.

### **Response with Approve and Forward Action (Node 10)**

See: Response with Approve and Forward Action, page E-81.

### **Is Approval List Empty? (Node 11)**

This activity makes sure there are no more approvers. If there are not, the workflow begins approving the requisition. If there are, the workflow routes the document for their approval.

### **Is Requisition Pre-Approved? (Node 12)**

This function activity checks if the purchase order has been pre-approved. A Pre-Approved document is one that has already been approved by the appropriate individual, who also chose to forward it to yet another person for approval. Or, it is a document that has been authorized for approval but for which funds have not yet been reserved. A document is still considered pre-approved until the subprocess Reserve Before Approve or the subprocess Approve Requisition sets its status to Approved.

## **Summary of the Reject Requisition Subprocess**

To view the properties of the Reject Requisition subprocess, select its process activity in the navigator tree, then choose Properties from the Edit menu. The Reject Requisition subprocess has a result type of PO Approval Action and Doc Verification, indicating that when the subprocess completes, it has a result of Invalid Action or Valid Action. These results correspond to the lookup codes in the PO Approval Action and Doc Verification lookup type, in the PO Standard item type.

This process activity is not runnable, indicating that it cannot be initiated as a top-level process to run, but rather can only be run when called by another higher level process as a subprocess.

The subprocess begins at node 1.

Node 2 changes the status of the document to Rejected. If the subprocess cannot reject the document (for example, the document status has changed to closed, frozen, or on hold,) node 5 sends a notification to the approver that the document could not be rejected. (If the document is rejected, a notification outside this subprocess in the Main Requisition Approval Process, sends the rejection notification.)

If the Document Approval Manager fails at node 2, node 4 sends a notification of the failure to the approver. Once the Document Approval Manager is restarted successfully, the workflow continues if the approver or system administrator responds to the notification with Retry.

## **Reject Requisition Subprocess Activities**

The following is a description of each activity in the Reject Requisition subprocess, listed by the activity's display name.

### **Start (Node 1)**

This is a Standard function activity that simply marks the start of the subprocess.

### **Reject the Requisition (Node 2)**

This activity sets a requisition to a Rejected status. It also reverses encumbrance if the document has been encumbered.

### **Unable to Reject Document (Node 5)**

This activity sends a notification to the approver that Purchasing was unable to reject the document-for example, because its status is closed, frozen, or on hold.

### **Document Manager Failed (Node 4)**

If the Document Approval Manager fails, the approver receives this notification that it failed. Once a system administrator successfully restarts the Document Approval Manager, the approver must respond to the notification by choosing Retry, so that the workflow can continue.

### **End (Nodes 3 and 6)**

This function activity marks the end of the process. Although the activity itself does not have a result type, each node of this activity in the process must have a process result assigned to it. The process result is assigned in the property page of the activity node. Since the Reject Requisition subprocess activity has a result type of PO Approval Action and Doc Verification, each End activity node must have a process result matching one of the lookup codes in the PO Approval Action and Doc Verification lookup type.

## Summary of the Return Requisition to Submitter Subprocess

To view the properties of the Return Requisition to Submitter subprocess, select its process activity in the navigator tree, then choose Properties from the Edit menu. The Return Requisition to Submitter subprocess has a result type of PO Activity Performed, indicating that when the subprocess completes, it has a result of Activity Performed. This result corresponds to the lookup code in the PO Activity Performed lookup type, in the PO Standard item type.

This process activity is not runnable, indicating that it cannot be initiated as a top-level process to run, but rather can only be run when called by another higher level process as a subprocess.

If the Approval List Routing subprocess activity (outside this subprocess activity, in the Main Requisition Approval process) doesn't find an approver, the Return Requisition to Submitter subprocess returns the requisition to the submitter

The subprocess begins at node 1. Node 2 sets the document back to its status before it entered this subprocess. Node 3 sends the requester a notification that no approver was found. Node 5 sends the last approver a notification that no approver was found; however, if node 4 finds that the requester is also the sole or last approver, the subprocess skips node 5 and ends at node 6 so that the requester does not receive two notifications.

## Return Requisition to Submitter Subprocess Activities

The following is a description of each activity in the Return Requisition to Submitter subprocess, listed by the activity's display name.

### Start (Node 1)

This is a Standard function activity that simply marks the start of the subprocess.

### Set Req Status to Original Status (Node 2)

This activity sets the requisition back to its status before it entered this process activity, if no approver was found.

### Notify Requestor of No Approver Available (Node 3)

This activity sends a notification to the requestor when no approver is found.

This notification's message uses Document type item attributes to call two PL/SQL functions, one that retrieves all of the lines in the document and displays them in the notification, and another that retrieves the action history of the document and displays that in the notification.

### Is Submitter Last Approver? (Node 4)

This function activity checks if the requester is also the sole or last approver. If so, the subprocess skips node 5 so as not to send the requester two notifications.

### Notify Last Approver of No Approver Found (Node 5)

This activity sends a notification to the last approver that the next approver was not found.

This notification's message uses Document type item attributes to call two PL/SQL functions, one that retrieves all of the lines in the document and displays them in the notification, and another that retrieves the action history of the document and displays that in the notification.

### End (Node 6)

This function activity marks the end of the process. Although the activity itself does not have a result type, each node of this activity in the process must have a process result assigned to it. The process result is assigned in the property page of the activity node. Since the Return Requisition to Submitter subprocess activity has a result type of PO Activity Performed, each End activity node must have a process result matching one of the lookup codes in the PO Activity Performed lookup type.

## Summary of the Notify Approver Subprocess

To view the properties of the Notify Approver subprocess, select the process in the navigator tree, then choose Properties from the Edit menu. The Notify Approver subprocess has a result type of PO Document Approval Action, indicating that when the process completes, it has a result of Approve, Approve and Forward, Forward, or Reject. These results correspond to the lookup codes in the PO Document Approval Action lookup type in the PO Standard item type.

This process activity is not runnable, indicating that it cannot be initiated as a top-level process to run, but rather can be run only when called by another higher-level process.

The subprocess begins at node 1.

Node 2 updates the action history. The action history records that the document awaits a response from the approver. (Other Update Action History function activities, used in other subprocesses, work *together* with this one to update the Action History window.)

Node 3 sends a notification to the approver that the document requires approval. If you have entered a Timeout in the Properties window for node 3, node 10 sends a reminder notification to the approver. The Timeout indicates how long the workflow waits before sending the reminder, if the approver does not respond. If you have entered a Timeout number for node 10, node 17 sends another reminder.

If the approver performs an Approve And Forward or a Forward action, nodes 4, 8, 11, 15, 18, and 22 make sure the forward-to is a valid user name.



The Approval List Routing subprocess, in which this subprocess is contained, behaves differently depending on how the approver responds here—with Approve And Forward, Approve, Reject, or Forward.

## **Notify Approver Subprocess Activities**

The following is a description of each activity in the Notify Approver subprocess, listed by the activity's display name.

### **Update Action History (Expect Response) (Node 2)**

This activity records in the action history that the document awaits a response from the approver. This activity works in conjunction with the other Update Action History activities, used in other subprocesses, to update the Action History window.

### **Approve Requisition Notification (Node 3)**

This activity sends a notification to the approver requesting approval.

This notification's message uses Document type item attributes to call two PL/SQL functions, one that retrieves all of the lines in the document and displays them in the notification, and another that retrieves the action history of the document and displays that in the notification.

### **Requisition Approval Reminder1 (Node 10)**

If no approval response is received after a period of time, this activity sends a first reminder if you designate a timeout period in the activity's Properties window.

This notification's message uses Document type item attributes to call two PL/SQL functions, one that retrieves all of the lines in the document and displays them in the notification, and another that retrieves the action history of the document and displays that in the notification.

### **Requisition Approval Reminder 2 (Node 17)**

If still no approval response is received, this activity sends a second reminder if you've entered a timeout period in the activity's Properties window.

This notification's message uses Document type item attributes to call two PL/SQL functions, one that retrieves all of the lines in the document and displays them in the notification, and another that retrieves the action history of the document and displays that in the notification.

### **Is Forward-To Valid (Nodes 4, 8, 11, 15, 18, and 22)**

This function activity checks that the Forward-To name entered in the Forward-To field, in response to an approval notification, is a valid user name.

## Summary of the Response with Approve Action Subprocess

To view the properties of the Response with Approve Action subprocess, select the process in the navigator tree, then choose Properties from the Edit menu. The Response with Approve Action subprocess has a result type of None, indicating that when the process completes, it doesn't end with a particular result, such as Approved or Rejected.

This process activity is not runnable, indicating that it cannot be initiated as a top-level process to run, but rather can only be run when called by another higher level process as a subprocess.

The subprocess begins at node 1.

Node 2 updates the Oracle internal approval list tables PO\_APPROVAL\_LIST\_HEADERS and PO\_APPROVAL\_LIST\_LINES with the approver's approval. Node 3 updates the action history with an Approve action. Node 6 verifies that the approver has approval authority if the requisition has not yet been preapproved at node 4. Then, node 8 sets the requisition's status to Pre-Approved. (Until the requisition is actually approved by the Approve Requisition subprocess or the Reserve Before Approve subprocess, the requisition is still considered Pre-Approved during this subprocess.)

## Response with Approve Action Subprocess Activities

The following is a description of each activity in the Response with Approve Action subprocess, listed by the activity's display name.

### Update Approval List Response (Node 2)

This activity updates the Oracle internal approval list tables PO\_APPROVAL\_LIST\_HEADERS and PO\_APPROVAL\_LIST\_LINES with the approver's approval.

### Update Action History (Approve) (Node 3)

This activity records an Approve action action in the Action History window.

### Set Req Status to Pre-Approved (Node 8)

A requisition's status is set to Pre-Approved if any of the following has occurred:

- It has already been approved by the appropriate individual, who also chose to forward it to yet another person for approval.
- It has been authorized for approval but funds have not yet been reserved for it.
- The document has been approved but the subprocess Approve Requisition or the subprocess Reserve Before Approve has not yet set its status to Approved.

This activity updates the document status only, not the action history.

#### **Is Requisition Pre-Approved? (Node 4)**

This function activity checks if the purchase order has been pre-approved.

#### **Verify Approval Authority for Approve Action (Node 6)**

See: Verify Approval Authority for Approve Action, page E-88.

### **Summary of the Response with Approve and Forward Action Subprocess**

To view the properties of the Response with Approve and Forward Action subprocess, select the process in the navigator tree, then choose Properties from the Edit menu. The Response with Approve and Forward Action subprocess has a result type of None, indicating that when the process completes, it doesn't end with a particular result, such as Approved or Rejected.

This process activity is not runnable, indicating that it cannot be initiated as a top-level process to run, but rather can only be run when called by another higher level process as a subprocess.

This subprocess begins at node 1.

Node 2 updates the Action History with an Approve and Forward action. If node 3 finds that the requisition has already been approved (considered Pre-Approved here), then this approver's authority does not need to be verified at node 4. Node 6 updates the Oracle internal approval list tables PO\_APPROVAL\_LIST\_HEADERS and PO\_APPROVAL\_LIST\_LINES with the approver's approval and forward action.

If node 3 finds that this requisition has not already been Pre-Approved, the approver's approval authority is verified at node 4. If the approver does not have sufficient authority, node 6 updates the approval list tables, and the workflow (outside this subprocess) looks for the next approver with authority.

If the approver does have authority, node 5 sets the requisition status to Pre-Approved. (Until the requisition is actually approved by the subprocess Approve Requisition or the subprocess Reserve Before Approve, the requisition is still considered Pre-Approved during this subprocess.)

**Note:** The sequence of events in this subprocess is important. Node 6 depends on the information provided by nodes 2 and 5.

### **Response with Approve and Forward Action Subprocess Activities**

The following is a description of each activity in the Response with Approve and Forward Action subprocess, listed by the activity's display name.

### **Update Action History (Approve/Forward) (Node 2)**

This activity records an Approve and Forward action in the Action History window.

### **Verify Approval Authority for Approve and Forward Action (Node 4)**

See: Verify Approval Authority for Approve and Approve/Forward Action, page E-88.

### **Set Req Status to Pre-Approved (Node 5)**

A requisition's status is set to Pre-Approved if any of the following has occurred:

- It has already been approved by the appropriate individual, who also chose to forward it to yet another person for approval.
- It has been authorized for approval but funds have not yet been reserved for it.
- The document has been approved but the subprocess Approve Requisition or Reserve Before Approve has not yet set its status to Approved.

This activity updates the document status only, not the action history.

### **Is Requisition Pre-Approved? (Node 3)**

This function activity checks if the requisition has been pre-approved.

### **Update Approval List Response (Node 6)**

This activity updates the Oracle internal approval list tables PO\_APPROVAL\_LIST\_HEADERS and PO\_APPROVAL\_LIST\_LINES with the approver's approval and forward action.

## **Summary of the Response with Forward Action Subprocess**

To view the properties of the Response with Forward Action subprocess, select the process in the navigator tree, then choose Properties from the Edit menu. The Response with Forward Action subprocess has a result type of None, indicating that when the process completes, it doesn't end with a particular result, such as Approved or Rejected.

This process activity is not runnable, indicating that it cannot be initiated as a top-level process to run, but rather can only be run when called by another higher level process as a subprocess.

This subprocess begins at node 1.

Node 2 updates the Oracle internal approval list tables PO\_APPROVAL\_LIST\_HEADERS and PO\_APPROVAL\_LIST\_LINES with the approver's forward action. Node 3 updates the Action History window with the Forward action.

## Response with Forward Action Subprocess Activities

The following is a description of each activity in the Response with Forward Action subprocess, listed by the activity's display name.

### Update Approval List Response (Node 2)

This activity updates the Oracle internal approval list tables PO\_APPROVAL\_LIST\_HEADERS and PO\_APPROVAL\_LIST\_LINES with the approver's forward action.

### Update Action History (Forward) (Node 3)

This activity records a Forward action in the Action History window.

## Summary of the Response with Reject Action Subprocess

To view the properties of the Response with Reject Action subprocess, select the process in the navigator tree, then choose Properties from the Edit menu. The Response with Reject Action subprocess has a result type of None, indicating that when the process completes, it doesn't end with a particular result, such as Approved or Rejected.

This process activity is not runnable, indicating that it cannot be initiated as a top-level process to run, but rather can only be run when called by another higher level process as a subprocess.

Node 2 updates the Oracle internal approval list tables PO\_APPROVAL\_LIST\_HEADERS and PO\_APPROVAL\_LIST\_LINES with the approver's rejection. Node 3 updates the Action History window with a Reject action.

## Response with Reject Action Subprocess Activities

The following is a description of each activity in the Response with Reject Action subprocess, listed by the activity's display name.

### Update Approval List Response (Node 2)

This activity updates the Oracle internal approval list tables PO\_APPROVAL\_LIST\_HEADERS and PO\_APPROVAL\_LIST\_LINES with the approver's rejection.

### Update Action History (Reject) (Node 3)

This activity records a Reject action in the Action History window.

## Summary of the Reserve Before Approve Subprocess

To view the properties of the Reserve Before Approve subprocess, select the process in

the navigator tree, then choose Properties from the Edit menu. The Reserve Before Approve subprocess has a result type of PO Reserve Before Approve, indicating that when the subprocess completes, it has a result of Forward, No, or Yes. These results correspond to the lookup codes in the PO Reserve Before Approve lookup type, in the PO Standard item type.

This process activity is not runnable, indicating that it cannot be initiated as a top-level process to run, but can be run only when called by another higher-level process.

If node 2 finds that encumbrance is on and funds for the document are not yet reserved, node 4 attempts to reserve funds for the document.

If funds cannot be reserved, node 6 sends the notification Unable To Reserve Document to the approver. The approver must then use the Approve Document window to try to reserve the document again if, for example, more funds have been allocated, and then respond with Retry in the notification; reject the document; or forward the document to somebody else with authority to reserve the funds.

If the approver forwards the document, node 7 checks if the forward-to approver has a valid user name. If so, node 8 sets the Forward-To/From information for the new approver.

If the approver rejects the document, node 10 rejects the requisition. If it cannot reject the requisition (because the document failed the state check—for example, its status has changed to closed, frozen, or on hold), node 13 sends a notification to the approver that the document could not be rejected.

If the Document Approval Manager fails at node 4 or 10, the notification activity at node 5 or 11 sends a notification of the failure to the approver. Once the Document Approval Manager is restarted successfully, the workflow continues if the approver or system administrator responds to the notification with Retry.

## **Reserve Before Approve Subprocess Activities**

Following is a description of each activity in the Reserve Before Approve subprocess, listed by the activity's display name.

### **Is Encumbrance On and Is Document Not Reserved? (Node 2)**

This function activity checks whether you are using encumbrance accounting and whether the document is already reserved.

### **Reserve Document (Node 4)**

This activity tries to reserve funds for the document.

### **Document Manager Failed (Nodes 5 and 11)**

If the Document Approval Manager fails, the approver receives this notification that it failed. Once a system administrator successfully restarts the Document Approval

Manager, the approver must respond to the notification by choosing Retry, so that the workflow can continue.

### **Unable to Reserve Document (Node 6)**

This activity notifies the requester that Purchasing failed to reserve funds for the requisition, and provides instructions for resolving the failure. The approver must then use the Approve Document window to try to reserve the document again if, for example, more funds have been allocated, and then respond with Retry in the notification; reject the document; or forward the document to somebody else with authority to reserve the funds.

### **Is Forward-To Valid (Node 7)**

This activity checks that the Forward-To name entered in the Forward-To field, in response to an approval notification, is a valid user name.

### **Set Forward-To/From Forward (Node 8)**

If the approver responded to the notification Unable to Reserve Document by forwarding the document, this function activity resets the Forward-To and Forward-From attributes.

### **Reject the Requisition (Node 10)**

This activity sets a requisition to a Rejected status and records the rejection in the Action History window. It also reverses encumbrance if the document has been encumbered.

### **Unable to Reject Document (Node 13)**

This activity sends a notification to the approver that Purchasing was unable to properly reject the requisition—for example, because its status is closed, frozen, or on hold.

## **Summary of the Approve Requisition Subprocess**

To view the properties of the Approve Requisition subprocess, select its process activity in the navigator tree, then choose Properties from the Edit menu. The Approve Requisition subprocess has a result type of PO Approval Action and Doc Verification, indicating that when the subprocess completes, it has a result of Invalid Action or Valid Action. These results correspond to the lookup codes in the PO Approval Action and Doc Verification lookup type, in the PO Standard item type.

This process activity is not runnable, indicating that it cannot be initiated as a top-level process to run, but rather can only be run when called by another higher level process as a subprocess.

The subprocess begins at node 1.

Node 2 checks if the document was already approved (for example, in the Reserve Before Approve subprocess). If so, this subprocess ends at node 3 and the workflow (in the Main Requisition Approval process), sends a notification to the requester that the document has been approved.

Otherwise, node 4 verifies that the document status is compatible with an approval action (for example, is not closed, frozen, or on hold), and node 6 verifies that the document is complete, such as ensuring that it contains at least one line and one distribution.

If the document does not allow an approval action at node 4 or is incomplete at node 6, the subprocess sends the appropriate notification at node 10 or 11 respectively. Then node 12 reverts the document status back to what it was before it entered this subprocess, and the workflow ends at node 13.

If the document passes the checks at nodes 4 and 6, node 8 approves the requisition, and node 14 retrieves requisition information and other internal workflow attributes, in case these have changed.

If the Document Approval Manager fails at node 4, 6, or 8, the notification activity at node 5, 7, or 9 sends a notification of the failure to the approver. Once the Document Approval Manager is restarted successfully, the workflow continues if the approver or system administrator responds to the notification with Retry.

See: Document Status Checks, page 2-21. See: Document Submission Checks, page 2-22.

## **Approve Requisition Subprocess Activities**

The following is a description of each activity in the Approve Requisition subprocess, listed by the activity's display name.

### **Start (Node 1)**

This is a Standard function activity that simply marks the start of the subprocess.

### **Is Document Approved? (Node 2)**

If you are using encumbrance and the document was Pre-Approved at the time that funds were reserved for it, then its status already changed to Approved.

### **Does Document State Allow Approval Action? (Node 4)**

Examples of document statuses that allow an approval action are Incomplete, In Process, and Pre-Approved.

### **Is Document Complete? (Node 6)**

This activity verifies that the requisition is complete—for example, verifying that all the quantities match, and at least one line and one distribution exist.



### **Approve the Requisition (Node 8)**

This activity sets the status of the requisition to Approved.

### **Get Requisition Attributes (Node 14)**

This function activity retrieves key values from the requisition header and lines, in case these have changed, and assigns them to Workflow attributes.

### **Document Manager Failed (Nodes 5, 7, and 9)**

If the Document Approval Manager fails, the approver receives this notification that it failed. Once a system administrator successfully restarts the Document Approval Manager, the approver must respond to the notification by choosing Retry, so that the workflow can continue.

### **Document Failed State Check (Node 10)**

This function activity sends a notification to the approver that the document failed the state check. See: Document Status Checks, page 2-21.

### **Document Failed Correctness Check (Node 11)**

This function activity sends a notification to the approver that the document failed the correctness check. See: Document Submission Checks, page 2-22.

### **Set Req Status to Original Status (Node 12)**

This function activity sets the requisition back to its original status, if the document has failed state or correctness checks.

### **End (Nodes 3 and 13)**

This function activity marks the end of the process. Although the activity itself does not have a result type, each node of this activity in the process must have a process result assigned to it. The process result is assigned in the property page of the activity node. Since the Approve Requisition subprocess activity has a result type of PO Approval Action and Doc Verification, each End activity node must have a process result matching one of the lookup codes in the PO Approval Action and Doc Verification lookup type.

## **Summary of the Print Document Subprocess**

To view the properties of the Print Document subprocess, select its process activity in the navigator tree, then choose Properties from the Edit menu. The Print Document subprocess has a result type of PO Activity Performed, indicating that when the subprocess completes, it has a result of Activity Performed. This result corresponds to the lookup code in the PO Activity Performed lookup type, in the PO Standard item

type.

The subprocess begins at node 1.

Node 2 checks if Print was selected in the Approve Document window when the requisition was first submitted for approval. If Print was selected, node 4 prints the document.

## **Print Document Subprocess Activities**

The following is a description of each activity in the Print Document subprocess, listed by the activity's display name.

### **Start (Node 1)**

This is a Standard function activity that simply marks the start of the subprocess.

### **Does User Want Document Printed? (Node 2)**

This activity checks if Print was selected when the requisition was first submitted.

### **Print Document (Node 4)**

If Print was selected when the requisition was first submitted, this activity prints the document.

### **End (Nodes 3 and 5)**

This function activity marks the end of the process. Although the activity itself does not have a result type, each node of this activity in the process must have a process result assigned to it. The process result is assigned in the property page of the activity node. Since the Print Document subprocess activity has a result type of PO Activity Performed, each End activity node must have a process result matching one of the lookup codes in the PO Activity Performed lookup type.

## **Summary of the Verify Approval Authority for Approve and Approve/Forward Action Subprocesses**

To view the properties of the Verify Approval Authority for Approve Action subprocess or the Verify Approval Authority for Approve and Forward Action subprocess, select the process in the navigator tree, then choose Properties from the Edit menu. This subprocess has a result type of Yes/No, indicating that when the subprocess completes, it has a result of Yes or No. This result corresponds to the lookup code in the Yes/No lookup type in the Standard item type.

This process activity is not runnable, indicating that it cannot be initiated as a top-level process to run, but can be run only when called by another higher-level process.

The Verify Approval Authority for Approve Action subprocess is called by the

Response with Approve Action subprocess to verify an approver's approval authority. The Verify Approval Authority for Approve and Forward Action subprocess is called by the Response with Approve and Forward Action subprocess to verify an approver's approval authority.

The subprocess begins at node 1.

At node 2, the subprocess checks the approver's approval authority limits defined in the Approval Groups and Assign Approval Groups windows. (See: Defining Approval Groups, page 1-21. See: Assigning Approval Groups, page 1-24.)

If the Document Approval Manager fails at node 2, node 3 sends a notification of the failure to the approver. Once the Document Approval Manager is restarted successfully, the workflow continues if the approver or system administrator responds to the notification with Retry.

Except for their names, the subprocess Verify Approval Authority for Approve Action and the subprocess Verify Approval Authority for Approve and Forward Action are identical. They are named differently because they are used by two different subprocesses.

## **Verify Approval Authority Subprocess Activities**

The following is a description of each activity in the Verify Approval Authority for Approve Action subprocess and the Verify Approval Authority for Approve and Forward Action subprocess, listed by the activity's display name.

### **Does Approver Have Authority? (Node 2)**

This function activity verifies the approver's authority based on the authority limits defined in the Approval Groups and Assign Approval Groups windows. See: Defining Approval Groups, page 1-21. See: Assigning Approval Groups, page 1-24.

### **Document Manager Failed (Node 3)**

If the Document Approval Manager fails, the approver receives this notification that it failed. Once a system administrator successfully restarts the Document Approval Manager, the approver must respond to the notification by choosing Retry, so that the workflow can continue.

## **Purchase Order Approval Workflow**

Whenever you submit a purchase order or release for approval or take an action in the Notifications Summary window, Purchasing uses Oracle Workflow technology in the background to handle the approval process. Workflow uses the approval controls and hierarchies you define according to the setup steps in the section Setting Up Document Approval and Security, page 2-1 to route documents for approval. You can use the Workflow Builder interface to modify your approval process.

The purchase order approval workflow consists of processes, which are viewable in the Workflow Builder as a diagram, some of whose objects and properties you can modify. Each workflow process, in turn, consists of individual function activities.

The PO Approval workflow is initiated at the following points in Purchasing:

- When you choose Submit for Approval (and then choose OK) in the Approve Document window. See: Submitting a Document for Approval, page 2-32.
- When you respond to a reminder in the Notifications Summary window reminding you to submit a document for approval that has not yet been submitted.

For information on the requisition approval workflow, see: Requisition Approval Workflow, page E-50.

## Customizing the PO Approval Workflow

Use the Oracle Workflow Builder to customize workflows. When you customize a workflow, only those documents that are submitted for approval *after* you have customized it are affected by the customized workflow.

You can also use the Workflow Builder to create unique approval workflows for each document type in your organization. You associate particular workflows with certain document types in the Document Types window. See: Defining Document Types, page 1-67.

You can use the Workflow Monitor to follow where certain documents are in a workflow process. See: Overview of Workflow Monitoring, *Oracle Workflow User's Guide*.

### To display the workflow in the Oracle Workflow Builder:

1. Choose Open from the File menu, and connect to the database.

See: Opening and Saving Item Types, *Oracle Workflow Developer's Guide*.

The Display name of the PO Approval workflow is *PO Approval*. The name of its Workflow definition file is *poxwfpoa.wft*.

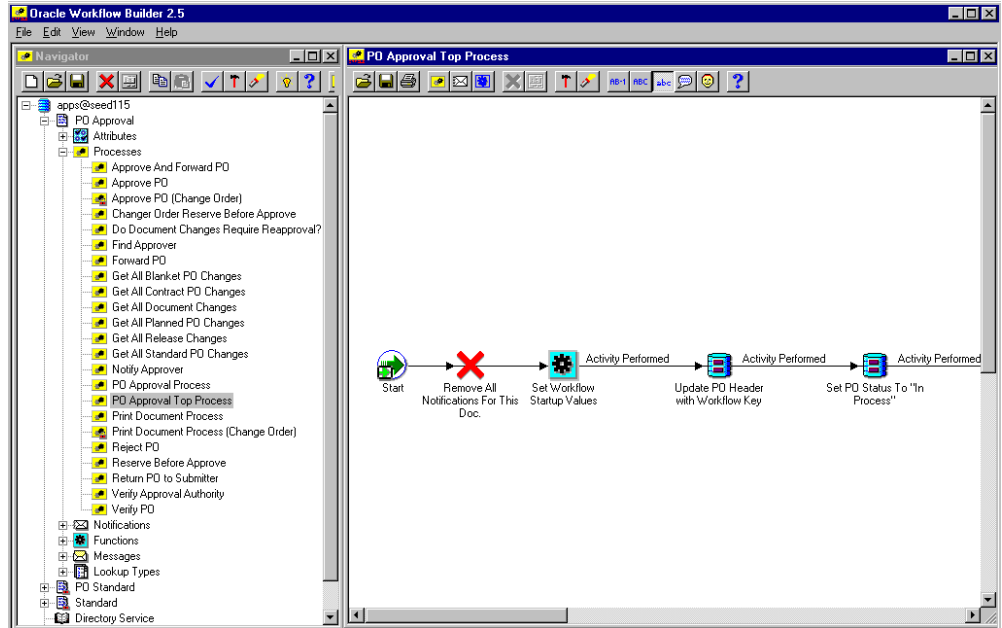

2. Expand the data source, then the PO Approval item type branch within that data source.
3. Expand the Processes branch within the PO Approval branch, then double-click a process activity to display its diagram.

## Creating a New Custom Process

You can either modify the default PO Approval workflow that Purchasing provides, or copy it and create a whole new workflow. Use the Document Types window to select a custom PO Approval Workflow Startup Process for specific document types or operating units.

If you create different workflows for different documents or operating units, the recommended practice is not to copy and rename the item type (such as PO Approval 1), but to copy and rename the Workflow Startup Process, which you will modify to call your own custom subprocesses. All of your operating units will point to the same item type, and will use the default item attributes and other activities that the item type requires, but one operating unit will also use your custom startup process.

**Important:** Creating a new workflow process with a new Internal Name affects the implementation of future upgrades. See: Upgrade Support, page E-3.

## Required Modifications

There are no required modifications you need to make to the PO Approval workflow.

However, this documentation assumes that you have already set up Purchasing and performed the Workflow setup steps described in Workflow Setup Options, page 1-85.

## Supported and Unsupported Customizations

The following is a discussion of what you can and *definitely cannot* modify in the PO Approval workflow. For those things you *can* modify, the discussion includes important guidelines that you need to be careful of when making customizations.

For important information on how to customize workflows, see the *Oracle Workflow Developer's Guide*.

To further help you with your customizations, refer to the sections later in this document, starting with The PO Approval Item Type, page E-95. These sections describe the components of the main processes in the PO Approval workflow. If you haven't already, see also: Customization Guidelines, page E-2.

**Important:** If a particular Workflow object does not appear in the following sections on the lists of things you can customize, do not modify it, regardless of its access level.

## Attributes

You can modify the following attributes only, by changing their Default Value:

- Change Order Header Blanket Total Tolerance
- Change Order Header Amount Limit Tolerance
- Change Order Header Purchase Order Total Tolerance
- Change Order Line Quantity Tolerance
- Change Order Line Unit Price Tolerance
- Change Order Line Quantity Committed Tolerance
- Change Order Line Agreed Amount Tolerance
- Change Order Line Price Limit Tolerance
- Change Order Shipment Price Override Tolerance
- Change Order Shipment Quantity Tolerance
- Change Order Distribution Quantity Ordered Tolerance

For information about how to modify these attributes, see: Workflow Processes for Approving Change Orders, page E-133.

## Processes

If you modify a process, it is essential that the basic flow remain intact to maintain data integrity in the database. For example, you should not remove or bypass the function activity *Is Document Complete?* in the *Verify PO* subprocess because this may allow incomplete data to be inserted into the database tables. However, you could add additional checks (processes or function activities) before allowing data to be inserted into the tables.

If you modify any process, either by replacing a portion of its flow or by adding additional function activities, remember the following:

- Attributes that are set by default function activities in the default processes must also be set if you replace default function activities with ones of your own. That is, if a function activity in that process uses a *SetItemAttr* statement, then that function activity is setting an attribute to be used by another function activity later. Therefore, your new function activity must do the same. You should also preserve *SetItemUserKey* and *SetItemOwner* statements, if any. (Depending on your customizations, you may also want to preserve *GetItemAttr* statements.)
- Any database state maintained by the default processes must also be maintained by processes you customize. That is, if a function activity in that process uses an *Update* or *Insert Into* statement, then that function activity is updating or inserting rows in the database. Therefore, your new function activity must maintain the same database state.

To get a list of the workflow function activities that use *SetItemAttr*, *GetItemAttr*, *SetItemUserKey*, *SetItemOwner*, *Insert Into*, or *Update* statements, run the PL/SQL script *powfcust*. For instructions on running this script, see: *Customization Guidelines*, page E-2.

The processes listed below may be modified as your business processes require; however, remember that after your customizations, the attributes that were set and the database states that were maintained by the default process must also be set or maintained by your customized process:

- *Do Document Changes Require Reapproval?*
- *Find Approver*
- *Get All Blanket PO Changes*
- *Get All Contract PO Changes*
- *Get All Planned PO Changes*
- *Get All Release Changes*
- *Get All Standard PO Changes*

- Notify Approver
- Print Document Process
- Print Document Process (Change Order)
- Fax Document Process
- Fax Document Process (Change Order)

You may add your own additional function activities to the processes listed below, but do not remove any default function activities from them:

- Approve and Forward PO
- Approve PO
- Approve PO (Change Order)
- Change Order Reserve Before Approve
- Forward PO
- Get All Document Changes
- PO Approval Process
- PO Approval Top Process
- Reject PO
- Reserve Before Approve
- Return PO to Submitter
- Verify Approval Authority
- Verify PO

## Notifications

All of the notifications can be modified to meet your individual business needs. However, if the notification has a reply code, make sure that the Result Type of your customized notification matches the transitions in the workflow diagram. See: *To Create a Notification Activity, Oracle Workflow Developer's Guide*. See also: *Message Result, Oracle Workflow Developer's Guide* and *To Create a Message, Oracle Workflow Developer's Guide*.



## Function Activities

You cannot modify any function activities in the PO Approval workflow.

However, you can replace some function activities with function activities of your own. When you replace a function activity, you are modifying the process in which it is contained. See the guidelines for customizing the PO Approval processes in the section **Processes** above.

If you substitute default function activities in a process with function activities that you create, you must remember the following:

- The result type of your new function activity must match the result type of the default activity. That is, the Result Type of function activity in the Workflow Builder—for example, a Result Type of Yes/No—needs to match the result type that you specify in that function activity's corresponding PL/SQL procedure. It also means that if you have, for example, two results (such as Yes and No) in your function activity and corresponding PL/SQL procedure, you need to make sure that there are two corresponding transitions in the workflow diagram (one for Yes and one for No). If you alter the result types and transitions in a process, be careful that you aren't deleting or bypassing any special transitions or checks.
- Just as in the section **Processes** above, any attributes that were set by the default function activity must also be set by your customized function activity.
- Just as in the section **Processes** above, any database state maintained by the default function activity must also be maintained by the customized function activity.

## Messages

All of the messages can be modified to meet your individual business needs.

## Lookup Types

All of the lookup types can be modified to meet your individual business needs.

**Note:** If you change a lookup type, you must be sure that all activities that use the lookup type allow for the change. For example, if you change the lookup type from Yes/No to something else, the activities that use that lookup type should also change their Result Type from Yes/No to whatever new lookup type you created. See: Lookup Types, *Oracle Workflow Developer's Guide*.

## The PO Approval Item Type

The purchase order approval process is associated with an item type called PO Approval. This item type identifies all purchase order and release approval workflow

processes available. The following workflow processes are associated with PO Approval:

- PO Approval Top Process, page E-103
- PO Approval Process, page E-108
- Approve And Forward PO, page E-121
- Approve PO, page E-117
- Approve PO (Change Order) \*
- Change Order Reserve Before Approve \*
- Do Document Changes Require Reapproval? \*
- Find Approver, page E-126
- Forward PO, page E-128
- Get All Blanket PO Changes \*
- Get All Contract PO Changes \*
- Get All Document Changes \*
- Get All Planned PO Changes \*
- Get All Release Changes \*
- Get All Standard PO Changes \*
- Notify Approver, page E-124
- Print Document Process, page E-120
- Fax Document Process, page E-120
- Print Document Process (Change Order) \*
- Fax Document Process (Change Order) \*
- Reject PO, page E-131
- Reserve Before Approve, page E-114
- Return PO to Submitter, page E-130

- Verify Approval Authority, page E-116
- Verify PO, page E-112

\* These are Change Order workflow process, described in a separate section. See: Workflow Processes for Approving Change Orders, page E-133.

The PO Approval item type also has many attributes associated with it. These attributes reference information in the Purchasing application tables. The attributes are used and maintained by function activities as well as notification activities throughout the process.

### PO Approval Workflow Item Type Attributes

**Important:** All of the Change Order item attributes are described in the Change Order Workflow section. See: Workflow Processes for Approving Change Orders, page E-133.

Display Name	Description	Type	Length/ Format/ Lookup Type
Action History of the Document	Action history of the document as displayed in the approval notification	Document	
Application ID	Unique identifier for the application (such as Purchasing)	Number	
Approval Path ID	Unique identifier for the approval hierarchy	Number	
Approver Employee ID	Unique identifier for the approver	Number	
Approver Display Name	Approver's name as displayed in Purchasing	Text	
Approver User Name	User name of the approver	Text	

<b>Display Name</b>	<b>Description</b>	<b>Type</b>	<b>Length/ Format/ Lookup Type</b>
Authorization Status	Status of the document, such as Approved or Incomplete	Text	25
Authorization Status Display	Document status as displayed in Purchasing	Text	25
Closed Code	Indicator that the document is closed	Text	25
Closed Code Display	Closed status as displayed in Purchasing	Text	25
Concurrent Request ID	Request ID for the Document Approval Manager	Number	
Context ORG_ID	Unique identifier for the organization	Number	
Document ID	Unique identifier for the document	Number	
Document Manager Error Number	Error number for the Document Manager Failed notification	Number	
Document Submitted by Web Supplier	Indicator of whether the change to the document was made through Oracle Supply Management Portal	Text	
Document Subtype	Document subtype, such as Blanket	Text	25
Document Subtype Display	Document subtype as displayed in Purchasing	Text	25

<b>Display Name</b>	<b>Description</b>	<b>Type</b>	<b>Length/ Format/ Lookup Type</b>
Document Type	Document type, such as Purchase Order	Text	25
Document Type Display	Document type as displayed in Purchasing	Text	25
Fax Document	Indicator of whether Fax was selected when submitting the document for approval	Text	
Fax Number	Facsimile number entered when submitting the document for approval	Text	
Forward From Display Name	Name of the forward-from person as displayed in Purchasing	Text	60
Forward From ID	Unique identifier for the forward-from person	Number	
Forward From User Name	User name for the forward-from person	Text	60
Forward To Display Name	Name of the forward-to person as displayed in Purchasing	Text	60
Forward To ID	Unique identifier for the forward-to person	Number	
Forward-To ID Old Value	Item attribute for internal use that keeps track of the previous forward-to person	Number	

Display Name	Description	Type	Length/ Format/ Lookup Type
Forward To User Name	User name for the forward-to person	Text	60
Functional Currency	Functional currency	Text	
Interface Source	Source of the document, such as ICX or POR	Text	25
Interface Source Line ID	<i>(Not currently used)</i>	Number	
"Invalid Forward To" Translated Message	Message used when approving the document if the forward-to user name is invalid	Text	
Line Number Translated	Translation for "Line Number"	Text	
Note	Note to the approver	Text	240
Online Report ID For Doc Complete Check	Unique identifier for the error message displayed after saving a document that is in error	Number	
Online Report Text For Doc Complete Check	Text of the error message displayed after saving a document that is in error	Text	2000
Open Document	Command that Purchasing sends to open the document from the notification	Form	

Display Name	Description	Type	Length/ Format/ Lookup Type
Original Authorization Status	Status of the document before it was submitted for approval	Text	25
PL/SQL Error Document	The document that was being approved when a PL/SQL error occurred	Text	2000
PL/SQL Error Location	Where an internal, PL/SQL error occurred	Text	2000
PL/SQL Error Message	Text for the notification sent when a PL/SQL error occurs	Text	2000
PO Amount	<i>(Not currently used)</i>	Text	30
PO Amount Display	Total amount, without tax, as displayed in Purchasing	Text	30
PO Approval Headers Message	Message header that indicates the specific document requiring approval	Document	
PO Description	Header description	Text	240
PO Lines Details	Purchase order line details displayed in the approval notification	Document	
PO Number	Purchase order number	Text	20
PO Type	<i>(Not currently used)</i>	Text	

<b>Display Name</b>	<b>Description</b>	<b>Type</b>	<b>Length/ Format/ Lookup Type</b>
Preparer Display Name	Name of the person who created the document, as displayed in Purchasing	Text	80
Preparer ID	Unique identifier for the person who created the document	Number	
Preparer User Name	User name for the person who created the document	Text	60
Print Document	Indicator of whether Print Document was selected when submitting the document for approval	Text	
Release Num	Release number	Number	
Release Num Dash Separator	Separator symbol, such as a dash, used in the release number	Text	
Release Type	Release type such as Blanket or Scheduled	Text	25
"Requires Approval" Translated Message	Message text used to indicate the document requires approval	Text	
Response Forward-To	Forward-to name as entered by the person forwarding the document	Text	100



Display Name	Description	Type	Length/ Format/ Lookup Type
Responsibility ID	Unique identifier for the document preparer's user responsibility	Number	
System Administrator Error Message	Document Approval Manager failed message	Text	2000
Tax Amount Display	Tax amount displayed in the approval notification	Text	30
Total Amount Display	Total document amount, with tax, displayed in the approval notification	Text	30
User ID	Unique identifier for the document preparer	Number	

## Summary of the PO Approval Top Process

To view the properties of the PO Approval Top Process, select the process in the navigator tree, then choose Properties from the Edit menu. The PO Approval Top Process has a result type of None, indicating that when the process completes, it doesn't end with a particular result, such as Approved or Rejected. Instead, its subprocesses end with specific results.

This process activity is runnable, indicating that it can be initiated as a top-level process to run by making calls to the Workflow Engine *CreateProcess* and *StartProcess* APIs.

The Details property page of the process activity indicates that the PO Approval Top Process has an error process called DEFAULT\_ERROR associated with it, which gets initiated only when an error is encountered in the process. For example, if you attempt to initiate the PO Approval Top Process with a purchase order that is created by someone who is not listed in the employee approval hierarchy, the Workflow Engine would raise an error when it tries to execute the Find Approver activity. This error would initiate DEFAULT\_ERROR, which is associated with the System:Error item type.

Currently the process simply executes the standard Default Error Notification activity to provide information associated with the error. You can customize the process further to suit your needs. See: Default Error Process, *Oracle Workflow Developer's Guide*.

The PO Approval workflow begins when you submit a purchase order for approval in Purchasing, or respond to a reminder notification to submit a purchase order for approval.

The workflow begins at node 1.

Node 2 removes previous purchase order notifications for this document if previous versions of the document sent to the workflow were incomplete or rejected.

Node 3 sets startup values, node 5 sets the purchase order status to In Process, node 6 determines whether the process is set up to run in Online or Background performance modes according to the profile option *PO: Workflow Processing Mode*, and node 8 retrieves purchase order attributes (purchase order information and internal workflow attributes). For more detail on these startup activities, see the next section.

Node 9 checks if the document requires reapproval because the supplier made a change (for example, to the Promised or Need-By Date) through Oracle iSupplier Portal. If the supplier's change was approved through iSupplier Portal, the document is approved directly rather than submitted for change order or full reapproval.

**Note:** Node 9 enables you to approve any change made through iSupplier Portal. If you were to delete node 9, any change a supplier makes through iSupplier Portal would be treated like any other document change in the change order workflow. See: *Workflow Processes for Approving Change Orders*, page E-133.

Node 10 checks if the document is new. If it is, the workflow moves from node 10 to the Main PO Approval Process at node 14 to approve the document. If the document is not new, the change order workflow begins if your Purchasing setup (in the Document Types window) archives documents on approval (the Change Order workflow cannot work without this setup). The change order workflow gathers all document changes at node 12; determines at node 13 if those changes require manual reapproval or can simply be approved automatically; attempts at node 16 to reserve funds for the document if encumbrance accounting is used; approves the changes at node 18; sends a notification at node 20 that the document was approved; and, if Print was selected in the Approve Document window, prints the document at node 21. If a facsimile number was entered in the Approve Document window, node 22 sends a facsimile of the purchase order.

## PO Approval Top Process Activities

The following is a description of each activity in the PO Approval Top Process listed by the activity's display name. You can create all the components for an activity in the graphical Workflow Builder except for the PL/SQL stored procedures that the function activities call. All function activities execute PL/SQL stored procedures which you must

create and store in the Oracle RDBMS. The naming convention for the PL/SQL stored procedures is:

`<PACKAGE> . <PROCEDURE>`

`<PACKAGE>` is the name of the package that groups all of the procedures.  
`<PROCEDURE>` represents the name of the procedure.

To view the package and procedure names used by the PO Approval processes, view the Properties page for each function activity. For example, the function activity Remove All Notifications For This Document uses the `<PACKAGE>.<PROCEDURE>` name `PO_REQAPPROVAL_INIT1.REMOVE_REMINDER`.

You can use the Item Type Definitions Web page to view `<PACKAGE>.<PROCEDURE>` names. See: Item Type Definitions Web Page, *Oracle Workflow Developer's Guide*.

### **Start (Node 1)**

This is a Standard function activity that simply marks the start of the process.

### **Remove All Notifications For This Document (Node 2)**

This function activity removes previous notifications for a purchase order previously submitted to the workflow that was not completed because of an error or because of an action such as rejection.

### **Set Workflow Startup Values (Node 3)**

This function activity sets all initial values necessary to identify a unique purchase order, such as the preparer's user name and a forward-to user name.

### **Update PO Header with Workflow Key (Node 4)**

This function activity updates the document header with the item type and item key, which indicate that the purchase order has been submitted to the workflow.

### **Set PO Status to "In Process" (Node 5)**

When you submit a purchase order for approval, its status changes to In Process.

### **Get Workflow Approval Mode (Node 6)**

This function activity retrieves the value from the profile option *PO: Workflow Processing Mode*, which lets you choose whether you want the approval process to run in Online or Background modes. For definitions of Background and Online modes, see: Profile Options in Purchasing, page C-1.

### **Wait for Background Process (Node 7)**

If the profile option *PO: Workflow Processing Mode* is set to Background, this function activity waits for the Workflow Background Engine to pick up this document for

processing by the workflow. This activity enables you to proceed to your next Purchasing activity while the approval process for this document completes in the background.

### **Get PO Attributes (Node 8)**

This function activity retrieves key values from the purchase order header and lines, and assigns them to Workflow attributes.

### **Is Change Initiated from Web Suppliers? (Node 9)**

This is a Standard Workflow comparison activity that provides a standard way to compare two numbers, dates, or text strings. Here, this activity is used to check the item attribute Document Submitted by Web Supplier. If the document change was approved through Oracle iSupplier Portal (the item attribute is Y for Yes), the document is approved directly rather than submitted for change order or full reapproval.

See: Comparison Activities, *Oracle Workflow Developer's Guide*. See: *Oracle iSupplier Portal Implementation Manual*.

### **Is This a New Document? (Node 10)**

This function activity checks whether the purchase order is new or a change to an existing purchase order. (If there is no APPROVED\_DATE, it considers the document new.) If it's new, the purchase order goes through the PO Approval Process. If it's a change to an existing purchase order, it goes through the change order approval process if the document type is set to Archive on Approval.

### **Is Archive on Approval Flag Set to Yes? (Node 11)**

This function activity checks if the document type is set to Archive on Approval or Archive on Print in the Document Types window. See: Defining Document Types, page 1-67. If it's set to Archive on Approval and the previously approved document has been modified, then the workflow processes for approving changed purchase orders or releases begins. If it's set to Archive on Print, then the document goes through the full approval process.

### **PO Approval Process (Node 14)**

See: PO Approval Process, page E-108.

### **Get All Document Changes (Node 12)**

See: Get All Document Changes, page E-147.

### **Do Document Changes Require Reapproval? (Node 13)**

See: Do Document Changes Require Reapproval?, page E-154.

### **Change Order Reserve Before Approve (Node 16)**

See: Change Order Reserve Before Approve, page E-155.

### **Approve PO (Change Order) (Node 18)**

See: Approve PO (Change Order), page E-157.

### **PO Approved (Node 20)**

This function activity sends a notification to the appropriate individual that the purchase order has been approved.

This notification's message uses Document type item attributes to call two PL/SQL functions, one that retrieves all of the lines in the document and displays them in the notification, and another that retrieves the action history of the document and displays that in the notification.

### **Print Document Process (Change Order) (Node 21)**

See: Print, Fax, and Email Document Processes, page E-120.

### **Fax or Email Document Process (Change Order) (Node 22)**

See: Print, Fax, and Email Document Processes, page E-120.

### **Raise Send PO Event (Change Order) (Node 23)**

This function activity will check the document to see if XML is the chosen supplier transmission method. If true, it will raise an event that will cause the document to be sent by way of XML.

Processing following this node takes two paths and workflow executes both of them in parallel. One path is to an end node to wait and the other links to a sub-process to automatically create sourcing rules and approved supplier lists (ASL).

### **Does User Want SR and ASLs Created (Node 24)**

This function activity checks the profile PO: Allow Auto-generate Sourcing Rules and ASL. If the profile is set to Yes and automatic sourcing rule generation was selected, either from Purchasing Document Import or by the user in the Approval window, this activity will return true and the Create SR and ASL sub-process will be invoked.

### **Create SR and ASL (Node 25)**

This sub-process will generate the requested sourcing rules and ASL for all eligible lines in the blanket purchase agreement that is being approved. Exceptions created by this process can be viewed in the Purchasing Interface Errors report.

## PL/SQL Error Occurs

This notification activity does not appear in any process diagram, but is used by the workflow in case an internal, PL/SQL error occurs when a function activity performs. If such an error occurs, this notification activity sends a notification to the document owner or approver that a Workflow error has occurred.

## Summary of the PO Approval Process

To view the properties of the PO Approval process, select the process in the navigator tree, then choose Properties from the Edit menu. The PO Approval process has a result type of PO Main Requisition Approval Process Result, indicating that when the process completes, it has a result of Approved, Invalid Action, No Approver Available, or Rejected. These results correspond to the lookup codes in the PO Main Requisition Approval Process Result lookup type in the PO Standard item type.

This process activity is not runnable, indicating that it cannot be initiated as a top-level process to run, but rather can be run only as a subprocess when called by a higher-level process.

The PO Approval Process is initiated when a new purchase order is submitted for approval or when changes to a purchase order require going through the full approval process.

The workflow begins at node 1.

If the purchase order passes verification at node 2, node 4 checks if Owner Can Approve in the Document Types window is enabled for the document type. If node 5 finds that the owner has approval authority, node 6 checks if the owner has provided an additional forward-to approver. If so, node 7 approves and forwards the purchase order, and node 8 notifies the approver. Otherwise, the workflow begins to approve the document at node 9.

If the approver approves, or approves and forwards the document, node 12 checks if the resulting document status is Pre-Approved. A pre-approved document is one that has been approved by the final approver, but also forwarded to an additional approver, or one that has been authorized for approval but for which funds have not yet been reserved, if you use encumbrance accounting. In this process, even after the document is approved, it is still considered pre-approved until the subprocess at node 9 or 23 sets its status to Approved. If the document is not pre-approved, the workflow verifies the approver's current approval authority at node 5.

The Find Approver subprocess at node 13 begins if the approver forwards the document for additional approval or does not respond, or if the activities at nodes 4 or 5 find that the document owner does not have approval authority. If an approver is found at node 13, node 16 checks if the user name of the approver is valid. If so, node 17 forwards the purchase order to the approver. If the Find Approver activity is not successful, or if the approver user name is invalid, the purchase order is returned to the submitter at node 14.

Once an approver is found, the workflow branches differently depending on how the approver responds in the subprocess at node 8-with Forward, Timeout (no response), Approve, Approve And Forward, or Reject. If the approver rejects the document, a notification as such is sent to the buyer (document owner) at node 21.

Once all approvers have approved the document, node 9 attempts to reserve funds for the document before approval if encumbrance accounting is being used and funds for the document are not already reserved. Then, node 23 approves the purchase order, sends a document-approved notification to the document owner at node 25, and prints the document at node 26 if Print was selected in the Approve Document window when the purchase order was first submitted. If a facsimile number was entered in the Approve Document window, node 27 sends a facsimile of the purchase order.

## **PO Approval Process Activities**

The following is a description of each activity in the PO Approval Process, listed by the node number from the above graphic.

### **Start (Node 1)**

This is a Standard function activity that simply marks the start of the process.

### **Verify PO (Node 2)**

See: Verify PO, page E-112.

### **Can Owner Approve? (Node 4)**

This function activity checks if Owner Can Approve is enabled for the specific document type in the Document Types window. See: Defining Document Types, page 1-67. If the owner can approve, the subprocess Verify Approval Authority verifies the owner's approval authority. If not, the subprocess Find Approver begins.

### **Verify Approval Authority (Node 5)**

See: Verify Approval Authority, page E-116.

### **Is Forward-To Provided? (Node 6)**

This function activity checks if a forward-to person was provided in the Approve Document or Notifications Summary windows.

### **Approve and Forward PO (Node 7)**

See: Approve And Forward PO, page E-121.

### **Notify Approver (Node 8)**

See: Notify Approver, page E-124.

**Reserve Before Approve (Node 9)**

See: Reserve Before Approve, page E-114.

**Is PO Pre-Approved? (Node 12)**

This function activity checks if the purchase order has been pre-approved. A Pre-Approved document is one that has already been approved by the appropriate individual, who also chose to forward it to yet another person for approval. Or, it is a document that has been authorized for approval but for which funds have not yet been reserved. In the PO Approval workflow, a document is still considered pre-approved until the subprocess Reserve Before Approve or the subprocess Approve PO sets its status to Approved.

**Find Approver (Node 13)**

See: Find Approver, page E-126.

**Return PO to Submitter (Node 14)**

See: Return PO to Submitter, page E-130.

**Is Forward-To User Name Valid? (Node 16)**

This function activity checks if the user name of the approver found by the Find Approver activity is valid.

**Forward PO (Node 17)**

See: Forward PO, page E-128.

**Reject PO (Node 19)**

See: Reject PO, page E-131.

**PO Rejected (Node 21)**

After the approver's rejection is recorded and the purchase order sent back to the buyer, this activity sends a notification to the buyer that the purchase order has been rejected.

**Approve PO (Node 23)**

See: Approve PO, page E-117.

**PO Approved (Node 25)**

This function activity sends a notification to the appropriate individual that the purchase order has been approved.



This notification's message uses Document type item attributes to call two PL/SQL functions, one that retrieves all of the lines in the document and displays them in the notification, and another that retrieves the action history of the document and displays that in the notification.

### **Raise Send PO Event (Node 26)**

This function activity will check the document to see if XML is the chosen supplier transmission method. If true, it will raise an event that will cause the document to be sent by way of XML.

Processing following this node takes two paths and workflow executes both of them in parallel. One path is to an end node to wait and the other links to a sub-process to automatically create sourcing rules and approved supplier lists (ASL).

### **Does User Want SR and ASLs Created**

If automatic sourcing rule generation was selected, either from Purchasing Document Import or by the user in the Approval window, this activity will return true and the Create SR and ASL sub-process will be invoked.

### **Create SR and ASL (Node 27)**

This sub-process will generate the requested sourcing rules and ASL for all eligible lines in the blanket purchase agreement that is being approved.

### **Print Document Process (Node 28)**

See: Print, Fax, and Email Document Processes, page E-120.

### **Fax Document Process (Node 29)**

See: Print, Fax, and Email Document Processes, page E-120.

This notification's message uses Document type item attributes to call two PL/SQL functions, one that retrieves all of the lines in the document and displays them in the notification, and another that retrieves the action history of the document and displays that in the notification.

### **Email Document Process (Node 30)**

See: Print, Fax, and Email Document Processes, page E-120.

### **End (Nodes 3, 10, 11, 15, 18, 20, 22, 24)**

This function activity marks the end of the process. Although the activity itself does not have a result type, each node of this activity in the process must have a process result assigned to it. The process result is assigned in the property page of the activity node. Since the Main Requisition Approval process activity has a result type of PO Main Requisition Approval Process Result, each End activity node must have a process result

matching one of the lookup codes in the PO Main Requisition Approval Process Result lookup type.

## Summary of the Verify PO Subprocess

To view the properties of the Verify PO subprocess, select its process activity in the navigator tree, then choose Properties from the Edit menu. The Verify PO subprocess has a result type of PO Document Verification, indicating that when the subprocess completes, it has a result of Failed Verification or Passed Verification. These results correspond to the lookup codes in the PO Document Verification lookup type, in the PO Standard item type.

This subprocess activity is not runnable, indicating that it cannot be initiated as a top-level process to run, but rather can be run only as a subprocess when called by a higher-level process.

This subprocess activity makes sure the purchase order is complete and the information is valid.

The subprocess begins at node 1.

Node 2 checks if the document is open (for example, not finally closed).

Node 3 checks that the document status is compatible with an approval action (for example, its status is not closed, frozen, or on hold). Node 4 verifies that the document is complete, such as ensuring that it contains at least one line and one distribution.

If the document state does not allow an approval action at node 3 or the document is incomplete at node 4, a notification of such at node 8 or 9, respectively, is sent to the document owner. Then, at node 10, the purchase order status is set back to what it was before it entered this subprocess, and the workflow ends at node 11. If you modify and resubmit the purchase order or create a new one, the PO Approval workflow starts over when you submit the purchase order for approval.

If the document passes validation at nodes 3 and 4, node 12 records in the Action History window that the document has been submitted for approval. Then the activity Can Owner Approve? (outside this subprocess, in the PO Approval Top Process) begins.

If the Document Approval Manager fails at node 2, 3, or 4, the notification activity at node 5, 6, or 7 sends a notification of the failure to the document owner. Once the Document Approval Manager is restarted successfully, the workflow continues if the document owner or system administrator responds to the notification with Retry.

See: Document Status Checks, page 2-21. See: Document Submission Checks, page 2-22.

## Verify PO Subprocess Activities

The following is a description of each activity in the Verify PO subprocess, listed by the activity's display name.

**Start (Node 1)**

This is a Standard function activity that simply marks the start of the subprocess.

**Open Document State (Node 2)**

This function activity checks if the document is open (for example, not finally closed).

**Does Document State Allow Approval Action? (Node 3)**

This function activity checks if the document status is compatible with the approval action. Examples of document statuses that allow an approval action are Incomplete, In Process, and Pre-Approved.

**Is Document Complete? (Node 4)**

This function activity verifies that the purchase order is complete—for example, verifying that all the quantities match, and at least one line and one distribution exist.

**Record 'Submit' In Action History (Node 12)**

This function activity inserts a Submit Action row into the PO\_ACTION\_HISTORY table to record that the document has been submitted for approval. It also inserts an additional row with a null ACTION\_CODE to simulate a forward-to action, since the document status is In Process. The document manager looks for this row.

**Document Manager Failed (Nodes 5, 6, and 7)**

If the Document Approval Manager fails, the document owner receives this notification that it failed. Once a system administrator successfully restarts the Document Approval Manager, the owner must respond to the notification by choosing Retry, so that the workflow can continue.

**Document Failed State Check (Node 8)**

This function activity sends a notification to the document owner that the document failed the state check. See: Document Status Checks, page 2-21.

**Document Failed Correctness Check (Node 9)**

This function activity sends a notification to the document owner that the document failed the correctness check. See: Document Submission Checks, page 2-22.

**Set PO Status to Original Status (Node 10)**

This function activity sets the document back to its status before it entered this process activity, if the document has failed state or correctness checks.

## End (Nodes 11 and 13)

This function activity marks the end of the process. Although the activity itself does not have a result type, each node of this activity in the process must have a process result assigned to it. The process result is assigned in the property page of the activity node. Since the Verify PO subprocess activity has a result type of PO Document Verification, each End activity node must have a process result matching one of the lookup codes in the PO Document Verification lookup type.

## Summary of the Reserve Before Approve Subprocess

To view the properties of the Reserve Before Approve subprocess, select its process activity in the navigator tree, then choose Properties from the Edit menu. The Reserve Before Approve subprocess has a result type of PO Reserve Before Approve, indicating that when the subprocess completes, it has a result of Forward, No, or Yes. These results correspond to the lookup codes in the PO Reserve Before Approve lookup type, in the PO Standard item type.

This subprocess activity is not runnable, indicating that it cannot be initiated as a top-level process to run, but rather can be run only as a subprocess when called by a higher-level process.

The subprocess begins at node 1.

If node 2 finds that encumbrance is on and funds are not yet reserved, node 4 attempts to reserve funds for the document.

If funds cannot be reserved, node 6 sends an Unable to Reserve Document notification to the approver. The approver must then use the Approve Document window to try to reserve the document again if, for example, more funds have been allocated, and then respond to the notification with Retry; reject the document; or forward the document to somebody else with authority to reserve the funds.

If the approver forwards the document, node 7 checks if the forward-to approver has a valid user name. If so, node 8 sets the Forward-To/From information for the new approver.

If the approver rejects the document, node 10 rejects the purchase order. If it cannot reject the purchase order (because the document failed the state check-for example, its status has changed to closed, frozen, or on hold), node 13 sends a notification to the approver that the document could not be rejected.

If the Document Approval Manager fails at node 4 or 10, the notification activity at node 5 or 11 sends a notification of the failure to the approver. Once the Document Approval Manager is restarted successfully, the workflow continues if the approver or system administrator responds to the notification with Retry.

## Reserve Before Approve Subprocess Activities

The following is a description of each activity in the Reserve Before Approve

subprocess, listed by the activity's display name.

### **Start (Node 1)**

This is a Standard function activity that simply marks the start of the subprocess.

### **Is Encumbrance On and Is Document Not Reserved? (Node 2)**

This function activity checks whether you are using encumbrance accounting, and whether the document is already reserved.

### **Reserve Document (Node 4)**

This function activity tries to reserve funds for the document.

### **Document Manager Failed (Nodes 5 and 11)**

If the Document Approval Manager fails, the approver receives this notification that it failed. Once a system administrator successfully restarts the Document Approval Manager, the approver must respond to the notification by choosing Retry, so that the workflow can continue.

### **Unable To Reserve Document (Node 6)**

This activity notifies the approver that Purchasing failed to reserve funds for the document, and provides instructions for resolving the failure. The approver must use the Approve Document window to try to reserve the document again if, for example, more funds have been allocated, and then respond to the notification with Retry; reject the document; or forward the document to somebody else with authority to reserve the funds.

### **Is Forward-To Valid? (Node 7)**

This function activity checks that the Forward-To name entered in the Forward-To field, in response to an approval notification, is a valid user name.

### **Set Forward-To/From For Forward Action (Node 8)**

If the approver responded to the notification Unable to Reserve Document by forwarding the document, this function activity resets the Forward-To and Forward-From attributes appropriately.

### **Reject the PO (Node 10)**

This function activity updates the status of the document to Rejected and records the rejection in the Action History window. It also reverses encumbrance if the document has been encumbered.

### **Unable to Reject Document (Node 13)**

This activity sends a notification to the approver that Purchasing was unable to reject the document—for example, because its status is closed, frozen, or on hold.

### **End (Nodes 3, 9, 12, and 14)**

This function activity marks the end of the process. Although the activity itself does not have a result type, each node of this activity in the process must have a process result assigned to it. The process result is assigned in the property page of the activity node. Since the Reserve Before Approve subprocess activity has a result type of PO Reserve Before Approve, each End activity node must have a process result matching one of the lookup codes in the PO Reserve Before Approve lookup type.

## **Summary of the Verify Approval Authority Subprocess**

To view the properties of the Verify Approval Authority subprocess, select its process activity in the navigator tree, then choose Properties from the Edit menu. The Verify Approval Authority subprocess has a result type of Yes/No, indicating that when the subprocess completes, it has a result of Yes or No. This result corresponds to the lookup codes in the Yes/No lookup type, in the Standard item type.

This subprocess activity is not runnable, indicating that it cannot be initiated as a top-level process to run, but rather can be run only as a subprocess when called by a higher-level process.

The subprocess begins at node 1.

At node 2, the subprocess checks the approver's approval authority limits defined in the Approval Groups and Assign Approval Groups windows. (See: Defining Approval Groups, page 1-21. See: Assigning Approval Groups, page 1-24.)

If the person has enough authority to approve the document, the function activity Is Forward-To Provided? (which is outside this subprocess, in the overall workflow) begins. If not, then the process activity Find Approver (outside this subprocess) begins.

If the Document Approval Manager fails at node 2, node 4 sends a notification of the failure to the approver. Once the Document Approval Manager is restarted successfully, the workflow continues if the approver or system administrator responds to the notification with Retry.

## **Verify Approval Authority Subprocess Activities**

The following is a description of each activity in the Verify Approval Authority subprocess, listed by the activity's display name.

### **Start (Node 1)**

This is a Standard function activity that simply marks the start of the subprocess.

### **Does Approver Have Authority? (Node 2)**

This function activity verifies the approver's authority based on the authority limits defined in the Approval Groups and Assign Approval Groups windows. See: Defining Approval Groups, page 1-21. See: Assigning Approval Groups, page 1-24.

### **Document Manager Failed (Node 4)**

If the Document Approval Manager fails, the approver receives this notification that it failed. Once a system administrator successfully restarts the Document Approval Manager, the approver must respond to the notification by choosing Retry, so that the workflow can continue.

### **End (Nodes 3 and 5)**

This function activity marks the end of the process. Although the activity itself does not have a result type, each node of this activity in the process must have a process result assigned to it. The process result is assigned in the property page of the activity node. Since the Verify Approval Authority subprocess activity has a result type of Yes/No, each End activity node must have a process result matching one of the lookup codes in the Yes/No lookup type.

## **Summary of the Approve PO Subprocess**

To view the properties of the Approve PO subprocess, select its process activity in the navigator tree, then choose Properties from the Edit menu. The Approve PO subprocess has a result type of PO Approval Action and Doc Verification, indicating that when the subprocess completes, it has a result of Invalid Action or Valid Action. These results correspond to the lookup codes in the PO Approval Action and Doc Verification lookup type, in the PO Standard item type.

This subprocess activity is not runnable, indicating that it cannot be initiated as a top-level process to run, but rather can be run only as a subprocess when called by a higher-level process.

The subprocess begins at node 1.

Node 2 checks if the document was already approved (for example, in the Reserve Before Approve subprocess). If so, this subprocess ends at node 3 and the workflow (in the PO Approval Process), sends a notification to the buyer that the document has been approved.

Otherwise, node 4 verifies that the document is ready for approval. If not, node 5 sends a notification to the approver that the document failed the state check (for example, the document's status has changed to closed, frozen, or on hold). Then, node 6 reverts the purchase order to its status before it entered this subprocess, and the workflow ends at node 7. If you modify and resubmit the purchase order or create a new one, the PO Approval workflow starts over when you submit the purchase order for approval.

If the document passes the state check, node 8 verifies that the document is complete, such as ensuring that it contains at least one line and one distribution.

If the document is not complete, node 10 sends a notification of such to the approver. The approver can respond to the notification by choosing Retry (if there is a system-level issue), or reject the document. If node 13 cannot reject the document (for example, the document's status has changed to closed, frozen, or on hold), node 14 sends the Unable to Reject Document notification to the document owner.

If the document passes the state check and is complete, node 17 approves the document, and node 19 retrieves purchase order information and other internal workflow attributes, in case these have changed.

If the Document Approval Manager fails at node 4, 8, 13, or 17, the notification activity at node 9, 11, 12, or 18 sends a notification of the failure to the approver. Once the Document Approval Manager is restarted successfully, the workflow continues if the approver or system administrator responds to the notification with Retry.

See: Document Status Checks, page 2-21. See: Document Submission Checks, page 2-22.

## **Approve PO Subprocess Activities**

The following is a description of each activity in the Approve PO subprocess, listed by the activity's display name.

### **Start (Node 1)**

This is a Standard function activity that simply marks the start of the subprocess.

### **Is Document Approved? (Node 2)**

If you are using encumbrance and the document was Pre-Approved at the time that funds were reserved for it, then its status already changed to Approved.

### **Does Document State Allow Approval? (Node 4)**

Examples of document statuses that allow an approval action are Incomplete, In Process, and Pre-Approved.

### **Is Document Complete? (Node 8)**

This function activity verifies that the document is complete—for example, verifying that all the quantities match, and at least one line and one distribution exist.

### **Approve the PO (Node 17)**

This function activity sets the status of the purchase order to Approved.



**Get PO Attributes (Node 19)**

This function activity retrieves key values from the purchase order header and lines, in case these have changed, and assigns them to Workflow attributes.

**Document Manager Failed (Nodes 9, 11, 12, and 18)**

If the Document Approval Manager fails, the approver receives this notification that it failed. Once a system administrator successfully restarts the Document Approval Manager, the approver must respond to the notification by choosing Retry, so that the workflow can continue.

**Document Failed State Check (Node 5)**

This activity sends a notification to the approver that the document failed the state check. See: Document Status Checks, page 2-21.

**Set PO Status to Original Status (Node 6)**

This function activity sets the purchase order back to its status before it entered this process activity, if the document has failed the state check.

**Unable To Approve (Node 10)**

This activity sends a notification to the approver that Purchasing was unable to approve the document.

**Reject the PO (Node 13)**

This function activity updates the status of the document to Rejected and records the rejection in the Action History window. It also reverses encumbrance if the document has been encumbered.

**Unable to Reject Document (Node 14)**

This activity sends a notification to the approver that Purchasing was unable to reject the document—for example, because its status is closed, frozen, or on hold.

**End (Nodes 3, 7, 15, and 16)**

This function activity marks the end of the process. Although the activity itself does not have a result type, each node of this activity in the process must have a process result assigned to it. The process result is assigned in the property page of the activity node. Since the Approve PO subprocess activity has a result type of PO Approval Action and Doc Verification, each End activity node must have a process result matching one of the lookup codes in the PO Approval Action and Doc Verification lookup type.

## Summary of the Print, Fax, and Email Document Subprocesses

To view the properties of the Print Document Process or the Fax Document Process, select its process activity in the navigator tree, then choose Properties from the Edit menu. This subprocess has a result type of PO Activity Performed, indicating that when the subprocess completes, it has a result of Activity Performed. This result corresponds to the lookup code in the PO Activity Performed lookup type, in the PO Standard item type.

### Print Document Process

The subprocess begins at node 1.

Node 2 checks if Print was selected in the Approve Document window when the purchase order was first submitted for approval. If Print was selected, node 4 prints the document.

### Fax Document Process

The Fax Document Process looks and behaves like the Print Document Process except that node 2 checks if Fax was selected in the Approve Document window. If Fax was selected, node 4 automatically sends a facsimile of the document if a Fax Number was also entered in the Approve Document window. (If a Fax Number was not specified, the document is sent to your facsimile server once it is approved. Depending on your CommercePath setup, you can choose where or when to send the documents that are stored on your facsimile server.)

CommercePath, or any facsimile software that uses the CommercePath Fax Command Language (FCL), must be installed to use the facsimile functionality.

### Email Document Process

The Email Document Process looks and behaves like the Print Document Process except that node 2 checks if Email was selected in the Approve Document window. If Email was selected, node 4 automatically sends an Email of the document if an Email Address was also entered in the Approve Document window.

## Print, Fax, and Email Document Subprocess Activities

The following is a description of each activity in the Print Document, Fax Document, and Email Document subprocesses, listed by the activity's display name.

### Start (Node 1)

This is a Standard function activity that simply marks the start of the subprocess.

### **Does User Want Document Printed? (Node 2)**

This function activity checks if Print was selected in the Approve Document window when the purchase order was first submitted.

In the Fax Document Process, the function activity Does User Want Document Faxed? checks if Fax was selected in the Approve Document window. CommercePath, or any facsimile software that uses the CommercePath Fax Command Language (FCL), must be installed to use the facsimile functionality.

### **Print Document (Node 4)**

If Print was selected in the Approve Document window when the purchase order was first submitted, this activity prints the document.

In the Fax Document Process, the function activity Fax Document automatically sends a facsimile of the document if a Fax Number was entered in the Approve Document window. CommercePath, or any facsimile software that uses the CommercePath Fax Command Language (FCL), must be installed to use the facsimile functionality.

### **End (Nodes 3 and 5)**

This function activity marks the end of the process. Although the activity itself does not have a result type, each node of this activity in the process must have a process result assigned to it. The process result is assigned in the property page of the activity node. Since the Print Document subprocess activity has a result type of PO Activity Performed, each End activity node must have a process result matching one of the lookup codes in the PO Activity Performed lookup type.

## **Summary of the Approve and Forward PO Subprocess**

To view the properties of the Approve and Forward PO subprocess, select its process activity in the navigator tree, then choose Properties from the Edit menu. The Approve and Forward PO subprocess has a result type of PO Approval Action and Doc Verification, indicating that when the subprocess completes, it has a result of Invalid Action or Valid Action. These results correspond to the lookup code in the PO Approval Action and Doc Verification lookup type, in the PO Standard item type.

This subprocess activity is not runnable, indicating that it cannot be initiated as a top-level process to run, but rather can be run only as a subprocess when called by a higher-level process.

The subprocess begins at node 1.

Node 2 checks that the document status is compatible with an approval action (for example, its status is not closed, frozen, or on hold). If the document status is not compatible with an approval action, node 3 sends a notification to the approver that the document failed the state check. Then, at node 4, the subprocess reverts the purchase order to its status before it entered this subprocess, and the workflow ends at node 5. If

you modify and resubmit the purchase order or create a new one, the PO Approval workflow starts over when you submit the purchase order for approval.

If the document passes the state check, node 6 verifies that the document is complete, such as ensuring that it contains at least one line and one distribution.

If the document is not complete, node 7 sends a notification of such to the approver. The approver can respond to the notification by choosing Retry, or reject the document. If node 8 cannot reject the document (because the state check fails again), node 11 sends the Unable to Reject Document notification to the document owner.

If the document is complete, node 13 approves and forwards the purchase order in one step and node 14 retrieves purchase order information and other internal workflow attributes, in case these have changed. The resulting status of the purchase order is Pre-Approved until the forward-to approver approves the purchase order (outside this subprocess) and Reserve Before Approve or Approve PO (also outside this subprocess) sets the purchase order status to Approved.

If the Document Approval Manager fails at node 2, 6, 8, or 13, the notification activity at node 9, 16, 17, or 18 sends a notification of the failure to the approver. Once the Document Approval Manager is restarted successfully, the workflow continues if the approver or system administrator responds to the notification with Retry.

See: Document Status Checks, page 2-21. See: Document Submission Checks, page 2-22.

## **Approve and Forward PO Subprocess Activities**

The following is a description of each activity in the Approve and Forward PO subprocess, listed by the activity's display name.

### **Start (Node 1)**

This is a Standard function activity that simply marks the start of the subprocess.

### **Does Document State Allow Approval? (Node 2)**

Examples of document statuses that allow an approval action are Incomplete, In Process, and Pre-Approved.

### **Is Document Complete? (Node 6)**

This function activity verifies that the document is complete-for example, verifying that all the quantities match, and at least one line and one distribution exist.

### **Approve And Forward The PO (Node 13)**

This function activity approves the purchase order and forwards it to the next approver.

### **Get PO Attributes (Node 14)**

This function activity retrieves key values from the purchase order header and lines, in case these have changed, and assigns them to Workflow attributes.

### **Document Manager Failed (Nodes 9, 16, 17, and 18)**

If the Document Approval Manager fails, the approver receives this notification that it failed. Once a system administrator successfully restarts the Document Approval Manager, the approver must respond to the notification by choosing Retry, so that the workflow can continue.

### **Document Failed State Check (Node 3)**

This function activity sends a notification to the approver that the document failed the state check. See: Document Status Checks, page 2-21.

### **Set PO Status to Original Status (Node 4)**

This function activity sets the purchase order back to its status before it entered this process activity, if the document has failed the state check.

### **Unable To Approve Document (Node 7)**

This activity sends a notification to the approver that Purchasing was unable to approve the document because the document was incomplete.

### **Reject the PO (Node 8)**

This function activity updates the status of the document to Rejected and records the rejection in the Action History window. It also reverses encumbrance if the document has been encumbered.

### **Unable To Reject Document (Node 11)**

This activity sends a notification to the approver that Purchasing was unable to reject the document-for example, because its status is closed, frozen, or on hold.

### **End (Nodes 5, 10, 12 and 15)**

This function activity marks the end of the process. Although the activity itself does not have a result type, each node of this activity in the process must have a process result assigned to it. The process result is assigned in the property page of the activity node. Since the Approve and Forward PO subprocess activity has a result type of PO Approval Action and Doc Verification, each End activity node must have a process result matching one of the lookup codes in the PO Approval Action and Doc Verification lookup type.

## Summary of the Notify Approver Subprocess

To view the properties of the Notify Approver subprocess, select its process activity in the navigator tree, then choose Properties from the Edit menu. The Notify Approver subprocess has a result type of PO Document Approval Action Process, indicating that when the subprocess completes, it has a result of Approve, Approve and Forward, Forward, Reject, or Timeout. These results correspond to the lookup codes in the PO Document Approval Action Process lookup type, in the PO Standard item type.

This subprocess activity is not runnable, indicating that it cannot be initiated as a top-level process to run, but rather can be run only as a subprocess when called by a higher-level process.

The subprocess begins at node 1.

Node 2 sends a notification to the approver that the document requires approval.

If you have entered a Timeout number in the Properties window for node 2, node 12 sends a reminder notification to the approver. The Timeout number indicates how long the workflow waits before sending the reminder if the approver does not respond. If you have entered a Timeout number for node 12, node 22 sends another reminder. If you have entered a Timeout number for node 22, the workflow ends (times out) at node 33.

Depending on whether the approver responds with Approve, Approve and Forward, Forward, or Timeout, this subprocess sets the correct forward-to and forward-from information: nodes 9, 19, and 29 set this information after an Approve action; nodes 4, 14, and 24 after an Approve and Forward action; nodes 7, 17, and 27 after a Forward action; and node 32 after the subprocess times out if a Timeout is provided.

The PO Approval process, in which this subprocess is contained, behaves differently depending on how the approver responds here-with Approve And Forward, Approve, Reject, or Forward.

## Notify Approver Subprocess Activities

The following is a description of each activity in the Notify Approver subprocess, listed by the activity's display name.

### Start (Node 1)

This is a Standard function activity that simply marks the start of the subprocess.

### Approve PO Notification (Node 2)

This activity sends a notification to the approver requesting approval.

This notification's message uses Document type item attributes to call two PL/SQL functions, one that retrieves all of the lines in the document and displays them in the notification, and another that retrieves the action history of the document and displays

that in the notification.

### **PO Approval Reminder 1 (Node 12)**

If no approval response is received after a period of time, this activity sends a first reminder if you designate a timeout period in the activity's Properties window.

This notification's message uses Document type item attributes to call two PL/SQL functions, one that retrieves all of the lines in the document and displays them in the notification, and another that retrieves the action history of the document and displays that in the notification.

### **PO Approval Reminder 2 (Node 22)**

If still no approval response is received, this activity sends a second reminder if you've entered a timeout period in the activity's Properties window.

This notification's message uses Document type item attributes to call two PL/SQL functions, one that retrieves all of the lines in the document and displays them in the notification, and another that retrieves the action history of the document and displays that in the notification.

### **Set Forward-To/From For Approve Action (Nodes 9, 19, and 29)**

This function activity resets the Forward-To and Forward-From attributes after an Approve action.

### **Is Forward-To Valid? (Node 3, 6, 13, 16, 23, and 26)**

This function activity checks that the Forward-To name entered in the Forward-To field, in response to an approval notification, is a valid user name.

### **Set Forward-To/From App. & Fwd. Action (Nodes 4, 14, and 24)**

This function activity resets the Forward-To and Forward-From attributes after an Approve and Forward action.

### **Set Forward-To/From For Forward Action (Nodes 7, 17, and 27 )**

This function activity resets the Forward-To and Forward-From attributes after a Forward action.

### **Set Forward-To/From For Timeout (Node 32)**

This function activity resets the Forward-To and Forward-From attributes after the previous activity times out (if a Timeout is associated with it).

### **End (Nodes 5, 8, 10, 11, 15, 18, 20, 21, 25, 28, 30, 31, and 33)**

This function activity marks the end of the process. Although the activity itself does not

have a result type, each node of this activity in the process must have a process result assigned to it. The process result is assigned in the property page of the activity node. Since the Notify Approver subprocess activity has a result type of PO Document Approval Action Process, each End activity node must have a process result matching one of the lookup codes in the PO Document Approval Action Process lookup type.

## Summary of the Find Approver Subprocess

To view the properties of the Find Approver subprocess, select its process activity in the navigator tree, then choose Properties from the Edit menu. The Find Approver subprocess has a result type of Yes/No, indicating that when the subprocess completes, it has a result of Yes or No. These results correspond to the lookup codes in the Yes/No lookup type, in the Standard item type.

This subprocess activity is not runnable, indicating that it cannot be initiated as a top-level process to run, but rather can be run only as a subprocess when called by a higher-level process.

This process looks for the next approver in the approval hierarchy if any of the following is true:

- Verify Approval Authority determines that the document owner does not have the authority to approve the document as defined in the Approval Groups and Assign Approval Groups windows. (See: Defining Approval Groups, page 1-21. See: Assigning Approval Groups, page 1-24.)
- Can Owner Approve? finds that Owner Can Approve is not checked for the specific document type in the Document Types window. See: Defining Document Types, page 1-67.
- The approver forwarded the document to another approver during the Notify Approver process, or didn't respond after a certain time, if the Timeout feature is set up.

The subprocess begins at node 1.

If node 2 finds no forward-to approver, node 4 gets the default approval hierarchy—either a specific approval hierarchy that the buyer provides in the Approve Document window, or the default approval hierarchy in Purchasing.

Node 5 checks the forwarding method. If the forwarding method is Direct, the workflow sends the purchase order to the first person with enough approval authority, starting at node 13. If the forwarding method is Hierarchy, each person in the hierarchy must take action until a person with enough approval authority is reached, starting at node 6.

Nodes 6 and 13 check whether you use position hierarchies. If you do, nodes 7 and 14 use your position hierarchy to find the next approver. If you do not, nodes 10 and 19 use your employee/supervisor hierarchy to find the next approver.



If the Document Approval Manager fails at node 16 or 21, the notification activity at node 17 or 22 sends a notification of the failure to the approver. Once the Document Approval Manager is restarted successfully, the workflow continues if the approver or system administrator responds to the notification with Retry.

## **Find Approver Subprocess Activities**

The following is a description of each activity in the Find Approver subprocess, listed by the activity's display name.

### **Start (Node 1)**

This is a Standard function activity that simply marks the start of the subprocess.

### **Is Forward-To Provided? (Node 2)**

This function activity checks whether the buyer or the approver provided a forward-to user name.

### **Get Approval Path (Node 4)**

This function activity retrieves the approval hierarchy-either a specific approval hierarchy that the buyer provides in the Approve Document window, or the default approval hierarchy in Purchasing.

### **Get Forwarding Mode (Node 5)**

This function activity retrieves the forwarding mode: Hierarchy or Direct. In a Direct mode, the purchase order goes to the first person with enough approval authority. In a Hierarchy mode, each person in the hierarchy must take action until a person with enough approval authority is reached.

### **Are You Using PO Approval Hierarchies? (Nodes 6 and 13)**

This function activity checks whether position hierarchies are being used in approvals. See: Setting Up Document Approval and Security, page 2-1.

### **Get Next Manager in H.R. (Nodes 10 and 19)**

This activity retrieves the buyer's manager if employee/supervisor relationship hierarchies are being used. It gets the buyer's first manager using the HR\_EMPLOYEES and HR\_ASSIGNMENTS tables.

### **Get First Manager in Approval Hierarchy (Nodes 7 and 14)**

This function activity gets the first manager of the buyer using the PO\_EMPLOYEE\_HIERARCHIES and HR\_EMPLOYEES tables, if position hierarchies are being used.

### **Does Approver Have Authority? (Nodes 16 and 21)**

This function activity verifies the approver's approval authority based on the authority limits defined in the Approval Groups and Assign Approval Groups windows.

### **Document Manager Failed (Nodes 17 and 22)**

If the Document Approval Manager fails, the approver receives this notification that it failed. Once a system administrator successfully restarts the Document Approval Manager, the approver must respond to the notification by choosing Retry, so that the workflow can continue.

### **End (Nodes 3, 8, 9, 11, 12, 15,18, 20, and 23)**

This function activity marks the end of the process. Although the activity itself does not have a result type, each node of this activity in the process must have a process result assigned to it. The process result is assigned in the property page of the activity node. Since the Find Approver subprocess activity has a result type of Yes/No, each End activity node must have a process result matching one of the lookup codes in the Yes/No lookup type.

## **Summary of the Forward PO Subprocess**

To view the properties of the Forward PO subprocess, select its process activity in the navigator tree, then choose Properties from the Edit menu. The Forward PO subprocess has a result type of PO Approval Action and Doc Verification, indicating that when the subprocess completes, it has a result of Invalid Action or Valid Action. These results correspond to the lookup codes in the PO Approval Action and Doc Verification lookup type, in the PO Standard item type.

This subprocess activity is not runnable, indicating that it cannot be initiated as a top-level process to run, but rather can be run only as a subprocess when called by a higher-level process.

The subprocess begins at node 1.

If the Find Approver subprocess activity (outside this subprocess, in the overall workflow) finds an approver, this subprocess forwards the purchase order to the next approver.

Node 2 checks if the purchase order is pre-approved (it has been approved by the final approver, but also forwarded to an additional approver; or it has been authorized for approval but funds have not yet been reserved for it, if you use encumbrance accounting). If it has not been pre-approved, node 4 forwards the purchase order with a status of In Process. If it is pre-approved, node 8 forwards the purchase order with a status of Pre-Approved. The PO Approval workflow still considers a document pre-approved until the subprocess Reserve Before Approve or the subprocess Approve PO sets its status to Approved.

After the document is forwarded, nodes 6 and 10 retrieve purchase order information and other internal workflow attributes, in case these have changed.

If the Document Approval Manager fails at node 4 or 8, the notification activity at node 5 or 9 sends a notification of the failure to the person who forwarded the document. Once the Document Approval Manager is restarted successfully, the workflow continues if the approver or system administrator responds to the notification with Retry.

## **Forward PO Subprocess Activities**

The following is a description of each activity in the Forward PO subprocess, listed by the activity's display name.

### **Start (Node 1)**

This is a Standard function activity that simply marks the start of the subprocess.

### **Is PO Pre-Approved? (Node 2)**

This function activity checks if the purchase order has been pre-approved. A Pre-Approved document is one that has already been approved by the appropriate individual, who also chose to forward it to yet another person for approval. Or, it is a document that has been authorized for approval but for which funds have not yet been reserved. The PO Approval workflow still considers a document pre-approved until the subprocess Reserve Before Approve or the subprocess Approve PO sets its status to Approved.

### **Forward PO with Status "In-Process" (Node 4)**

If the purchase order status is Incomplete, this activity sets the status to In Process, forwards the purchase order to the approver, and updates the document's action history with the forward action.

### **Forward PO with Status "Pre-Approved" (Node 8)**

If the purchase order status is Pre-Approved, this activity forwards the purchase order to the next approver without changing its status.

### **Get PO Attributes (Nodes 6 and 10)**

This function activity retrieves key values from the purchase order header and lines, in case these have changed, and assigns them to Workflow attributes.

### **Document Manager Failed (Nodes 5 and 9)**

If the Document Approval Manager fails, the person who forwarded the document receives this notification that it failed. Once a system administrator successfully restarts the Document Approval Manager, the approver must respond to the notification by

choosing Retry, so that the workflow can continue.

### **End (Nodes 3, 7, and 11)**

This function activity marks the end of the process. Although the activity itself does not have a result type, each node of this activity in the process must have a process result assigned to it. The process result is assigned in the property page of the activity node. Since the Forward PO subprocess activity has a result type of PO Approval Action and Doc Verification, each End activity node must have a process result matching one of the lookup codes in the PO Approval Action and Doc Verification lookup type.

## **Summary of the Return PO to Submitter Subprocess**

To view the properties of the Return PO to Submitter subprocess, select its process activity in the navigator tree, then choose Properties from the Edit menu. The Return PO to Submitter subprocess has a result type of PO Activity Performed, indicating that when the subprocess completes, it has a result of Activity Performed. This result corresponds to the lookup code in the PO Activity Performed lookup type, in the PO Standard item type.

This subprocess activity is not runnable, indicating that it cannot be initiated as a top-level process to run, but rather can be run only as a subprocess when called by a higher-level process.

If the Find Approver subprocess activity (outside this subprocess activity, in the PO Approval Process) does not find an approver, the Return PO to Submitter subprocess returns the purchase order to the buyer.

The subprocess begins at node 1. Node 2 sets the document back to its status before it entered this subprocess. Node 3 sends the buyer a notification that no approver was found. Node 5 sends the last approver a notification that no approver was found; however, if node 4 finds that the buyer is also the sole or last approver, the subprocess skips node 5 and ends at node 6 so that the buyer does not receive two notifications.

## **Return PO to Submitter Subprocess Activities**

The following is a description of each activity in the Return PO to Submitter subprocess, listed by the activity's display name.

### **Start (Node 1)**

This is a Standard function activity that simply marks the start of the subprocess.

### **Set PO Status to Original Status (Node 2)**

This activity sets the purchase order back to its status before it entered this process activity, if no approver was found.

### **Notify Preparer Of No Approver Found (Node 3)**

This activity sends a notification to the buyer when no approver is found.

This notification's message uses Document type item attributes to call two PL/SQL functions, one that retrieves all of the lines in the document and displays them in the notification, and another that retrieves the action history of the document and displays that in the notification.

### **Is Submitter Last Approver? (Node 4)**

This function activity checks if the buyer is also the sole or last approver. If so, the subprocess skips node 5 so as not to send the buyer two notifications.

### **Notify Last Approver Of No Approver Found (Node 5)**

This activity sends a notification to the last approver that the next approver was not found.

This notification's message uses Document type item attributes to call two PL/SQL functions, one that retrieves all of the lines in the document and displays them in the notification, and another that retrieves the action history of the document and displays that in the notification.

### **End (Node 6)**

This function activity marks the end of the process. Although the activity itself does not have a result type, each node of this activity in the process must have a process result assigned to it. The process result is assigned in the property page of the activity node. Since the Return Requisition to Submitter subprocess activity has a result type of PO Activity Performed, each End activity node must have a process result matching one of the lookup codes in the PO Activity Performed lookup type.

## **Summary of the Reject PO Subprocess**

To view the properties of the Reject PO subprocess, select its process activity in the navigator tree, then choose Properties from the Edit menu. The Reject PO subprocess has a result type of PO Approval Action and Doc Verification, indicating that when the subprocess completes, it has a result of Invalid Action or Valid Action. These results correspond to the lookup codes in the PO Approval Action and Doc Verification lookup type, in the PO Standard item type.

This subprocess activity is not runnable, indicating that it cannot be initiated as a top-level process to run, but rather can be run only as a subprocess when called by a higher-level process.

The subprocess begins at node 1.

At node 2, this subprocess records the approver's rejection of the purchase order in the Action History window and changes the status of the document to Rejected. If the

subprocess cannot reject the document (for example, the document's status has changed to closed, frozen, or on hold), node 5 sends a notification to the approver that the document could not be rejected. (If the document is rejected, a notification outside this subprocess in the PO Approval process, sends the rejection notification.)

If the Document Approval Manager fails at node 2, node 4 sends a notification of the failure to the approver. Once the Document Approval Manager is restarted successfully, the workflow continues if the approver or system administrator responds to the notification with Retry.

## **Reject PO Subprocess Activities**

The following is a description of each activity in the Reject PO subprocess, listed by the activity's display name.

### **Start (Node 1)**

This is a Standard function activity that simply marks the start of the subprocess.

### **Reject The PO (Node 2)**

This function activity updates the status of the document to Rejected and records the rejection in the Action History window. It also reverses encumbrance if the document has been encumbered.

### **Unable To Reject Document (Node 5)**

This activity sends a notification to the approver that Purchasing was unable to reject the document-for example, because its status is closed, frozen, or on hold.

### **Document Manager Failed (Node 4)**

If the Document Approval Manager fails, the approver receives this notification that it failed. Once a system administrator successfully restarts the Document Approval Manager, the approver must respond to the notification by choosing Retry, so that the workflow can continue.

### **End (Nodes 3 and 6)**

This function activity marks the end of the process. Although the activity itself does not have a result type, each node of this activity in the process must have a process result assigned to it. The process result is assigned in the property page of the activity node. Since the Reject PO subprocess activity has a result type of PO Approval Action and Doc Verification, each End activity node must have a process result matching one of the lookup codes in the PO Approval Action and Doc Verification lookup type.

## Change Order Process Activities

See: Workflow Processes for Approving Change Orders, page E-133.

## Workflow Processes for Approving Change Orders

Whenever you make a change to a document that causes its status to change to Requires Reapproval, that document is routed through the change order workflow. The Change Order workflow uses the same reapproval rules already defined in Purchasing. See: Document Reapproval Rules, page 4-108.

With the change order workflow, Purchasing lets you define what changes to purchase orders or releases—for example, to amounts, suppliers, or dates—require manual reapproval and which are automatically reapproved. If you modify the change order workflow as described in the next section, you can allow certain changes to bypass full (manual) reapproval. All reapproved documents, either fully or automatically reapproved, result in the document revision number's being incremented.

All of the workflow processes and functions relating to change orders can be found within the PO Approval workflow.

The change order workflow begins when all of the following is true:

- Changes to a purchase order cause its Status to change to 'Requires Reapproval.'
- The document revision number of the purchase order increases.
- You select Submit for Approval (and then choose OK) in the Approve Document window or otherwise submit the document for approval.

## Related Topics

Purchase Order Approval Workflow, page E-89

## Customizing the Change Order Workflow

Use the Oracle Workflow Builder to customize workflows. When you customize a workflow, only those documents that are submitted for approval *after* you customize it are affected by the customized workflow.

You can use the Workflow Monitor to follow where certain documents are in a workflow process. See: Overview of Workflow Monitoring, *Oracle Workflow User's Guide*.

### To display the workflow in the Oracle Workflow Builder:

1. Choose Open from the File menu, and connect to the database.

See: Opening and Saving Item Types, *Oracle Workflow Developer's Guide*.

The change order workflow is not actually an item type, like the other Purchasing workflows, but is a group of processes contained in the purchase order approval workflow. Therefore, to display the change order workflow, open the purchase order approval workflow. The Display name of the purchase order approval workflow is *PO Approval*. The name of its Workflow definition file is *poxwfpoa.wft*.

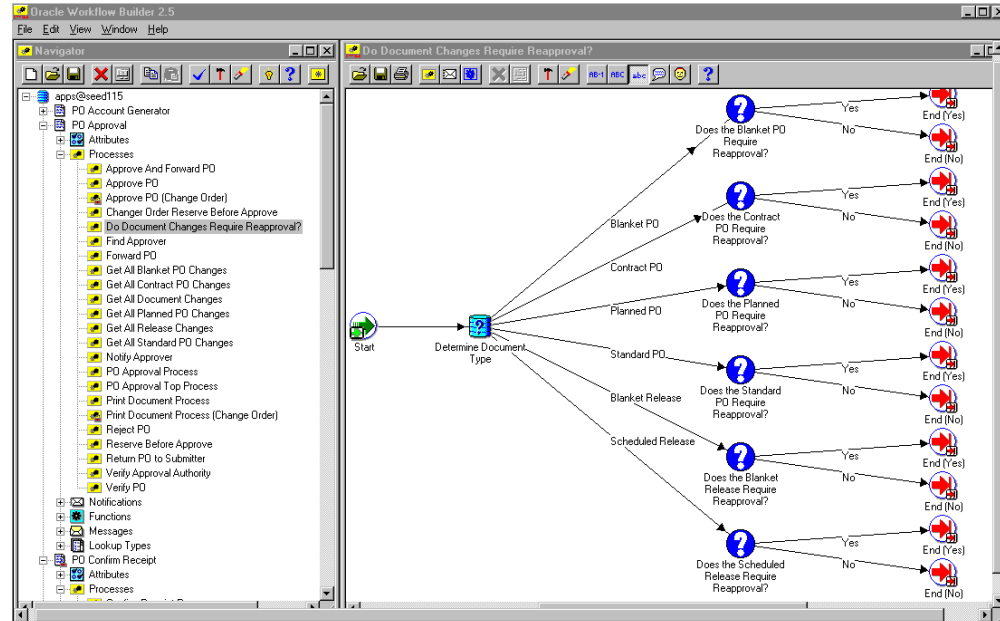

2. Expand the data source, then the PO Approval item type branch within that data source.
3. Expand the Processes branch, then double-click the PO Approval Top Process activity.

You can see the change order processes within the PO Approval Top Process diagram.

### Creating a New Custom Process

For the PO Approval workflow, which contains the change order workflow processes, you can either modify the default workflow that Purchasing provides, or copy it and create a whole new workflow. Use the Document Types window to select a custom PO Approval Workflow Startup Process for specific document types or operating units. See: Customizing the PO Approval Workflow, page E-90.

**Important:** Creating a new workflow process with a new Internal Name affects the implementation of future upgrades. See: Upgrade Support, page E-3.



## Required Modifications

There are no required modifications you need to make to the change order workflow itself.

However, for the change order workflow to work, you must select Archive on Approve in the Document Types window, if you haven't already done this when you set up Purchasing. The Archive on Approve option copies the purchase order information into the archive tables in Purchasing every time you approve or reapprove a purchase order. The change order workflow uses this archive information to compare a document before and after you make a change.

## Supported and Unsupported Customizations

You can modify percentage tolerances used by the change order workflow to determine what percentage increase to a unit price, quantity, or document total requires reapproval. The change order workflow represents these percentage tolerances as item attributes that you can change, using the Workflow Builder. For example, you can change the attribute Change Order Line Unit Price Tolerance from a value of 0 to a value of 20. This means that the document will be reapproved automatically by the change order workflow, without going through the full reapproval process, if the unit price is increased or decreased by less than 20 percent.

You can modify the percentage tolerances for these attributes:

- Change Order Header Blanket Total Tolerance
- Change Order Header Amount Limit Tolerance
- Change Order Header Purchase Order Total Tolerance
- Change Order Line Quantity Tolerance
- Change Order Line Unit Price Tolerance
- Change Order Line Quantity Committed Tolerance
- Change Order Line Agreed Amount Tolerance
- Change Order Line Price Limit Tolerance
- Change Order Shipment Price Override Tolerance
- Change Order Shipment Quantity Tolerance
- Change Order Distribution Quantity Ordered Tolerance

For a complete discussion of what other change order workflow activities you can and *definitely cannot* modify, see: Purchase Order Approval Workflow, page E-89.

To help you with your customizations, refer to the sections later in this document, starting with *The Change Order Workflow Item Attributes*, page E-136. These sections describe the components of the change order processes in the PO Approval workflow. If you haven't already, see also: *Customization Guidelines*, page E-2.

**To modify percentage tolerances:**

1. In the Workflow Navigator, select one of the modifiable Change Order tolerance item attributes listed above.
2. Select the item attribute and open its Properties window.
3. Change the Default value from 0 to your own tolerance value.

For example, if you can change the attribute Change Order Line Unit Price Tolerance from a value of 0 to a value of 20, the document will be reapproved automatically by the change order workflow, without going through the full reapproval process, if the unit price is increased or decreased by less than 20 percent.

## The Change Order Workflow Item Attributes

The change order workflow processes are associated with an item type called PO Approval. The change order process activities in the PO Approval item type are as follows:

- Get All Document Changes, page E-147
- Get All Blanket PO Changes, page E-149
- Get All Contract PO Changes, page E-150
- Get All Planned PO Changes, page E-150
- Get All Release Changes, page E-152
- Get All Standard PO Changes, page E-153
- Do Document Changes Require Reapproval?, page E-154
- Change Order Reserve Before Approve, page E-155
- Approve PO (Change Order), page E-157
- Print Document (Change Order), page E-160
- Fax Document (Change Order), page E-160

These processes have many attributes associated with them. These attributes reference information in the Purchasing application tables. The attributes are used and

maintained by function activities as well as notification activities throughout the change order processes.

The change order workflow item attributes are associated with the PO Approval item type.

**Important:** If one item attribute for one of the document lines does not pass the tolerance check, the entire document needs to go through full reapproval.

### Change Order Workflow: Modifiable Item Type Attributes

Modifiable Item Display Name	Description	Type	Length/Format/lookup Type
Change Order Distribution Quantity Ordered Tolerance	If the change in the distribution Quantity ordered is less than this percentage, the document is reapproved automatically	Number	
Change Order Header Amount Limit Tolerance	If the change to the Amount Limit is less than this percentage, the document is reapproved automatically	Number	
Change Order Header Blanket Total Tolerance	If the change to the blanket Total is less than this percentage, the document is reapproved automatically	Number	
Change Order Header Purchase Order Total Tolerance	If the change to the purchase order Total is less than this percentage, the document is reapproved automatically	Number	
Change Order Line Agreed Amount Tolerance	If the change in Amount Agreed is less than this percentage, the document is reapproved automatically	Number	
Change Order Line Price Limit Tolerance	If the change in Price Limit is less than this percentage, the document is reapproved automatically	Number	
Change Order Line Quantity Committed Tolerance	If the change in Quantity Agreed is less than this percentage, the document is reapproved automatically	Number	

<b>Modifiable Item Display Name</b>	<b>Description</b>	<b>Type</b>	<b>Length/Format/lookup Type</b>
Change Order Line Quantity Tolerance	If the change in Quantity ordered is less than this percentage, the document is reapproved automatically	Number	
Change Order Line Unit Price Tolerance	If the change in unit Price is less than this percentage, the document is reapproved automatically	Number	
Change Order Shipment Price Override Tolerance	If the change in price override is less than this percentage, the document is reapproved automatically	Number	
Change Order Shipment Quantity Tolerance	If the change in the shipment Quantity ordered is less than this percentage, the document is reapproved automatically	Number	

### Change Order Workflow: Header Item Type Attributes

<b>Header Display Name</b>	<b>Description</b>	<b>Type</b>	<b>Length/Format/lookup Type</b>
Change Order Document Type	The type of the document, such as Standard or Blanket Purchase Agreement	Text	
Change Order Header Acceptance Due Date Modified	Indicator of whether the Acceptance Required By date (in the Terms and Conditions window) has changed	Text	1
Change Order Header Acceptance Required Modified	Indicator of whether the Acceptance Required option (in the Terms and Conditions window) has changed	Text	1

<b>Header Display Name</b>	<b>Description</b>	<b>Type</b>	<b>Length/Format/Look up Type</b>
Change Order Header Agent Modified	Indicator of whether the buyer has changed	Text	1
Change Order Header Amount Limit Change	Percentage by which the Amount Limit (in the Terms and Conditions window) has changed	Number	
Change Order Header Amount Limit Modified	Indicator of whether the Amount Limit (in the Terms and Conditions window) has changed	Text	1
Change Order Header Bill To Modified	Indicator of whether the Bill-To location has changed	Text	1
Change Order Header Blanket Total Change	Percentage by which the document Total for a blanket purchase agreement has changed	Number	
Change Order Header Blanket Total Modified	Indicator of whether the document Total for a blanket purchase agreement has changed	Text	1
Change Order Header Cancel Flag Modified	Indicator of whether the document's Canceled status has changed	Text	1
Change Order Header Confirming Order Modified	Indicator of whether the Confirming Order option (in the Terms and Conditions window) has changed	Text	1
Change Order Header End Date Modified	Indicator of whether the Effective end date (in the Terms and Conditions window) has changed	Text	1
Change Order Header FOB Modified	Indicator of whether the free-on-board point (in the Terms and Conditions window) has changed	Text	1

<b>Header Display Name</b>	<b>Description</b>	<b>Type</b>	<b>Length/Format/Look up Type</b>
Change Order Header Freight Modified	Indicator of whether the Freight (in the Terms and Conditions window) has changed	Text	1
Change Order Header Note to Supplier Modified	Indicator of whether the Supplier Note (in the Terms and Conditions window) has changed	Text	1
Change Order Header PO Accepted	Indicator of whether the purchase order's acceptance status (in the Acceptances window) has changed	Text	1
Change Order Header PO Acknowledged	Indicator of whether the purchase order has been acknowledged through the Acceptances window	Text	1
Change Order Header PO Total Change	Percentage by which the purchase order Total has changed	Number	
Change Order Header Ship To Modified	Indicator of whether the document's Ship-To information has changed	Text	1
Change Order Header Ship Via Modified	Indicator of whether the Ship Via information has changed	Text	1
Change Order Header Start Date Modified	Indicator of whether the Effective start date (in the Terms and Conditions window) has changed	Text	1
Change Order Header Supplier Contact Modified	Indicator of whether the Supplier Contact has changed	Text	1
Change Order Header Supplier Site Modified	Indicator of whether the Supplier Site has changed	Text	1

<b>Header Display Name</b>	<b>Description</b>	<b>Type</b>	<b>Length/Format/Lookup Type</b>
Change Order Header Terms Modified	Indicator of whether the Payment term (in the Terms and Conditions window) has changed	Text	1

### Change Order Workflow: Release Item Type Attributes

<b>Release Display Name</b>	<b>Description</b>	<b>Type</b>	<b>Length/Format/Lookup Type</b>
Change Order Release Acceptance Due Date Modified	Indicator of whether the Acceptance Required Due By date has changed on a release	Text	1
Change Order Release Acceptance Required Modified	Indicator of whether the Acceptance Required option has changed on a release	Text	1
Change Order Release Agent Modified	Indicator of whether the buyer on the release has changed	Text	1
Change Order Release Date Modified	Indicator of whether the release creation date has changed	Text	1
Change Order Release Number Modified	Indicator of whether the release document number has changed	Text	1
Change Order Release Total Change	Percentage by which the release Total has changed	Number	

### Change Order Workflow: Line Item Type Attributes

<b>Line Display Name</b>	<b>Description</b>	<b>Type</b>	<b>Length/ Format / Lookup Type</b>
Change Order Lines Agreed Amount Change	Percentage by which the Amount Agreed has changed for an agreement line	Number	
Change Order Lines Agreed Quantity Change	Percentage by which the Quantity Agreed has changed on an agreement line	Number	
Change Order Lines Cancel Flag Modified	Indicator of whether a line's Canceled status has changed	Text	1
Change Order Lines Category Modified	Indicator of whether the item Category has changed	Text	1
Change Order Lines Closed Code Modified	Indicator of whether a line's Closed status has changed	Text	1
Change Order Lines Committed Amount Modified	Indicator of whether the Amount Agreed on the agreement line has changed	Text	1
Change Order Lines Contract Number Modified	Indicator of whether a line's Contract number (in the Reference Documents tabbed region) has changed	Text	1
Change Order Lines From Header Modified	Indicator of whether the unique identifier for the quotation header has changed	Text	1
Change Order Lines From Line Modified	Indicator of whether the unique identifier for the quotation line has changed	Text	1
Change Order Lines Hazard Class Modified	Indicator of whether a line's Hazard Class (in the More tabbed region) has changed	Text	1
Change Order Lines Item Description Modified	Indicator of whether a line's item Description has changed	Text	1



<b>Line Display Name</b>	<b>Description</b>	<b>Type</b>	<b>Length/ Format / Lookup Type</b>
Change Order Lines Item Modified	Indicator of whether a line's Item has changed	Text	1
Change Order Lines Item Revision Modified	Indicator of whether a line's item revision (Rev) has changed	Text	1
Change Order Lines Line Num Modified	Indicator of whether a line number (Num) has changed	Text	1
Change Order Lines Note to Supplier Modified	Indicator of whether a line's Note to the Supplier (in the More tabbed region) has changed	Text	1
Change Order Lines Price Limit Change	Percentage by which the Price Limit (in the Price Reference tabbed region) has changed	Number	
Change Order Lines Price Type Modified	Indicator of whether a line's Price Type (in the Price Reference tabbed region) has changed	Text	1
Change Order Lines Quantity Change	Percentage by which a line's Quantity ordered has changed	Number	
Change Order Lines Quantity Committed Modified	Indicator of whether the Quantity Agreed on the agreement line has changed	Text	1
Change Order Lines Quantity Modified	Indicator of whether a line's Quantity ordered has changed	Text	1
Change Order Lines Supplier Product Number Modified	Indicator of whether a line's Supplier Item number has changed	Text	1
Change Order Lines Unit of Measure Modified	Indicator of whether a line's UOM has changed	Text	1

<b>Line Display Name</b>	<b>Description</b>	<b>Type</b>	<b>Length/ Format / Lookup Type</b>
Change Order Lines Unit Price Change	Percentage by which a line's unit Price has changed	Number	
Change Order Lines Unit Price Modified	Indicator of whether a line's unit Price has changed	Text	1
Change Order Lines UN Number Modified	Indicator of whether a line's UN Number (in the More tabbed region) has changed	Text	1

### Change Order Workflow: Shipment Item Type Attributes

<b>Shipment Display Name</b>	<b>Description</b>	<b>Type</b>	<b>Length/ Format / Lookup Type</b>
Change Order Shipments Cancel Flag Modified	Indicator of whether the shipment's Canceled status has changed	Text	1
Change Order Shipments Closed Code Modified	Indicator of whether the shipment's Closed status has changed	Text	1
Change Order Shipments Last Accept Date Modified	Indicator of whether the latest acceptable receipt date for the shipment (in the Receiving Controls window) has changed	Text	1
Change Order Shipments Need By Date Modified	Indicator of whether the shipment's Need By date has changed	Text	1
Change Order Shipments Price Discount Modified	Indicator of whether the price break has changed	Text	1

<b>Shipment Display Name</b>	<b>Description</b>	<b>Type</b>	<b>Length/Format / Lookup Type</b>
Change Order Shipments Price Override Change	Percentage by which the shipment's price override has changed	Number	
Change Order Shipments Price Override Modified	Indicator of whether the shipment's price override (in the Price Reference tabbed region) has changed	Text	1
Change Order Shipments Promised Date Modified	Indicator of whether the shipment's Promised Date has changed	Text	1
Change Order Shipments Quantity Change	Percentage by which the shipment's Quantity ordered has changed	Number	
Change Order Shipments Quantity Modified	Indicator of whether the shipment's Quantity ordered has changed	Text	1
Change Order Shipments Shipment Number Modified	Indicator of whether the shipment line number (Num) has changed	Text	1
Change Order Shipments Ship To Location Modified	Indicator of whether the shipment's Ship-To location has changed	Text	1
Change Order Shipments Ship To Organization Modified	Indicator of whether the shipment line's ship-to organization (Org) has changed	Text	1
Change Order Shipments Taxable Flag Modified	Indicator of whether the shipment line's Taxable status has changed	Text	1

### Change Order Workflow: Distribution Item Type Attributes

<b>Distribution Display Name</b>	<b>Description</b>	<b>Type</b>	<b>Length/Format / Lookup Type</b>
Change Order Distribution Quantity Ordered Change	Percentage by which the distribution Quantity ordered has changed	Number	
Change Order Distribution Rate Change	Percentage by which the currency conversion Rate on the distribution has changed	Number	
Change Order Distribution Rate Tolerance	Maximum percentage change allowed to the currency conversion rate	Number	
Change Order Distribution Subinventory Modified	Indicator of whether the distribution Subinventory has changed	Text	
Change Order Distributions Charge Account Modified	Indicator of whether the distributions Charge Account has changed	Text	1
Change Order Distributions Deliver To Person Modified	Indicator of whether the distributions Deliver-To person has changed	Text	1
Change Order Distributions GL Encumbered Date Modified	Indicator of whether the distributions GL Date (date the distribution was encumbered) has changed	Text	1
Change Order Distributions Quantity Ordered Modified	Indicator of whether the distribution Quantity ordered has changed	Text	1
Change Order Distributions Rate Date Modified	Indicator of whether the currency conversion Rate Date on the distribution has changed	Text	1

Distribution Display Name	Description	Type	Length/Format / Lookup Type
Change Order Distributions Rate Modified	Indicator of whether the currency conversion Rate on the distribution has changed	Text	1
Change Order Distributions Rate Type Modified	Indicator of whether the currency conversion Rate Type on the distribution has changed	Text	1

## Summary of the Get All Document Changes Subprocess

To view the properties of the Get All Document Changes subprocess, select the process in the navigator tree, then choose Properties from the Edit menu. The Get All Document Changes subprocess has a result type of PO Activity Performed, indicating that when the process completes, it has a result of Activity Performed. This result corresponds to the lookup code in the PO Activity Performed lookup type in the PO Standard item type.

This process activity is not runnable, indicating that it cannot be initiated as a top-level process to run, but rather can be run only as a subprocess when called by a higher-level process.

The Get All Document Changes subprocess is initiated when the PO Approval workflow determines that the document is a changed, not a new, document, and Archive on Approval is chosen for the document type in the Document Types window. (The change order workflow is not initiated unless you have chosen Archive on Approval. See: Required Modifications in Customizing the Change Order Workflow, page E-133.)

The subprocess begins at node 1.

Node 2 determines the document type so that the correct subprocess (nodes 3 through 8) for gathering the document changes begins. For example, if node 2 finds that the document is a contract purchase order, node 3 finds all the changes in the contract purchase order. Nodes 3 through 8 find the changes by comparing the document with its previous archived revision.

## Get All Document Changes Subprocess Activities

The following is a description of each activity in the Get All Document Changes subprocess listed by the activity's display name. You can create all the components for an activity in the graphical Workflow Builder except for the PL/SQL stored procedures that

the function activities call. All function activities execute PL/SQL stored procedures which you must create and store in the Oracle RDBMS. The naming convention for the PL/SQL stored procedures is:

`<PACKAGE>.<PROCEDURE>`

`<PACKAGE>` is the name of the package that groups all of the procedures.

`<PROCEDURE>` represents the name of the procedure.

To view the package and procedure names used by the change order processes, view the Properties page for each function activity. For example, the function activity Determine Document Type uses the `<PACKAGE>.<PROCEDURE>` name `PO_CHORD_WF0.CHORD_DOC_TYPE`.

You can use the Item Type Definitions Web page to view `<PACKAGE>.<PROCEDURE>` names. See: Item Type Definitions Web Page, *Oracle Workflow Developer's Guide*.

### **Start (Node 1)**

This is a Standard function activity that simply marks the start of the subprocess.

### **Determine Document Type (Node 2)**

This function activity looks for the changed document's document type.

### **Get All Contract PO Changes (Node 3)**

See: Get All Contract PO Changes, page E-150.

### **Get All Blanket PO Changes (Node 4)**

See: Get All Blanket PO Changes, page E-149.

### **Get All Planned PO Changes (Node 5)**

See: Get All Planned PO Changes, page E-150.

### **Get All Standard PO Changes (Node 6)**

See: Get All Standard PO Changes, page E-153.

### **Get All Release Changes (Nodes 7 and 8)**

Node 7 gathers all release changes for a blanket release, and node 8 gathers all release changes for a scheduled release. See: Get All Release Changes, page E-152.

### **End (Node 9)**

This function activity marks the end of the process. Although the activity itself does not have a result type, each node of this activity in the process must have a process result assigned to it. The process result is assigned in the property page of the activity node.

Since the Get All Document Changes subprocess activity has a result type of PO Activity Performed, each End activity node must have a process result matching one of the lookup codes in the PO Activity Performed lookup type.

## Summary of the Get All Blanket PO Changes Subprocess

To view the properties of the Get All Blanket PO Changes subprocess, select the process in the navigator tree, then choose Properties from the Edit menu. The Get All Blanket PO Changes subprocess has a result type of PO Activity Performed, indicating that when the process completes, it has a result of Activity Performed. This result corresponds to the lookup code in the PO Activity Performed lookup type in the PO Standard item type.

This process activity is not runnable, indicating that it cannot be initiated as a top-level process to run, but rather can be run only as a subprocess when called by a higher-level process.

The subprocess begins at node 1.

Nodes 2 and 3 compare the document with its previous archived revision to find all header and line changes for a blanket purchase order. The activities update the appropriate item attributes with the changed values.

## Get All Blanket PO Changes Subprocess Activities

The following is a description of each activity in the Get All Blanket PO Changes subprocess, listed by the activity's display name.

### Start (Node 1)

This is a Standard function activity that simply marks the start of the subprocess.

### Get Header Changes (Node 2)

This function activity gathers all of the changes that occurred in the blanket purchase agreement header and updates the appropriate item attributes with the changes.

### Get Lines Changes (Node 3)

This function activity gathers all of the changes that occurred in the blanket purchase agreement lines and updates the appropriate item attributes with the changes.

### End (Node 4)

This function activity marks the end of the process. Although the activity itself does not have a result type, each node of this activity in the process must have a process result assigned to it. The process result is assigned in the property page of the activity node. Since the Get All Blanket PO Changes subprocess activity has a result type of PO Activity Performed, each End activity node must have a process result matching one of

the lookup codes in the PO Activity Performed lookup type.

## Summary of the Get All Contract PO Changes Subprocess

To view the properties of the Get All Contract PO Changes subprocess, select the process in the navigator tree, then choose Properties from the Edit menu. The Get All Contract PO Changes subprocess has a result type of PO Activity Performed, indicating that when the process completes, it has a result of Activity Performed. This result corresponds to the lookup code in the PO Activity Performed lookup type in the PO Standard item type.

This process activity is not runnable, indicating that it cannot be initiated as a top-level process to run, but rather can be run only as a subprocess when called by a higher-level process.

The subprocess begins at node 1.

Node 2 compares the document with its previous archived revision to find all the changes for a contract purchase order. (Contract purchase orders contain only header information.)

## Get All Contract PO Changes Subprocess Activities

The following is a description of each activity in the Get All Contract PO Changes subprocess, listed by the activity's display name.

### Start (Node 1)

This is a Standard function activity that simply marks the start of the subprocess.

### Get Header Changes (Node 2)

This function activity gathers all of the changes that occurred in the contract purchase order header and updates the appropriate item attributes with the changes.

### End (Node 3)

This function activity marks the end of the process. Although the activity itself does not have a result type, each node of this activity in the process must have a process result assigned to it. The process result is assigned in the property page of the activity node. Since the Get All Contract PO Changes subprocess activity has a result type of PO Activity Performed, each End activity node must have a process result matching one of the lookup codes in the PO Activity Performed lookup type.

## Summary of the Get All Planned PO Changes Subprocess

To view the properties of the Get All Planned PO Changes subprocess, select the process in the navigator tree, then choose Properties from the Edit menu. The Get All Planned PO Changes subprocess has a result type of PO Activity Performed, indicating



that when the process completes, it has a result of Activity Performed. This result corresponds to the lookup code in the PO Activity Performed lookup type in the PO Standard item type.

This process activity is not runnable, indicating that it cannot be initiated as a top-level process to run, but rather can be run only as a subprocess when called by a higher-level process.

The subprocess begins at node 1.

Nodes 2, 3, 4, and 5 compare the document with its previous archived revision to find all header, line, shipment, and distribution changes for a planned purchase order.

## **Get All Planned PO Changes Subprocess Activities**

The following is a description of each activity in the Get All Planned PO Changes subprocess, listed by the activity's display name.

### **Start (Node 1)**

This is a Standard function activity that simply marks the start of the subprocess.

### **Get Header Changes (Node 2)**

This function activity gathers all of the changes that occurred in the planned purchase order header and updates the appropriate item attributes with the changes.

### **Get Lines Changes (Node 3)**

This function activity gathers all of the changes that occurred in the planned purchase order lines and updates the appropriate item attributes with the changes.

### **Get Shipments Changes (Node 4)**

This function activity gathers all of the changes that occurred in the planned purchase order shipments and updates the appropriate item attributes with the changes.

### **Get Distribution Changes (Node 5)**

This function activity gathers all of the changes that occurred in the planned purchase order distributions and updates the appropriate item attributes with the changes.

### **End (Node 6)**

This function activity marks the end of the process. Although the activity itself does not have a result type, each node of this activity in the process must have a process result assigned to it. The process result is assigned in the property page of the activity node. Since the Get All Planned PO Changes subprocess activity has a result type of PO Activity Performed, each End activity node must have a process result matching one of the lookup codes in the PO Activity Performed lookup type.

## Summary of the Get All Release Changes Subprocess

To view the properties of the Get All Release Changes subprocess, select the process in the navigator tree, then choose Properties from the Edit menu. The Get All Release Changes subprocess has a result type of PO Activity Performed, indicating that when the process completes, it has a result of Activity Performed. This result corresponds to the lookup code in the PO Activity Performed lookup type in the PO Standard item type.

This process activity is not runnable, indicating that it cannot be initiated as a top-level process to run, but rather can be run only as a subprocess when called by a higher-level process.

The subprocess begins at node 1.

Nodes 2, 3, and 4 compare the document with its previous archived revision to find all release header, shipment, and distribution changes for a blanket or scheduled release.

## Get All Release Changes Subprocess Activities

The following is a description of each activity in the Get All Release Changes subprocess, listed by the activity's display name.

### Start (Node 1)

This is a Standard function activity that simply marks the start of the subprocess.

### Get Release Changes (Node 2)

This function activity gathers all of the changes that occurred in the release header and updates the appropriate item attributes with the changes.

### Get Shipments Changes (Node 3)

This function activity gathers all of the changes that occurred in the release shipments and updates the appropriate item attributes with the changes.

### Get Distribution Changes (Node 4)

This function activity gathers all of the changes that occurred in the release distributions and updates the appropriate item attributes with the changes.

### End (Node 5)

This function activity marks the end of the process. Although the activity itself does not have a result type, each node of this activity in the process must have a process result assigned to it. The process result is assigned in the property page of the activity node. Since the Get All Release Changes subprocess activity has a result type of PO Activity Performed, each End activity node must have a process result matching one of the

lookup codes in the PO Activity Performed lookup type.

## Summary of the Get All Standard PO Changes Subprocess

To view the properties of the Get All Standard PO Changes subprocess, select the process in the navigator tree, then choose Properties from the Edit menu. The Get All Standard PO Changes subprocess has a result type of PO Activity Performed, indicating that when the process completes, it has a result of Activity Performed. This result corresponds to the lookup code in the PO Activity Performed lookup type in the PO Standard item type.

This process activity is not runnable, indicating that it cannot be initiated as a top-level process to run, but rather can be run only as a subprocess when called by a higher-level process.

The subprocess begins at node 1.

Nodes 2, 3, 4, and 5 compare the document with its previous archived revision to find all header, line, shipment, and distribution changes for a standard purchase order.

## Get All Standard PO Changes Subprocess Activities

The following is a description of each activity in the Get All Standard PO Changes subprocess, listed by the activity's display name.

### Start (Node 1)

This is a Standard function activity that simply marks the start of the subprocess.

### Get Header Changes (Node 2)

This function activity gathers all of the changes that occurred in the standard purchase order header and updates the appropriate item attributes with the changes.

### Get Lines Changes (Node 3)

This function activity gathers all of the changes that occurred in the standard purchase order lines and updates the appropriate item attributes with the changes.

### Get Shipments Changes (Node 4)

This function activity gathers all of the changes that occurred in the standard purchase order shipments and updates the appropriate item attributes with the changes.

### Get Distribution Changes (Node 5)

This function activity gathers all of the changes that occurred in the standard purchase order distributions and updates the appropriate item attributes with the changes.

## End (Node 6)

This function activity marks the end of the process. Although the activity itself does not have a result type, each node of this activity in the process must have a process result assigned to it. The process result is assigned in the property page of the activity node. Since the Get All Standard PO Changes subprocess activity has a result type of PO Activity Performed, each End activity node must have a process result matching one of the lookup codes in the PO Activity Performed lookup type.

## Summary of the Do Document Changes Require Reapproval? Subprocess

To view the properties of the Do Document Changes Require Reapproval? subprocess, select the process in the navigator tree, then choose Properties from the Edit menu. The Do Document Changes Require Reapproval? subprocess has a result type of Yes/No, indicating that when the process completes, it has a result of Yes or No. This result corresponds to the lookup code in the Yes/No lookup type in the Standard item type.

This process activity is not runnable, indicating that it cannot be initiated as a top-level process to run, but rather can be run only as a subprocess when called by a higher-level process.

The subprocess begins at node 1.

Node 2 determines the document type. Nodes 3 through 8 determine whether the changed components on the document require the document to go through the full approval process (find the next approver in the approval hierarchy, send notifications, and so on) or to be approved immediately. If the changed components require approval, the PO Approval Process (outside this subprocess, in the overall purchase order approval workflow) begins.

For example, if node 2 finds that the document is a blanket purchase agreement, node 3 checks if the changes to the agreement require full reapproval. Node 4 does the same for contract purchase orders, and so on.

The subprocess Do Document Changes Require Reapproval? uses reapproval rules that are already defined in Purchasing-or the Change Order Tolerance attributes, if you modified them-to determine if the document is required to go through the full approval process.

## Do Document Changes Require Reapproval? Subprocess Activities

The following is a description of each activity in the Do Document Changes Require Reapproval? subprocess, listed by the activity's display name.

### Start (Node 1)

This is a Standard function activity that simply marks the start of the subprocess.

### **Determine Document Type (Node 2)**

This function activity looks for the changed document's document type.

### **Does the Blanket PO Require Reapproval? (Node 3)**

This function activity returns the value of Yes when the blanket purchase agreement is required to go through the approval process and No if it is not. This subprocess uses reapproval rules that are already defined in Purchasing-or the Change Order Tolerance attributes, if you modified them-to determine if the document is required to go through the full PO Approval Process, or if it can be approved immediately.

### **Does the Contract PO Require Reapproval? (Node 4)**

This function activity does the same as the previous activity, for contract purchase orders.

### **Does the Planned PO Require Reapproval? (Node 5)**

This function activity does the same as the previous activity, for planned purchase orders.

### **Does the Scheduled Release Require Reapproval? (Node 8)**

This function activity does the same as the previous activity, for scheduled releases.

### **Does the Standard PO Require Reapproval? (Node 6)**

This function activity does the same as the previous activity, for standard purchase orders.

### **Does the Blanket Release Require Reapproval? (Node 7)**

This function activity does the same as the previous activity, for blanket releases.

### **End (Nodes 9, 10, 11, 12, 13, 14, 15, 16, 17, 18, 19 and 20)**

This function activity marks the end of the process. Although the activity itself does not have a result type, each node of this activity in the process must have a process result assigned to it. The process result is assigned in the property page of the activity node. Since the Do Document Changes Require Reapproval? subprocess activity has a result type of PO Activity Performed, each End activity node must have a process result matching one of the lookup codes in the PO Activity Performed lookup type.

## **Summary of the Change Order Reserve Before Approve Subprocess**

To view the properties of the Change Order Reserve Before Approve subprocess, select the process in the navigator tree, then choose Properties from the Edit menu. The

Change Order Reserve Before Approve subprocess has a result type of Yes/No, indicating that when the process completes, it has a result of Yes or No. This result corresponds to the lookup code in the Yes/No lookup type in the Standard item type.

This process activity is not runnable, indicating that it cannot be initiated as a top-level process to run, but rather can be run only as a subprocess when called by a higher-level process.

The subprocess begins at node 1.

If node 2 finds that encumbrance is on and funds are not yet reserved, node 4 attempts to reserve funds for the document.

If funds cannot be reserved, node 6 sends an Unable to Reserve Document notification to the approver. The approver must then use the Approve Document window to try to reserve the document again if, for example, more funds have been allocated, and then respond to the notification with Retry; reject the document; or forward the document to somebody else with approval authority to reserve the funds.

If the approver forwards the document, node 7 checks if the forward-to approver has a valid user name. If so, node 8 sets the Forward-To/From information for the new approver.

If the approver rejects the document, node 9 rejects the purchase order. If it cannot reject the purchase order (because the document failed the state check—for example, its status has changed to closed, frozen, or on hold), node 11 sends a notification to the approver that the document could not be rejected.

If the Document Approval Manager fails at node 4 or 9, the notification activity at node 5 or 10 sends a notification of the failure to the approver, and the workflow continues if the approver or system administrator responds to the notification with Retry.

## **Change Order Reserve Before Approve Subprocess Activities**

The following is a description of each activity in the Change Order Reserve Before Approve subprocess, listed by the activity's display name.

### **Start (Node 1)**

This is a Standard function activity that simply marks the start of the subprocess.

### **Is Encumbrance On and Is Document Not Reserved? (Node 2)**

This function activity determines whether you are using encumbrance accounting, and whether the document is reserved.

### **Reserve Document (Node 4)**

This function activity tries to reserve funds for the document.

### **Document Manager Failed (Nodes 5 and 10)**

Any time the document manager fails, the approver receives a notification that it failed. Once a system administrator successfully restarts the Document Approval Manager, the approver must respond to the notification by choosing Retry, so that the workflow can continue.

### **Unable To Reserve Document (Node 6 )**

This activity notifies the document owner that Purchasing failed to reserve funds for the document, and provides instructions for resolving the failure.

### **Is Forward-To Valid? (Node 7)**

This function activity checks that the Forward-To name entered in the Forward-To field, in response to an approval notification, is a valid user name.

### **Set Forward-To/From For Forward Action (Node 8)**

This function activity resets the Forward-To and Forward-From attributes after a Forward action.

### **Reject the PO (Node 9)**

This function activity sets a rejected purchase order to a Rejected status and records the rejection in the Action History window. It also reverses encumbrance if the document has been encumbered.

### **Unable to Reject Document (Node 11)**

This activity sends a notification to the document owner that Purchasing was unable to properly reject the document.

### **End (Nodes 3 and 12)**

This function activity marks the end of the process. Although the activity itself does not have a result type, each node of this activity in the process must have a process result assigned to it. The process result is assigned in the property page of the activity node. Since the Change Order Reserve Before Approve subprocess activity has a result type of Yes/No, each End activity node must have a process result matching one of the lookup codes in the Yes/No lookup type.

## **Summary of the Approve PO (Change Order) Subprocess**

To view the properties of the Approve PO (Change Order) subprocess, select its process activity in the navigator tree, then choose Properties from the Edit menu. The Approve PO (Change Order) subprocess has a result type of PO Approval Action and Doc Verification, indicating that when the subprocess completes, it has a result of Invalid

Action or Valid Action. These results correspond to the lookup codes in the PO Approval Action and Doc Verification lookup type, in the PO Standard item type.

This subprocess activity is not runnable, indicating that it cannot be initiated as a top-level process to run, but rather can be run only as a subprocess when called by a higher-level process.

If the change to the purchase order requires full reapproval, this process approves the purchase order. If while approving the purchase order, validation fails, this process sends a notification to the buyer that the document failed state or correctness checks.

The subprocess begins at node 1.

Node 2 checks if the document was already approved (for example, in the Reserve Before Approve subprocess). If so, this subprocess ends at node 3 and the workflow (in the PO Approval Process), sends a notification to the buyer that the document has been approved.

Otherwise, node 4 verifies that the document is ready for approval. If not, node 5 sends a notification to the approver that the document failed the state check (for example, the document's status has changed to closed, frozen, or on hold). Then, node 6 reverts the purchase order to its status before it entered this subprocess, and the workflow ends at node 7. If you modify and resubmit the purchase order or create a new one, the PO Approval workflow starts over when you submit the purchase order for approval.

If the document passes the state check, node 8 verifies that the document is complete, such as ensuring that it contains at least one line and one distribution. If the document is not complete, node 10 sends a notification of such to the approver. The approver can respond to the notification by choosing Retry (useful if there is a system-level issue), or reject the document. If node 13 cannot reject the document (for example, the document's status has changed to closed, frozen, or on hold), node 14 sends the Unable to Reject Document notification to the document owner.

If the document passes the state check and is complete, node 17 approves the document, and node 19 retrieves purchase order information and other internal Workflow attributes, in case these have changed.

If the Document Approval Manager fails at node 4, 8, 13, or 17, the notification activity at node 9, 11, 12, or 18 sends a notification of the failure to the approver. Once the Document Approval Manager is restarted successfully, the workflow continues if the approver or system administrator responds to the notification with Retry.

See: Document Status Checks, page 2-21. See: Document Submission Checks, page 2-22.

## **Approve PO (Change Order) Subprocess Activities**

The following is a description of each activity in the Approve PO subprocess, listed by the activity's display name.



**Start (Node 1)**

This is a Standard function activity that simply marks the start of the subprocess.

**Is Document Approved? (Node 2)**

If you are using encumbrance and the document was Pre-Approved at the time that funds were reserved for it, then its status already changed to Approved.

**Does Document State Allow Approval? (Node 4)**

Examples of document statuses that allow an approval action are Incomplete, In Process, and Pre-Approved.

**Is Document Complete? (Node 8)**

This function activity verifies that the document is complete-for example, verifying that all the quantities match, and at least one line and one distribution exist.

**Approve the PO (Node 17)**

This function activity sets the status of the purchase order to Approved.

**Get PO Attributes (Node 19)**

This function activity retrieves key values from the purchase order header and lines, in case these have changed, and assigns them to Workflow attributes.

**Document Manager Failed (Nodes 9, 11, 12, and 18)**

If the document approval manager fails, the approver receives this notification that it failed. Once a system administrator successfully restarts the document manager, the approver must respond to the notification by choosing Retry, so that the workflow can continue.

**Document Failed State Check (Node 5)**

This activity sends a notification to the approver that the document failed the state check. See: Document Status Checks, page 2-21.

**Set PO Status to Original Status (Node 6)**

This function activity sets the purchase order back to its status before it entered this process activity, if the document has failed the state check.

**Unable To Approve (Node 10)**

This activity sends a notification to the approver that Purchasing was unable to approve the document.

### **Reject the PO (Node 13)**

This function activity updates the status of the document to Rejected and records the rejection in the Action History window.

### **Unable to Reject Document (Node 14)**

This activity sends a notification to the approver that Purchasing was unable to reject the document-for example, because its status is closed, frozen, or on hold.

### **End (Nodes 3, 7, 15, and 16)**

This function activity marks the end of the process. Although the activity itself does not have a result type, each node of this activity in the process must have a process result assigned to it. The process result is assigned in the property page of the activity node. Since the Approve PO (Change Order) subprocess activity has a result type of PO Approval Action and Doc Verification, each End activity node must have a process result matching one of the lookup codes in the PO Approval Action and Doc Verification lookup type.

## **Summary of the Print and Fax Document Processes (Change Order)**

To view the properties of the Print Document Process (Change Order) or the Fax Document Process (Change Order), select its process activity in the navigator tree, then choose Properties from the Edit menu. This subprocess has a result type of PO Activity Performed, indicating that when the subprocess completes, it has a result of Activity Performed. This result corresponds to the lookup code in the PO Activity Performed lookup type, in the PO Standard item type.

### **Print Document Process (Change Order)**

The subprocess begins at node 1.

Node 2 checks if Print was selected in the Approve Document window when the purchase order was first submitted for approval. If Print was selected, node 4 prints the document.

### **Fax Document Process (Change Order)**

The Fax Document Process (Change Order) looks and behaves like the Print Document Process (Change Order) except that node 2 checks if Fax was selected in the Approve Document window. If Fax was selected, node 4 automatically sends a facsimile of the document if a Fax Number was also entered in the Approve Document window. (If a Fax Number was not specified, the document is sent to your facsimile server once it is approved. Depending on your CommercePath setup, you can choose where or when to send the documents that are stored on your facsimile server.)

CommercePath, or any facsimile software that uses the CommercePath Fax Command

Language (FCL), must be installed to use the facsimile functionality.

## **Print and Fax Document Process (Change Order) Activities**

The following is a description of each activity in the Print Document (Change Order) subprocess and the Fax Document (Change Order) subprocess, listed by the activity's display name.

### **Start (Node 1)**

This is a Standard function activity that simply marks the start of the subprocess.

### **Does User Want Document Printed? (Node 2)**

This function activity checks if Print was selected in the Approve Document window when the purchase order was first submitted.

In the Fax Document Process, the function activity Does User Want Document Faxed? checks if Fax was selected in the Approve Document window. CommercePath, or any facsimile software that uses the CommercePath Fax Command Language (FCL), must be installed to use the facsimile functionality.

### **Print Document (Node 4)**

If Print was selected in the Approve Document window when the purchase order was first submitted, this activity prints the document.

In the Fax Document Process, the function activity Fax Document automatically sends a facsimile of the document if a Fax Number was entered in the Approve Document window. CommercePath, or any facsimile software that uses the CommercePath Fax Command Language (FCL), must be installed to use the facsimile functionality.

### **End (Nodes 3 and 5)**

This function activity marks the end of the process. Although the activity itself does not have a result type, each node of this activity in the process must have a process result assigned to it. The process result is assigned in the property page of the activity node. Since the Print Document (Change Order) subprocess activity has a result type of PO Activity Performed, each End activity node must have a process result matching one of the lookup codes in the PO Activity Performed lookup type.

## **Workflow for Creating Purchase Orders and Releases**

Purchasing integrates with Oracle Workflow technology to create standard purchase orders or blanket releases automatically from approved requisition lines. The workflow for creating purchasing documents automatically is called PO Create Documents. You can modify this workflow in the Oracle Workflow Builder to define additional business rules that determine when your approved requisitions are automatically converted into

standard purchase orders and blanket releases.

In the Workflow Builder, PO Create Documents consists of several processes. Each of these processes is viewable in the Workflow Builder as a diagram whose objects and properties you can modify. Each workflow process consists of individual functions.

For each document that is created successfully by the PO Create Documents workflow, the PO Approval workflow is called to approve the document if you have allowed automatic approval. See: Choosing Document Creation Options, page 1-85. See: Purchase Order Approval Workflow, page E-89.

The PO Create Documents workflow is initiated at the end of the requisition approval workflow for approved requisition lines. The workflow begins automatic document creation if you've kept the item attribute Is Automatic Creation Allowed? set to Y for Yes, if source documents are associated with the requisition lines, and you have properly set up sourcing rules (see: Setting Up Automatic Sourcing, page 5-27). If the source document associated with the requisition line is a quotation, a standard purchase order is created. If the source document is a blanket purchase agreement, a release is created.

There are also workflow processes for approving changes to purchase orders and releases. See: Workflow Processes for Approving Change Orders, page E-133.

## Customizing the Automatic Document Creation Workflow

Use the Oracle Workflow Builder to customize workflows. When you customize a workflow, only those documents that are created *after* you customize it are affected by the customized workflow.

You can also use the Workflow Builder to create unique document creation workflows for each document type in your organization. You associate particular workflows with certain document types in the Document Types window. See: Defining Document Types, page 1-67.

You can use the Workflow Monitor to follow where certain documents are in a workflow process. See: Overview of Workflow Monitoring, *Oracle Workflow User's Guide*.

### To display the workflow in the Oracle Workflow Builder:

1. Choose Open from the File menu, and connect to the database.

See: Opening and Saving Item Types, *Oracle Workflow Developer's Guide*.

The Display name of the automatic document creation workflow is *PO Create Documents*. The name of its Workflow definition file is *poxwfatc.wft*.

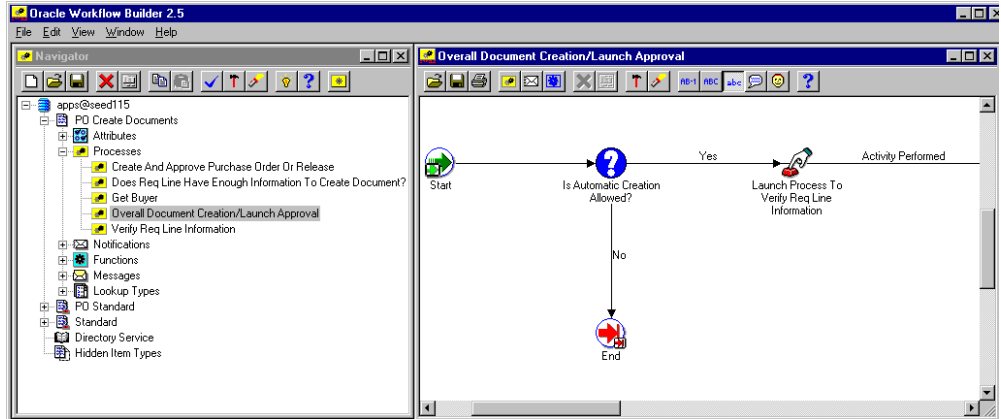

2. Expand the data source, then the PO Create Documents item type branch within that data source.
3. Expand the Processes branch, then double-click a process activity to display its diagram.

### Creating a New Custom Process

You can either modify the default PO Create Documents workflow that Purchasing provides, or copy it and create a whole new workflow. Use the Document Types window to select a custom Workflow Startup Process for specific document types or operating units.

If you create different workflows for different documents or operating units, the recommended practice is not to copy and rename the item type (such as PO Create Documents 1), but to copy and rename the Workflow Startup Process, which you will modify to call your own custom subprocesses. All of your operating units will point to the same item type, and will use the default item attributes and other activities that the item type requires, but one operating unit will also use your custom startup process.

**Important:** Creating a new workflow process with a new Internal Name affects the implementation of future upgrades. See: Upgrade Support, page E-3.

### Required Modifications

There are no required modifications you need to make to the PO Create Documents workflow. However, this documentation assumes that you have already set up Purchasing and performed the Workflow setup steps described in Workflow Setup Options, page 1-85.

## Supported and Unsupported Customizations

Following is a discussion of what you can and *definitely cannot* modify in the PO Create Documents workflow. For those things you *can* modify, the discussion includes important guidelines that you need to be careful of when making customizations.

For important information on how to customize workflows, see the Oracle Workflow Guide, .

To further help you with your customizations, refer to the sections later in this document, starting with The PO Create Documents Workflow Item Attributes, page E-167. These sections describe the components of the automatic document creation processes in the PO Create Documents workflow. If you haven't already, see also: Customization Guidelines, page E-2.

**Important:** If a particular Workflow object does not appear in the following sections on the lists of things you can customize, do not modify it, regardless of its access level.

## Attributes

You can modify the following attributes only, by changing their Default Value:

- Is Automatic Creation Allowed?
- Is Automatic Approval Allowed?
- Should Workflow Create the Release?

For information on modifying these item attributes' default values, see: Choosing Document Creation Options, page 1-85.

## Processes

If you modify a process, it is essential that the basic flow remain intact to maintain data integrity in the database. For example, the function activity Get Req Line Info in the process Verify Req Line Information updates many item attributes with requisition line information. In turn, these item attributes pass that information on to other function activities and processes in the workflow. Therefore, you should not remove or bypass this function activity, and if you replace it with one of your own, you still need to make sure that these item attributes are set. However, you could add additional checks (processes or function activities) to the Verify Req Line Information process.

If you modify any process, either by replacing a portion of its flow or by adding additional function activities, remember the following:

- Attributes that are set by default function activities in the default processes must also be set if you replace default function activities with ones of your own. That is, if

a function activity in that process uses a SetItemAttr statement, then that function activity is setting an attribute to be used by another function activity later. Therefore, your new function activity must do the same. You should also preserve SetItemUserKey and SetItemOwner statements if any. Depending on your customizations, you may also want to preserve GetItemAttr statements.

- Any database state maintained by the default processes must also be maintained by processes you customize. That is, if a function activity in that process uses an Update or Insert Into statement, then that function activity is updating or inserting rows in the database. Therefore, your new function activity must maintain the same database state.

To get a list of the workflow function activities that use SetItemAttr, GetItemAttr, SetItemUserKey, SetItemOwner, Insert Into, or Update statements, run the PL/SQL script powfcust. For instructions on running this script, see: Customization Guidelines, page E-2.

You can modify all of the processes in PO Create Documents, taking into careful consideration the information described below for each:

### **Overall Document Creation / Launch Approval**

In the Overall Document Creation / Launch Approval process, you could replace the function activity Is Automatic Creation Allowed? with one of your own. Right now, this function activity looks to an item attribute of the same name to see whether automatic document creation from an approved requisition is allowed. But you could replace this function activity with one of your own that has more complex logic. For example, you could replace this function activity with one that allows automatic document creation for requisitions under a certain total price.

You could also add a notification activity—for example after Launch Process to Create and Approve Purchase Order and Release—to let buyers know that the workflow is currently attempting to create and approve your purchase order.

Other than these kinds of additions, you should not interrupt the basic flow of the Overall Document Creation / Launch Approval process by adding or removing any other function activity.

### **Create and Approve Purchase Order or Release**

Just as with Is Automatic Creation Allowed? in the Overall Document Creation / Launch Approval process, you can replace the function activity Is Automatic Approval Allowed? with one of your own that allows automatic approval for only certain kinds of documents. For example, you could automatically approve purchase orders under a certain total price.

### **Get Buyer**

You could modify the Get Buyer process by adding a final function activity that, if no

buyer is found by any of the previous activities, always uses a certain buyer. Or, you could replace all of these function activities with one or more of your own that simply uses buyer workload to determine which buyer to use for the purchase order or release.

### **Does Req Line Have Enough Information to Automatically Create a Document?**

It is not recommended that you replace the function activities in this process with function activities of your own.

For example, a supplier is required to create a purchase order or release. Therefore, you should not replace the function activity Does The Req Line Have Valid Supplier Information? with anything else. Additionally, information gathered from this function activity is used later by function activities like Launch Process to Create and Approve Purchase Order or Release and Get The Source Document Type which get required supplier and pricing information.

Similarly, if you don't gather source document information through the function activity Does The Req Line Have Valid Source Document Information?, many function activities in the Verify Req Line Information subprocess will not be able to complete.

Even though it is not recommended to replace any of the function activities in Does Req Line Have Enough Information to Automatically Replace a Document?, you could add function activities—for example, additional information checks—to this subprocess.

### **Verify Req Line Information**

In the Verify Req Line Information subprocess, the function activity Should Workflow Create the Release? looks to an item attribute by the same name to see whether the item attribute says Y for Yes or N for No. (You can set this to Y or N yourself, as described in Choosing Document Creation Options, page 1-85. The default is Y for workflow to create the release.) The function activity Should Workflow Create the Release? looks to its corresponding item attribute to determine if Workflow should create the release, or if Workflow should leave the release to you to create, through the AutoCreate Documents window.

You could replace the function activity Should Workflow Create the Release? with one of your own that uses a different logic (besides Yes/No) to determine whether workflow should create the release. You could make a function activity that looks at the pricing or supplier information on a requisition to determine whether to create the release. For example, Workflow could create the release automatically only for certain suppliers; for other suppliers, it won't, and you would use AutoCreate to create those releases yourself.

### **Notifications**

You can modify the following notifications in the PO Create Documents workflow, as your business needs require:

- Purchase Order Or Release Has Been Created



See: To Create a Notification Activity, *Oracle Workflow Developer's Guide*. See also: Message Result, *Oracle Workflow Developer's Guide* and To Create a Message, *Oracle Workflow Developer's Guide*.

## Function Activities

You cannot modify any function activity in the PO Create Documents workflow.

However, you can replace some function activities with function activities of your own. When you replace a function activity, you are modifying the process in which it is contained. See the guidelines for customizing the PO Create Documents processes in the section **Processes** above.

If you substitute default function activities in a process with function activities that you create, you must remember the following:

- The result type of your new function activity must match the result type of the default activity. That is, the Result Type of the function activity in the Workflow Builder needs to match the result type specified by that function activity's corresponding PL/SQL procedure—for example, a Result Type of Yes/No. It also means that if you have, for example, two results (such as Yes and No) in your function activity and corresponding PL/SQL procedure, you need to make sure that there are two corresponding transitions in the workflow diagram (one for Yes and one for No). If you change the result types and transitions in a process, be careful that you aren't deleting or bypassing any special transitions or checks.
- Just as in the section **Processes** above, any attributes that were set by the default function activity must also be set by your customized function activity.
- Just as in the section **Processes** above, any database state maintained by the default function activity must also be maintained by the customized function activity.

## Messages

You can modify the message body of the following messages in the PO Create Documents workflow:

- PO Document Created

## Lookup Types

You cannot modify any Lookup Types in the PO Create Documents workflow.

## The PO Create Documents Item Type

The automatic document creation process is associated with an item type called PO Create Documents. This item type identifies all workflow processes available for automatic purchase order and release creation. The following workflow processes are associated with PO Create Documents:

- Overall Document Creation / Launch Approval, page E-171
- Verify Req Line Information, page E-174
- Does This Req Line Have Enough Information to Automatically Create a Document?, page E-178
- Create and Approve Purchase Order or Release, page E-179
- Get Buyer, page E-181

The PO Create Documents item type also has many attributes associated with it. These attributes reference information in the Purchasing application tables. The attributes are used and maintained by function activities as well as notification activities throughout the process.

### PO Create Documents Workflow Item Type Attributes

Display Name	Description	Type	Length/ Format/ Lookup Type
Agent ID	Unique identifier for the buyer	Number	
Autocreated Document ID	Unique, internal identifier for the workflow-created document	Number	
Buyer UserName	User name of the buyer as set up in Oracle Applications	Text	100
Category ID	Unique identifier for the item category	Number	
Currency Code	Currency used on the document, such as USD	Text	15
Document Number Created	Document (PO) number of the purchase order or release	Text	50
Document Type Created Disp	Display name for the document type	Text	25

<b>Display Name</b>	<b>Description</b>	<b>Type</b>	<b>Length/ Format/ Lookup Type</b>
Document Type To Create	Document type (standard or blanket) that the workflow will create from the requisition	Text	25
Group ID	Unique identifier for the requisition lines, once they are grouped	Number	
Interface Header ID	Temporary identifier for the requisition lines while they are being grouped in the temporary tables	Number	
Interface Source	Requisition Import source such as INV	Text	30
Is Automatic Creation Allowed?	Indicator (Y for Yes or N for No) of whether this workflow is initiated for all approved requisition lines	Text	1
Is Automatic Approval Allowed?	Indicator (Y for Yes or N for No) of whether the purchase order approval workflow is initiated automatically after this workflow	Text	1
Item ID	Unique identifier for the item	Number	
On RFQ Flag	Indicator of whether the requisition line is associated with an RFQ	Text	1
Open Document	Command that Purchasing sends to open the purchase order or release from the notification notifying you that workflow has created the document	Form	
Org ID	Unique identifier for the operating unit in which the document was created	Number	
P-Card ID	Unique identifier for the procurement card number specified on a requisition in iProcurement	Number	
PO Number To Create	Emergency PO Number specified on a requisition in iProcurement	Text	20

<b>Display Name</b>	<b>Description</b>	<b>Type</b>	<b>Length/ Format/ Lookup Type</b>
Rate	Exchange rate on the requisition that gets carried over to the purchase order	Number	
Rate Date	Date upon which the exchange rate is obtained	Date	
Rate Type	Exchange rate type	Text	30
Release Generation Method	Automatic Release/Review, Automatic Release, or Release Using AutoCreate as defined in the Approved Supplier List	Text	25
Requisition ID	Unique identifier for the requisition from which the purchase order or release is being created	Number	
Requisition Line ID	Unique identifier for the requisition line from which the purchase order or release is being created	Number	
RFQ Required Flag	Indicator of whether an RFQ is required for the item on the requisition line before the line can be automatically created onto a purchase order	Text	1
Should Workflow Create The Release?	Indicator (Y for Yes or N for No) of whether this workflow creates releases or leaves them to you to create using AutoCreate	Text	1
Source Document ID	Unique identifier for the source document referenced on the requisition	Number	
Source Document Line Num	Source document line number used on the requisition	Number	
Source Document Type Code	Type of the source document used	Text	25
Suggested Buyer ID	Unique identifier for the suggested buyer on the requisition	Number	

Display Name	Description	Type	Length/ Format/ Lookup Type
Suggested Supplier ID	Unique identifier for the suggested supplier on the requisition	Number	
Suggested Supplier Site	Unique identifier for the suggested supplier site on the requisition	Text	240
Suggested Supplier Name	Name of the suggested supplier on the requisition	Text	80
Suggested Supplier Site ID	Unique identifier for the suggested supplier site on the requisition	Number	

## Summary of Overall Document Creation / Launch Approval Process

To view the properties of the Overall Document Creation / Launch Approval process, select the process in the navigator tree, then choose Properties from the Edit menu. The Overall Document Creation / Launch Approval Process process has a result type of None, indicating that when the process completes, it does not have a specific result of, for example, Invalid or Valid, which are found in the Lookup Types branch in the Workflow Builder. Its subprocesses have specific result types associated with them.

This process activity is also runnable, indicating that it can be initiated as a top-level process to run by making calls to the Workflow Engine *CreateProcess* and *StartProcess* APIs.

The Overall Document Creation / Launch Approval process is initiated when requisition lines are approved, you've kept the item attribute Is Automatic Creation Allowed? set to Y for Yes, a source document is associated with the requisition line, and you have properly set up sourcing rules (see: Setting Up Automatic Sourcing, page 5-27).

The process begins at node 1.

Node 2 checks the item attribute Is Automatic Creation Allowed? to see if this workflow for creating documents automatically from approved requisition lines should begin at all.

If automatic document creation is allowed, node 4 launches the subprocess Verify Req Line Information, which checks if the requisition line has enough information from which to automatically create a document. For example, only requisition lines with

source documents associated with them can be automatically created by this workflow.

Node 5 waits for all the requisition lines to be processed by the subprocess Verify Req Line Information.

After all requisition lines on the requisition are processed, node 6 checks if the requisition is an emergency requisition created in Oracle iProcurement. An emergency requisition is given a purchase order number in advance. Instead of waiting to group similar requisition lines onto single purchase orders or releases, the PO Create Documents workflow places emergency requisition lines onto their own purchase order at node 8. At node 8, the workflow puts all of an emergency requisition's lines (which have the same Emergency PO Number) onto one purchase order, bypassing the grouping of requisition lines at node 7.

For all other requisitions, the requisition lines on each requisition get grouped appropriately by node 7. For example, if two requisition lines on a requisition have the same Supplier, Site, Currency, and Buyer, they are created on a single purchase order header. Node 7 processes and groups lines from one requisition at a time.

Node 9 launches the Create And Approve Purchase Order or Release process. Node 10 waits for the purchase orders or releases to be created and approved before moving on to the next activity. Node 11 removes the requisition lines from the temporary storing place where they were kept to see which ones could be grouped together.

## Overall Document Creation / Launch Approval Process Activities

The following is a description of each activity listed by the activity's display name. You can create all the components for an activity in the graphical Workflow Builder except for the PL/SQL stored procedures that the function activities call. All function activities execute PL/SQL stored procedures which you must create and store in the Oracle RDBMS. The naming convention for the PL/SQL stored procedures is:

`<PACKAGE>.<PROCEDURE>`

`<PACKAGE>` is the name of the package that groups all of the procedures.

`<PROCEDURE>` represents the name of the procedure.

To view the package and procedure names used by the PO Create Documents processes, view the Properties page for each function activity. For example, the function activity Is Automatic Creation Allowed? uses the `<PACKAGE>.<PROCEDURE>` name `PO_AUTOCREATE_DOC.SHOULD_REQ_BE_AUTOCREATED`.

You can use the Item Type Definitions Web page to view `<PACKAGE>.<PROCEDURE>` names. See: Item Type Definitions Web Page, *Oracle Workflow Developer's Guide*.

### Start (Node 1)

This is a Standard function activity that simply marks the start of the subprocess.

### **Is Automatic Creation Allowed? (Node 2)**

This function activity checks the item attribute Is Automatic Creation Allowed? The default value of this item attribute is Y for Yes. If the value is Y, then automatic document creation is allowed, and the workflow continues. You can prevent automatic document creation by setting the default value of this attribute in the Workflow Builder to N for No.

### **Launch Process To Verify Req Line Information (Node 4)**

This function activity retrieves all requisition lines on the requisition that are available for processing and launches the Verify Req Line Information process for each requisition line.

### **Wait For Flow (Nodes 5 and 10)**

The first Wait For Flow activity waits for all the requisition lines to be processed by Verify Req Line Information. The second Wait For Flow activity waits for the purchase orders or releases to be created and approved before moving on to the next activity.

### **Is This An Emergency Requisition? (Node 6)**

Emergency requisitions are created in iProcurement and submitted to Purchasing for approval and document creation. An emergency requisition is given a purchase order number in advance. Instead of waiting to group similar requisition lines onto single purchase orders or releases, this workflow places emergency requisition lines onto their own purchase order, bypassing the grouping of requisition lines.

**Note:** In iProcurement, you cannot put multiple suppliers on an emergency requisition.

For more information about iProcurement, see the *iProcurement Implementaion Manual*.

### **Group Req Lines Into Purchase Orders Or Releases (Node 7)**

Once Verify Req Line Information finishes processing all the requisition lines, this function activity groups together requisition lines that have similar characteristics and allows them to be created onto the same document. For example, if two requisition lines have the same Supplier, Site, Currency, and Buyer, they are created on a single purchase order header. This function activity also groups procurement card lines created in iProcurement that have the same procurement card number, supplier, and supplier site onto one purchase order or release.

### **Put All Requisition Lines On A Purchase Order (Node 8)**

This function activity places all emergency requisition lines, which have the same Emergency PO Number, onto one purchase order.

### Launch Process To Create/Approve PO or Release (Node 9)

This function activity initiates the Create and Approve Purchase Order Or Release process for each document. Then it initiates the PO Approval workflow so that purchase orders or blanket releases that match pre-defined approval criteria get approved automatically.

### Remove Processed Req Lines From Temp Table (Node 11)

In the Verify Req Line Information process, the function activity Insert Req Line Into Temp Table As A Candidate For Creation puts into a temporary table those requisition lines that contain enough information to attempt automatic document creation. These lines are picked up from this table later when certain requisition lines are grouped onto particular purchase orders or releases. Once these purchase orders or releases are created, the lines in this temporary table can be purged. That is what this function activity, Remove Processed Req Lines From Temp Table, does.

### End (Nodes 3 and 12)

This function activity marks the end of the process.

## Summary of the Verify Req Line Information Process

To view the properties of the Verify Req Line Information process, select the process in the navigator tree, then choose Properties from the Edit menu. The Verify Req Line Information process has a result type of PO Req Line AutoCreatable?, indicating that when the process completes, it has a result of Automatic Creation Not Allowed, Automatic Creation Not Done Through Workflow, Not Enough Information For Autocreation, or Req Line Can Be Automatically Created. These results correspond to the lookup codes in the PO Req Line AutoCreatable? lookup type in the PO Create Documents item type.

This process activity is also runnable, indicating that it can be initiated as a top-level process to run by making calls to the Workflow Engine *CreateProcess* and *StartProcess* APIs.

The Verify Req Line Information process is initiated by the activity Launch Process To Verify Req Line Information.

The process begins at node 1.

Node 2 retrieves information from the requisition line. Node 3 checks how the profile option *PO: Warn if RFQ Required before AutoCreate* is set. If it is set to Yes, the requisition line is not on an RFQ, and RFQ Required is checked for the requisition line, the workflow stops automatic document creation because it is unable to issue the warning. This requisition line will be available in the AutoCreate Documents window. Otherwise, even if an RFQ is required for the requisition line, as long as the profile option *PO: Warn if RFQ Required before AutoCreate* is set to No, the workflow continues creating the document.



Node 5 checks if the requisition line has enough information from which to create a purchase order or release.

Node 7 checks if the requisition is an emergency requisition created in iProcurement, and node 8 checks if a procurement (credit) card number is associated with the requisition. Emergency and procurement card requisitions can be created in iProcurement only.

If the requisition line comes from an emergency or procurement card requisition, none of the activities related to node 12 are performed. Since the workflow does not require an emergency or procurement card requisition to have a source document associated with it, the workflow skips node 12, moves directly to node 9, and continues.

**Note:** Although a procurement card requisition line doesn't require a source document, if it *is* associated with a source document such as a blanket purchase agreement, the workflow (through the activity Group Requisition Lines, in a later subprocess) does create a release.

For all other requisition lines, the workflow uses node 12 to retrieve the source document type. If the source document is a quotation, or if the source document is a blanket purchase agreement but the requisition line is for a one-time item, node 9 inserts the requisition line into a temporary table as a candidate for automatic document creation, and the workflow continues.

For a requisition line that has a blanket purchase agreement as a source document (as determined by node 12) and that is not for a one-time time (as determined by node 13), the workflow at node 14 gives different results depending on the release generation method:

- If there is no release generation method, the workflow ends at Node 15.
- If the release generation method is Automatic Release/Review or Automatic Release, the workflow ends at node 16 or 17 respectively; instead the document will be created automatically through the Create Releases process.
- If the release generation method is Release Using AutoCreate, node 19 checks the item attribute Should Workflow Create the Release? to see how you set up Purchasing. If you left this item attribute set to Y for Yes, the workflow creates the release. Otherwise, it ends at node 18, and you can create the release through the AutoCreate Documents window.

**Note:** No release generation method is retrieved for one-time items at node 14 since the Approved Supplier List does not support one-time items and the release generation method is specified in the Approved Supplier List. If the requisition line is for a one-item item but also associated with a blanket purchase agreement, the workflow does create a release from it later, using the activity Group Requisition Lines.

The workflow in this case does not need to retrieve a release generation method from the Approved Supplier List.

## Verify Req Line Information Process Activities

The following is a description of each activity in the Verify Req Line Information process, listed by the activity's display name.

### Start (Node 1)

This is a Standard function activity that simply marks the start of the subprocess.

### Get Req Line Info (Node 2)

This function activity retrieves information from the requisition line and updates the item attributes in the PO Create Documents workflow with the information. For example, the Currency Code attribute (under Attributes in the Workflow Builder) gets updated with information from the Currency field in the Requisition line.

### Does This Req Line Require An RFQ? (Node 3)

This function activity checks if the following is true: RFQ Required is selected in the Requisitions window, the profile option *PO: Warn if RFQ Required before AutoCreate* is set to Yes, and the requisition line has not been autocreated into an RFQ. If all of these are true, the workflow ends because it is unable to issue the RFQ Required warning. Otherwise, the workflow continues.

### Does Req Line Have Enough Information to Create Document? (Node 5)

See: Does This Req Line Have Enough Information to Automatically Create a Document?, page E-178.

### Is This An Emergency Requisition? (Node 7)

Emergency requisitions are created in iProcurement and submitted to Purchasing for approval and document creation. An emergency requisition is given a purchase order number in advance. Since this workflow does not require an emergency requisition line to have a source document, this workflow bypasses the function activity Get The Source Document Type (node 12) for emergency requisition lines.

### Is This Req Line a P-Card Line? (Node 8)

This function activity checks if the requisition line has a procurement card number associated with it. A procurement card (or P-Card) is a corporate credit card used on iProcurement requisitions only.

### **Get The Source Document Type (Node 12)**

This function activity checks for the source document type-blanket agreement or quotation-referenced on the requisition line.

### **Does the Req Line Have A One-Time Item? (Node 13)**

This function activity checks for the type of item-one-time or predefined-used on the requisition line.

### **Get Release Generation Method From ASL (Node 14)**

If the requisition line has a predefined item, this function activity checks if an approved supplier list (ASL) entry exists for that particular combination of item, supplier, and supplier site. Then the function activity retrieves the Release Generation Method specified in the ASL.

If the Release Generation Method is either Automatic Release or Automatic Release Review, then the Creates Releases process in Purchasing will create a blanket release for the requisition line. If the Release Generation Method is Release Using AutoCreate, then the workflow continues.

### **Should Workflow Create The Release? (Node 19)**

This function activity checks the value of the attribute Should Workflow Create The Release? If the value of this attribute is set to Y for Yes, then the workflow creates the release; otherwise, you must use the AutoCreate Documents window to create the release.

### **Insert Req Line Into Temp Table As A Candidate For Creation (Node 9)**

This function activity puts into a temporary table those requisition lines that contain enough information to attempt automatic document creation. These lines are picked up from this table later when certain requisition lines are grouped onto particular purchase orders or releases. Once these purchase orders or releases are created, the lines in this temporary table are purged. (The function activity that does the purging is Remove Processed Req Lines From Temp Table in the Overall Document Creation / Launch Approval Process.)

### **Continue Flow (Node 10)**

This function activity tells the first Wait for Flow function activity in the Overall Document Creation / Launch Approval Process that Verify Req Line Information for a particular requisition line has been completed successfully. Wait for Flow now has to wait only for the other requisition lines to be processed.

## End (Nodes 4, 6, 11, 15, 16, 17, and 18)

This function activity marks the end of the process. Although the activity itself does not have a result type, each node of this activity in the process must have a process result assigned to it. The process result is assigned in the property page of the activity node. Since the Verify Req Line Information process activity has a result type of PO Req Line AutoCreatable?, each End activity node must have a process result matching one of the lookup codes in the PO Req Line AutoCreatable? lookup type.

## Summary of the Does Req Line Have Enough Information To Automatically Create A Document? Process

To view the properties of the Does Req Line Have Enough Information To Automatically Create A Document? process, select the process in the navigator tree, then choose Properties from the Edit menu. This process has a result type of Yes/No, indicating that when the process completes, it has a result of Yes or No. These results correspond to the lookup codes in the Yes/No lookup type in the Standard item type.

This process activity is also runnable, indicating that it can be initiated as a top-level process to run by making calls to the Workflow Engine *CreateProcess* and *StartProcess* APIs.

The process Does Req Line Have Enough Information To Automatically Create A Document? process is used within the process Verify Req Line Information.

The process begins at node 1.

Node 2 checks if the requisition line has enough, correct supplier information, and node 5 checks if the requisition line has enough, correct source document information. This information is needed to automatically create a purchase order or blanket release.

If node 4 indicates that the requisition is an emergency requisition, or node 6 indicates that the requisition is a procurement card requisition, the workflow does not need to check for source document information at node 5 since a source document is not required for these requisitions. Emergency and procurement card requisitions can be created in iProcurement only.

At node 8, the workflow determines which buyer to use for the automatically created document.

## Does Req Line Have Enough Information To Automatically Create A Document? Process Activities

The following is a description of each activity in the Does Req Line Have Enough Information To Automatically Create A Document? process, listed by the activity's display name.

### **Start (Node 1)**

This is a Standard function activity that simply marks the start of the subprocess.

### **Does The Req Line Have Valid Supplier Information? (Node 2)**

This function activity checks if a valid Supplier and Supplier Site exist for the requisition line.

### **Is This An Emergency Requisition? (Node 4)**

Emergency requisitions are created in iProcurement and submitted to Purchasing for approval and document creation. An emergency requisition is given a purchase order number in advance. Since this workflow does not require an emergency requisition line to have a source document, this workflow bypasses the function activity Does The Req Line Have Valid Source Document Information? (node 5) for emergency requisition lines.

### **Is This Req Line a P-Card Line? (Node 6)**

This function activity checks if the requisition line has a procurement card number associated with it. A procurement card (or P-Card) is a corporate credit card used on iProcurement requisitions only.

### **Does The Req Line Have Valid Source Document Information? (Node 5)**

This function activity checks if valid source document information (from a blanket agreement or quotation) exists for the requisition line. Specifically, it checks the source document type, the source document, and the source document line.

### **Get Buyer (Node 8)**

See: Get Buyer, page E-181

### **End (Nodes 3, 7, 9, and 10)**

This function activity marks the end of the process. Although the activity itself does not have a result type, each node of this activity in the process must have a process result assigned to it. The process result is assigned in the property page of the activity node. Since the Does Req Line Have Enough Information To Automatically Create A Document? process activity has a result type of Yes/No, each End activity node must have a process result matching one of the lookup codes in the Yes/No lookup type.

## **Summary of the Create and Approve Purchase Order Or Release Process**

To view the properties of the Create And Approve Purchase Order Or Release process, select the process in the navigator tree, then choose Properties from the Edit menu. The Create And Approve Purchase Order Or Release process has a result type of PO

Document Processed, indicating that when the process completes, it has a result of Document Processed. This result corresponds to the lookup code in the PO Document Processed lookup type in the PO Create Documents item type.

This process activity is also runnable, indicating that it can be initiated as a top-level process to run by making calls to the Workflow Engine CreateProcess and StartProcess APIs.

The Create And Approve Purchase Order Or Release process is initiated by the activity Launch Process To Create/Approve PO or Release.

The process begins at node 1.

Node 2 creates the purchase order or release. For those documents created successfully, node 3 sends a notification to the buyer that the document has been created.

Node 4 checks if the item attribute Is Automatic Approval Allowed? is set to Y for Yes. If it is, node 5 launches the PO Approval workflow to approve the purchase order or release. Node 6 indicates that the workflow should continue with the final activities in the Overall Document Creation/Launch Approval process.

## **Create And Approve Purchase Order Or Release Process Activities**

The following is a description of each activity in the Create And Approve Purchase Order Or Release process, listed by the activity's display name.

### **Start (Node 1)**

This is a Standard function activity that simply marks the start of the subprocess.

### **Create Purchase Order Or Release (Node 2)**

This function activity creates a standard purchase order or blanket release depending on the information on the requisition line.

### **Purchase Order Or Release Has Been Created (Node 3)**

If the document is created successfully, this function activity sends a notification to the buyer.

### **Is Automatic Approval Allowed? (Node 4)**

This function activity checks the value of the attribute, Is Automatic Approval Allowed?. If the item attribute is set to Y for Yes, this workflow launches the PO Approval workflow to approve the purchase order or release. (The default value for the item attribute is N for No.)

### **Launch Document Approval Process (Node 5)**

This function activity launches the PO Approval workflow. See: Purchase Order

### **Continue Flow (Node 6)**

This function activity tells the second Wait for Flow function activity in the Overall Document Creation / Launch Approval Process that the process Create and Approve Purchase Order Or Release has completed. Wait for Flow now has to wait only for the other documents to be processed.

### **End (Node 7)**

This function activity marks the end of the process. Although the activity itself does not have a result type, each node of this activity in the process must have a process result assigned to it. The process result is assigned in the property page of the activity node. Since the Create And Approve Purchase Order Or Release process activity has a result type of PO Document Processed, each End activity node must have a process result matching one of the lookup codes in the PO Document Processed lookup type.

## **Summary of the Get Buyer Subprocess**

To view the properties of the Get Buyer process, select the process in the navigator tree, then choose Properties from the Edit menu. The Get Buyer process has a result type of PO Action Result, indicating that when the process completes, it has a result of Action Failed or Action Complete. These results correspond to the lookup code in the PO Action Result lookup type in the PO Create Documents item type.

This process activity is not runnable, indicating that it cannot be initiated as a top-level process to run, but rather can be run only as a subprocess when called by a higher-level process.

This process retrieves buyer information for the purchase order. Node 2 retrieves a valid buyer name from the buyer field on the requisition line. If no buyer is indicated there, node 4 retrieves the default buyer from the item definition in the Master Item window. If no buyer is indicated there, node 6 retrieves the default category assigned to a buyer in the Define Buyers window. If no buyer is indicated there, node 8 retrieves the buyer from the source document associated with the requisition line. When creating a release, this subprocess retrieves the buyer's name from the blanket agreement.

If the workflow does not find a buyer, it does not create the document. The requisition line, however, will still be available to you in the AutoCreate Documents window in Purchasing.

## **Get Buyer Subprocess Activities**

The following is a description of each activity in the Get buyer process, listed by the activity's display name.

### **Start (Node 1)**

This is a Standard function activity that simply marks the start of the subprocess.

### **Get Buyer From Req Line (Node 2)**

This function activity tries first to get the buyer from the requisition line.

### **Get Buyer From Item (Node 4)**

If Get Buyer From Req Line fails, then this function activity tries to get the buyer assigned to the item in the Master Item window.

### **Get Buyer From Category (Node 6)**

If Get Buyer From Item fails, this function activity tries to get the buyer assigned to the Category on the requisition line.

### **Get Buyer From Source Doc (Node 8)**

If Get Buyer From Category fails, this function activity tries to get the buyer from the source document associated with the requisition line. If more than one or no buyers are assigned, then this function activity fails.

### **End (Nodes 3, 5, 7, and 9)**

This function activity marks the end of the process. Although the activity itself does not have a result type, each node of this activity in the process must have a process result assigned to it. The process result is assigned in the property page of the activity node. Since the Get Buyer subprocess activity has a result type of PO Action Result, each End activity node must have a process result matching one of the lookup codes in the PO Action Result lookup type.

## **Using the Workflow Monitor for the PO Create Documents Workflow**

To monitor a document as it proceeds through a workflow, you need to provide the Workflow Monitor with an item key, which is specific both to the document you are monitoring and the process in which you're monitoring it.

For information on how to use the Workflow Monitor, see: *Overview of Workflow Monitoring*, *Oracle Workflow User's Guide*.

#### **To determine the item key for the PO Create Documents workflow:**

1. Write down the requisition number of the requisition you're monitoring.
2. Find the REQUISITION\_HEADER\_ID by writing the following SQL\* statements. (The REQUISITION\_HEADER\_ID is an internal number not found in the Requisitions window.)



For example, if the requisition number is 12012570, you would write this SQL\* statement:

```
select requisition_header_id
from po_requisition_headers_all
where segment1='12012570';
```

A REQUISITION\_HEADER\_ID is returned.

- Using the REQUISITION\_HEADER\_ID returned in the step above, find the Overall Document Creation / Launch Approval process item key by writing the following SQL\* statements.

For example, if the REQUISITION\_HEADER\_ID is 1024961, you would write the following SQL\* statement:

```
select item_type, item_key, root_activity
from wf_items
where item_key like '1024961'||'%'
and item_type='CREATEPO'
and root_activity='OVERALL_AUTOCREATE_PROCESS';
```

The item key for your requisition, as it appears in the Overall Document Creation / Launch Approval process, is returned. For example:

ITEM_TYP	ITEM_KEY	ROOT_ACTIVITY
CREATEPO	1024961-12374	OVERALL_AUTOCREATE_PROCESS

Next, you need to identify the unique item keys for your requisition as it appears in the other PO Create Documents processes, so that you can monitor it all the way through the workflow. This is described in the next step.

- Using the ITEM\_KEY returned from the step above, find the ITEM\_KEY for the other two workflow processes, Verify Req Line Information and Create and Approve Document, using the following SQL\* statements.

For example, if your ITEM\_KEY is 1024961-12374, you would write this SQL\* statement:

```
select item_type, item_key, root_activity
from wf_items
where parent_item_type = 'CREATEPO'
and parent_item_key = '1024961-12374';
```

REQ\_LINE\_PROCESSING returns an item key for each requisition line. CREATE\_AND\_APPROVE\_DOC returns an item key for each purchase order. For example:

ITEM_TYP	ITEM_KEY	ROOT_ACTIVITY
----------	----------	---------------

CREATEPO 1025575-12375                    REQ\_LINE\_PROCESSING  
CREATEPO 1004590-12376                    CREATE\_AND\_APPROVE\_DOC

You don't need to find item keys for the processes Get Buyer and Does This Req Line Have Enough Information to Automatically Create a Document, because they are subprocesses of the other processes; you can drill down to these subprocesses through the Workflow Monitor, without an item key.

## Confirm Receipts Workflow

The Confirm Receipts workflow sends notifications through the Web, e-mail, or Notifications Summary window to requesters or buyers who create requisitions through Purchasing or Oracle iProcurement. It lets people know they should have received an item.

The Confirm Receipts workflow sends notifications for items with a Destination or Deliver-To Type of Expense, a Routing of Direct Delivery, and a Need-By date that is equal to or later than today's date.

This workflow requires that the Workflow Background Process and the Confirm Receipts Workflow Select Orders process be running. See: Confirm Receipts Workflow Select Orders, page 13-3.

## Customizing the Confirm Receipts Workflow

Use the Oracle Workflow Builder to customize workflows. When you customize a workflow, only those documents that are created *after* you customize it are affected by the customized workflow.

You can use the Workflow Monitor to follow where certain documents are in a workflow process. See: Overview of Workflow Monitoring, *Oracle Workflow User's Guide*

### **To display the workflow in the Oracle Workflow Builder:**

1. Choose Open from the File menu, and connect to the database.

See: Opening and Saving Item Types, *Oracle Workflow Developer's Guide*.

The Display name of the workflow is *PO Confirm Receipt*. The name of its Workflow definition file is *poxwfrco.wft*.

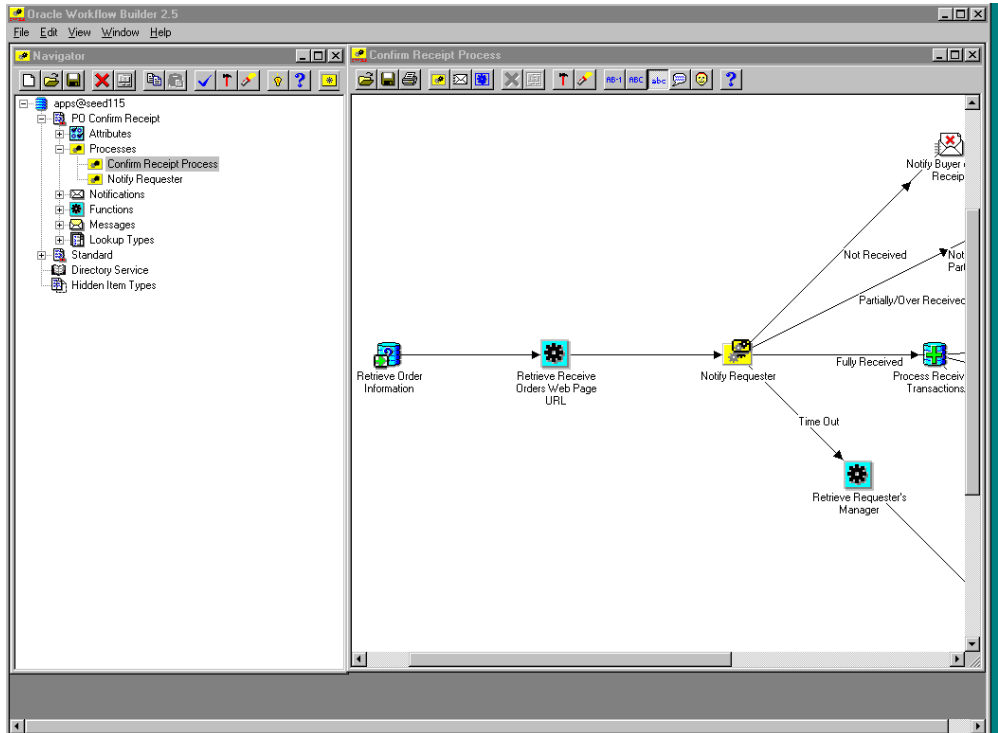

2. Expand the data source, then the PO Confirm Receipt item type branch within that data source.
3. Expand the Processes branch within the PO Confirm Receipt branch, then double-click on a process activity to display its diagram.

### Creating a New Custom Process

If you want to customize the PO Confirm Receipt workflow, you must customize the default (original) workflow that Purchasing provides. Unlike the PO Approval, PO Requisition Approval, and PO Create Documents workflows in Purchasing, only one PO Confirm Receipt workflow can be called from the application itself. You can't select a separate customization, like you can with the other workflows in the Document Types window. Therefore, you need to make your customizations to the default workflow. You'll always have your backup to revert to, if you need, while you are testing your customizations.

### Required Modifications

There are no required modifications you need to make to the PO Confirm Receipt workflow itself. However, for the confirm receipts workflow to work, you need to submit the Workflow Background Process and the Confirm Receipts Workflow Select Orders process. See: Confirm Receipts Workflow Select Orders, page 13-3.

## Optional Customizations

You can change the amount of time given before reminding the requester to respond to a receipt confirmation. You do this by entering your own Timeout intervals in the Control Properties window for each of the notifications in the Notify Requestor subprocess.

These notifications already provide a default Timeout period before which a requester is reminded to respond to the receipt confirmation, but you can change the Timeout to suit your business needs.

### To change the default Timeout intervals:

1. Select any of the following notification activities in the Notify Requestor process:
2. Notify Requestor of Confirm Receipt - initial notification
3. Notify Requestor of Confirm Receipt - first reminder
4. Notify Requestor of Confirm Receipt - second reminder
5. Open the notification's Properties window and change the Timeout period before which the next reminder is sent, or before which the last reminder times out and sends a notification to the requester's manager. For instructions, see the Oracle Workflow Guide, *Oracle Workflow Developer's Guide*.

## Supported and Unsupported Customizations

Following is a discussion of what you can and *definitely cannot* modify in the PO Confirm Receipt workflow. For those things you *can* modify, the discussion includes important guidelines that you need to be very careful of when making customizations.

For important information on how to customize workflows, see the *Oracle Workflow Developer's Guide*.

**Important:** If a particular Workflow object does not appear in the following sections on the lists of things you can customize, do not modify it, regardless of its access level.

### Attributes

You cannot modify any item attributes in the PO Confirm Receipt workflow. However, you can add item attributes.

### Processes

If you modify a process, it is essential that the basic flow remain intact to maintain data integrity in the database:

- Attributes that are set by default function activities in the default processes must also be set if you replace default function activities with ones of your own. That is, if a function activity in that process uses a SetItemAttr statement, then that function activity is setting an attribute to be used by another function activity later. Therefore, your new function activity must do the same. You should also preserve SetItemUserKey and SetItemOwner statements, if any. (Depending on your customizations, you may also want to preserve GetItemAttr statements.)
- Any database state maintained by the default processes must also be maintained by processes you customize. That is, if a function activity in that process uses an Update or Insert Into statement, then that function activity is updating or inserting rows in the database. Therefore, your new function activity must maintain the same database state.

To get a list of the workflow function activities that use SetItemAttr, GetItemAttr, SetItemUserKey, SetItemOwner, Insert Into, or Update statements, run the PL/SQL script powfcust. For instructions on running this script, see: Customization Guidelines, page E-2.

You should not remove any default function activities from the following processes. You may, however, add your own additional function activities to them:

- Confirm Receipt Process
- Notify Requester

## Notifications

You cannot modify any of the PO Confirm Receipt notifications except for the Timeout feature in the Notify Requester of Confirm Receipt notifications in the Notify Requester process.

## Function Activities

You cannot modify any function activities in the PO Confirm Receipt workflow.

However, you can replace some function activities with function activities of your own. When you replace a function activity, you are effectively modifying the process in which it is contained. See the guidelines for customizing the PO Confirm Receipt processes in the section **Processes** above.

If you substitute default function activities in a process with function activities that you create, you must remember the following:

- The result type of your new function activity must match the result type of the default activity. That is, the Result Type of the function activity in the Workflow Builder needs to match the result type specified by that function activity's corresponding PL/SQL procedure—for example, a Result Type of Yes/No. It also means that if you have, for example, two results (such as Yes and No) in your

function activity and corresponding PL/SQL procedure, you need to make sure that there are two corresponding transitions in the workflow diagram (one for Yes and one for No). If you change the result types and transitions in a process, be careful that you aren't deleting or bypassing any special transitions or checks.

- Just as with **Processes** above, any attributes that were set by the default function activity must also be set by your customized function activity.
- Just as with **Processes** above, any database state maintained by the default function activity must also be maintained by the customized function activity.

## Messages

You can modify any of the PO Confirm Receipt messages to suit your business needs.

See: Message Result, *Oracle Workflow Developer's Guide* and To Create a Message, *Oracle Workflow Developer's Guide*.

## Lookup Types

You cannot modify any of the PO Confirm Receipt lookup types.

## The Confirm Receipts Workflow Item Type

The Confirm Receipts workflow process is associated with an item type called PO Confirm Receipt. This item type identifies all workflow processes available for confirming receipts. The following workflow processes are associated with PO Confirm Receipt:

- Confirm Receipt Process, page E-191
- Notify Requester, page E-194

The PO Confirm Receipt item type also has many attributes associated with it. These attributes reference information in the Purchasing application tables. The attributes are used and maintained by function activities as well as notification activities throughout the process.

## PO Confirm Receipt Workflow Item Type Attributes

<b>Display Name</b>	<b>Description</b>	<b>Type</b>	<b>Length/ Format/ Lookup Type</b>
Buyer's Display Name	Buyer's name as displayed in the window field	Text	80
Buyer ID	Unique identifier for the buyer	Text	
Buyer's Username	Buyer's user (short) name as defined in Oracle Applications	Text	80
Currency Code 1-5	The Currency used on the first 5 lines of the requisition	Text	3
Due Date	Date the shipment is due	Date	DD-MON-YYY
Filler11, 12, 21, 22, 31, 32, 41, 42, 51, and 52	Notification boiler-plate text such as "This is" and "for requisition number"	Text	50
Functional Currency	The functional currency used in your Ledger	Text	10
Item description 1-5	Description of the first 5 items	Text	240
Item price 1-5	Price of the first 5 items	Text	20
Line 1-5	First 5 lines on the document, for reference	Text	9
Quantity 1-5	Quantity of each of the first 5 requisition lines	Number	
Manager's Display Name	Name of the requester's manager	Text	80
Manager ID	Unique identifier for the requester's manager	Number	
Manager's Username	User (short) name of the requester's manager as defined in Oracle Applications	Text	80

<b>Display Name</b>	<b>Description</b>	<b>Type</b>	<b>Length/ Format/ Lookup Type</b>
More Lines note	Notification text indicating whether the requisition has more than the first 5 lines displayed in the notification	Text	80
Note from requester	Note from the requester	Text	640
Note to receiver	Note to the receiver of the purchase order, in Terms and Conditions window		
Number of Lines	Number of lines in the notification message to the buyer	Number	
PO Header ID	Purchase order internal identification number	Number	
PO Number	Purchase order number	Text	20
Rct_Qty1-5	Partially received quantity if indicated by requester	Number	
Receive Orders URL	iProcurement Receive Orders Web page URL	URL	
Receiving Transaction Status	Receiving status such as Failed or Pending	Text	500
Requester's Display	Name of the requester on the purchase order or requisition	Text	80
Requester_ID	Unique identifier for the requester	Number	
Requester's Username	User name of the requester on the purchase order or requisition	Text	80
Requisition date 1-5	Date of each of the first 5 requisition lines	Text	30
Requisition number 1-5	Requisition number for each of the first 5 requisition lines used on the order	Text	30



Display Name	Description	Type	Length/ Format/ Lookup Type
Supplier's Display Name	Supplier's name as displayed in the window field	Text	80
Supplier ID	Unique identifier for the supplier	Number	
Total Number of Lines in PO	Total number of lines in the purchase order	Number	
Unit of measure 1-5	UOM for each of the first 5 document lines	Text	15

## Summary of the Confirm Receipt Process

To view the properties of the Confirm Receipt process, select the process in the navigator tree, then choose Properties from the Edit menu. The Confirm Receipt process has a result type of None, indicating that when the process completes, it does not have specific results of, for example, End (Invalid) or End (Valid), which are found in the Lookup Types branch in the Workflow Builder. Instead, this process's subprocesses have specific result types associated with them.

The Details property page of the process activity indicates that the Confirm Receipt process has an error process called DEFAULT\_ERROR associated with it, which gets initiated only when an error is encountered in the process. For example, if the workflow sends a notification to the requester's manager but cannot find the manager's unique identifier (Manager ID), the Workflow Engine would raise an error when it tries to execute the notification activity. This error would initiate DEFAULT\_ERROR, which is the Default Error Process. The Default Error Process is associated with the System:Error item type. Currently the process simply executes the standard Default Error Notification activity to provide information associated with the error. You can customize the process further to suit your needs. See: Default Error Process, *Oracle Workflow Developer's Guide*.

This process activity is also runnable, indicating that it can be initiated as a top-level process to run by making calls to the Workflow Engine *CreateProcess* and *StartProcess* APIs.

The Confirm Receipt process begins when you submit the Confirm Receipts Workflow Select Orders process through the Requests window.

The workflow begins at node 1.

Node 1 retrieves information from the purchase order and requisition that will be used in the message that is sent to the buyer or requester.

Node 2 retrieves a URL that enables you to access the iProcurement Receive Orders Web page from the notification if you wish to process receipt confirmation through Oracle iProcurement, if iProcurement is installed.

At node 3, the subprocess sends a notification to the requester to confirm the receipt of expense items that are past due.

If the requester responds with Not Received, node 4 notifies the buyer that the items have not been received. If the requester responds with Partially/Over Received, node 5 notifies the buyer of such. If the requester responds with Fully Received, node 6 processes the receipt. If the receipt cannot be processed, node 7 sends a notification of the failure to the requester, and node 9 sends a notification of the failure to the buyer.

At node 3, if the requester does not respond before the number of days indicated by the notification activities in the node 3 subprocess, the workflow times out, retrieves the requester's manager from your hierarchy setup (node 10), and notifies the requester's manager (node 11).

## Confirm Receipt Process Activities

The following is a description of each activity listed by the activity's display name. You can create all the components for an activity in the graphical Workflow Builder except for the PL/SQL stored procedures that the function activities call. All function activities execute PL/SQL stored procedures which you must create and store in the Oracle RDBMS. The naming convention for the PL/SQL stored procedures is:

`<PACKAGE>.<PROCEDURE>`

`<PACKAGE>` is the name of the package that groups all of the procedures.

`<PROCEDURE>` represents the name of the procedure.

To view the package and procedure names used by the PO Confirm Receipts processes, view the Properties page for each function activity. For example, the function activity Retrieve Requester's Manager uses the `<PACKAGE>.<PROCEDURE>` name PORCPTWF.GET\_REQUESTER\_MANAGER.

You can use the Item Type Definitions Web page to view `<PACKAGE>.<PROCEDURE>` names. See: Item Type Definitions Web Page, *Oracle Workflow Developer's Guide*.

## Retrieve Order Information (Node 1)

This function activity retrieves the purchase order and requisition information from the RCV\_CONFIRM\_RECEIPT\_V table using the PO\_HEADER\_ID, EXPECTED\_RECEIPT\_DATE and REQUESTER\_ID as search criteria. The retrieved data are used by the Notify Requester subprocess for sending the notification message, which contains the order header and order line data.

### **Retrieve Receive Orders Web Page URL (Node 2)**

This function activity retrieves the URL of the Receive Orders Web page, which you set up through iProcurement. The URL provides a direct link from the workflow notification message to the Receive Orders web page for processing receipt confirmation through iProcurement, if iProcurement is installed.

### **Retrieve Requester's Manager (Node 10 )**

If the requester does not respond before the number of days indicated by the notification activities in the Notify Requester subprocess, this function activity retrieves the manager's user name from your hierarchy setup. The workflow then notifies the manager.

### **Process Receiving Transactions (Node 6)**

This function activity processes transactions in the Receiving Open Interface when the workflow notification is responded to as Fully Received. It ensures that the shipment or shipments are still open. It invokes the Receiving Open Interface program to insert the receipt records into the receiving transactions open interface table.

The Receiving Transaction Manager is then called in *On-line* mode (regardless of how you set the profile option RCV: Processing Mode) to process the receipt records immediately. If there are errors, you receive a notification of such, sent by the activity Notify Receiving Transactions Failure.

### **Notify Requester's Manager of Time Out (Node 11)**

If the requester does not respond before the number of days indicated by the notification activities in the Notify Requester subprocess, this function activity notifies the requester's manager.

### **Notify Receiving Transactions Failure (Nodes 7 and 9)**

There are two of these activities in the Confirm Receipt process. They are used whenever a receipt cannot be created—for example, when the Receiving Transaction Manager has not started or if someone has already created a receipt in the Receipts window. One activity sends a notification to the requester that the receipt could not be created; the other sends the same notification to the buyer. On the Web, this activity presents an error message immediately on the screen. This activity also sends a formal notification to your regular notification queue.

### **Notify Buyer of Partial Receipt (Node 5)**

If the requester responds in the Notify Requester subprocess activity with Partially/Over Received, this activity notifies the buyer that the items have been partially or over-received. The notification shows the quantity that was supposed to be received and the quantity that was actually received.

### Notify Buyer of Non-Receipt (Node 4)

If the requester responds in the Notify Requester subprocess activity with Not Received, this activity notifies the buyer that the items have not been received.

### End (Node 12)

This activity ends the process.

## Summary of the Notify Requester Subprocess

To view the properties of the Notify Requester process, select the process in the navigator tree, then choose Properties from the Edit menu. The Notify Requester process has a result type of Notify Requester Response, indicating that when the process completes, it has a result of Fully Received, Not Received, Partially/Over Received, or Time Out. These results correspond to the lookup code in the Notify Requester Response lookup type in the PO Confirm Receipt item type.

This process activity is also runnable, indicating that it can be initiated as a top-level process to run by making calls to the Workflow Engine *CreateProcess* and *StartProcess* APIs.

This process sends a notification to the requester to confirm the receipt of expense items that are past their due date. The requester can then respond that the items were not received, partially or over-received, or fully received.

The notification activities at nodes 1, 5, and 6 contain the following default Timeout days:

- Notify Requestor of Confirm Receipt - initial notification (node 1) - 7 days
- Notify Requestor of Confirm Receipt - first reminder (node 5) - 7 days
- Notify Requestor of Confirm Receipt - second reminder (node 6) - 1 day

Because the first notification at node 1 contains a default Timeout of 7 days, the second notification at node 5 sends a reminder to the requester after 7 days. The third notification at node 6 sends a final reminder after another 7 days.

Node 6 times out after one additional day, if still no response is received from the requester. The Confirm Receipt process then notifies the requester's manager to confirm receipt of the goods.

You can change these default Timeout numbers to your own desired settings. See: Customizing the Confirm Receipts Workflow, page E-184.

## Notify Requester Subprocess Activities

The following is a description of each activity in the Notify Requester subprocess listed by the activity's display name.

### **Notify Requester of Confirm Receipt - initial notice (Node 1)**

This activity notifies the requester that the requester should have received the goods, and asks for confirmation.

### **Notify Requester of Confirm Receipt - first reminder (Node 5)**

This activity sends a reminder to the requester if no response is received after 7 days (or however many days you specify in the previous activity's Control Properties window; the default is 7 days).

### **Notify Requester of Confirm Receipt - second reminder (Node 6)**

This activity sends a second reminder to the requester if no response is received after another 7 days (or however many days you specify in the previous activity's Control Properties window; the default is 7 days). If still no response is received after one day, the Notify Requester subprocess activity times out and sends the receipt confirmation notification to the requester's manager.

### **End (Nodes 2, 3, 4, 8, 10, and 12)**

This function activity marks the end of the process. Although the activity itself does not have a result type, each node of this activity in the process must have a process result assigned to it. The process result is assigned in the property page of the activity node. Since the Notify Requester subprocess activity has a result type of Notify Requester Response, each End activity node must have a process result matching one of the lookup codes in the Notify Requester Response lookup type.

## **PO Send Notifications Workflow**

The workflow PO Send Notifications for Purchasing Documents looks for documents that are incomplete, rejected, or in need of reapproval and sends notifications to the appropriate people of the document's status. You can view and respond to these notifications through the Notifications Summary window.

For information on the kinds of notifications sent by the Send Notifications for Purchasing Documents process, see: *Viewing and Responding to Notifications*, page 2-29.

In order for these notifications to be sent, you need to start the concurrent program process, Send Notifications for Purchasing Documents, and choose how frequently you want the process to run. See: *Send Notifications for Purchasing Documents*, page 13-36.

## **Customizing the PO Send Notifications for Purchasing Documents Workflow**

Use the Oracle Workflow Builder to customize workflows. When you customize a workflow, only those documents that are created *after* you customize it are affected by

the customized workflow.

You can use the Workflow Monitor to follow where certain documents are in a workflow process. See: Overview of Workflow Monitoring, *Oracle Workflow User's Guide*

**To display the workflow in the Oracle Workflow Builder:**

1. Choose Open from the File menu, and connect to the database.

See: Opening and Saving Item Types, *Oracle Workflow Developer's Guide*.

The Display name of the workflow is *PO Send Notifications for Purchasing Documents*. The name of its Workflow definition file is *poxwfarm.wft*.

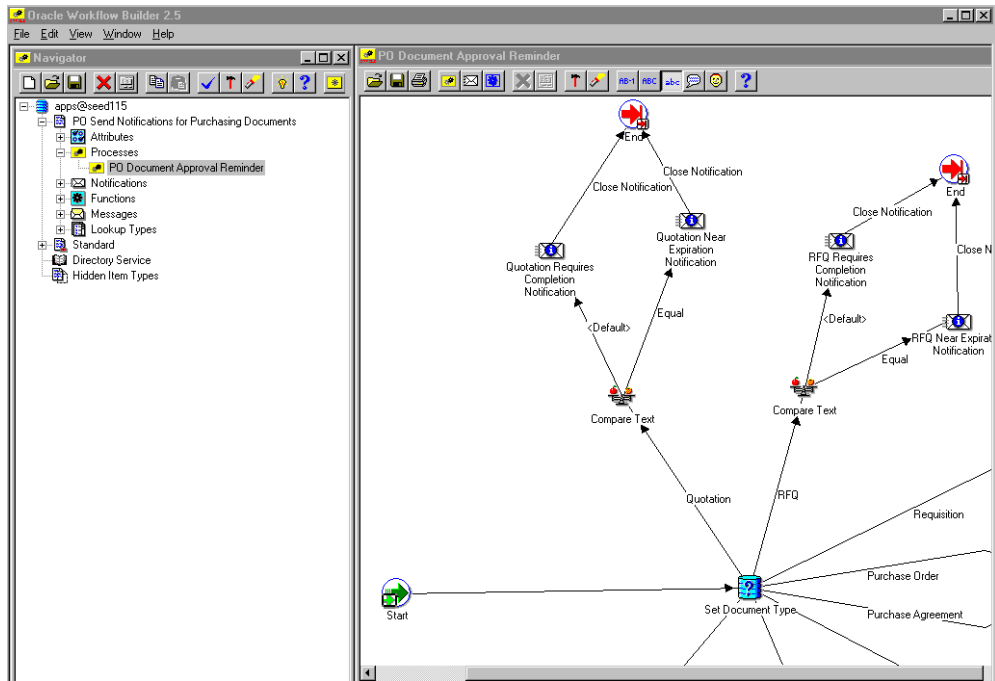

2. Expand the data source, then the PO Send Notifications for Purchasing Documents item type branch within that data source.
3. Expand the Processes branch within PO Send Notifications for Purchasing Documents branch, then double-click on its process activity to display the process diagram.

**Creating a New Custom Process**

If you want to customize the PO Send Notifications for Purchasing Documents workflow, you must customize the default (original) workflow that Purchasing provides. Unlike the PO Approval, PO Requisition Approval, and PO Create Documents workflows in Purchasing, only one PO Send Notifications for Purchasing Documents workflow can be called from the application itself. You can't select a

separate customization, like you can with the other workflows in the Document Types window. Therefore, you need to make your customizations to the default workflow. You'll always have your backup to revert to, if you need, while you are testing your customizations.

### Required Modifications

There are no required modifications you need to make to the PO Send Notifications for Purchasing Documents workflow itself. However, for the workflow to work, you need to start the concurrent program process, Send Notifications for Purchasing Documents, if you didn't already start this process when you set up Purchasing. See: Send Notifications for Purchasing Documents, page 13-36.

### Supported and Unsupported Customizations

Following is a discussion of what you can and *definitely cannot* modify in the PO Send Notifications for Purchasing Documents workflow. For those things you *can* modify, the discussion includes important guidelines that you need to be very careful of when making customizations.

For important information on how to customize workflows, see the *Oracle Workflow Developer's Guide*.

To further help you with your customizations, refer to the sections later in this document, starting with The PO Send Notifications for Purchasing Documents Item Attributes, page E-199. These sections describe the components of the automatic document creation processes in the workflow. If you haven't already, see also: Customization Guidelines, page E-2.

**Important:** If a particular Workflow object does not appear in the following sections on the lists of things you can customize, do not modify it, regardless of its access level.

### Attributes

You cannot modify any of the attributes in the PO Send Notifications for Purchasing Documents workflow.

### Processes

If you modify a process, it is essential that the basic flow remain intact to maintain data integrity in the database:

- Attributes that are set by default function activities in the default processes must also be set if you replace default function activities with ones of your own. That is, if a function activity in that process uses a SetItemAttr statement, then that function activity is setting an attribute to be used by another function activity later. Therefore, your new function activity must do the same. You should also preserve

SetItemUserKey and SetItemOwner statements, if any. (Depending on your customizations, you may also want to preserve GetItemAttr statements.)

- Any database state maintained by the default processes must also be maintained by processes you customize. That is, if a function activity in that process uses an Update or Insert Into statement, then that function activity is updating or inserting rows in the database. Therefore, your new function activity must maintain the same database state.

To get a list of the workflow function activities that use SetItemAttr, GetItemAttr, SetItemUserKey, SetItemOwner, Insert Into, or Update statements, run the PL/SQL script powfcust. For instructions on running this script, see: Customization Guidelines, page E-2.

There is one process in the PO Send Notifications for Purchasing Documents workflow, and you can modify it as your business needs require, paying careful attention to the guidelines described above and in the following section, **Function Activities**:

- PO Document Approval Reminder

## Notifications

You cannot modify any of the notifications in the PO Send Notifications for Purchasing Documents workflow.

## Function Activities

You cannot modify any function activities in the PO Send Notifications for Purchasing Documents workflow.

However, you can replace some function activities with function activities of your own. When you replace a function activity, you are effectively modifying the process in which it is contained. See the guidelines for customizing the processes in the section **Processes** above.

If you substitute default function activities in a process with function activities that you create, you must remember the following:

- The result type of your new function activity must match the result type of the default activity. That is, the Result Type of the function activity in the Workflow Builder needs to match the result type specified by that function activity's corresponding PL/SQL procedure—for example, a Result Type of Yes/No. It also means that if you have, for example, two results (such as Yes and No) in your function activity and corresponding PL/SQL procedure, you need to make sure that there are two corresponding transitions in the workflow diagram (one for Yes and one for No). If you change the result types and transitions in a process, be careful that you aren't deleting or bypassing any special transitions or checks.
- Just as with **Processes** above, any attributes that were set by the default function



activity must also be set by your customized function activity.

- Just as with **Processes** above, any database state maintained by the default function activity must also be maintained by the customized function activity.

## Messages

You can modify any of the messages in the PO Send Notifications for Purchasing Documents workflow, as your business needs require.

See: Message Result, *Oracle Workflow Developer's Guide* and To Create a Message, *Oracle Workflow Developer's Guide*.

## Lookup types

You cannot modify any of the lookup types in the PO Send Notifications for Purchasing Documents workflow.

## The PO Send Notifications for Purchasing Documents Item Type

The notification sending process is associated with an item type called PO Send Notifications for Purchasing Documents. This item type identifies all notification workflow processes available. There is one workflow process associated with PO Send Notifications for Purchasing Documents: PO Document Approval Reminder, page E-202 .

The PO Send Notifications for Purchasing Documents item type also has many attributes associated with it. These attributes reference information in the Purchasing application tables. The attributes are used and maintained by function activities as well as notification activities throughout the process.

## PO Send Notifications for Purchasing Documents Item Type Attributes

Display Name	Description	Type	Length/ Format/ Lookup Type
Acceptance Due Date	Date acceptance is due	Date	
Acceptance Past Due	Indicator that the acceptance due date has passed	Text	25
Agent Display Name	Buyer's name as displayed in Purchasing	Text	250

<b>Display Name</b>	<b>Description</b>	<b>Type</b>	<b>Length/ Format/ Lookup Type</b>
Agent ID	Unique identifier for the buyer	Number	
Agent User Name	Buyer's user name	Text	100
Document ID	Unique identifier for the document submitted to this workflow	Number	
Document Number	Document number for the document submitted to this workflow	Text	80
Document Subtype	Document subtype	Text	80
Document Type	Document type	Text	60
Document Type Display	Document type as displayed in Purchasing	Text	250
Forward From Display Name	Name of the person who forwarded the document, as displayed in Purchasing	Text	250
Forward From ID	Unique identifier of the person who forwarded the document	Number	
Forward From User Name	User name of the person who forwarded the document	Text	250
Forward to Display Name	Name of the forward-to person as displayed in Purchasing	Text	250
Forward to ID	Unique identifier for the forward-to person	Number	
Forward to ID Old Value	Item attribute for internal use that keeps track of the previous forward-to person	Number	

<b>Display Name</b>	<b>Description</b>	<b>Type</b>	<b>Length/ Format/ Lookup Type</b>
Forward to User Name	User name of the forward-to person	Text	250
Never Approved Message	Text message that shows the document was never approved	Text	500
Note	Note text	Text	240
Open PO Form Command	Command that Purchasing sends to open the purchase order from the notification	Form	
Open Quotations Form Command	Command that Purchasing sends to open the quotation from the notification	Form	
Open Release Form Command	Command that Purchasing sends to open the release from the notification	Form	
Open Req Form Command	Command that Purchasing sends to open the requisition from the notification	Form	
Open RFQ Form Command	Command that Purchasing sends to open the RFQ from the notification	Form	
Org ID	Unique identifier for the operating unit	Number	
Quotation Status	Quotation status such as In Process or Active	Text	25
Quote End Date Active	Quotation expiration date	Date	
Quote Type Display	Quotation type as displayed in Purchasing	Text	250
Quote Warning Delay	Number of days prior to the expiration of the quotation that you want to be notified	Number	

Display Name	Description	Type	Length/ Format/ Lookup Type
Release Revision Number	Document revision number	Number	
Requires Approval Message	Text for the Requires Approval message	Text	500
Requisition Rejected Message	Text for the Requisition Rejected message	Text	500
Requisition Returned Message	Text for the Requisition Returned message	Text	500
Response Forward To	Forward-to response	Text	250
RFQ Close Date	Date the RFQ will be closed	Date	
RFQ Reply Date	Date the supplier replied to the RFQ	Date	
RFQ Status	RFQ status such as In Process or Active	Text	25
Wrong Forward to Error Message	Text for "wrong forward-to" message	Text	500

## Summary of the PO Document Approval Reminder Process

To view the properties of the PO Document Approval Reminder process, select the process in the navigator tree, then choose Properties from the Edit menu. The PO Document Approval Reminder process has a result type of None, indicating that when the process completes, it doesn't end with any particular result, such as End (Approved) or End (Rejected). Instead, its subprocesses end with specific results.

This process activity is also runnable, indicating that it can be initiated as a top-level process to run by making calls to the Workflow Engine *CreateProcess* and *StartProcess* APIs.

The workflow begins at node 1.

At node 2, this workflow branches differently depending on whether the document is a

quotation, RFQ, requisition, purchase order, purchase agreement, or release; or a buyer's recording of a supplier's acceptance of a purchase order or release.

Then, at nodes 3, 7, 11, and 15, the workflow uses the standard Workflow comparison activity to determine how to branch next. The comparison activities provide a standard way to compare two numbers, dates, or text strings. Node 3 checks whether the quotation requires completion or is near expiration. Node 7 checks the same for an RFQ. Node 11 checks whether release acceptance is required or past due. Node 15 checks the same for a purchase order.

Nodes 19, 23, and 27 send approval reminder notifications for documents that have not been submitted for approval, such as incomplete documents. These documents are detected by the Send Notifications for Purchasing Documents process.

If the person receiving the reminder notification responds with Ignore, Purchasing dismisses the notification from the person's notification queue until the next time the Send Notifications for Purchasing Documents process runs. The workflow then ends at node 22 or 26.

If the person receiving the reminder notification responds with Approve, the activity at node 20, 24, or 26 makes sure that the forward-to person specified is a valid forward-to approver. If not, the standard Workflow activity at node 21, 25, or 29 directs the workflow to resend the reminder notification.

Node 30 launches the appropriate approval workflow if the notification is answered with Approve and the forward-to approver (if any) is valid.

## PO Document Approval Reminder Process Activities

The following is a description of each activity listed by the activity's display name. You can create all the components for an activity in the graphical Workflow Builder except for the PL/SQL stored procedures that the function activities call. All function activities execute PL/SQL stored procedures which you must create and store in the Oracle RDBMS. The naming convention for the PL/SQL stored procedures is:

`<PACKAGE>.<PROCEDURE>`

`<PACKAGE>` is the name of the package that groups all of the procedures.

`<PROCEDURE>` represents the name of the procedure.

To view the package and procedure names used by the PO Document Approval Reminder process, view the Properties page for each function activity. For example, the function activity Set Document Type uses the `<PACKAGE>.<PROCEDURE>` name `PO_APPROVAL_REMINDER_SV.SET_DOC_TYPE`.

You can use the Item Type Definitions Web page to view `<PACKAGE>.<PROCEDURE>` names. See: Item Type Definitions Web Page, *Oracle Workflow Developer's Guide*.

### Start (Node 1)

This is a Standard function activity that simply marks the start of the process.

### **Set Document Type (Node 2)**

This function activity determines the document type: quotation, RFQ, requisition, purchase order, purchase agreement, release, or a purchase order or release that requires acceptance.

### **Compare Text (Nodes 3, 7, 11, and 15)**

This is a standard Workflow comparison activity that provides a standard way to compare two numbers, dates, or text strings. See: Comparison Activities, *Oracle Workflow Developer's Guide*.

### **Quotation Requires Completion Notification (Node 4)**

This activity sends a notification to the document preparer that the quotation requires completion because its status is still In Process.

### **Quotation Near Expiration Notification (Node 5)**

This activity sends a notification to the document preparer that the quotation is nearing expiration. That is, the quotation is Active, and the current date is between the Effectivity end date on the document and the Quote Warning Delay date in the Purchasing Options window.

### **RFQ Near Expiration Notification (Node 9)**

This activity sends a notification to the document preparer that the RFQ is nearing expiration. That is, the RFQ is Active, and the current date is between the Due Date and the Close Date on the RFQ.

### **RFQ Requires Completion Notification (Node 8)**

This activity sends a notification to the document preparer that the RFQ requires completion because its status is still In Process.

### **Release Acceptance Required Notification (Node 12)**

This activity sends a notification that acceptance is required if Acceptance Required is selected for the release in the Terms and Conditions window, and the release has not been entered as accepted in the Acceptances window.

### **Release Acceptance Past Due Notification (Node 13)**

If the Acceptance Require By date for the release indicates that acceptance is overdue, this activity sends a notification that acceptance is past due.

**PO Acceptance Required Notification (Node 16)**

This activity sends a notification that acceptance is required if Acceptance Required is selected for the purchase order in the Terms and Conditions window, and the purchase order has not been entered as accepted in the Acceptances window.

**PO Acceptance Past Due Notification (Node 17)**

If the Acceptance Require By date for the purchase order indicates that acceptance is overdue, this activity sends a notification that acceptance is past due.

**Approve Requisition Reminder Notification (Node 19)**

This activity sends a notification that the requisition requires approval because it is incomplete, rejected, or in need of reapproval.

**Approve Purchase Order Reminder Notification (Node 23)**

This activity sends a notification that the purchase order requires approval because it is incomplete, rejected, or in need of reapproval.

**Approve Purchase Order Release Reminder Notification (Node 27)**

This activity sends a notification that the release requires approval because it is incomplete, rejected, or in need of reapproval.

**Is Forward to Valid? (Nodes 20, 24, and 28)**

This function activity checks if the person responding to the notification has provided a forward-to approver and, if so, if the forward-to approver is a valid approver.

**Noop (Nodes 21, 25, and 28)**

This is a standard Workflow activity. Here, it is used to simply return to the previous activity, the reminder notification, if the forward-to approver is not valid. See: Noop Activity, *Oracle Workflow Developer's Guide*.

**Start Document Approval**

If the notification is answered with Approve, and the forward-to approver (if any) is valid, this function activity launches the appropriate approval workflow.

**End**

This function activity marks the end of the process.

## Price/Sales Catalog Notification Workflow

The price/sales catalog notification workflow uses the Price Update Tolerance you set to determine when a price increase in an Update price/sales catalog submission exceeds your tolerance. Workflow is an underlying technology that sends a notification to the buyer if the price tolerance is exceeded and waits for the buyer to accept or reject the price increase. The Purchasing Documents Open Interface applies or does not apply the price increase depending on the buyer's action.

The buyer is notified automatically by the workflow. The supplier is notified of price update rejections only if you customize the workflow to do so.

You can view or modify this workflow in the Oracle Workflow Builder. See the *Oracle Workflow Guide*.

The following figure shows how the workflow affects line statuses in the Purchasing Documents Open Interface tables:



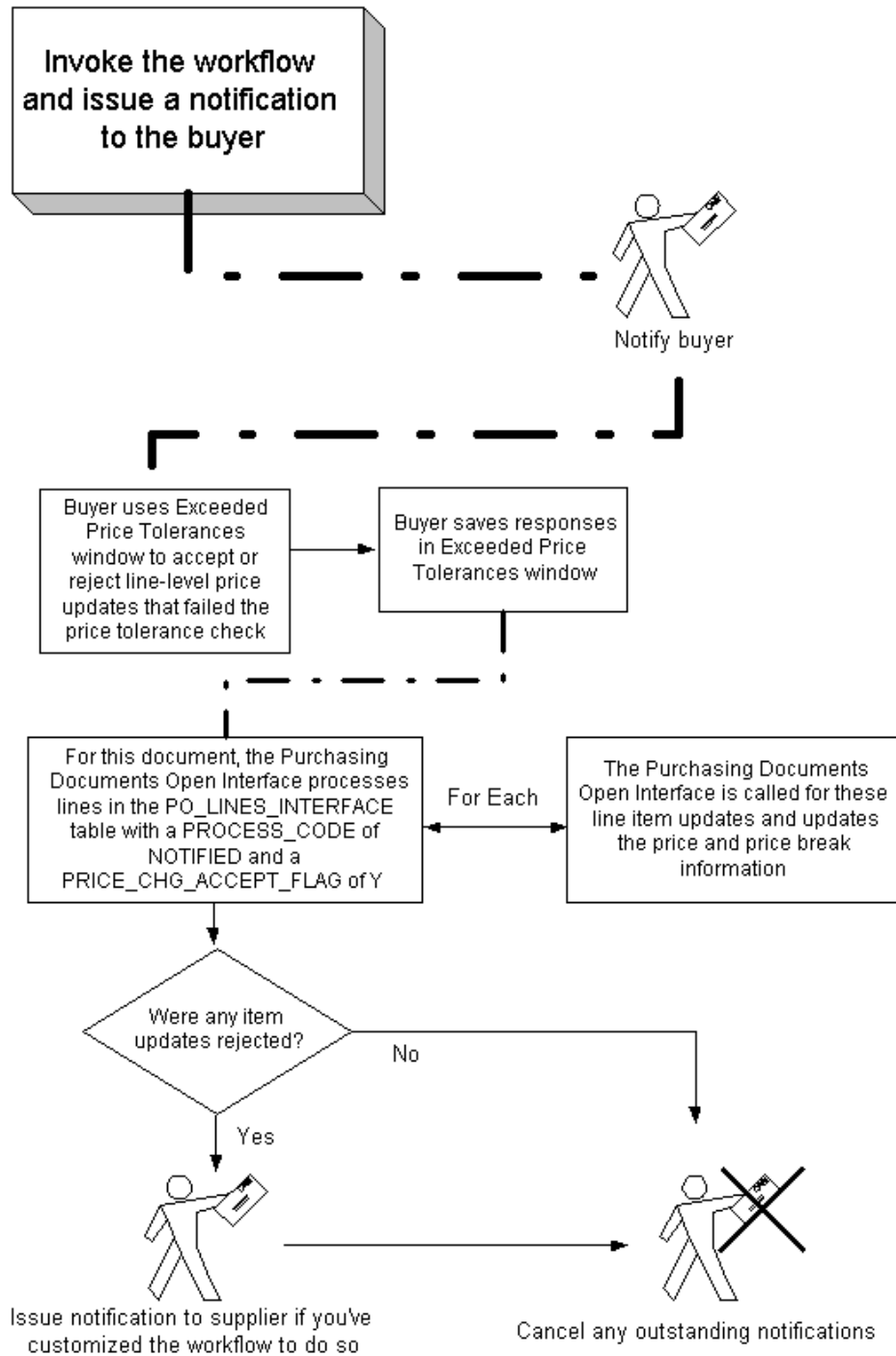

## Customizing the Issue Notifications Process

You can view the workflow in a Process window using the Workflow Builder.

### To display the workflow in the Oracle Workflow Builder:

1. Choose Open from the File menu, and connect to the database.

See: Opening and Saving Item Types, *Oracle Workflow Developer's Guide*.

The Display name of the price/sales catalog notification workflow is *PO Catalog Price Tolerance Exceeded Notifications*. The name of its Workflow definition file is *poxprcat.wft*.

2. Expand the data source, then the item type branch within that data source.
3. Expand the Processes branch, then double-click the Issue Notifications process activity to display its diagram.

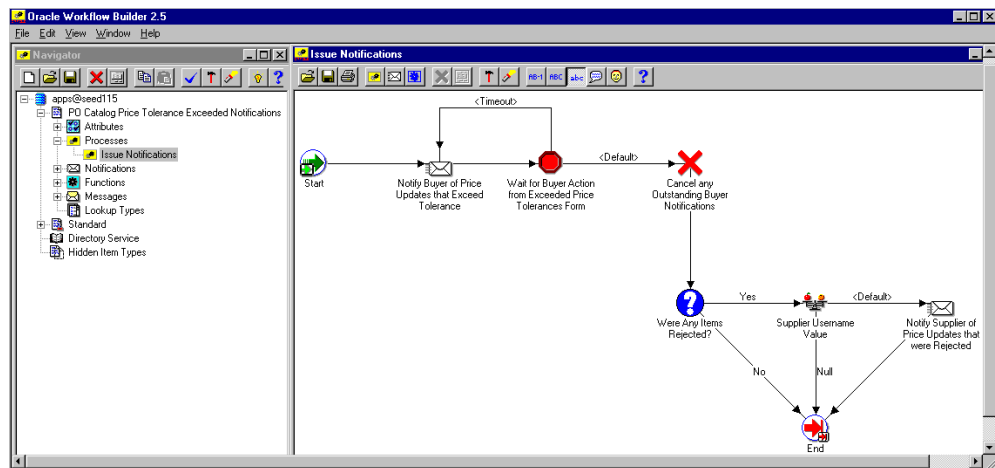

### Required Modifications

There are no required modifications you need to make to this workflow.

### Optional Customizations

Although you can use the workflow as is, you may wish to customize it further to accommodate your organization's specific needs. You can modify the Issue Notifications process to suit your business needs.

You could modify the process to send the buyer a reminder sooner or later than the activity Wait for Buyer Action from Exceeded Price Tolerances Form does by default. You could modify the workflow to send the notification to people other than the buyer. If you want to send the supplier an automatic notification of rejected price updates, you must modify the workflow. Some of these customizations are described below.

To help you with your customizations, refer to the sections later that describe the components of this process.

See also: Customization Guidelines, page E-2.

**To change the Timeout period from seven days:**

1. In the Workflow Builder, expand the Functions branch and select the Wait for Buyer Action from Exceeded Price Tolerances Form activity.
2. Open the activity's Properties window.
3. Change the Timeout to a period of time that best suits your organization's needs.
4. In Oracle Applications, submit the Workflow Background Process if you haven't already. See: To Schedule Background Engines, *Oracle Workflow Administrator's Guide*.

Create Workflow users and roles for your suppliers and associate e-mail addresses with them.

See: Setting Up an Oracle Workflow Directory Service, *Oracle Workflow Administrator's Guide*.

**To send automatic notifications of rejected price updates to the supplier:**

1. Create a function activity that for a given supplier assigns the correct supplier user name to the Supplier User Name item attribute.

When you create a function activity in the Workflow Builder, you also have to create the PL/SQL stored procedure that the function activity calls.

See: To Create a Function Activity, *Oracle Workflow Developer's Guide*.

2. Place the function activity in the Issue Notifications process diagram.

You could place it after the Were Any Items Rejected? activity and before the Supplier Username Value activity. Your new function activity will assign the supplier's user name to the Supplier User Name item attribute. Then, the Supplier Username Value activity retrieves the supplier name from the item attribute.

## Supported and Unsupported Customizations

You cannot modify any of the item attributes except for Supplier User Name. (Information about when you might customize this attribute is provided in the section above.) You cannot modify any of the function activities or messages in the workflow; however, you could replace them in the Issue Notifications process with ones of your own. You can modify the notification activities.

For important information on how to customize workflows, see the *Oracle Workflow Developer's Guide*.

If you modify the process, either by replacing a portion of its flow or by adding additional function activities, remember the following:

- Attributes that are set by default function activities in the default processes must also be set if you replace default function activities with ones of your own. That is, if a function activity in that process uses a SetItemAttr statement, then that function activity is setting an attribute to be used by another function activity later. Therefore, your new function activity must do the same. You should also preserve SetItemUserKey and SetItemOwner statements, if any. (Depending on your customizations, you may also want to preserve GetItemAttr statements.)
- Any database state maintained by the default processes must also be maintained by processes you customize. That is, if a function activity in that process uses an Update or Insert Into statement, then that function activity is updating or inserting rows in the database. Therefore, your new function activity must maintain the same database state.

To get a list of the workflow function activities that use SetItemAttr, GetItemAttr, SetItemUserKey, SetItemOwner, Insert Into, or Update statements, run the PL/SQL script powfcust. For instructions on running this script, see: Customization Guidelines, page E-2.

### Creating a New Custom Process

Customize the default (original) workflow that Purchasing provides, after you make a backup. Unlike the PO Approval, PO Requisition Approval, and PO Create Documents workflows, only one price/sales catalog notification workflow can be called in Purchasing. You can't select a separate customization, like you can with the other workflows in the Document Types window. Therefore, you need to make your customizations to the default workflow. You'll always have your backup to revert to, if you need, while you are testing your customizations.

### The PO Catalog Price Tolerances Exceeded Notifications Item Type

The Issue Notifications process is associated with an item type called PO Catalog Price Tolerances Exceeded Notifications. This item type identifies all workflow processes available with the price/sales catalog update submission.

The PO Catalog Price Tolerances Exceeded Notifications item type also has several attributes associated with it. These attributes reference information in the Purchasing application tables. The attributes are used and maintained by function activities as well as notification activities throughout the process.

To view descriptions of each item type attribute, select the attribute in the Workflow Builder and choose Properties from the Edit menu. Look in the Description field.

### Summary of the Issue Notifications Process

To view the properties of the Issue Notifications process, select the process in the navigator tree, then choose Properties from the Edit menu. The Issue Notifications process has no result type, indicating that when the process completes, it has no defined

result of, for example, End (Valid) or End (Invalid) corresponding to any lookup type in the navigator tree.

This process activity is runnable, indicating that it can be initiated as a top-level process to run by making calls to the Workflow Engine *CreateProcess* and *StartProcess* APIs.

Node 2 sends the buyer a notification if any of the supplier price updates exceed the price tolerance you have set as described in the section Monitoring Price Increases in a Price/Sales Catalog Update, page 5-21. Node 3 waits for the buyer to respond before updating the price or price breaks. If the buyer at node 3 does not respond after the amount of time you specify in the Control Properties page, the notification at node 2 is sent to the buyer again.

As soon as the buyer responds to all of the pending price updates, node 2 cancels the notification so that it does not show up the next time the buyer queries for notifications.

Node 5 determines if any price updates were rejected. If they were, node 7 can notify the supplier of the document lines whose prices were rejected if you customize the workflow to send automatic supplier notifications. See Optional Customizations, page E-208.

## Issue Notifications Process Activities

The following is a description of each activity listed by the activity's display name. You can create all the components for an activity in the graphical Workflow Builder except for the PL/SQL stored procedures that the function activities call. All function activities execute PL/SQL stored procedures which you must create and store in the Oracle RDBMS. The naming convention for the PL/SQL stored procedures is:

`<PACKAGE>.<PROCEDURE>`

`<PACKAGE>` is the name of the package that groups all of the procedures.

`<PROCEDURE>` represents the name of the procedure.

To view the package and procedure names used by the Issue Notifications process, view the Properties page for each function activity. For example, the function activity Cancel Any Outstanding Buyer Notifications uses the `<PACKAGE>.<PROCEDURE>` name `PO_WF_PO_PRICAT_UPDATE.CANCEL_BUYER_NOTIF`.

You can use the Item Type Definitions Web page to view `<PACKAGE>.<PROCEDURE>` names. See: Item Type Definitions Web Page, *Oracle Workflow Developer's Guide*.

### Notify Buyer of Price Updates that Exceed Tolerance (Node 2)

If any of the price updates in the price/sales catalog update submission exceed the tolerance you have set, this activity sends the buyer a notification. One notification is sent for each document.

### Wait for Buyer Action from Exceeded Price Tolerances Form (Node 3)

This function activity waits for the buyer to respond to the notification. The price

update is not made and the workflow does not continue until the buyer responds. If the buyer does not respond after the amount of time specified in the Control Properties page of this activity, the notification is sent to the buyer again.

#### **Cancel any Outstanding Buyer Notifications (Node 4)**

As soon as the buyer responds to the notification, this activity cancels the notification so that it does not show up the next time the buyer queries for notifications.

#### **Were Any Items Rejected? (Node 5)**

This function activity determines if any price updates were rejected.

#### **Supplier Username Value (Node 6)**

This function activity is a standard Workflow activity used to do comparisons. It makes sure that the supplier's user name is on the list of user names in Oracle Applications. This activity is used only if you create a function activity to populate the Supplier User Name item attribute. This function activity is associated with the Standard item type.

#### **Notify Supplier of Price Updates that were Rejected (Node 7)**

If the function activity *Were Any Items Rejected?* records any price updates that the buyer rejected, this activity sends a notification to the supplier if your supplier is set up in Workflow to receive such notifications. See the *Oracle Workflow Guide*.

## **Debit Memo Notification Workflow**

The workflow Debit Memo Notification notifies you through the Notifications Summary window of debit memos that could not be created. For example, if an invoice was not yet created for the receipt when entered the return, a debit memo for the invoice would not have been able to be created and you would receive a notification of such. See: Debit Memos, page 9-14.

## **Customizing the Debit Memo Notification Workflow**

Use the Oracle Workflow Builder to customize workflows. When you customize a workflow, only those documents that are created *after* you customize it are affected by the customized workflow.

#### **To display the workflow in the Oracle Workflow Builder:**

1. Choose Open from the File menu, and connect to the database.

See: Opening and Saving Item Types, *Oracle Workflow Developer's Guide*.

The Display name of the workflow is *PO Debit Memo Notification*. Its internal name, viewable through the Workflow Builder, is RCVDMEMO. The name of its Workflow definition file is *rcvdfmo.wft*.

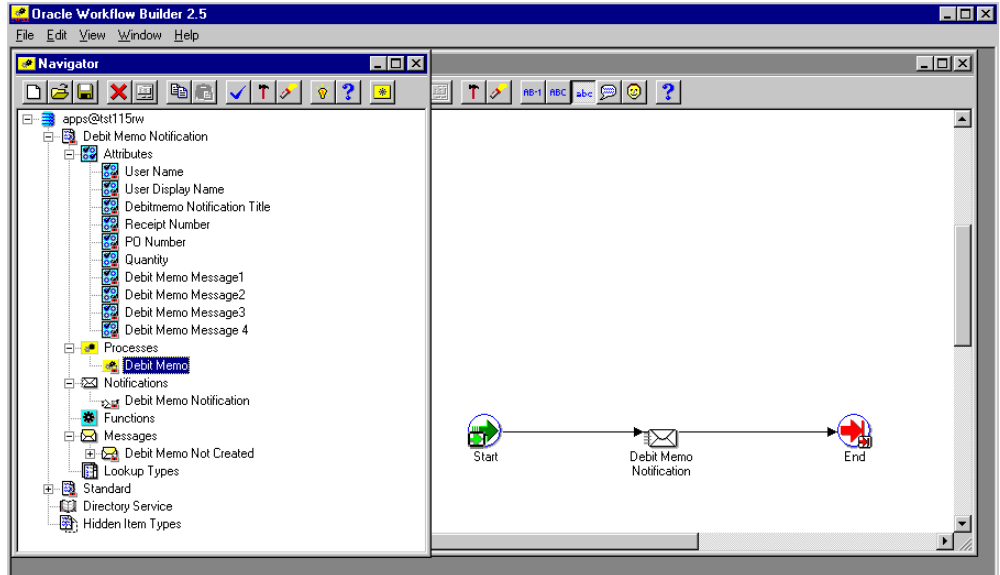

2. Expand the data source, then the PO Debit Memo Notification item type branch within that data source.
3. Expand the Processes branch within the PO Debit Memo Notification branch, then double-click on its process activity to display the process diagram.

### Creating a New Custom Process

If you want to customize the PO Debit Memo Notification workflow, you must customize the default (original) workflow that Purchasing provides. Unlike the PO Approval, PO Requisition Approval, and PO Create Documents workflows in Purchasing, only one PO Debit Memo Notification workflow can be called from the application itself. You can't select a separate customization, like you can with the other workflows in the Document Types window. Therefore, you need to make your customizations to the default workflow. Create a backup to revert to, if you need, while you are testing your customizations.

### Required Modifications

There are no required modifications you need to make to the PO Debit Memo Notification workflow.

### Supported and Unsupported Customizations

Following is a discussion of what you can and *definitely cannot* modify in the PO Debit Memo Notification workflow. For those things you *can* modify, the discussion includes important guidelines that you need to be careful of when making customizations.

For important information on how to customize workflows, see the *Oracle Workflow*

*Developer's Guide.*

To further help you with your customizations, refer to the following sections, **The PO Debit Memo Notification Item Type** and **Summary of the Debit Memo Process**. These sections describe the components of the notification process in the workflow. If you haven't already, see also: Customization Guidelines, page E-2.

**Important:** If a particular Workflow object does not appear in the following sections on the lists of things you can customize, do not modify it, regardless of its access level.

### **Attributes**

You cannot modify any of the attributes in the PO Debit Memo Notification workflow.

### **Processes**

There is one process, "Debit Memo," in the PO Debit Memo Notification workflow, and you can modify it as your business needs require.

### **Notifications**

You cannot modify the notification in the PO Debit Memo Notification workflow. (You could remove it and replace it with your own.)

### **Messages**

You can modify any of the messages in the PO Debit Memo Notification workflow, as your business needs require.

See: Message Result, *Oracle Workflow Developer's Guide* and To Create a Message, *Oracle Workflow Developer's Guide*.

## **The PO Debit Memo Notification Item Type**

The notification sending process is associated with an item type called PO Debit Memo Notification. This item type identifies all notification workflow processes available. There is one workflow process associated with PO Debit Memo Notification: Debit Memo.

The PO Debit Memo Notification item type also has attributes associated with it. These attributes reference information in the Purchasing application tables. The attributes are used and maintained by function activities as well as notification activities throughout the process.

### **PO Debit Memo Notification Item Type Attributes**



Display Name	Description	Type	Length/ Format/ Lookup Type
Debit Memo Message1	First part of the notification text, up until the receipt number is mentioned (the message text is divided into four messages for translation purposes)	Text	100
Debit Memo Message2	The part of the notification text just before the purchase order number is mentioned	Text	100
Debit Memo Message3	Main body of the notification text	Text	1000
Debit Memo Message 4	The part of the notification text that mentions the returned quantity	Text	100
Debitmemo Notification Title	Notification title, "Automatic Debit Memo Creation Failed"	Text	2000
PO Number	Number of the purchase order against which the debit memo is created	Text	20
Quantity	Returned quantity for which the debit memo is created	Text	20
Receipt Number	Number of the receipt against which the debit memo is created	Text	20
User Display Name	Buyer's name as displayed in Purchasing	Text	240
User Name	Buyer's user name as set up in Oracle Applications	Text	100

## Summary of the Debit Memo Process

To view the properties of the Debit Memo process, select the process in the navigator tree, then choose Properties from the Edit menu. The Debit Memo process has a result type of None, indicating that when the process completes, it doesn't end with any particular result, such as End (Approved) or End (Rejected).

This process activity is also runnable, indicating that it can be initiated as a top-level process to run by making calls to the Workflow Engine *CreateProcess* and *StartProcess*

APIs.

The workflow begins at node 1. It sends a notification to the buyer at node 2 if the debit memo could not be created—for example, if an invoice does not yet exist against which to create the debit memo, or if the invoice program that creates the memos failed. This includes notifications for debit memos that were not created because Payment on Receipt already accounted for the return using the Aging Period functionality. The notification instructs the buyer to contact the Accounts Payables department to create a debit memo manually.

## Process Navigator Workflows

The Processes tab in the Oracle Purchasing Navigator, in the Purchasing application, allows access to the process navigator workflows. These Workflow-enabled diagrams guide you through the following procurement processes from beginning to end by automatically launching the appropriate windows:

- Procure-to-Pay, from creating a requisition and purchase order to transferring invoice and payment accounting information to the general ledger.
- Sourcing, from using the Oracle Business Intelligence System to analyze commodities and suppliers to defining sourcing rules in Purchasing.
  - Define Sourcing, a subprocess of Sourcing, which describes how to define sourcing rules.
- Purchase Order Creation, from creating the purchase order to modifying it and communicating it to the supplier.
- Receiving, from receiving an Advance Shipment Notice from the supplier to delivering the goods.

These processes are the default navigator workflow processes that come with Purchasing.

## Accessing the Navigator Processes in Purchasing

The Processes tab in the Purchasing application allows access to the process navigator workflows.

See also: Using the Navigator's Process Region, *Oracle Applications User's Guide*.

### **To use the process navigator workflows in Purchasing:**

1. In the Processes tab of the Purchasing Navigator in the Purchasing application, select any process.
2. Select any activity in the process to display additional information about it.

3. Double-click each activity to launch the appropriate window and guide yourself through the process.

A few activities require other products to be installed. For example, the activity Create and Approve Requisition in the Procure-to-Pay process launches Oracle iProcurement if it is installed.

## Accessing the Workflows in the Workflow Builder

You can also view these processes in the Oracle Workflow Builder. In the Workflow Builder, the procurement navigator processes are associated with an item type called Procurement Processes.

You should not change your access level to modify a locked process; however, you can use the default procurement navigator processes as examples to create your own processes for the Process Navigator. For more information, see: *Creating Process Navigator Processes, Oracle Applications System Administrator's Guide*.

## PO Approval Error Workflow

When a purchasing document is submitted for approval, the Approval Workflow starts the approval process for that document. The Approval Workflow process moves the document from one sub-process to another, making various checks on the document.

The Document Approval Manager is a concurrent manager that executes the code needed to perform these various checks called by the Approval Workflow. This concurrent manager needs to be Active for the Approval Workflow process to complete successfully. The Document Approval Manager is setup and maintained like any other concurrent manager by the System Administrator. The figure below demonstrates the flow of the document during the approval process.

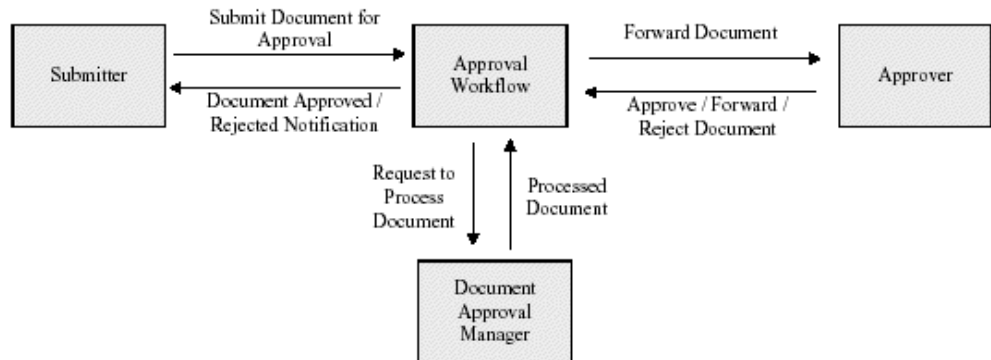

Since the Document Approval Manager is required for the Approval Workflow process to complete successfully, if the Document Approval Manager fails, times out, or is not

active, the Approval Workflow process also errors and halts without resetting the status of the document being processed. This causes the document to remain in 'In Process' status and are inaccessible to the Oracle Purchasing application. The Document Approval Manager returns three error codes. These are explained in the table below.

#### **Document Approval Manager Errors**

<b>Error Number</b>	<b>Description</b>
1	Document Approval Manager timed out.  This error occurs when the Approval Workflow process has been waiting for the Document Approval Manager for more than 180 seconds to finish execution and return a result to the PO/Req Approval Workflow.
2	Document Approval Manager is not Active.
3	Exception in the Document Approval Manager code.  Any other Document Approval Manager failure other than a Timeout (Error 1) or Not Active (Error 2) results in this Document Approval Manager Error 3 code. When this error occurs, the Document Approval Manager provides more details about the exact code error in an error message. Approval workflow then sets the value of attribute SYSADMIN_ERROR_MSG to this message.

Whenever one of the above errors occurs, the document that the Workflow is processing remains in status 'In Process'. PO Approval Error workflow can be configured to resubmit documents automatically that failed due to Document Approval Manager Errors 1 or 2. For Document Approval Manager Error 3 a notification is sent that allows the System Administrator to retry the document approval directly from the notification.

## **Customizing the PO Approval Error Workflow**

Use the Oracle Workflow Builder to customize workflows. For the PO Approval Error workflow this is the set up. When you customize a workflow, only those documents that are created *after* you customize it are affected by the customized workflow.

#### **To display the workflow in the Oracle Workflow Builder:**

1. Choose Open from the File menu, and connect to the database.

See: Opening and Saving Item Types, *Oracle Workflow Developer's Guide*.

The Display name of the workflow is *PO Approval Error*. Its internal name, viewable through the Workflow Builder, is POERROR. The name of its Workflow definition file is *poxwfpoe.wft*.

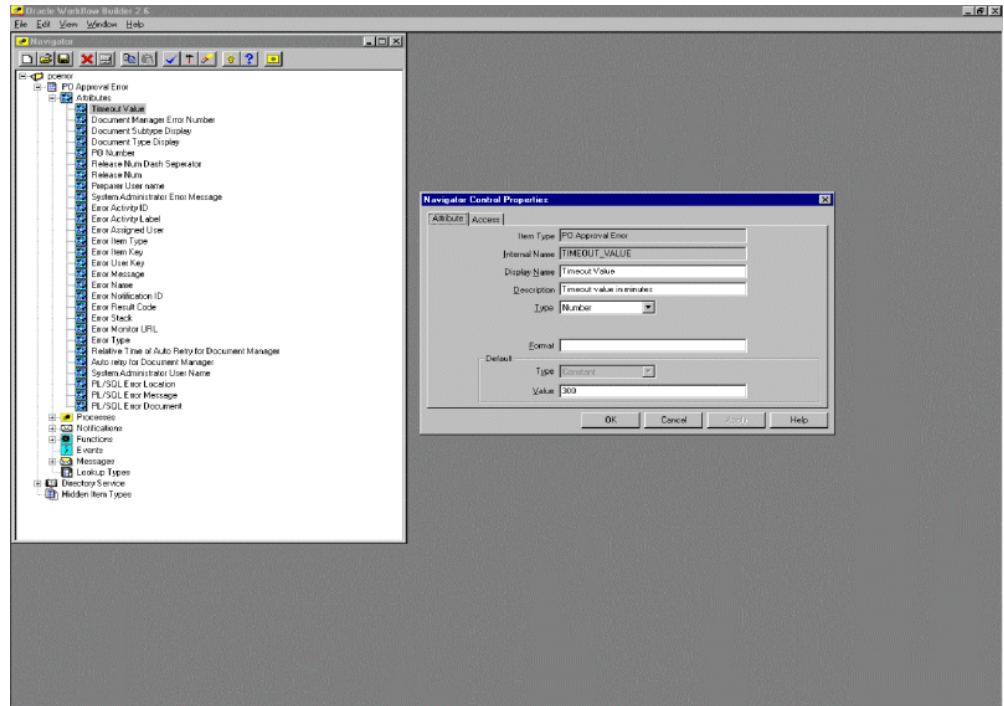

2. Expand the data source, then the PO Approval Error item type branch within that data source.
3. Expand the Processes branch within the PO Approval Error branch, then double-click on its process activity to display the process diagram.

## Creating a New Custom Process

If you want to customize the PO Approval Error workflow, you must customize the default (original) workflow that Purchasing provides. Unlike the PO Approval, PO Requisition Approval, and PO Create Documents workflows in Purchasing, only one PO Approval Error workflow can be called from the application itself. You can't select a separate customization, like you can with the other workflows in the Document Types window. Therefore, you need to make your customizations to the default workflow. Create a backup to revert to, if you need, while you are testing your customizations.

## Required Modifications

There are no required modifications you need to make to the PO Approval Error workflow.

## Supported and Unsupported Customizations

Following is a discussion of what you can and *definitely cannot* modify in the PO Approval Error workflow. For those things you *can* modify, the discussion includes

important guidelines that you need to be careful of when making customizations.

For important information on how to customize workflows, see the *Oracle Workflow Developer's Guide*.

To further help you with your customizations, refer to the following sections, **The PO Approval Error Item Type** and **Summary of the PO Approval Error Process**. These sections describe the components of the notification process in the workflow. If you haven't already, see also: Customization Guidelines, page E-2.

**Important:** If a particular Workflow object does not appear in the following sections on the lists of things you can customize, do not modify it, regardless of its access level.

## Attributes

You can modify the following attributes only, by changing their Default Value:

- Timeout Value
- Relative Time of Auto Entry for Document Manager
- Auto Retry Count for Document Manager
- System Administrator User Name

## Processes

There is one process, "PO Approval Error," in the PO Approval Error workflow, and you can modify it as your business needs require.

## Notifications

You cannot modify the notification in the PO Approval Error workflow. (You could remove it and replace it with your own.)

## Messages

You can modify any of the messages in the PO Approval Error workflow, as your business needs require.

See: Message Result, *Oracle Workflow Developer's Guide* and To Create a Message, *Oracle Workflow Developer's Guide*.

## The PO Approval Error Item Type

### PO Approval Error Item Type Attributes

Display Name	Description	Type	Length/ Format/ Lookup Type
Timeout Value	Length of time, in minutes, for the notification to automatically close itself.  Default value is 0.	Number	
Relative Time of Auto Entry for Document Manager	Length of time, in minutes, processes will have to wait before getting picked again.  Default value is 0.	Number	
Auto Retry Count for Document Manager	Number of attempts to get document manager for approval.  Default value is 0.	Number	
System Administrator User Name	Application user (typically the System Administrator) who will receive notifications for document manager-related errors in status 1 and 2.  This must be defined manually as a valid UserID name in the system.	Text	30

### Summary of PO Approval Error Workflow

Once the document is submitted for approval, the Approval Workflow is launched and the various activities of the workflow are executed. Typically a PO Approval workflow activity makes a call to the Document Approval Manager and the Document Approval Manager returns an error causing this activity to fail. As soon as an activity fails due to Document Approval Manager Error, workflow will spawn another process for the PO Approval Error (POERROR) item type.

This new spawned POERROR process submits the document for approval only if the Document Approval Manager errors. The value of the POERROR workflow item attribute `RETRY_COUNT` determines the number of times this process will try to process the document. If at the end of all the attempts, the document is still in error, a

notification is sent to the user name specified for the POERROR Workflow item attribute SYSADMIN\_USER\_NAME.

The notification sent to SYSADMIN\_USER\_NAME has an option of Retry, to allow the System Administrator to resubmit the document for approval after taking corrective action. If no action is taken on this notification, the notification times out based on the value defined by the attribute TIMEOUT\_VALUE. If the notification is timed out, the document is submitted for approval once again. When the document is submitted for approval in this manner and fails again due to Document Approval Manager Error, the entire process is repeated.

#### **Limitations**

- The document is automatically submitted again for approval only when the Document Approval Manager fails with error number 1 (Timed Out) and error number 2 (Not Active).
- When the Document Approval Manager fails with error number 3 (Unknown Error), a notification is sent to SYSADMIN\_USER\_NAME with a retry option. This document will not be automatically submitted again for approval and the notification sent will not time out. This will allow the System Administrator to communicate to the Users to correct the issue and allows the System Administrator to retry the document approval without having to access the database to use wfretry.sql.
- When a document fails approval process due to a Generic or PL/SQL error, a FYI notification will be sent to SYSADMIN\_USER\_NAME. This document will not be automatically submitted again for approval and does not have a retry option.



---

# 21 CFR Part 11 Compliance: Oracle E-Records

## 21 CFR Part 11 Overview

The Food and Drug Administration (FDA) protects the public health by regulating the food and drug industries. In 1997, the FDA issued new regulations for quality systems using computerized software in the FDA Code of Federal Regulations (CFR) Title 21 Part 11, otherwise known as 21 CFR Part 11. The regulations strive to assure that computerized records are safe, secure, and as accurate as a paper based system.

According to 21 CFR Part 11, the software application's role in the data management process is to guarantee and substantiate that the manufactured product data is electronically captured, manipulated, extracted, and coded during the manufacturing of the product. All subject data and definitional objects (metadata) must have a complete audit trail.

In general, 21 CFR Part 11 describes the requirements that must be met when using electronic records (e-records) and electronic signatures (e-signatures), but does not describe where they are required. The FDA left the definition of where to use electronic records and which signatures to apply as electronic signatures to the discretion of the medical device manufacturers who use software applications as part of their quality management system. The predicate rule used by the medical device manufacturers is FDA 21 CFR Part 820. Oracle Discrete Manufacturing Applications enable electronic records and signatures for certain business events (as described in this chapter), as well as give users ways to choose which business events must meet 21 CFR Part 11 requirements, by using the Oracle E-Records product. Refer to the *Oracle E-Records Implementation Guide* for information on how to tailor Oracle E-Records to meet your needs.

Depending on the type of business event, an electronic signature is either online or deferred. An online signature requires that you enter a valid signature before saving the event or transaction. A deferred signature enables you to save the event in a Pending Approval state before obtaining a final signature. Many times a deferred signature

requires a workflow approval, so the event is saved before full approval is received back from the workflow process.

Certain business events also include any attachment made to the business event object in the e-record. For example, if a drawing depicting an engineering change is attached to an engineering change order, you can review the drawing in the e-record for the engineering change order.

The e-records and e-signatures (ERES) framework is a central tool designed to achieve 21 CFR Part 11 compliance for the necessary Oracle Applications business events. The ERES framework uses common Oracle Applications components such as Oracle Workflow business events, the XML Gateway, and others.

In order to enable electronic records and signatures for Oracle Applications, you must follow the steps listed in *Implementing E-Records, Oracle E-Records Implementation Guide*. Otherwise, no e-records or e-signatures are required.

## E-records and E-signatures for Oracle Purchasing

The following table lists the Oracle Purchasing events seeded in Oracle E-Records.

Event	Online or Deferred E-signature	E-Record Includes Attachment
ASL Creation	Online*	No
ASL Update	Online*	No
Receiving Quality Inspection	Online	Yes
Receiving Transfer with Quality Data Collection	Online*	Yes
Receiving Delivery with Quality Data Collection	Online*	Yes

\* By default, the online e-signatures marked with an asterisk (\*) are disabled. To enable e-signatures for these events, change the ESIG\_REQUIRED configuration variable default value to Y. See: *Setting Up the Configuration Variables, Oracle E-Records Implementation Guide* for information on changing the default value so e-signatures are required.

**Important:** You must implement Oracle Quality and set the profile option QA:PO Inspection to **Oracle Quality** in order to capture e-records and e-signatures in Oracle Purchasing.

## ASL Creation or Update

You capture an e-record when you create or update an Approved Supplier List (ASL) in the Approved Supplier List window, the PO Approval workflow, or through Import Price Catalogs.

## Receiving Quality Inspection

To capture an e-record when you perform a receiving inspection, you must have Oracle Quality installed. You capture an e-record when you enter receiving inspection results in the Enter Quality Results window. After entering the receiving inspection results, the required e-signatures must be captured. You must enter your signature online, while the event is happening in the window. You can view the status of the e-signatures at any time by viewing the eSign Details window.

## Receiving Transfer with Quality Data Collection

You capture an e-record when you enter a receiving transfer transaction in the Receiving Transactions window, then select the Inspections button to enter quality data in the Enter Quality Results window.

## Receiving Delivery with Quality Data Collection

You capture an e-record when you enter a receiving delivery transaction in the Receiving Transactions window, then select the Inspections button to enter quality data in the Enter Quality Results window.

## Viewing Oracle E-Records and E-Signatures

You can view e-records and e-signatures using the following methods:

- Using the Oracle E-Records Evidence Store to query e-records and e-signatures. See: Evidence Store, *Oracle E-Records Implementation Guide*.
- Selecting the eRecord Details option from the Tools menu of a transaction initiating or summary window.



---

## Complex Work in the Procurement Suite

### Complex Work in the Procurement Suite

Much of services spending go to complex services, such as outsourced high-value projects that require extensive collaboration between the buying and supplying organizations. Complex services can include consulting, advertising, construction, research and development, and professional services, and they typically require negotiated contracts with complex terms and payment arrangements. Oracle's Complex Work feature streamlines all aspects of the acquisition process for complex services including:

- Negotiation of service contracts with emphasis on terms related to contract financing and progress payment arrangements
- Tracking of work progress against an agreed schedule in the contract
- Processing of payment requests

By supporting real time online collaboration involving key stakeholders throughout the lifecycle, organizations can significantly improve the acquisition process of this important spend category.

This feature is designed for fixed price contracts with either interim progress payments based on cost or milestones. Complex work procurement spans across Oracle iProcurement, Oracle iSupplier Portal, Oracle Purchasing, Oracle Projects, Oracle Procurement Contracts, Oracle Sourcing, and Oracle Accounts Payable.

### Major Features

#### Incorporate Payment Schedule into a Contract

With Oracle's Complex Work feature, buying organizations can negotiate with their contractors on the progress payment schedule using the Sourcing RFQ and Quote process. When negotiations are complete, the buyer can autcreate the Contract from

the sourcing document and incorporate a detailed progress payment schedule as part of the contract. The schedule consists of "pay items" that specifies the work component, the associated dollar amount and due date for completion. The feature provides for maximum flexibility in defining these pay items based on the way progress needs to be measured. The pay items could be:

- **Milestone:** This pay item is based on a 'Milestone' that needs to be fully complete before the associated payment can be claimed by the contractor. Example: Final Acceptance of Completed Freeway. Amount: \$300,000.00. There are two kinds of Milestone pay items - Recurring Milestones and Non-Recurring Milestones.
  - Recurring Milestones can only be used with Line Types which have a value basis of Quantity. Let's consider the example of procurement of a complex item such as an F16 Aircraft. The Recurring Milestone can represent an event such as 'Complete & Install Landing Gear' that needs to be completed for the product or service ordered. Hence, these recurring Milestones have a quantity associated with them which is the same as the line quantity. In our example each F16 Aircraft will need Landing Gear and so if 10 Aircraft are being purchased, Landing Gears need to be installed for all 10 Aircraft.
  - Non-recurring Milestones can be used with Fixed Price Services and Fixed Price Temp Labor Lines for procurement of a service such as 'Remodeling the Conference Room'. The Milestone represents an event such as 'Tear Down of the Existing Conference Room' that needs to be completed as a part of the service. This type of Milestone does not recur and needs to be completed just once.
- **Rate:** This pay item is based on a 'Rate' of work completion. Payments for these can be claimed as units of work are completed. Example: Installation of 200 lamp posts @ \$1000.00/lamp post
- **Lumpsum:** This pay item is based on a 'Lump Sum' amount allocated to a portion of work against which payments can be released based on the stage of completion. Unlike 'Milestone' pay items, contractors can report partial progress against 'Lump Sum' pay items and request payments. Example: Excavation of Site. Amount: \$200,000.00.

The types of pay items that can be used on the Contract depend on the PO Line the pay items are associated with. The following Lines Types are supported with this feature:

- Goods: With this Line Type, only Milestone Pay Items can be used.
- Fixed Price Services: With this Line Type, all three pay items can be used – Rate, Lumpsum and Milestone
- Fixed Price Temp Labor: Again, all three pay items can be used – Rate, Lumpsum and Milestone.

**Note:** Rate Based Temp Labor, Amount-based Services and Outside Processing Line Types are not supported with this feature.

Progress Payments can be treated as either Delivery payments i.e. payment for actual work done or progress made on the Contract, or they can be treated as a form of Contract Financing as is typical in certain industries. The type of progress payments is decided on the Document Style by the status of the flag 'Treat Progress Payments as Financing'. When progress payments are considered a form of contract financing, these payments are automatically recouped from payments due at delivery based on the recoupment rates specified in the contract. For more details about the recoupment functionality please refer to the *Oracle Payables User Guide*.

## Advances and Recoupment

In order to provide working capital to smaller contractors, buying organizations may often pay advances to these contractors right after contract signing, before any work or product delivery has been performed.

With this release, buying organizations can negotiate and finalize the terms of such advances, and ensure compliance to those terms. In order to define an Advance on the Contract the Document Style for the Contract should allow the use of Advances. Advances are defined on the PO Line as an amount and can be claimed by the Contractor using Prepayment Invoices before any work has been done on the Contract. The Contractor can create and submit these Prepayment Invoices through the Oracle iSupplier Portal. Requests for advances submitted by the Contractor are verified against the advance limits set forth in the contract. These advance payments are automatically recouped from progress invoices, based on the recoupment rates specified in the contract.

Recoupment is the process of recovering previous financing payments from a current delivery payment billed on a Standard Invoice. All Financing Payments made to the Contractor need to be liquidated or "recouped".

The Recoupment Rate attribute appears on the PO Line if the Document Style either enables the use of Advances or the 'Treat Progress Payments as Financing' flag is enabled. The buyer can then define a Recoupment Rate on the PO Line which will be applied to Standard Invoices billed to the Line or Pay Items of the Contract for deliveries made by the Contractor.

The Progress Payment Rate is used primarily on Cost Reimbursement Contracts and represents the rate at which costs incurred by the Contractor can be reimbursed by the buying organization. This term is captured on the Contract for offline use by the Contractor in determining the billable amount for work done on the Contract. It is not used for any computation on the Contract or any of its transaction documents like Work Confirmations or Invoices. The Progress Payment Rate attribute appears on the PO Line if the Document Styles has the flag 'Treat Progress Payments as Financing' enabled.

## Track Progress Based on a Schedule

Oracle's Complex Work feature provides a streamlined process for Contractors to report progress and request payments using either a Work Confirmation Request or an Invoice, each of which can then be electronically routed for approval.

Organizations can leverage the flexibility of Oracle Approvals Management to configure their business approval processes for Work Confirmation Requests and Invoices. Please refer to the Oracle Approvals Management Engine User Guide for more details about this feature.

The feature allows online negotiation on the amount of work eligible for payment through multiple rounds of resubmissions of the work confirmation request till both parties are in agreement and the request is approved. The contractor can report progress and request progress payments in the multiple ways.

### Contractor Submits a Work Confirmation

The Contractor can create and submit a Work Confirmation Request in Oracle iSupplier Portal. The Contractor will need to specify a Work Confirmation Number, Period of Performance and the Requested Quantity or Amount. Other details like Drawings or Certificates can be provided as Attachments for each Work Confirmation Line. Please refer to the *Oracle iSupplier Portal Users Guide* for more information on this feature.

### Project Manager Submits a Work Confirmation Request in iProcurement

The Project Manager can create a Work Confirmation request on behalf of the Contractor in iProcurement using the 'Create Work Confirmation' action available on the Purchase Order view page.

### Buyer/Contract Administrator Creates a Work Confirmation on behalf of the Supplier

The Buyer can create and submit a Work Confirmation on behalf of the Supplier. This can be done using either the 'Create Work Confirmation' action on the Contract Update page as shown below or using the iSupplier Portal Internal View. Please refer to the *Oracle iSupplier Portal Users Guide* for more information on creating a Work Confirmation.

## Release Progress Payments

The Contractor can request payment for the work that has been completed on the Progress Payment Schedule. These payments are billed using a Standard Invoice and can be used to recoup Contract Financing based on the Recoupment Rate specified on the Contract. Also Retainage can be applied to these Progress Payments.

### Contract Financing

In certain industries, Progress Payments are treated as a form of Contract Financing. This can be configured on the Document Style using the flag 'Treat Progress Payments as Financing'.



As work progresses, Contract Financing can be released by the buying organization. These Progress Payments are billed using a Prepayment Invoice and are tracked on the Contract as an Amount Financed on the respective Pay Item and its Distribution. No retainage can be applied to these progress payments.

At the completion of the Contract, a final Standard Invoice can be submitted by the Contractor for the delivery of goods and services specified on the contract. The buying organization can process this final Invoice for payment and recoup all previously released Contract Financing.

Progress payments can be released using methods such as Self-Billing and Contractor Submits an Invoice.

#### **Self-Billing (Evaluated Receipt Settlement)**

The buying organization can use Evaluated Receipt Settlement to create Invoices from processed Work Confirmations. If the Contract and the Supplier Site are setup with the Pay on Receipt flag set to 'Receipt', then the Pay on Receipt AutoInvoice Program can generate Invoices for both Contract Financing as well as Delivery Payments automatically.

#### **Contractor Submits an Invoice (2-way match)**

The Contractor can report progress and request payment using an Invoice if the Pay Items of the Contract have been setup as a 2-way match. Please note that the payment request is processed as a Standard Invoice for Progress Payments, and as a Prepayment Invoice if these Progress Payments are a form of Contract Financing. Please refer to the *Oracle Payables User Guide* for more information on the Invoicing features.

#### **Contractor Submits an Invoice (3-way match)**

If the Pay Items of the Contract have been setup as a 3-way match, the Contractor can submit an Invoice to request for Payments after the Work Confirmation has been approved and processed. Please note that the payment request is processed as a Standard Invoice for Progress Payments, and as a Prepayment Invoice if these Progress Payments are a form of Contract Financing. Please refer to the *Oracle Payables User Guide* for more information on the Invoicing features.

### **Retainage and Retainage Release**

Retainage represents funds withheld from payment to ensure that the contractor finishes work as agreed. The buying organization releases these funds only after verifying that the contractor has fulfilled all contractual obligations. Retainage is also called "retention" or "contractual withholds".

With Oracle's Complex Work feature, contract administrator can negotiate retainage terms with the contractor and capture these as part of the contract. These terms include Retainage Rate and Maximum Retainage Amount.

#### **Retainage Rate**

The Retainage Rate determines the percentage of the amount requested that will be withheld before releasing payments to the contractor. This attribute appears on the PO

Line if the Document Styles enables the use of Retainage. The Retainage Rate specified on the PO Line is applied to all Standard Invoices billed to the Pay Items of the respective Line. Based on the Retainage Rate, a certain percentage of the Standard Invoice Amount is with-held as a Retained Amount.

#### **Maximum Retainage Amount**

The Maximum Retainage Amount defines maximum amount of Retainage that can be withheld on a Contract Line. The Maximum Retainage Amount attribute appears on the PO Line if the Document Style enables the use of Retainage. Every time Retainage is withheld on an Invoice, the application checks that the total retained amount does not exceed this value.

#### **Retainage Release**

At the end of the project the contractor can submit a Retainage Release Invoice for release of retainage withheld on the Contract. If the contractual clauses or other conditions governing the release of the retainage are met, the buyer can release the retainage amount applicable. Retainage Release Invoices can also be used for recoupment of financing payments.

- The application will not allow you to release more than the retained amount
- You cannot Finally Close a contract that has an outstanding retainage balance

Please refer to the *Oracle Payables User Guide* for more information on the Invoicing features.

## **Complex Work Procurement Business Flow**

Since complex work procurement requires integration between several Oracle Applications it is beneficial to know the role that Oracle Purchasing takes in the process. The following diagram illustrates how the various roles and products intersect.

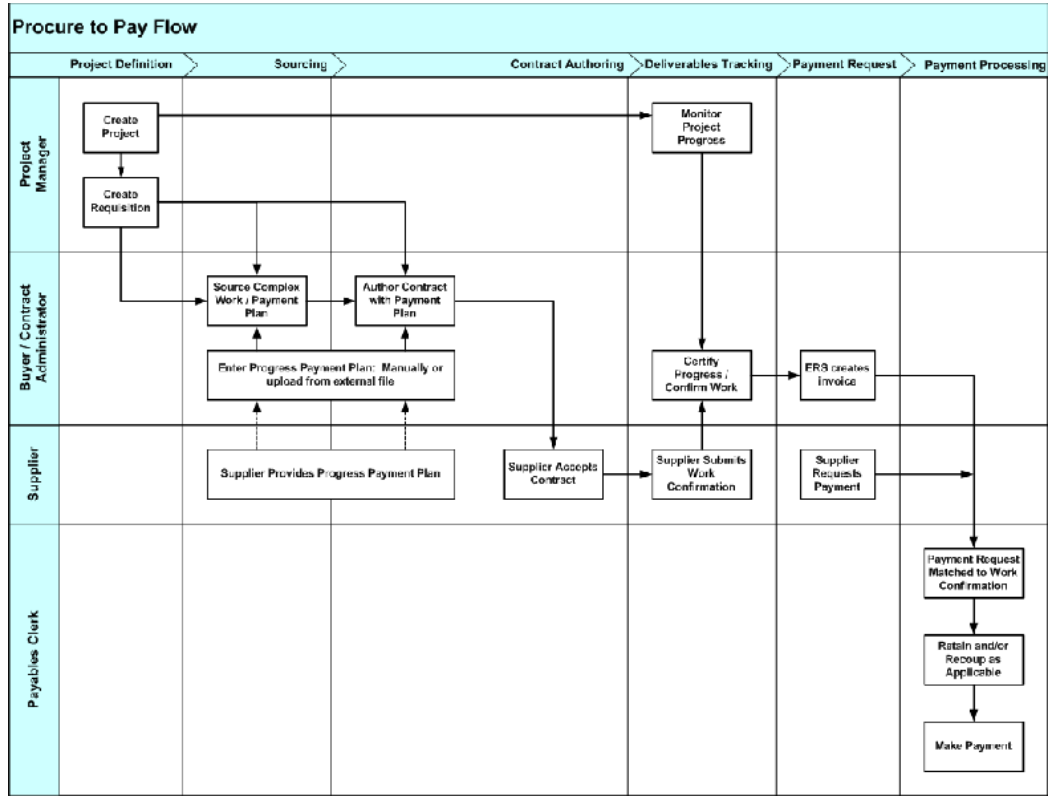

## Oracle Purchasing

The role that Oracle Purchasing plays is primarily in the authoring and monitoring a portion of the flow.

Refer to these topics for details:

- *Authoring Purchase Orders, Oracle Purchasing Users Guide*
- *Finding Purchase Orders, Oracle Purchasing Users Guide*

In addition, the purchase order styles that dictate which of the complex work procurement attributes are available are created in Oracle Purchasing. See: *Defining Document Styles, Oracle Purchasing Users Guide*

### Some Purchasing Usage Considerations:

- **Available Line Types:** Goods (Purchase Basis of Goods, Value Basis of Quantity)– Only Milestone Pay Items supported, Fixed Price Services–Rate, Lumpsum and Milestone Pay Items supported, Fixed Price Temp Labor–Rate, Lumpsum and Milestone Pay Items supported, Rate Based Temp Labor is not supported, Amount-Based Services is not supported.
- **Destination Types:** Only Expense Destination Types are allowed (not Inventory,

Shop Floor), Inventorized Items are supported with Expense Destination Types only.

- **Advances:** Available only with Progress Payments, Paid with 'Prepayment' Invoices only, Can be recouped on 'Standard' Invoices only if 'Prepayment' Invoice is paid (not billed!).
- **Retainage:** Available only with Progress Payments, Retainage withheld on Standard Invoices only, Released using a 'Retainage Release' Invoice only.
- **Non-Financed PO's:** Pay Items need to sum up to the Line, Recoupment Rate should be high enough to liquidate the Advance (if any).
- **Financed PO's:** Line has its own Delivery Schedule, Pay Items are financed, can be billed only using 'Prepayment' Invoices, Pay Items + Advances need to be less than the Line Amount, Recoupment Rate should be high enough to liquidate Advances + Pay Items amount, Accrue at Receipt not supported for Financed Pay Items.

## Related Topics

Defining Document Styles, Oracle Purchasing, *Oracle Purchasing Users Guide*

Orders in the Buyer's Work Center, *Oracle Purchasing User Guide*

Negotiating Complex Work Projects, Oracle Sourcing, *Oracle Sourcing Online Help*

Creating Work Confirmation, Oracle iSupplier Portal, *Oracle iSupplier Portal User Guide*

---

# Glossary

## **accept**

An action to indicate that you accept the previous approver's authorization.

## **acceptance**

Supplier acknowledgement of a purchase order that indicates that the supplier agreed to and accepted the terms of the purchase order.

## **account**

See: **accounting flexfield**

## **account alias**

An easily recognized name or label representing an account charged on miscellaneous transactions. You may view, report, and reserve against an account alias.

## **Account Generator**

A feature that uses Oracle Workflow to provide various Oracle Applications with the ability to construct Accounting Flexfield combinations automatically using custom construction criteria. You define a group of steps that determine how to fill in your Accounting Flexfield segments. You can define additional processes and/or modify the default process(es), depending on the application.

See also: **activity (Workflow), function, item type, lookup type, node, process, protection level, result type, transition, Workflow Engine**

## **accounting flexfield**

A feature used to define your account coding for accounting distributions. For example, this structure can correspond to your company, budget account, and project account numbers. For simplicity, Inventory and Oracle Manufacturing use the term account to refer to the accounting flexfield.

## **accounting flexfield limit**

The maximum amount you authorize an employee to approve for a particular range of accounting flexfields.

**accounting period**

The fiscal period a company uses to report financial results, such as a calendar month or fiscal period.

**accounts payable accrual account**

The account used to accrue payable liabilities when you receive your items. Always used for inventory and outside processing purchases. You can also accrue expenses at the time of receipt. Used by Purchasing and Inventory, the accounts payable account represents your non-invoiced receipts, and is included in your month end accounts payable liability balance. This account balance is cleared when the invoice is matched in Payables.

**accrual accounting**

Recognition of revenue when you sell goods and recognition of expenses when a supplier provides services or goods. Accrual based accounting matches expenses with associated revenues when you receive the benefit of the good and services rather than when cash is paid or received.

**acquisition cost**

The cost necessary to obtain inventory and prepare it for its intended use. It includes material costs and various costs associated with procurement and shipping of items, such as duty, freight, drayage, customs charges, storage charges, other supplier's charges, and so on.

**activity (Workflow)**

An Oracle Workflow unit of work performed during a business process.

See also: **activity attribute**, **function activity**

**activity attribute**

A parameter for an Oracle Workflow function activity that controls how the function activity operates. You define an activity attribute by displaying the activity's Attributes properties page in the Activities window of Oracle Workflow Builder. You assign a value to an activity attribute by displaying the activity node's Attribute Values properties page in the Process window.

**alert**

A specific condition defined in Oracle Alert that checks your database and performs actions based on the information it finds there.

**alert action**

In Oracle Quality, an electronic mail message, operating system script, SQL script, or concurrent program request that is invoked when specified action rule conditions are met.

**alphanumeric number type**

An option for numbering documents, employees, and suppliers where assigned numbers can contain letters as well as numbers.

**amount based order**

An order you place, receive, and pay based solely on the amount of service you purchase.

**approve**

An action you take to indicate that you consider the contents of the purchasing document to be correct. If the document passes the submission tests and you have sufficient authority, Purchasing approves the document.

**approved**

A purchase order or requisition status that indicates a user with appropriate authorization approved the purchase or requisition. Purchasing verifies that the purchase order or requisition is complete during the approval process.

**archiving**

The process of recording all historical versions of approved purchase orders. Purchasing automatically archives a purchase order when you approve it for the first time. Purchasing subsequently archives your purchase orders during the approval process if you have increased the revision number since the last time you approved the purchase order.

**ASC X12**

Accredited Standards Committee X12 group. This group is accredited by ANSI and maintains and develops the EDI standards for the United States and Canada.

**ASCII**

American Standard Code for Information Interchange. A standard file format used for transmission and storage. ASCII is a seven-bit code with an eighth bit used for parity.

**ASL**

Approved Suppliers List. A list where you can set up your Approved Suppliers, Sites, and Items.

**ASN**

(Advanced Shipping Notice)

**asset item**

Anything you make, purchase, or sell including components, subassemblies, finished

products, or supplies which carries a cost and is valued in your asset subinventories.

**asset subinventory**

Subdivision of an organization, representing either a physical area or a logical grouping of items, such as a storeroom where quantity balances are maintained for all items and values are maintained for asset items.

**assigned units**

The number of resource units assigned to work at an operation in a routing. For example, if you have 10 units of machine resource available at a department, you can assign up to 10 of these units to an operation in a routing. The more units you assign, the less elapsed time Work in Process schedules for the operation.

**assignment set**

A group of sourcing rules and/or bills of distribution and a description of the items and/or organizations whose replenishment they control.

**attribute**

See: **activity attribute**, **item type attribute**

**authorization check**

A set of tests on a purchasing document to determine if the document approver has sufficient authority to perform the approval action.

**automatic numbering**

A numbering option Purchasing uses to assign numbers to your documents, employees, or suppliers automatically.

**automatic sourcing**

A Purchasing feature which allows you to specify for predefined items a list of approved suppliers and to associate source documents for these suppliers. When you create a requisition or purchase order line for the item, Purchasing automatically provides appropriate pricing for the specified quantity based on the top-ranked open source document for the supplier with the highest percentage allocation.

**balancing entity**

An organization for which you prepare a balance sheet, represented as a balancing segment value in your accounting flexfield. This is the equivalent of a fund in government organizations. Examples include companies, strategic business units, and divisions.

**balancing segment**

An Accounting Flexfield segment you define so that Oracle General Ledger



automatically balances all journal entries for each value of this segment. For example, if your company segment is a balancing segment, General Ledger ensures that within every journal entry, the total debits to company 01 equal the total credits to company 01.

**base unit**

The unit of measure to which you convert all units of measure within one class. The base unit is the smallest or most commonly used unit of measure in the class. For example, millimeter is the base unit in the Length class. You define your base unit of measure when you create your unit class.

**bill-to address**

The customer's billing address. It is also known as invoice-to address.

**blanket purchase agreement**

A type of purchase order you issue before you request actual delivery of goods or services. You normally create a blanket purchase agreement to document a long-term supplier agreement. A blanket purchase agreement may contain an effective date and an expiration date, a committed amount, or quantity. You use a blanket purchase agreement as a tool for specifying agreed prices and delivery dates for goods and services before ordering them.

**blanket purchase order**

See: **blanket purchase agreement**

**blanket release**

An actual order of goods and services against a blanket purchase agreement. The blanket purchase agreement determines the characteristics and prices of the items. The blanket release specifies actual quantities and dates ordered for the items. You identify a blanket release by the combination of the blanket purchase agreement number and the release number.

**blind receiving**

A site option that requires your receiving staff to count all items on a receipt line. Blind receiving prevents display of expected receipt quantities in receiving windows.

**budget organization**

An entity, such as a department, division, or activity responsible for entering and maintaining budget data. You define budget organizations for your agency, then assign appropriate accounting flexfields to each budget organization.

**bucket patterns**

Bucket patterns can be defined to include daily, weekly, monthly, or quarterly buckets. Bucket patterns are used to bucket quantity requirements on Planning or Shipping

Schedules.

**budgetary account**

An account segment value (such as 6110) that is assigned one of the two budgetary account types. You use budgetary accounts to record the movement of funds through the budget process from appropriation to expended appropriation.

**business document**

A document used for conducting business between two trading partners - a purchase order or invoice, for example.

**business group**

An organization which represents the consolidated enterprise, a major division, or an operation company. This entity partitions Human Resources information.

**buyer**

Person responsible for placing item resupply orders with suppliers and negotiating supplier contracts.

**cancel**

You can cancel a purchase order after approving it. When you cancel a purchase order, you prevent anyone from adding new lines to the purchase order or receiving additional goods. Purchasing still allows billing for goods you received before cancelling the purchase order. Purchasing releases any unfilled requisition lines for reassignment to another purchase order.

**candidate**

A record Purchasing selects to purge based on the last activity date you specify. Purchasing selects only records that you have not updated since the last activity date. Purchasing does not purge a candidate until you confirm it.

**carrier**

See: **freight carrier**

**category**

Code used to group items with similar characteristics, such as plastics, metals, or glass items.

**category set**

A feature in Inventory where users may define their own group of categories. Typical category sets include purchasing, materials, costing, and planning.

**check funds**

To certify whether you have funds available to complete your requisition or purchase order. The difference between the amount you are authorized to spend and the amount of your expenditures plus encumbrances equals your funds available. You can certify funds available at any time when you enter a requisition or a purchase order. You can track funds availability at different authority levels on-line.

**close**

A purchase order is automatically closed once it is received (if you require a receipt) and is billed for all purchase order shipments. Since you do not require or expect any further activity, Purchasing closes the purchase order. You can also manually close the purchase order early if you do not expect further activity. Adding lines to it or receiving against it, reopens the purchase order. Purchasing does not consider closed purchase orders for accruals.

**close for invoicing**

A purchase order control that you can assign manually or that Purchasing can assign automatically when the amount invoiced reaches a defined percentage of the order quantity.

**close for receiving**

A purchase order control you can assign manually or that Purchasing can assign automatically when the amount received reaches a defined percentage of the order quantity.

**column headings**

Descriptions of the contents of each column in the report.

**combination of segment values**

A combination of segment values uniquely describes the information stored in a field made up of segments. A different combination of segment values results when you change the value of one or more segments. When you alter the combination of segment values, you alter the description of the information stored in the field.

**commitment**

A contractual guarantee with a customer for future purchases, usually with deposits or prepayments. You can then create invoices against the commitment to absorb the deposit or prepayment. Receivables automatically records all necessary accounting entries for your commitments. Oracle Order Entry allows you to enter order lines against commitments.

A journal entry you make to record an anticipated expenditure as indicated by approval of a requisition. Also known as **pre-commitment**, **pre-encumbrance** or **pre-lien**.

**committed amount**

The amount you agree to spend with a supplier.

**concurrent manager**

Components of your applications concurrent processing facility that monitor and run time-consuming tasks for you without tying up your terminal. Whenever you submit a request, such as running a report, a concurrent manager does the work for you, letting you perform many tasks simultaneously.

**concurrent process**

A task in the process of completing. Each time you submit a task, you create a new concurrent process. A concurrent process runs simultaneously with other concurrent processes (and other activities on your computer) to help you complete multiple tasks at once with no interruptions to your terminal.

**concurrent queue**

A list of concurrent requests awaiting completion by a concurrent manager. Each concurrent manager has a queue of requests waiting in line. If your system administrator sets up simultaneous queuing, your request can wait to run in more than one queue.

**concurrent request**

A request to complete a task for you. You issue a request whenever you submit a task, such as running a report. Once you submit a task, the concurrent manager automatically takes over for you, completing your request without further involvement from you, or interruption to your work. Concurrent managers process your request according to when you submit the request and the priority you assign to your request. If you do not assign a priority to your request, your application prioritizes the request for you.

**configuration**

A product a customer orders by choosing a base model and a list of options. It can be shipped as individual pieces as a set (kit) or as an assembly (configuration item).

**consigned location**

The physical location of inventories which resides on the property of buyers and sellers through a consigned agreement with the manufacturer.

**context element**

A collection element associated with a quality collection transaction. Values for context elements are automatically transferred to Oracle Quality as their parent collection transaction are entered.

**context field prompt**

A question or prompt to which a user enters a response, called a context field value. When Oracle Applications displays a descriptive flexfield pop-up window, it displays your context field prompt after it displays any global segments you have defined. Each descriptive flexfield can have up to one context prompt.

**context field value**

A response to your context field prompt. Your response is composed of a series of characters and a description. The response and description together provide a unique value for your context prompt, such as 1500, Journal Batch ID, or 2000, Budget Formula Batch ID. The context field value determines which additional descriptive flexfield segments appear.

**context segment value**

A response to your context-sensitive segment. The response is composed of a series of characters and a description. The response and description together provide a unique value for your context-sensitive segment, such as Redwood Shores, Oracle Headquarters, or Minneapolis, Merrill Aviation's Hub.

**context-sensitive segment**

A descriptive flexfield segment that appears in a second pop-up window when you enter a response to your context field prompt. For each context response, you can define multiple context segments, and you control the sequence of the context segments in the second pop-up window. Each context-sensitive segment typically prompts you for one item of information related to your context response.

**contract**

An agreement between you and a supplier for unspecified goods or services. This agreement may include terms and conditions, committed amount, and an effective and expiration date. You reference contract purchase agreements directly on standard purchase order lines. Purchasing monitors the amount you have spent against contract purchase agreements.

**conversion**

Converts foreign currency transactions to your functional currency.

See also: **foreign currency conversion**

**conversion formula**

The number that, when multiplied by the quantity of one unit of the source base unit, gives you the quantity of one unit of the destination base units in the interclass conversion. The number is also the conversion between units for standard unit conversion or item-specific conversion.

**copy**

An AutoCreate option that lets a buyer designate a specific requisition line as the source of information that Purchasing copies to the purchase order or RFQ line.

**corporate exchange rate**

An exchange rate you can optionally use to perform foreign currency conversion. The corporate exchange rate is usually a standard market rate determined by senior financial management for use throughout the organization.

**cost element**

A classification for the cost of an item. Oracle Manufacturing supports five cost elements: material, material overhead, resource, outside processing, and overhead.

**cost variance**

The difference between the actual and expected cost. Oracle Manufacturing and Payables supports the following cost variances: invoice price, resource rate, and standard cost variances.

**credit memo**

A document that partially or fully reverses an original invoice.

**current on-hand quantity**

Total quantity of the item on-hand before a transaction is processed.

**default value**

Information Oracle Applications automatically enters depending on other information you enter. Also referred to as defaults or a defaulted value.

**deliver-to location**

A location where you deliver goods previously received from a supplier to individual requestors.

**delivery**

Internal delivery of items to requestors within your organization.

**demand**

Projected inventory issue transactions against an item. For Order Management, it is an action you take to communicate current or future product needs to manufacturing.

**depot repair**

A process used to track items returned by a customer for repair or replacement.

**descriptive flexfield**

An Oracle Applications feature used to collect information unique to your business. You determine the additional information you need and descriptive flexfield lets you customize your application to your needs without additional programming.

**destination base unit**

The unit of measure to which you are converting when you define interclass conversions. Your destination base unit is the base unit of a unit class.

**destination organization**

An inventory organization that receives item shipments from a given organization.

**detailed message action**

A message representing one exception. Oracle Alert inserts the exception values into the text of the message.

**direct receipt**

The receipt of an item directly to its final destination (either directly to the person who requested the item or directly to the final inventory location). It differs from a standard receipt in that it is received into a receiving location and delivered in one transaction, rather than received and delivered in two separate transactions.

**discrete manufacturing**

A manufacturing environment where you build assemblies in discrete jobs or batches. Different from a repetitive production environment where you build assemblies on production or assembly lines at a daily rate.

**distribution account**

An account where you record material, material overhead, resource, outside processing, and overhead charges incurred by a discrete job or repetitive assembly. In a standard costing system, this is where you record your standard costs.

**distribution list**

A predefined list of electronic mail IDs that you can use rather than entering individual mail IDs (To, Cc, and Bcc) when defining mail message alert actions in Oracle Quality.

**document reference**

A message that precisely identifies the document or part of document you want to describe using standard or one-time notes.

**drop shipment**

A method of fulfilling sales orders by selling products without handling, stocking, or

delivering them. The selling company buys a product from a supplier and has the supplier ship the product directly to customers.

**due date**

The date when scheduled receipts are currently expected to be received into inventory and become available for use.

**duplicate**

An exception Oracle Alert located for the same action set during a previous alert check. Oracle Alert does not consider a detail action to contain a duplicate exception until Oracle Alert sends the final action level to a specific action set, and then locates the same exception for the same action set again. For example, if on Monday Oracle Alert notifies a buyer that a supplier shipment is overdue, then on Tuesday Oracle Alert finds the shipment is still overdue, you can choose whether Oracle Alert should re-notify the buyer or suppress the message.

**dynamic distribution**

You can use output variables to represent electronic mail IDs. When you define mail message alert actions in Oracle Quality, the message is sent to all defined mail IDs.

**dynamic insertion**

Automatically creates new accounting flexfield combinations as you enter them. If you do not use dynamic insertion, you create new accounting flexfield combinations with a separate window.

**EDI**

See: **Electronic Data Interchange (EDI)**

**EDIFACT**

Electronic Data Interchange for Administration, Commerce, and Trade is the current acronym for standards developed within Working Party 4. *See also* **WP4**

**electronic commerce**

Conducting business via an electronic medium. This includes methods of exchanging business information electronically, such as Electronic Data Interchange (EDI), FAX, email, and eforms.

**Electronic Data Interchange (EDI)**

Exchanging business documents electronically between trading partners. EDI subscribes to standard formats for conducting these electronic transactions as stated by various standards.



**electronic funds transfer**

A method of payment in which your bank transfers funds electronically from your bank account into another bank account. In Oracle Payables, funds are transferred from your account into that of a supplier. This information is sent to the bank in a file.

**employee supervisor hierarchy**

An approval routing structure based on employee/supervisor relationships. *See position hierarchy*

**encumbrance**

See: **purchase order encumbrance**.

**encumbrance type**

An encumbrance category that allows you to track your expenditures according to your purchase approval process and better control your planned expenditures. You can set up separate encumbrance types for each stage in your purchasing cycle to track your spending at each level. Examples of encumbrance types are commitments (requisition encumbrances) and obligations (purchase order encumbrances).

**event alert**

An alert that runs when a specific event occurs that you define. For example, you can define an event alert to immediately send a message to the buyer if an item is rejected on inspection.

**exception**

An occurrence of the specified condition found during an alert check. For example, an alert testing for invoices on hold may find five invoices on hold, or none. Each invoice on hold is an exception.

**exception message**

A message received indicating a situation that meets your predefined exception set for an item, such as *Items that are overcommitted*, *Items with excess inventory*, and *Orders to be rescheduled out*.

**exception reporting**

An integrated system of alerts and action sets that focuses attention on time-sensitive or critical information, shortens your reaction time, and provides faster exception distribution. Exception reporting communicates information by either electronic mail messages or paper reports.

**expected receipts report**

A printed report of all expected receipts for a time period and location you specify.

**expense item**

Anything you make, purchase, or sell including components, subassemblies, finished products, or supplies and that does not carry a cost. Also known as a non-asset item.

**expense subinventory**

Subdivision of an organization, representing either a physical area or a logical grouping of items, such as a storeroom where no value exists but the quantities may be tracked.

**exchange rate**

A rate that represents the amount of one currency you can exchange for another at some point in time. Oracle Applications use the daily, periodic, and historical exchange rates you maintain to perform foreign currency conversion, re-evaluation, and translation.

You can enter and maintain daily exchange rates for Oracle Purchasing to use to perform foreign currency conversion. Oracle Purchasing multiplies the exchange rate times the foreign currency to calculate **functional currency**.

**exchange rate type**

A specification of the source of an exchange rate. For example, a user exchange rate or a corporate exchange rate.

See also: **corporate exchange rate, spot exchange rate**

**explode**

An AutoCreate option that lets a buyer split a single requisition line for an item into one or more requisition lines for different items. Use this option to expand a requisition line for an item that your company purchases in component parts.

**express delivery**

An option that lets you deliver the entire quantity of a receipt without entering quantities for each shipment or distribution.

**express receipt**

A site option that lets you receive an entire purchase order or blanket purchase agreement release with one keystroke.

**express requisitions**

To create requisitions quickly from predefined requisition templates. You only need to provide an accounting flexfield and quantities to create a requisition for commonly purchased items.

**FIFO (first-in-first-out) costing method**

A cost flow method used for inventory valuation. Inventory balances and values are

updated perpetually after each transaction is sequentially costed. It assumes that the earliest inventory units received or produced are the first units used or shipped. The ending inventory therefore consists of the most recently acquired goods. FIFO cost flow does not have to match the physical flow of inventory.

**final close**

A purchase order control you can assign to prevent modifications to or actions against completed documents, lines, and shipments by final closing them. Final-closed documents are not accessible in the corresponding entry windows, and you cannot perform the following actions against final-closed entities: receive, transfer, inspect, deliver, correct receipt quantities, invoice, return to supplier, or return to receiving.

**firm**

A purchase order control. When you firm an order, Master Scheduling/MRP uses the firm date to create a time fence within which it does not suggest new planned purchase orders, cancellations, or reschedule-in actions. It continues to suggest reschedule-out actions for orders within the time fence. If several shipments with different promised or need-by dates reference the same item, Master Scheduling/MRP sets the time fence at the latest of all scheduled dates.

**flexfield**

A field made up of segments. Each segment has a name you assign and a set of valid values.

See also: **descriptive flexfield, key flexfield**

**flexfield segment**

One of the parts of your key flexfield, separated from the other parts by a symbol you choose (such as -, /, or \). Each segment typically represents a cost center, company, item family, or color code.

**FOB**

See: **freight on board.**

**foreign currency**

A currency you define for your ledger for recording and conducting accounting transactions in a currency other than your functional currency. When you enter and pay an invoice in a foreign currency, Oracle Payables automatically converts the foreign currency into your functional currency based on the exchange rate you define.

See also: **exchange rate, functional currency**

**forward**

An action you take to send a document to another employee without attempting to approve it yourself.

**four-way matching**

Purchasing performs four-way matching to verify that purchase order, receipt, inspection and invoice quantities match within tolerance.

**freight on board**

**(FOB)** The point or location where the ownership title of goods is transferred from the seller to the buyer.

**freeze**

You can freeze a purchase order after printing. By freezing a purchase order, you prevent anyone from adding new lines or changing the purchase order. You can continue to receive goods and be billed on already existing purchase order lines. The ability to continue receiving against the purchase order is the difference between freezing and cancelling.

**freight carrier**

A commercial company used to send item shipments from one address to another.

**function**

A PL/SQL stored procedure referenced by an Oracle Workflow function activity that can enforce business rules, perform automated tasks within an application, or retrieve application information. The stored procedure accepts standard arguments and returns a completion result. *See also*

**function activity**

An automated Oracle Workflow unit of work that is defined by a PL/SQL stored procedure.

See also: **function**

**functional currency**

Currency you use to record transactions and maintain your accounting information. The functional currency is generally the currency used to perform most of your company's business transactions. You determine the functional currency for the ledger you use in your organization. Also called **base currency**.

**funds available**

The difference between your budget, less encumbrances of all types and actual expenditures.

**funds checking**

The process of certifying funds available. When you check funds, the transaction amount is compared with your funds available, and you are notified whether funds are

available for your transaction. Checking funds does not reserve funds for your transaction.

**You can check funds when you enter a requisition, purchase order, or invoice.**

### **funds reservation**

The creation of requisition, purchase order, or invoice encumbrance journal entries. Purchasing immediately updates your funds available balances and creates an encumbrance journal entry in which you can post in your general ledger.

This is also the process of reserving funds available. You can reserve funds when you enter actual, budget, or encumbrance journals. When you reserve funds, the amount of your transaction is compared with your funds available and you are notified on-line whether funds are available.

### **general ledger transfer**

The process of creating a postable batch for the general ledger from summarized activity for a given period. Using Journal Import in General Ledger, you can create a postable batch in your general ledger. After running Journal Import, you can post your journal using the General Ledger posting process.

### **inspection**

A procedure you perform to ensure that items received conform to your quality standards. You can use inspections to prevent payment for goods and services that fail to meet your quality standards.

### **inter-organization transfer**

Transfer of items from one inventory organization to another. You can have freight charges and transfer credits associated with inter-organization transfer. You can choose to ship items directly or have them go through intransit inventory.

### **interclass conversion**

The conversion formula you define between base units from the different unit classes.

### **intercompany invoice**

An automatically generated statement that eliminates intercompany profit. This transaction may occur between organizations in the same or different legal entities.

### **internal requisition**

See: **internal sales order, purchase requisition.**

### **internal sales order**

A request within your company for goods or services. An internal sales order originates from an employee or from another process as a requisition, such as inventory or

manufacturing, and becomes an internal sales order when the information is transferred from Purchasing to Order Management. Also known as **internal requisition** or **purchase requisition**.

### **intransit inventory**

Items being shipped from one inventory organization to another. While items are intransit you can view and update arrival date, freight charges, and so on.

### **inventory item**

Items you stock in inventory. You control inventory for inventory items by quantity and value. Typically, the inventory item remains an asset until you consume it. You recognize the cost of an inventory item as an expense when you consume it or sell it. You generally value the inventory for an item by multiplying the item standard cost by the quantity on hand.

### **inventory organization**

An organization that tracks inventory transactions and balances, and/or that manufactures or distributes products.

### **inventory transaction**

A record of material movement. The basic information for a transaction includes the item number, the quantity moved, the transaction amount, the accounting flexfields, and the date. *See* **material transaction**

### **invoice**

A summarized list of charges, including payment terms, invoice item information, and other information that is sent to a customer by a supplier for payment.

### **invoice price variance**

The difference between the purchase order price for an item and the actual invoice price multiplied by the quantity invoiced. Payables records this variance after matching the invoice to the purchase order. Typically, the price variance is small since the price the supplier charges you for an item should be the one you negotiated on your purchase order.

### **item**

Anything you make, purchase, or sell, including components, subassemblies, finished products, or supplies. Oracle Manufacturing also uses items to represent planning items that you can forecast, standard lines that you can include on invoices, and option classes you can use to group options in model and option class bills.

### **item attributes**

Specific characteristics of an item, such as order cost, item status, revision control,

COGS account, etc.

**item category**

See: **category**.

**item-specific conversion**

The conversion formula you define between the primary unit of measure for an item and another unit of measure from the same unit class. If you define a conversion rate for a specific item, Purchasing uses the item-specific conversion rate instead of the standard conversion rate for converting between units for that item.

**item type**

A term used by Oracle Workflow to refer to a grouping of all items of a particular category that share the same set of item attributes, used as a high level grouping for processes. For example, each Account Generator item type (e.g. FA Account Generator) contains a group of processes for determining how an Accounting Flexfield code combination is created. *See also* **item type attribute**.

**item type attribute**

A feature of a particular Oracle Workflow item type, also known as an item attribute. An item type attribute is defined as a variable whose value can be looked up and set by the application that maintains the item. An item type attribute and its value is available to all activities in a process.

**Item Validation Organization**

The inventory organization that contains your master list of items. You define it in the Financials Options window. *See also* **organization**.

**job**

A category of personnel in your organization. Examples of a typical job include Vice President, Buyer, and Manager. *See also* **position**.

**key flexfield**

A set of segments. You choose the number of segments you want, the length of each segment, the order of your segments and more. You can then define the list of acceptable values for each segment.

**key flexfield segment**

One of up to 30 different sections of your key flexfield. You separate segments from each other by a symbol you choose (such as -, / or \.). Each segment can be up to 25 characters long. Each key flexfield segment typically captures one element of your business or operations structure, such as company, division, region, or product for the accounting flexfield and item, version number, or color code for the item flexfield.

**key flexfield segment value**

A series of characters and a description that provide a unique value for this element, such as 0100, Eastern region, V20, or Version 2.0.

**LIFO (last-in-first-out) costing method**

A cost flow method used for inventory valuation. Inventory balances and values are updated perpetually after each transaction is sequentially costed. It assumes that the most recent inventory units received or produced are the first units used or shipped. The ending inventory consists of old goods acquired in the earliest purchases or completions.

**legal entity**

An organization that represents a legal company for which you prepare fiscal or tax reports. You assign tax identifiers and other relevant information to this entity.

**license plate number (LPN)**

LPNs are unique identifiers used to store and transact inventory throughout the supply chain. They store a container's contents, including item, revision, lot and serial numbers, and quantity.

**line type**

Determines whether a purchasing document line is for goods, services, or any other type that you define. The line type also determines whether the document line is based on price and quantity or on amount.

**location**

A shorthand name for an address. Location appears in address lists of values to let you select the correct address based on an intuitive name. For example, you may want to give the location name of 'Receiving Dock' to the Ship To business purpose of 100 Main Street.

**locator**

Physical area within a subinventory where you store material, such as a row, aisle, bin, or shelf.

**lockbox**

A service commercial banks offer corporate customers to enable them to outsource their accounts receivable payment processing. Lockbox processors set up special postal codes to receive payments, deposit funds and provide electronic account receivable input to corporate customers. A lockbox operation can process millions of transactions a month.



**logical organization**

A business unit that tracks items for accounting purposes but does not physically exist. *See* **organization**.

**lookup code**

The internal name of a value defined in an Oracle Workflow lookup type. *See also* **lookup type**.

**lookup type**

An Oracle Workflow predefined list of values. Each value in a lookup type has an internal and a display name. *See also* **lookup code**.

**long notes**

A Purchasing feature that lets you provide up to 64K characters per note. You can add long notes to your headers and lines. Purchasing automatically wraps the note while you are typing. You can also format the note by providing extra lines or indenting parts of your message. You can provide as many long notes as you want wherever the long notes capability is available.

**lot**

A specific batch of an item identified by a number.

**manual numbering**

A numbering option to let someone assign numbers manually to documents, employees, and suppliers.

**message**

The text or data Oracle Alert sends when it finds an exception while checking an alert.

**min-max planning**

An inventory planning method used to determine when and how much to order based on a fixed user-entered minimum and maximum inventory levels.

**modal window**

Certain actions that you perform may cause a modal window to display. A modal window requires you to act on its contents before you can continue, usually by choosing OK or Cancel.

**move transaction**

A transaction to move assemblies from operation to operation or within an operation on a discrete job or repetitive schedule.

**multi-source**

An AutoCreate option that lets a buyer distribute the quantity of a single requisition line to several suppliers whenever the buyer wants to purchase the requisition line item from more than one supplier.

**multiple sets of books**

A General Ledger concept for having separate entities for which chart of accounts, calendar, or functional currency differs.

**node**

An instance of an activity in an Oracle Workflow process diagram as shown in the Process window of Oracle Workflow Builder. *See also* **process**.

**note name**

A name that uniquely identifies a standard or one-time note. You use note names to locate a note you want to use or copy on a document.

**numeric number type**

An option for numbering documents, employees, and suppliers where assigned numbers contain only numbers.

**offsetting account**

The source or opposite side of an accounting entry.

**omit**

An AutoCreate option that lets a buyer prevent Purchasing from including certain displayed requisition lines when creating a purchase order or RFQ. If you omit a requisition line, Purchasing returns it to the available pool of requisition lines.

**on-hand quantity**

The physical quantity of an item existing in inventory.

**one-time item**

An item you want to order but do not want to maintain in the Items window. You define a one-time item when you create a requisition or purchase order. You can report or query on a one-time item by specifying the corresponding item class.

**one-time note**

A unique message you can attach to an order, return, order line, or return line to convey important information.

**open**

An open purchase order exists if the purchase order has any lines that have not been fully invoiced and are not cancelled. If you require receipt for items you order, an open purchase order exists if any lines have not been fully received and fully invoiced and are not cancelled.

**open interface**

A Manufacturing function that lets you import or export data from other systems through an open interface. An example is a bar code reader device accumulating data you later import into your manufacturing system for further processing.

**operating unit**

An organization that partitions data for subledger products (AP, AR, PO, OE). It is roughly equivalent to a single pre-Multi-Org installation.

**order cycle**

A sequence of actions you or Oracle Management perform on an order to complete the order. An order cycle lets you define the activity an order follows from initial entry through closing. Order cycles are assigned to order types.

**organization**

A business unit such as a plant, warehouse, division, department, and so on.

**outside operation**

An operation that contains outside resources and possibly internal resources as well.

**outside processing**

Performing work on a discrete job or repetitive schedule using resources provided by a supplier.

**outside processing operation**

Any operation that has an outside processing resource. *See* **outside resource**

**outside processing item**

An item you include on a purchase order line to purchase supplier services as part of your assembly build process. This item can be the assembly itself or a non-stocked item which represents the service performed on the assembly.

**outside resource**

A resource provided by a supplier that you include in your routings, such as supplier sourced labor or services. This includes both **PO move and PO receipt resources**.

**parameter**

A variable used to restrict information in a report, or determine the form of a report. For example, you may want to limit your report to the current month, or display information by supplier number instead of supplier name.

**payment batch**

A group of invoices selected for automatic payment processing via Oracle Payables AutoSelect function.

**payment terms**

The due date and discount date for payment of an invoice. For example, the payment term '2% 10, Net 30' lets a customer take a two percent discount if payment is received within 10 days, with the balance due within 30 days of the invoice date.

**pending**

A status where a process or transaction is waiting to be completed.

**period**

See: **accounting period**.

**period expense**

An expense you record in the period it occurs. An expense is typically a debit.

**periodic alert**

An alert that checks your database for the presence of a specific condition according to a schedule you define.

**planned purchase order**

A type of purchase order you issue before you order actual delivery of goods and services for specific dates and locations. You normally enter a planned purchase order to specify items you want to order and when you want delivery of the items. You later enter a shipment release against the planned purchase order when you actually want to order the items.

**PO**

See: **purchase order**

**PO move resource**

An outside resource that is automatically charged upon receipt of a purchase order. PO move resources also automatically initiate shop floor move transactions upon receipt.

**PO receipt resource**

An outside resource that is automatically charged upon receipt of a purchase order.

**position**

A specific function within a job category. Examples of typical positions associated with the Vice President job include: Vice President of Manufacturing, Vice President of Engineering, and Vice President of Sales. *See job.*

**position hierarchy**

A structure of **positions used to define management line reporting and control access to employee information.**

**pre-approved**

A document that has been approved by someone with final approval authority, but then forwarded to yet another approver for additional approval; or a document that has been authorized for approval but for which funds have not yet been reserved (if your organization uses encumbrance). A document with a status of Pre-Approved does not show up as supply until its status changes to Approved.

**price break line**

Supplier pricing information for an item or purchasing category on a quotation. The price you enter on a price break line depends on the quantity you order from your supplier. Usually, suppliers provide you with price break line structures to indicate the price you would pay for an item depending on the quantity you order. Generally, the more you order, the less expensive your unit price. Also, depending on the quantity you order, a supplier may provide you with different purchase conditions, such as advantageous payment or freight terms when you buy in large quantities.

**process**

A set of Oracle Workflow activities that need to be performed to accomplish a business goal. *See also Account Generator, process activity, process definition.*

**process activity**

An Oracle Workflow process modelled as an activity so that it can be referenced by other processes; also known as a subprocess. *See also .*

**processing status**

The processing state of a row (record) in an open interface table. Common statuses include, but are not restricted to, Pending, Running, and Error.

**profile option**

A set of changeable options that affect the way your applications run. In general, profile

options can be set at one or more of the following levels: site, application, responsibility, and user.

**project**

A unit of work broken down into one or more tasks, for which you specify revenue and billing methods, invoice formats, a managing organization, and project manager and bill rates schedules. You can charge costs to a project, as well as generate and maintain revenue, invoice, unbilled receivable and unearned revenue information for a project.

**Project Manufacturing**

A type of manufacturing environment where production requirements are driven by large projects. You can plan, schedule, process, and cost against a specific project or a group of projects. If Oracle Project Manufacturing is installed and the Project References Enabled and Project Control Level parameters are set in the Organization Parameters window in Oracle Inventory, you can assign project and, if required, task references to sales orders, planned orders, jobs, requisitions, purchase orders, and other entities within Oracle Manufacturing. If the Project Cost Collection Enabled parameter is also set, you can collect and transfer manufacturing cost to Oracle Projects.

**project purchase order**

A purchase order with a project and task reference.

**project requisition**

A requisition with a project and task reference.

**promise date**

The date on which your supplier agrees to ship the products to you, or the date that you will receive the products.

**proprietary accounty**

An account segment value (such as 3500) that is assigned one of the five proprietary account types.

**protection level**

In Oracle Workflow, a numeric value ranging from 0 to 1000 that represents who the data is protected from for modification. When workflow data is defined, it can either be set to customizable (1000), meaning anyone can modify it, or it can be assigned a protection level that is equal to the access level of the user defining the data. In the latter case, only users operating at an access level equal to or lower than the data's protection level can modify the data. *See also* **Account Generator**.

**purchase order**

A type of purchase order you issue when you request delivery of goods or services for

specific dates and locations. You can order multiple items for each planned or standard purchase order. Each purchase order line can have multiple shipments and you can distribute each shipment across multiple accounts. *See* **standard purchase order** and **planned purchase order**.

**purchase order encumbrance**

A transaction representing a legally binding purchase. Purchasing subtracts purchase order encumbrances from funds available when you approve a purchase order. If you cancel a purchase order, Purchasing creates appropriate reversing entries in your general ledger. Purchase order encumbrance is also known as obligation, encumbrance, or lien.

**purchase order receipt**

See: **receipt**.

**purchase order revision**

A number that distinguishes printed purchase order versions. Purchasing automatically sets the revision to 0 when you initially create a purchase order. Each purchase order you print displays the current revision number.

**purchase order shipment**

A schedule for each purchase order line composed of the quantity you want to ship to each location. You can also provide delivery dates for each shipment line. You can create an unlimited number of shipments for each purchase order line. You receive goods and services against each shipment line.

**purchase price variance**

The variance that you record at the time you receive an item in inventory or supplier services into work in process. This variance is the difference between the standard unit cost for the item or service and the purchase unit price multiplied by the quantity received. You record purchase price variances in a purchase price variance account for your organization. Since standard cost is a planned cost, you may incur variances between the standard cost and the purchase order price.

**purchase requisition**

An internal request for goods or services. A requisition can originate from an employee or from another process, such as inventory or manufacturing. Each requisition can include many lines, generally with a distinct item on each requisition line. Each requisition line includes at least a description of the item, the unit of measure, the quantity needed, the price per item, and the Accounting Flexfield you are charging for the item. *See also* **internal sales order**.

**purchased item**

An item that you buy and receive. If an item is also an inventory item, you may also be

able to stock it. *See also* **inventory item**.

**purchasing documents**

Any document you use in the purchasing life cycle, including requisitions, RFQs, quotations, purchase orders, and purchase agreements.

**purchasing open interface**

A Purchasing function that lets you import price/sales catalog information from your suppliers. It receives the catalog data electronically, verifies and processes the data, and imports the data directly into Purchasing as blanket purchase agreements or quotations.

**purge**

A technique for deleting data in Oracle Manufacturing that you no longer need to run your business.

**purge category**

A Purchasing feature you use to purge a particular group of records from the database. Purchasing lets you choose from the following separate categories: *Simple Requisitions*, *Simple Purchase Orders*, *Suppliers*, *Simple Invoices* (only if you installed Payables), and *Matched Invoices and POs* (only if you installed Payables). The last category is the most comprehensive category you can choose. You should purge all appropriate documents before purging your supplier information, because Purchasing does not purge suppliers that you referenced on existing documents.

**purge status**

A Purchasing method of reporting the progress of a purge you initiate. The Status field lets you take an action on your purge process (Initiate, Confirm, Abort), or reports on the current status of the purge (Printed, Deleting, Completed-Aborted, Completed-Purged).

**quantity accepted**

The number of items you accept after inspection.

**quantity-based order**

An order you place, receive, and pay based on the quantity, unit of measure, and price of the goods or services that you purchase.

**quantity received tolerance**

The percentage by which you allow quantity received to exceed quantity ordered.

**quantity rejected**

The number of items you reject after inspection.



**quotation**

A statement of the price, terms, and conditions of sale a supplier offers you for an item or items. A quotation usually includes a detailed description (specifications) of goods or services the supplier offers. Suppliers consider quotations as an offer to sell when given in response to an inquiry. A quotation may be verbal or written. You often get verbal quotations for minor purchases by telephone. You usually send a request for quotation if you want a written quotation from a supplier. Written quotations often have an effective date and an expiration date.

**quotation type**

A QuickCode you define to categorize your quotation information. Purchasing provides you with the following set of predefined quotation types: Catalog, Verbal, Telephone, or From RFQ. You can define other quotation types that better fit your business.

**receipt**

A shipment from one supplier that can include many items ordered on many purchase orders.

**receipt line**

An individual receipt transaction that identifies receipt of an item against a purchase order shipment.

**receipt routing**

A method of simplifying transaction entry by specifying routing steps for receipts.

**receipt traveler**

An internal routing ticket you place on received goods to show their final destination.

**receiving open interface**

A set of interface tables in Purchasing that lets you import information from outside of Purchasing, from Oracle or non-Oracle applications. Some examples of information imported into the receiving open interface are Advance Shipment Notices (ASNs). The receiving open interface validates the information before importing it into the Purchasing application.

**receiving organization**

For drop-ship orders, the purchasing organization that records receipt of a drop-shipped item.

**reject**

For Oracle Automotive, Oracle Service and Oracle Work in Process, reject is an intraoperation step in an operation where you can record assemblies that require

rework or need to be scrapped. For Oracle Purchasing and Oracle Quality, reject is an option you use to indicate that you do not want to approve a document. Purchasing returns the document to its owner for modification and resubmission if appropriate.

**reject over quantity tolerance**

An option you use to disallow receipts that exceed the tolerance level.

**release**

An actual order of goods and services you issue against a blanket purchase agreement. The blanket purchase agreement determines the characteristics and the prices of the items. The release specifies the actual quantities and dates ordered for the items. You identify a release by the combination of blanket purchase agreement number and release number.

**reorder point planning**

An inventory planning method used to determine when and how much to order based on customer service level, safety stock, carrying cost, order setup cost, lead time and average demand.

**report**

An organized display of Oracle Applications information. A report can be viewed on-line or sent to a printer. The content of information in a report can range from a summary to a complete listing of values.

**report headings**

General information about the contents of the report.

**report options**

Options for sorting, formatting, selecting, and summarizing the information in the report. This section describes the options available for each report.

**requisition template**

A feature that lets you define a list of commonly purchased items from which a requestor can create a requisition. You can define the list of items by referencing an existing purchase order. Requestors use the requisition template to create simple, pre-sourced requisitions.

**request for quotation (RFQ)**

A document you use to solicit supplier quotations for goods or services you need. You usually send a request for quotation to many suppliers to ensure that you get the best price and terms possible. Depending on the way you do business, you can use two general types of RFQs: specific and generic.

**requisition**

See: **purchase requisition and internal sales order.**

**requisition approval**

The act of approving the purchases of the items on a requisition. A requisition must receive the required approvals before a buyer can create purchase orders from this requisition. The approvals can come from any employee, but a requisition is fully approved only when an employee who has enough authority approves it. If you require encumbrance or budgetary control for requisitions, a requisition is fully approved only when an employee with sufficient approval authority approves and reserves funds for the requisition.

**requisition encumbrance**

A transaction representing an intent to purchase goods and services as indicated by the reservation of funds for a requisition. Purchasing subtracts requisition encumbrances from funds available when you reserve funds for a requisition. If you cancel a requisition, Purchasing creates appropriate reversing entries in your general ledger.

**requisition pool**

Requisition lines that are approved, not cancelled, and not yet on a purchase order.

**reserve**

An action you take in Purchasing to reserve funds for a purchasing document or an action in Order Entry to allocate products for a sales order. If the document passes the submission tests and if you have sufficient authority, Purchasing reserves funds for the document.

**Reserve for Encumbrance account**

The account you use to record your encumbrance liability. You define a Reserve for Encumbrance account when you define your ledger. When you create encumbrances automatically in Purchasing or Payables, General Ledger automatically creates a balancing entry to your Reserve for Encumbrance account when you post your encumbrance journal entries. And General Ledger overwrites the balancing segment for your Reserve for Encumbrance account, so you automatically create the reserve for encumbrance journal entry to the correct company.

**responsibility**

Determines the data, forms, menus, reports, and concurrent programs you can access in Oracle Applications. It is linked directly to a data group. Several users can share the same responsibility, and a single user can have multiple responsibilities.

**result code**

In Oracle Workflow, the internal name of a result value, as defined by the result type.

See also: **result type**, **result value**.

**result type**

In Oracle Workflow, the name of the lookup type that contains an activity's possible result values.

**result value**

In Oracle Workflow, the value returned by a completed activity, such as *Approved*.

See also: **result code**, **result type**.

**return**

In Purchasing, an AutoCreate option that lets a buyer return a requisition line and all other unpurchased requisition lines on the same requisition to the requisition preparer. In Order Entry, it is the opposite of a sales order. It involves receipt of goods previously sold to a customer, credit to a customer, and possibly replacement with an identical or similar product.

**return material authorization (RMA)**

Permission for a customer to return items.

**return to supplier**

A transaction that allows you to return to the supplier items from a fully or partially received purchase order and receive credit for them.

**revision**

A particular version of an item, bill of material, or routing.

**revision quantity control**

A condition placed on an item that ensures that you always identify an item by its number and its revision. Certain items require tighter controls than other. For instance, you may want to control the quantities you have in inventory for an item by revision. For another item, you may just want to know the quantities you have on hand across all revisions. You keep track of inventory quantities by revision when an item is under revision quantity control. You keep track of inventory quantities by item when an item is not under revision quantity control.

**RFQ**

See also: **request for quotation**.

**RMA**

See also: **Return Material Authorization**.

**serial number**

A number assigned to each unit of an item and used to track the item.

**ledger**

A financial reporting entity that partitions General Ledger information and uses a particular chart of accounts, functional currency, and accounting calendar. This concept is the same whether or not the Multi-organization support feature is implemented.

**ship-to address**

A location where items are to be shipped.

**ship via**

See: **freight carrier**

**shipment release**

An actual order of goods and services against a planned purchase order. The planned purchase order determines the characteristics of the items on the order. The planned purchase order also has the expected quantities, prices, and ship-to locations, and delivery dates for the items on the order. You identify a shipment release by the combination of the planned purchase order number and the release number. Each planned purchase order line can have multiple shipments and you can distribute the quantity of each shipment across multiple accounts.

**shipment relief**

The process of relieving the master demand schedule when a sales order ships. This decrements the demand schedule to represent an actual statement of demand.

**short notes**

A Purchasing feature that lets you provide up to 240 characters on your documents. Typically, these notes are for your supplier, approver, buyer, or receiver.

**source base unit**

The unit of measure from which you are converting when you define your interclass conversions. You define the destination base unit in terms of the source base unit. Your source base unit is the base unit of a unit class.

**sourcing**

The action of identifying a purchasing source or supplier for goods or services. To identify the best sources for your purchases, you can create RFQs that you send to your suppliers, enter quotations from your supplier, and evaluate these quotations for each item you purchase.

**sourcing rule**

Specifies how to replenish items in an organization, such as purchased items in plants. You can also use sourcing rules to override sourcing that is specified in the bill of distribution assigned to an item.

**sourcing rule assignment**

See: **assignment hierarchy**

**SQL validation statement**

A statement written in SQL to customize action details.

**standard note**

A long note you define and can later reference on as many documents as you want.

**standard purchase order**

A type of purchase order you issue when you order delivery of goods or services for specific dates and locations for your company. Each standard purchase order line can have multiple shipments and you can distribute the quantity of each shipment across multiple accounts. *See* **purchase order**.

**standard receipt**

A receipt routing in which shipments are received into a receiving location and then delivered in a separate transaction. Standard receipts can be inspected or transferred before delivery.

**standard unit conversion**

The conversion formula you define between different units from the same unit class. You define your own standard conversion.

**status check**

A set of tests Purchasing performs on a purchasing document to ensure it is in a valid state before performing an approval action.

**submission check**

A set of tests on a purchasing document to ensure it is ready to be submitted for approval processing.

**submit**

To send a document to another employee without attempting to approve or reserve funds for it yourself.

**substitute receipt**

An option that lets you receive predefined acceptable substitutes for any item.

**supply chain planning**

The development and maintenance of multi-organizational distribution and manufacturing plans across a global supply chain.

**summary message action**

A message representing one or more exceptions. The message may include introductory and closing paragraphs separated by the exceptions listed in a columnar report format.

**supplier**

Provider of goods or services.

**supplier product number**

The number your supplier assigns to an item. You and your supplier can have different item naming conventions. You can identify the item with one number (Item) while your supplier identifies this item using another number (Supplier Product Number). Using and referencing supplier product numbers helps you speed up your purchasing cycle. By referencing a number your supplier knows, you can help your suppliers understand your purchase orders and RFQs better.

**supplier purchasing hold**

A hold condition you place on a supplier to prevent new purchasing activity on the supplier. You cannot approve purchase orders for suppliers you placed on hold.

**supplier quotation list**

A list of suppliers who can provide goods or services you need. You often define a supplier quotation list for an item or class of items. You can use a supplier quotation list to generate multiple copies of a RFQ automatically and to manage supplier responses.

**supplier sourced component**

A component item on a bill of material supplied to work in process directly by a supplier.

**supply**

A quantity of materials available for use. Supply is replenished in response to demand or anticipated demand.

**supply agreement blanket purchase order**

A type of purchase order you issue before you request actual delivery of goods or services. You normally create a blanket purchase agreement to document a long-term

supplier agreement. A blanket purchase agreement may contain an effective date and an expiration date, a committed amount, or quantity. You use a blanket purchase agreement as a tool for specifying agreed prices and delivery dates for goods and services before actually ordering them. Blanket agreement in Oracle Purchasing with the Supply Agreement flag set on the Blanket Agreement header. Only Supply Agreement Releases are picked up by Supplier Scheduling.

**task**

A subdivision of project work. Each project can have a set of top level tasks and a hierarchy of subtasks below each top level task.

See also: **work breakdown structure**.

**tax codes**

Codes to which you assign sales tax or value-added tax rates.

**three-way matching**

Purchasing performs three-way matching to verify the purchase order, receipt, and invoice information match within tolerance.

**total quantity accepted**

The total number of accepted items for the receipt line.

**total requisition limit**

The maximum amount you authorize an employee to approve for a specific requisition.

**trading partner**

Any company that sends and receives documents via EDI.

**transaction interface**

An open interface table through which you can import transactions. *See* **open interface**.

**transition**

In Oracle Workflow, the relationship that defines the completion of one activity and the activation of another activity within a process. In a process diagram, the arrow drawn between two activities represents a transition.

See also: **activity, Workflow Engine**.

**two-level master scheduling**

A technique that facilitates the forecast explosion of product groupings into related master production schedules. The top-level MPS is usually defined for a product line, family or end product while the second-level is defined for key options and components.



**two-way matching**

Purchasing performs two-way matching to verify that purchase order and invoice information match within tolerance.

**UN number**

An identifier for a hazardous material. Each Identification number has a description. Identification numbers are not unique. For instance, the same UN Number may correspond to 2 closely related but different types of materials.

**unit of measure**

The unit that the quantity of an item is expressed.

**unit of measure class**

A group of units of measure and their corresponding base unit of measure. The standard unit classes are Length, Weight, Volume, Area, Time, and Pack.

**unit of measure conversions**

Numerical factors that enable you to perform transactions in units other than the primary unit of the item being transacted.

**unordered receipt**

A site option that lets you receive an unordered item. You can later batch an unordered item to an existing purchase order, or add it to a new purchase order.

**UOM**

See: **unit of measure**.

**value added**

See: **outside processing**.

**value basis**

An attribute you associate with a line type to indicate whether you order items for this line type by quantity or amount.

**variance**

An accounting term used to express the difference between an expected cost and an actual cost. A variance can be favorable or unfavorable. Variances are usually written directly to the income statement as a period expense.

**vendor**

See: **supplier**.

**waybill**

A document containing a list of goods and shipping instructions relative to a shipment.

**Workflow Engine**

The Oracle Workflow component that implements a workflow process definition. The Workflow Engine manages the state of all activities, automatically executes functions, maintains a history of completed activities, and detects error conditions and starts error processes. The Workflow Engine is implemented in server PL/SQL and activated when a call to an engine API is made.

See also: **Account Generator, activity, function, item type.**

**X12**

ANSI standard for inter-industry electronic interchange of business transactions.

---

# Index

## A

---

### Acceptances

- acceptance required, 4-63
- overview, 4-5

### Acceptances window

- enter acceptances, 4-82

### Access Level

- defining, 1-71

### Access Level Options, 2-8

- full, 2-8
- modify, 2-8
- view only, 2-8

### Account Generator, E-6

- using in Oracle Purchasing, E-6

### Account Generator workflow

- account defaults, E-9
- activities, E-39
- customizing, E-24
- default accrual account, E-43
- default budget account, E-43
- default charge account, E-44
- default variance account, E-44
- expense charge account, E-45
- FlexBuilder rules, E-49
- generate default accounts, E-37
- get charge account, E-48
- get variance account, E-48
- implementation decisions, E-7
- inventory budget account, E-46
- inventory charge account, E-45
- item types, E-30

- project account, E-47

- shop floor charge account, E-46

- Workflow Monitor, E-49

### Accounting

- Center-Led Procurement, 1-79

- Expense Charge Account Rules, 1-83

### Accounting lines, viewing, 9-47

### Accrual Process

- period-end accruals, 9-104

### Accrual Reconciliation, 9-102

### Accrual Reconciliation Load, 13-1

### Accrual Write Off, 9-111

### Accrual Write-Off report, 11-1

### Accrual Write Offs, 9-114

- accounting, 9-119

- overview, 9-111

- process, 9-113

- select accounts, 9-115

- view, 9-118

### window

- AP and PO, 9-116

- miscellaneous, 9-117

### Accrue Expense Items

- option setup, 1-40

### Action History, viewing, 10-1

### Action History window, 10-1

### Activities

- Generate Default Accounts process, E-39

- in the Approve and Forward PO subprocess, E-122

- in the Approve PO (Change Order)

- subprocess, E-158

- in the Approve PO subprocess, E-118

- in the Approve Requisition subprocess, E-86
- in the Change Order Reserve Before Approve subprocess, E-156
- in the Confirm Receipt process, E-192
- in the Do Document Changes Require Reapproval? subprocess, E-154
- in the Does Req Line Have Enough Information To Automatically Create A Document, E-178
- in the Find Approver subprocess (for purchase orders), E-127
- in the Forward PO subprocess, E-129
- in the Get All Blanket PO Changes subprocess, E-149
- in the Get All Contract PO Changes subprocess, E-150
- in the Get All Document Changes subprocess, E-147
- in the Get All Planned PO Changes subprocess, E-151
- in the Get All Release Changes subprocess, E-152
- in the Get All Standard PO Changes subprocess, E-153
- in the Notify Approver subprocess, E-73
- in the Notify Approver subprocess (for purchase orders), E-124
- in the Notify Requester subprocess, E-194
- in the Overall Document Creation / Launch Approval Process, E-172
- in the PO Approval Top Process, E-104
- in the PO Catalog Price Tolerances Exceeded workflow, E-211
- in the PO Document Approval Reminder process, E-203
- in the Print Document subprocess, E-88
- in the Print Document subprocess (for change orders), E-161
- in the Print Document subprocess (for purchase orders), E-120
- in the Reject PO subprocess, E-132
- in the Reject Requisition subprocess, E-76
- in the Reserve at the Start subprocess, E-71
- in the Reserve Before Approve subprocess (for purchase orders), E-114
- in the Return PO to Submitter subprocess, E-130

- in the Return Requisition to Submitter subprocess, E-77
- in the Verify Approval Authority subprocess, E-73, E-89
- in the Verify Approval Authority subprocess (for purchase orders), E-116
- in the Verify PO subprocess, E-112
- in the Verify Req Line Info process, E-176
- in the Verify Requisition subprocess, E-70
- Main Requisition Approval process, E-63
- PO Approval process, E-109
- Activity nodes
  - in the Notify Approver subprocess, E-73
- Advanced Pricing
  - Receipt Option setup, 1-46
- Advanced Shipment Notice Discrepant Receipts Report, 11-3
- Advance Shipment Notice
  - and CUM management, 9-19
  - application advices, 9-17
  - correcting a receipt, 9-73
  - finding expected receipts, 9-27
  - finding returns, 9-70
  - in Manage Shipments window, 9-81
  - intransit shipments, 9-80
  - overview, 9-15
  - receiving against, 9-19
  - receiving options, 9-17
  - types of, 9-18
  - with substitute items, 9-19
- Advance Shipment Notices (ASNs), 9-15
- Agreements
  - Buyer's Work Center, 7-18
- Amount Based Purchasing, 1-60
- Annotating Purchasing Documents, 1-26
- AP and PO Accrual Reconciliation Report, 11-4
- AP and PO Accrual Write-Offs, 9-116
- Approval, 3-57
- Approval Actions
  - cancel, 2-35
  - change the forward from person, 2-35
  - change the forward to person, 2-35
  - facsimile, 2-36
  - print, 2-36
  - reserve, 2-33
  - retroactive pricing, 2-36
  - sourcing updates, 2-35

- Approval and Security
  - Human Resources, 2-1
  - setup matrix, 2-4
  - setup overview, 2-1
  - setup steps, 2-2
  - Using Approval Hierarchies, 2-1
  - Using Security Hierarchies, 2-2
- Approval authorization rules
  - defining, 2-13
- Approval Groups
  - account range, 1-22
  - assigning, 1-24, 2-15
  - assign window
    - See* Appendix A
  - defining, 1-21, 2-13
  - document total, 1-23
  - item category range, 1-23
  - item range, 1-23
  - location, 1-23
  - overview, 2-12
  - setup window
    - See* Appendix A
- Approval Hierarchy, 2-1
  - changing, 2-4
- Approvals
  - effect on supply, 2-21
  - offline, 2-38
  - overview, 2-19
  - Pre-Approved status, 2-21
  - taking approval actions, 2-32
- Approval Workflow, 2-2
  - defining, 1-71
- Approve and Forward PO subprocess activities
  - Approve And Forward The PO, E-122
  - Document Failed State Check, E-123
  - Document Manager Failed, E-123
  - Does Document State Allow Approval?, E-122
  - Get PO Attributes, E-123
  - Is Document Complete?, E-122
  - Reject the PO, E-123
  - Set PO Status to Original Status, E-123
  - Start, E-122
  - Unable To Approve Document, E-123
  - Unable To Reject Document, E-123
- Approve and Forward PO subprocess overview, E-121
- Approve and Forward Req subprocess activities
  - End, E-123
- Approve Document window
  - Taking Approval Actions, 2-32
- Approved Quotations
  - using on purchase orders, 5-77
  - using on purchase orders and requisitions, 5-79
  - using on requisitions, 5-77
- Approved Supplier List, 5-35
  - define, 5-40
  - find window, 5-49
  - supplier and item/commodity combination, 5-40
- Approved Supplier List Statuses, 5-37
- Approved Supplier List Summary
  - window, 5-49
- Approved Supplier List Summary window, 5-48
- Approve Entire Quotations window
  - Approving Entire Quotations, 5-79
- Approve PO (Change Order) subprocess activities
  - Approve the PO, E-159
  - Document Failed State Check, E-159
  - Document Manager Failed, E-159
  - Does Document State Allow Approval?, E-159
  - End, E-160
  - Get PO Attributes, E-159
  - Is Document Approved?, E-159
  - Is Document Complete?, E-159
  - Reject the PO, E-160
  - Set PO Status to Original Status, E-159
  - Start, E-159
  - Unable To Approve Document, E-159
  - Unable to Reject Document, E-160
- Approve PO (Change Order) subprocess overview, E-157
- Approve PO subprocess activities
  - Approve the PO, E-118
  - Document Failed State Check, E-119
  - Document Manager Failed, E-119
  - Does Document State Allow Approval?, E-118
  - End, E-119
  - Get PO Attributes, E-119
  - Is Document Approved?, E-118
  - Is Document Complete?, E-118
  - Reject the PO, E-119
  - Set PO Status to Original Status, E-119

- Start, E-118
- Unable To Approve Document, E-119
- Unable to Reject Document, E-119
- Approve PO subprocess overview, E-117
- approve purchase orders, 4-6
- Approve Quotations window
  - Approving Quotation Shipments, 5-77
- Approver Can Modify
  - defining, 1-70
- Approve Requisition subprocess activities
  - Approve the Requisition, E-87
  - Document Failed Correctness Check, E-87
  - Document Failed State Check, E-87
  - Document Manager Failed, E-87
  - Does Document State Allow Approval Action?, E-86
  - End, E-87
  - Get Requisition Attributes, E-87
  - Is Document Approved, E-86
  - Is Document Complete?, E-86
  - Set Req Status to Original Status, E-87
  - Start, E-86
- Approve Requisition subprocess overview, E-85
- Archive When
  - defining, 1-71
- ASL Upgrade process, 13-2
- Assign Requisition Lines window, 5-87
- Attaching Notes to Purchasing Documents, 1-33
- Attachments, 1-26
  - attaching notes to documents, 1-33
  - brief notes, 1-27
  - icon, 1-33
  - managing , 1-28
  - printing, 1-31
  - referencing on documents, 1-32
  - usage, 1-31
  - using , 1-27
- Attachment Size
  - maximum setup, 1-37
- Attributes (item attributes)
  - Account Generator workflow, E-30
  - Change order workflow, E-136
  - Debit Memo Notification, E-214
  - PO Approval, E-95
  - PO Confirm Receipts, E-188
  - PO Create Documents, E-167
  - PO Requisition Approval, E-56
  - PO Send Notifications for Purchasing Documents, E-199
- AutoApproval
  - definition, 3-5
- AutoClose, 4-8
- AutoCreate, 6-1
  - Add to Document window, 6-15
  - automatic mode, 6-3
  - completing, 6-15
  - criteria, selecting, 6-12
  - descriptive flexfields, 6-12
  - Document Builder, 6-17
  - document options, 6-3
  - entering document information, 6-15
  - features, 6-7
  - finding requisition lines, 6-9
  - from emergency requisitions, 6-8
  - from procurement card requisitions, 6-8
  - iProcurement requisitions, 6-8
  - manual mode, 6-3
  - modifying requisition lines, 6-19
  - New Document Number window, 6-16
  - New Document window, 6-16
  - overview, 6-1
- AutoCreate Documents window
  - Selecting AutoCreation Criteria, 6-12
  - Using the Document Builder, 6-17
- automatic document creation
  - Buyer's Work Center, 7-1
- Automatic Offset Method
  - option setup, 1-40
- Automatic Release Generation, 4-96
- automatic sourcing, 5-24
  - setting up, 5-27
  - troubleshooting, 5-29
- Automatic sourcing
  - definition, 5-4
- Automatic Sourcing
  - Center-Led Procurement, 1-79

## **B**

---

- Backordered Internal Requisitions report, 11-6
- Bid quotation or RFQ, 5-5
- Blanket and Planned PO Status report, 11-7
- Blanket purchase agreements
  - audit report, 11-47

- notify options setup, 1-37
- Blanket Purchase Agreements, 4-2
  - Buyer's Work Center, 7-18
- blanket purchase orders
  - status report, 11-7
- Blanket Releases, 4-3
- Blind receipt
  - setup, 9-8
- Blind Receiving
  - option setup, 1-45
- Budgetary control
  - online funds availability Checking, 3-4
  - on-line funds availability checking, 4-5
- Build Expense Charge Account subprocess
  - overview, E-45
- Build Inventory Budget Account subprocess
  - overview, E-46
- Build Inventory Charge Account subprocess
  - overview, E-45
- Build Project Related Account subprocess
  - overview, E-47
- Build Shop Floor Charge Account subprocess
  - overview, E-46
- Buyer's Requisition Action Required report, 11-9
- Buyer's Work Center, 7-1, 7-2
  - Agreement Control, 7-21
  - Agreement Header, 7-20
  - Agreement Lines, 7-21
  - Agreements, 7-17
  - Agreement Summary, 7-18
  - complex work, 7-16
  - Create Blanket Purchase Agreements, 7-19
  - Create Contract Purchase Agreements, 7-19
  - Create Standard Purchase Orders, 7-12
  - orders, 7-10
  - Order Summary, 7-11
  - Update Blanket Purchase Agreements, 7-19
  - Update Contract Purchase Agreements, 7-19
  - using agreement views, 7-19
  - using order views, 7-12
- Buyer Listing, 11-8
- Buyers
  - defining, 1-20
  - setup, 1-20
  - window
    - See Appendix A
- buyer workload, 5-83

- Buyer Workload
  - reviewing, 5-85

## C

---

- Cancel
  - purchase orders, 4-7
- Cancelled Purchase Order report, 11-11
- Cancelled Requisitions Report, 11-11
- Cancel Requisitions
  - option setup, 1-35
- Can Change Approval Hierarchy
  - defining, 1-70
- Can Change Forward-From
  - defining, 1-70
- Can Change Forward-To
  - defining, 1-70
- Capacity
  - defining for a supplier (overview), 5-26
  - in Supplier-Item Attributes window, 5-47
- Cascade
  - receipts and receiving transactions, 9-23
- Cascade transactions
  - setup, 9-8
- Cascade Transactions
  - option setup, 1-44
- catalog information
  - monitoring supplier price increases, 5-21
  - price tolerance, 5-20
  - receiving electronically, 5-18
- Catalog information
  - sourcing, 5-19
- Catalog quotation or RFQ, 5-5
- Center-Led Procurement
  - accounting, 1-79
  - setup, 1-79, 1-80
  - transaction flows, 1-80
- centralized procurement, 3-6
- CFR 21 Part 11 Compliance, 9-41
- Change Order Reserve Before Approve
  - subprocess activities
    - Document Manager Failed, E-157
    - End, E-157
    - Is Encumbrance On and Is Document Not Reserved?, E-156
    - Is Forward-To Valid?, E-157
    - Reject the PO, E-157

- Reserve Document, E-156
- Set Forward-To/From For Forward Action, E-157
- Start, E-156
- Unable to Reject Document, E-157
- Unable To Reserve Document, E-157
- Change Order Reserve Before Approve subprocess overview, E-155
- Change Order workflow, E-133
  - Approve PO (Change Order), E-157, E-158
  - Changes Require Reapproval?, E-154, E-154
  - customizing, E-133
  - Get All Blanket PO Changes, E-149, E-149
  - Get All Contract PO Changes, E-150, E-150
  - Get All Document Changes, E-147, E-147
  - Get All Planned PO Changes, E-150
  - Get All Release Changes, E-152, E-152
  - Get All Standard PO Changes, E-153, E-153
  - Item Attributes, E-136
  - Print and Fax, E-160, E-161
  - Reserve Before Approve, E-155, E-156
- Changes to purchase orders, viewing, 10-3
- Clearing Account
  - option setup, 1-46
- Code of Federal Regulations (CFR) Title 21 Part 11
  - Oracle Purchasing, F-2
  - overview, F-1
  - viewing e-records and e-signatures, F-3
- Communicating purchase orders
  - PO Output Format options setup, 1-36
- Complex Work, G-1
  - pay items, 7-16
  - purchase order lines, 7-16
- Confirm Receipt process activities
  - End, E-194
  - Notify Receiving Transactions Failure, E-193
  - Process Receiving Transactions, E-193
  - Retrieve Order Information, E-192
  - Retrieve Receive Orders Web Page URL, E-193
  - Retrieve Requester's Manager, E-193
- Confirm Receipt process overview, E-191
- Confirm Receipts workflow, E-184
  - Activities, E-192
  - customize, E-184
  - item types, E-188
  - Notify Requester, E-194, E-194
  - overview, E-191
- Confirm Receipts Workflow Select Orders, 13-3
- Contract Purchase Agreements, 4-3
  - Buyer's Work Center, 7-18
- Contract Status report, 11-12
- Control Documents window
  - Controlling Documents, 2-60
- Controlling Documents, 2-57
  - cancel, 2-58
  - close, 2-58
  - close for invoicing, 2-58
  - close for receiving, 2-59
  - finally close, 2-59
  - freeze, 2-59
  - on hold, 2-59
  - open, 2-59
  - open for invoicing, 2-59
  - open for receiving, 2-59
  - release hold, 2-59
  - unfreeze, 2-59
- control numbers, 9-83
- Copy Document window, 4-99
  - copy a quotation from an RFQ, 5-74
- Copying
  - purchase agreements, 4-99
  - purchase orders, 4-99
  - quotations, 4-99
- Copying quotations from RFQs, 5-74
- Corrections, 9-73
  - finding, 9-74
- Corrections, entering, 9-78
- corrections window
  - exchange rate and Currency, 9-79
- Country of Origin
  - Approved Supplier List, 5-45
  - Receipts window, 9-32
  - release Shipments window, 4-89
  - Shipments window, 4-68
- Country of Origin Report (by Item), 11-13
- Country of Origin Report (by Supplier), 11-14
- Create Internal Sales Orders process, 13-4
- Create Releases process, 13-5
- Cumulative Pricing, 4-56
- currency
  - in Corrections window, 9-79
- Currency
  - entering in purchase orders, RFQs, quotations,



- 4-60
- information, entering in receipt, 9-33
- rate type options setup, 1-39
- currency information
  - in Receiving Transactions window, 9-61
- Currency window, 4-60
- Customer returns, overview, 9-13

## D

---

- Debit Memo Notification Workflow, E-212
  - customize, E-212
  - item type, E-214
  - summary, E-215
- Debit Memo process overview, E-215
- Debit Memos, 9-14
- Default charge account
  - expense, 1-83
- Default Hierarchy
  - defining, 1-71
- Define Catalog Server for External Suppliers
  - iProcurement, 1-89
- Define Catalog Server Loader Values
  - iProcurement, 1-89
- Define MassCancel Listing, 2-65
- Define MassCancel window, 2-61
  - Defining MassCancel, 2-62
- Defining MassCancel
  - report submission, 2-67
- Defining Purchase Order Receipt Accruals, 9-120
- Defining Supplier Lists, 5-81
- Demand Workbench, 7-4
  - advanced search, 7-7
  - create documents, 7-7
  - manage requisitions, 7-8
  - requisition grouping, 7-9
  - searching, 7-5
  - search results, 7-6
  - using, 7-3
  - using views, 7-6
- Disposition messages
  - display option, 1-37
- Distributions window
  - More tab, 4-78
  - Project tab, 4-78
  - purchase order distributions, 4-75
  - Releases, 4-93

- tax information, 4-78
- Document
  - approval and security, 2-1
- Document Approval
  - approval button, 2-19
  - Approve button, 2-20
- Document Approval Status Rules, 2-21
- Document Builder in AutoCreate, using, 6-17
- Document control
  - applicability matrix, 2-49
  - status check matrix, 2-51
  - submission check matrix, 2-53
- Document Control, 2-40
  - options, 2-41
- Document Control Options
  - cancel, 2-42
  - close, close for receiving, close for invoicing, 2-45
  - delete, 2-41
  - final close, 2-43
  - firm, 2-44
  - freeze, 2-44
  - hold, 2-44
- Document Manager Failed notification, 2-31
- Document Reapproval Rules, 4-108
- Document Revision Numbering, 4-103
- Document Revision Rules, 4-104
- Documents
  - access level, 2-8
  - approval process overview, 2-19
  - approval routing, 2-10
  - approval status checks, 2-21
  - approval submission checks, 2-22
  - authorization rules, 2-12
  - control, 2-40
  - hierarchy security, 2-7
  - placing purchase orders in the Navigator, 4-9
  - placing requisitions in the Navigator, 3-5
  - private security, 2-7
  - public security, 2-7
  - purchasing security, 2-7
  - security and access level matrix, 2-8
  - security and access levels, 2-7
  - security levels, 2-7
  - document sourcing, 5-24, 5-27
    - centralized, 5-26
    - defaults, 5-24

- global or local, 5-25
  - item or item category, 5-25
- Document Styles, 1-73, 7-2
- Document Styles window
  - See* Appendix A
- Document Subtypes
  - defining, 1-68
  - purchase agreement, 1-68
  - purchase order, 1-68
  - quotation, 1-68
  - release, 1-68
  - request for quotation, 1-68
  - requisition, 1-68
- Document Transmission, 2-36
  - E-Mail, 2-37
  - Fax, 2-36
  - Print, 2-36
- Document Types
  - approval processes, 1-71
  - defining, 1-67
  - Multilingual Support, 1-67
  - prerequisites, 1-67
  - window
    - See* Appendix A
  - workflow processes, 1-71
- Do Document Changes Require Reapproval?
  - End, E-155
- Do Document Changes Require Reapproval?
  - subprocess activities
    - Determine Document Type, E-155
    - Does the Blanket PO Require Reapproval?, E-155
    - Does the Blanket Release Require Reapproval?, E-155
    - Does the Contract PO Require Reapproval?, E-155
    - Does the Planned PO Require Reapproval?, E-155
    - Does the Scheduled Release Require Reapproval?, E-155
    - Does the Standard PO Require Reapproval?, E-155
    - Start, E-154
- Do Document Changes Require Reapproval?
  - subprocess overview, E-154
- Does Req Line Have Enough Information To Automatically Create A Document? process, E-

- 178, E-178
- Does Req Line Have Valid Source Document Information?, E-179
- Drilling down from GL
  - customizing windows, 9-63
- drop shipments, 9-15
- Drop shipments, 4-114

## **E**

---

- E&C Industry, 12-1
- Early/late receipt tolerance
  - setup, 9-9
- EDI integration
  - price sales catalogs, 5-19
- EDI purchase order, 1-78
- Electronic Signatures
  - inspections, 9-41
- E-mailed purchase order, 1-77
- Emergency requisitions, 6-8
- Employees
  - assigning to jobs or positions, 2-18
- encumbrance
  - requisitions, 3-8
- Encumbrance
  - in Approve Document window, 2-33
  - purchase orders and requisitions, 4-113
  - Terms and Conditions window, 4-65
- Encumbrance Detail report, 11-15
- Enforce Buyer Name
  - options setup, 1-37
- Enforce ship-to location
  - setup, 9-8
- Enforce Ship-To Location
  - option setup, 1-43
- Enforce Supplier Hold
  - options setup, 1-38
- Engineering and Construction Industry, 12-1
- Enter Person
  - window, 2-18
- E-records
  - Oracle Purchasing, F-2
  - overview, F-1
  - viewing, F-3
- eSignature, 4-84
- E-signatures
  - Oracle Purchasing, F-2

- overview, F-1
  - viewing, F-3
  - Euro
    - currency rate type in Currency window, 4-60
    - currency Rate Type in New Document window, 6-17
    - currency rate type in Requisition Preferences window, 3-45
    - currency rate type in Requisitions window, 3-56
    - rate type options setup, 1-39
  - Exceeded Price Tolerances window, 5-21
  - exchange rate
    - in Corrections Window, 9-79
    - in Receiving Transactions Window, 9-61
  - Exchange rate
    - entering at time of receipt, 9-33
  - expected receipts
    - finding, 9-25
  - Expected Receipts report, 11-17
  - Expected Receipts Report, 9-85
  - Expense Accrual
    - setup, 9-8
  - Expense AP accrual account
    - setup, 9-8
  - Expense Charge Account Rules, 1-83
    - charge account segment, 1-84
  - Expiring line items, 4-56
  - Express
    - receipts and receiving transactions, 9-23
  - Express Receipts, entering, 9-25
  - Express transactions
    - setup, 9-8
  - Express Transactions
    - option setup, 1-44
  - External Systems, 3-18
- F**
- 
- Facsimile
    - upon approval, 2-36
  - Faxed purchase order, 1-76
  - Fill Employee Hierarchy process, 13-6
  - Financials/Purchasing Options Listing, 11-19
  - Financials Options, 2-2
  - Find Approver subprocess activities
    - Are You Using PO Approval Hierarchies? (for purchase orders), E-127
    - Document Manager Failed (for purchase orders), E-128
    - Does Approver Have Authority? (for purchase orders), E-128
    - End (for purchase orders), E-128
    - Get Approval Path (for purchase orders), E-127
    - Get First Manager in Approval Hierarchy (for purchase orders), E-127
    - Get Forwarding Mode (for purchase orders), E-127
    - Get Next Manager in H.R. (for purchase orders), E-127
    - Is Forward-To Provided? (for purchase orders), E-127
    - Start (for purchase orders), E-127
  - Find Approver subprocess overview (for purchase orders), E-126
  - Find Corrections window
    - Finding Corrections, 9-74
  - Find Expected Receipts window, 9-25
    - entering unordered receipts, 9-36
  - Finding Purchase Orders, 4-23
  - Finding Requisitions, 3-36
    - clear existing search criteria, 3-38
    - enter a new requisition, 3-38
  - Find In-Transit Shipments window
    - Finding In-Transit Shipments, 9-80
  - Find Purchase Orders window, 4-23
  - Find Quotations window, 5-75
  - Find Receiving Transactions window, 9-56
  - Find Requisition Lines window, 5-83
  - Find Requisitions window
    - Finding Requisitions, 3-36
  - Find Returns window, 9-68
  - Fixed Price-Based Purchasing, 1-60
  - Forms
    - Enter Purchase Orders, 6-9
  - Forward
    - in Approve Document window, 2-34
  - Forward Documents window
    - Mass Forwarding Documents, 2-39
  - Forward Method
    - defining, 1-71
  - Forward PO subprocess activities
    - Document Manager Failed, E-130

- End, E-130
- Forward PO with Status "In-Process", E-129
- Forward PO with Status "Pre-Approved", E-129
- Get PO Attributes, E-129
- Is PO Pre-Approved?, E-129
- Start, E-129
- Forward PO subprocess overview, E-128
- Freeze
  - purchase orders, 4-8
- Full lot quantities
  - enforcement options, 1-35
- Function Security, D-1
- Funds checking
  - purchase orders, 4-5
  - requisitions, 3-4
- funds reservation
  - requisitions, 3-8
- Funds reservation
  - approvals, 2-33
  - changing reserved/unreserved documents, 4-113

## G

---

- Gapless Invoice Numbering
  - enable option, 1-38
  - SBI Buying Company Identifier, 1-36
- Generate Accounts Using FlexBuilder Rules
  - process overview, E-49
- Generate Default Accounts Process, E-37
- Generate Default Accounts process activities
  - Accrual Account For Expense Item, E-40
  - Accrual Account From Organization, E-40
  - Build Inventory Charge Account, E-40
  - End, E-205
  - Expense Account, E-40
  - Get Budget Account From Item/Sub, E-40
  - Get Charge Account, E-40
  - Get Item Level Budget Account, E-40
  - Get Org Level Budget Account, E-40
  - Is Charge Account CCID Null?, E-41
  - Item Under Budgetary Control?, E-41
  - Job WIP Account, E-41
  - PO Accrual Acc Flexbuilder Upgrade, E-41
  - PO Budget Acc Flexbuilder Upgrade, E-41
  - PO Charge Acc Flexbuilder Upgrade, E-41

- PO Project-Related?, E-42
- PO Requisition Accrual Acc Flexbuilder Upgrade, E-41
- PO Requisition Budget Acc Flexbuilder Upgrade, E-41
- PO Requisition Charge Acc Flexbuilder Upgrade, E-42
- PO Requisition Variance Acc Flexbuilder Upgrade, E-42
- PO Variance Flexbuilder Upgrade, E-42
- Requisition Project-Related?, E-42
- Schedule Account, E-42
- Set Encoded Error Message, E-43
- Type of WIP, E-42
- Variance Account From Organization, E-42
- Work Item Destination Type, E-42
- Generate Default Accrual Account subprocess overview, E-43
- Generate Default Budget Account subprocess overview, E-43
- Generate Default Charge Account subprocess overview, E-44
- Generate Default Variance Account subprocess overview, E-44
- Generate Sourcing Rules and ASLs from Blanket Agreements, 13-6
- Get All Blanket PO Changes subprocess activities
  - End, E-149
  - Get Header Changes, E-149
  - Get Lines Changes, E-149
  - Start, E-149
- Get All Blanket PO Changes subprocess overview, E-149
- Get All Contract PO Changes subprocess activities
  - End, E-150, E-152
  - Get Header Changes, E-150
  - Start, E-150
- Get All Contract PO Changes subprocess overview, E-150
- Get All Document Changes subprocess activities
  - Determine Document Type, E-148
  - End, E-148
  - Start, E-148
- Get All Document Changes subprocess overview, E-147
- Get All Planned PO Changes subprocess

- activities
  - End, E-151
  - Get Distribution Changes, E-151
  - Get Header Changes, E-151
  - Get Lines Changes, E-151
  - Get Shipments Changes, E-151
  - Start, E-151
- Get All Planned PO Changes subprocess overview, E-150
- Get All Release Changes subprocess activities
  - Get Distribution Changes, E-152
  - Get Release Changes, E-152
  - Get Shipments Changes, E-152
  - Start, E-152
- Get All Release Changes subprocess overview, E-152
- Get All Standard PO Changes subprocess activities
  - End, E-154
  - Get Distribution Changes, E-153
  - Get Header Changes, E-153
  - Get Lines Changes, E-153
  - Get Shipments Changes, E-153
  - Start, E-153
- Get All Standard PO Changes subprocess overview, E-153
- Get Charge Account for Variance Account subprocess overview, E-48
- Get Variance Account from Organization subprocess overview, E-48
- Global Agreement
  - enable organizations, 4-56
- global agreements, 4-2
- Global Agreements, 4-120
  - Center-Led Procurement, 1-79
  - setup, 1-80
- Global Buyer
  - setup, 1-81
- Global Contract Purchase Agreements, 4-3
- Global Requester
  - setup, 1-81
- Global Supervisor
  - setup, 1-81

## H

---

Hazard Classes

- defining, 1-53
- Multilingual Support, 1-53
- window
  - See* Appendix A
- Hazardous Materials
  - overview, 1-50
  - regulation background, 1-50
    - hazard class, 1-51
    - identification number, 1-51
    - labels required, 1-52
    - packaging requirements, 1-52
    - shipping name, 1-50
    - shipping requirements, 1-52

## I

---

- Import Price Catalogs, 13-8
- Import Standard Purchase Orders, 13-11
- Include In Next RFQ Printing, 5-56
- Include Non-Catalog Requests
  - defining, 1-70
- Information Template
  - iProcurement, 1-89
- inspecting received items, 9-65
- Inspection, 9-63
- Inspection Details window, 9-65
- Integration with Landed Cost Management, 9-121
- Internal requisitions
  - demand for, 3-16
  - overview, 3-13
  - shipping execution, 3-26
  - updating intransit information, 3-22
  - viewing status of, 3-22
- Internal Requisitions
  - approval, 3-18
  - approvals and controls, 3-15
  - business example, 3-31
  - cancellation of requisitions, 3-16
  - cancelling, 3-22
  - complete item sourcing definition, 3-13
  - complete requisitions status visibility, 3-15
  - creating online requisitions, 3-14
  - creation of internal sales orders, 3-15
  - exception processing, 3-15
  - external systems, 3-18
  - flexible processing, 3-14

- full unit of issue enforcement, 3-14
- internal sales orders, 3-19, 3-20
- inter-organization shipping network, 3-14
- inventory replenishment requisitions, 3-14
- inventory setup, 3-28
- Kanban replenishments, 3-17
- management, 3-22
- MRP generated requisitions, 3-15
- online processing automation, 3-30
- order management, 3-15
- Order Management, 3-25
- processing summary, 3-23
- purchasing setup, 3-27
- setup, 3-24
- Internal Requisitions/Deliveries Discrepancy report, 11-20
- Internal Requisition Status Report, 11-19
- internal sales orders, 3-19
- Internal Sales Orders
  - across operating units, 3-19
  - management, 3-20
  - pick release, 3-21
  - ship confirmation, 3-21
- intransit shipments
  - finding, 9-80
- Intrastat, 9-6
- inventory accruals
  - setting up, 9-89
- Inventory Replenishment Requests, 3-16
- Invoice Close % Tolerance
  - setup, 9-7
- Invoice Close Tolerance percentage
  - option setup, 1-38
- Invoice exchange rate variances, 9-99
- Invoice match approval
  - setup, 9-7
- Invoice Matching
  - option setup, 1-39
- Invoice Price Variance by Vendor, 11-22
- Invoice Price Variance report, 11-21
- Invoices, finding, 13-19
- iProcurement
  - requisitions and AutoCreate, 6-8
- Item Description
  - update options setup, 1-37
- Item Detail Listing, 11-24
- Items

- last price history, 5-3
- purchase history, 5-3
- Item Source
  - iProcurement, 1-89
- Item Summary Listing, 11-25
- Item type attributes
  - Catalog Price Tolerances Exceeded workflow, E-210
- item types
  - Account Generator, E-30
- Item types
  - Catalog Price Tolerances Exceeded workflow, E-210
  - Debit Memo Notification, E-214
  - PO Approval, E-95
  - PO Confirm Receipts, E-188
  - PO Create Documents, E-167
  - PO Requisition Approval, E-56
  - PO Send Notifications for Purchasing Documents, E-199

## J

---

- Job and Category Association, 1-92
  - define associations, 1-92
- Journal Entry Batches in General Ledger, 9-108

## K

---

- Kanban
  - replenishments, 3-17
- Kanban replenishment request
  - receiving purchase order for, 9-5

## L

---

- Landed Cost Management, 9-121
- Landed Cost Management and Purchasing, 12-4
- Landed Cost Simulation, 12-5
- Last Price History
  - definition, 5-3
- Line Type
  - default for documents, 1-39
- Line Types, 1-59
  - defining, 1-62
  - in document style, 1-74
  - Multilingual Support, 1-63
- Line Types window

- Defining Line Types
  - See Appendix A
- Location Listing, 11-25
- Locations
  - receiving, 9-6
  - setup, 1-18
  - window
    - See Appendix A
- Lookup Codes
  - 1099 Supplier Exception, 1-57
  - acceptance type, 1-57
  - defining, 1-55
  - freight terms, 1-57
  - minority group, 1-57
  - Multilingual Support, 1-56
  - pay group, 1-57
  - PO/Requisition Reason, 1-57
  - price type, 1-57
  - quotation approval reason, 1-57
  - reply/receive via, 1-57
  - supplier type, 1-57
  - window
    - See Appendix A
- Lot numbers, 9-84

## **M**

---

- Main Requisition Approval process activities
  - Can Owner Approve?, E-64
  - Get AutoCreate PO Mode, E-67
  - Is Requisition Pre-Approved?, E-75
  - Launch Create PO Workflow, E-67
  - Wait for Background Process, E-67
- Manage Shipments window, 9-82
- Managing Requisitions, 3-9
- MassCancel
  - defining, 2-61
  - delete MassCancel batch, 2-68
  - run MassCancel, 2-68
- MassCancel, running, 2-67
- Mass Close of Purchasing Documents, 13-16
- Mass Forwarding Documents, 2-39
  - change original approver, 2-40
  - view action history, 2-40
- Mass Update of Purchasing Documents, 13-13
- Mass Update of Requisitions, 13-15
- Matching Holds by Buyer report, 11-27

- Matching Unordered Receipts, 9-36
- Match Unordered Receipts
  - Matching Unordered Receipts, 9-37
- Menu paths, A-1
- Minimum Release Amount
  - option setup, 1-40
- Miscellaneous Accrual Reconciliation Report, 11-28
- Miscellaneous Accrual Write-Offs, 9-117
- Modify Lines window, 6-19
- Movement statistics, 9-6
- MRP Generated Requisitions, 3-18
- Multilingual support
  - Printed purchase orders, 8-4
- Multilingual Support
  - Document Types window, 1-67
  - Hazard Classes window, 1-53
  - Line Types window, 1-63
  - Oracle Purchasing Lookups window, 1-56
  - UN Numbers window, 1-54
- Multiple Distributions, 9-22
- Multiple Receiving Organizations
  - Centralized Purchasing in, 9-5

## **N**

---

- Naming conventions
  - PL/SQL stored procedures in the PO Catalog
  - Price Exceeded Tolerances workflow, E-211
- Navigator
  - placing purchase orders in, 4-9
  - requisitions, 3-5
- Navigator paths, A-1
- New Document Number window, 6-16
- New Vendor Letter report, 11-30
- Notes, 1-26, 5-3
  - brief, 1-27
- Notification Controls window, 4-80
- Notifications
  - MRP reschedules, 2-30
  - viewing and responding to (overview), 2-29
- Notifications Summary window, 2-29
- Notify Approver subprocess activities
  - Approve PO Notification, E-124
  - Approve Requisition Notification, E-79
  - End (for purchase orders), E-126
  - Is Forward-To Valid, E-79

- Is Forward-To Valid? (for purchase orders), E-125
- PO Approval Reminder 1, E-125
- PO Approval Reminder 2, E-125
- Requisition Approval Reminder1, E-79
- Requisition Approval Reminder 2, E-79
- Set Forward-To/From App. & Fwd. Action (for purchase orders), E-125
- Set Forward-To/From For Approve Action (for purchase orders), E-125
- Set Forward-To/From For Timeout (for purchase orders), E-125
- Start (for purchase orders), E-124
- Notify Approver subprocess overview (for purchase orders), E-124
- Notify Requester subprocess activities
  - End, E-195
  - Notify Requester of Confirm Receipt - first reminder, E-195
  - Notify Requester of Confirm Receipt - initial notice, E-195
  - Notify Requester of Confirm Receipt - second reminder, E-195
- Notify Requester subprocess overview, E-194

## O

---

- Off-line approver, 2-3
- Offline Approvers, 2-38
- On-line approver, 2-3
- Open Purchase Orders By Buyer report, 11-31
- Open Purchase Orders by Cost Center report, 11-32
- Oracle Alert
  - use in Purchasing, B-1
- Oracle E-Business Tax, 4-116
- Oracle E-Records, F-1
- Oracle iProcurement, 1-89
- Oracle iSupplier Portal, 8-3
- Oracle Procurement Contracts, 4-9
  - author contract terms, 4-65
  - copy documents, 4-102
  - enter contract terms, 4-64
  - manage contract documents, 4-65
  - update deliverable status, 4-65
  - view contract terms, 4-65
- Oracle Purchasing

- Account Generator setup, E-6
- Oracle Purchasing Lookups, 1-55
- Oracle Quality
  - receiving transactions, 9-58
- Oracle Services Procurement, 6-14
  - automatic sourcing, 5-27
- Oracle Sourcing, 4-9
- Order Pad Options, 5-16
- Order Source default
  - setup for internal requisitions, 1-38
- Order Type default
  - setup for internal requisitions, 1-38
- outside processing information, 4-79
- Outside Processing Line Types, 1-60
- Outside Processing window, 4-79
- Overall Document Creation / Launch Approval process activities
  - End, E-174
  - Group Req Lines Into Purchase Orders Or Releases, E-173
  - Is Automatic Creation Allowed?, E-173
  - Is This An Emergency Requisition?, E-173
  - Launch Process To Create/Approve PO Or Release, E-174
  - Launch Process to Verify Req Line Information, E-173
  - Put All Requisition Lines On A Purchase Order, E-173
  - Remove Processed Req Lines From Temp Table, E-174
  - Start, E-172
  - Wait For Flow, E-173
- Overall Document Creation / Launch Approval process overview, E-171
- Overdue Vendor Shipments report, 11-33
- Overreceipt tolerance
  - setup, 9-9
- Over Receipt Tolerance percentage
  - option setup, 1-44
- Overshipments report, 11-34
- Overview of Requisitions, 3-1
- Owner Can Approve
  - defining, 1-69

## P

---

- Payment on Receipt process, 13-16



- Pay When Paid, 12-1
- P-Card, 4-118
- PDF, 8-3
- PDF purchase order, 1-78
- period end
  - Accrual Process, 9-104
  - Receipts Accruals-Period End, 9-104
- Period End
  - Period End Checklist, 9-100
  - Reset Period End Accrual Flag, 13-32
- Period-End reconciliation tasks, 9-100
- Period Status
  - closed, 1-83
  - future, 1-83
  - never opened, 1-83
  - open, 1-83
  - permanently closed, 1-83
- perpetual accruals
  - receipt accrual process, 9-94
- PL/SQL Error Occurs, E-108
- PL/SQL stored procedures
  - Generate Default Accounts process, E-39
  - PO Approval process, E-109
  - PO Approval Top Process, E-104
  - PO Document Approval Reminder process, E-203
  - workflow naming conventions, E-211
- Placing requisitions in the Navigator, 3-5
- Planned Purchase Orders, 4-3
- Planning active, 5-32
- Planning constraints
  - overview, 5-26
- PO Approval Error workflow, E-217
  - customize, E-218
  - item type, E-221
  - summary, E-221
- PO Approval Process activities
  - Can Owner Approve?, E-109
  - End, E-112
  - Is Forward-To Provided?, E-109
  - Is PO Pre-Approved?, E-110
  - PO Approved, E-111
  - PO Rejected, E-110
  - Start, E-109
- PO Approval Process workflow
  - activities, E-109, E-118
  - Approve and Forward PO, E-121, E-122, E-124
  - Change Order, E-133
  - Find Approver, E-126, E-127
  - Forward PO, E-128, E-129
  - Notify Approver, E-124
  - Print, Fax, and Email, E-120, E-120
  - Reject PO, E-131, E-132
  - Reserve Before Approve, E-114, E-114
  - Return PO to Submitter, E-130, E-130
  - summary, E-108, E-117
  - Verify Approval Authority, E-116, E-116
  - Verify PO, E-112, E-112
- PO Approval Top Process activities
  - Get PO Attributes, E-106
  - Get Workflow Approval Mode, E-105
  - Is Archive on Approval Flag Set to Yes?, E-106
  - Is Change Initiated from Web Suppliers?, E-106
  - Is This a New Document?, E-106
  - PO Approved, E-107
  - Remove All Notifications For This Doc, E-105
  - Set PO Status to "In Process", E-105
  - Set Workflow Startup Values, E-105
  - Start, E-105
  - Update PO Header with Workflow Key, E-105
  - Wait for Background Process, E-106
- PO Approval Top Process overview, E-103
- PO Approval workflow, E-89
  - activities, E-104
  - customizing, E-90
  - item type, E-95
  - top process, E-103
- PO Change History, 10-3
- PO Create Documents workflow, E-161
  - Activities, E-172
  - Create and Approve, E-179
  - Create and Approve Activities, E-180
  - customize, E-162
  - Get Buyer, E-181
  - Get Buyer Activities, E-181
  - item type, E-167
  - summary, E-171
  - Verify Req Line, E-174, E-176, E-178
  - Verify Req Line Activities, E-178
  - Workflow Monitor, E-182
- PO Document Approval Reminder process
  - activities
    - Approve Purchase Order Release Reminder

- Notification, E-205
- Approve Purchase Order Reminder Notification, E-205
- Approve Requisition Reminder Notification, E-205
- Compare Text, E-204
- Is Forward to Valid, E-205
- Noop, E-205
- PO Acceptance Past Due Notification, E-205
- PO Acceptance Required Notification, E-205
- Quotation Near Expiration Notification, E-204
- Quotation Requires Completion Notification, E-204
- Release Acceptance Past Due Notification, E-204
- Release Acceptance Required Notification, E-204
- RFQ Near Expiration Notification, E-204
- RFQ Requires Completion Notification, E-204
- Set Document Type, E-204
- Start, E-203
- Start Document Approval, E-205
- PO Document Approval Reminder process overview, E-202
- POERROR, E-217
- PO Lines with No Source Document:, 7-24
- PO Output for Communication, 13-23
- PO Output Format
  - options setup, 1-36
- PO Send Notifications for Purchasing Documents, E-195
- PO Send Notifications Workflow, E-195
  - Activities, E-203
  - customize, E-195
  - item types, E-199
  - overview, E-202
- Position Hierarchies
  - setting up, 2-6
  - uses, 2-6
- Pre-Approved
  - document, 2-21
- Price/Sales Catalog Notification Workflow, E-206
  - activities, E-211
  - Customizing, E-208
  - item types, E-210
  - summary, E-210
  - price break information, 4-73
- Price Break Type
  - option setup, 1-39
- Price Break window, 4-74
- Price Tolerance
  - options setup, 1-34
- Price Type
  - option setup, 1-40
- Price Update Tolerance, 5-20
- price variances
  - monitoring, 9-101
- Pricing Transparency, 7-23, 12-6
- Print
  - purchase orders, 4-6
- Print Document Process (Change Order) overview, E-160
- Print Document subprocess activities
  - Does User Want Document Printed, E-88
  - Does User Want Document Printed? (for change orders), E-161
  - Does User Want Document Printed? (for purchase orders), E-121
  - End, E-88
  - End (for change orders), E-161
  - End (for purchase orders), E-121
  - Print Document, E-88
  - Print Document (for change orders), E-161
  - Print Document (for purchase orders), E-121
  - Start, E-88
  - Start (for change orders), E-161
  - Start (for purchase orders), E-120
- Print Document subprocess overview, E-87
- Print Document subprocess overview (for purchase orders), E-120
- Printed Change Orders (Landscape) report, 11-35
- Printed Change Orders (Portrait) report, 11-37
- Printed purchase order, 1-76
- Printed Purchase Order, overview, 8-3
- Printed Purchase Order (Landscape) report, 11-39
- Printed Purchase Order (Portrait) report, 11-42
- Printed Requisitions report, 11-46
- Printed RFQ (Landscape) report, 11-44
- Printed RFQ (Portrait) report, 11-45
- Processes
  - Accrual Reconciliation Load, 13-1
  - ASL Upgrade, 13-2
  - Confirm Receipts Workflow Select Orders, 13-

3

- Create Internal Sales Orders, 13-4
- Create Releases, 13-5
- Fill Employee Hierarchy, 13-6
- Generate Sourcing Rules and ASLs from Blanket Agreements, 13-6
- Import Price Catalogs, 13-8
- Import Standard Purchase Orders, 13-11
- overall document creation, E-171
- Payment on Receipt, 13-16
- Purchasing Database Administration, 13-24
- Purge Purchasing Open Interface Processed Data, 11-59
- Receipt Accruals - Period End, 9-104, 13-25
- Receiving Transaction Processor, 13-28
- Requisition Import, 13-29
- Reschedule Requisitions, 13-33
- Reset Period End Accrual Flags, 13-32
- Retrieve Time from Oracle Time and Labor, 13-34
- Retroactive Price Update on Purchasing Documents, 13-34
- Send Notifications for Purchasing Documents, 13-36
- Workflow Background, 1-88

Processing mode

- setup, 9-9

Process Navigator, E-216

procurement card, 4-118

Procurement Contracts

- in document style, 1-74

Procurement processes workflow, E-216

Procurement Workflows, E-1

- customization guidelines, E-2

profile option categories

- Approvals, C-6
- AutoCreate, C-7
- AutoCreate Security, C-8
- AutoCreate UI, C-9
- Automatic Sourcing, C-11
- Catalog Import, C-11
- Consigned and VMI, C-12
- Create Releases, C-13
- Debug, C-14
- Deployment, C-15
- description, C-5
- Document Builder Security, C-18
- Document Builder UI, C-18
- Document Security, C-19
- Encumbrance, C-21
- Enterprise Asset Management Setup, C-22
- iProcurement Setup, C-23
- Notifications, C-23
- Notifications UI, C-24
- overview, C-1
- PO/Releases/Requisitions UI, C-26
- PO Communication, C-24
- Procurement Contracts Setup, C-27
- Receiving, C-28
- Requisition Import, C-29
- Self-Billing, C-30
- Services Procurement Setup, C-31
- Sourcing Setup, C-31
- Supplier Item Catalog Forms UI, C-32

profile options

- descriptions, C-5
- overview, C-1

project information

- purchase order Distributions window, 4-78

Project information

- in Purchase Order Preferences window, 4-40
- in Quotations window, 5-68
- in quotation when copying from RFQ, 5-74
- in Requisition Preferences window, 3-46
- in RFQs window, 5-54
- release distributions, 4-96
- requisition Distributions window, 3-60

Project Manufacturing

- release distributions, 4-96

Project Manufacturing information

- in purchase order Distributions window, 4-78
- requisition Distributions window, 3-60

Purchase Agreement Audit report, 11-47

purchase agreement header information

- entering, 4-55

purchase agreement line information

- entering, 4-55

purchase agreement price breaks, 4-74

Purchase Agreements

- global, 4-56
- notification controls, 4-80
- price breaks, 4-73
- terms, 4-64

Purchase History

- definition, 5-3
- purchase order acceptances, 4-82
- Purchase Order and Releases Detail report, 11-52
- Purchase Order Commitment report, 11-48
- Purchase Order Communication, 8-1
  - EDI delivery, 8-3
  - E-mailed, 8-2
  - faxed, 8-2
  - online viewing, 8-3
  - printed, 8-2
  - setup, 1-75
  - XML delivery, 8-3
- Purchase Order Defaulting Rules, 4-10
- Purchase Order Detail report, 11-49
- Purchase Order Details, 4-61
- Purchase Order Distribution Detail report, 11-51
- purchase order distributions, 4-75
- Purchase Order Distributions window, 4-35
- Purchase Order Features, 4-4
- Purchase Order Headers
  - entering, 4-40
- Purchase Order Headers window, 4-26
  - Using the Purchase Order Headers Results window, 4-27
- purchase order lines
  - entering, 4-46
- Purchase order lines
  - using line types, 1-62
- Purchase Order Lines
  - summary window, 4-30
- Purchase Order Lines window, 4-30
- purchase order miscellaneous information, 4-53
- purchase order notification controls, 4-80
- Purchase order numbers
  - entry method setup, 1-41
  - entry type setup, 1-41
- Purchase Order Preferences
  - entering, 4-37
- Purchase Order Preferences window, 4-37
- Purchase Order Price Reference Information, 4-50
- Purchase order reference document information, 4-51
- Purchase Orders, 4-1
  - acceptances, 4-5
  - Acceptances, 4-82
  - agreement information, 4-64
  - approval, 4-6
  - archiving, 4-103
  - AutoClose, 4-8
  - blanket purchase agreements, 4-2
  - Buyer's Work Center, 7-10, 7-11
  - cancel, 4-7
  - close, 4-8
  - communicating, 8-1
  - contract purchase agreements, 4-3
  - control matrices, 2-46
  - copying, 4-7
  - currency, 4-60
  - defaulting rules, 4-10
  - Distributions, 4-75
  - EDI delivery, 1-78
  - E-mailed, 1-77
  - encumbrance controls, 4-65
  - faxed, 1-76
  - features, 4-4
  - finding, 4-23
  - freeze, 4-8
  - funds checking, 4-5
  - Global Blanket Purchase Agreements, 4-2
  - global contract purchase agreements, 4-3
  - headers, 4-40
  - hold, 4-8
  - lines, 4-46
  - line types, 4-6
  - miscellaneous information, 4-53
  - multiple shipments, 4-5
  - notification controls, 4-8
  - Oracle Procurement Contracts, 4-64
  - output format options, 1-36
  - outside services, 4-79
  - overview, 4-1
  - P-Card, 4-118
  - PDF, 1-78
  - placing in the Navigator for easy access, 4-9
  - planned purchase orders, 4-3
  - preferences, 4-37
  - price reference, 4-50
  - pricing, 4-6
  - print, 4-6
  - printed, 1-76, 8-3
  - purchase agreement, 4-73
  - receipt accruals, 9-120
  - receiving controls, 4-71

- reference documents, 4-51
  - release generation, automatic, 4-96
  - Releases, 4-84
  - reserve and unreserve, 4-113
  - revision, 4-5
  - revisions, 4-103
  - services, 1-66
  - Shipments, 4-67
  - standard costing
    - receipt to expense destinations, 9-98
    - receipt to inventory, 9-97
    - receipt to receiving inspection, 9-95
  - standard purchase orders, 4-2
  - styles, 1-73
  - taxes, 4-116
  - tax information at distribution level, 4-78
  - temporary labor, 4-58
  - terms, 4-55
  - Terms and Conditions, 4-61
  - types, 4-2
  - viewing changes, 4-9
  - viewing changes to, 10-3
  - XML delivery, 1-78
  - purchase order shipments, 4-67
  - Purchase Order Shipments window, 4-32
    - Using the Purchase Order Shipments Results Window, 4-33
  - Purchase Order Summary
    - distributions, 4-35
    - headers, 4-26
    - lines, 4-30
    - shipments, 4-32
  - Purchase Orders window, 4-40
    - Agreement tab, 4-55
    - Enable Organizations, 4-56
    - Lines tab, 4-46
    - More tab, 4-53
    - Price Reference tab, 4-50
    - Reference Document tab, 4-51
    - Temporary Labor tab, 4-58
    - Terms button, 4-55
  - Purchase Order Temporary Labor, entering, 4-58
  - Purchase Price Variance report, 11-53
  - Purchase Requisition Status report, 11-54
  - Purchase Summary by Category report, 11-55
  - Purchasing
    - e-records and e-signatures, F-2
    - Purchasing Accounting Lines window, 9-62
    - Purchasing Activity Register, 11-56
    - Purchasing Database Administration, 13-24
    - Purchasing Documents Open Interface, 5-18, 5-44
      - See* Import Price Catalogs, Import Standard Purchase Orders
      - monitoring supplier price increases, 5-21
      - price tolerance, 5-20
      - Purchasing Interface Errors Report, 11-57
      - sourcing, 5-19
    - Purchasing Documents Open Interface (PDOI)
      - Import Price Catalogs, 13-8
      - Import Standard Purchase Orders, 13-11
    - Purchasing Interface Errors Report, 11-57
    - Purchasing Options, 1-33
      - defining, 1-33
      - document control options, 1-34
      - document default options, 1-38
      - document numbering options, 1-41
      - internal requisition options, 1-38
      - numbering options in a Multi-Org setup, 1-42
      - receipt accounting options, 1-40
      - window
        - See* Appendix A
    - Purchasing Periods
      - controlling, 1-82
      - Controlling Purchasing Periods window, 1-82
      - prerequisites, 1-82
    - Purchasing Receiving Accounting Lines window, 9-63
    - Purchasing Services, 1-65
    - Purge Purchasing Open Interface Processed Data process, 11-59
- Q**
- 
- Quality Code Listing, 11-59
  - Quality Inspection Codes, 1-57
    - quality code, 1-58
    - ranking number, 1-58
    - window
      - See* Appendix A
  - Quality results
    - entering (overview), 9-40
    - entering in Receiving Transactions window, 9-58
  - Quantity-Based Purchasing, 1-60

- Quotation Action Required report, 11-60
- Quotation Class
  - defining, 1-69
- Quotation Headers, 5-62
- Quotation lines
  - using line types, 1-62
- Quotation Lines, 5-66
- Quotation numbers
  - entry method setup, 1-41
  - entry type setup, 1-41
- Quotation Price Breaks, 5-72
- Quotation Price Breaks window
  - Entering Quotation Price Break Information, 5-72
- Quotations, 5-4, 5-62
  - approving, 5-75
  - approving entire, 5-79
  - approving shipments, 5-77
  - autocreating, 5-3
  - copying from RFQs, 5-74
  - finding, 5-75
  - headers, 5-62
  - Lines, 5-66
  - numbering options, 5-2
  - Price Breaks, 5-72
  - purchase orders, 5-4
  - requisitions, 5-5
  - Shipments, 5-70
  - terms and conditions, 5-69
  - types, 5-5
  - warning delay default, 1-39
- Quotation Shipments, 5-70
  - approving, 5-77
- Quotation Shipments window
  - entering quotation shipment information, 5-70
- Quotations window
  - Entering Quotation Headers, 5-63
  - Entering Quotation Lines, 5-66
- Quotation Terms, 5-69
- Quotation Terms window
  - Entering Quotation Terms Information, 5-69
- Quote warning delay
  - option setup, 1-39

## R

---

- Rate-Based Purchasing , 1-60

- Realms
  - iProcurement, 1-89
- Reassign
  - through Notifications Summary window, 2-29
- receipt accounting
  - overview, 9-86
- Receipt accounting
  - viewing from receiving transaction, 9-47
- Receipt Accruals - Period End process, 9-104, 13-25
- Receipt Adjustments Report, 11-61
- Receipt Close % Tolerance
  - setup, 9-7
- Receipt close point
  - setup, 9-8
- Receipt Close Point
  - option setup, 1-35
- Receipt Close Tolerance percentage
  - option setup, 1-38
- Receipt Days Early/Late
  - option setup, 1-44
- Receipt Days Exceed
  - option setup, 1-44
- receipt exchange information
  - in Corrections window, 9-79
  - in Receiving Transactions window, 9-61
- Receipt exchange information
  - entering, 9-33
- Receipt Header Details window, 9-50
- Receipt Header Details window, using, 9-50
- Receipt Headers, 9-29
- Receipt Header window, 9-29
- Receipt-invoice matching
  - ASNs, 9-16
  - with Payment on Receipt, 13-18
- Receipt Lines, 9-30
- Receipt numbering
  - alphanumeric or numeric, 9-8
  - automatic or manual, 9-8
  - option setup, 1-45
- Receipt Routing
  - option setup, 1-44
- Receipt routing, default
  - setup, 9-9
- Receipt routing override
  - setup, 9-9
- Receipts

- cascade, 9-23
  - express, 9-23
  - Receipt Traveler, 9-86
  - Substitute Receipts Report, 11-81
- Receipts window
  - enter express receipts, 9-25
  - Entering exchange rate information, 9-33
  - entering receipt lines, 9-30
- Receipt Tolerances, 9-12
- Receipt Traveler, 11-63
- Receipt Traveler, automatic print
  - setup, 9-9
- Receipt Travelers, 9-86
- Receiving, 9-1
  - accounting, 9-86
  - accounting details, 9-61
  - accounting lines, 9-47
  - accounting offsets, 9-120
  - accrual write-offs, 9-111
  - accrue un-invoiced receipts, 9-3
  - AP accrual accounts, 9-102
  - blind receiving, 9-1
  - Cascade, 9-2
  - closed for invoicing, 9-3
  - closed for receiving, 9-3
  - control numbers, 9-4, 9-83
  - corrections, 9-73, 9-78
  - corrections, finding, 9-74
  - Express Receipt, 9-1
  - find expected receipts, 9-25
  - find transactions, 9-55
  - hazardous materials, 9-3
  - headers summary, 9-44
  - inspecting received items, 9-65
  - inspection, 9-4
  - inspections, 9-63
  - intransit shipments, 9-80
  - inventory accruals, 9-89
  - journal entries, 9-108
  - locator, 9-4
  - managing receipts, 9-21
  - match approval levels, 9-2
  - matching unordered receipts, 9-36
  - multiple distributions, 9-22
  - overview, 9-1
  - period-end accruals, 9-104
  - perpetual accruals, 9-94
  - predefined substitute items, 9-2
  - price variances, 9-101
  - profile options, 9-7
  - quality and destination, 9-4
  - Quality results (overview), 9-40
  - Quality results in Receiving Transactions window, 9-58
  - receipt accruals, 9-120
  - receipt headers, 9-29
  - receipt lines, 9-30
  - Receipt Tolerances, 9-12
  - receiving tolerances, 9-1
  - receiving transactions, 9-39, 9-58
  - reports, 9-85
  - returns, 9-4, 9-13, 9-71
  - Returns, 9-66
  - services and labor, 9-3
  - shipments, 9-81
  - supply information, 9-2
  - transaction status, 9-51
  - transaction summary, 9-41, 9-45
  - transfers of inventory items, 9-3
  - unordered items, 9-2
  - unordered receipts, 9-34, 9-36
  - view transaction status, 9-54
- Receiving account, default
  - setup, 9-9
- Receiving Account Distributions report, 11-64
- Receiving Controls, 9-7
  - purchase order, 4-71
- Receiving Controls window, 4-71
- Receiving Corrections window, 9-78
- Receiving Exceptions report, 11-66
- Receiving Headers Summary window, using, 9-44
- Receiving Interface Errors Report, 11-67
- Receiving Inventory Account
  - option setup, 1-46
- Receiving Locations, 9-6
- Receiving Open Interface, 9-15
- Receiving Options, 9-7
  - defining, 1-42
  - window
    - See* Appendix A
- Receiving Reports, 9-85
- Receiving Returns, 9-66
- Receiving Returns window, 9-71

- Receiving Transaction Processor, 13-28
- receiving transactions
  - entering, 9-58
  - finding, 9-55
- Receiving Transactions, 9-39
  - cascade, 9-23
  - express, 9-23
- Receiving Transactions Register, 11-68
- Receiving Transactions Summary, 9-41
- Receiving Transactions Summary window
  - Using the Receiving Transactions Summary window, 9-45
- Receiving Transaction Summary window, using, 9-45
- Receiving Transactions window, 9-59
  - currency, 9-61
  - entering Quality results, 9-58
- Receiving Value by Destination Account report, 11-73
- Receiving Value report, 11-70
- Recovery Rate field, 4-116
- Reject PO subprocess activities
  - Document Manager Failed, E-132
  - End, E-132
  - Reject The PO, E-132
  - Start, E-132
  - Unable To Reject Document, E-132
- Reject PO subprocess overview, E-131
- Reject Requisition subprocess activities
  - Document Manager Failed, E-76
  - End, E-76
  - Reject the Requisition, E-76
  - Start, E-76
  - Unable to Reject Document, E-76
- Reject Requisition subprocess overview, E-75
- Release Distributions window
  - More tab, 4-95
- release generation, automatic, 4-96
- Release Headers, 4-84
- Releases, 4-84
  - agreement details, 4-92
  - blanket, 4-3
  - Distributions, 4-93
  - Receiving Controls, 4-92
  - scheduled, 4-3
  - Shipments, 4-87
  - tax information at distribution level, 4-96
  - tax information at shipment level, 4-91
- Release shipments, entering, 4-87
- Releases window
  - Drop Shop tab, 4-92
  - headers, 4-84
  - Item tab, 4-91
  - More tab, 4-90
  - shipments, 4-87
- Reports
  - Accrual Write-Off, 11-1
  - Advanced Shipment Notice Discrepant Receipts, 11-3
  - AP and PO Accrual Reconciliation, 11-4
  - Backordered Internal Requisitions, 11-6
  - Blanket and Planned PO Status, 11-7
  - Buyer's Requisition Action Required, 11-9
  - Buyer Listing, 11-8
  - Cancelled Purchase Order, 11-11
  - Contract Status, 11-12
  - Country of Origin (by Item), 11-13
  - Country of Origin (by Supplier), 11-14
  - Define MassCancel Listing, 2-65
  - Encumbrance Detail, 11-15
  - Expected Receipts Report, 11-17
  - Financials/Purchasing Options Listing, 11-19
  - Internal Requisitions/Deliveries Discrepancy, 11-20
  - Internal Requisition Status Report, 11-19
  - Invoice Price Variance by Vendor, 11-22
  - Invoice Price Variance Report, 11-21
  - Item Detail Listing, 11-24
  - Item Summary Listing, 11-25
  - Location Listing, 11-25
  - Mass Update of Purchasing Documents, 13-13
  - Matching Holds by Buyer, 11-27
  - Miscellaneous Accrual Reconciliation, 11-28
  - New Vendor Letter, 11-30
  - Open Purchase Orders By Buyer, 11-31
  - Open Purchase Orders by Cost Center, 11-32
  - Overdue Vendor Shipments Report, 11-33
  - Overshipments, 11-34
  - PO Output for Communication, 13-23
  - Printed Change Orders (Landscape), 11-35
  - Printed Change Orders (Portrait), 11-37
  - Printed Purchase Order (Landscape), 11-39
  - Printed Purchase Order (Portrait), 11-42
  - Printed Requisitions, 11-46



Printed RFQ (Landscape), 11-44  
 Printed RFQ Report (Portrait), 11-45  
 Purchase Agreement Audit, 11-47  
 Purchase Order and Releases Detail, 11-52  
 Purchase Order Commitment, 11-48  
 Purchase Order Detail, 11-49  
 Purchase Order Distribution Detail, 11-51  
 Purchase Price Variance Report, 11-53  
 Purchase Requisition Status Report, 11-54  
 Purchase Summary by Category, 11-55  
 Purchasing Activity Register, 11-56  
 Purchasing Interface Errors, 11-57  
 Quality Code Listing, 11-59  
 Quotation Action Required, 11-60  
 Receipt Adjustments Report, 11-61  
 Receipt Traveler, 11-63  
 Receiving Account Distributions Report, 11-64  
 Receiving Exceptions Report, 11-66  
 Receiving Transactions Register, 11-68  
 Receiving Value by Destination Account Report, 11-73  
 Receiving Value Report, 11-70  
 ReqExpress Templates Listing, 11-74  
 Requisition Activity Register, 11-74  
 Requisition Distribution Detail, 11-75  
 Requisition Import Exceptions, 11-76  
 Requisitions on Cancelled Sales Orders, 11-77  
 RFQ Action Required, 11-77  
 Run MassCancel Listing, 2-68  
 Savings Analysis (By Buyer), 11-78  
 Savings Analysis (By Category), 11-79  
 Standard Notes Listing, 11-80  
 Substitute Receipts Report, 11-81  
 Summary Accrual Reconciliation, 11-82  
 Suppliers on Hold, 11-89  
 Uninvoiced Receipts, 11-90  
 Unit of Measure Class Listing, 11-92  
 Unit of Measure Listing, 11-92  
 Unordered Receipts, 11-93  
 Vendor Affiliated Structure Listing, 11-83  
 Vendor Price Performance Analysis, 11-84  
 Vendor Purchase Summary, 11-85  
 Vendor Quality Performance Analysis, 11-86  
 Vendor Service Performance Analysis, 11-87  
 Vendor Volume Analysis, 11-89  
 ReqExpress  
   definition, 3-4  
 ReqExpress Templates Listing, 11-74  
 ReqImport  
   definition, 3-5  
 Req Import group by  
   option setup, 1-38  
 Request For Quotation (RFQ), 5-49  
 Requires Reapproval status  
   effect on supply, 2-21  
 Requisition Activity Register, 11-74  
 Requisition Approval workflow, E-50  
   activities, E-63  
   approval list routing, E-74, E-74  
   approve requisition, E-85, E-86  
   approve requisition activities, E-68  
   customize, E-51  
   item types, E-56  
   notify approver subprocess, E-78, E-79  
   print document subprocess, E-87, E-88  
   reject requisition subprocess, E-75, E-76  
   reserve activities, E-71  
   reserve at the start overview, E-71  
   reserve before approve, E-83, E-84  
   response with approve action, E-80, E-80  
   response with approve and forward action, E-81, E-81  
   response with forward action, E-82, E-83  
   response with reject action, E-83, E-83  
   return requisition to submitter, E-77, E-77  
   start of approve requisition, E-67  
   summary of process, E-62  
   verify approval authority, E-72, E-73, E-88, E-89  
   verify requisition activities, E-70  
   verify requisition overview, E-69  
 Requisition Distribution Detail report, 11-75  
 Requisition Distributions, 3-58  
 Requisition Distributions Summary window, 3-42  
   using, 3-43  
 Requisition Headers, 3-48  
   release funds, 3-60  
 Requisition Headers Summary window, 3-39  
   action history, 3-40  
   control requisitions, 3-40  
   distributions, 3-40  
   enter a new requisition, 3-40  
   open for the current line, 3-40

- preferences, 3-40
  - project contracts, 3-42
  - sales orders, 3-40
  - view purchase orders, 3-40
  - view requisition lines, 3-39
- Requisition Import Exceptions report, 11-76
- Requisition Import process, 13-29
- Requisition lines
  - using line types, 1-62
- Requisition Lines, 3-51, 6-9
  - approve requisitions, 3-57
  - assigning, 5-86
  - distributions, 3-56
  - enter line details, 3-56
  - finding for review or assignment, 5-83, 5-83
  - funds check, 3-57
  - line currency information, 3-56
  - line source details, 3-55
  - modify during AutoCreate, 6-19
  - outside processing, 3-56
  - preferences, 3-57
  - Supplier Item Catalog, 3-56
- Requisition Lines Summary window, 3-40
  - purchase orders, 3-42
  - sales orders, 3-42
- Requisition numbers
  - entry method setup, 1-41
  - entry type setup, 1-41
- Requisition Preferences, 3-44
- Requisition Preferences window, 3-44
- Requisitions
  - accounting information, 3-3
  - action history, 10-1
  - approval history, 3-3
  - approvals, 3-4
  - approval status, 3-3
  - assigning to a buyer, 3-10
  - AutoApproval, 3-5
  - cancelling, 3-11
  - defaults, 3-44
  - distribution-level tax, 3-60
  - distributions, 3-58
  - distribution summary, 3-42
  - emergency, 6-8
  - encumbrance, 3-8
  - finally closing, 3-11
  - finding, 3-36
  - foreign currency, 3-10
  - headers, 3-48
  - headers summary, 3-39
  - imported, 3-8
  - imported from iProcurement, 6-8
  - importing from another system, 3-5
  - Internal, 3-7
  - internally sourced, 3-13
  - internal requisition approval, 3-18
  - line-level tax, 3-57
  - lines, 3-51
  - lines summary, 3-40
  - managing, 3-9
  - online entry, 3-3
  - overview, 3-1
  - paper, 3-8
  - paperless system, 3-2
  - placing in the Navigator, 3-5
  - printing, 3-5
  - purchase, 3-7
  - Purchase Requisitions Status report, 11-54
  - quantity rounding, 3-4
  - reserving funds, 3-8
  - resubmission, 3-3
  - returning, 3-10
  - reviewing, 3-9
  - services, 1-65
  - templates, 3-8, 3-61
  - types, 3-6
  - updating, 3-12
  - updating during approval, 3-12
  - updating with Modify, 3-12
- Requisitions cancellation, 3-3
- Requisitions Distributions window, 3-58
- Requisitions on Cancelled Sales Order Report, 11-77
- Requisitions window
  - entering requisition headers, 3-48
  - lines, 3-51
  - requisition templates, 3-61
- Requisition Template
  - copy button, 1-48
  - defining, 1-46
  - window
    - See Appendix A*
- requisition templates, 3-61
- Requisition Types, 3-6

- Requisition window
  - approval actions, 3-50
  - check funds, 3-50
  - open the Supplier Item Catalog, 3-50
  - preferences, 3-50
  - release funds, 3-50
  - taxes, 3-50
- Requisition Template
  - copy lines, 1-48
  - define, 1-47
  - manually add lines, 1-48
  - sourcing information, 1-49
- Reschedule Requisitions process, 13-33
- Reserve at the Start subprocess activities
  - Document Manager Failed, E-72
  - End, E-72
  - Is Encumbrance On and Is Document Not Reserved?, E-72
  - Is Interface Source Req Import, E-72
  - Reserve Document, E-72
  - Start, E-72
- Reserve at the Start subprocess overview, E-71
- Reserve Before Approve subprocess activities
  - Document Manager Failed, E-85
  - Document Manager Failed (for purchase orders), E-115
  - End (for purchase orders), E-116
  - Is Encumbrance On and Is Document Not Reserved?, E-84
  - Is Encumbrance On and Is Document Not Reserved? (for purchase orders), E-115
  - Is Forward-To Valid, E-85
  - Is Forward-To Valid? (for purchase orders), E-115
  - Reject the PO (for purchase orders), E-115
  - Reject the Requisition, E-85
  - Reserve Document, E-84
  - Reserve Document (for purchase orders), E-115
  - Set Forward-To/From For Forward Action (for purchase orders), E-115
  - Set Forward-To/From Forward, E-85
  - Start (for purchase orders), E-115
  - Unable to Reject Document, E-85
  - Unable to Reject Document (for purchase orders), E-116
  - Unable to Reserve Document, E-85
  - Unable To Reserve Document (for purchase orders), E-115
- Reserve Before Approve subprocess overview in the PO Approval workflow, E-114
- Reserve Funds
  - purchase order lines, 4-49
- reserving funds
  - requisitions, 3-8
- Reserving funds
  - changing documents, 4-113
  - through Approve Document window, 2-33
- Reset Period End Accrual Flags, 13-32
- Retrieve Time from Oracle Time and Labor, 13-34
- Retroactive Price Adjustment Account
  - option setup, 1-46
- Retroactive Price Update on Purchasing Documents, 13-34
- Retroactive Pricing, 2-36
- Return Material Authorizations (RMAs), 9-13
- Return PO to Submitter subprocess activities
  - End, E-131
  - Is Submitter Last Approver?, E-131
  - Notify Last Approver Of No Approver Found, E-131
  - Notify Preparer Of No Approver, E-131
  - Set PO Status to Original Status, E-130
  - Start, E-130
- Return PO to Submitter subprocess overview, E-130
- Return Requisition to Submitter subprocess activities
  - End, E-78
  - Is Submitter Last Approver?, E-78
  - Notify Last Approver of No Approver Found, E-78
  - Notify Requestor of No Approver Available, E-77
  - Set Req Status to Original Status, E-77
  - Start, E-77
- Return Requisition to Submitter WF subprocess overview, E-77
- Returns, 9-66
  - finding, 9-68
- Returns, entering, 9-71
- Review
  - requisition approvals, 10-1
- Review Buyer Workload window, 5-85

- Reviewing Requisitions, 3-9
- RFQ
  - requirement, 5-3
- RFQ Action Required report, 11-77
- RFQ lines
  - using line types, 1-62
- RFQ numbers
  - entry method setup, 1-41
  - entry type setup, 1-41
- RFQ Price Break Information, 5-60
- RFQ Price Breaks window
  - Entering RFQ Price Break Information, 5-60
- RFQ required
  - option setup, 1-38
- RFQs, 5-4, 5-49, 5-57
  - autocreating, 5-3
  - entering RFQ headers, 5-50
  - Headers, 5-49
  - lines, 5-53
  - numbering options, 5-2
  - Price Breaks, 5-60
  - RFQ Suppliers window, 5-55
  - Shipments, 5-58
  - supplier list, 5-55
  - supplier lists, 5-3
  - types, 5-5
- RFQ Shipment Information, 5-58
- RFQ Shipments window
  - Entering RFQ Shipment Information, 5-58
- RFQ Supplier Information
  - entering, 5-55
- RFQs window
  - Entering RFQ Lines, 5-53
- RFQ Terms Information
  - terms and conditions, 5-57
- RFQ Terms window
  - Entering RFQ Terms Information, 5-57
- RMA Receipt Routing
  - option setup, 1-44
- RMAs, 9-13
- Routing Control
  - Allow Change to Approval Hierarchy, 2-11
  - Allow Change to Forward-From, 2-11
  - Allow Change to Forward-To, 2-11
  - Approval Hierarchy, 2-12
  - Forwarding Method, 2-11
  - Owner Can Approve, 2-10

- Run MassCancel
  - purchase order, 2-63
  - requisition, 2-63
- Run MassCancel Listing, 2-68
- Run MassCancel window, 2-63

## S

---

- Sample alerts
  - for Oracle Purchasing, B-2
- Savings Analysis (By Buyer) report, 11-78
- Savings Analysis Report (By Category), 11-79
- Scheduled Releases, 4-3
- Search Supplier Item Catalog window
  - Finding Supplier Items, 5-9
- Security Hierarchy
  - options setup, 1-35
- Security Level
  - defining, 1-71
- Security Level Options, 2-7
- Select Accrual Accounts, 9-115
- Self-Billing Invoices, 1-36, 13-21
  - payment on receipt process, 13-19
  - setup, 1-36
- Send Notifications for Purchasing Documents
  - process, 13-36
- Serial numbers, 9-84
- Services
  - matching purchase orders, 1-67
  - purchase orders, 1-66
  - receiving, 1-67
  - requisitions, 1-65
  - sourcing, 1-66
- Services Procurement, 1-90
  - in document style, 1-74
  - Price Differential codes, 1-91, 1-91
  - Retrieve Time and Labor process, 1-91
  - setup, 1-90
  - temp labor line types, 1-91
- Setting Up a Default Line Type, 1-61
- Setup , 1-1
  - checklist, 1-1
  - steps, 1-4
- Shipments
  - manage, 9-81
- Shipments window
  - entering purchase order shipments, 4-67

- source document information, 5-35
- sourcing, 5-2
  - automatic (overview), 5-24
  - automatic (setting up), 5-27
- Sourcing
  - overview, 5-1
  - Purchasing Documents Open Interface, 5-19
- Sourcing Rules
  - assign, 5-33
  - define, 5-30
  - overview, 5-24
  - setting up, 5-27
- Standard costing transactions
  - delivery from receiving inspection to inventory, 9-95
  - matching invoices, 9-99
  - purchase order receipt to expense destinations, 9-98
  - purchase order receipt to inventory, 9-97
  - receipt to receiving inspection, 9-95
  - return to supplier from inventory or expense destinations, 9-100
  - return to supplier from receiving, 9-100
- Standard Notes Listing, 11-80
- Standard Purchase Orders, 4-2
- Standard quotation or RFQ, 5-5
- Start of Approve Requisition subprocess activities
  - Get Requisition Attributes, E-69
  - Get Workflow Approval Mode, E-68
  - Remove All Notifications For This Document, E-68
  - Set Req Status to In-Process and Update with Item Type & Key, E-68
  - Set Workflow Startup Values, E-68
  - Wait for Background Process, E-69
- Stock locators, 9-85
- Styles, 1-73
- Submission Check, 2-22
- Submission Check Rules, 2-23
- Substitute receipts
  - setup, 9-8
- Substitute Receipts
  - option setup, 1-44
- Substitute Receipts Report, 11-81
- Summary Accrual Reconciliation Report, 11-82
- Supplier and Item/Commodity Combination, 5-

- 40
- Supplier Communication , 8-1
- Supplier-Item Attributes
  - define, 5-43
- Supplier-Item Attributes window, 5-43
- Supplier Item Catalog, 3-56, 5-5
  - entering Order Pad Options, 5-16
  - Order Pad, 5-7
  - order pad options, 5-8
  - Order Total, 5-8
  - receiving electronically, 5-18
  - requisitions, 5-16
  - searching, 5-9
  - search window, 5-6
  - Select Price Only, 5-8
  - sourcing regions, 5-6
  - tabbed regions, 5-13
- Supplier Item Catalog window
  - Using the Supplier Item Catalog Alternative Regions, 5-14
- Supplier Lists, 5-3
  - defining, 5-81
  - window, 5-81
- Suppliers
  - defaulting, 5-27
  - holding, 5-3
- Suppliers on Hold report, 11-89
- supplier statuses, 5-37
- Supply Base Management, 5-1

## T

---

- Tax
  - at purchase order distribution level, 4-78
  - at release distribution level, 4-96
  - at release shipment level, 4-91
  - at requisition distribution level, 3-60
  - attributes and rules, 4-116
  - on documents, 4-116
  - overview, 4-116
  - recovery rate, 4-116
  - requisition line level, 3-57
  - view information, 4-117
- Temporary Labor Line Types, 1-61
- Terms and Conditions
  - encumbrance information, 4-65
  - Entering Oracle Procurement Contracts

- Information, 4-64
  - entering purchase agreement information, 4-64
  - window, 4-61
- Transaction Statuses window, 9-51
- Transaction status information
  - finding, 9-51
- Transportation Execution
  - Receipt Option setup, 1-46

## U

---

- Unable to Reserve Document notification, 2-31
- Uninvoiced Receipts report, 11-90
- Unit of Measure Class Listing, 11-92
- Unit of Measure Listing, 11-92
- UN Numbers
  - defining, 1-54
  - Multilingual Support, 1-54
  - window
    - See* Appendix A
- unordered receipts, 9-34
  - matching, 9-36
- Unordered receipts
  - setup, 9-8
- Unordered Receipts
  - option setup, 1-44
- Unordered receipts, entering, 9-36
- Unordered Receipts report, 11-93
- Unreserve
  - purchase orders and requisitions, 4-113
  - through Approve Document window, 2-33
- Updating Requisitions, 3-12
- Usages
  - in attachments, 1-31
- Use Contract Agreements for Auto Sourcing
  - defining, 1-70
- Using View PDF, 7-30

## V

---

- Vendor
  - Volume, 11-85
- Vendor Affiliated Structure Listing, 11-83
- Vendor Price Performance Analysis report, 11-84
- Vendor Purchase Summary report, 11-85
- Vendor Quality Performance Analysis report, 11-86

- Vendor Service Performance Analysis report, 11-87
- Vendor Volume Analysis report, 11-89
- Verify Approval Authority subprocess activities
  - Document Manager Failed, E-73
  - Document Manager Failed (for purchase orders), E-117
  - Does Approver Have Authority?, E-73
  - Does Approver Have Authority? (for purchase orders), E-117
  - End, E-73
  - End (for purchase orders), E-117
  - Start, E-73
  - Start (for purchase orders), E-116
- Verify Approval Authority subprocess overview in the PO Approval workflow, E-116
- Requisition Approval workflow, E-72
- Verify PO subprocess activities
  - Document Failed Correctness Check, E-113
  - Document Failed State Check, E-113
  - Document Manager Failed, E-113
  - Does Document State Allow Approval Action?, E-113
  - End, E-114
  - Is Document Complete?, E-113
  - Open Document State, E-113
  - Record 'Submit' In Action History, E-113
  - Set PO Status to Original Status, E-113
  - Start, E-113
- Verify PO subprocess overview, E-112
- Verify Req Line Info process activities
  - Continue Flow, E-177
  - Does the Req Line Have A One-Time Item?, E-177
  - Does This Req Line Require An RFQ?, E-176
  - Get Release Generation Method From ASL, E-177
  - Get Req Line Info, E-176
  - Get The Source Document Type, E-177
  - Insert Req Line Into Temp Table As A Candidate For Creation, E-177
  - Is This An Emergency Requisition?, E-176
  - Is This Req Line a P-Card Line?, E-176, E-179
  - Should Workflow Create The Release?, E-177
  - Start, E-176
- Verify Req Line Information process overview, E-174

- Verify Requisition subprocess activities
  - Document Failed Correctness Check, E-70
  - Document Failed State Check, E-70
  - Document Manager Failed, E-70
  - Does Document State Allow Approval Action?, E-70
  - End, E-71
  - Is Document Complete?, E-70
  - Record Submit In Action History, E-70
  - Set Req Status to Original Status, E-70
  - Start, E-70
- Verify Requisition subprocess overview, E-69
- View Accounting window, 9-49
- View Accounting windows
  - customizing, 9-49
- View Approved Suppliers, 5-48, 5-49
- Viewing Action History, 10-1
- Viewing Price Structure, 7-23
- Viewing Purchase Order Changes, 10-3
- View Receiving Accounting window, 9-48, 9-49
- View Write-Off Transactions, 9-118

## **W**

---

- Web Requisition Approval List Routing Subprocess Activities
  - Get Next Approver, E-74
  - Rebuild Approval List for Invalid Approver, E-74
- Web Requisition Main Requisition Approval Process Activities
  - Build Default Approval List, E-64
  - Create Information Template Attachment, E-66
  - Does Approval List Exist?, E-64
  - Is Approval List Empty?, E-64
  - Rebuild Approval List After Forward Action, E-65
  - Set Requisition Status to Pre-Approved, E-64
- Web Requisition Main Requisition Approval process overview, E-62
- Web Requisition Notify Approver Subprocess Activities
  - Update Action History (Expect Response), E-79
- Web Requisition Reserve at the Start Subprocess Activities

- Is Requisition Created Through the Web, E-72
- Web Requisition Response with Approve Action Subprocess Activities
  - Update Action History (Approve), E-80
  - Update Approval List Response, E-80
- Web Requisition Response with Approve and Forward Action Subprocess Activities
  - Update Action History (Approve/Forward), E-82
- Web Requisition Response with Forward Action Subprocess Activities
  - Update Action History (Forward), E-83
- Web Requisition Response with Reject Action Subprocess Activities
  - Update Action History (Reject), E-83
- Web Requisition Start Process Activities
  - Find Approval List, E-68
- Windows
  - navigator paths, A-1
- Workflow
  - background engine, 1-88
  - document creation options, 1-85
  - overall document creation process, E-171
  - processing mode, 1-85
  - send notifications, 1-88
  - setup options, 1-85
  - timeout feature, 1-86
- Workflow Background process, 1-88
- Workflow for price exceeded notifications
  - naming conventions, E-211
- Workflow Monitor
  - Account Generator, E-49

## **X**

---

- XML purchase order, 1-78

