

***SeeBeyond ICAN Suite***

# **CICS eWay Intelligent Adapter User's Guide**

***Release 5.0.2***



The information contained in this document is subject to change and is updated periodically to reflect changes to the applicable software. Although every effort has been made to ensure the accuracy of this document, SeeBeyond Technology Corporation (SeeBeyond) assumes no responsibility for any errors that may appear herein. The software described in this document is furnished under a License Agreement and may be used or copied only in accordance with the terms of such License Agreement. Printing, copying, or reproducing this document in any fashion is prohibited except in accordance with the License Agreement. The contents of this document are designated as being confidential and proprietary; are considered to be trade secrets of SeeBeyond; and may be used only in accordance with the License Agreement, as protected and enforceable by law. SeeBeyond assumes no responsibility for the use or reliability of its software on platforms that are not supported by SeeBeyond.

SeeBeyond, e\*Gate, and e\*Way are the registered trademarks of SeeBeyond Technology Corporation in the United States and select foreign countries; the SeeBeyond logo, e\*Insight, and e\*Xchange are trademarks of SeeBeyond Technology Corporation. The absence of a trademark from this list does not constitute a waiver of SeeBeyond Technology Corporation's intellectual property rights concerning that trademark. This document may contain references to other company, brand, and product names. These company, brand, and product names are used herein for identification purposes only and may be the trademarks of their respective owners.

© 2003 by SeeBeyond Technology Corporation. All Rights Reserved. This work is protected as an unpublished work under the copyright laws.

**This work is confidential and proprietary information of SeeBeyond and must be maintained in strict confidence.**

Version 20031218170904.

# Contents

---

## Chapter 1

<b>Introducing the CICS eWay</b>	<b>7</b>
<b>Overview</b>	<b>7</b>
CICS Transaction Server	7
The eWay Intelligent Adapter for CICS	8
z/OS CICS Security Considerations	9
Security Considerations for SeeBeyond CICS Listener	9
<b>Supported Operating System</b>	<b>11</b>
Also Supported	11
<b>System Requirements</b>	<b>12</b>
<b>External System Requirements</b>	<b>12</b>
CICS Server Requirements for Using the SeeBeyond CICS Listener	12
CICS Listener Requirements for Invoking DB2 Applications	13

---

## Chapter 2

<b>Installing the CICS eWay</b>	<b>14</b>
<b>Installing the CICS eWay</b>	<b>14</b>
Installing the CICS eWay on an eGate Supported System	14
After Installation	15
<b>SeeBeyond CICS Listener Installation for z/OS</b>	<b>15</b>
Installing the SeeBeyond CICS Listener from CD z/OS	15
Installing the SeeBeyond CICS Listener from 3480 Tape	16
Copying the Tape Contents to Disk	16
Installing the CICS CEDA Definitions	17
Adding the CICS eWay Load Modules to CICS DFHRPL Concatenation	17
Creating the STCLCFG File	17
<b>The SeeBeyond CICS Listener Configuration File Maintenance Screen for z/OS</b>	<b>18</b>
The SeeBeyond CICS Listener Monitor Screen for z/OS	23
<b>CICS Listener Considerations for Invoking DB2 Applications</b>	<b>34</b>
RCT entry for the STCL SeeBeyond CICS Listener Transaction	35
PPT entry to redirect DB2 application to another AOR	35

---

**Chapter 3**

<b>Configuring the CICS eWay</b>	<b>37</b>
<b>Creating and Configuring the CICS eWay</b>	<b>37</b>
Selecting CICS as the External Application	37
Modifying the CICS eWay Properties	38
Using the Properties Sheet	38
<b>CICS eWay Connectivity Map Configuration Properties</b>	<b>40</b>
Connector	40
Class	40
Connection Transport	40
Property.Tag	41
Type	41
CICS Client	41
CICS Program	41
CICS TransId	42
COMMAREA Length	42
ECI call type	42
ECI extend mode	42
Encoding	42
<b>CICS eWay Environment Explorer Configuration Properties</b>	<b>43</b>
SeeBeyond CICS Listener	43
COMMAREA Padding Character	43
Host	44
KeepAlive	44
Listener Timeout	44
NoDelay	44
Polling Rate	45
Port	45
ReceiveBufSize	45
SeeBeyond CICS Listener TransId	45
SendBufSize	45
Start Delay	46
Start Type	46
TP Timeout	46
Transport Timeout	46
Tracing	47
Timing	47
CICS Client	47
CICS Password	47
CICS UserId	47
<b>Alerting and Logging</b>	<b>48</b>

---

**Chapter 4**

<b>Using eInsight Business Processes with the CICS eWay</b>	<b>49</b>
The eInsight Engine and Components	49
The CICS eWay With eInsight	50

The CICS eWay eInsight Sample Project	50
Importing a Sample Project	50
The CICS_BP_Sample Project Overview	51
Creating the CICS_BP_Sample Project	51
Creating a Project	51
Creating a Business Process	52
Creating the Business Process Flow	52
Configuring the Modeling Elements	54
Creating a Connectivity Map	56
Selecting the External Applications	57
Populating the Connectivity Map	57
Binding the eWay Components	58
Creating an Environment	59
Configuring the eWay Properties	60
Configuring the File eWay Properties	60
Configuring the CICS eWay Properties	61
Creating and Activating the Deployment Profile	62
Running the Project	63

---

## Chapter 5

<b>Implementing a CICS eWay Project</b>	<b>65</b>
CICS eWay Components	65
CICS eWay Sample Projects	66
Importing a Sample Project	66
The CICS_JCE_Sample Project Overview	67
Creating the CICS_JCE_Sample Project	67
Creating a Project	67
Creating a Connectivity Map	68
Selecting the External Applications	68
Populating the Connectivity Map	69
Creating the Collaboration Definitions	69
Using the Collaboration Editor (Java)	71
Creating the CICSjms_Collab Business Rules	71
Creating the JMS2File_Collab Collaboration Business Rules	75
Binding the eWay Components	76
Creating an Environment	77
Configuring the eWays	78
Configuring the File eWays	79
Configuring the CICS eWay	79
Configuring the JMS Clients	80
Creating and Activating the Deployment Profile	81
Running the Project	82
<b>The CICS_COBOL_Sample Project</b>	<b>83</b>
Creating a Project	83
Creating a Connectivity Map	84
Selecting the External Applications	84

## Contents

Populating the Connectivity Map	84
Creating an Object Type Definition	85
Using the Cobol Copybook Wizard	85
Creating a Collaboration Definition (Java)	86
The CICS_COBOL_Collab Business Rules	86
Creating Collaboration Bindings	94
Creating an Environment	95
Configuring the eWays	96
Configuring the File eWays	96
Configuring the CICS eWay	96
Creating and Activating the Deployment Profile	97
Running the Project	98

---

## Chapter 6

<b>Java Methods</b>	<b>99</b>
<b>The CicsClient Class</b>	<b>99</b>
CICS Javadoc	99
<b>Packed Decimal Java Helper Methods</b>	<b>99</b>
ContainerExists	100
CopyBack	100
CopyTo	101
GiveElem	101
SetElem	102
<b>Index</b>	<b>103</b>

# Introducing the CICS eWay

This chapter includes a brief description of IBM's Customer Information Control System™ (CICS™), an overview of the SeeBeyond eWay Intelligent Adapter for CICS, as well as system requirements for using the CICS eWay.

## Chapter Topics

- [Overview](#) on page 7
- [Supported Operating System](#) on page 11
- [System Requirements](#) on page 12
- [External System Requirements](#) on page 12

---

## 1.1 Overview

### CICS Transaction Server

IBM's Customer Information Control System (CICS), is IBM's most widely used proprietary, transaction monitor. CICS provides connectivity and online transaction management for mission-critical applications. It supports real-time distributed processing environments and online transaction processing (OLTP). According to IBM, CICS handles more than thirty billion transactions, processing more than one trillion dollars, per day.

CICS is the premier OLTP (On-Line Transaction Processing) product from IBM. It is used to access many file systems and databases including third party products. For IBM product, it interfaces with DB2, VSAM and IMS/DB. For non-IBM products, it interfaces with IDMS, ADABAS, DATACOM, to name a few. Most applications in CICS are written in COBOL, although it supports other languages such as PL/1.

OLTP systems provide accurate, up-to-date information within seconds, from terminals that give direct access to data held as either files or databases. CICS provides a company with numerous transaction processing and resource management functions, allowing the user to concentrate on developing application programs that meet that organization's specific business needs. CICS controls OLTP application programs in a distributed transaction processing (DTP) environment. CICS handles interactions between the terminal user and the application programs. Programs gain access to the CICS facilities with straightforward, high-level commands.

CICS provides:

- Communication functions to terminals and systems required by application programs
- Control of concurrently running programs serving online users
- Facilities for accessing databases and files
- The ability to communicate with other CICS family members using Transmission Control Protocol/Internet Protocol (TCP/IP)
- Interactive facilities to configure specific systems
- Recovery processing and data protection, should a problem occur

## The eWay Intelligent Adapter for CICS

The eWay Intelligent Adapter for CICS is an interface that enables remote bidirectional calls to CICS transactional programs. The CICS eWay includes a build tool, the Cobol Copybook Converter, that creates an Object Type Definition (OTD) from a Cobol Copybook file and generates eGate Object Type Definitions for use within the eGate environment. The Copybook file structures are passed into the CICS environment as the data buffer (Commarea).

A fixed Object Type Definition, the **CICS\_eWay.CICSClient OTD**, designed to expose various essential portions of the CICS Java API, provides available methods and properties, as well as access to all message attributes.

The eWay uses the SeeBeyond CICS Listener as the underlying connection transport for accessing OS/390 V2R10 or z/OS CICS transactions.

### SeeBeyond CICS Listener (STCL)

The CICS eWay connects to the IBM CICS Listener running on z/OS via the TCP/IP Sockets. The Listener accepts the incoming request and spawns a new process handing the socket connection off to the newly created process via TCP/IP `givesocket()/takesocket()` function calls. The spawned process invokes the user written CICS application program through an EXEC CICS LINK.



**Figure 1** Using the SeeBeyond CICS Listener for Synchronous Transactions

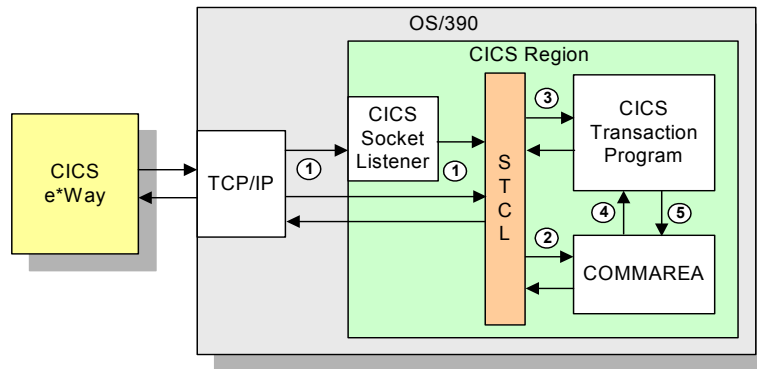

The CICS eWay (Java version) communicates with SeeBeyond CICS Listener for Synchronous Transactions (See Figure 1) as follows:

- 1 An incoming Connect request is handled by the IBM CICS Socket Listener, which starts the SeeBeyond CICS Listener Transaction STCL and hands off the incoming connection via the IBM TCP/IP Give Socket and Take Socket interface.
- 2 The SeeBeyond CICS Listener allocates a CICS COMMAREA and copies information from the CICS eWay COMMAREA to the actual CICS COMMAREA.
- 3 The SeeBeyond CICS Listener issues an EXEC CICS LINK to requested CICS Transaction Program passing it the newly allocated COMMAREA.
- 4 The requested CICS Transaction obtains data from the COMMAREA, performs typical business rule processing and then returns its results in the COMMAREA and returns control back to the SeeBeyond CICS Listener.
- 5 The SeeBeyond CICS Listener copies information from the CICS COMMAREA back to the CICS eWay COMMAREA.
- 6 The SeeBeyond CICS Listener goes into a listen mode and waits for the next incoming Transaction Program request.

The process continues until the SeeBeyond CICS Listener Timeout is exceeded or a disconnect request is received from the CICS eWay.

### 1.1.1. z/OS CICS Security Considerations

#### Security Considerations for SeeBeyond CICS Listener

The CICS eWay, using the SeeBeyond CICS Listener as the underlying connection transport, utilizes three modes of security with z/OS: Connection Logic, Request Link to Program, and Request Start Transaction. The userID and password are defined in the eWay properties file. The connection manager uses the userID and password in the properties file to start the SeeBeyond CICS Listener on z/OS. During Business Rules processing, requests that flow into the SeeBeyond CICS Listener can use the userID and password from the properties file, or can be overwritten in the Collaborations.

Figure 2 Connection Logic

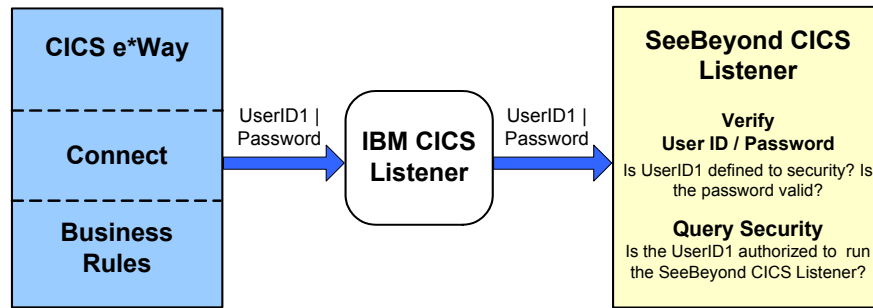

### Connection Logic

For the Connection Logic mode (Figure 2), the userID and password, passed from the CICS eWay through the IBM CICS listener and into the SeeBeyond CICS Listener, must be defined for the z/OS security system (RACF, for example). The userID must be authorized by the z/OS security system to run CICS transaction “xxxx” inside of CICS. The default value for “xxxx” is STCL, and can be changed in the properties of the Connection Manager in the CICS eWay.

Figure 3 Business Rules Request to Program

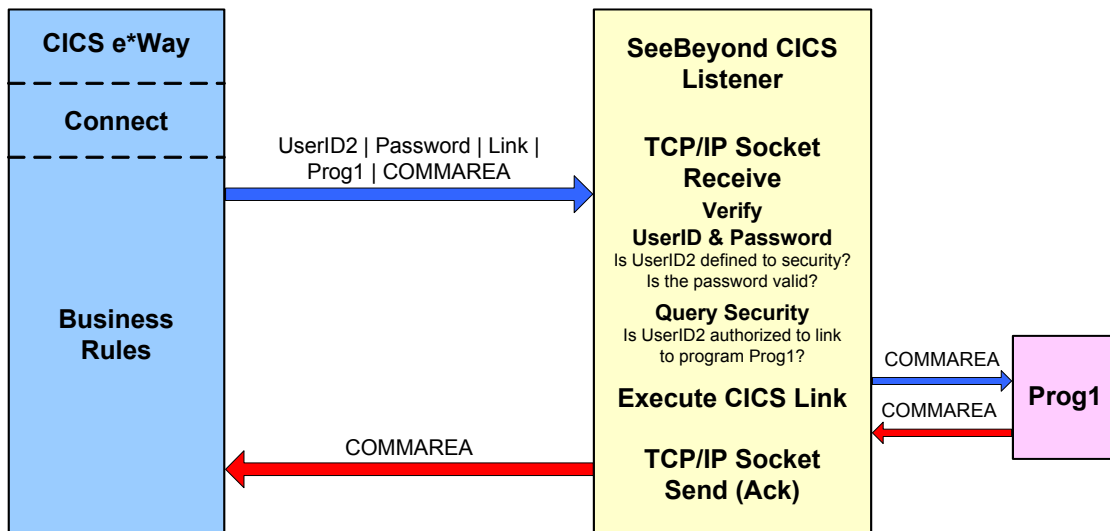

### Request Link to Program

For the Request Link to Program mode (Figure 3), the userID and password passed from the CICS eWay to the SeeBeyond CICS Listener must be defined for the z/OS security system (RACF, for example). The userID must be authorized by the z/OS security system to run CICS program “prog1” inside of CICS. The default value for “prog1” is set in the properties of the CICS eWay, and can be overridden in the Collaboration for each request sent into the SeeBeyond CICS Listener.

Figure 4 Business Rules Request Start Transaction

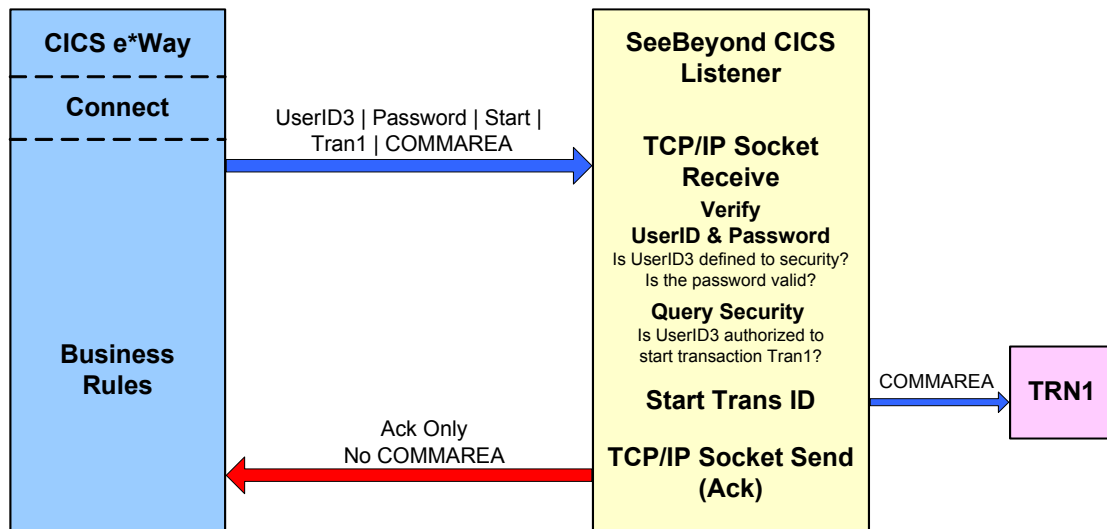

### Request Start Transaction

For the Request Start Transaction mode (Figure 4), the userID and password passed from the CICS eWay to the SeeBeyond CICS Listener must be defined for the z/OS security system (RACF, for example). The userID must be authorized by the z/OS security system to start CICS transaction "TRN1" inside of CICS. The default value for "TRN1" is set in the properties file of the CICS eWay, and can be overridden in the Collaboration for each request sent into the SeeBeyond CICS listener.

---

## 1.2 Supported Operating System

The CICS eWay is available on the following operating systems:

- Windows XP
- Windows 2000
- Solaris 8 and 9
- AIX 5.1 and 5.2
- HP-UX 11.0 and HP-UX 11i (RISC)

### Also Supported

The CICS eWay also supports CICS Transaction Server residing on the following operating systems:

- OS/390 V2R10 or above (any reference to z/OS in this document also includes OS/390 V2R10)

---

## 1.3 System Requirements

To set up and run the CICS eWay with the eGate Enterprise Designer, you need the following:

- A TCP/IP network connection
- Windows 2000 SP3, Windows 2003 Server, or Windows XP (required for the User Interface)
- Microsoft Internet Explorer 6.0 SP1 or above

**Note:** *Open and review the **Readme.txt** eWay prior to installation, for any additional requirements.*

---

## 1.4 External System Requirements

### Software Requirements

- IBM CICS Transaction Server version 1.3 or 2.1
- The CICS eWay connects to CICS using the **SeeBeyond CICS Listener** (STCL). See [CICS Server Requirements for Using the SeeBeyond CICS Listener](#) on page 12 and [CICS Listener Requirements for Invoking DB2 Applications](#) on page 13 for specific requirements.

### 1.4.1. CICS Server Requirements for Using the SeeBeyond CICS Listener

To enable the eWay to communicate correctly with CICS using the SeeBeyond CICS Listener the following are required:

- OS/390 V2R10 or above (see [System Requirements](#) on page 12)
- Resource Access Control Facility (RACF) or an equivalent security product
- IBM CICS Transaction Server version 1.3 or 2.1
- IBM MVS TCP/IP socket runtime libraries, installed and configured for each CICS region in which the SeeBeyond CICS Listener will be run. For more information please refer to IBM's TCP/IP V3R2 for MVS: CICS TCP/IP Socket Interface Guide.
- COBOL for z/OS and Language Environments

## 1.4.2. CICS Listener Requirements for Invoking DB2 Applications

There are two different techniques that can be used for invoking DB2 application programs through the SeeBeyond CICS Listener.

- RCT entry for the STCL SeeBeyond CICS Listener Transaction
- PPT entry to redirect DB2 application to another AOR (Application Owning Region)

For detailed information refer to [CICS Listener Considerations for Invoking DB2 Applications](#) on page 34.

# Installing the CICS eWay

This chapter contains installation information for the CICS eWay and SeeBeyond CICS Listener.

## Chapter Topics

- [Installing the CICS eWay](#) on page 14
- [SeeBeyond CICS Listener Installation for z/OS](#) on page 15
- [The SeeBeyond CICS Listener Configuration File Maintenance Screen for z/OS](#) on page 18

---

## 2.1 Installing the CICS eWay

During the eGate Integrator installation process, the Enterprise Manager, a web-based application, is used to select and upload eWays (eWay.sar files) from the eGate installation CD-ROM to the Repository.

When the Repository is running on a UNIX operating system, eGate and the eWays are installed using the Enterprise Manager from a computer running Windows, connected to the Repository server.

### 2.1.1. Installing the CICS eWay on an eGate Supported System

The CICS eWay is installed during the installation of the eGate Integrator. The eGate installation process includes the following operations:

- Installing the eGate Repository
- Uploading products to the Repository
- Downloading components (such as eGate Enterprise Designer and Logical Host)
- Viewing product information home pages

Follow the instructions for installing the eGate Integrator in the *SeeBeyond ICAN Suite Installation Guide*, and include the following steps:

- 1 During the procedures for uploading files to the eGate Repository using the Enterprise Manager, after uploading the **eGate.sar** file, select and upload the following files:
  - ♦ **CICSeWay.sar** (to install the CICS eWay)

- ♦ **CobolCopyBook.sar** (to install the Cobol Copybook Converter Wizard)
  - ♦ **FileeWay.sar** (to install the File eWay, used in the sample project)
  - ♦ **CICSeWayDocs.sar** (to download the CICS eWay user's guide)
- 2 Continue installing the eGate Integrator as instructed in the *SeeBeyond ICAN Suite Installation Guide*

## 2.1.2. After Installation

Once the eWay is installed and configured it must then be incorporated into a project before it can perform its intended functions. See the *eGate Integrator User's Guide* for more information on incorporating the eWay into an eGate project.

---

## 2.2 SeeBeyond CICS Listener Installation for z/OS

The following section provides directions for installing the SeeBeyond CICS Listener to an OS/390 or z/OS operating system from the installation CD-ROM or from a 3480 Tape. Directions are also included for installing CICS CEDA definitions, adding the CICS eWay load modules to the CICS DFHRPL concatenation, and using the SeeBeyond CICS Listener monitoring screen to verify that all components are properly installed and working correctly.

### 2.2.1. Installing the SeeBeyond CICS Listener from CD z/OS

These instructions show how to restore the SeeBeyond CICS Listener files from the installation CD\_ROM (setup\addons\ewcics\SBYN\_Listner.zip) to your MVS system in a usable state. The files are packaged on MVS for transfer using the TSO transmit (XMIT) command to transmit them into a data set. This is done to turn a PDS into FB 80 files which can be sent by FTP. These files are downloaded to a PC and then compressed with PKZIP.

- 1 Download the **SBYN\_Listener.zip** file to your PC.
- 2 Unzip the files using WinZip or the Zip program of your choice.
- 3 Create two MVS datasets to receive the files, as follows:

```
//DD1      DD DSN=USER.XMIT.CICSLOAD,
//          DISP=(NEW,CATLG,DELETE),
//          RECFM=FB,LRECL=80,BLKSIZE=3120,DSORG=PS,
//          SPACE=(3120,(48,5)),
//          UNIT=diskunit

//DD2      DD DSN=USER.XMIT.JCLLIB,
//          DISP=(NEW,CATLG,DELETE),
//          RECFM=FB,LRECL=80,BLKSIZE=3120,DSORG=PS,
//          SPACE=(3120,(30,5)),
//          UNIT=diskunit
```

- 4 Upload (FTP, IND\$FILE) the unzipped files to MVS using a binary file transfer method (no CRLF or ASCII translation).

- 5 Restore the files to PDS by using the **Receive** command on MVS.
- 6 Issue command: TSO RECEIVE INDATASET(uploaded.dataset)
- 7 When prompted by the message:

INMR906A Enter restore parameters or 'DELETE' or 'END' +  
enter:

DA(name.of.your.library) UNIT(unit) VOLUME(volume)

**Note:** The UNIT() and VOLUME() operands are optional but shown in case your installation requires them.

We suggest using the following names for your received datasets:

STC.XMIT.CICS.CICSLOAD  
STC.XMIT.CICS.JCLLIB

These names match our documentation, but you may change them as your facility requires.

## 2.2.2. Installing the SeeBeyond CICS Listener from 3480 Tape

The SeeBeyond CICS Listener installation for OS/390 or z/OS is provided on an installation tape containing the following datasets (Table 1):

**Table 1** OS/390 Datasets

Dataset Name	Contents
TAPE.STC.RESTORE.JCL	Physical sequential datasets containing the JCL for this tape.
TAPE.STC.CICS.JCLLIB	Partition dataset that contains installation jobs and control cards for the CICS eWay.
TAPE.STC.CICS.CICLOAD	Load library that contains the CICS load modules for the CICS eWay.

### Copying the Tape Contents to Disk

- 1 Create and submit the following job to copy the RESTORE JCL to disk:

```
//JOB CARD
//IEBGENER EXEC PGM=IEBGENER
//*
//*COPY RESTORE JCL TO DISK
//*
//SYSUT1 DD DSN=TAPE.STC.RESTORE.JCL,DISP=OLD,UNIT=TAPE,
// VOL=(,RETAIN,SER=STC390),LABEL=(1,SL)
//SYSUT2 DD DSN=customers.pds(restore),DISP=SHR
//SYSIN DD DUMMY
//
```

- 2 Customize and submit the RESTORE job to copy the entire contents of the Installation tape to disk.



### 2.2.3. Installing the CICS CEDA Definitions

Customize the file definition in the JCLLIB member CEDALCFG to conform to your site's file naming conventions. Customize and submit job STCLCEDA to create CICS CEDA definitions for the CICS eWay.

### 2.2.4. Adding the CICS eWay Load Modules to CICS DFHRPL Concatenation

Add the following data set to the DFHRPL concatenation under CICS:

```
// DD DSN=&PREFIX..STC.CICS.CICSLOAD,DISP=SHR
```

### 2.2.5. Creating the STCCLCFG File

Customize and submit the STCCLCFG job found in JCLLIB. Make sure the FCT entry STCCLCFG is closed and disabled in CICS before running this job.

## 2.3 The SeeBeyond CICS Listener Configuration File Maintenance Screen for z/OS

After the STCCLCFG Configuration File has been created and the CEDA file definition has been installed, use the SeeBeyond CICS Configuration File Maintenance screen to view and update the contents of the STCCLCFG configuration file.

- 1 Logon to the CICS region that the SeeBeyond Listener is running in. Clear the screen, type in **stlc** as shown in Figure 5, and press **Enter**.

Figure 5

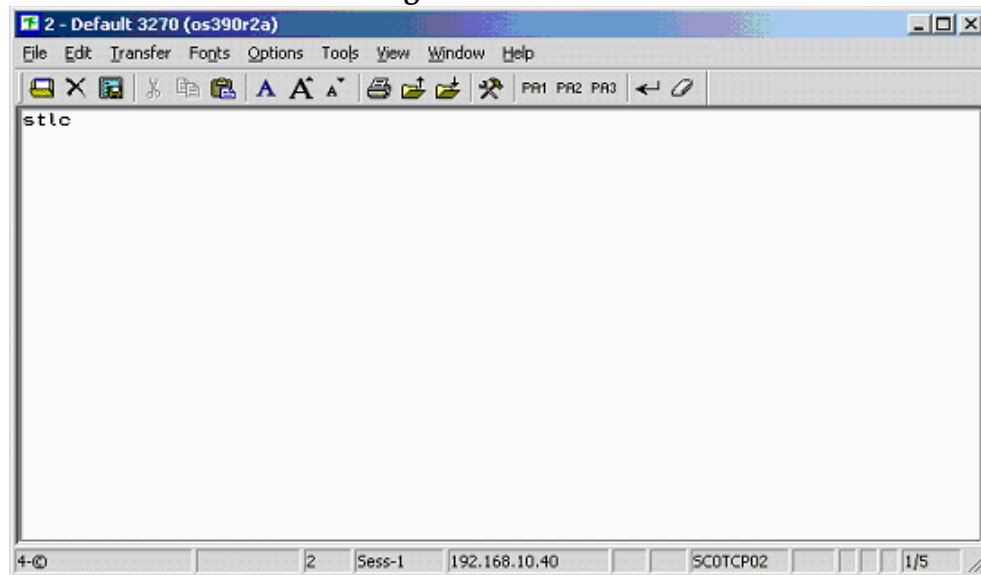

- 2 The **Configuration File Maintenance** screen appears as displayed in Figure 6.

Figure 6

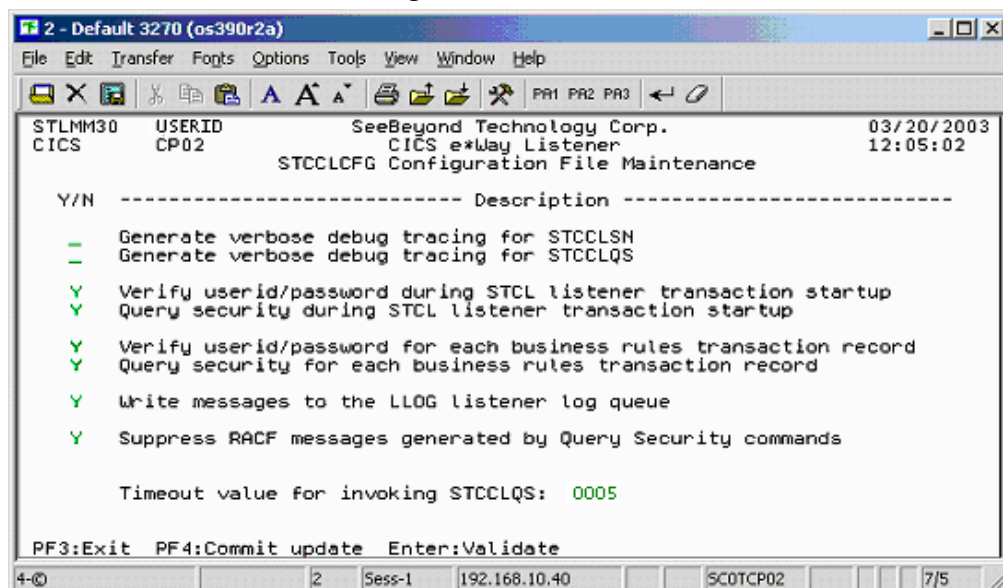

3 The fields of the Listener Configuration Maintenance screen are described as follows:

- ♦ **Generate verbose debug tracing for STCCLSN:** This flag controls the logging of debug tracing messages issued by the STCCLSN SeeBeyond CICS Listener Program. These tracing messages are written to the LLOG transient data queue.

If the “Write messages to the LLOG listener log queue” field on this screen is turned off, then debug tracing will NOT be logged.

- ♦ **Y:** yes, log debug tracing messages.
  - ♦ **N or blank:** no, do not log debug tracing messages.
- ♦ **Generate verbose debug tracing for STCCLQS:** This flag controls the logging of debug tracing messages issued by the STCCLQS SeeBeyond CICS Listener Query Security Program. These tracing messages are written to the LLOG transient data queue.

If the “Write messages to the LLOG listener log queue” field on this screen is turned off, then debug tracing will NOT be logged.

- ♦ **Y:** yes, log debug tracing messages.
  - ♦ **N or blank:** no, do not log debug tracing messages.
- ♦ **Verify userid/password during STCL listener transaction startup:** This flag controls userid/password verification at the STCL SeeBeyond Listener Transaction startup. The userid and password are passed from the CICS eWay to the IBM Listener program in the user area of Connection Request Record. The IBM Listener passes this user area to the SeeBeyond CICS Listener when it spawns it as a child listener task.

If this flag is turned on, the SeeBeyond Listener Program startup logic issues a Verify Password command to check whether the userid is defined for the RACF or any equivalent security system, and if the password is valid and current.

- ♦ **Y:** yes, verify userid/password.
  - ♦ **N or blank:** no, do not verify userid/password.
- ♦ **Query Security during STCL listener transaction startup:** This flag controls Query Security processing at the STCL SeeBeyond Listener Transaction startup. The userid and password are passed from the CICS eWay to the IBM Listener program in the user area of Connection Request Record. The IBM Listener passes this user area to the SeeBeyond CICS Listener when it spawns it as a child listener task.

If this flag is turned on, the SeeBeyond Listener Program startup logic invokes the STLQ SeeBeyond Listener Query Security transaction to check if the userid is authorized to run the STCL SeeBeyond Listener transaction.

- ♦ **Y:** yes, perform Query Security processing.
- ♦ **N or blank:** no, do not Query Security processing

- ♦ **Verify userid/password for each business rules transaction record:** This flag controls userid/password verification for each Business Rules transaction sent in from the CICS eWay. The userid and password are passed in from the CICS eWay in the Application Control Record (ACR) that contains the Business Rules transaction data.

If this flag is turned on, the SeeBeyond CICS Listener program Business Rules logic issues a Verify Password command to check whether the userid is defined for the RACF or any equivalent security system, and if the password is valid and current.

- ♦ **Y:** yes, verify userid/password.
- ♦ **N or blank:** no, do not verify userid/password.
- ♦ **Query Security for each business rules transaction record:** This flag controls Query Security processing for each Business Rules transaction sent in from the CICS eWay. The userid and password are passed in from the CICS eWay in the Application Control Record (ACR) that contains the Business Rules transaction data.

If this flag is turned on, the SeeBeyond CICS Listener Program Business Rules logic invokes the STLQ SeeBeyond Listener Query Security transaction to check whether the userid is authorized to run the requested customer application program or transaction that is specified in the ACR.

- ♦ **Y:** yes, perform Query Security processing.
- ♦ **N or blank:** no, do not Query Security processing.
- ♦ **Write messages to the LLOG listener log queue:** This flag controls the logging of messages to the LLOG listener log queue.

If this flag is turned off, NO messages (normal information as well as debug tracing) will be written by either the STCCLSN (SeeBeyond CICS Listener) or STCCLQS (SeeBeyond Listener Query Security) programs.

- ♦ **Y:** yes, write log messages to the LLOG listener log queue.
- ♦ **N or blank:** no, do not write log messages to the LLOG listener log queue.
- ♦ **Suppress RACF messages generated by Query Security commands:** This flag controls RACF informational message logging for Query Security exceptions.

If this flag is turned off, then every Query Security command that results in a negative result for Control, Alter, Update, or Read will cause respective RACF information messages to be written to the system message log. This could create unnecessary, high volume logging on the system message log files.

It is recommended that this flag be turned off for debugging or low volume testing purposes only.

In a production environment, it is recommended that this flag be turned on to

suppress the RACF informational messages generated by Query Security exception conditions.

- ♦ **Y:** yes, suppress RACF messages generated by Query Security processing.
- ♦ **N or blank:** no, do not suppress (in other words, allow) RACF messages to be generated by Query Security processing.
- ♦ **Timeout value for invoking STCCLQS:** This value is used to control the amount of time the STCCLSN SeeBeyond CICS Listener program waits for the STLQ Listener Query Security Transaction to return a response. Valid values are 0000 to 9999. Since the STLQ transaction, under normal CICS processing conditions, executes within one second, it is recommended that the value be set above 1 and below 10. However, if the CICS region that the SeeBeyond CICS Listener is running in experiences occasional performance bottle necks, you may choose to set this value higher to avoid unnecessary STLQ timeout errors during peak load conditions.

This value does not affect the time STLQ takes to respond. It simply sets a timeout threshold above which the STCCLSN stops waiting for a response from STLQ and issues an error message back to the CICS eWay indicating that an STLQ timeout has occurred. For example, if this timeout value is set to 5, and STLQ executes in 1 second, then STCCLSN will “wake up” after 1 second, not the full 5 seconds.

4 The pfkeys for this screen are as follows:

- ♦ **PF3:** exit.
- ♦ **PF4:** commit the updates on the screen to the STCCLCFG file and update all existing Listener Program Areas (LPA's) in CICS storage.
- ♦ **Enter:** validates the onscreen data for errors.

The user may make any necessary changes, then use the **Enter** key to validate any new values that have been entered. IF no error conditions occur for the data on the screen, then the user must press the PF4 key to commit the updates to the STCCLCFG Listener Config VSAM File. The updated screen appears as displayed in [Figure 7 on page 22](#). A message appears at the bottom of the screen that indicating the file and whether any LPA's were updated.

During commit processing, the program will also automatically propagate the new data to all existing SeeBeyond Listener Program Areas (LPA's) in the same CICS region. There is one LPA for each instance of the SeeBeyond CICS Listener in the region. The STCCLSN (SeeBeyond CICS Listener) program uses its copy of the LPA to store monitoring statistics and to retrieve data used to control the execution of the SeeBeyond CICS Listener. Live updates to the LPAs provide the capability for real time control of the configuration flags and timers for all active SeeBeyond CICS Listeners executing at that time.

Figure 7

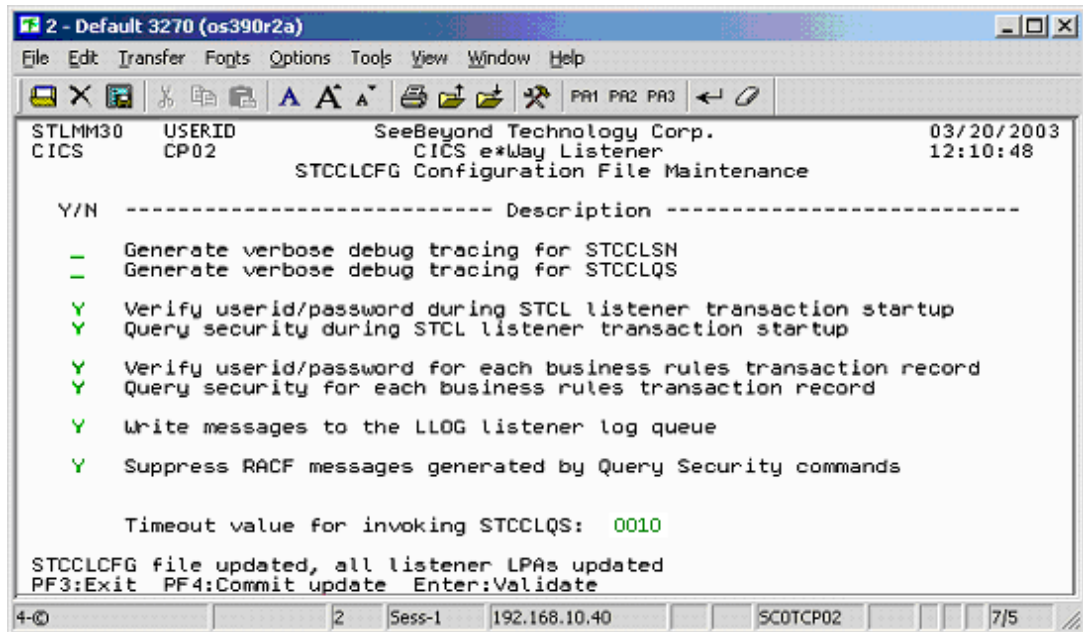

- 5 Continue making any necessary changes, committing them by pressing **PF4**. To exit the screen press **PF3**.

### 2.3.1. The SeeBeyond CICS Listener Monitor Screen for z/OS

After the components are installed, use the SeeBeyond CICS Listener monitoring screen to verify that all components are properly installed and working correctly.

- 1 Logon to the CICS region that the SeeBeyond Listener is running in. Clear the screen, and type in **stlm** as displayed in Figure 8. Press **Enter**.

Figure 8

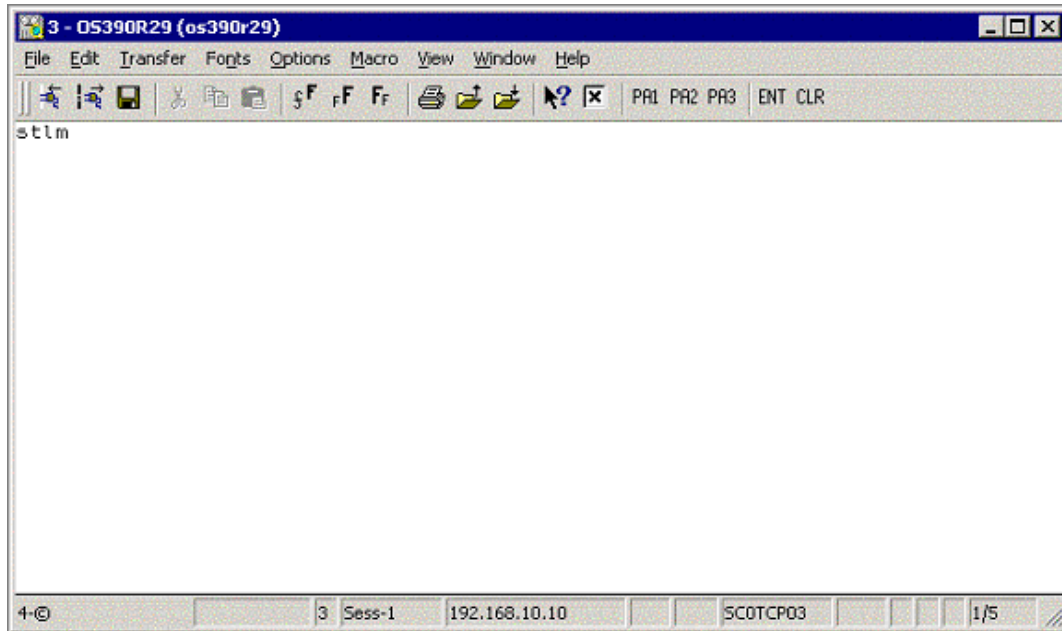

- 2 The menu screen appears as displayed in Figure 9.

Figure 9

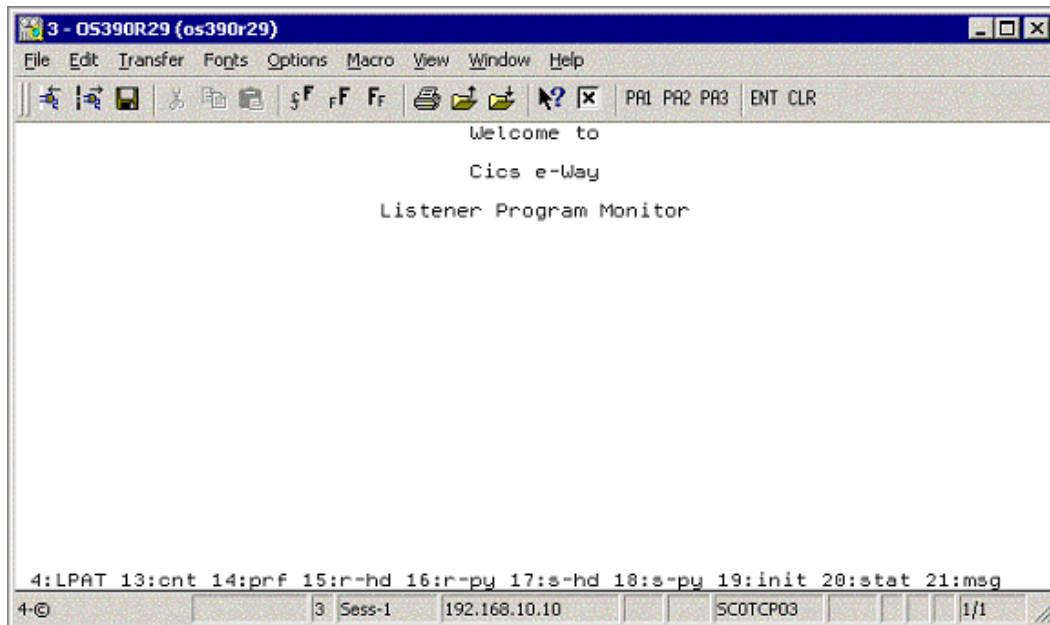

3 The **pfkeys** for this screen, and all of the monitor screens shown in this document, are as follows:

- ♦ **PF4**: displays the LPAT (Listener Program Area Table).
- ♦ **PF13**: displays the LPA counts and polling rates.
- ♦ **PF14**: displays the LPA performance statistics.
- ♦ **PF15**: displays the LPA last request header received from the CICS eWay.
- ♦ **PF16**: displays the LPA last request payload received from the CICS eWay.
- ♦ **PF17**: displays the LPA last response header sent to the CICS eWay.
- ♦ **PF18**: displays the LPA last response payload sent to the CICS eWay.
- ♦ **PF19**: displays the LPA initial record sent from the IBM Listener (EZACIC02).
- ♦ **PF20**: displays the LPA status.
- ♦ **PF21**: displays the LPA last error message sent to the CICS eWay.

Press **PF4**. The **Listener Program Area Table** screen appears as displayed in Figure 10.

Figure 10

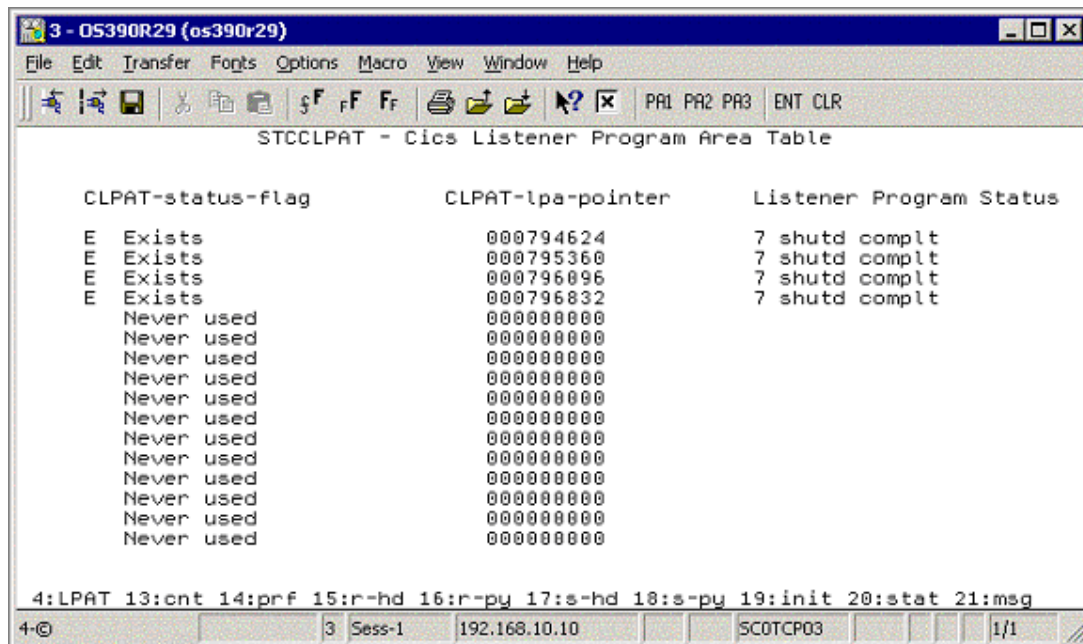

4 This screen displays the Listener Program Area Table (LPAT). Each line contains information about a Listener Program Area (LPA). There is one LPA associated with each instance of the SeeBeyond CICS Listener Program that is running or has run in this CICS region. The fields on the screen are:

- ♦ **CLPAT-status-flag**: shows the current status of the LPAT entry as follows:
  - ♦ **E**: Exists.
  - ♦ **N**: Never used.



- ♦ C: Corrupted.
- ♦ **CLPAT-lpa-pointer**: shows the address of the most recent LPA in this entry.
- ♦ **Listener Program Status**: shows the last status of the Listener Program using this LPA.

Press PF13. The **LPA Counts and Polling Rates** screen appears as displayed in Figure 11.

Figure 11

program link	start trans	avg poll rate	non-max poll	highest poll	receive delay cnt	listener delay cnt
373	0	1.0	2	2	0	0
900	0	1.0	2	2	0	0
1	0	1.0	1	1	0	0
1	0	1.0	1	1	0	0

4:LPAT 13:cnt 14:prf 15:r-hd 16:r-py 17:s-hd 18:s-py 19:init 20:stat 21:msg

4-C 3 Sess-1 192.168.10.10 SCOTCP03 1/1

- 5 This screen displays counts and polling rates information for each LPA. Each line shows one LPA (one for each instance of the SeeBeyond Listener Program).

The fields on the screen are as follows:

- ♦ **program link**: the number of program links that have been requested.
- ♦ **start trans**: the number of transaction starts that have been requested.
- ♦ **avg poll rate**: the average number of receives per polling cycle to satisfy a full message receive from the CICS eWay.
- ♦ **non-max cnt**: the 'high water mark' of receives within a polling cycle without reaching the polling rate (polling rate is sent in from the CICS eWay when it initializes connection with the CICS Listener program).
- ♦ **highest poll**: the 'high water mark' of receives within a polling cycle that can include reaching the maximum allowed polling rate.
- ♦ **receive delay cnt**: the number of one second delays that occurred due to the Comm Timeout limit being reached (Comm. Timeout is sent in from the CICS eWay when it initializes connection with the CICS Listener program).

- ◆ **listener delay cnt:** number of one second delays that occur due to the Listener Timeout limit being reached (Listener Timeout is sent in from the CICS eWay when it initializes connection with the CICS Listener program).

Press **PF14**. The **LPA Performance Statistics** screen appears as displayed in Figure 12.

Figure 12

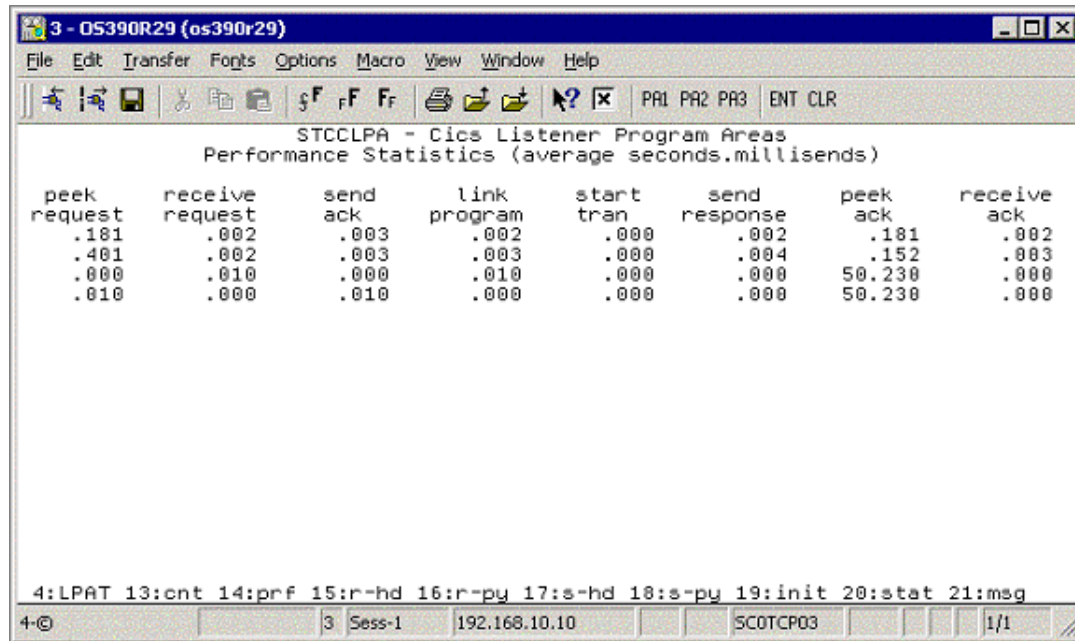

- 6 This screen (Figure 12) displays the performance statistics for each LPA. Each line shows one LPA (one for each instance of the SeeBeyond Listener Program).

All times shown are in sss.mmm format (sss = seconds, mmm=milliseconds). The fields on the screen are as follows:

- ◆ **peek request:** the average time spent peeking for the next incoming application request message.
- ◆ **receive request:** the average time spent receiving the next incoming application request message.
- ◆ **send ack:** the average time spent sending an ack for an incoming application request message.
- ◆ **link program:** the average time spent link to requested application programs.
- ◆ **start tran:** the average time spent starting requested application transactions.
- ◆ **send response:** the average time spent sending the application response (including the updated COMMAREA for program links) back to the eWay.
- ◆ **peek ack:** the average time spent peeking for the incoming ack to the preceding send response.
- ◆ **receive ack:** the average time spent receiving the incoming ack to the preceding send response.

Press PF15. The **Last Application Request Header Received** screen appears as displayed in Figure 13.

Figure 13

message length	program or tran	appl timeout	request code	response code	pad char	commarea length	payload length
113	QAN3GLR1	0	9000	0000	40	0	0
113	QAN3GLR1	0	9000	0000	40	0	0
163	BOB3GLR1	0	0010	0000	40	50	50
163	BOB3GLR1	0	0010	0000	40	50	50

7 This screen (Figure 13) displays the last application request header received from the CICS eWay for each LPA. Each line shows one LPA (one for each instance of the SeeBeyond Listener Program). The fields on the screen are as follows:

- ♦ **message length:** the entire length of the incoming message including the header and payload.
- ♦ **program or tran:** the requested application program or transaction.
- ♦ **appl timeout:** (reserved for future development).
- ♦ **request code:** which action is being requested.
  - ♦ 0010 = link to application program.
  - ♦ 0020 = start application transaction.
  - ♦ 0111 = ack for a link response.
  - ♦ 0121 = ack for a start response.
  - ♦ 9000 = shutdown the Listener program.
- ♦ **response code:** always set to zero from the CICS eWay.
- ♦ **pad char:** padding character for the COMMAREA if the payload length is less than the COMMAREA length.
- ♦ **commarea length:** the length of the data to pass to the application program (link) or the application transaction (start).
- ♦ **payload length:** the length of the payload portion of the incoming message.

Press PF16. The **Last Application Request Payload Received** screen appears as displayed in Figure 14.

Figure 14

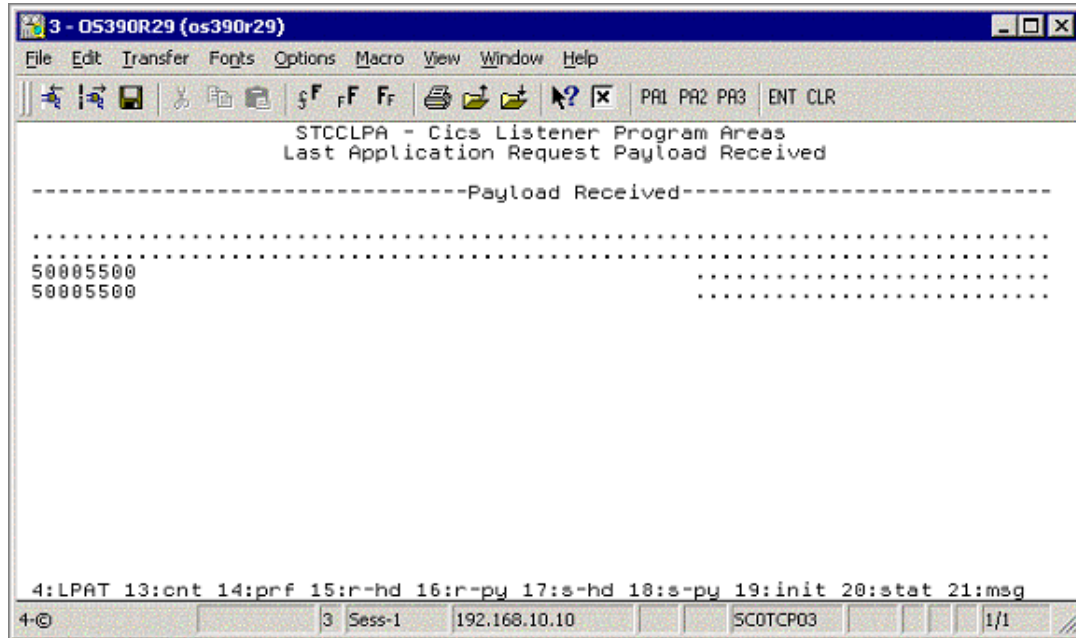

- This screen (Figure 14) displays the last application request payload received from the CICS eWay for each LPA. Each line shows one LPA (one for each instance of the SeeBeyond Listener Program). There is one field on the screen:

- ◆ **Payload Received:** the incoming payload from the CICS eWay.

Press PF17. The **Last Application Response Header** screen appears as displayed in Figure 15.

**Figure 15**

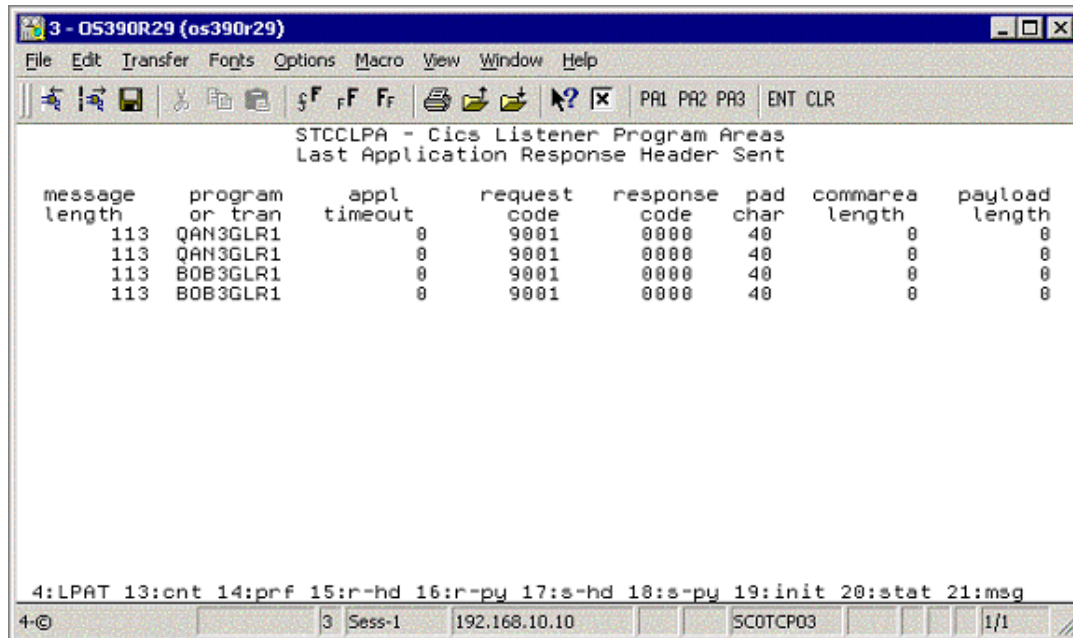

9 The **Last Application Response Header** screen ([Figure 15 on page 29](#)) displays the last response header sent to the CICS eWay for each LPA. Each line shows one LPA (one for each instance of the SeeBeyond Listener Program). The fields on the screen are as follows:

- ♦ **message length:** the entire length of the outgoing message including the header and payload.
- ♦ **program or tran:** the application program or transaction that was executed or started.
- ♦ **appl timeout:** (reserved for future development).
- ♦ **request code:** what action is being requested.
  - ♦ 0001 = ack the init request.
  - ♦ 0011 = ack for a link program request.
  - ♦ 0021 = ack for a start trans response.
  - ♦ 0110 = response from a linked application program (including COMMAREA).
  - ♦ 0120 = response from starting an application transaction (no COMMAREA included).
  - ♦ 9001 = ack for a shutdown request.
- ♦ **response code:** response code indicating what occurred while processing the previous incoming request from the eWay.
  - ♦ 0000 = ok.
  - ♦ 0011 = bad startcode during initialization.

- ♦ 0012 = bad password on init record.
- ♦ 0013 = bad comm timeout on init record.
- ♦ 0014 = bad appl timeout on init record.
- ♦ 0015 = bad Listener timeout on init record.
- ♦ 0016 = error reading the init record from transient data queue.
- ♦ 0017 = error retrieving the init record from the start data.
- ♦ 0018 = error while setting blocking mode.
- ♦ 0051 = bad payload length.
- ♦ 0052 = error while linking to a program.
- ♦ 0053 = error while starting a transaction.
- ♦ 0054 = bad request code.
- ♦ 0055 = bad response code.
- ♦ 0056 = partial message received.
- ♦ 0057 = bad program name.
- ♦ 0058 = bad message length.
- ♦ 0059 = bad commarea length.
- ♦ **pad char**: padding char that was sent in from the CICS eWay.
- ♦ **commarea length**: COMMAREA length that was sent in from the CICS eWay.
- ♦ **payload length**: payload length that was sent in from the CICS eWay (the Listener sets this to zero if this is a response to a start transaction request).

Press **PF18**. The **Last Application Response Payload Sent** screen appears as displayed in Figure 16.

Figure 16

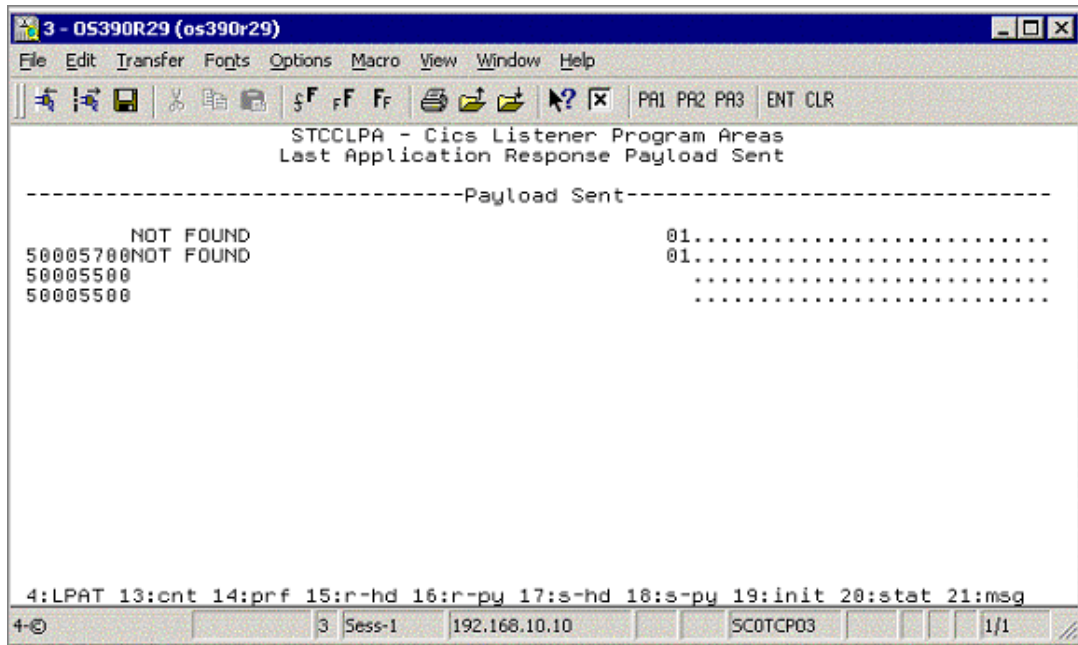

- 10 This screen (Figure 16) displays the last application response payload sent to the CICS eWay for each LPA. Each line shows one LPA (one for each instance of the SeeBeyond Listener Program). There is one field on the screen:

- ♦ Payload sent: the outgoing payload being sent to the CICS eWay.

Press PF19. The **Initialization Record Passed from EZACIC02** screen appears as displayed in [Figure 17 on page 32](#).

Figure 17

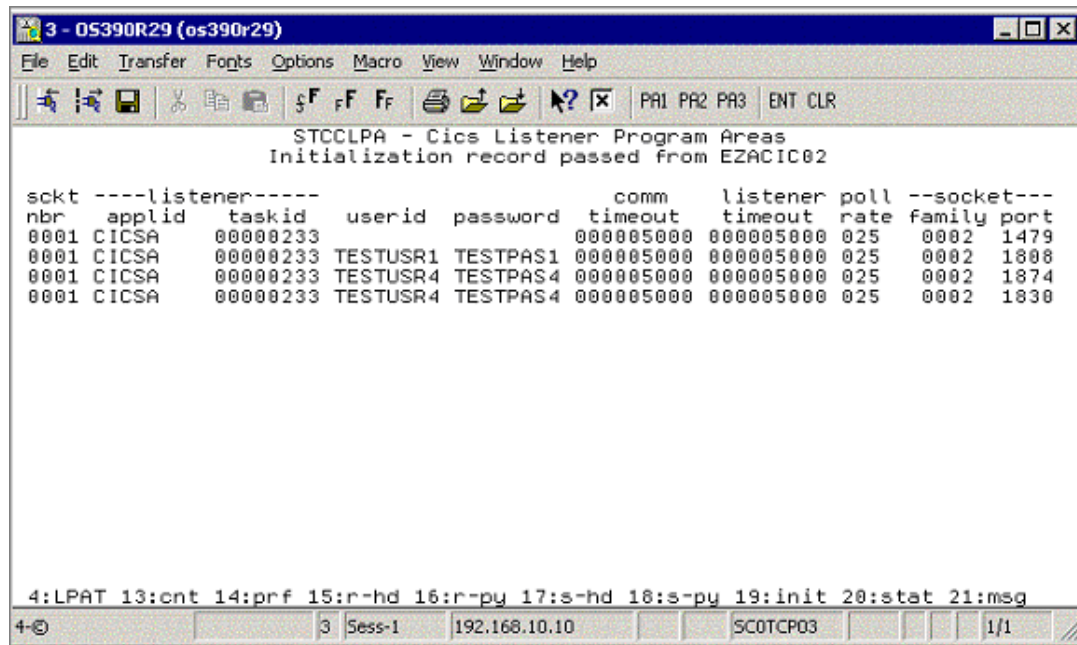

11 This screen (Figure 17) displays the init record that was passed to the SeeBeyond Listener program from the IBM Listener program (ezacic02) for each LPA. Each line shows one LPA (one for each instance of the SeeBeyond Listener program). The fields on the screen are as follows:

- ◆ **sckt nbr:** the socket number that is passed to the SeeBeyond Listener.
- ◆ **Listener applid:** the applid of the CICS region that the IBM Listener is executing in that started this instance of the SeeBeyond Listener.
- ◆ **Listener tasked:** the CICS taskid for the IBM Listener program that started this instance of the SeeBeyond Listener.
- ◆ **userid:** userid passed in from the CICS eWay.
- ◆ **password:** user password passed in from the CICS eWay.
- ◆ **comm. Timeout:** this timeout value is the threshold limit for waiting for all the bytes of an incoming message.
- ◆ **Listener timeout:** this timeout value is the threshold limit for waiting for a new incoming message.
- ◆ **poll rate:** how many times the SeeBeyond Listener will perform a receive loop to satisfy a complete message receive, after which it will wait one second before trying again.
- ◆ **socket family:** the TCP/IP family to which this socket belongs.
- ◆ **socket port:** the port this instance of the SeeBeyond Listener is using.

Press PF20. The **Status Code Information** screen appears as displayed in [Figure 18 on page 33](#).



**Figure 18**

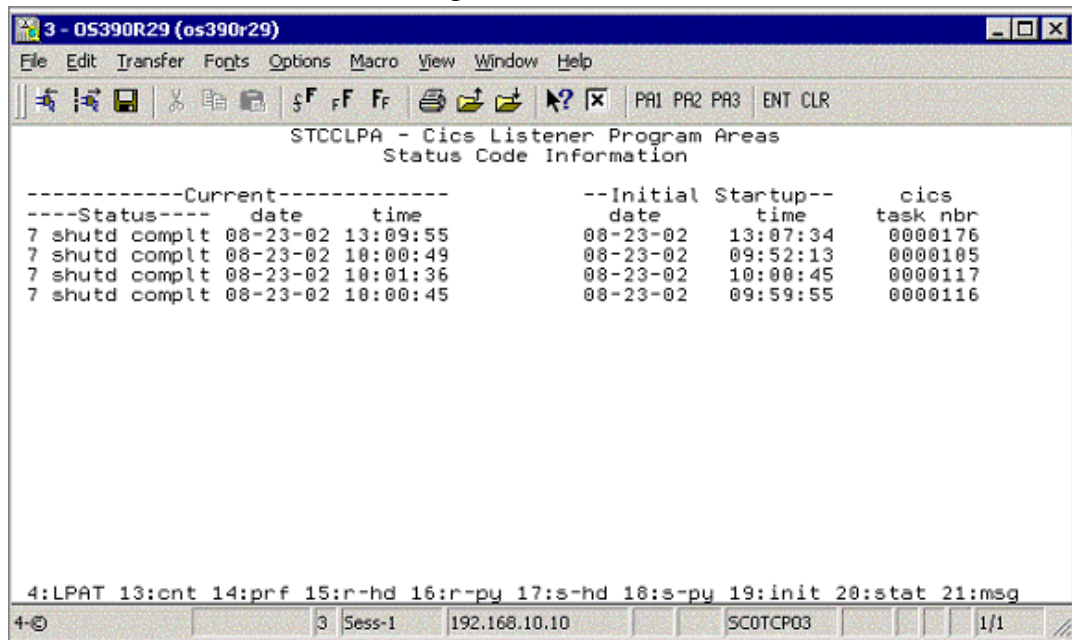

12 This screen (Figure 18) shows the status information for each LPA. Each line shows one LPA (one for each instance of the SeeBeyond Listener program). The fields on the screen are as follows:

- ♦ **Current status:** the current status of an active SeeBeyond Listener program, or the last known status of a previously executing SeeBeyond Listener program.
  - ♦ C = LPA is initialized.
  - ♦ E = about to get ezacic02 data.
  - ♦ G = about to take socket from IBM Listener program.
  - ♦ I = about to set mode to blocking.
  - ♦ K = about to send ack for init request.
  - ♦ M = peeking for length of next incoming request.
  - ♦ O = peeking for entire incoming request.
  - ♦ Q = receiving full incoming request message.
  - ♦ S = sending ack for application request.
  - ♦ U = linking to requested application program.
  - ♦ W = starting a request application transaction.
  - ♦ Y = sending a application response.
  - ♦ 0 = peeking for application response ack.
  - ♦ 2 = receiving an application response ack.
  - ♦ 4 = a shutdown request has been received.
  - ♦ 6 = sending an ack for the shutdown request.

- ♦ 7 = shutdown is complete, this LPA is now available for reuse.
  - ♦ 8 = SeeBeyond Listener program appended.
  - ♦ **Current Status date:** date for this status.
  - ♦ **Current Status time:** time for this status.
  - ♦ **Initial Startup date:** date this instance of the SeeBeyond Listener was started.
  - ♦ **Initial Startup time:** time this instance of the SeeBeyond Listener was started.
  - ♦ **cics task nbr:** the CICS eibtaskn for this instance of the SeeBeyond Listener.
- Press **PF21**. The **Error Message Sent** screen appears as displayed in Figure 19.

Figure 19

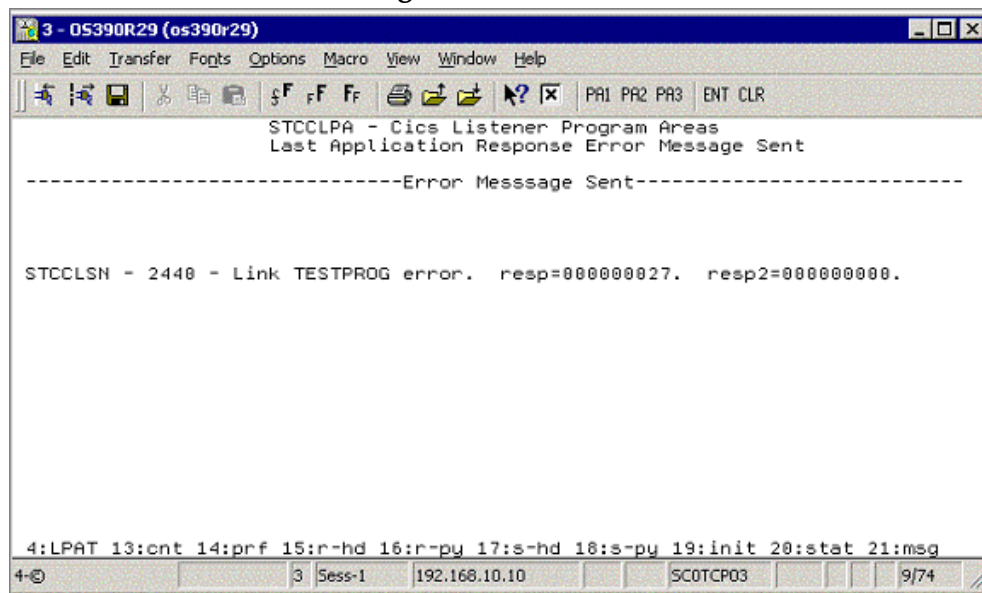

- 13 This screen (Figure 19) shows the last error message sent to the CICS eWay for each LPA. Each line shows one LPA (one for each instance of the SeeBeyond Listener program). There is one field on the screen:

**Error Message Sent:** the last error message sent to the CICS eWay for this instance of the SeeBeyond Listener program.

## 2.4 CICS Listener Considerations for Invoking DB2 Applications

One of the following two techniques are required when using the CICS eWay to run CICS applications that invoke a DB2 table:

- RCT entry for the STCL SeeBeyond CICS Listener Transaction
- PPT entry to redirect DB2 application to another AOR

## RCT entry for the STCL SeeBeyond CICS Listener Transaction

To run DB2 application programs under the STCL SeeBeyond CICS Listener transid, an RCT entry for the STCL transaction must be created using an RCT macro definition similar to the one shown below or by using an equivalent RDO entry.

```
DSNCRCT TYPE=ENTRY, TXID=STCL, THRDM=0, THRDA=0, THRDS=0,  
TWAIT=POOL, PLAN=HD45LE06, AUTH=(SIGNID, *, *)
```

## PPT entry to redirect DB2 application to another AOR

To redirect DB2 application programs to another AOR, the PPT entry for the requested DB2 application program in the TOR (where the STCL SeeBeyond CICS Listener transaction is running) must be defined to run the DB2 application program in a different region (usually an AOR) and under a specific PCT in that AOR. Refer to [Figure 20 on page 36](#) for a detailed flow diagram showing the use of the PPT and PCT.

**Figure 20** SeeBeyond CICS Listener invoking DB2 programs

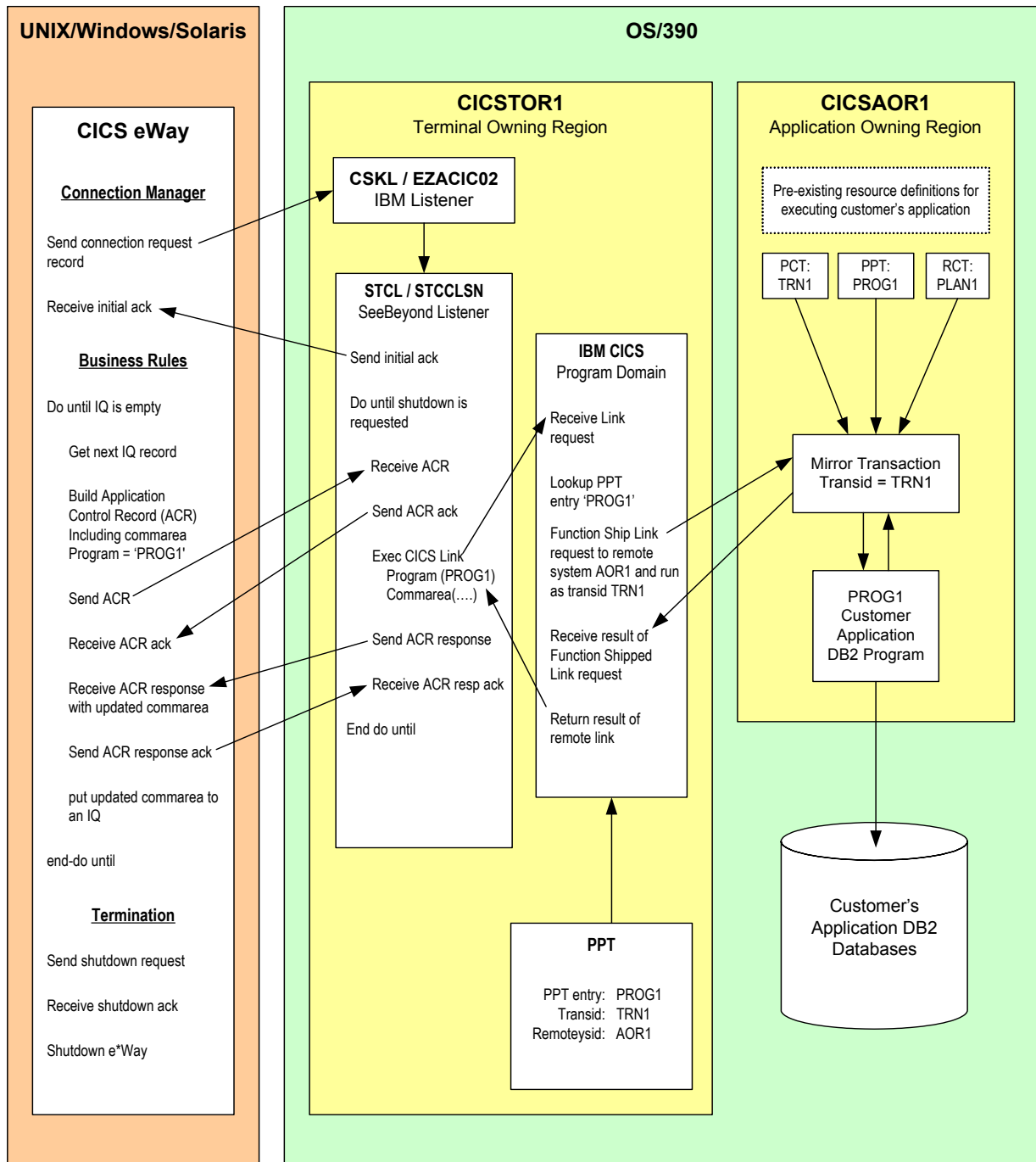

# Configuring the CICS eWay

This chapter describes how to create and configure the CICS eWay properties.

## Chapter Topics

- [Creating and Configuring the CICS eWay](#) on page 37
- [Using the Properties Sheet](#) on page 38
- [CICS eWay Connectivity Map Configuration Properties](#) on page 40
- [CICS eWay Environment Explorer Configuration Properties](#) on page 43

---

## 3.1 Creating and Configuring the CICS eWay

All eWays contain a set of parameters with properties unique to that eWay type. After the eWays are established and a CICS External System is created in the project's Environment, the eWay parameters can be modified for your specific system. The CICS eWay parameters are modified from two locations:

- From the **Connectivity Map**. These parameters most commonly apply to a specific component eWay, and may vary from other eWays (of the same type) in the project.
- From the **Environment Explorer tree**. These parameters are commonly global, applying to all eWays (of the same type) in the project. The saved properties are shared by all eWays in the CICS External System window.

### 3.1.1 Selecting CICS as the External Application

To create a CICS eWay you must first create a CICS External Application in your Connectivity Map. CICS eWays are located between a CICS External Application and a Service. Services are containers for Collaborations, Business Processes, eTL processes, and so forth.

#### To create the CICS External Application

- 1 From the Connectivity Map toolbar, click the **External Applications** icon.
- 2 Select the **CICS External Application** from the menu (see [Figure 21 on page 38](#)). The selected CICS External Application icon appears on the Connectivity Map toolbar.

Figure 21 External Applications Selection Menu

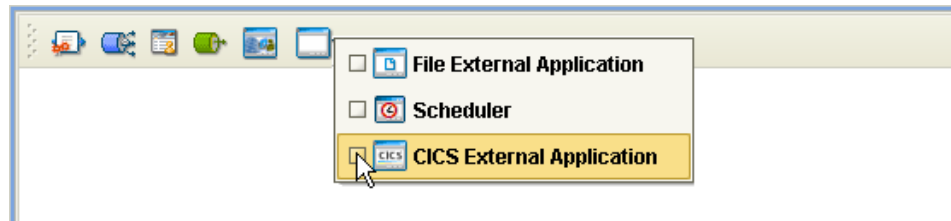

- 3 Drag the new **CICS External Application** from the toolbar onto the Connectivity Map canvas. This represents an external CICS system.

From the Connectivity Map, you can associate (bind) the External Application with the Service to establish an eWay (see Figure 22).

Figure 22 eWay Location.

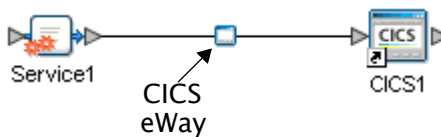

When CICS is selected as the External Application, it automatically applies the default CICS eWay properties, provided by the OTD, to the eWay that connects it to the Service. These properties can then be or modified for your specific system using the **Properties Sheet**.

### 3.1.2 Modifying the CICS eWay Properties

A project's eWay properties can be modified after the eWays have been established in the Connectivity Map and the Environment has been created.

#### Modifying the CICS eWay (Connectivity Map) Properties

- 1 From the Connectivity Map, double click the eWay icon, located in the link between the associated External Application and the Service.
- 2 The eWay **Properties Sheet** opens with the CICS eWay Connectivity Map properties. Make any necessary modifications and click **OK** to save the settings.

#### Modifying the CICS eWay (Environment Explorer) Properties

- 1 From the Environment Explorer tree, right-click the CICS External System. Select **Properties** from the shortcut menu. The **Properties Sheet** opens with the CICS eWay Environment properties.
- 2 Make any necessary modifications to the Environment properties of the CICS eWays, and click **OK** to save the settings.

### 3.1.3. Using the Properties Sheet

Modifications to the eWay configuration properties are made from the CICS eWay Properties Sheet.

### To modify the default eWay configuration properties

- 1 Open the Properties Sheet to the CICS eWay default properties. An eWay has two different sets of parameters: those specific to that particular eWay (accessed from the Connectivity Map), and those that are common to all eWays of this type (accessed from the Environment Explorer tree).
- 2 From the upper-right pane of the Properties Sheet, select a subdirectory of the configuration directory. The parameters contained in that subdirectory are now displayed in the Properties pane of the Properties Sheet. For example, clicking on the **connector** subdirectory displays the editable parameters in the right pane, as shown in Figure 23.

Figure 23 Properties Sheet -- CICS Properties

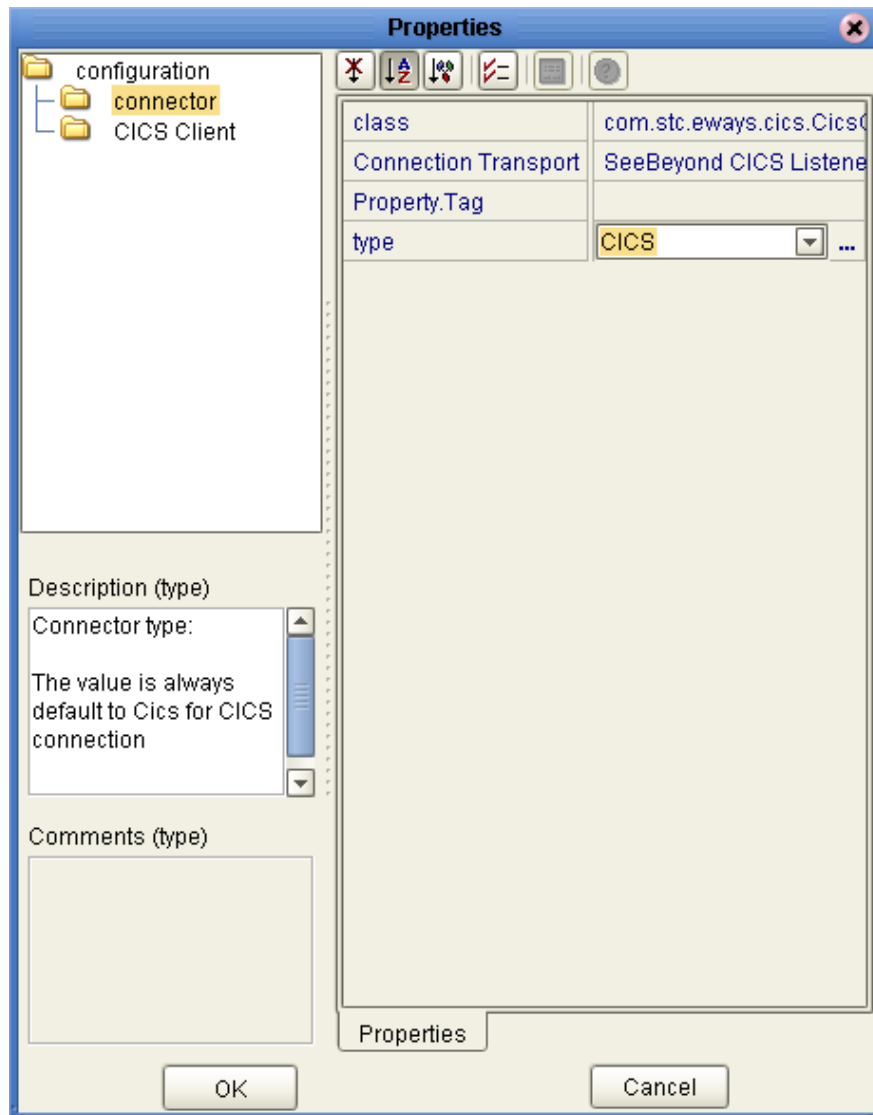

- 3 Click on any property field to make it editable. For example, click on the **class** parameter to edit the class value. If a parameter's value is true/false or multiple choice, the field reveals a submenu of property options.

Click on the ellipsis (. . .) in the properties field to open a separate configuration dialog box. This is helpful for large values that cannot be fully displayed in the parameter's property field. Enter the property value in the dialog box and click **OK**. The value is now displayed in the parameter's property field.

- 4 A description of each parameter is displayed in the **Description** pane when that parameter is selected, providing an explanation of any required settings or options.
- 5 The **Comments** pane provides an area for recording notes and information regarding the currently selected parameter. This is saved for future referral.
- 6 After modifying the configuration properties, click **OK** to close the Properties Sheet and save the changes.

---

## 3.2 CICS eWay Connectivity Map Configuration Properties

The CICS eWay configuration parameters, accessed from the Connectivity Map, are organized into the following sections:

- **Connector** on page 40
- **CICS Client** on page 41

### 3.2.1. Connector

This section contains a set of top level parameters:

- **Class** on page 40
- **Connection Transport** on page 40
- **Property.Tag** on page 41
- **Type** on page 41

#### Class

##### Description

Specifies the class name of the CICS Client connector object.

##### Required Value

The valid (class) package name for the CICS Client connector object. The default is `com.stc.eways.cics.CicsClientConnector`.

#### Connection Transport

##### Description

Specifies the underlying connection transport used by the CICS eWay. The **SeeBeyond CICS Listener** is the underlying transport to send requests to and get responses from a CICS region.



### Required Value

Enter the name of the selected underlying connection transport as follows:

#### **SeeBeyond CICS Listener**

SeeBeyond CICS Listener is the default.

### Property.Tag

#### Description

Specifies the data source identity. This parameter is required by the current EBobConnectorFactory.

#### Required Value

The valid data source package name.

### Type

#### Description

Specifies the connector type.

#### Required Value

**CICS**. The value always defaults to **CICS** for CICS connections.

## 3.2.2. CICS Client

This section contains the following parameters for CICS Client setup:

- **CICS Program** on page 41
- **CICS TransId** on page 42
- **COMMAREA Length** on page 42
- **ECI call type** on page 42
- **ECI extend mode** on page 42
- **Encoding** on page 42

### CICS Program

#### Description

Specifies the CICS program to be run on the server. Maximum length is eight characters.

#### Required Value

A valid CICS program name, eight characters or less.

## CICS TransId

### Description

Specifies the CICS TransId to be run on the server. Maximum length is four characters.

### Required Value

A valid CICS TransId, four characters or less.

## COMMAREA Length

### Description

Specifies the length (in bytes) of the communication area (COMMAREA) passed to the ECI.

### Required Value

An integer in the range of 1 to 32659. The configured default is 1000.

## ECI call type

### Description

Specifies whether the ECI call type is Synchronous. Synchronous calls wait for the transaction to complete, then return the contents of the COMMAREA. Only Synchronous calls are supported

### Required Value

Synchronous is the configured default.

## ECI extend mode

### Description

Specifies whether a logical unit of work is terminated at the end of a call.

### Required Value

**Yes** or **No**. Yes indicates that the work unit is terminated at the end of a call. No is the configured default.

## Encoding

### Description

Specifies default encoding.

### Required Value

The canonical name for any encoding set supported by Sun's Java Runtime Environment 1.1.8 (contained in rt.jar and i18n.jar). Examples are ASCII and Cp500 (EBCDIC). When running the CICS eWay on z/OS platforms, encoding should be set to "ISO-8859-1".

---

## 3.3 CICS eWay Environment Explorer Configuration Properties

The CICS eWay configuration parameters, accessed from the Environment Explorer tree, are organized into the following sections:

- [SeeBeyond CICS Listener](#) on page 43
- [Tracing](#) on page 47
- [CICS Client](#) on page 47

### 3.3.1. SeeBeyond CICS Listener

These parameters are specific to the SeeBeyond CICS Listener. This section contains a set of top level parameters:

- [COMMAREA Padding Character](#) on page 43
- [Host](#) on page 44
- [KeepAlive](#) on page 44
- [Listener Timeout](#) on page 44
- [NoDelay](#) on page 44
- [Polling Rate](#) on page 45
- [Port](#) on page 45
- [ReceiveBufSize](#) on page 45
- [SeeBeyond CICS Listener TransId](#) on page 45
- [SendBufSize](#) on page 45
- [Start Delay](#) on page 46
- [Start Type](#) on page 46
- [TP Timeout](#) on page 46
- [Transport Timeout](#) on page 46

## COMMAREA Padding Character

### Description

Specifies the EBCDIC code for the character used by the SBYND listener to pad the COMMAREA at the CICS server when the actual length of the payload in the COMMAREA is shorter than the length given by CommAreaLength. The default value is hexadecimal 40 - EBCDIC space.

### Required Value

- A character value coded in Hexadecimal. For example: 40 for Blanks, 00 for Low Values, FF for High Values, and so forth.

## Host

### Description

Specifies the name of the mainframe host with which to connect. This is always CICS.

### Required Value

CICS. The value always defaults to CICS for CICS connections. The default is CICS.

## KeepAlive

### Description

Specifies whether to enable socket keep-alive checking. A setting of TRUE enables an implementation specific time period when a probe is sent to the peer host. The purpose of this option is to detect if the peer host has crashed.

One of three responses is expected:

1. The peer responds with the expected ACK. The application is not notified (since everything is OK). TCP will send another probe following another 2 hours of inactivity.
2. The peer responds with an RST, which tells the local TCP that the peer host has crashed and rebooted. The socket is closed.
3. There is no response from the peer. The socket is closed.

### Required Value

Enter TRUE or FALSE. TRUE is the default.

## Listener Timeout

### Description

Specifies the estimated amount of time (in milliseconds) for the SeeBeyond CICS Listener to wait for the next incoming transaction program request from the CICS eWay.

### Required Value

An integer between 1 and 864000 representing milliseconds (for example, 120000 milliseconds equals 2 minutes). The default value is 5000.

## NoDelay

### Description

Specifies whether the system can delay connections or requests. Generally, **NoDelay/True** is necessary for high-volume and/or critical transactions. In cases of low-volume and/or noncritical transactions, you can use **NoDelay/False**. Required Values

### Required Value

Enter **TRUE** or **FALSE**. TRUE is the default.

## Polling Rate

### Description

Specifies the polling rate. This is the number of times the SeeBeyond CICS Listener will query the current TCP connection for incoming traffic before issuing an EXEC CICS DELAY for one second.

### Required Value

An integer between 1 and 255 representing. The default value is 5.

## Port

### Description

Specifies the TCP/IP port where the SeeBeyond CICS Listener is listening. This is the port to which the CICS eWay will connect.

### Required Value

The TCP/IP port to which SeeBeyond CICS Listener is listening. The default is 3001.

## ReceiveBufSize

### Description

Specifies the Receive Buffer Size (in bytes) for the underlying socket, this is a hint.

### Required Value

An integer between 1 and 864000 representing bytes (for example, 10240 bytes equals 10 kilobytes). The default value is 4096.

## SeeBeyond CICS Listener TransId

### Description

Specifies the TransId of the SeeBeyond CICS Listener on the mainframe host. This is the CICS Transaction that the SeeBeyond CICS Listener is installed under.

### Required Value

The valid TransId of the SeeBeyond Cics Listener

## SendBufSize

### Description

Specifies the Send Buffer Size for the underlying socket.

### Required Value

An integer between 1 and 864000 representing bytes (for example, 10240 bytes equals 10 kilobytes). The default value is 4096.

## Start Delay

### Description

Specifies the hours, minutes and seconds (interval of time) to delay starting the transaction program (TP) on the CICS server for the **IC** Start Type. This field is optional but must specify all 6 digits if used.

### Required Value

A 6 digit integer. All 6 digits must be given if this is specified (for example, 000000).

## Start Type

### Description

Specifies the startup type. This can be either **IC** for CICS interval control or **TD** for CICS transient data. This is the CICS Startup type for the program being executed.

### Required Value

Select **IC** or **TD**.

## TP Timeout

### Description

Specifies the amount of time the CICS eWay will wait for the SeeBeyond CICS Listener to return results for a current transaction program request.

### Required Value

An integer between 1 and 864000 representing milliseconds (for example, 120000 milliseconds equals 2 minutes). The default value is 50000.

## Transport Timeout

### Description

Specifies the timeout used by both the local and host side for receive on the socket.

### Required Value

An integer between 1 and 864000 representing milliseconds (for example, 120000 milliseconds equals 2 minutes). The default value is 5000.

### 3.3.2. Tracing

This section contains the following parameters for CICS Client setup:

- **Timing** on page 47

#### Timing

##### Description

Specifies whether or not to display time-stamps in the trace.

##### Required Value

On or Off. On indicates that the time-stamp is displayed in the trace. The default setting is On.

### 3.3.3. CICS Client

This section contains the following parameters for CICS Client setup:

- **CICS Password** on page 47
- **CICS UserId** on page 47

#### CICS Password

##### Description

Specifies the password for the CICS user. Maximum length is eight characters.

##### Required Value

- A valid password for the user ID, eight characters or less.

#### CICS UserId

##### Description

Specifies the ID of the CICS user. Maximum length is eight characters.

##### Required Value

A valid CICS user ID, eight characters or less.

---

## 3.4 Alerting and Logging

eGate provides an alerting and logging feature. This allows monitoring of messages, and captures any adverse messages in order of severity based on configured severity level and higher.

For information on enabling or modifying the level of logging for the various logging categories, see the *eGate Integrator System Administration Guide*.

*The alerts/status notifications for the CICS eWay are currently limited to Started, Running, Stopping, and Stopped.*



# Using eInsight Business Processes with the CICS eWay

This chapter describes how to use the CICS eWay with the ICAN Suite's eInsight Business Process Manager and the Web Services interface.

*Note:* You must have the *eInsight.sar* file installed to use the Web Services interface.

### Chapter Topics

- [The eInsight Engine and Components](#) on page 49
- [The CICS eWay With eInsight](#) on page 50
- [The CICS eWay eInsight Sample Project](#) on page 50

---

## 4.1 The eInsight Engine and Components

eGate components can be deployed as Activities in eInsight Business Processes. Once a component is associated with an Activity, eInsight invokes it using a Web Services interface. eGate components that can interface with eInsight in this way include the following:

- Object Type Definitions (OTDs)
- eWays
- Collaborations

Using the Enterprise Designer and eInsight, you can add an Activity to a Business Process, then associate that Activity with an eGate component, for example, an eWay. Then, when eInsight runs the Business Process, it automatically invokes that component via its Web Services interface.

See the *eInsight Business Process Manager User's Guide* for details.

---

## 4.2 The CICS eWay With eInsight

An eInsight Business Process Activity can be associated with the CICS eWay during the system design phase. To make this association, select the desired operators under the eWay in the Enterprise Explorer and drag it onto the eInsight Business Process Designer canvas.

The CICS eWay has the following operators available:

- execute

The operation is automatically changed to an Activity with an icon identifying the component that is the basis for the Activity. At run time, eInsight invokes each step in the order defined in the Business Process. Using eInsight's Web Services interface, the Activity in turn invokes the CICS eWay.

---

## 4.3 The CICS eWay eInsight Sample Project

The following pages provide directions for creating a simple project that demonstrates how eInsight Business Processes are used with the CICS eWay. The same project can be downloaded from the Installation CD-ROM in a near-complete state.

For more information on creating ICAN projects see the *eInsight Business Process Manager User's Guide* and the *eGate Integrator User's Guide*.

---

## 4.4 Importing a Sample Project

Sample eWay projects are included as part of the installation CD-ROM package. To import a sample eWay project to the Enterprise Designer do the following:

- 1 The sample files are uploaded with the eWay's documentation .sar file and downloaded from the Enterprise Manager's Documentation tab. Extract the samples from the Enterprise Manager to a local file.
- 2 From the Enterprise Designer's Project Explorer pane, right-click the Repository and select **Import** from the shortcut menu. The **Import Manager** appears.
- 3 Browse to the directory that contains the sample project zip file. Select the sample file (for this sample, **CICS\_BP\_Sample.zip**) and click **Import**. After the sample project is successfully imported, click **Close**.
- 4 When the import has successfully completed, right-click the Repository and select **Refresh All from Repository** from the shortcut menu.
- 5 Before the imported sample project can be run you must do the following:
  - ♦ Create an **Environment** (see [Creating an Environment](#) on page 59)

- ◆ Configure the eWay properties for your specific system (see [Configuring the eWay Properties](#) on page 60)
- ◆ Create a **Deployment Profile** (see [Creating and Activating the Deployment Profile](#) on page 62)

The following pages provide step by step directions for manually creating the CICS\_BP\_Sample project.

---

## 4.5 The CICS\_BP\_Sample Project Overview

The CICS eWay project, **CICS\_BP\_Sample**, demonstrates the following:

- The Inbound File eWay subscribes to an external directory and receives input data (ASCII text).
- The ASCII text data is converted to EBCDIC (byte array) using cp037 encoding, and published by the CICS eWay, to the CICS external system.
- Input EBCDIC data from the CICS external system, is received by the CICS eWay and converted back to String ASCII data using cp037 encoding. This data is published to the outbound File eWay.
- The outbound File eWay publishes the data to an external directory.

**Figure 24** CICS\_BP\_Sample Project

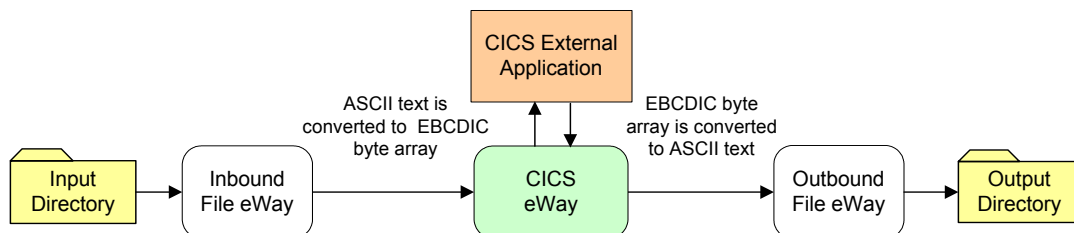

---

## 4.6 Creating the CICS\_BP\_Sample Project

The following pages provide step by step directions for creating the CICS\_BP\_Sample project.

### 4.6.1. Creating a Project

The first step is to create a new project in the SeeBeyond Enterprise Designer.

- 1 Start the Enterprise Designer.
- 2 From the Project Explorer tree, right-click the Repository and select **New Project** (see Figure 25). A new project (**Project1**) appears on the Project Explorer tree.

**Figure 25** Enterprise Explorer - New Project

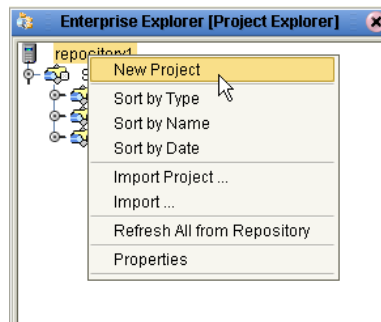

- 3 Click twice on **Project1** and rename the project (for this sample, **CICS\_BP\_Sample**).

## 4.6.2 Creating a Business Process

To create the CICS eInsight Business Process, do the following:

### Creating the Business Process Flow

- 1 Right-click an existing project (for this sample **CICS\_BP\_Sample**) in the Enterprise Designer's Project Explorer, and select **New > Business Process** from the shortcut menu. The eInsight Business Process Designer appears and **BusinessProcess1** is added to the Project Explorer tree. Rename **BusinessProcess1** to **CICS\_BP**.
- 2 From the Project Explorer tree, expand the SeeBeyond > eWays > CICS\_eWay > CICS\_eWay, and File > FileClient nodes.
- 3 Populate the eInsight Business Process Designer's modeling canvas with the following activities from the Project Explorer tree, as displayed in [Figure 26 on page 53](#):
  - ♦ **receive**, under SeeBeyond > eWays > File > FileClient
  - ♦ **execute**, under SeeBeyond > eWays > CICS\_eWay > CICS\_eWay
  - ♦ **write**, under SeeBeyond > eWays > File > FileClient

**Figure 26** eInsight Business Process Designer - Populate the Canvas

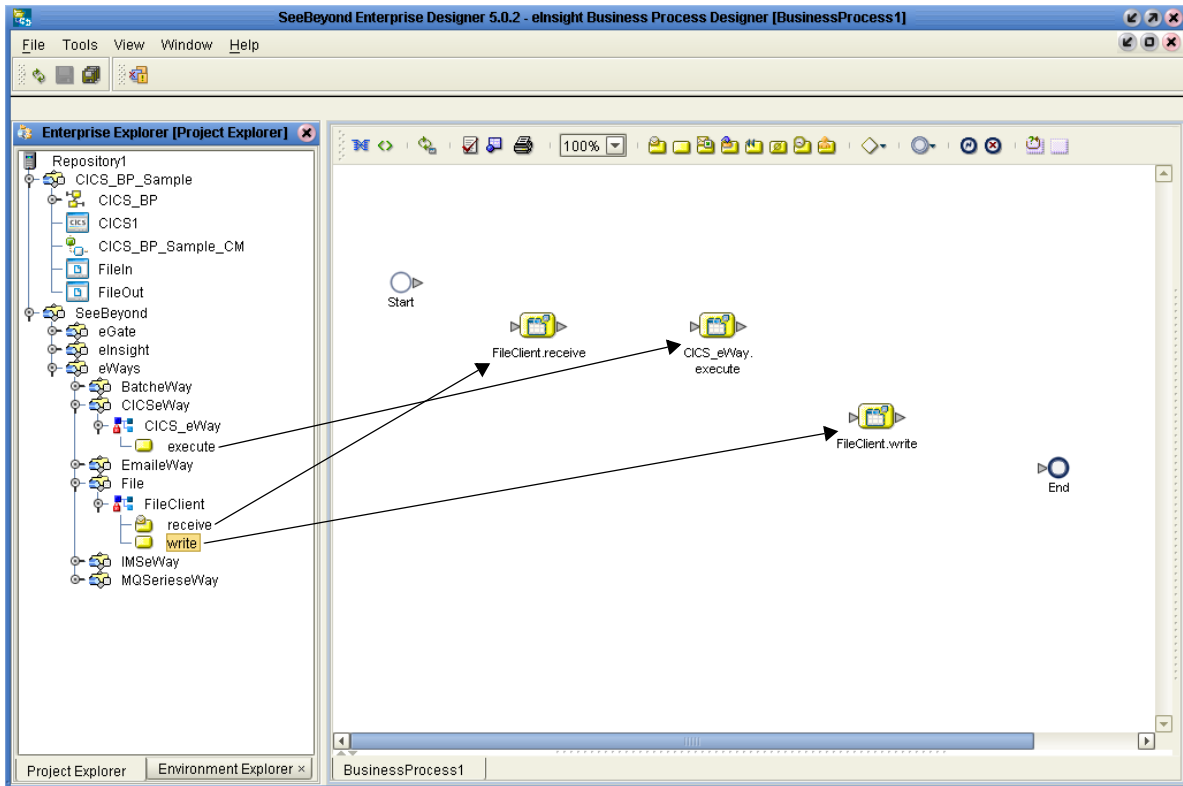

- 4 Link the modeling elements by clicking on the element connector and dragging the cursor to the next element connector, making the following links as displayed in Figure 27.
  - Start -> FileClient.receive
  - FileClient.receive -> CICS\_eWay.execute
  - CICS\_eWay.execute -> FileClient.write
  - FileClient.write -> End

**Figure 27** Business Process Designer - Link the Modeling Elements

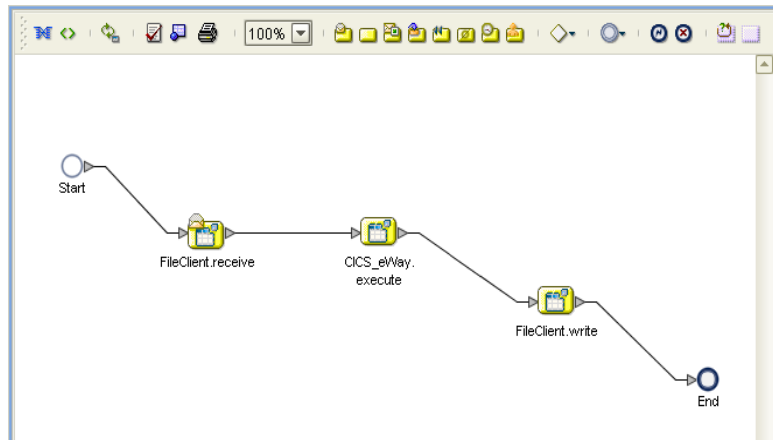

## Configuring the Modeling Elements

Business Rules, created between the Business Process Activities, allow you to configure the relationships between the input and output Attributes of the Activities using the Business Process Designer's Business Rule Designer.

### Adding Business Rules

- 1 Right-click the link between the **FileClient.receive** and **CICS\_eWay.execute** Activities and select **Add Business Rule** from the shortcut menu.
- 2 Repeat step 1 for the **CICS\_eWay.execute** to **FileClient.write** link (see Figure 28).

**Figure 28** eInsight Business Process Designer - Adding Business Rules

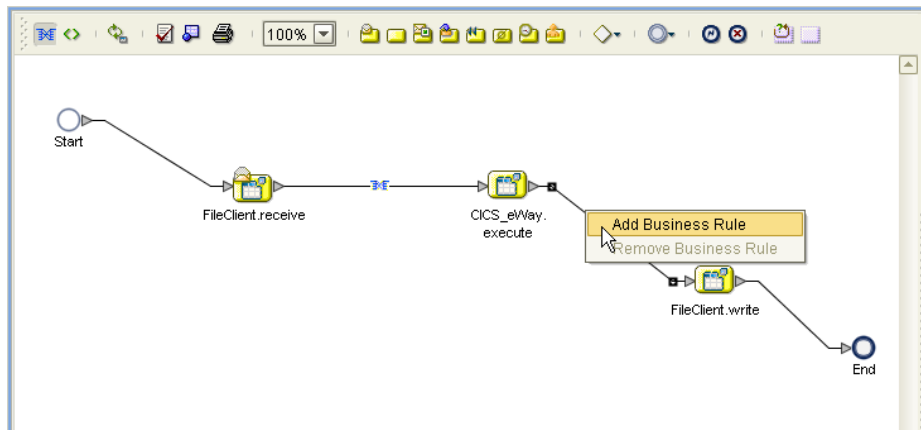

### Using the Business Rule Designer

- 1 From the eInsight Business Process Designer toolbar, click the **Map Business Process Attributes** button. The Business Rule Designer appears at the bottom of the eInsight Business Process Designer.
- 2 Click on the Business Rule icon in the link between **FileClient.receive** and **CICS\_eWay.execute** to display the Business Rule's Input and Output Attributes in the Business Rule Designer. These Attributes can now be modified.
- 3 From the Business Rule Designer toolbar, click the Method Palette icon (see Figure 29). The Method Palette appears. From the **String** tab, select **bytes to text** and **text to bytes**, and click **Close**. The **bytes to text** and **text to bytes** icons are added to the toolbar.
- 4 Drag the **text to bytes** icon to the Business Rule Designer canvas. The **text to bytes** method box appears on the Business Rule Designer canvas (see Figure 29).

**Figure 29** eInsight Business Rule Designer

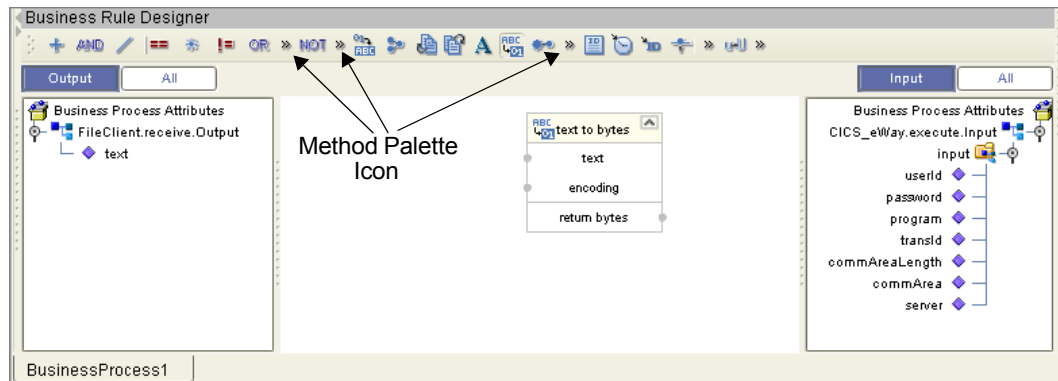

- 5 Map **text**, under FileClient.receive.Output to the **text** input node of the text to bytes method box by clicking on **text** under **FileClient.receive.Output** in Output pane of the Business Rule Designer, and dragging the cursor to the **text** input node of the **text to bytes** method box. A line is displayed between the two.
- 6 Map **return bytes** in the **text to bytes** method box, to **commArea** under **CICS\_eWay.execute.Input > Input** in the Input pane of the Business Rule Designer.
- 7 Drag the **string-literal** icon from the Business Rule Designer toolbar to the Business Rule Designer canvas. The **Input** dialog box appears. Enter **cp037** as the literal value. The string-literal method box is displayed in the Business Rule Designer.
- 8 Map the string-literal value, **cp037**, to the encoding input node of the **text to bytes** method box (see Figure 30).

**Figure 30** eInsight Business Rule Designer

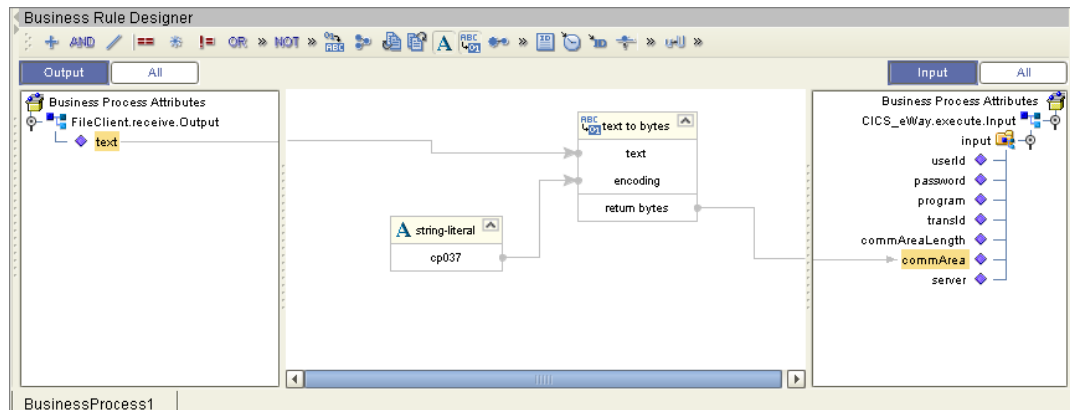

- 9 From the Enterprise Explorer, right-click the Repository and select **Save Changes into Repository** from the shortcut menu, to save your current changes.
- 10 To configure the second Business Rule, click on the Business Rule icon in the link between the **CICS\_eWay.execute** and **FileClient.write** Activities. This Business Rule is now displayed (to be modified) in the Business Rule Designer.
- 11 From the Business Rule Designer toolbar, drag and drop the **bytes to text** icon to the Business Rule Designer canvas. The **bytes to text** method box appears.

- 12 Map **commArea**, under **CICS\_eWay.execute.Output** > **output** in the Output pane, to the **bytes** input node of the **bytes to text** method box.
- 13 Map the **return text** output node of the **bytes to text** method box, to **text** under **FileClient.write.Input** in the Input pane.
- 14 Drag the **string-literal** icon from the Business Rule Designer toolbar to the Business Rule Designer. The **Input** dialog box appears. Enter **cp037** as the literal value. The string-literal method box is displayed in the Business Rule Designer.
- 15 Map the string-literal value, **cp037**, to the **encoding** input node of the **bytes to text** method box (see Figure 31).

Figure 31 eInsight Business Rule Designer

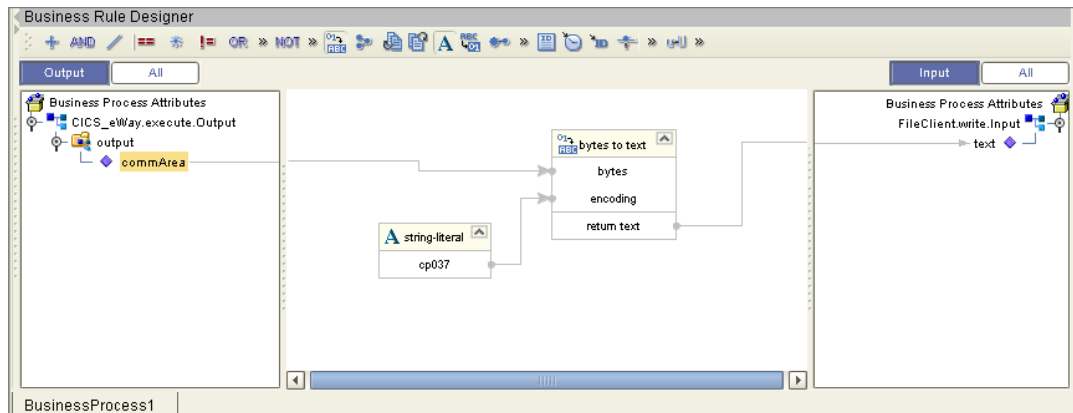

- 16 From the Business Process Designer toolbar, click the **Synchronize Graphical Model and Business Process** icon to synchronize the graphical interface to the Business Process code.
- 17 Save your changes to the Repository.

### 4.6.3 Creating a Connectivity Map

The Connectivity Map provides a canvas for assembling and configuring a project's components.

- 1 From the Project Explorer tree, right-click the new **CICS\_BP\_Sample** project and select **New > Connectivity Map** from the shortcut menu.
- 2 The New Connectivity Map appears and a node for the Connectivity Map is added under the project on the Project Explorer tree labeled **CMap1**. Rename the Connectivity Map **CICS\_BP\_Sample\_CM**.

The icons in the toolbar represent the available components used to populate the Connectivity Map canvas.



## Selecting the External Applications

In the Connectivity Map, the eWays are associated with External Systems. For example, to establish a connection to CICS, you must first select CICS as an External System to use in your Connectivity Map (see Figure 32).

**Figure 32** Connectivity Map - External Applications

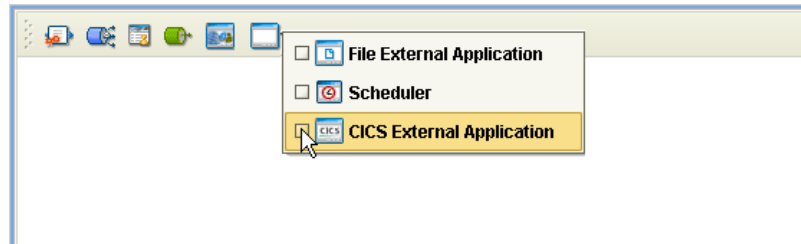

- 1 Click the **External Application** icon on the Connectivity Map toolbar,
- 2 Select the external systems necessary to create your project (for this sample, **CICS** and **File**). Icons representing the selected external systems are added to the Connectivity Map toolbar.

## Populating the Connectivity Map

Add the project components to the Connectivity Map by dragging the icons from the toolbar to the canvas.

- 1 For this sample, drag the following components onto the Connectivity Map canvas as displayed in Figure 33:
  - ♦ **File External System** (2)
  - ♦ **Service** (A service is a container for Collaborations, Business Processes, eTL processes, and so forth)
  - ♦ **CICS External System**

**Figure 33** Connectivity Map with Components

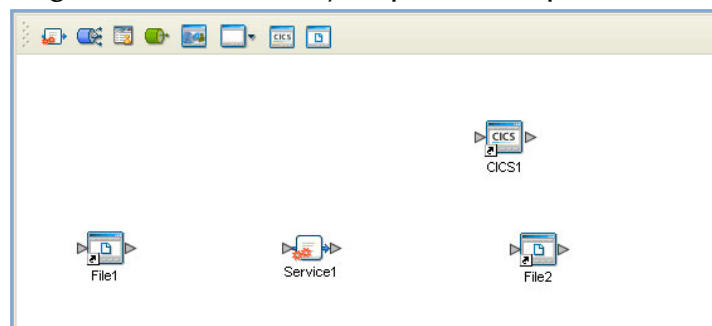

- 2 Rename the **File1** External Application to **FileIn** by right-clicking the object, selecting **Rename** from the shortcut menu, and typing in the new name.
- 3 Rename the **File2** External Application to **FileOut**.
- 4 Save your current changes to the Repository.

### 4.6.4. Binding the eWay Components

After the Business Processes have been completed, the components are associated and Bindings are created in the Connectivity Map.

- 1 From the Project Explorer, double-click **CICS\_BP\_Sample\_CM**. The Enterprise Designer canvas now displays the Connectivity Map.
- 2 Drag and drop the **CICS\_BP** Business Process from the Project Explorer onto the Service (**Service1**). If the Business Process was successfully associated, the Service's icon changes to a Business Process icon (see Figure 34).

**Figure 34** Connectivity Map - Binding the eWay Components

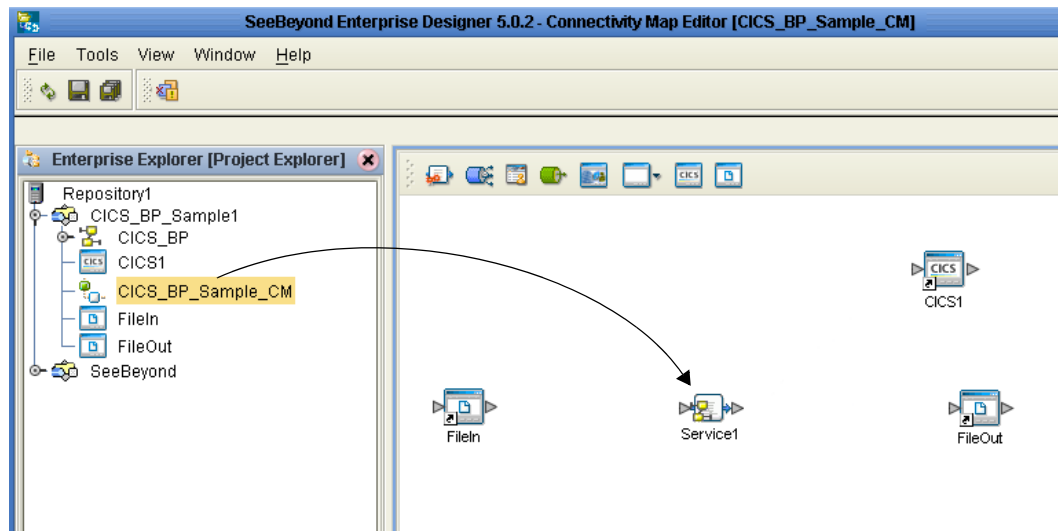

- 3 Double-click **Service1**. The **Service1 Binding dialog box** appears using the **CICS\_BP** Rule.
- 4 From the Service1 Binding dialog box, drag **FileSender** (under Implemented Services) to the **FileIn** (File) External Application.
- 5 From the Service1 Binding dialog box, drag **CICS\_Receiver** (under Invoked Services) to the **CICS1** External Application.
- 6 From the Service1 Binding dialog box, drag **FileReceiver** to the **FileOut** External Application (see [Figure 35 on page 59](#)). Minimize the Service1 Binding dialog box by clicking the chevrons in the upper-right corner.

**Figure 35** Connectivity Map - Associating (Binding) the Project's Components

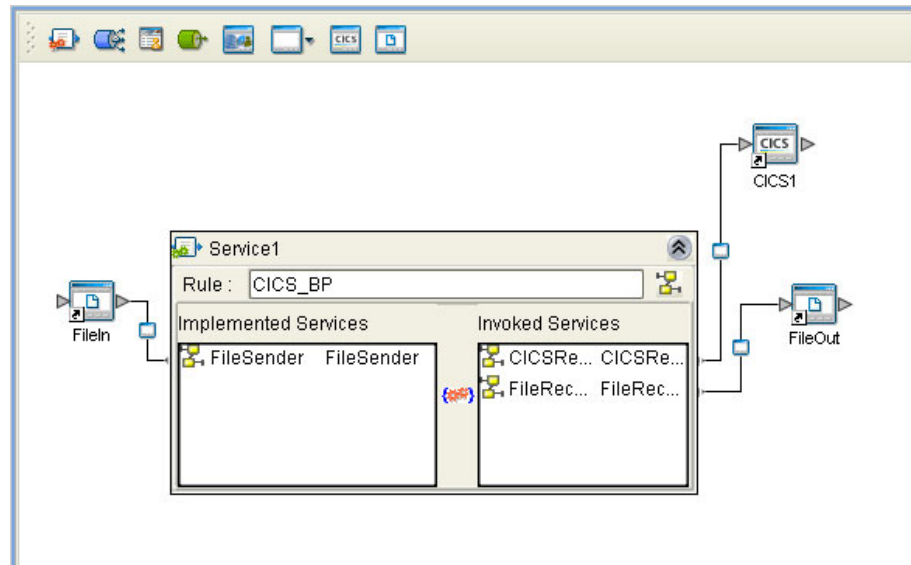

- 7 Minimize the Service1 Binding dialog box by clicking the chevrons in the upper-right corner.
- 8 Save your current changes to the Repository.

#### 4.6.5. Creating an Environment

Environments include the external systems, Logical Hosts, integration servers and message servers used by a project and contain the configuration information for these components. Environments are created using the Enterprise Designer's Environment Explorer and Environment Editor.

- 1 From the Enterprise Designer's Enterprise Explorer, click the **Environment Explorer** tab.
- 2 Right-click the Repository and select **New Environment**. A new Environment is added to the Environment Explorer tree.
- 3 Rename the new Environment to **CICS\_BP\_Sample\_ENV**.
- 4 Right-click **CICS\_BP\_Sample\_ENV** and select **New CICS External System**. Name the External System **CicsExtSys**. Click **OK**. **CicsExtSys** is added to the Environment Editor.
- 5 Right-click **CICS\_BP\_Sample\_ENV** and select **New File External System**. Name the External System **FileExtSysIn** and select **Inbound File eWay** as the **External System Type**. Click **OK**. **FileExtSysIn** is added to the Environment Editor.
- 6 Right-click **CICS\_BP\_Sample\_ENV** and select **New File External System**. Name this External System **FileExtSysOut** and select **Outbound File eWay** as the **External System Type**. **FileExtSysOut** is added to the Environment Editor.
- 7 Right-click **CICS\_BP\_Sample\_ENV** and select **New Logical Host**. The **LogicalHost1** box is added to the Environment and **LogicalHost1** is added to the Environment Editor tree.

- 8 From the Environment Explorer tree, right-click **LogicalHost1** and select **New SeeBeyond Integration Server**. A new Integration Server (**IntegrationSvr1**) is added to the Environment Explorer tree under LogicalHost1.
- 9 Save changes to the repository. The Environment Explorer and Environment Editor now appear as displayed in **Figure 36 on page 60**.

**Figure 36** Environment Editor

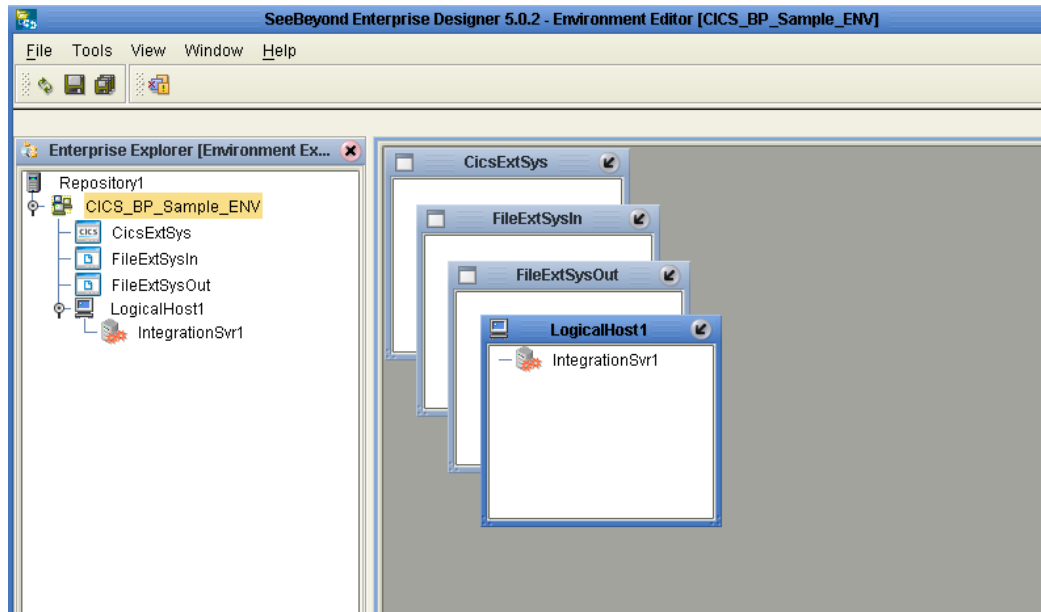

#### 4.6.6. Configuring the eWay Properties

The CICS\_BP\_Sample project uses three eWays, each represented in the Connectivity Map as a node between an External Application and a Business Process. eWays facilitate communication and movement of data between the external applications and the eGate system.

The File eWay properties are configured from the Connectivity Map. The CICS eWay configuration parameters are set from both the Project Explorer's Connectivity Map and the Environment Explorer tree.

To configure the eWays do the following:

#### Configuring the File eWay Properties

- 1 Double-click the inbound **File eWay** (see **Figure 37 on page 61**), select **Inbound File eWay** in the Templates dialog box and click **OK**.

Figure 37 eWays

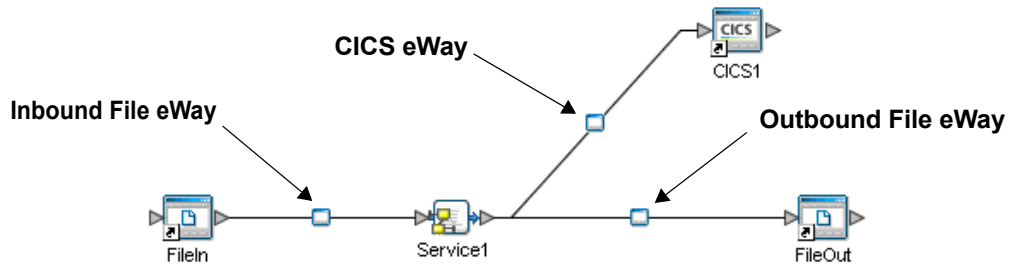

- 2 The **Properties Sheet** opens to the inbound File eWay properties. Modify the properties for your system, including the settings for the inbound File eWay in Table 2, and click **OK**.

Table 2 Inbound File eWay Settings

Inbound eWay Connection Parameters	
Directory	C:/temp
Input file name	Input*.txt

- 3 In the same way, modify the outbound File eWay properties for your system, including the settings in Table 3, and click **OK**.

Table 3 Outbound File eWay Settings

Outbound eWay Connection Parameters	
Directory	C:/temp
Output file name	output%.dat

## Configuring the CICS eWay Properties

The CICS eWay properties must be set in both the Project Explorer’s Connectivity Map and Environment Explorer. For more information on the CICS eWay properties and the Properties Sheet, see [Creating and Configuring the CICS eWay](#) on page 37 or see the *eGate Integrator User’s Guide*.

### Modifying the CICS eWay Connectivity Map Properties

- 1 From the **Connectivity Map**, double-click the **CICS eWay**. The **Parameters** dialog box opens to the CICS eWay project configuration properties.
- 2 Modify the CICS eWay Connectivity Map properties for your system, including the settings in [Table 4 on page 62](#), and click **OK**.

**Table 4** CICS eWay Connectivity Map Properties

CICS eWay (Connectivity Map) Properties	
<b>Connector</b> Set as directed, otherwise use the default settings	
Class	com.stc.eways.cics.CicsClientConnector
Connection Transport	SeeBeyond CICS Listener
Type	CICS
<b>CICS Client</b> Set as directed, otherwise use the default settings.	
COMMAREA Length	1000
CICS Program	<i>CICS program to be run on server</i>

### Modifying the CICS eWay Environment Explorer Properties

- 1 From the **Environment Explorer** tree, right-click the CICS External System (**CicsExtSys** in this sample), and select **Properties** from the shortcut menu. The Properties Sheet appears.
- 2 Modify the CICS eWay environment properties for your system, including the settings in Table 5, and click **OK**.

**Table 5** CICS Environment Explorer eWay Properties

CICS eWay Environment Properties	
<b>SeeBeyond CICS Listener Settings</b> Set as directed, otherwise use the default settings	
Host	<i>Host Name</i>
Port	<i>TCP/IP Port Number</i>
<b>CICS Client Settings</b> Set as directed, otherwise use the default settings.	
CICS Password	<i>Password of CICS user</i>
CICS UserId	<i>This is the Id of the CICS user</i>

## 4.6.7 Creating and Activating the Deployment Profile

Deployment Profiles are specific instances of a project in a particular Environment. A Deployment Profile contains information about the assignment of Services and message destinations to integration and message servers (JMS IQ Managers). It also contains version information for all versionable objects in the project. Deployment profiles are created using the Deployment Editor.

To create the CICS\_BP\_Sample Deployment Profile do the following:

- 1 From the Enterprise Explorer's Project Explorer, right-click the project (**CICS\_BP\_Sample**) and select **New > Deployment Profile** from the shortcut menu.

- 2 Enter a name for the Deployment Profile (for this sample **CICS\_BP\_Sample\_DP**). Make sure that the selected Environment is **CICS\_BP\_Sample\_ENV**. Click **OK**. The Deployment Profile Editor appears.
- 3 From the left pane of the Deployment Editor, drag the **FileIn -> Service1** (external application) object to the **FileExtSysIn** window.
- 4 Drag the **Service1 -> FileOut** (external application) object to the **FileExtSysOut** window.
- 5 Drag the **Service1 -> CICS1** (external application) to the **CicsExtSys** window.
- 6 Drag the **Service1** object to **IntegrationSvr1** in the **Logicalhost1** window (see Figure 38).

**Figure 38** Deployment Profile

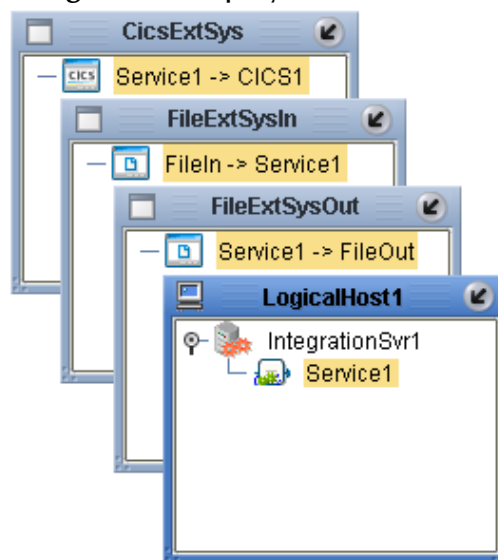

- 7 Click **Activate**. When activation succeeds, save the changes to the Repository.

### 4.6.8. Running the Project

The following directions assume that the Enterprise Designer was downloaded to C:\ican50. If this is not the case, replace that location in the following directions with the appropriate location.

- 1 From the Enterprise Manager Downloads tab, download **Local Host**.
- 2 Extract the file to the **ican50\LogicalHost1** directory. You must specify the **LogicalHost1** directory for it to be created.
- 3 Navigate to **C:\ican50\LogicalHost1\bootstrap\config** directory and open the **logical-host.properties** file using Notepad™.
- 4 Enter the following information in the appropriate fields:
  - ♦ Logical Host root directory: **ican50\LogicalHost1**
  - ♦ Repository URL: **http://localhost:port number/repository name**

- ♦ Repository user name and password: *Your user name and password*
- ♦ Logical Host Environment name: **CICS\_BP\_Sample\_Env**
- ♦ Logical Host name: **LogicalHost1**

Save your changes to **logical-host.properties** and close the file.

- 5 Run the **bootstrap.bat** file in the eGate50\LogicalHost1\bootstrap\bin directory.
- 6 Copy the sample input data file to the input directory.



# Implementing a CICS eWay Project

This chapter provides an introduction to the CICS eWay components and information on how these components are created and implemented in an eGate project. It is assumed that the reader understands the basics of creating a project using the SeeBeyond Enterprise Designer. For more information on creating an eGate project see the *eGate Tutorial* and the *eGate Integrator User's Guide*.

## Chapter Topics

- [CICS eWay Components](#) on page 65
- [CICS eWay Sample Projects](#) on page 66
  - ♦ [The CICS\\_JCE\\_Sample Project Overview](#) on page 67
  - ♦ [The CICS\\_COBOL\\_Sample Project](#) on page 83

---

## 5.1 CICS eWay Components

This chapter presents sample CICS eWay projects created using the same procedures as the sample end-to-end project provided in the *eGate Tutorial*. CICS eWay components that are unique to this eWay include the following:

### CICS eWay Configuration File

The configuration file for the CICS eWay contains the parameters that are used to connecting with a specific external system. These parameters are set using the **Parameters** dialog box. For more information about the CICS eWay Configuration File and the **Parameters** dialog box see [Creating and Configuring the CICS eWay](#) on page 37.

### CICS\_eWay.CICSClient OTD

The CICS\_eWay.CICSClient OTD is provided with the eWay and contains methods and attributes used to create the Business Rules that invoke the CICS program.

### Cobol Copybook Wizard

The Cobol Copybook Wizard allows the eGate Integrator to convert Cobol Copybook files into eGate Object Type Definition (OTD) files.

---

## 5.2 CICS eWay Sample Projects

Two sample projects are defined in the following sections.

- **CICS\_JCE\_Sample:** a simple project that demonstrates the CICS eWay receiving data from a file, passing the data to the CICS External System, and writing the output from the CICS System to another file.
- **CICS\_COBOL\_Sample:** demonstrates a simple CICS project that uses the Cobol Copybook Converter.

---

## 5.3 Importing a Sample Project

Sample eWay projects are included as part of the installation CD-ROM package. To import a sample eWay project to the Enterprise Designer do the following:

- 1 The sample files are uploaded with the eWay's documentation .sar file and downloaded from the Enterprise Manager's Documentation tab. Extract the samples from the Enterprise Manager to a local file.
- 2 From the Enterprise Designer's Project Explorer pane, right-click the Repository and select **Import** from the shortcut menu. The **Import Manager** appears.
- 3 Browse to the directory that contains the sample project zip file. Select the sample file (for this sample, **CICSjms\_JCE\_Sample.zip**) and click **Import**. After the sample project is successfully imported, click **Close**.
- 4 When the import has successfully completed, right-click the Repository and select **Refresh All from Repository** from the shortcut menu.
- 5 Before an imported sample project can be run you must do the following:
  - ♦ Create an **Environment** (see [Creating an Environment](#) on page 77)
  - ♦ Configure the eWays for your specific system (see [Configuring the eWays](#) on page 78)
  - ♦ Create a **Deployment Profile** (see [Creating and Activating the Deployment Profile](#) on page 81)

## 5.4 The CICS\_JCE\_Sample Project Overview

The CICS eWay project, **CICS\_JCE\_Sample**, demonstrates the following:

- Input data (ASCII text) is read from an external directory by the Inbound File eWay.
- The ASCII text data is converted to EBCDIC (byte array) using cp037 encoding, and published by the CICS eWay to the CICS external system.
- The CICS eWay subscribes to the CICS external system, receives EBCDIC input data, and converts it to String ASCII data using cp037 encoding. The data is then published to the JMS Topic.
- The outbound File eWay subscribes to the JMS Topic and publishes the data to an external directory.

**Figure 39** CICS\_JCE\_Sample Project

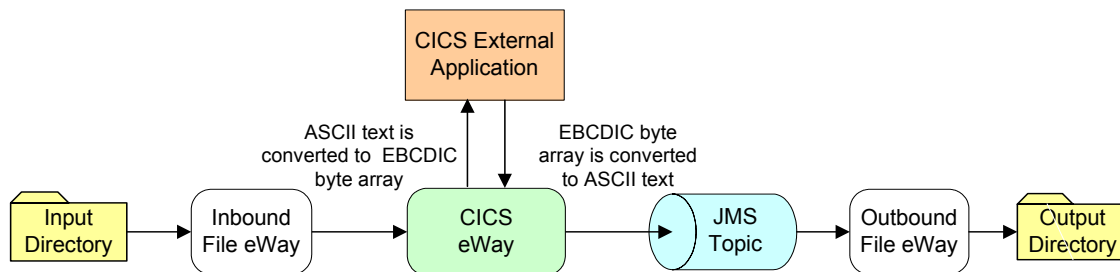

## 5.5 Creating the CICS\_JCE\_Sample Project

The following pages provide step by step directions for manually creating the sample eWay components.

### 5.5.1. Creating a Project

The first step is to create a new project in the SeeBeyond Enterprise Designer.

- 1 Start the Enterprise Designer.
- 2 From the Enterprise Explorer's Project Explorer tab, right-click your Repository on the Project Explorer tree and select **New Project** (see [Figure 40 on page 68](#)). A new project (Project1) appears on the Project Explorer tree.

**Figure 40** Enterprise Explorer - New Project

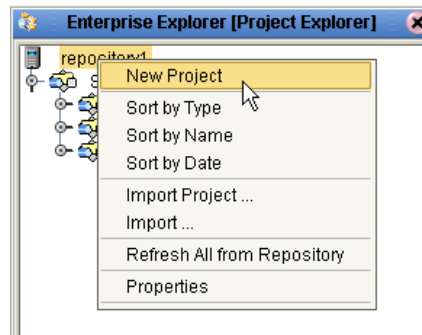

- 3 Click twice on **Project1** and rename the project (for this sample, **CICS\_JCE\_Sample**).

## 5.5.2 Creating a Connectivity Map

The Connectivity Map provides a canvas for assembling and configuring a project's components.

- 1 From the Project Explorer tree, right-click the new **CICS\_JCE\_Sample** project and select **New > Connectivity Map** from the shortcut menu.
- 2 The New Connectivity Map appears and a node for the Connectivity Map is added under the project on the Project Explorer tree labeled **CMap1**. Rename the Connectivity Map to **CICSjms\_JCE\_Sample\_CM**.

The icons in the toolbar represent the available components used to populate the Connectivity Map canvas.

## Selecting the External Applications

The icons in the toolbar represent the available components used to populate the Connectivity Map canvas.

In a Connectivity Map, the eWays are associated with External Systems. For example, to establish a connection to CICS, you must first select CICS as an External System to use in your Connectivity Map (see Figure 41).

**Figure 41** Connectivity Map - External Applications

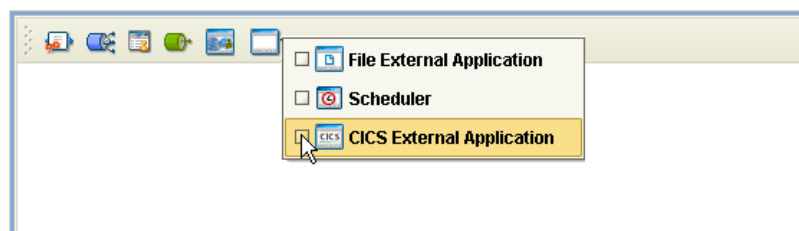

- 1 Click the **External Application** icon on the Connectivity Map toolbar,
- 2 Select the external systems needed for your project (for this sample, the **CICS** and **File** External Applications). Icons representing the selected external systems are added to the Connectivity Map toolbar.

## Populating the Connectivity Map

Add the project components to the Connectivity Map by dragging the icons from the toolbar to the canvas.

- 1 For this sample, drag the following components onto the Connectivity Map canvas as displayed in Figure 42:
  - ♦ **File External System** (2)
  - ♦ **Service** (2) A service is a container for Collaborations, Business Processes, eTL processes, and so forth.
  - ♦ **Topic**
  - ♦ **CICS External System**

**Figure 42** Connectivity Map with Components

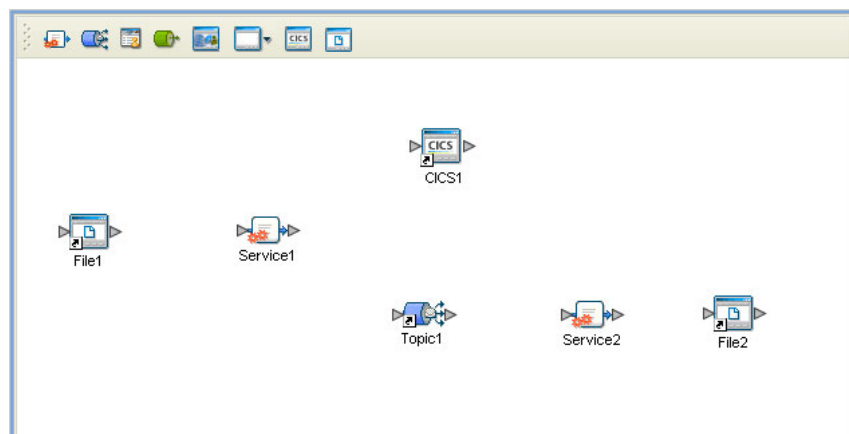

- 2 Rename the objects by right-clicking the object, selecting **Rename** from the shortcut menu, and typing in the new name. Change the names as follows:
  - ♦ **File1** to **FileIn**
  - ♦ **Service1** to **CICSjmsCollab**
  - ♦ **Service2** to **JMS2FileCollab**
  - ♦ **File2** to **FileOut**
- 3 From the Enterprise Designer toolbar, click the **Save All** icon to save your current changes to the Repository.

### 5.5.3. Creating the Collaboration Definitions

The next step in the sample is to create two Collaborations using the Collaboration Definition Wizard (Java). Once the Collaboration Definitions have been created, the Business Rules of the Collaborations are written using the Collaboration Editor.

### Creating the CICSjms\_Collab Collaboration

The CICSjms\_Collab Collaboration defines transactions from the inbound file application to the CICS eWay and the CICS application, and back to the JMS Topic.

- 1 From the Project Explorer, right-click the sample project and select **New > Collaboration Definition (Java)** from the shortcut menu. The **Collaboration Definition Wizard (Java)** appears.
- 2 Enter a Collaboration Definition name (for this sample CICSjms\_Collab) and click **Next**.
- 3 For Step 2 or the wizard, from the Web Services Interfaces selection window, double-click **SeeBeyond > eWays > File > FileClient > receive**. The File Name field now displays **receive**. Click **Next**.
- 4 For Step 3 of the wizard, from the Select OTDs selection window, double-click **SeeBeyond > eWays > CICSeWay > CICS\_eWay**. The **CICS\_eWay** OTD is added to the Selected OTDs field.
- 5 Click the **Up One Level** button to return to the Repository. Double-click **SeeBeyond > eGate > JMS**. The **Selected OTDs** field now lists the **JMS** OTD (see Figure 43).

**Figure 43** Collaboration Definition Wizard (Java) - Select Web Service Interface

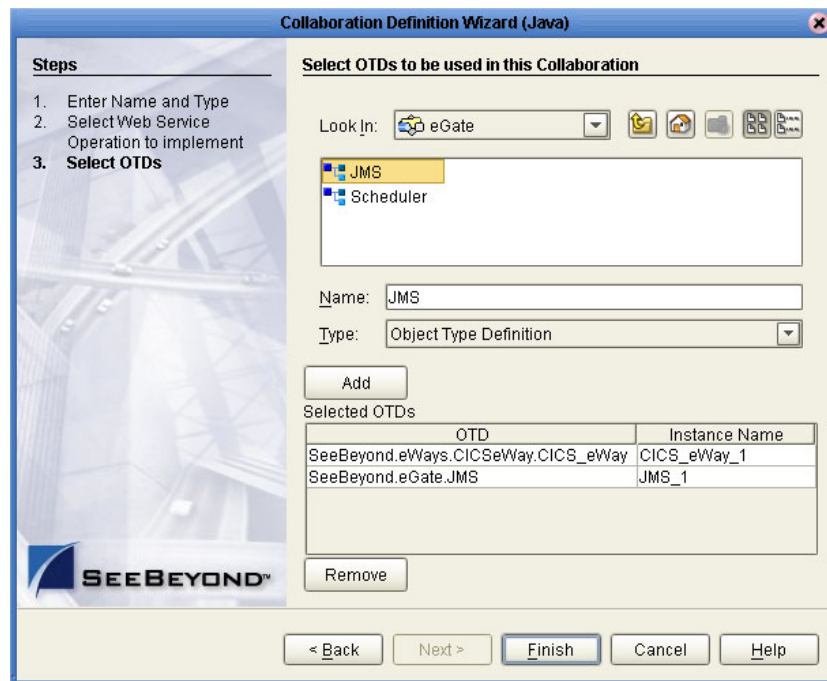

- 6 Click **Finish**. The Collaboration Editor with the new CICSjms\_Collab Collaboration appears in the right pane of the Enterprise Designer.

## Creating the JMS2File\_Collab Collaboration (Java)

The JMS2File\_Collab Collaboration defines transactions made from the JMS Topic to the Outbound File eWay.

- 1 From the Project Explorer, right-click the sample project and select **New > Collaboration Definition (Java)** from the shortcut menu. The **Collaboration Definition Wizard (Java)** appears.
- 2 Enter a Collaboration Definition name (for this sample **JMS2File\_Collab**) and click **Next**.
- 3 For Step 2 of the wizard, from the Web Services Interfaces selection window, double-click **SeeBeyond > eGate > JMS > receive**. The File Name field now displays **receive**. Click **Next**.
- 4 For Step 3, **Select OTDs**, from the Select OTDs selection window, double-click **SeeBeyond > eWays > File > FileClient**. The Selected OTDs field now lists the **FileClient** OTD.
- 5 Click **Finish**. The Collaboration Editor with the new JMS2File\_Collab Collaboration appears.

### 5.5.4. Using the Collaboration Editor (Java)

The next step in the sample is to create the Business Rules of the Collaboration using the Collaboration Editor.

## Creating the CICSjms\_Collab Business Rules

Be careful to open all nodes specified in the directions to connect to the correct item. The CICSjms\_Collab Collaboration contains the Business Rule displayed in Figure 44.

**Figure 44** CICSjms\_Collab Business Rules

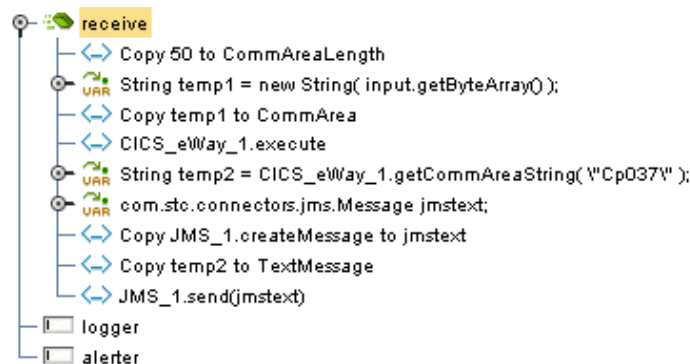

To create the CICSjms\_Collab Collaboration Business Rules do the following:

- 1 From the Project Explorer tree, double-click **CICSjms\_Collab** to open the Collaboration Editor (Java) to the CICSjms\_Collab Collaboration.
- 2 Double-click the **input, FileClient\_1**, and **CICCS\_eWay\_1** in the Transformation Designer panes to expand the nodes.

- 3 To create the **Copy 50 to CommAreaLength** Business Rule do the following:
  - A From the Transformation Designer toolbar, click the **Create Literal** icon. The **Create Literal** method box appears. Select **int** as the type, **50** as the value, and click **OK**. The Literal method box appears in the Transformation Designer.
  - B Map the **50** output node of the Literal method box to **CommAreaLength** under **CICS\_eWay\_1** in the right pane of the Collaboration Editor. To do this, click on the **50** output node in the Literal method box and drag the cursor to **CommAreaLength** under **CICS\_eWay\_1** in the right pane of the Transformation Designer (see Figure 45).

**Figure 45** CICSjms\_Collab - Copy 50 to CommAreaLength Business Rule

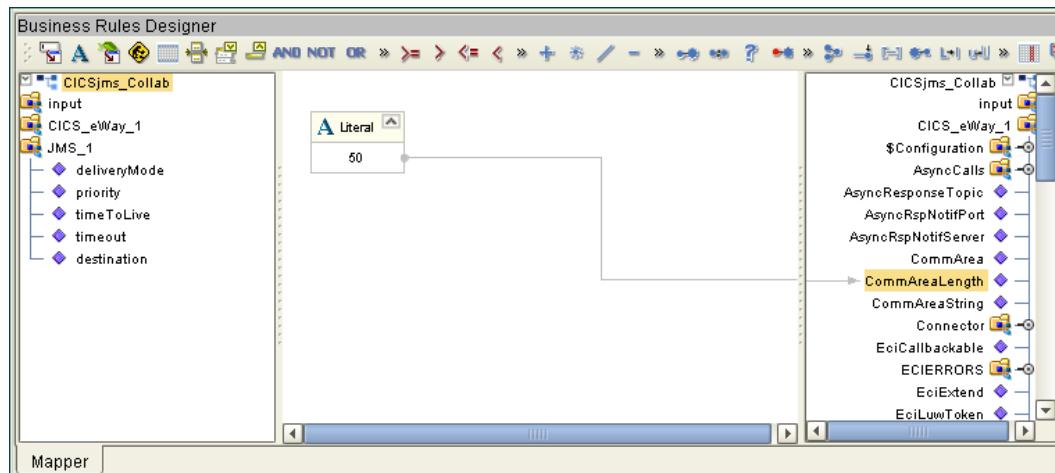

- 4 To create the (variable) **String temp1 = new String( input.getByteArray() )** Business Rule do the following:
  - A From the Business Rules toolbar, click the **rule** icon to add a new rule.
  - B From the Collaboration Editor toolbar, click the Advance mode icon. The Java Source Editor appears as the bottom pane of the Collaboration Editor.
  - C From the Java Source Editor, replace *//New rule* with the following code:
 

```
//String temp1 = new String( input.getByteArray() );
String temp1 = new String( input.getByteArray() );
```
  - D From the Collaboration Editor toolbar, click the **Commit Changes** icon. A new object named temp1 is added to the left pane of the Business Rules Designer.
- 5 To create the **Copy temp1 to CommArea** Business Rule do the following:
  - A From the Business Rules toolbar, click the **rule** icon to add a new rule.
  - B From the left pane of the Business Rules Designer, right click **temp1** and select **Select a method to call** from the shortcut menu.
  - C From the Method selection box, select **getBytes(java.lang.String charsetName)**. The **getBytes** method box appears on the Business Rules Designer canvas.
  - D From the Business Rules Designer toolbar, click on the **Create Literal** icon. The **Create Literal** dialog box appears.



- E From the Create Literal dialog box, select **String** as Type, enter **cp037** as the Value, and click **OK**. The **Literal** method box appears on the Business Rules Designer canvas.
- F Map the **cp037** output node of the Literal method box to the **charsetName (String)** input node of the **getBytes** method box. To do this, click on **cp037** in the Literal method box and drag the cursor to **charsetName (String)** in the **getBytes** method box, to create a link as displayed in Figure 46.
- G Map the **result (byte[])** output node of the **getBytes** method box to **CommArea** under **CICS\_eWay\_1** in the right pane of the Business Rules Designer. The Collaboration Editor now appears as displayed in Figure 46.

**Figure 46** Collaboration Editor - Business Rules Designer

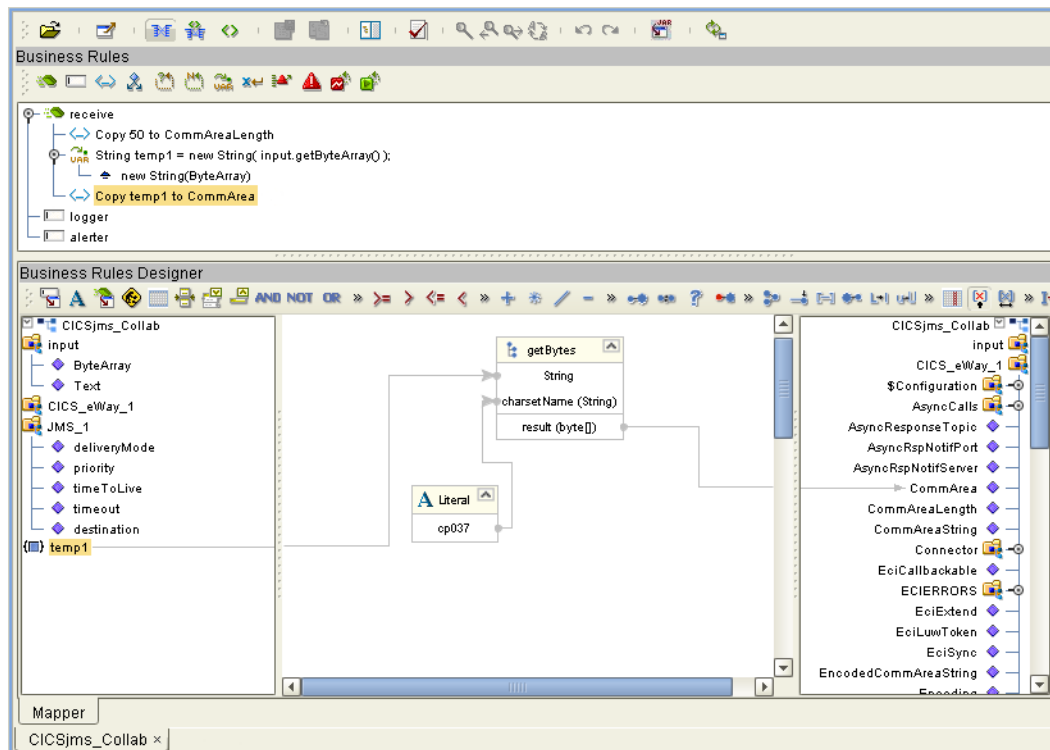

- 6 To create the **CICS\_eWay\_1.execute** Business Rule do the following:
  - A From the Business Rules toolbar, click the **rule** icon to add a new rule.
  - B From the left pane of the Business Rules Designer, right click **CICS\_eWay\_1** and select **Select a method to call** from the shortcut menu.
  - C From the Method selection box, select **execute()**. The **execute** method box appears on the Business Rules Designer canvas.
- 7 To create the (variable) **String temp1 = new String( input.getByteArray() )** Business Rule do the following:
  - A From the Business Rules toolbar, click the **rule** icon to add a new rule.
  - B From the Collaboration Editor toolbar, click the Advance mode icon. The Java Source Editor appears as the bottom pane of the Collaboration Editor.

- C From the Java Source Editor, replace *//New rule* with the following code:
 

```
//String temp2 = CICS_eWay_1.getCommAreaString( "\"cp037\"" );
String temp2 = CICS_eWay_1.getCommAreaString( "cp037" );
```
  - D From the Collaboration Editor toolbar, click the **Commit Changes** icon. A new object named temp2 is added to the left pane of the Business Rules Designer.
- 8 To create the **com.stc.connectors.jms.Message jmstext**; (variable) Business Rule do the following:
- A From the Business Rules toolbar, click on the **local variable** icon. The **Create a Variable** dialog box appears.
  - B From the Create a Variable dialog box, select **class**, and click the *ellipsis (...)* button. The **Find Class** dialog box appears. Select **Message** as the Class Name, **com.stc.connectors.jms** as the Package, and click **OK**.
  - C From the Create a Variable dialog box, enter **jmstext** as the Variable Name. Click **OK**.
  - D From the Collaboration Editor toolbar, click the **Commit Changes** icon. A new object named **jmstext** is added to the left pane of the Business Rules Designer.
- 9 To create the **Copy JMS\_1.createMessage to jmstext** Business Rule do the following:
- A From the Business Rules toolbar, click the **rule** icon to add a new rule.
  - B From the left pane of the Business Rules Designer, right click **JMS\_1** and select **Select a method to call** from the shortcut menu.
  - C From the Method selection box, select **createMessage()**. The **createMessage** method box appears on the Business Rules Designer canvas.
  - D Map the **result (Message)** output node of the **createMessage** method box to **jmstext** in the right pane of the Business Rules Designer (see Figure 47).

**Figure 47** Business Rules Designer

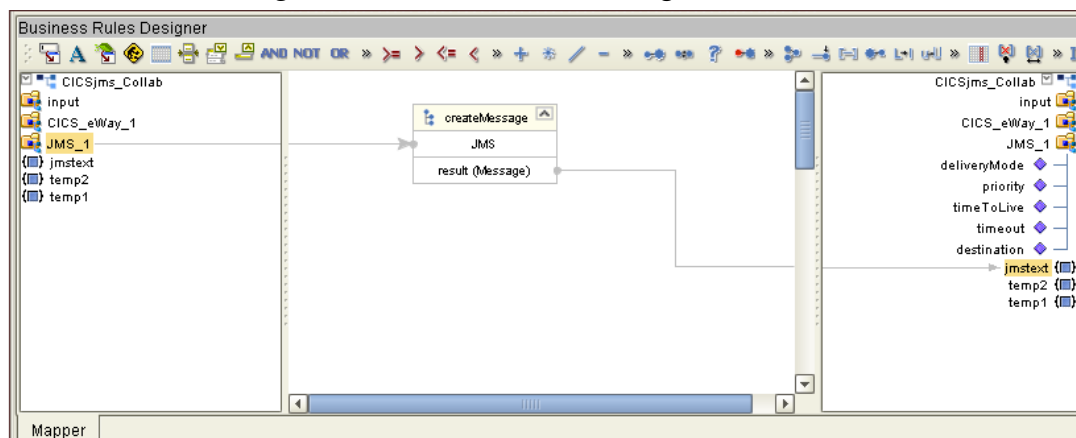

- 10 To create the **Copy temp2 to TextMessage** Business Rule do the following:
- A From the Business Rules toolbar, click the **rule** icon to add a new rule.

- B Map **temp2** in the left pane of the Business Rules Designer, to TextMessage under jmstext in the right pane of the Business Rules Designer (see Figure 48).

**Figure 48** Business Rules Designer

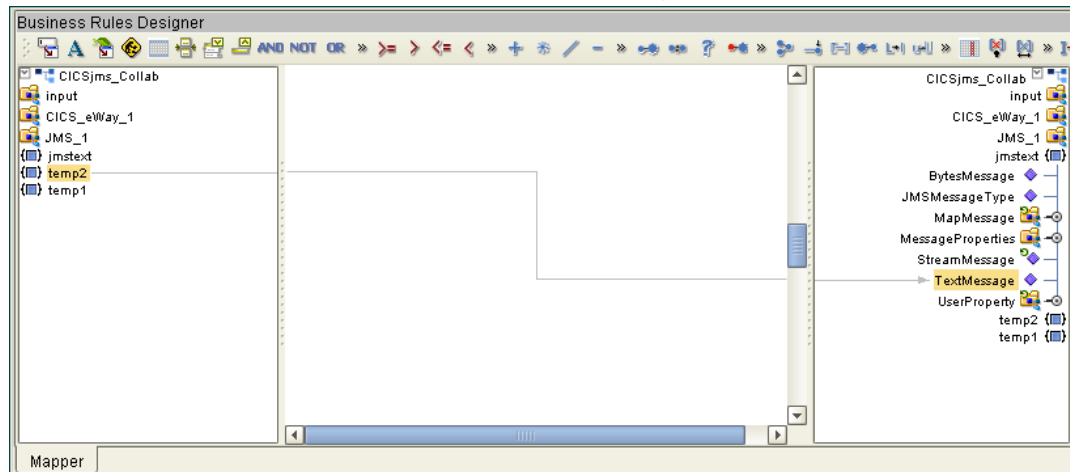

- 11 Right-click the Repository in the Project Explorer and select **Save changes to Repository** to save your changes.

## Creating the JMS2File\_Collab Collaboration Business Rules

Be careful to open all nodes specified in the directions to connect to the correct item. The CICSjms\_Collab Collaboration contains the Business Rule displayed in Figure 49

**Figure 49** JMS2File\_Collab Business Rules

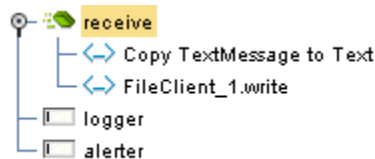

To create the **JMS2File\_Collab** Collaboration Business Rules do the following:

- 1 From the Project Explorer tree, double-click **JMS2File\_Collab** to open the Collaboration Editor to the **JMS2File\_Collab** Collaboration.
- 2 To create the **Copy TextMessage to Text** Business Rule do the following:
  - A Select the **New rule** in the Business Rules pane.
  - B Map **TextMessage** under **input** in the left pane of the Transformation Designer to **Text** under **FileClient\_1** in the right pane.
- 3 To create the **Copy TextMessage to Text** Business Rule do the following:
  - A From the Business Rules toolbar click the **rule** icon to add a new rule.

- B From the left pane of the Transformation Designer, right-click **FileClient\_1** and click **Select a method to call** from the shortcut menu. The method selection box appears.
- C Select the **write** method. The **write** method box appears in the Transformation Designer canvas.
- 4 Right-click the Repository in the Project Explorer and select **Save changes to Repository** to save your changes.

For more information on how to create Business Rules using the Collaboration Editor see the *eGate Integrator User's Guide*.

- 5 Right-click the Repository in the Project Explorer and select **Save changes to Repository** to save your changes.

### 5.5.5. Binding the eWay Components

After the Collaborations have been written, the components are associated and Bindings are created in the Connectivity Map.

- 1 From the Project Explorer, double-click the Connectivity Map **CICSjms\_JCE\_Sample\_CM**. The Enterprise Designer canvas now displays the **CICSjms\_JCE\_Sample\_CM** Connectivity Map.
- 2 Drag and drop the **CICSjms\_Collab** Collaboration from the Project Explorer to the first Service (**CICSjmsCollab**). If the Collaboration was successfully associated, the Service's "gears" icon changes from red to green (see Figure 50).

**Figure 50** Connectivity Map - Binding the Components

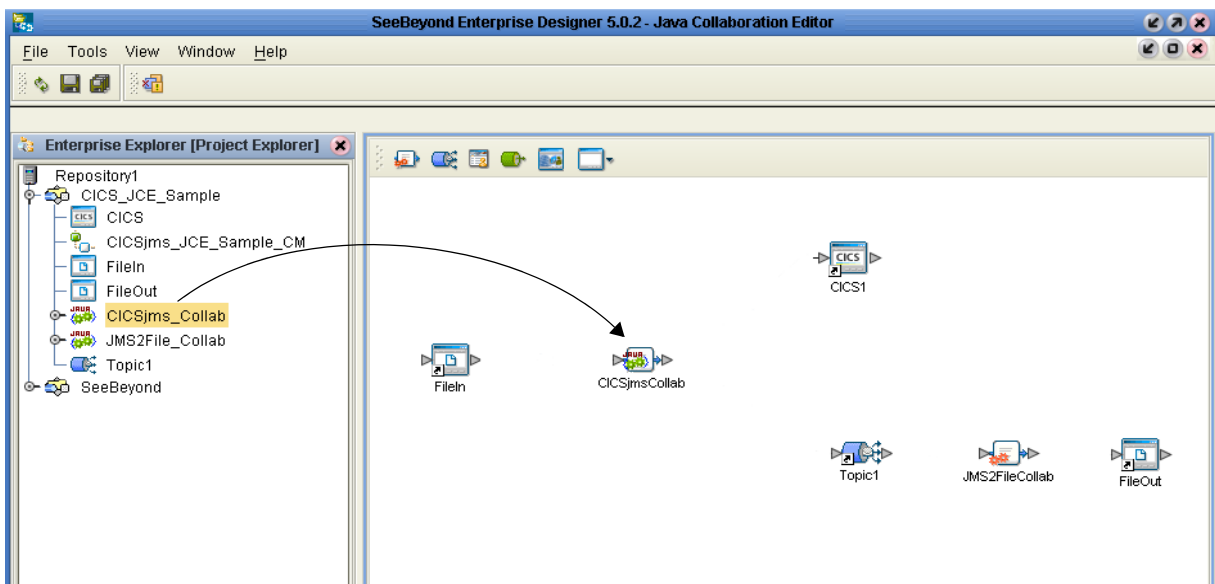

- 3 Drag and drop **JMS2File\_Collab** from the Project Explorer to the second Service (**JMS2FileCollab**).
- 4 From the Connectivity Map canvas, double-click **CICSjmsCollab**. The **CICSjmsCollab** Binding dialog box appears with the **CICSjms\_Collab** Rule.

- 5 From the **CICSjmsCollab** Binding dialog box, map **FileClient Input** (under Implemented Services) to the inbound **FileIn** External Application.
- 6 From the **CICSjmsCollab** Binding dialog box, map **CICS\_eWay** (under Invoked Services) to the **CICS1** External Application.
- 7 From the **CICSjmsCollab** Binding dialog box, drag **JMS\_1** (under Invoked Services) to **Topic1** (see [Figure 51 on page 77](#)).

**Figure 51** Connectivity Map - Associating (Binding) the Project's Components

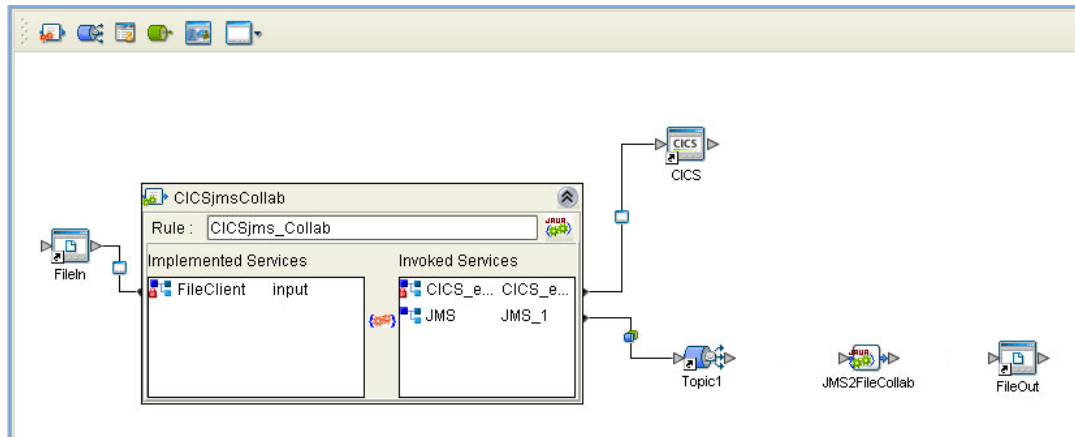

- 8 Minimize the **CICSjmsCollab** Binding dialog box by clicking the chevrons in the upper-right corner.
- 9 From the Connectivity Map, double-click **JMS2FileCollab**. The **JMS2FileCollab Binding dialog box** appears with the **JMS2File\_Collab** Rule.
- 10 From the **JMS2FileCollab** Binding dialog box, drag **JMS input** (under Implemented Services) to **Topic1**.
- 11 From the **JMS2FileCollab** Binding dialog box, drag **FileClient\_1** (under Invoked Services) to the outbound **FileOut** Application.
- 12 Minimize the Collaboration Binding dialog box, and save your current changes to the Repository

### 5.5.6. Creating an Environment

Environments include the external systems, Logical Hosts, integration servers and message servers used by a project and contain the configuration information for these components. Environments are created using the Enterprise Designer's Environment Explorer and Environment Editor.

- 1 From the Enterprise Designer's Enterprise Explorer, click the **Environment Explorer** tab.
- 2 Right-click the Repository and select **New Environment**. A new Environment is added to the Environment Explorer tree.
- 3 Rename the new Environment to **CICS\_JCE\_Sample\_Env**.

- 4 Right-click **CICS\_JCE\_Sample\_Env** and select **New CICS External System**. Name the External System **CicsExtSys**. Click **OK**. **CicsExtSys** is added to the Environment Editor.
- 5 Right-click **CICS\_JCE\_Sample\_Env** and select **New File External System**. Name the External System **FileExtSysIn** and select **Inbound File eWay** as the **External System Type**. Click **OK**. **FileExtSysIn** is added to the Environment Editor.
- 6 Right-click **CICS\_JCE\_Sample\_Env** and select **New File External System**. Name this External System **FileExtSysOut** and select **Outbound File eWay** as the **External System Type**. **FileExtSysOut** is added to the Environment Editor.
- 7 Right-click **CICS\_JCE\_Sample\_Env** and select **New Logical Host**. The **LogicalHost1** box is added to the Environment and **LogicalHost1** is added to the Environment Editor tree.
- 8 Right-click **LogicalHost1** and select **New SeeBeyond Integration Server**. A new Integration Server (**IntegrationSvr1**) is added to the Environment Explorer tree under **LogicalHost1**.
- 9 Right-click **LogicalHost1** and select **New SeeBeyond JMS IQManager**. A new JMS IQ Manager (**SBJmsIQMgr1**) is added to the Environment Explorer tree under **LogicalHost1**. The Environment Explorer and Environment Editor appear as displayed in Figure 52.

**Figure 52** Environment Editor - CICS\_JCE\_Sample\_Env

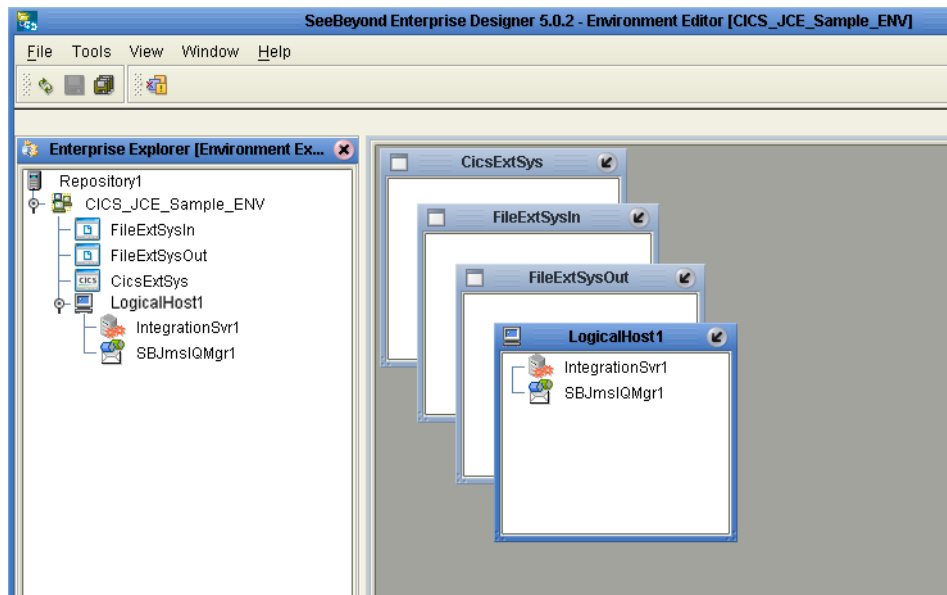

- 10 Save your current changes to the Repository.

### 5.5.7. Configuring the eWays

The CICS\_JCE\_Sample project uses three eWays, each represented in the Connectivity Map as a node between an External Application and a Service (see [Figure 53 on page 79](#)). eWays facilitate communication and movement of data between the external applications and the eGate system.

**Figure 53** Configuring the eWays and JMS Properties

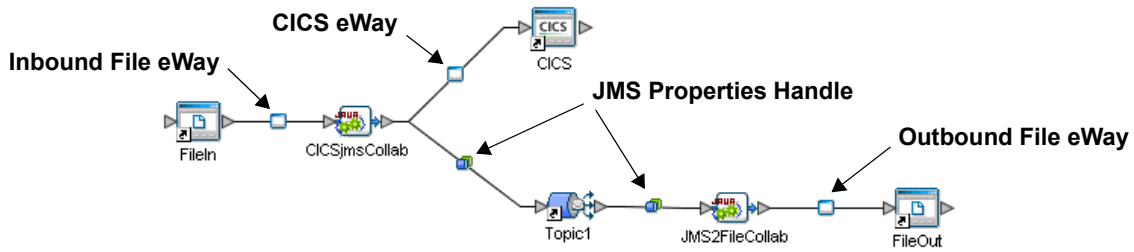

The File eWay configuration parameters are configured from the Connectivity Map. The CICS eWay configuration parameters are set from both the Project Explorer or Connectivity Map and the Environment Explorer. To configure the eWays do the following:

### Configuring the File eWays

- 1 Double-click the **Inbound File eWay**, select **Inbound File eWay** in the Templates dialog box and click **OK**.
- 2 The **Parameters** dialog box opens to the Inbound File eWay configuration. Modify the configuration for your system, including the settings for the **Inbound File eWay** in Table 6, and click **OK**. The configuration settings are saved for the eWay.

**Table 6** Inbound File eWay Settings

Inbound eWay Connection Parameters	
Directory	C:/temp
Input file name	Input*.txt

- 3 In the same way, modify the **Outbound File eWay** configuration for your system, including the settings in Table 7, and click **OK**.

**Table 7** Outbound File eWay Settings

Outbound eWay Connection Parameters	
Directory	C:/temp
Output file name	output%.dat

### Configuring the CICS eWay

The CICS eWay configuration parameters must be set in both the Project Explorer and Environment Explorer. For more information on the CICS eWay configuration parameters and the **Parameters** dialog box, see [Creating and Configuring the CICS eWay](#) on page 37 or see the *eGate Integrator User's Guide*.

For the CICS\_JCE\_Sample project, do the following:

### Modifying the CICS eWay (Project Explorer) Configuration Parameters

- 1 From the **Connectivity Map**, double-click the **CICS eWay**. The **Parameters** dialog box opens to the CICS eWay project configuration properties.
- 2 Modify the CICS eWay (Project Explorer) configuration for your system, including the settings in Table 8, and click **OK**.

**Table 8** CICS Project Explorer eWay Settings

CICS eWay Project-Configuration Parameters	
<b>Connector</b> Set as directed, otherwise use the default settings	
Class	com.stc.eways.cics.CicsClientConnector
Connection Transport	SeeBeyond CICS Listener
Type	CICS
<b>CICS Client</b> Set as directed, otherwise use the default settings.	
COMMAREA Length	1000
CICS Program	<i>CICS program to be run on server</i>

### Modifying the CICS eWay (Environment Explorer) Configuration Parameters

- 1 From the **Environment Explorer** tree, right-click the CICS External System (**CicsExtSys** in this sample), and select **Properties**. The **Parameters** dialog box opens to the CICS eWay environment-configuration properties.
- 2 Modify the CICS eWay environment-configuration for your system, including the settings in Table 9, and click **OK**.

**Table 9** CICS Environment Explorer eWay Settings

CICS eWay Environment-Configuration Parameters	
<b>SeeBeyond CICS Listener Settings</b> Set as directed, otherwise use the default settings	
Host	<i>Host Name</i>
Port	<i>TCP/IP Port Number</i>
<b>CICS Client Settings</b> Set as directed, otherwise use the default settings.	
CICS Password	<i>Password of CICS user</i>
CICS UserId	<i>This is the Id of the CICS user</i>

## 5.5.8. Configuring the JMS Clients

When a Service is linked with a Queue (or Topic), the Enterprise Designer adds a JMS properties handle between the two (see [Figure 53 on page 79](#)). These JMS properties facilitate the transfer and, if necessary, translation of data within the eGate system. JMS configuration properties must be configured in both the Connectivity Map and the Environment Explorer.



For more information on JMS configuration parameters see the *eGate Integrator User's Guide*.

### Modifying the JMS Connectivity Map Configuration Parameters

- 1 From the CICSjms\_JCE\_Sample\_CM Connectivity Map, double-click the JMS properties handle located between the **CICSjmsCollab** and **Topic1**.
- 2 The **Properties sheet** appears, containing the default environment-configuration properties. Click **OK** to keep the default settings.
- 3 Double-click the JMS properties handle located between **Topic1** and the **JMS2FileCollab** Collaboration.
- 4 The **Parameters** dialog box appears, containing the default configuration parameters. Click **OK** to keep the default settings.

### Modifying the JMS Environment Explorer Configuration Parameters

- 1 From the **Environment Explorer** tree, right-click the Message Server found under the Logical Host, and select **Properties**. The **Properties sheet** opens to the JMS Environment-configuration properties.
- 2 Modify the JMS Environment-configuration for your specific system and click **OK**.

## 5.5.9 Creating and Activating the Deployment Profile

A Deployment Profile is used to assign Collaborations and message destinations to the integration server and message server. Deployment Profiles are created using the Deployment Editor.

- 1 From the Enterprise Explorer's Project Explorer, right-click the project (**CICS\_JCE\_Sample**) and select **New > Deployment Profile**.
- 2 Enter a name for the Deployment Profile (for this sample **CICS\_JCE\_Sample\_DP**). Make sure that the selected Environment is **CICS\_JCE\_Sample\_Env**. Click **OK**.
- 3 From the left pane of the Deployment Editor, drag **CICSjmsCollab -> Topic1** (External Application) to the **CicsExtSys** window.
- 4 From the left pane of the Deployment Editor, drag the **FileIn -> CICSjmsCollab** (External Application) to the **FileExtSysIn** window.
- 5 From the left pane of the Deployment Editor, drag the **JMS2FileCollab -> FileOut** (External Application) to the **FileExtSysOut** window.
- 6 Drag the following 2 Collaborations:
  - ♦ **CICSjmsCollab**
  - ♦ **JMS2FileCollab**to **IntegrationSvr1** in the **LogicalHost1** window.
- 7 Drag the two Topic components:
  - ♦ **CICSjmsCollab -> Topic1**
  - ♦ **Topic1 -> JMS2FileCollab**

to **MessageSvr1** in the **LogicalHost1** window (see **Figure 54 on page 82**).

**Figure 54** Deployment Profile

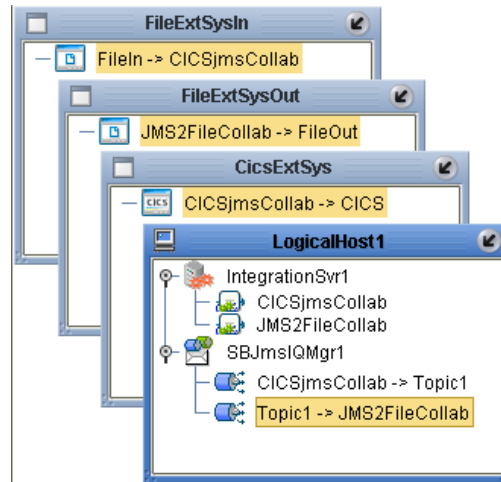

- 8 Click **Activate**. When activation succeeds, save the changes to the Repository.

### 5.5.10. Running the Project

The following directions assume that the Enterprise Designer was downloaded to **C:\ican50**. If this is not the case, replace that location in the following directions with the appropriate location.

- 1 From the Enterprise Manager Downloads tab, download **LogicalHost**.
- 2 Extract the file to the **ican50\LogicalHost2** directory. You must specify the **LogicalHost2** directory for it to be created.
- 3 Navigate to **C:\ican50\LogicalHost2\bootstrap\config** directory and open the **logical-host.properties** file using Notepad™.
- 4 Enter the following information in the appropriate fields:
  - ♦ Logical Host root directory: **ican50\LogicalHost2**
  - ♦ Repository URL: **http://localhost:port number/repository name**
  - ♦ Repository user name and password: **Your user name and password**
  - ♦ Logical Host Environment name: **CICS\_JCE\_Sample\_ENV**
  - ♦ Logical Host name: **LogicalHost2**

Save your changes to **logical-host.properties** and close the file.

- 5 Run the **bootstrap.bat** file in the **ican50\LogicalHost2\bootstrap\bin** directory.
- 6 Copy the sample input data file to the input directory.

## 5.6 The CICS\_COBOL\_Sample Project

The CICS eWay project, **CICS\_Cobol\_Sample**, demonstrates the following:

- The Inbound File eWay subscribes to an external directory, receives the data, and publishes the data to the CICS eWay.
- The CICS eWay, triggered by the data from the File eWay, does the following:
  - ♦ executes a CICS program on the external CICS system (mainframe)
  - ♦ reads the program's output (the contents of its COMM area)
  - ♦ copies the output into a Cobol Copybook OTD that is generated from the same data area description
  - ♦ OTD accessors selectively extract the value of select fields
- This data is published to the outbound File eWay, which publishes the data to an external directory.

**Figure 55** CICS\_Cobol\_Sample Project

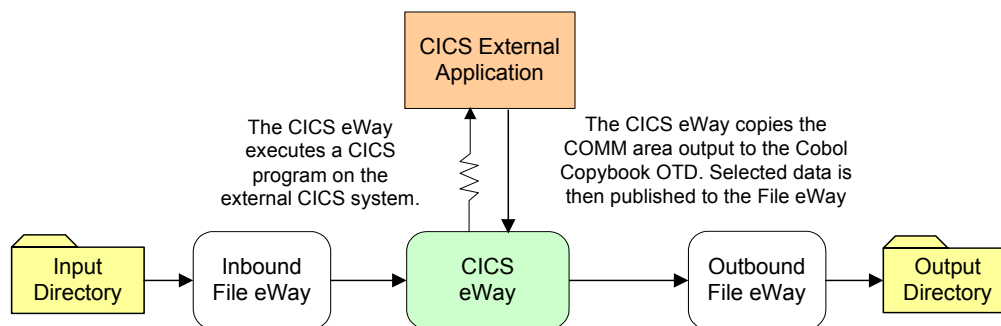

The **CICS\_Cobol\_Sample** is available to import from the Installation CD-ROM package (see [Importing a Sample Project](#) on page 66 for more information). The following pages review how the CICS\_Cobol\_Sample project is created.

### 5.6.1. Creating a Project

The first step is to create a new project in eGate Enterprise Designer.

- 1 Start the Enterprise Designer.
- 2 From the Enterprise Explorer's Project Explorer tab, right-click the Repository and select **New Project**. A new project (Project1) appears on the Project Explorer tree.
- 3 Click twice on **Project1** and rename the project (for this sample, **CICS\_COBOL\_Sample**).

## 5.6.2 Creating a Connectivity Map

The Connectivity Map provides a canvas for assembling and configuring a project's components.

- 1 In Enterprise Explorer's Project Explorer, right-click the new project (CICS\_COBOL\_Sample) and select **New > Connectivity Map** from the shortcut menu.
- 2 The New Connectivity Map appears and a node for the Connectivity Map is added under the project on the Project Explorer tree labeled **CMap1**. Rename the **CMap1** Connectivity Map to **CICS\_COBOL\_Sample\_CM**

### Selecting the External Applications

- 1 Click the **External Application** icon on the Connectivity Map toolbar,
- 2 Select the external systems needed for your project (for this sample, **CICS** and **File**). Icons representing the selected external systems are added to the Connectivity Map toolbar.

### Populating the Connectivity Map

Add the project components to the Connectivity Map by dragging the icons from the toolbar to the canvas.

- 1 For the **CICS\_COBOL\_Sample** project, drag the following components onto the Connectivity Map canvas as displayed in Figure 56:
  - ♦ **File** External System (2)
  - ♦ **Service**
  - ♦ **CICS** External System

**Figure 56** Connectivity Map with Components

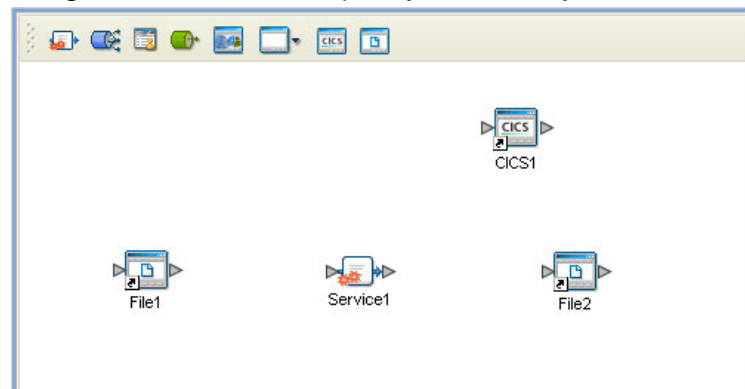

- 2 Rename the objects by right-clicking the object, selecting **Rename** from the shortcut menu, and typing in the new name. Change the names as follows:
  - ♦ **File1** to **FileIn**
  - ♦ **File2** to **FileOut**

- 3 Save your current changes to the Repository.

### 5.6.3 Creating an Object Type Definition

Object Type Definitions (OTDs) contain the data structures and rules that define objects. OTDs are used in the Enterprise Designer to create Collaboration Definitions for building data transformations. OTDs are created using the **Object Type Definition Wizard**.

#### Using the Cobol Copybook Wizard

The **CICS\_COBOL\_Sample** project uses an OTD that is created using the **Cobol Copybook Wizard**. A sample Cobol data file, **qan3glr1.cobol** is available from the downloaded CICS eWay Samples folder. To create the Cobol Copybook OTD using the sample Cobol file do the following:

- 1 Copy the sample Cobol file, **qan3glr1.cobol**, from the installation CD-ROM to a temporary file.
- 2 From the Project Explorer, right-click the **CICS\_COBOL\_Sample** project, and select **New > Object Type Definition** from the shortcut menu. The OTD Wizard Selection dialog box appears. Select the **Cobol Copybook Wizard** and click **Next**.
- 3 From the **Select Cobol Copybook Files** page of the Wizard, navigate to the directory that contains the sample Cobol file. The sample file is now visible in the Available Files field (see Figure 57).

**Figure 57** Cobol Copybook Wizard - Select Cobol Files

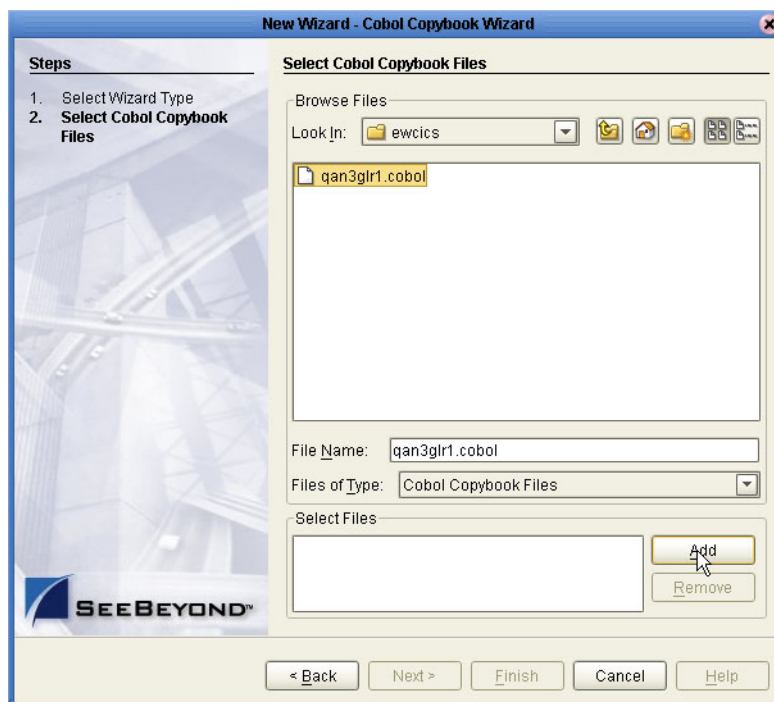

- 4 Select the sample Cobol file and click the **Add** button. The file is added to the **Selected Files** field. Click **Finish**.
- 5 A **Message** dialog box appears if the OTD is created successfully, and the OTD is added to the Project Explorer tree as **qan3glr1**.

#### 5.6.4. Creating a Collaboration Definition (Java)

The next step is to create the CICS\_COBOL\_Collab Collaboration using the Collaboration Definition Wizard (Java). Once the Collaboration Definition has been created, the Business Rules of the Collaboration can be written using the Collaboration Editor (Java).

##### Creating the CICS\_COBOL\_Colab Collaboration

- 1 From the Project Explorer, right-click the **CICS\_COBOL\_Sample** project and select **New > Collaboration Definition (Java)** from the shortcut menu. The **Collaboration Definition Wizard (Java)** appears.
- 2 Enter a Collaboration Definition name (for this sample **CICS\_COBOL\_Collab**) and click **Next**.
- 3 For Step 2 of the Wizard, from the Web Services Interfaces selection window, double-click **SeeBeyond > eWays > File > FileClient > receive**. The File Name field now displays **receive**. Click **Next**.
- 4 For Step 3 of the Wizard, from the Select OTDs selection window, double-click **SeeBeyond > eWays > CICS\_eWay > CICS\_eWay**. The **CICS\_eWay** OTD is added to the Selected OTDs field.
- 5 Click the **Up One Level** button to return to the Repository directory. Double-click **SeeBeyond > eWays > File > FileClient**. The **FileClient** OTD is added to the Selected OTDs field.
- 6 Click the **Up One Level** button to return to the Repository directory. Double-click **CICS\_COBOL\_Sample > qan3glr1**. The **qan3glr1** OTD is added to the Selected OTDs field.
- 7 Click **Finish**. The Collaboration Editor opens to the new Collaboration in the right pane of the Enterprise Designer.

#### 5.6.5. The CICS\_COBOL\_Collab Business Rules

The the **CICS\_COBOL\_Sample** project uses one Collaboration created in the previous section, **CICS\_COBOL\_Collab**.

##### CICS\_COBOL\_Collab Business Rules

The CICS\_COBOL\_Collab Collaboration contains the Business Rule displayed in **Figure 58 on page 87**. These rules are created using the Collaboration Editor (Java).

**Figure 58** CICS\_COBOL\_Collab Business Rules

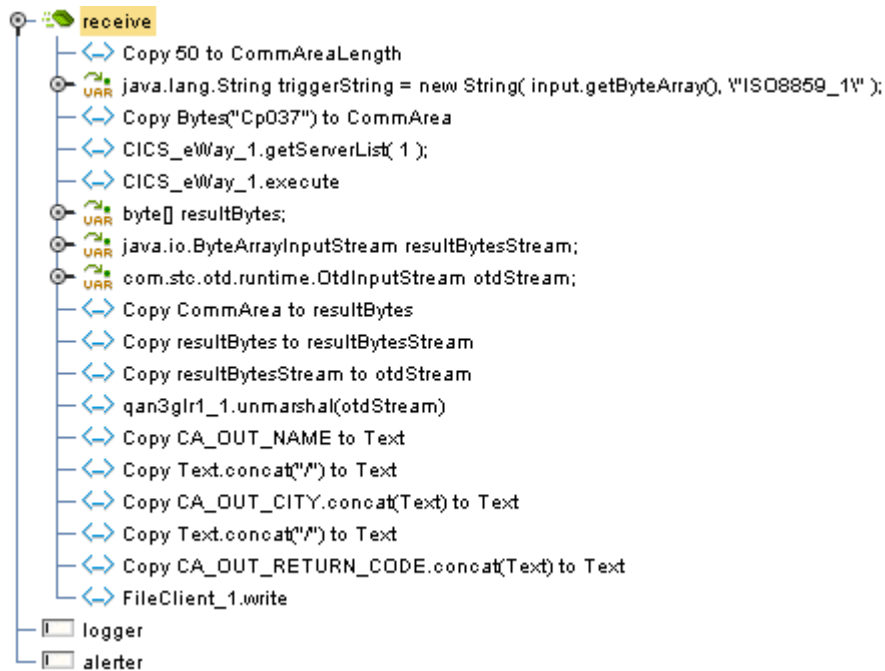

To create the CICS\_COBOL\_Collab Business Rules do the following:

- 1 From the Project Explorer tree, double-click **CICS\_COBOL\_Collab** to open the Collaboration Editor to the Collaboration.
- 2 Double-click the **input**, **FileClient\_1**, and **CICCS\_eWay\_1** in the Transformation Designer panes to expand the nodes.
- 3 To create the **Copy 50 to CommAreaLength** Business Rule do the following:
  - A From the Collaboration Editor toolbar click the **Advance mode** icon. The Java Source Editor now appears as the bottom pane of the Collaboration Editor.
  - B From the Collaboration Editor pane, select **//New rule**, and replace it with the following code:

```

//Copy 50 to CommAreaLength
CICS_eWay_1.setCommAreaLength( com.stc.util.STCTypeConverter.toIntegerPrimitive( 50 ) );

```
  - C From the Collaboration Editor toolbar click the **Commit changes** icon (see [Figure 59 on page 88](#)).

**Figure 59** Copy 50 to CommAreaLength Business Rule

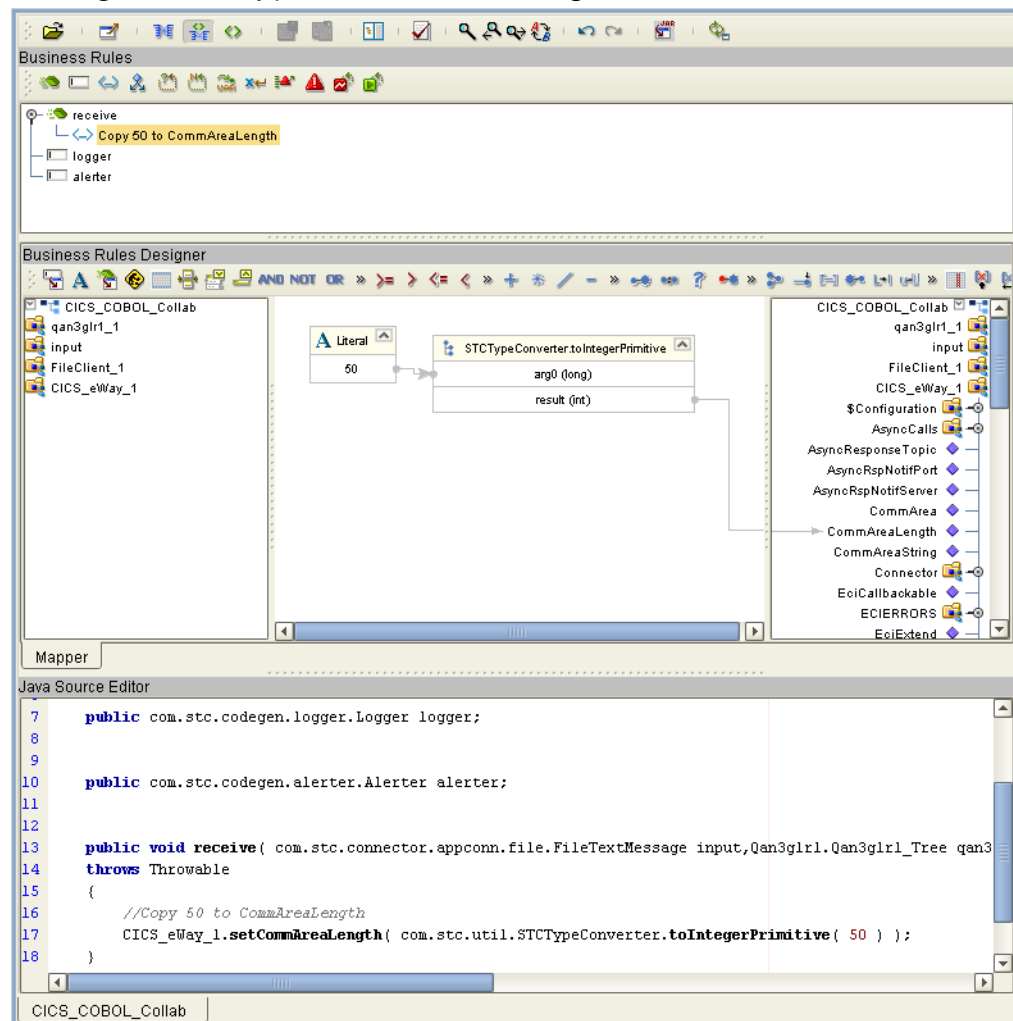

- 4 To create the `java.lang.String triggerString = new String( input.getBytes(), "\ISO8859_1\" )` variable Business Rule do the following:
  - A From the Business Rules toolbar, click the **local variable** icon. The **Create a Variable** dialog box appears. Select **Class** and browse to `java.lang.String` as the Class Name. Enter `triggerString` as the Variable Name, and click **OK**.
  - B From the Business Rules pane, expand the variable and select the variable's initializer.
  - C From the Business Rules Designer toolbar, click the **Call New Constructor** icon. The **Call New Constructor** dialog box appears.
  - D Select **String** for All Classes and `java.lang.String(byte[] bytes,java.lang.String charsetName)` as the Constructors. Click **OK**. The `java.lang.String` method box is appears on the Business Rules Designer canvas.
  - E From the Business Rules Designer toolbar, click the **Create Literal** icon. The **Create Literal** dialog box appears. Select `String` as the Type and `ISO8859_1` as the Value. Click **OK**.



- F Map **ByteArray** under **input** in the left pane of the Business Rules Designer, to the bytes (byte[]) input node of the **java.lang.String** method box.
  - G Map the **ISO8859\_1** output node of the **literal** method box, to the **charsetName (String)** input node of the **java.lang.String** method box.
- 5 To create the **Copy Bytes("cp037") to CommArea** Business Rule do the following:
  - A From the Business Rules toolbar, click the **rule** icon to add a new rule.
  - B From the left pane of the Business Rules Designer, right click **triggerString** and select **Select a method to call** from the shortcut menu.
  - C From the Method selection box, select **getBytes(java.lang.String charsetName)**. The **getBytes** method box appears on the Business Rules Designer canvas.
  - D From the Business Rules Designer toolbar, click on the **Create Literal** icon. The **Create Literal** dialog box appears.
  - E From the Create Literal dialog box, select **String** as Type, enter **cp037** as the Value, and click **OK**. The **Literal** method box appears on the Business Rules Designer canvas.
  - F Map the **cp037** output node of the Literal method box to the **charsetName (String)** input node of the **getBytes** method box. To do this, click on **cp037** in the Literal method box and drag the cursor to **charsetName (String)** in the **getBytes** method box, to create a link as displayed in Figure 46.
  - G Map the **result (byte[])** output node of the **getBytes** method box to **CommArea** under **CICS\_eWay\_1** in the right pane of the Business Rules Designer.
- 6 To create the **CICS\_eWay\_1.getServerList(1)** Business Rule do the following:
  - A From the Business Rules toolbar, click the **rule** icon to add a new rule.
  - B From the Collaboration Editor pane, select **//New rule**, and replace it with the following code:

```
//CICS_eWay_1.getServerList( 1 );  
CICS_eWay_1.getServerList( 1 );
```
  - C From the Collaboration Editor toolbar click the **Commit changes** icon.
- 7 To create the **CICS\_eWay\_1.execute** Business Rule do the following:
  - A From the Business Rules toolbar, click the **rule** icon to add a new rule.
  - B From the left pane of the Business Rules Designer, right click **CICS\_eWay\_1** and select **Select a method to call** from the shortcut menu.
  - C From the Method selection box, select **execute()**. The **execute** method box appears on the Business Rules Designer canvas.
- 8 To create the **byte[] resultBytes** variable Business Rule do the following:
  - A From the Business Rules toolbar, click the **local variable** icon. The **Create a Variable** dialog box appears. Select **Primitive** with byte as the value, and select **Is array**, for Type. Enter **resultByte** as the Variable Name, and click **OK**.
- 9 To create the **java.io.ByteArrayInputStream resultBytesStream** variable Business Rule do the following:

- A From the Business Rules toolbar, click the **local variable** icon. The **Create a Variable** dialog box appears. Select **Class** and browse to **java.io.ByteArrayInputStream** as the value. Enter **resultBytesStream** as the Variable Name, and click **OK**.
- 10 To create the **com.stc.otd.runtime.OtdInputStream otdStream** variable Business Rule do the following:
  - A From the Business Rules toolbar, click the **rule** icon to add a new rule.
  - B From the Collaboration Editor pane, select **//New rule**, and replace it with the following code:

```
//Copy com.stc.otd.runtime.OtdInputStream otdStream;  
com.stc.otd.runtime.OtdInputStream otdStream;
```
  - C From the Collaboration Editor toolbar click the **Commit changes** icon.
- 11 To create the **Copy CommArea to resultBytes** Business Rule do the following:
  - A From the Business Rules toolbar, click the **rule** icon to add a new rule.
  - B Map **CommArea** under **CICS\_eWay\_1** in the left pane of the Business Rules Designer, to **resultBytes** in the right pane of the Business Rules Designer (see Figure 60).

**Figure 60** Copy CommArea to resultBytes Business Rule

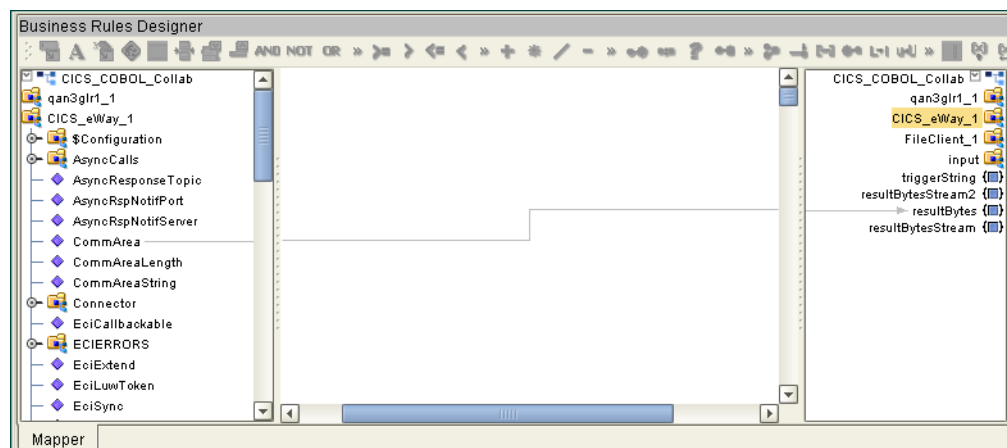

- 12 To create the **Copy resultBytes to resultBytesStream** Business Rule do the following:
  - A From the Business Rules toolbar, click the **rule** icon to add a new rule.
  - B From the Business Rules Designer toolbar, click the **Call New Constructor** icon. The **Call New Constructor** dialog box appears.
  - C Select **ByteArrayInputStream** for All Classes and **java.io.ByteArrayInputStream(byte[] buf)** as the Constructors. Click **OK**. The **java.io.ByteArrayInputStream** method box is appears on the Business Rules Designer canvas.
  - D Map **resultBytes** in the left pane of the Business Rules Designer, to the **buf (Byte[])** input node of the **java.io.ByteArrayInputStream** method box.

- E Map the **result (ByteArrayInputStream)** output node of the **java.io.ByteArrayInputStream** method box in the left pane of the Business Rules Designer, to the **buf (Byte[])** input node of the **java.io.ByteArrayInputStream** method box (see Figure 61).

**Figure 61** Copy resultBytes to resultBytesStream Business Rule

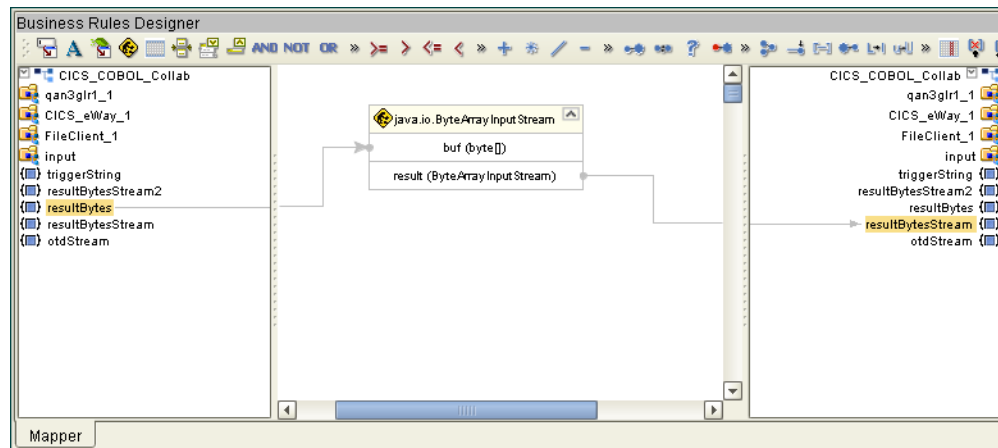

- 13 To create the **Copy resultBytesStream to otdStream** Business Rule do the following:
  - A From the Business Rules toolbar, click the **rule** icon to add a new rule.
  - B From the Collaboration Editor toolbar click the **Advance mode** icon. The Java Source Editor now appears as the bottom pane of the Collaboration Editor.
  - C From the Collaboration Editor pane, select **//New rule**, and replace it with the following code:
 

```
//Copy resultBytesStream to otdStream
otdStream = new com.stc.otd.runtime.provider.SimpleOtdInputStreamImpl(resultBytesStream );
```
  - D From the Collaboration Editor toolbar click the **Commit changes** icon.
- 14 To create the **qan3glr1\_1.unmarshal(otdStream)** Business Rule do the following:
  - A From the Business Rules toolbar, click the **rule** icon to add a new rule.
  - B From the left pane of the Business Rules Designer, right click **qan3glr1\_1** and select **Select a method to call** from the shortcut menu.
  - C From the Method selection box, select **unmarshal()**. The **unmarshal** method box appears on the Business Rules Designer canvas.
  - D Map **otdStream** from the left pane of the Business Rules Designer to the **in (OtdInputStream)** input node of the **unmarshal** method box.
- 15 To create the **Copy CA\_OUT\_NAME to Text** Business Rule do the following:
  - A From the Business Rules toolbar, click the **rule** icon to add a new rule.
  - B Map **CA-OUT-CITY** under **qan3glr1\_1 > DFHCOMMAREA** in the left pane of the Business Rules Designer to **Text** under **FileClient\_1** in the right pane of the Business Rules Designer.
- 16 To create the **Copy Text.concat("/") to Text** Business Rule do the following:

- A From the Business Rules toolbar, click the **rule** icon to add a new rule.
- B From the Business Rules Designer toolbar, click the **Create Literal** icon. The **Create Literal** dialog box appears.
- C From the **Create Literal** dialog box, select **String** as Type, enter / as the Value, and click **OK**. The **Literal** method box appears on the Business Rules Designer canvas.
- D From the Business Rules Designer toolbar, drag the **concat** icon to the Business Rules Designer canvas. The **concat** method box appears.
- E Map the **Text** under **FileClient\_1** in the left pane of the Business Rules Designer, to the String input node of the **concat** method box.
- F Map the / output node of the **Literal** method box to the **str (String)** input node of the **concat** method box.
- G Map the **result (String)** output node of the **concat** method box to **Text** under **FileClient\_1** in the right pane of the Business Rules Designer (see Figure 62).

**Figure 62** Copy Text.concat("/") to Text Business Rule

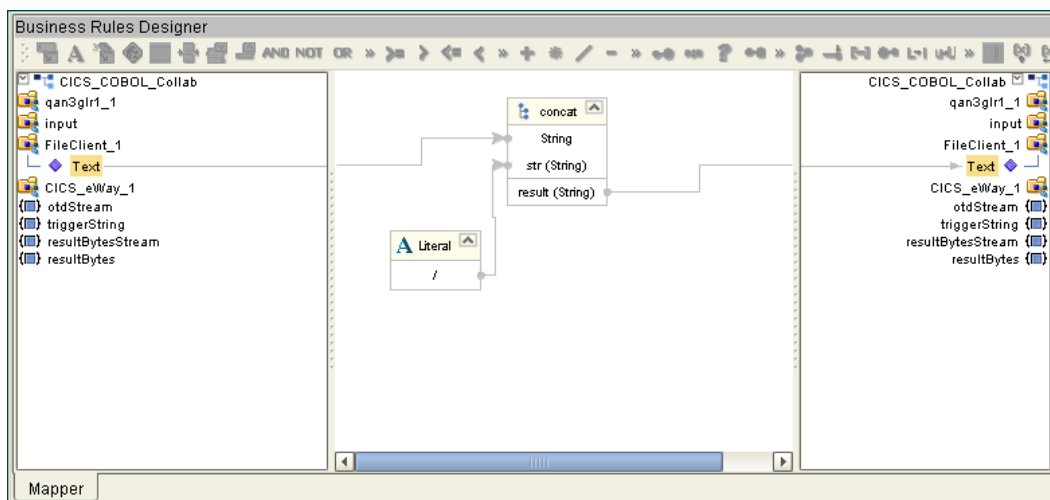

- 17 To create the **Copy CA\_OUT\_CITY.concat(Text) to Text** Business Rule do the following:
  - A From the Business Rules toolbar, click the **rule** icon to add a new rule.
  - B From the Business Rules Designer toolbar, drag the **concat** icon to the Business Rules Designer canvas. The **concat** method box appears.
  - C Map the **Text** under **FileClient\_1** in the left pane of the Business Rules Designer, to the String input node of the **concat** method box.
  - D Map **CA-OUT-CITY** under **qan3glr1\_1 > DFHCOMMAREA** in the left pane of the Business Rules Designer to the **str (String)** input node of the **concat** method box.
  - E Map the **result (String)** output node of the **concat** method box to **Text** under **FileClient\_1** in the right pane of the Business Rules Designer (see [Figure 63 on page 93](#)).

**Figure 63** Copy CA\_OUT\_CITY.concat(Text) to Text Business Rule

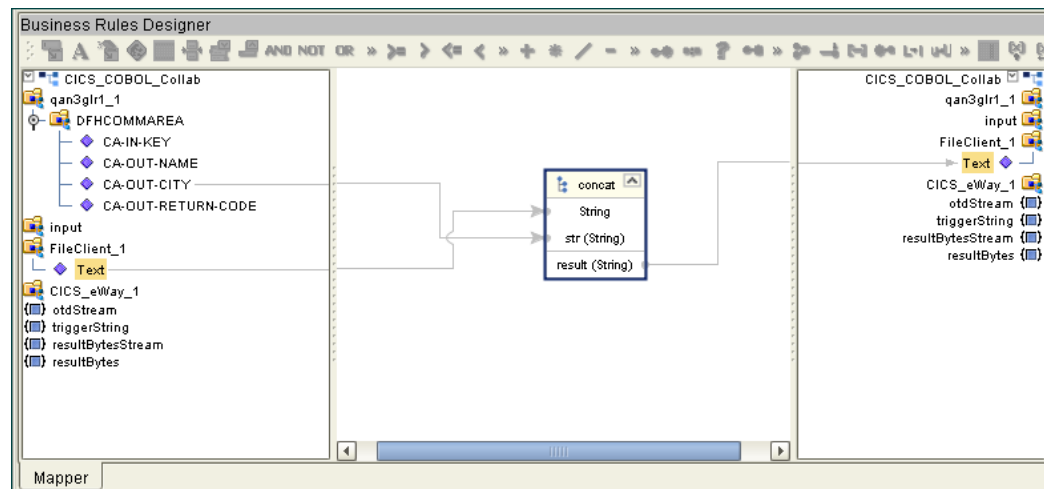

- 18 To create the **Copy Text.concat("/") to Text** Business Rule do the following:
  - A From the Business Rules toolbar, click the **rule** icon to add a new rule.
  - B From the Business Rules Designer toolbar, click the **Create Literal** icon. The **Create Literal** dialog box appears.
  - C From the **Create Literal** dialog box, select **String** as Type, enter / as the Value, and click **OK**. The **Literal** method box appears on the Business Rules Designer canvas.
  - D From the Business Rules Designer toolbar, drag the **concat** icon to the Business Rules Designer canvas. The **concat** method box appears.
  - E Map the **Text** under **FileClient\_1** in the left pane of the Business Rules Designer, to the String input node of the **concat** method box.
  - F Map the / output node of the **Literal** method box to the **str (String)** input node of the **concat** method box.
  
- 19 To create the **Copy CA\_OUT\_RETURN\_CODE.concat(Text) to Text** Business Rule do the following:
  - A From the Business Rules toolbar, click the **rule** icon to add a new rule.
  - B From the Business Rules Designer toolbar, drag the **concat** icon to the Business Rules Designer canvas. The **concat** method box appears.
  - C Map the **Text** under **FileClient\_1** in the left pane of the Business Rules Designer, to the String input node of the **concat** method box.
  - D Map **CA-OUT-RETURN-CODE** under **qan3glr1\_1 > DFHCOMMAREA** in the left pane of the Business Rules Designer to the **str (String)** input node of the **concat** method box.
  - E Map the **result (String)** output node of the **concat** method box to **Text** under **FileClient\_1** in the right pane of the Business Rules Designer.
  - F Map the **result (String)** output node of the **concat** method box to **Text** under **FileClient\_1** in the right pane of the Business Rules Designer.

- 20 To create the **FileClient\_1.write** Business Rule do the following:
  - A From the Business Rules toolbar, click the **rule** icon to add a new rule.
  - B From the left pane of the Business Rules Designer, right click **FileClient\_1** and select **Select a method to call** from the shortcut menu.
  - C From the Method selection box, select **write()**. The **write** method box appears on the Business Rules Designer canvas.
- 21 Save your current changes to the Repository.

For more information on how to create Business Rules using the Collaboration Editor (Java) see [Using the Collaboration Editor \(Java\)](#) on page 71, or see the *eGate Integrator User's Guide*.

### 5.6.6. Creating Collaboration Bindings

After the Collaborations have been written, the components are associated and the Collaboration Bindings are created in the Connectivity Map.

- 1 From the Project Explorer, double-click the Connectivity Map **CM\_CICS\_COBOL\_Sample**. The Enterprise Designer canvas now displays the **CM\_CICS\_COBOL\_Sample** Connectivity Map.
- 2 Drag and drop the **CICS\_COBOL\_Collab** Collaboration from the Project Explorer onto **CicsCobolCollab** in the **CICS\_COBOL\_Sample\_CM** Connectivity Map. If the Collaboration was successfully associated, the Collaboration's "gears" icon changes from red to green.
- 3 Double-click **CicsCobolCollab**. The **CicsCobolCollab** Binding dialog box appears.
- 4 From the **CicsCobolCollab** Binding dialog box, drag **FileClient input** (under Source) to the **Inbound** File external application.
- 5 From the **CicsCobolCollab** Binding dialog box, drag the **FileClient FileClient\_1** OTD (under Destination) to the **outbound** File external application.
- 6 From the **CicsCobolCollab** Binding dialog box, drag the **CICS\_eWay CICS\_eWay\_1** OTD (under Destination) to the **CICS** external application.
- 7 Minimize the **CicsCobolCollab** Binding dialog box. The Connectivity Map now appears similar to the Connectivity Map displayed in [Figure 64 on page 95](#).

**Figure 64** Connectivity Map - Connecting the Project's Components

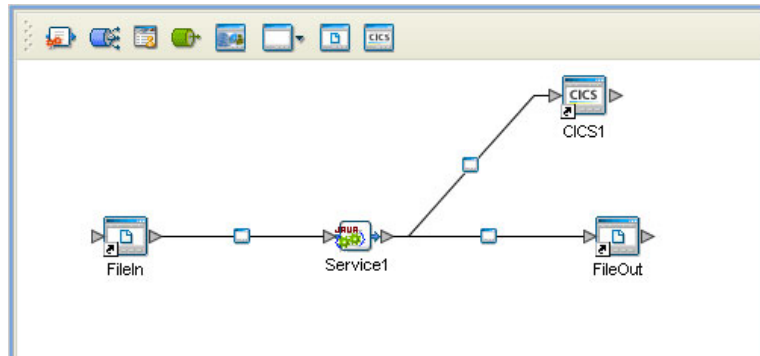

- 8 Right-click the Repository in the Project Explorer and select **Save changes to Repository** to save your changes.

### 5.6.7. Creating an Environment

Environments include the external systems, Logical Hosts, integration servers and message servers used by a project and contain the configuration information for these components.

- 1 From the Enterprise Designer's Enterprise Explorer, click the **Environment Explorer** tab.
- 2 Right-click the Repository and select **New Environment**. A new environment is added to the Environment Explorer tree.
- 3 Rename the new environment to **CICS\_COBOL\_Sample\_ENV**.
- 4 Right-click **CICS\_COBOL\_Sample\_ENV** and select **New CICS External System**. Name the External System **CicsExtSys**. Click **OK**. **CicsExtSys** is added to the Environment Editor.
- 5 Right-click **CICS\_COBOL\_Sample\_ENV** and select **New File External System**. Name the External System **FileExtSysIn** and select **Inbound File eWay** as the **External System Type**. Click **OK**. **FileExtSysIn** is added to the Environment Editor.
- 6 Right-click **CICS\_COBOL\_Sample\_ENV** and select **New File External System**. Name this External System **FileExtSysOut** and select **Outbound File eWay** as the **External System Type**. **FileExtSysOut** is added to the Environment Editor.
- 7 Right-click **CICS\_COBOL\_Sample\_ENV** and select **New Logical Host**. The **LogicalHost1** box is added to the Environment and **LogicalHost1** is added to the Environment Editor tree.
- 8 Right-click **LogicalHost1** and select **New SeeBeyond Integration Server**. A new Integration Server (**IntegrationSvr1**) is added to the Environment Explorer tree under **LogicalHost1**.
- 9 Save your current changes to the repository.

### 5.6.8. Configuring the eWays

The CICS\_COBOL\_Sample project uses three eWays, each represented in the Connectivity Map as a node between an External Application and a Collaboration.

The File eWay properties are configured from the Connectivity Map. The CICS eWay properties are set from both the Project Explorer's Connectivity Map and the Environment Explorer. To configure the eWays do the following:

#### Configuring the File eWays

- 1 Double-click the **Inbound File eWay** and select **Inbound File eWay** in the Templates dialog box and click **OK**.
- 2 The **Properties Sheet** opens to the Inbound File eWay properties. Modify the properties for your system, including the settings for the **Inbound File eWay** in Table 6, and click **OK**.

**Table 10** Inbound File eWay properties

Inbound eWay Connection Parameters	
Directory	C:/temp
Input file name	Input*.txt

- 3 In the same way, modify the **Outbound File eWay** properties for your system, including the settings in Table 7, and click **OK**.

**Table 11** Outbound File eWay properties

Outbound eWay Connection Parameters	
Directory	C:/temp
Output file name	output%.dat

#### Configuring the CICS eWay

The CICS eWay properties must be set in both the Project Explorer and Environment Explorer. For more information on the CICS eWay properties and the **Properties Sheet**, see [Creating and Configuring the CICS eWay](#) on page 37 or see the *eGate Integrator User's Guide*.

For the CICS\_JCE\_Sample project, do the following:

##### Modify the CICS eWay Connectivity Map Properties

- 1 From the **Connectivity Map**, double-click the **CICS eWay**. The **Properties Sheet** opens to the CICS eWay Connectivity Map configuration properties.
- 2 Modify the CICS eWay Connectivity Map properties for your system, including the settings in [Table 12 on page 97](#), and click **OK**.



**Table 12** CICS eWay Connectivity Map Properties

CICS eWay Connectivity Map Properties	
<b>Connector</b> Set as directed, otherwise use the default settings	
Class	com.stc.eways.cics.CicsClientConnector
Connection Transport	SeeBeyond CICS Listener
Type	CICS
<b>CICS Client</b> Set as directed, otherwise use the default settings.	
COMMAREA Length	1000
CICS Program	<i>CICS program to be run on server</i>

### Modify the CICS eWay Environment Explorer Properties

- 1 From the **Environment Explorer** tree, right-click the CICS External System (**CicsExtSys** in this sample), and select **Properties**. The **Properties Sheet** opens to the CICS eWay Environment configuration .
- 2 Modify the CICS eWay Environment configuration properties for your system, including the settings in **Table 13 on page 97**, and click **OK**.

**Table 13** CICS eWay Environment Explorer Properties

CICS eWay Environment Explorer Properties	
<b>SeeBeyond CICS Listener</b> Set as directed, otherwise use the default settings	
Host	<i>Host Name</i>
Port	<i>TCP/IP Port Number</i>
<b>CICS Client</b> Set as directed, otherwise use the default settings.	
CICS Password	<i>Password of CICS user</i>
CICS UserId	<i>This is the ID of the CICS user</i>

## 5.6.9 Creating and Activating the Deployment Profile

A Deployment Profile is used to assign Collaborations and message destinations to the integration server and message server. Deployment profiles are created using the Deployment Editor.

- 1 From the Enterprise Explorer’s Project Explorer, right-click the project (**CICS\_COBOL\_Sample**) and select **New > Deployment Profile**.
- 2 Enter a name for the Deployment Profile (for this sample **CICS\_COBOL\_Sample\_DP**). Select **CICS\_COBOL\_Sample\_ENV** as the Environment and click **OK**.
- 3 From the left pane of the Deployment Editor, drag the **Inbound -> Service1** (External Application) to the **FileExtSysIn** window.

- 4 From the left pane of the Deployment Editor, drag the **Service1 -> Outbound** (External Application) to the **FileExtSysOut** window.
- 5 Drag the **Service1 -> CICS1** (External Application) to the **CicsExtSys** window.
- 6 Drag **Service1** and **OTDProcessor1** to **IntegrationSvr1** in the **Logicalhost1** window (see Figure 65).

**Figure 65** Deployment Profile

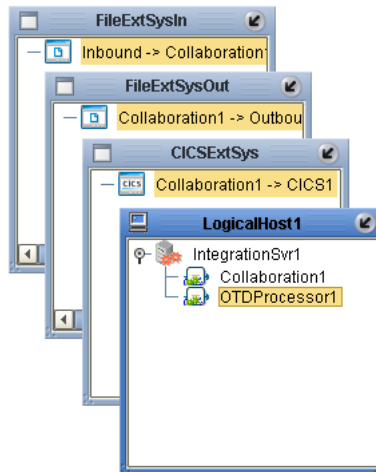

- 7 Click **Activate**. When activation succeeds, save the changes to the Repository.

### 5.6.10. Running the Project

The following directions assume that the Enterprise Designer was downloaded to C:\eGate50. If this is not the case, replace that location in the following directions with the appropriate location.

- 1 From the Enterprise Manager Downloads tab, click on **Local Host**.
- 2 Extract the file to the **eGate50\LogicalHost3** directory. You must specify the **LogicalHost3** directory for it to be created.
- 3 Navigate to C:\eGate50\LogicalHost2\bootstrap\config directory and open the **logical-host.properties** file using Notepad™.
- 4 Enter the following information in the appropriate fields:
  - ♦ Logical Host rood directory: **eGate50\LogicalHost3**
  - ♦ Repository URL: **http://localhost:port number/repository name**
  - ♦ Repository user name and password: *Your user name and password*
  - ♦ Logical Host Environment name: **CICS\_COBOL\_Sample\_ENV**
  - ♦ Logical Host name: **LogicalHost3**

Save your changes to **logical-host.properties** and close the file.

- 5 Run the **bootstrap.bat** file in the **eGate50\LogicalHost3\bootstrap\bin** directory.
- 6 Copy the sample input data file to the input directory.

# Java Methods

A number of Java methods have been exposed to make it easier to set information in the eWay's OTD Editor and to get information from it. These methods are contained in the CicsClient Class.

## Chapter Topics

- [The CicsClient Class](#) on page 99
- [Packed Decimal Java Helper Methods](#) on page 99

---

## 6.1 The CicsClient Class

The CicsClient class represents an OTD through which a Collaboration can invoke transaction programs on a CICS server. Nodes and methods are exposed so that the Collaboration can conveniently prepare a request for a CICS program, invoke the program, and get result from the program.

### CICS Javadoc

The Javadoc is uploaded with the eWay's documentation file (**CICSeWayDocs.sar**) and downloaded from the Documentation tab of the Enterprise Manager. To access the full Javadoc, extract the Javadoc to an easily accessible folder, and double click the **index.html** file.

---

## 6.2 Packed Decimal Java Helper Methods

The Java helper methods for the toPackedDecimal class. These methods are not exposed in the Collaboration but are available for use. For example, to use the **CopyTo** method to obtain a Hex value in a byte array you would use the following code:

```
MyPacked.toPackedDecimal("327.00") ;
System.out.println( " Decimal value is : " + MyPacked.toString() ) ;
byte[] work_buf = new byte[7];
MyPacked.CopyTo(work_buf, 7);
for ( int Ii = 0 ; Ii < 7 ; Ii++ )
{
    int Ib = (int) new Byte(work_buf[Ii]).intValue();
    if (Ib < 16)
    {
        System.out.println(" Byte" + Ii + " Hexvalue = 0" + Integer.toHexString(Ib));
    }
    else
    {
```

```
    {  
      System.out.println(" Byte" + Ii + " Hexvalue = " + Integer.toHexString(Ib));  
    }  
  }
```

This produces the following output:

```
Decimal value is : 327.00  
Byte0 Hexvalue = 00  
Byte1 Hexvalue = 00  
Byte2 Hexvalue = 00  
Byte3 Hexvalue = 00  
Byte4 Hexvalue = 32  
Byte5 Hexvalue = 70  
Byte6 Hexvalue = 0c
```

These methods are described in detail on the following pages:

[ContainerExists](#) on page 100

[GiveElem](#) on page 101

[CopyBack](#) on page 100

[SetElem](#) on page 102

[CopyTo](#) on page 101

---

## ContainerExists

### Description

Checks to see if contents of a packed decimal are available.

### Syntax

```
public com.stc.eways.cics.PackedDecimal boolean ContainerExists()
```

### Parameters

None.

### Return Values

**Boolean**

### Throws

None.

---

## CopyBack

### Description

Builds a packed decimal from the payload in a byte array. The byte array must contain a valid packed decimal number.

### Syntax

```
public com.stc.eways.cics.PackedDecimal void CopyBack(byte Origin[],  
int Size)
```

### Parameters

Name	Type	Description
Origin[]	byte	Payload containing a valid packed decimal number.
Size	int	Size of the payload that contains the packed decimal number.

### Return Values

None.

### Throws

None.

## CopyTo

### Description

Copies a packed decimal number to a byte array.

### Syntax

```
public com.stc.eways.cics.PackedDecimal void CopyTo(byte Dest[],
                                                    int Size)
```

### Parameters

Name	Type	Description
Dest[]	byte	A byte array that the packed decimal number will be copied to.
Size	int	Size of the payload that contains the packed decimal number.

### Return Values

None.

### Throws

None.

## GiveElem

### Description

Returns a specified byte of a packed decimal number.

### Syntax

```
public com.stc.eways.cics.PackedDecimal int GiveElem(int Ii)
```

### Parameters

Name	Type	Description
li	int	Position of the byte to be returned.

### Return Values

**int**  
Returns the value of the position.

### Throws

None.

---

## SetElem

### Description

Sets the value of a specified byte in a packed decimal number.

### Syntax

```
public com.stc.eways.cics.PackedDecimal void SetElem(int li,  
                                                    byte Value)
```

### Parameters

Name	Type	Description
li	int	Position of the byte to be set.
Value	byte	Value to set.

### Return Values

None.

### Throws

None.

# Index

## A

alerting and logging **48**  
 alerts/status notifications **48**

## B

binding **76**  
   dialog box **59**  
   eWay components **58**  
 bindings **94**

## C

CEDA **15, 17**  
 CICS  
   overview **7**  
 CICS eWay  
   location **38**  
   modify properties **39**  
   overview **7, 8**  
   properties **37**  
     Connectivity Map **37**  
     Environment Explorer tree **37**  
 CICSClient OTD **65**  
 Cobol Copybook Converter  
   function described **8**  
   sample project **83**  
 Cobol Copybook Wizard **85**  
 Collaboration  
   editor **69**  
 Collaboration definitions  
   Java **69**  
 Collaboration editor  
   Business Rules **71**  
   using **71**  
 COMMAREA **8**  
 Connectivity Map **68**

## D

Deployment Profile **81**  
   creating **62**  
 DFHRPL Concatenation **17**

## E

Environment **59, 77**  
   creating **59**  
     Logical Host **59**  
     SeeBeyond Integration Server **60**  
 eWays  
   creating **38**  
 External Application  
   creating **37**  
 External Applications **68**

## H

helper methods **99**

## I

implementation **65**

## J

Java methods **99**  
   CicsClient Class **99**  
 Javadoc **99**  
 JMS Client  
   properties **80**

## L

logging  
   enabling and modifying **48**  
   levels and categories **48**

## M

methods  
   packed decimal helper methods **99**  
     ContainerExists **100**  
     CopyBack **100**  
     CopyTo **101**  
     GiveElem **101**  
     SetElem **102**  
   packed decimal helper methods example **102**  
 Microsoft Internet Explorer **12**

## O

operating systems  
   supported **11**

## P

## project

- creating 67
- importing 66
- JCE sample overview 67
- using Java Collaborations 65

## properties

- CICS Client 41, 47
  - CICS Password 47
  - CICS Program 41
  - CICS TransId 42
  - CICS UserId 47
  - Class 40
  - COMMAREA length 42
  - COMMAREA Padding Character 43
  - configuring 37
  - configuring the eWays 60
  - Connection Transport 40
  - Connectivity Map properties 40
    - modifying 38
  - Connector
    - Class 40
  - ECI call type 42
  - Encoding 42
  - Host 44
  - JMS Client 80
  - KeepAlive 44
  - Listener Timeout 44
  - NoDelay 44
  - Polling Rate 45
  - Port 45
  - Property.Tag 41
  - ReceiveBufSize 45
  - SeeBeyond CICS Listener 43
  - SeeBeyond CICS Listener TransId 45
  - SendBufSize 45
  - Start Delay 46
  - Start Type 46
  - TP Timeout 46
  - Transport Timeout 46
  - Type 41
- Properties Sheet 39

## R

running a project 63, 82

## S

## sar files

- CICSeWay.sar 14

## security 9

security validation

request start transaction mode 10

## SeeBeyond Listener

- business logic mode 10
- request link to program mode 10
- request start transaction mode 11
- z/OS CICS security 9

## SeeBeyond CICS Listener

- configuration file maintenance screen for z/OS 18
- configuration requirements 12
- installation
  - 3480 tape 16
    - adding the CICS e\*Way Load Module 17
    - CICS CEDA definitions 17
    - copying the tape contents to disk 16
    - verifying proper installation 17
  - z/OS 15
    - installation from CD-ROM 15
    - monitor screen for OS/390 23
- overview 8
- system requirements 12
  - external 12

## W

Windows 12

Windows 2000 12