

SeeBeyond ICAN Suite

Sybase eWay Intelligent Adapter User's Guide

Release 5.0.2



The information contained in this document is subject to change and is updated periodically to reflect changes to the applicable software. Although every effort has been made to ensure the accuracy of this document, SeeBeyond Technology Corporation (SeeBeyond) assumes no responsibility for any errors that may appear herein. The software described in this document is furnished under a License Agreement and may be used or copied only in accordance with the terms of such License Agreement. Printing, copying, or reproducing this document in any fashion is prohibited except in accordance with the License Agreement. The contents of this document are designated as being confidential and proprietary; are considered to be trade secrets of SeeBeyond; and may be used only in accordance with the License Agreement, as protected and enforceable by law. SeeBeyond assumes no responsibility for the use or reliability of its software on platforms that are not supported by SeeBeyond.

SeeBeyond, e*Gate, and e*Way are the registered trademarks of SeeBeyond Technology Corporation in the United States and select foreign countries; the SeeBeyond logo, e*Insight, and e*Xchange are trademarks of SeeBeyond Technology Corporation. The absence of a trademark from this list does not constitute a waiver of SeeBeyond Technology Corporation's intellectual property rights concerning that trademark. This document may contain references to other company, brand, and product names. These company, brand, and product names are used herein for identification purposes only and may be the trademarks of their respective owners.

© 2003 by SeeBeyond Technology Corporation. All Rights Reserved. This work is protected as an unpublished work under the copyright laws.

This work is confidential and proprietary information of SeeBeyond and must be maintained in strict confidence.

Version 20031218151946.

eWay Contents

Chapter 1

Introduction	6
Overview	6
Supported Operating Systems	6
System Requirements	7
External System Requirements	7

Chapter 2

Installing the Sybase eWay	8
Before Installing the eWay	8
Installing the Sybase eWay	8
After Installation	9

Chapter 4

Properties of the Sybase eWay	10
Setting the eWay Properties in the Connectivity Map	10
Setting the Properties in the Outbound eWay	10
ClassName	11
Description	11
InitialPoolSize	12
LoginTimeOut	12
MaxIdleTime	12
MaxPoolSize	12
MaxStatements	12
MinPoolSize	13
NetworkProtocol	13
PropertyCycle	13
RoleName	13
Setting the Properties in the Inbound eWay	14
Pollmilliseconds	14
PreparedStatement	14
Setting the Properties in the Outbound eWay Environment	15
DatabaseName	15

DataSourceName	15
Delimiter	16
Description	16
DriverProperties	16
Password	16
PortNumber	17
ServerName	17
User	17
Setting the Properties in the Inbound eWay Environment	18
DatabaseName	18
Password	18
PortNumber	19
ServerName	19
User	19

Chapter 5

Using the Sybase eWay Database Wizard	20
Using the Database OTD Wizard	20
To create a new OTD using the Database Wizard	20

Chapter 6

Reviewing the eWay Project(s)	30
eInsight Engine and eGate Components	30
Using the Sample Project in eInsight	30
The Business Process	32
whereClause()	33
selectAll	33
selectMultiple	35
selectOne	37
insert	38
update	39
delete	41
Using the Sample Project in eGate	42
Working with the Sample Project in eGate	42
Configuring the eWays	43
Creating the Environment Profile	44
Deploying a Project	44
Running the Sample	44
Common DataType Conversions	45
Using OTDs with Tables, Views, and Stored Procedures	46
The Table	46
The Query Operation	46
The Insert Operation	47
The Update Operation	48
The Delete Operation	49

The Stored Procedure	49
Executing Stored Procedures	49
Alerting and Logging	51
Index	52

Introduction

This document describes how to install and configure the eWay Intelligent Adapter for Sybase.

This Chapter Includes:

- [“Overview” on page 6](#)
- [“Supported Operating Systems” on page 6](#)
- [“System Requirements” on page 7](#)
- [“External System Requirements” on page 7](#)

1.1 Overview

The Sybase eWay enables eGate Integrator Projects to exchange data with external Sybase databases. This user’s guide describes how to install and configure the Sybase eWay.

1.2 Supported Operating Systems

The Sybase eWay is available on the following operating systems:

- Windows Server 2003, Windows XP SP1a, and Windows 2000 SP3
- HP Tru64 V5.1A
- HP-UX 11.0 and 11i
- IBM AIX 5.1 and 5.2
- Red Hat Linux 8.0
- Red Hat Enterprise Linux AS 2.1
- Sun Solaris 8 and 9

Although the Sybase eWay, the Repository, and Logical Hosts run on the platforms listed above, the Enterprise Designer requires the Windows operating system. Enterprise Manager can run on any platform that supports Internet Explorer 6.0.

1.3 System Requirements

The system requirements for the Sybase eWay are the same as for eGate Integrator. For information, refer to the *eGate Integrator Installation Guide*. It is also helpful to review the **Readme.txt** for any additional requirements prior to installation. The **Readme.txt** is located on the installation CD-ROM.

Note: To enable Web Services, you must install and configure the SeeBeyond ICAN Suite eInsight Business Process Manager.

1.4 External System Requirements

The Sybase eWay supports the following software for external systems running eGate Projects.

- Sybase Server 11.9 or 12.5.

Installing the Sybase eWay

This chapter describes how to install the Sybase eWay.

This Chapter Includes:

- “Before Installing the eWay” on page 8
- “Installing the Sybase eWay” on page 8
- “After Installation” on page 9

2.1 Before Installing the eWay

Open and review the **Readme.txt** for the Sybase eWay for any additional information or requirements, prior to installation. The **Readme.txt** is located on the installation CD-ROM.

2.2 Installing the Sybase eWay

During the eGate Integrator installation process, the Enterprise Manager, a web-based application, is used to select and upload eWays (eWay.sar files) from the eGate installation CD-ROM to the Repository.

The installation process includes installing the following components:

- Installing the Repository
- Uploading products to the Repository
- Downloading components (such as Enterprise Designer and Logical Host)
- Viewing product information home pages

Follow the instructions for installing the eGate Integrator in the *ICAN Installation Guide*, and include the following steps:

- On the Enterprise Manager, select the **SybaseeWay.sar** (to install the Sybase eWay) file to upload.
- On the Enterprise Manager, select the **FileeWay.sar** (to install the File eWay, used in the sample Project) file to upload.

- On the Enterprise Manager, install the **SybaseeWayDocs.sar** (to install the documentation and the sample) file to upload.
- On the Enterprise Manager under the Documentation tab, click on the document link or the sample file link. For the sample project, it is recommended that you extract the file to another file location prior to importing it using the Enterprise Explorer's Import Project tool.

For additional information on how to use eGate, please see the *eGate Tutorial*.

Continue installing the eGate Enterprise Designer as instructed.

2.3 After Installation

Once the eWay is installed and configured it must then be incorporated into a Project before it can perform its intended functions. See the *eGate Integrator User's Guide* for more information on incorporating the eWay into an eGate Project.

Properties of the Sybase eWay

This chapter describes how to set the properties of the Sybase eWay.

This Chapter Includes:

- [Setting the Properties in the Outbound eWay](#) on page 10
- [Setting the Properties in the Inbound eWay](#) on page 14
- [Setting the Properties in the Outbound eWay Environment](#) on page 15
- [Setting the Properties in the Inbound eWay Environment](#) on page 18

4.1 Setting the eWay Properties in the Connectivity Map

On the Properties sheet window and using the descriptions below, enter the information necessary for the eWay to establish a connection to the external application.

4.1.1. Setting the Properties in the Outbound eWay

The DataSource settings define the properties used to interact with the external database.

Figure 1 The eWay Properties

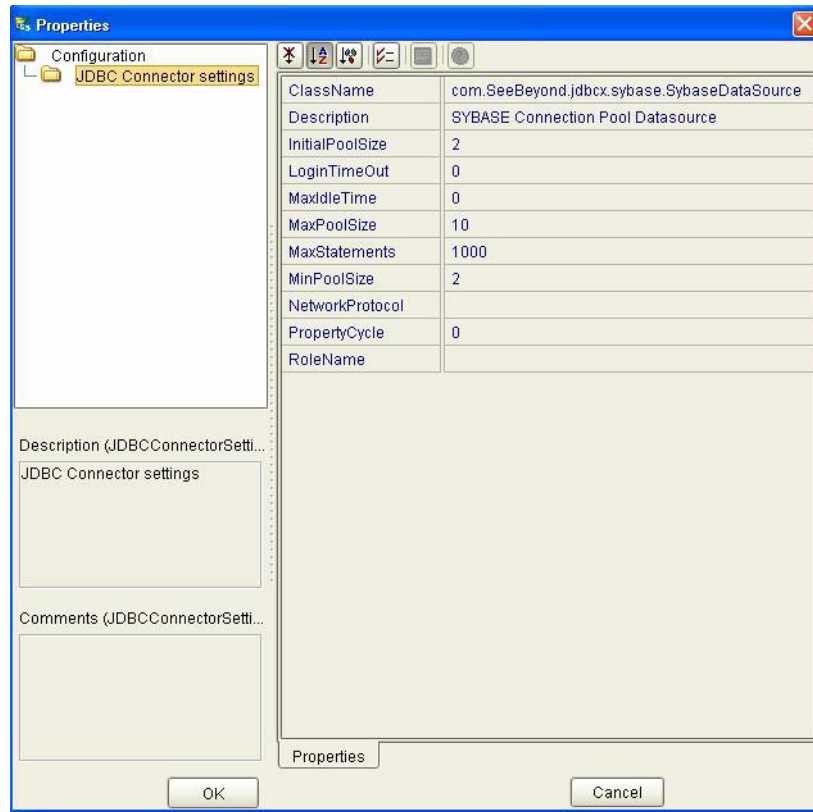

The DataSource settings define the properties used to interact with the external database.

ClassName

Description

Specifies the Java class in the JDBC driver that is used to implement the ConnectionPoolDataSource interface.

Required Values

A valid class name.

The default is **com.SeeBeyond.jdbcx.sybase.sybaseDataSource**.

Description

Description

Enter a description for the database.

Required Value

A valid string.

InitialPoolSize

Description

Enter a number for the physical connections the pool should contain when it is created.

Required Value

A valid numeric value. The default is 2.

LoginTimeout

Description

The number of seconds driver will wait before attempting to log in to the database before timing out.

Required Value

A valid numeric value.

MaxIdleTime

Description

The maximum number of seconds that a physical connection may remain unused before it is closed. 0 (zero) indicates that there is no limit.

Required Value

A valid numeric value.

MaxPoolSize

Description

The maximum number of physical connections the pool should keep available at all times. 0 (zero) indicates that there is no maximum.

Required Value

A valid numeric value. The default is 10.

MaxStatements

Description

The maximum total number of statements that the pool should keep open. 0 (zero) indicates that the caching of statements is disabled.

Required Value

A valid numeric value. The default is 1000.

MinPoolSize

The minimum number of physical connections the pool should keep available at all times. 0 (zero) indicates that there should be no physical connections in the pool and the new connections should be created as needed.

Required Value

A valid numeric value. The default is 2.

NetworkProtocol

Description

The network protocol used to communicate with the server.

Required Values

Any valid string.

PropertyCycle

Description

The interval, in seconds, that the pool should wait before enforcing the current policy defined by the values of the other connection pool properties in this deployment descriptor.

Required Values

A valid numeric value. The default is 0.

RoleName

Description

An initial SQL role name.

Required Values

Any valid string.

4.1.2. Setting the Properties in the Inbound eWay

Figure 2 Properties of the Inbound eWay



Pollmilliseconds

Description

Polling interval in milliseconds.

Required Value

A valid numeric value. The default is 5000.

PreparedStatement

Description

Prepared Statement used for polling against the database.

Required Value

The Prepared Statement must be the same Prepared Statement you created using the Database OTD Wizard. Only SELECT Statement is allowed. Additionally, no place holders should be specified. There should not be any “?” in the Prepared Query.

4.1.3. Setting the Properties in the Outbound eWay Environment

Before deploying your eWay, you will need to set the properties of the eWay environment using the following descriptions.

Figure 3 eWay Environment Configuration

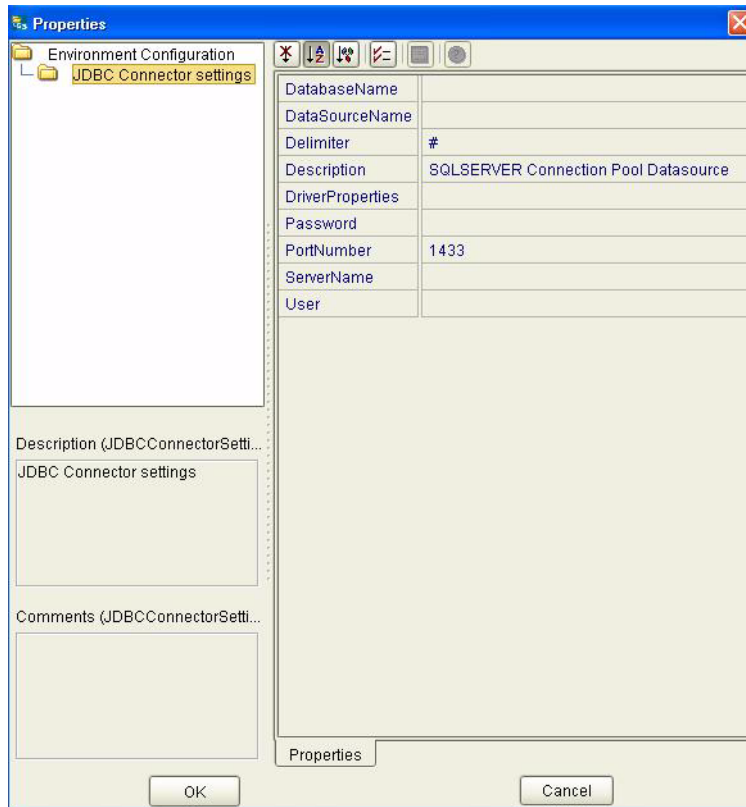

DatabaseName

Description

Specifies the name of the database instance.

Required Values

Any valid string.

DataSourceName

Description

Provide the name of the ConnectionPoolDataSource object that the DataSource object delegates behind the scenes when connection pooling or distributed transaction management is being done.

Required Value

Optional. In most cases, leave this box empty.

Delimiter

Description

This is the delimiter character to be used in the DriverProperties prompt.

Required Value

The default is #

Description

Description

Enter a description for the database.

Required Value

A valid string.

DriverProperties

Description

If you choose to not to use the JDBC driver that is shipped with this eWay, you will need to add the drivers properties to the eWay. Often times the DataSource implementation will need to execute additional properties to assure a connection. The additional methods will need to be identified in the Driver Properties.

Required Value

Any valid delimiter.

Valid delimiters are: "`<method-name-1>#<param-1>#<param-2>##.....<param-n>##<method-name-2>#<param-1>#<param-2>#.....<param-n>##.....##`".

For example: to execute the method setURL, give the method a String for the URL "`setURL#<url>##`".

If you are using Spy Log. Optional:

`setURL#jdbc:SeeBeyond:db2://<server>:446;locationName=<location>;collectionId=<collection>##setLocationName#<location>##setCollectionID#<collection>##setSpyAttributes#log=(file)c:/temp/spy.log;logTName=yes##`".

Password

Description

Specifies the password used to access the database.

Required Values

Any valid string.

PortNumber

Description

Specifies the I/O port number on which the server is listening for connection requests.

Required Values

A valid port number. The default is 1521.

ServerName

Description

Specifies the host name of the external database server.

Required Values

Any valid string.

User

Description

Specifies the user name the eWay uses to connect to the database.

Required Values

Any valid string.

4.1.4. Setting the Properties in the Inbound eWay Environment

Figure 4 Inbound eWay Environment



DatabaseName

Description

Specifies the name of the database instance.

Required Values

Any valid string.

Password

Description

Specifies the password used to access the database.

Required Values

Any valid string.

PortNumber

Description

Specifies the I/O port number on which the server is listening for connection requests.

Required Values

A valid port number. The default is 1433.

ServerName

Description

Specifies the host name of the external database server.

Required Values

Any valid string.

User

Description

Specifies the user name the eWay uses to connect to the database.

Required Values

Any valid string.

Using the Sybase eWay Database Wizard

This chapter describes how to use the Sybase eWay Database Wizard to build OTD's.

This Chapter Includes:

- [Select Wizard Type](#) on page 20
- [Connect to Database](#) on page 21
- [Select Database Objects](#) on page 22
- [Select Table/Views](#) on page 22
- [Select Procedures](#) on page 25
- [Add Prepared Statements](#) on page 26
- [Specify the OTD Name](#) on page 28

5.1 Using the Database OTD Wizard

The Database OTD Wizard generates OTDs by connecting to external data sources and creating corresponding Object Type Definitions. The OTD Wizard can create OTDs based on any combination of Tables and Stored Procedures or Prepared SQL Statements.

Field nodes are added to the OTD based on the Tables in the external data source. Java method and parameter nodes are added to provide the appropriate JDBC functionality. For more information about the Java methods, refer to your JDBC developer's reference.

Note: *Database OTDs are not messagable. For more information on messagable OTDs, see the eGate Integrator User's Guide.*

To create a new OTD using the Database Wizard

Select Wizard Type

- 1 On the Enterprise Explorer, right click on the project and select **Create an Object Type Definition** from the shortcut menu.

- From the OTD Wizard Selection window, select the **Sybase Database** and click **Next**. See [Figure 5](#).

Figure 5 OTD Wizard Selection

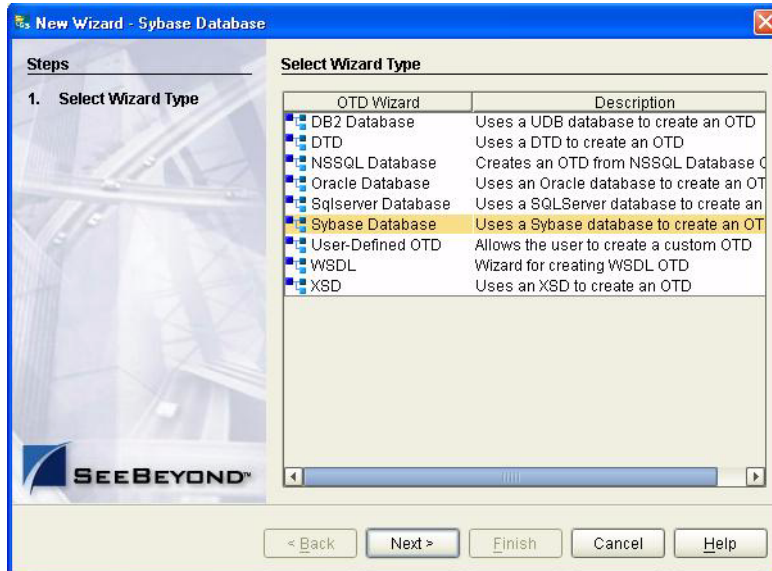

Connect to Database

- Specify the connection information for your database including your **UserName** and **Password** and click **Next**. See [Figure 6](#).

Figure 6 Database Connection Information

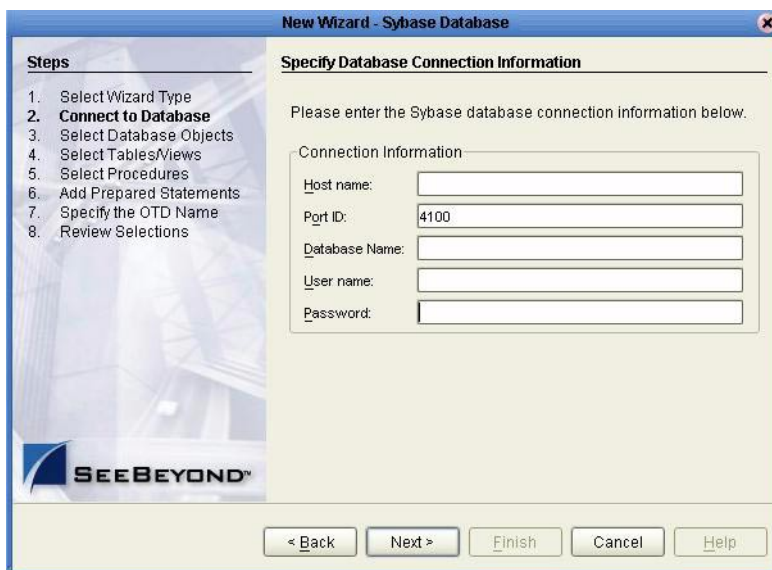

Select Database Objects

- 1 When selecting Database Objects, you can select any combination of **Tables, Views, Procedures, or Prepared Statements** you would like to include in the .otd file. Click **Next** to continue. See [Figure 7](#).

Note: Views are read-only and are for informational purposes only.

Figure 7 Select Database Objects

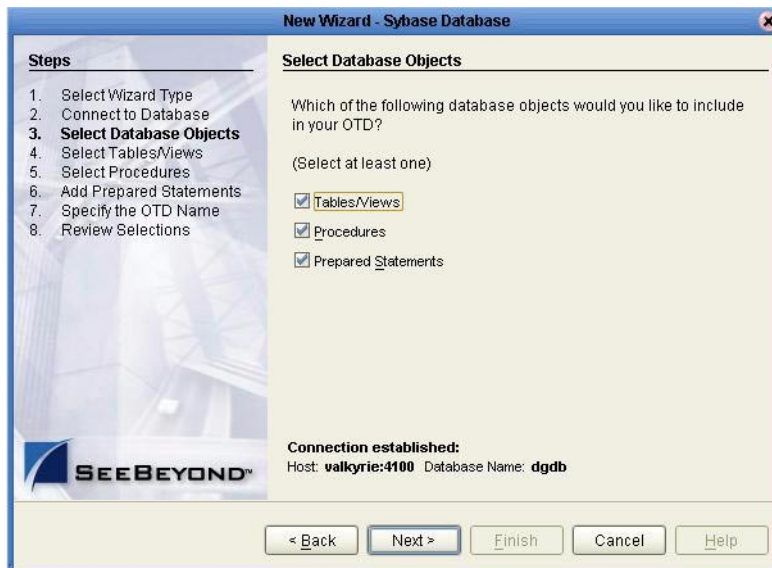

Select Table/Views

- 1 In the **Select Tables/Views** window, click **Add**. See [Figure 8](#).

Figure 8 Select Tables/Views

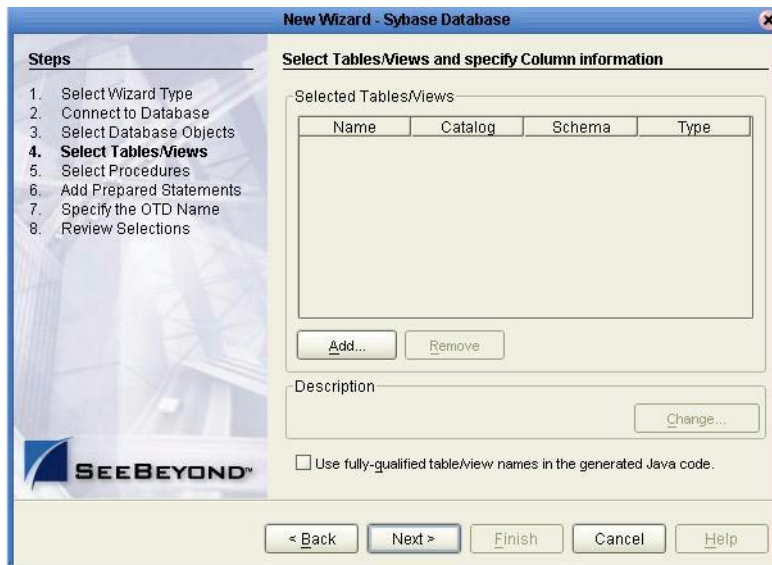

- 2 In the **Add Tables** window, select if your selection criteria will include table data, view only data, both, and/or system tables.
- 3 From the **Table/View Name** drop down list, select the location of your database table and click **Search**. See [Figure 9](#).

Figure 9 Database Wizard - All Schemes

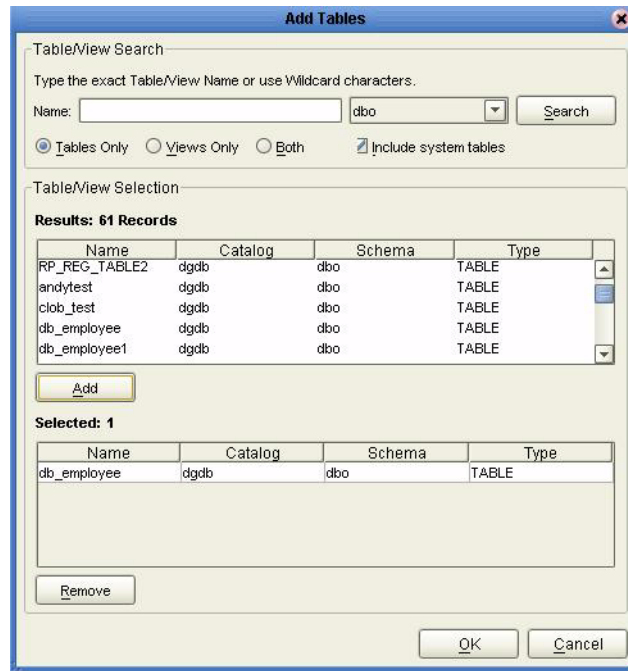

- 4 Select the table of choice and click **OK**.
- The table selected is added to the **Selected Tables/Views** window. See [Figure 10](#).

Figure 10 Selected Tables/Views window with a table selected

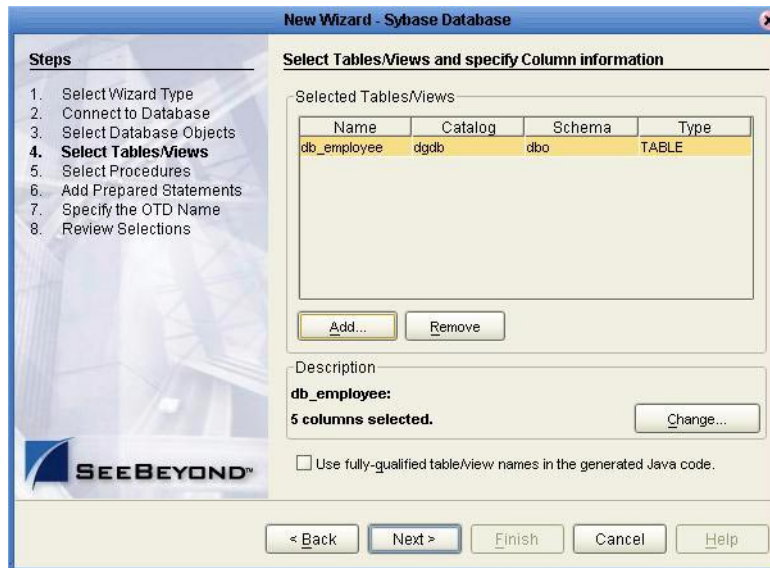

- 5 In the **Selected Tables/Views** window, review the table(s) you have selected. To make changes to the selected Table or View, click **Change**. If you do not wish to make any additional changes, click **Next** to continue.
- 6 In the **Table/View Columns** window, you can select or deselect your table columns. You can also change the data type for each table by highlighting the data type and selecting a different one from the drop down list. If you would like to change any of the tables columns, click **Change**. See [Figure 11](#).

Figure 11 Table/View Columns

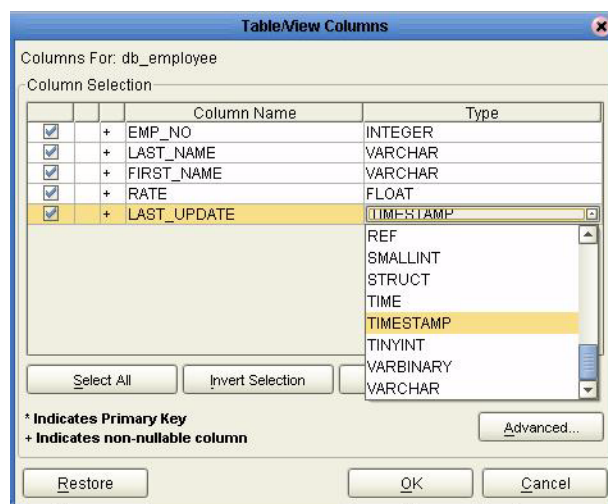

- 7 Click **Advanced** to change the data type, precision/length, or scale. Once you have finished your table choices, click **OK**. In general, you will not need to make any changes. See [Figure 12](#).

Figure 12 Table/View Columns – Advanced

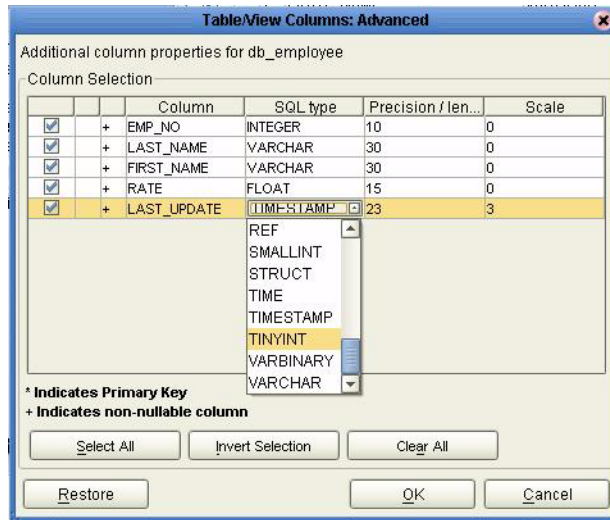

Select Procedures

- 1 On the **Select Procedures** and specify Resultset and Parameter Information window, click **Add**.

Figure 13 Select Procedures and specify Resultset and Parameter Information

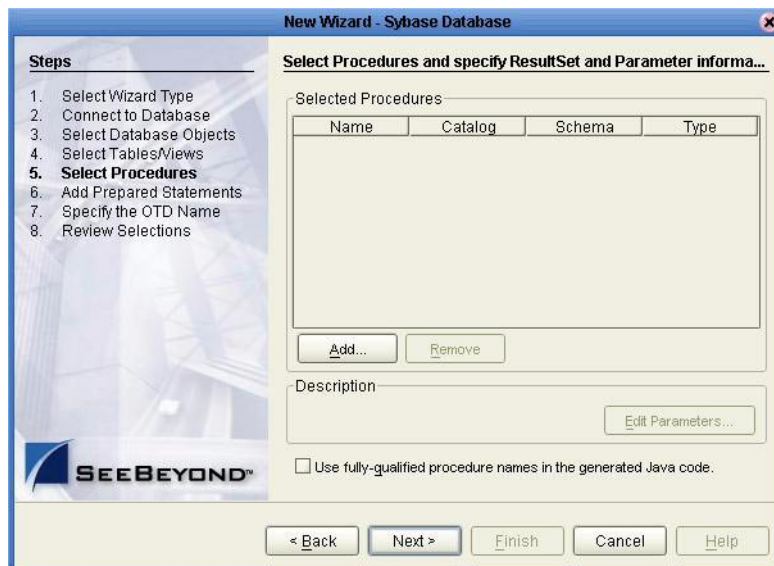

- 2 On the **Select Procedures** window, enter the name of a Procedure or select a table from the drop down list. Click **Search**. Wildcard characters can also be used.
- 3 In the resulting **Procedure Selection** list box, select a Procedure. Click **OK**.

Figure 14 Add Procedures

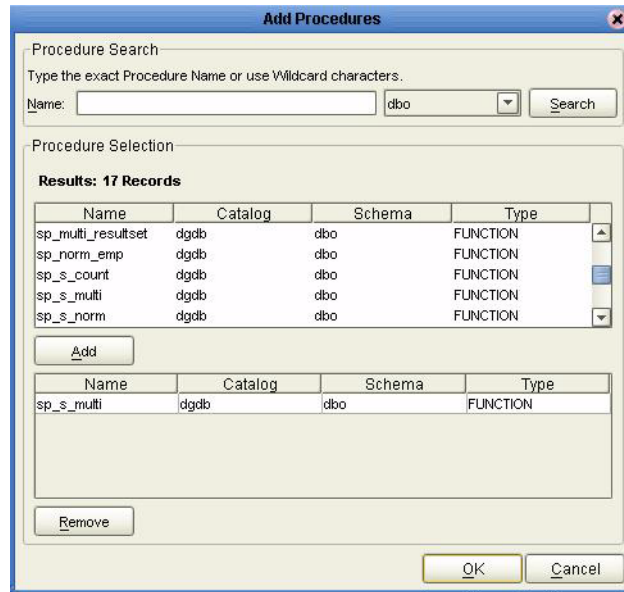

- 4 On the **Select Procedures and specify Resultset and Parameter Information** window click **Edit Parameters** to make any changes to the selected Procedure. See **Figure 15**.

Figure 15 Procedure Parameters

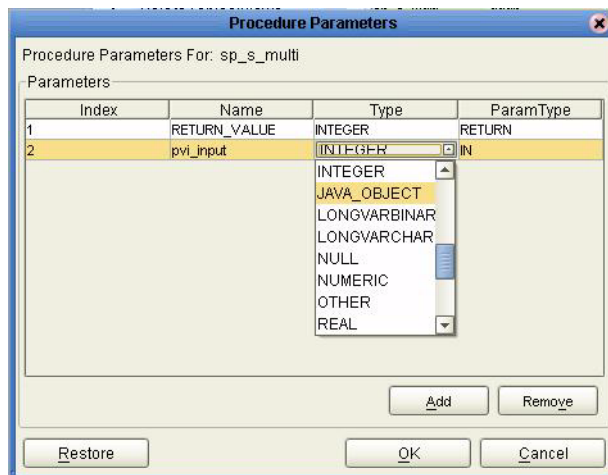

- 5 To restore the data type, click **Restore**. When finished, click **OK**.
- 6 On the **Select Procedures and specify Resultset and Parameter Information** window click **Next** to continue.

Add Prepared Statements

- 1 On the **Add Prepared Statements** window, click **Add**.

Figure 16 Prepared Statement

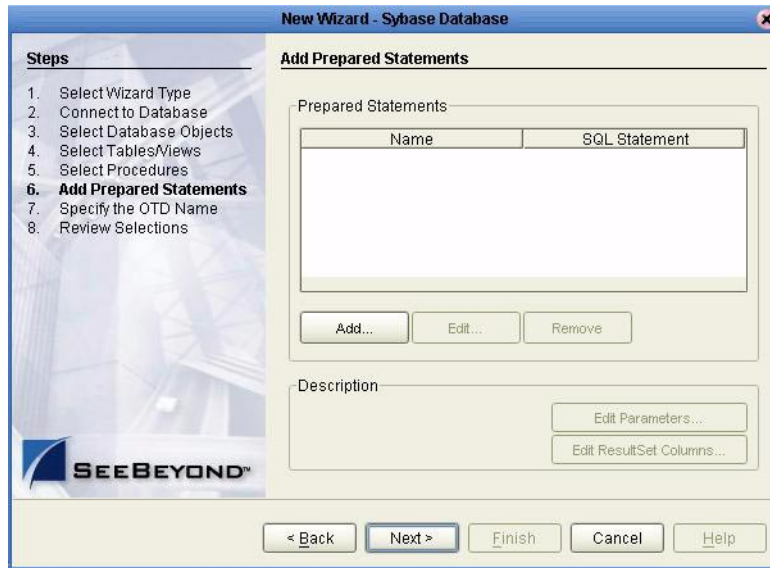

- 2 Enter the name of a Prepared Statement or create a SQL statement by clicking in the SQL Statement window. When finished creating the statement, click **Save As** giving the statement a name. This name will appear as a node in the OTD. Click **OK**. See [Figure 17](#).

Figure 17 Prepared SQL Statement

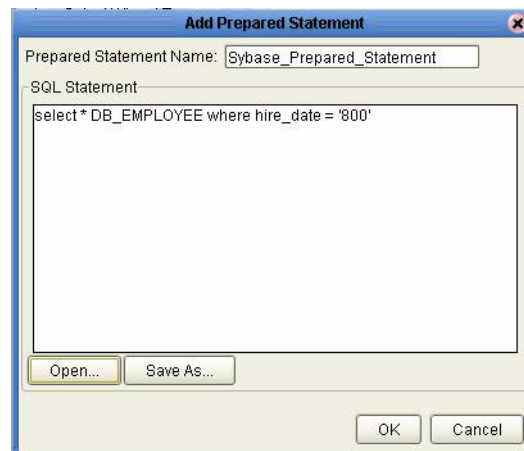

- 3 On the **Add Prepared Statement** window, the name you assigned to the Prepared Statement appears. To edit the parameters, click **Edit Parameters**. You can change the datatype by clicking in the **Type** field and selecting a different type from the list.
- 4 Click **Add** if you want to add additional parameters to the Statement or highlight a row and click **Remove** to remove it. Click **OK**. See [Figure 18](#).

Figure 18 Edit the Prepared Statement Parameters

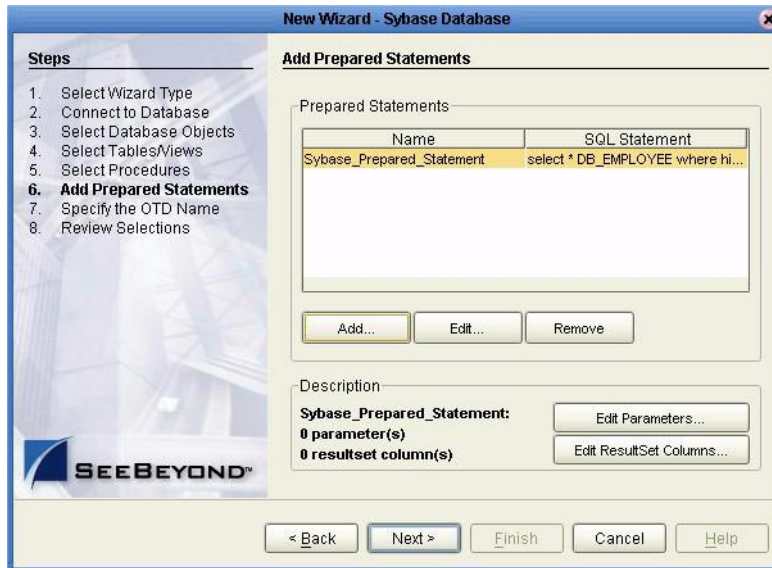

- 1 To edit the Resultset Columns, click **Edit Resultset Columns**. Both the Name and Type are editable but it is recommend you do not changed the Name. Doing so will cause a loss of inegraty between the Resultset and the Database. Click **OK**. See [Figure 19](#).

Figure 19 ResultSet Columns

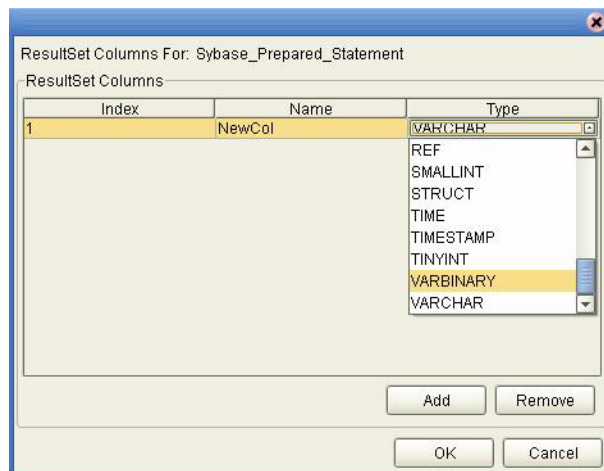

Specify the OTD Name

- 1 Enter a name for the OTD. The OTD contains the selected tables and the package name of the generated classes. See [Figure 20](#).

Figure 20 Naming an OTD

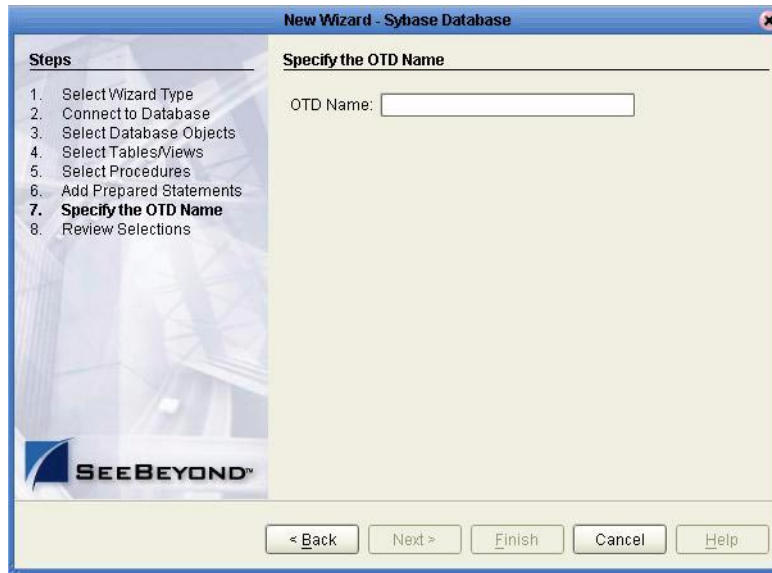

- 2 View the summary of the OTD. If you find you have made a mistake, click **Back** and correct the information. If you are satisfied with the OTD information, click **Finish** to begin generating the OTD. See [Figure 21](#).

Figure 21 Database Wizard - Summary

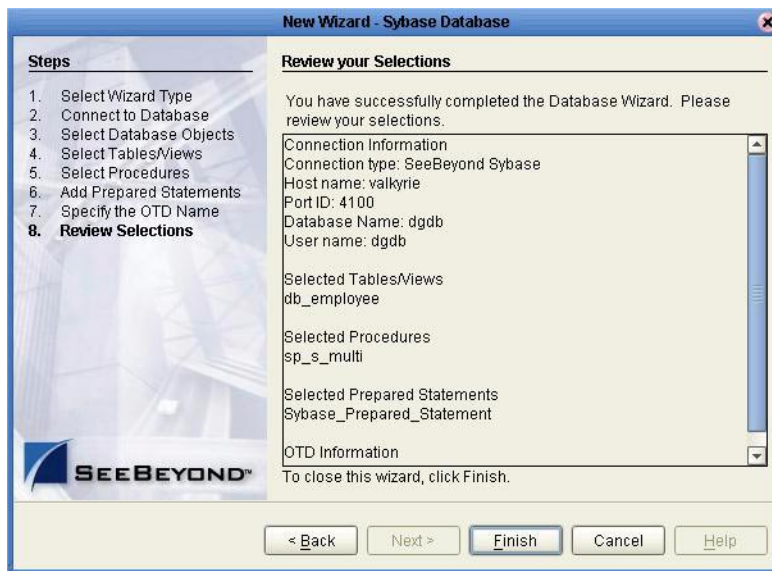

The resulting OTD will appear on the Enterprise Designer's canvas.

Reviewing the eWay Project(s)

This chapter describes how to build an eWay project in a production environment.

This Chapter Includes:

- [eInsight Engine and eGate Components](#) on page 30
- [Using the Sample Project in eInsight](#) on page 30
- [Using the Sample Project in eGate](#) on page 42
- [Common DataType Conversions](#) on page 45
- [Using OTDs with Tables, Views, and Stored Procedures](#) on page 46
- [Alerting and Logging](#) on page 51

6.1 eInsight Engine and eGate Components

You can deploy an eGate component as an Activity in an eInsight Business Process. Once you have associated the desired component with an Activity, the eInsight engine can invoke it using a Web Services interface. Examples of eGate components that can interface with eInsight in this way are:

- Java Messaging Service (JMS)
- Object Type Definitions (OTDs)
- An eWay
- Collaborations

Using the eGate Enterprise Designer and eInsight, you can add an Activity to a Business Process, then associate that Activity with an eGate component, for example, an eWay. When eInsight runs the Business Process, it automatically invokes that component via its Web Services interface.

6.2 Using the Sample Project in eInsight

To begin using the sample eInsight Business Process project, you will need to import the project and view it from within the Enterprise Designer using the Enterprise

Designer Project Import utility. Import the **Syb_BPEL_Sample.zip** file contained in the eWay sample folder on the installation CD-ROM.

Note: *eInsight is a Business Process modeling tool. If you have not purchased eInsight, contact your sales representative for information on how to do so.*

Before recreating the sample Business Process, review the *eInsight Business Process Manager User's Guide* and the *eGate Tutorial*.

Importing the Sample Project

- 1 On the Enterprise Explorer highlight the repository and right click. Select **Import Project**. See [Figure 22](#).

Figure 22 Importing the sample project

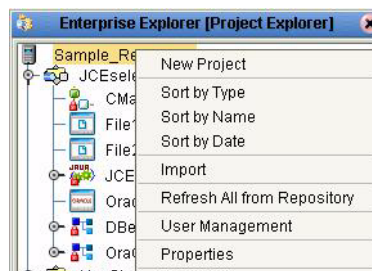

- 1 In the **Import Manager** window, **From ZIP file** browse to the location of the sample folder and select the following .zip file **Syb_BPEL_Sample.zip** and click **Import**. See [Figure 23](#).

Figure 23 Select the project file

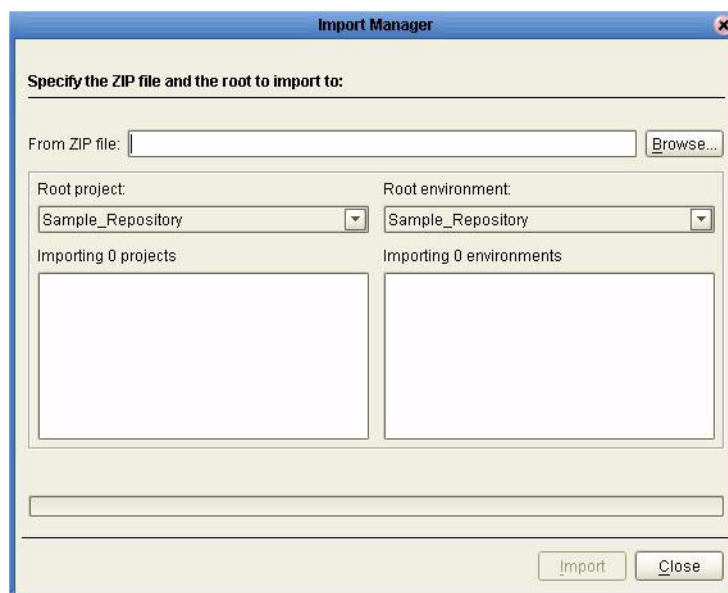

- 2 Click the **Refresh All From Repository** icon located on the **Enterprise Explorer** toolbar.

The Business Process

The data used for this sample project is contained within a table called db_employee. The table has the following columns:

Table 1 Sample project data

Column Name	Mapping	Data Type	Data Length
EMP_NO	employee_no	integer	10
LAST_NAME	employee_lname	varchar	30
FIRST_NAME	employee_fname	varchar	30
LAST_UPDATE	update_date	timestamp	16
RATE	rate	float	53

The sample project consists of an input file containing data that is passed into a database collaboration, and then written out to an output file

- 3 Refer to the *eInsight Business Process Manager User's Guide* for specific information on how to create and use a Business Process

You can associate an eInsight Business Process Activity with the eWay, both during the system design phase and during run time. To make this association, select the desired **receive** or **write** operation under the eWay in the Enterprise Explorer and drag it onto the eInsight Business Process canvas. The following operations are available:

- SelectAll
- SelectMultiple
- SelectOne
- Insert
- Update
- Delete

The operation automatically changes to an Activity with an icon identifying the component that is the basis for the Activity.

At run time, the eInsight engine invokes each step in the order that you defined in the Business Process. Using the engine's Web Services interface, the Activity in turn invokes the eWay. You can open a file specified in the eWay and view its contents before and after the Business Process is executed.

Note: *Inbound database eWays are only supported within BPEL Collaborations.*

The table below shows the inputs and outputs to each of these eInsight operations:

eInsight Operation	Input	Output
SelectAll	where() clause (optional)	Returns all rows that fit the condition of the where() clause
SelectMultiple	number of rows where() clause (optional)	Returns the number of rows specified that fit the condition of the where() clause
SelectOne	where() clause (optional)	Returns the first row that fits the condition of the where() clause
Insert	definition of new item to be inserted	Returns status.
Update	where() clause	Returns status.
Delete	where() clause	Returns status.

6.2.1 whereClause()

A BPEL whereClause() statement may be joined by AND/OR with conditions of "=", "!=", "<>", "<", ">", "<=", ">=".

For example:

whereClause such as where column2=2 AND column1=1 OR column3=3 is valid

6.2.2 SelectAll

The input to a SelectAll operation is an optional where() clause. The where() clause defines to which criteria rows must adhere to be returned. In the SelectAll operation, all items that fit the criteria are returned. If the where() clause is not specified, all rows are returned.

The figure below shows a sample eInsight Business Process using the SelectAll operation. In this process, the SelectAll operation returns all rows where the ITEM_ID matches the selected ITEM_ID to the shopping cart.

Figure 24 SelectAll Sample Business Process

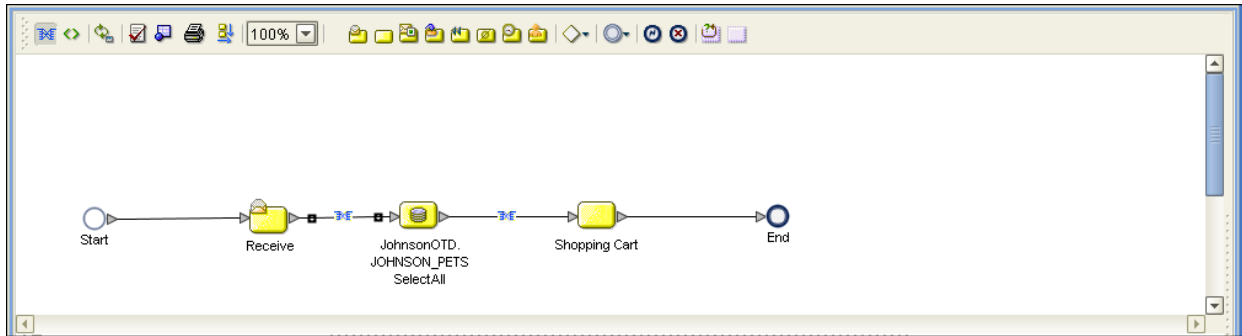

The figure below shows the definition of the where() clause for the SelectAll operation.

Figure 25 SelectAll Input

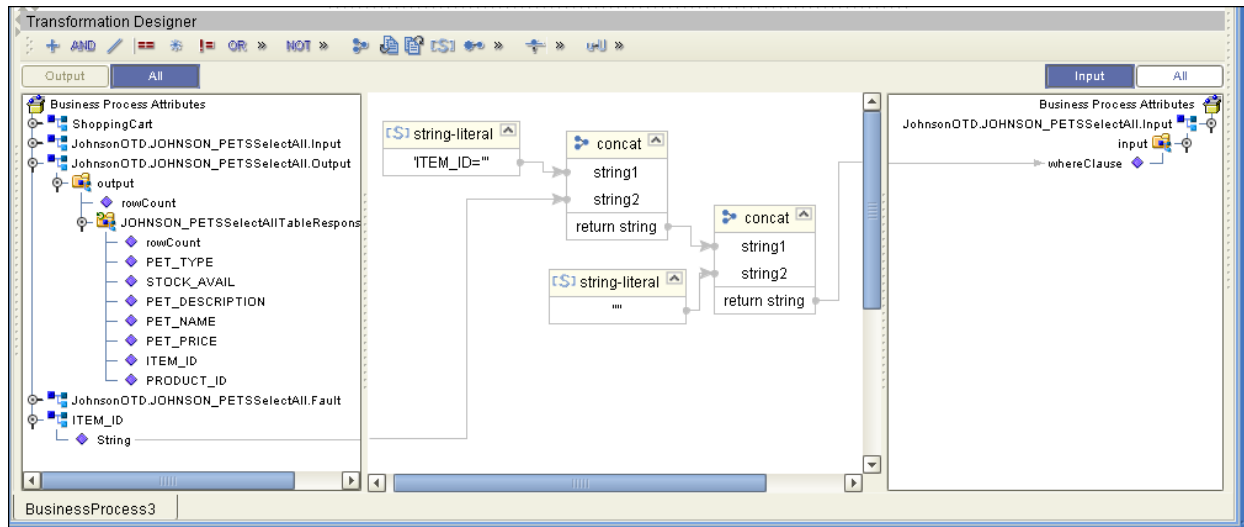

The figure below shows the definition of the output for the SelectAll operation. For each row selected during the operation, the shopping cart shows the columns of those rows as defined here.

Figure 26 SelectAll Output

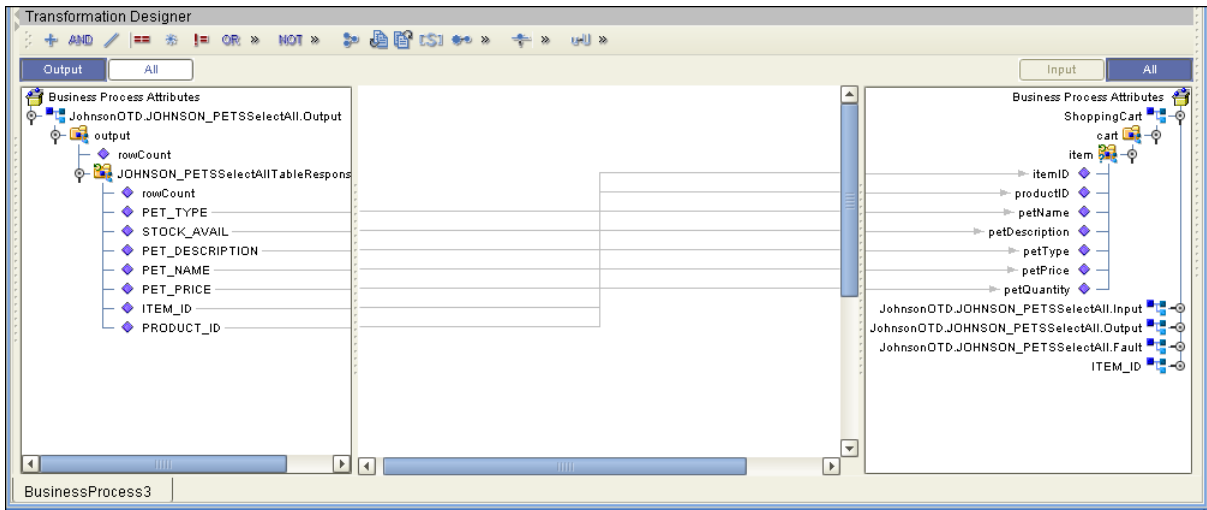

6.2.3 SelectMultiple

The input to a SelectMultiple operation is the number of rows to be selected and a where() clause. The number of rows indicates how many rows the SelectMultiple operation returns. The where() clause defines to which criteria rows must adhere to be returned.

The figure below shows a sample eInsight Business Process using the SelectMultiple operation. In this process, the SelectMultiple operation returns the first two rows where the ITEM_ID matches the selected ITEM_ID to the shopping cart.

Figure 27 SelectMultiple Sample Business Process

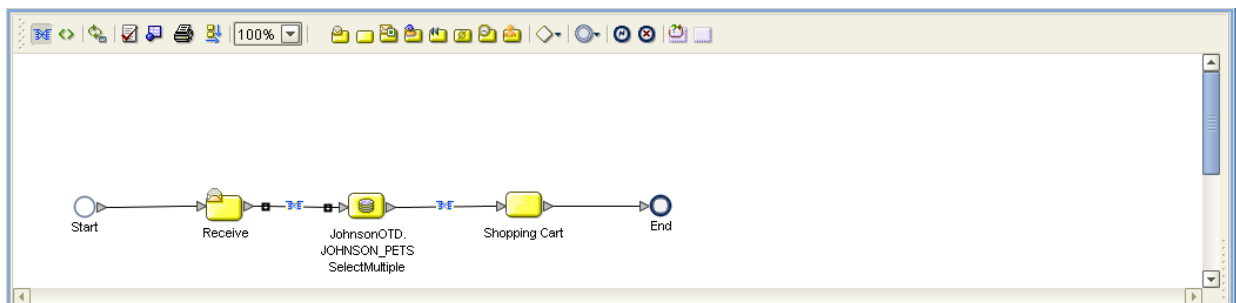

The figure below shows the definition of the number of rows and where() clause input for the SelectMultiple operation. You could also use an empty string for example item=ID=' '.

Figure 28 SelectMultiple Input

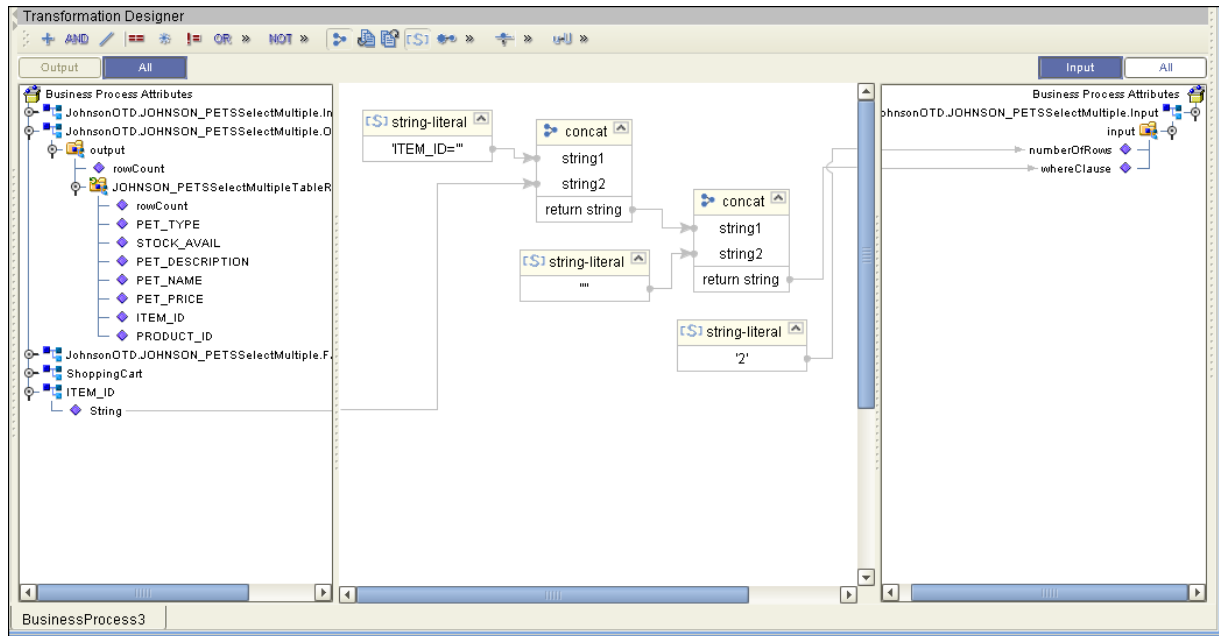

The figure below shows the definition of the output for the SelectMultiple operation. For each row selected during the operation, the shopping cart shows the columns of those rows as defined here.

Figure 29 SelectMultiple Output

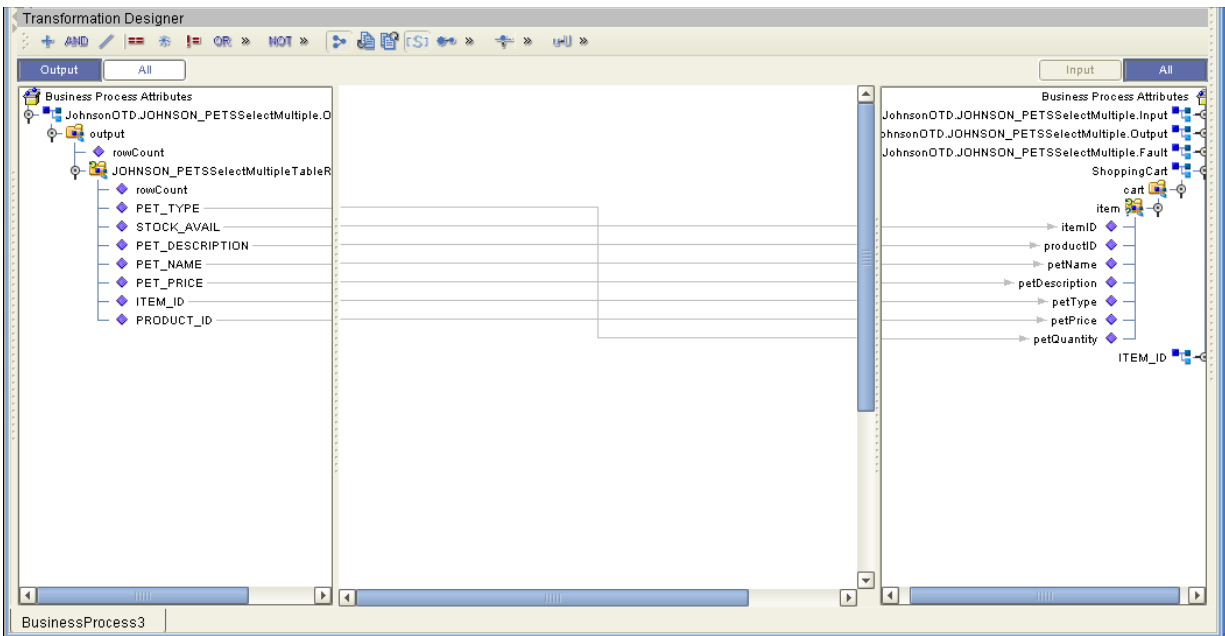

6.2.4 SelectOne

The input to a SelectOne operation is a where() clause. The where() clause defines to which criteria rows must adhere to be selected for the operation. In the SelectOne operation, the first row that fits the criteria is returned.

The figure below shows a sample eInsight Business Process using the SelectOne operation. In this process, the SelectOne operation returns the first row where the ITEM_ID matches the specified ITEM_ID to the shopping cart.

Figure 30 SelectOne Sample Business Process

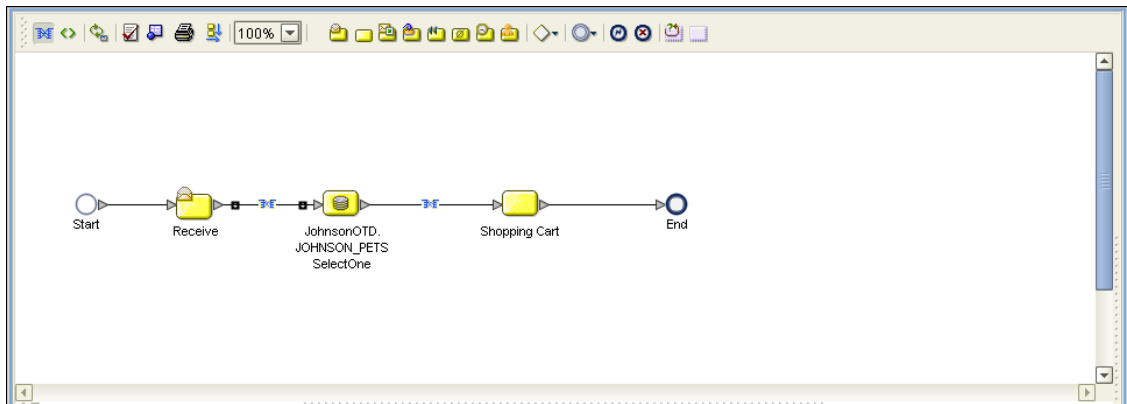

The figure below shows the definition of the where() clause for the SelectOne operation.

Figure 31 SelectOne Input

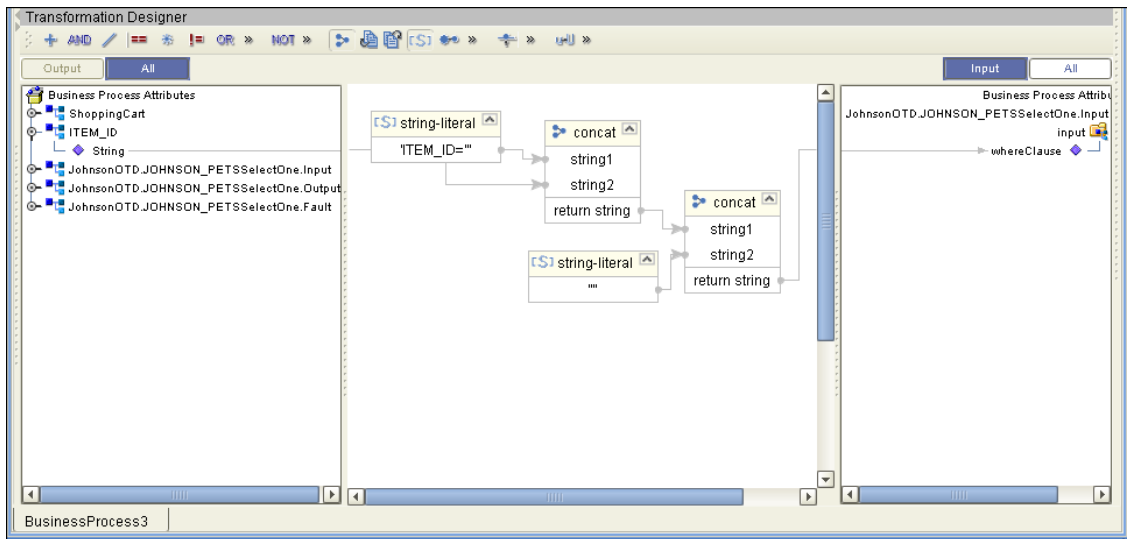

The figure below shows the definition of the output for the SelectOne operation. For the first row selected during the operation, the shopping cart shows the columns of that row as defined here.

Figure 32 SelectOne Output

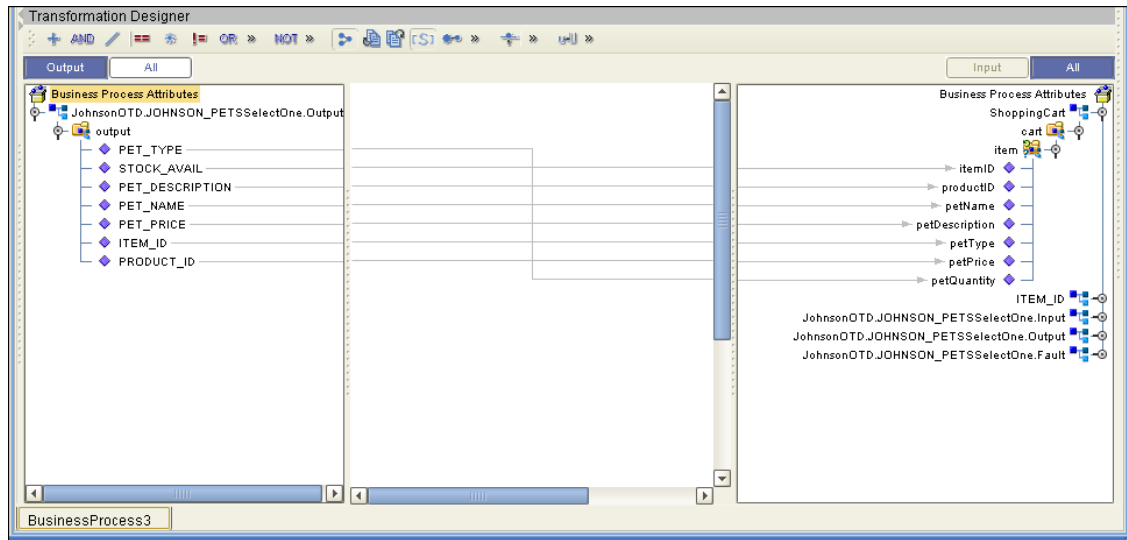

6.2.5 Insert

The Insert operation inserts a row. The input to an Insert operation is a where() clause. The where() clause defines to which criteria rows must adhere to be selected for the operation. In the Insert operation, the first row that fits the criteria is returned.

The figure below shows a sample eInsight Business Process using the Insert operation. In this process, the operation inserts a new row into the database to accommodate a new item provided by a vendor.

Figure 33 Insert Sample Business Process

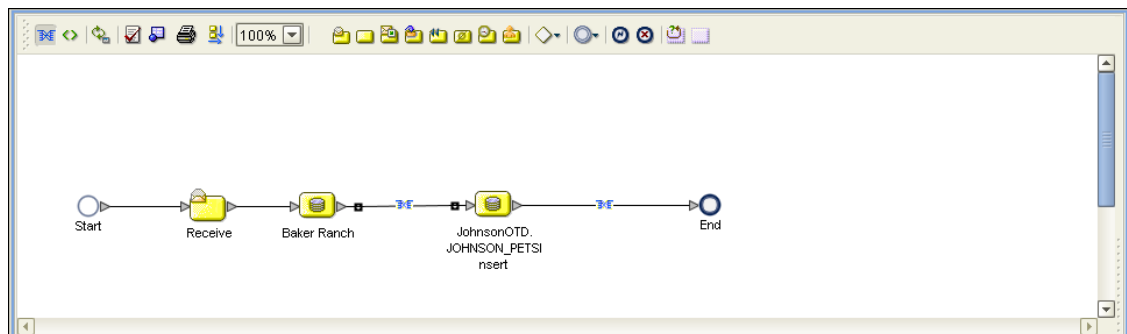

The figure below shows the definition of the input for the Insert operation.

Figure 34 Insert Input

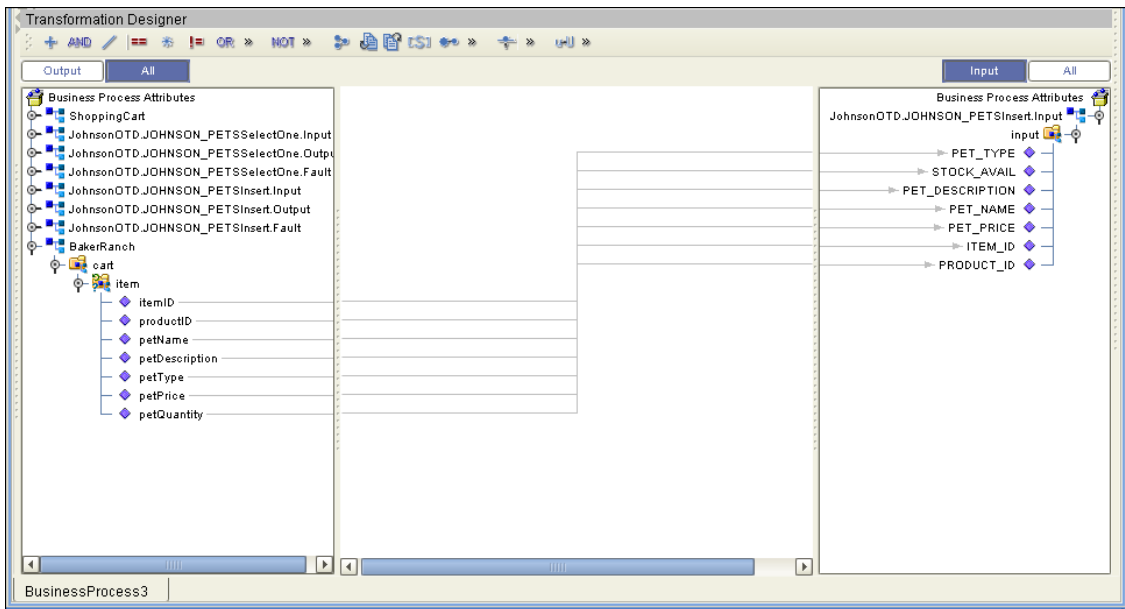

The figure below shows the output of the Insert operation, which is a status indicating the number of rows created.

Figure 35 Insert Output

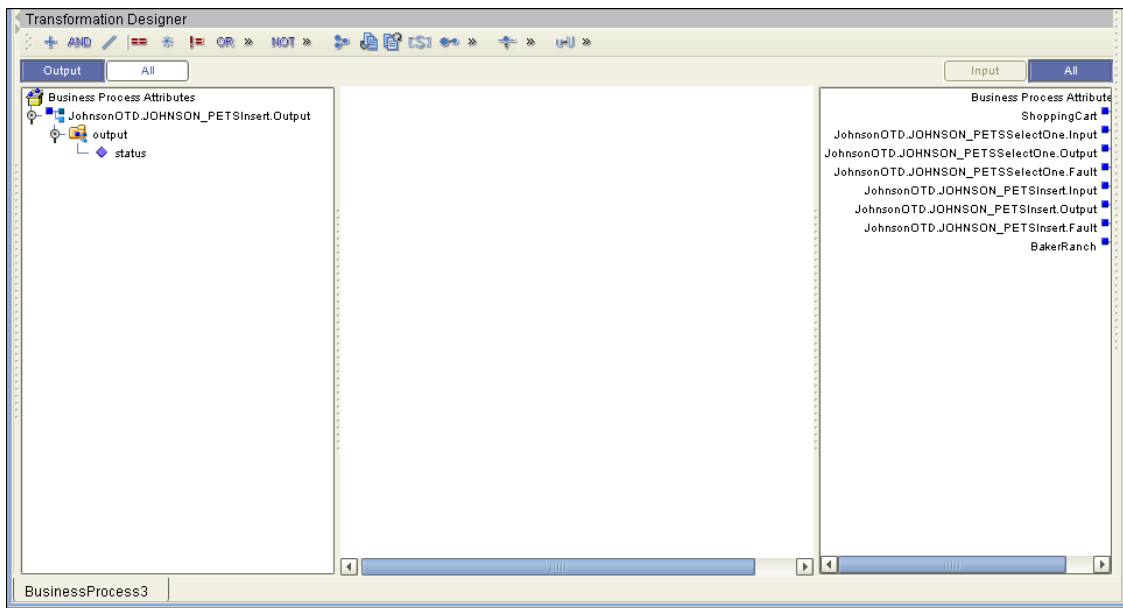

6.2.6 Update

The Update operation updates rows that fit certain criteria defined in a where() clause.

The figure below shows a sample eInsight Business Process using the Update operation. In this process, the operation updates the ITEM_ID for all items with a certain name to ESR_6543.

Figure 36 Update Sample Business Process

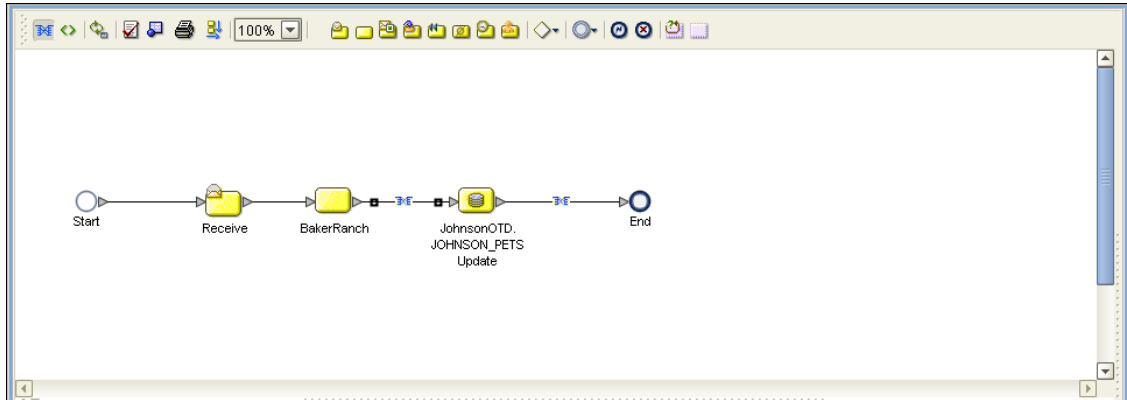

The figure below shows the definition of the where() clause for the Update operation.

Figure 37 Update Input

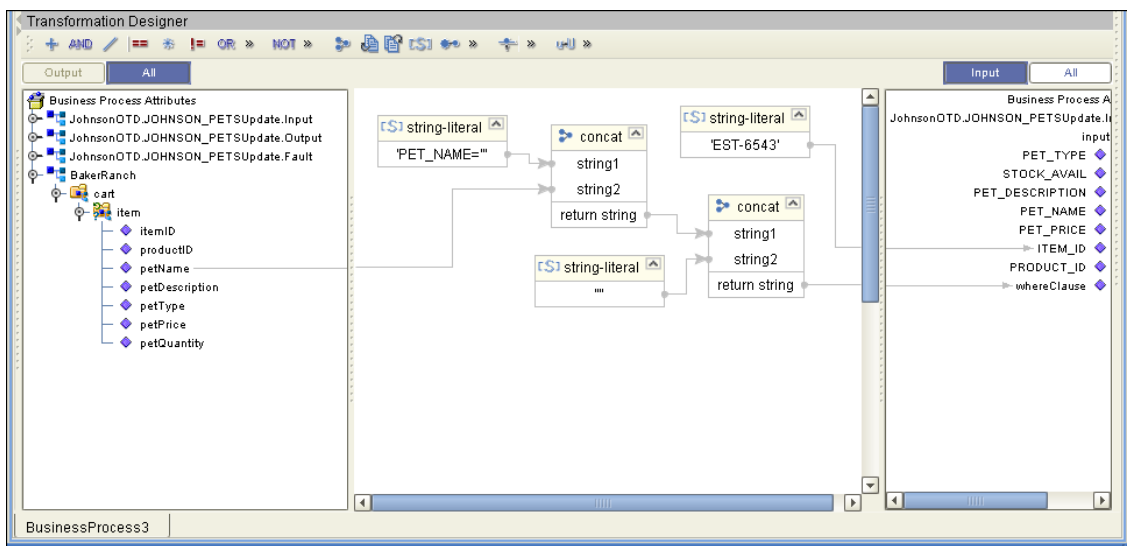

The figure below shows the output of the Update operation, which is a status indicating the number of rows updated.

Figure 38 Update Output

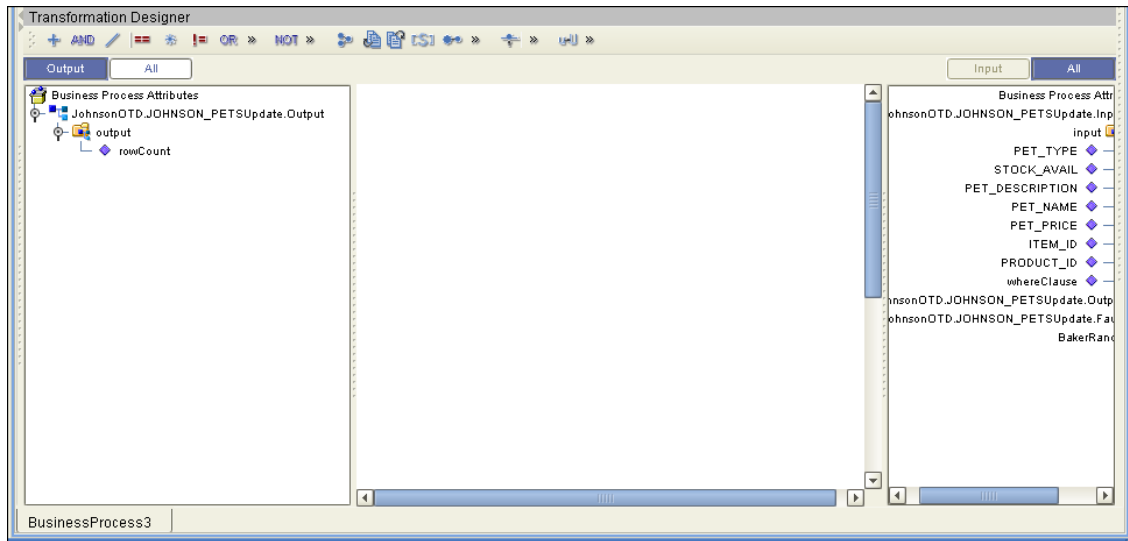

6.2.7 Delete

The Delete operation deletes rows that match the criteria defined in a where() clause. The output is a status of how many rows where deleted.

The figure below shows a sample eInsight Business Process using the Delete operation. In this process, the operation deletes rows with a certain product ID from the shopping cart.

Figure 39 Delete Sample Business Process

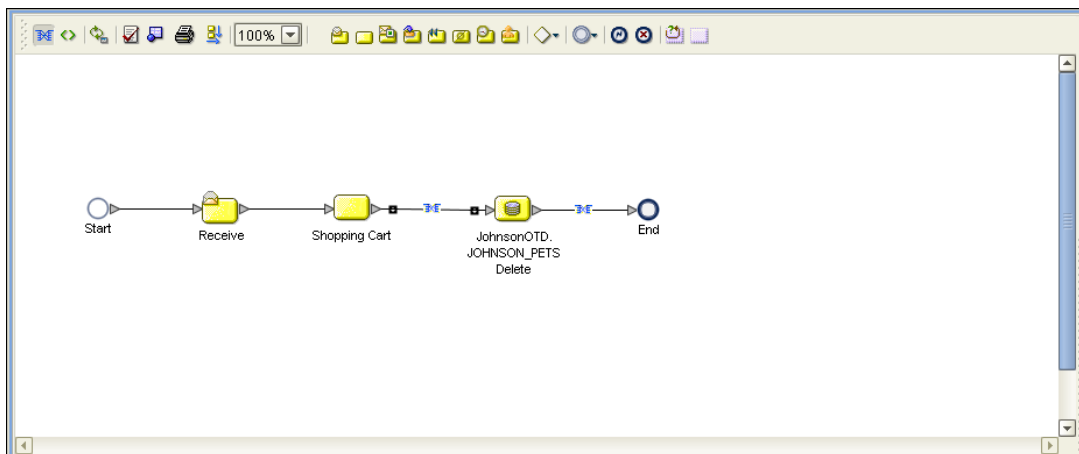

The figure below shows the definition of the where() clause for the Delete operation.

Figure 40 Delete Input

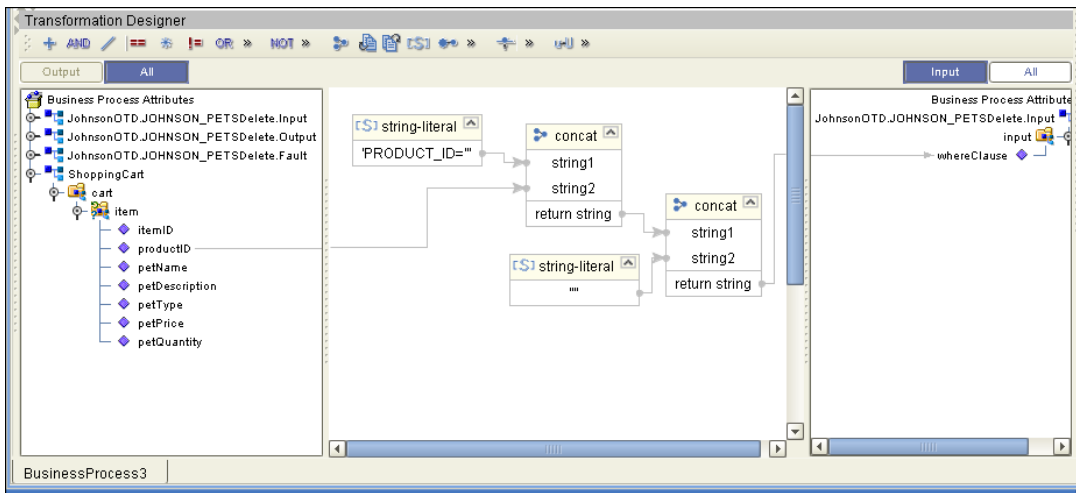

The figure below shows the output of the Delete operation, which is a status indicating the number of rows deleted.

Figure 41 Delete Output

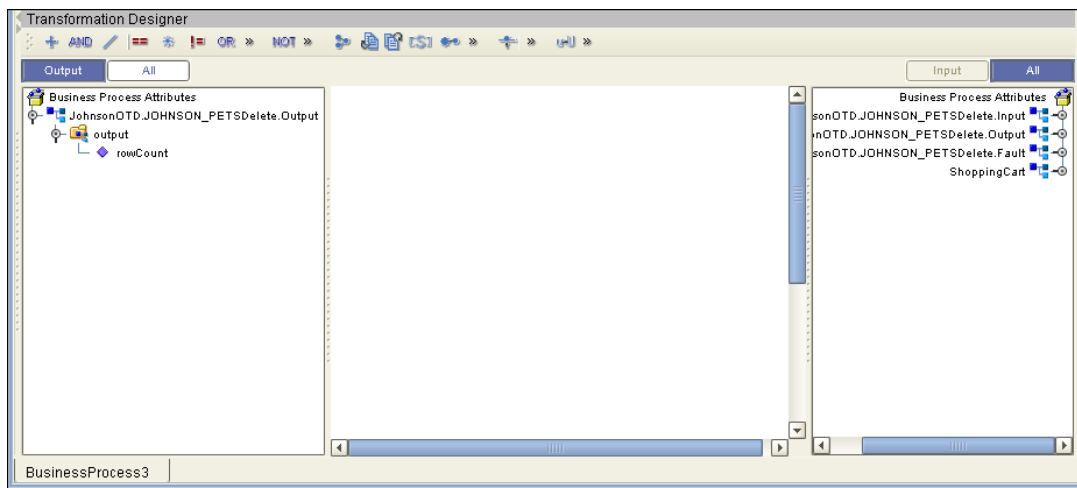

6.3 Using the Sample Project in eGate

To import the sample project **Syb_JCE_Sample.zip** follow the instructions given in [Importing the Sample Project](#) on page 31.

6.3.1. Working with the Sample Project in eGate

This sample project selects the EMP_NO, LAST_NAME, FIRST_NAME, RATE, LAST_UPDATE, RATE and the columns from the table db_employee and publishes the record to an output file.

The data used for this projects is within a table called db_employees. The table contains the following columns:

Table 2 Sample project data

Column Name	Mapping	Data Type	Data Length
EMP_NO	employee_no	integer	10
LAST_NAME	employee_lname	varchar	30
FIRST_NAME	employee_fname	varchar	30
LAST_UPDATE	update_date	timestamp	16
RATE	rate	float	53

The sample project consists of an input file containing data that is passed into a collaboration and out to the database from which data is retrieved and passed back into the collaboration and then to an output file.

Note: Outbound database eWays are available when using a JCE Collaboration. To poll the database, you must use the Scheduler.

Figure 42 Database project flow

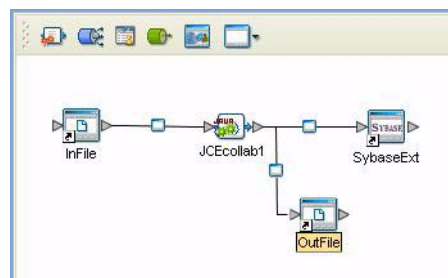

To work with the sample project, follow the instructions given in the *eGate Tutorial*.

6.3.2. Configuring the eWays

The sample uses an inbound and an outbound File eWay as well as an outbound eWay. To configure the sample projects eWays, use the following information. For additional information on the eWay properties, see [Setting the eWay Properties in the Connectivity Map](#) on page 10.

To configure the Inbound File eWay:

- 1 On the Connectivity Map canvas, double click the eWay icon located between the InFile and Service1 (JCECollab1).
- 2 On the resulting **Templates** window, select **Inbound File eWay** and click **OK**.
- 3 On the **Properties** window, enter the appropriate configurations for the Inbound File eWay. See the *File eWay User's Guide* for information on how to specifically configure the File eWay. For this sample, the default settings are used.
- 4 When you have completed your selections, click **OK**.

To configure the Outbound SybaseExt eWay:

- 1 On the Connectivity Map canvas, double click the eWay icon located between the **Service1 (JCECollab1)** and **SybaseExt** database.
- 2 On the resulting **Templates** window, select **Outbound SybaseExt** and click **OK**.
- 3 On the Properties window, enter the appropriate configurations for the Outbound Sybase eWay and click **OK**. See [Setting the Properties in the Outbound eWay](#) on page 10. For this sample, the default settings are used.
- 4 When you have completed your selections, click **OK**.

To configure the Outbound File eWay:

- 1 On the Connectivity Map canvas, double click the eWay icon located between **Service1 (JCECollab1)** and **OutFile** eWay.
- 2 On the resulting **Templates** window, select **Outbound File eWay** and click **OK**.
- 3 On the **Properties** window, enter the appropriate configurations for the Outbound File eWay. See the *File eWay User's Guide* for information on how to specifically configure the File eWay. For this sample, change the Directory field to **<valid path to the directory where the output file will be stored>**. The Output File Name to **Output1.dat**. For the remaining parameters, the default settings are used.
- 4 When you have completed your selections, click **OK**.

6.3.3. Creating the Environmnet Profile

To review the components of the Sample project, there is an Inbound and an Outbound File eWay, an eWay, and a Service.

To create the external environment for the Sample project:

- 5 On the Environment Explorer, highlight and right-click the eWay profile. Select **Properties**. Enter the configuration information required for your Outbound eWay. See [Setting the Properties in the Outbound eWay Environment](#) on page 15.

6.3.4 Deploying a Project

To deploy a project, please see the *"eGate Integrators User's Guide"*.

6.3.5. Running the Sample

For instruction on how to run the Sample project, see the *eGate Tutorial*.

Once the process has completed, the Output file in the target directory configured in the Outbound File eWay will contain all records retrieved from the database in an .xml format.

6.4 Common DataType Conversions

Figure 43 The Sybase eWay Datatype Conversions

Sybase Server Data Type	OTD/Java Data Type	Methods to Use	Sample Data
BigInt	Long	Long: java.lang.Long.parseLong(String)	123
Int	Int	Integer: java.lang.Integer.parseInt(String)	123
tinyInt	Byte	Byte: java.lang.Byte.parseByte(String)	123
SmallInt	Short	Short: java.lang.Short.parseShort(String)	123
Number	BigDecimal	Call a NewConstructor BigDecimal: java.math.BigDecimal(String)	145.78
Decimal	BigDecimal	Call a NewConstructor BigDecimal: java.math.BigDecimal(String)	145.78
Bit	Boolean	Boolean: java.lang.Boolean.getBoolean(String)	true or false
Real	Float	Float: java.lang.Float.parseFloat(String)	3468.494
Float	Double	Double: java.lang.Double.parseDouble(String)	3468.494
Money	BigDecimal	Call a NewConstructor BigDecimal: java.math.BigDecimal(String)	2456.95
Smallmoney	BigDecimal	Call a NewConstructor BigDecimal: java.math.BigDecimal(String)	2456.95
Smalldatetime	TimeStamp	TimeStamp: java.sql.TimeStamp.valueOf(String)	2003-09-28 11:35:00
Timestamp	Binary	N/A (Used by the Database Internally)	N/A
DateTime	TimeStamp	Date: java.sql.TimeStamp.valueOf(String)	2003-09-28 11:35:42
Varchar	String	Direct Assign	Any Characters

Sybase Server Data Type	OTD/Java Data Type	Methods to Use	Sample Data
Char	String	Direct Assign	Any Characters
Text	String	Direct Assign	Any Characters
Binary(1)	Byte[]	String: java.lang.String.getBytes()	0 or 1

6.5 Using OTDs with Tables, Views, and Stored Procedures

Tables, Views, and Stored Procedures are manipulated through OTDs. Common operations include insert, delete, update, and query.

6.5.1 The Table

A table OTD represents a database table. It consists of fields and methods. Fields correspond to the columns of a table while methods are the operations that you can apply to the OTD. This allows you to perform query, update, insert, and delete SQL operations in a table.

By default, the Table OTD has `UpdatableConcurrency` and `ScrollTypeForwardOnly`. The type of result returned by the `select()` method can be specified using:

- `SetConcurrencytoUpdatable`
- `SetConcurrencytoReadOnly`
- `SetScrollTypetoForwardOnly`
- `SetScrollTypetoScrollSensitive`
- `SetScrollTypetoInsensitive`

The methods should be called before executing the `select()` method. For example,

```
getDBEmp().setConcurToUpdatable();
getDBEmp().setScroll_TypeToScrollSensitive();
getDBEmp().getDB_EMPLOYEE().select("");
```

The Query Operation

To perform a query operation on a table

- 1 Execute the `select()` method with the “**where**” clause specified if necessary.
- 2 Loop through the `ResultSet` using the `next()` method.
- 3 Process the return record within a `while()` loop.

For example:

```
package SelectSales;
```

```
public class Select
{
    public com.stc.codegen.logger.Logger logger;

    public com.stc.codegen.alerter.Alerter alerter;

    public void receive(
com.stc.connector.appconn.file.FileTextMessage
input,com.stc.connector.appconn.file.FileApplication
FileClient_1,db_employee.Db_employeeOTD
db_employee_1,employeeDb.Db_employee employeeDb_db_employee_1 )
    throws Throwable
    {
        //@map:Db_employee.select(Text)
        db_employee_1.getDb_employee().select( input.getText() );

        //while
        while (db_employee_1.getDb_employee().next()) {
            //@map:Copy EMP_NO to Employee_no
            employeeDb_db_employee_1.setEmployee_no(
java.lang.Integer.toString(
db_employee_1.getDb_employee().getEMP_NO() ) );

            //@map:Copy LAST_NAME to Employee_lname
            employeeDb_db_employee_1.setEmployee_lname(
db_employee_1.getDb_employee().getLAST_NAME() );

            //@map:Copy FIRST_NAME to Employee_fname
            employeeDb_db_employee_1.setEmployee_fname(
db_employee_1.getDb_employee().getFIRST_NAME() );

            //@map:Copy RATE to Rate
            employeeDb_db_employee_1.setRate(
java.lang.Double.toString(
db_employee_1.getDb_employee().getRATE() ) );

            //@map:Copy LAST_UPDATE to Update_date
            employeeDb_db_employee_1.setUpdate_date(
db_employee_1.getDb_employee().getLAST_UPDATE().toString() );
        }

        //@map:Copy employeeDb_db_employee_1.marshallToString to
Text
        FileClient_1.setText(
employeeDb_db_employee_1.marshallToString() );

        //@map:FileClient_1.write
        FileClient_1.write();
    }
}
```

The Insert Operation

To perform an insert operation on a table

- 1 Execute the **insert()** method. Assign a field.
- 2 Insert the row by calling **insertRow()**

This example inserts an employee record.

```

//DB_EMPLOYEE.insert
    Table_OTD_1.getDB_EMPLOYEE().insert();

//Copy EMP_NO to EMP_NO
    insert_DB_1.getInsert_new_employee().setEmployee_no(
        java.lang.Integer.parseInt(
            employeedb_with_top_db_employee_1.getEmployee_no() ) );

//@map:Copy Employee_lname to Employee_Lname
    insert_DB_1.getInsert_new_employee().setEmployee_Lname(
        employeedb_with_top_db_employee_1.getEmployee_lname() );

//@map:Copy Employee_fname to Employee_Fname
    insert_DB_1.getInsert_new_employee().setEmployee_Fname(
        employeedb_with_top_db_employee_1.getEmployee_fname() );

//@map:Copy java.lang.Float.parseFloat(Rate) to Rate
    insert_DB_1.getInsert_new_employee().setRate(
        java.lang.Float.parseFloat(
            employeedb_with_top_db_employee_1.getRate() ) );

//@map:Copy java.sql.Timestamp.valueOf(Update_date) to Update_date
    insert_DB_1.getInsert_new_employee().setUpdate_date(
        java.sql.Timestamp.valueOf(
            employeedb_with_top_db_employee_1.getUpdate_date() ) );

//@map:Insert Row
    Table_OTD_1.getDB_EMPLOYEE().insertRow();

//Table_OTD_1.commit
    Table_OTD_1.commit();
}

```

The Update Operation

To perform an update operation on a table

- 1 Execute the **update()** method.
- 2 Using a while loop together with **next()**, move to the row that you want to update.
- 3 Assign updating value(s) to the fields of the table OTD
- 4 Update the row by calling **updateRow()**.

```

//SalesOrders_with_top_SalesOrders_1.unmarshalFromString(Text)
    SalesOrders_with_top_SalesOrders_1.unmarshalFromString(
        input.getText() );

//SALES_ORDERS.update("SO_num =99")
    DB_sales_orders_1.getSALES_ORDERS().update( "SO_num ='01'" );

//while
    while (DB_sales_orders_1.getSALES_ORDERS().next() ) {

//Copy SalesOrderNum to SO_num
    DB_sales_orders_1.getSALES_ORDERS().setSO_num(
        SalesOrders_with_top_SalesOrders_1.getSalesOrderNum() );

//Copy CustomerName to Cust_name
    DB_sales_orders_1.getSALES_ORDERS().setCust_name(
        SalesOrders_with_top_SalesOrders_1.getCustomerName() );
}

```



```
//Copy CustomerPhone to Cust_phone
DB_sales_orders_1.getSALES_ORDERS().setCust_phone(
SalesOrders_with_top_SalesOrders_1.getCustomerPhone() );

//SALES_ORDERS.updateRow
DB_sales_orders_1.getSALES_ORDERS().updateRow();
}
//DB_sales_orders_1.commit
DB_sales_orders_1.commit();
}
```

The Delete Operation

To perform a delete operation on a table

- 1 Execute the **delete()** method.
- 2 Move to the row that you want to delete.
- 3 Delete the row by calling **deleteRow()**.

In this example DELETE an employee.

```
//DB_EMPLOYEE.delete("EMP_NO = '".concat(EMP_NO).concat("'"))
Table_OTD_1.getDB_EMPLOYEE().delete( "EMP_NO = '".concat(
employeeDb_with_top_db_employee_1.getEMP_NO() ).concat( "' " ) );

//DB_EMPLOYEE.commit
DB_EMPLOYEE.commit();
}
```

6.5.2 The Stored Procedure

A Stored Procedure OTD represents a database stored procedure. Fields correspond to the arguments of a stored procedure while methods are the operations that you can apply to the OTD. It allows you to execute a stored procedure. Remember that while in the Collaboration Editor you can drag and drop nodes from the OTD into the Collaboration Editor.

Executing Stored Procedures

The OTD represents the Stored Procedure “LookUpGlobal” with two parameters, an inbound parameter (INLOCALID) and an outbound parameter (OUTGLOBALPRODUCTID). These inbound and outbound parameters are generated by the DataBase Wizard and are represented in the resulting OTD as nodes. Within the Transformation Designer, you can drag values from the input parameters, execute the call, collect data, and drag the values to the output parameters.

Below are the steps for executing the Stored Procedure:

- 1 Specify the input values.
- 2 Execute the Stored Procedure.
- 3 Retrieve the output parameters if any.

For example:

```

package Storedprocedure;

public class sp_jce
{
    public com.stc.codegen.logger.Logger logger;

    public com.stc.codegen.alerter.Alerter alerter;

    public void receive(
com.stc.connector.appconn.file.FileTextMessage
input,com.stc.connector.appconn.file.FileApplication
FileClient_1,employeedb.Db_employee
employeedb_with_top_db_employee_1,insert_DB.Insert_DBOTD insert_DB_1
)
    throws Throwable
    {
        //
        @map:employeedb_with_top_db_employee_1.unmarshalFromString(Text)
            employeedb_with_top_db_employee_1.unmarshalFromString(
input.getText() );

        //@map:Copy java.lang.Integer.parseInt(Employee_no) to
Employee_no
            insert_DB_1.getInsert_new_employee().setEmployee_no(
java.lang.Integer.parseInt(
employeedb_with_top_db_employee_1.getEmployee_no() ) );

        //@map:Copy Employee_lname to Employee_Lname
            insert_DB_1.getInsert_new_employee().setEmployee_Lname(
employeedb_with_top_db_employee_1.getEmployee_lname() );

        //@map:Copy Employee_fname to Employee_Fname
            insert_DB_1.getInsert_new_employee().setEmployee_Fname(
employeedb_with_top_db_employee_1.getEmployee_fname() );

        //@map:Copy java.lang.Float.parseFloat(Rate) to Rate
            insert_DB_1.getInsert_new_employee().setRate(
java.lang.Float.parseFloat(
employeedb_with_top_db_employee_1.getRate() ) );

        //@map:Copy java.sql.Timestamp.valueOf(Update_date) to
Update_date
            insert_DB_1.getInsert_new_employee().setUpdate_date(
java.sql.Timestamp.valueOf(
employeedb_with_top_db_employee_1.getUpdate_date() ) );

        //@map:Insert_new_employee.execute
            insert_DB_1.getInsert_new_employee().execute();

        //@map:insert_DB_1.commit
            insert_DB_1.commit();

        //@map:Copy "procedure executed" to Text
            FileClient_1.setText( "procedure executed" );

        //@map:FileClient_1.write
            FileClient_1.write();
    }
}

```

6.6 Alerting and Logging

eGate provides an alerting and logging feature. This allows monitoring of messages and captures any adverse messages in order of severity based on configured severity level and higher. To enable Logging, please see the *eGate Integrator User's Guide*.

Index

A

Add Prepared Statements 26

C

ClassName 11
 Configuring eWay Connections 10
 Connect to Database 21

D

Database Wizard 20
 DatabaseName 15, 18
 DataSourceName 15
 Delimiter 16
 Description 11, 16
 driver class, JDBC 11
 DriverProperties 16

E

eWay properties 10

H

host system requirements 7

I

Inbound Environment Properties
 Database 18
 Password 18
 PortNumber 19
 ServerName 19
 User 19
 Inbound Properties
 Pollmilliseconds 14
 PreparedStatement 14
 InitialPoolSize 12

J

JDBC
 driver class 11

L

LoginTimeOut 12

M

MaxIdleTime 12
 MaxPoolSize 12
 MaxStatements 12
 MinPoolSize 13

N

NetworkProtocol 13

O

Outbound Environment Properties
 DatabaseName 15
 DataSourceName 15
 Delimiter 16
 Description 16
 DriverProperties 16
 Password 16
 PortNumber 17
 ServerName 17
 User 17
 Outbound Properties
 ClassName 11
 Description 11
 InitialPoolSize 12
 LoginTimeOut 12
 MaxIdleTime 12
 MaxPoolSize 12
 MaxStatements 12
 MinPoolSize 13
 NetworkProtocol 13
 PropertyCycle 13
 RoleName 13

P

Password 16, 18
 Pollmilliseconds 14
 PortNumber 17, 19
 PreparedStatement 14
 Properties of the eWay
 creating 10
 Property settings, Inbound
 Pollmilliseconds 14
 PreparedStatement 14
 Property settings, Inbound Environment
 Database 18
 Password 18

Index

- PortNumber 19
- ServerName 19
- User 19
- Property settings, Outbound
 - ClassName 11
 - Description 11
 - InitialPoolSize 12
 - LoginTimeOut 12
 - MaxIdleTime 12
 - MaxPoolSize 12
 - MaxStatements 12
 - MinPoolSize 13
 - NetworkProtocol 13
 - PropertyCycle 13
 - RoleName 13
- Property settings, Outbound Environment
 - DatabaseName 15
 - DataSourceName 15
 - Delimiter 16
 - Description 16
 - DriverProperties 16
 - Password 16
 - PortNumber 17
 - ServerName 17
 - User 17
- PropertyCycle 13

R

- requirements
 - host system 7
- RoleName 13

S

- Select Database Objects 22
- Select Procedures 25
- Select Table/Views 22
- Select Wizard Type 20
- ServerName 17, 19
- Setting 10
- SQL Server eWay Database Wizard 20

U

- User 17, 19