



# Sun Fire™ V440 Server Administration Guide

---

Sun Microsystems, Inc.  
4150 Network Circle  
Santa Clara, CA 95054 U.S.A.  
650-960-1300

Part No. 816-7728-10  
July 2003, [Revision A](#)

Submit comments about this document at: <http://www.sun.com/hwdocs/feedback>

Copyright 2003 Sun Microsystems, Inc., 4150 Network Circle, Santa Clara, California 95054, U.S.A. All rights reserved.

Sun Microsystems, Inc. has intellectual property rights relating to technology that is described in this document. In particular, and without limitation, these intellectual property rights may include one or more of the U.S. patents listed at <http://www.sun.com/patents> and one or more additional patents or pending patent applications in the U.S. and in other countries.

This document and the product to which it pertains are distributed under licenses restricting their use, copying, distribution, and decompilation. No part of the product or of this document may be reproduced in any form by any means without prior written authorization of Sun and its licensors, if any.

Third-party software, including font technology, is copyrighted and licensed from Sun suppliers.

Parts of the product may be derived from Berkeley BSD systems, licensed from the University of California. UNIX is a registered trademark in the U.S. and in other countries, exclusively licensed through X/Open Company, Ltd.

Sun, Sun Microsystems, the Sun logo, Sun Fire, Solaris, VIS, Sun StorEdge, Solstice DiskSuite, Java, SunVTS and the Solaris logo are trademarks or registered trademarks of Sun Microsystems, Inc. in the U.S. and in other countries.

All SPARC trademarks are used under license and are trademarks or registered trademarks of SPARC International, Inc. in the U.S. and in other countries. Products bearing SPARC trademarks are based upon an architecture developed by Sun Microsystems, Inc.

The OPEN LOOK and Sun™ Graphical User Interface was developed by Sun Microsystems, Inc. for its users and licensees. Sun acknowledges the pioneering efforts of Xerox in researching and developing the concept of visual or graphical user interfaces for the computer industry. Sun holds a non-exclusive license from Xerox to the Xerox Graphical User Interface, which license also covers Sun's licensees who implement OPEN LOOK GUIs and otherwise comply with Sun's written license agreements.

U.S. Government Rights—Commercial use. Government users are subject to the Sun Microsystems, Inc. standard license agreement and applicable provisions of the FAR and its supplements.

DOCUMENTATION IS PROVIDED "AS IS" AND ALL EXPRESS OR IMPLIED CONDITIONS, REPRESENTATIONS AND WARRANTIES, INCLUDING ANY IMPLIED WARRANTY OF MERCHANTABILITY, FITNESS FOR A PARTICULAR PURPOSE OR NON-INFRINGEMENT, ARE DISCLAIMED, EXCEPT TO THE EXTENT THAT SUCH DISCLAIMERS ARE HELD TO BE LEGALLY INVALID.

---

Copyright 2003 Sun Microsystems, Inc., 4150 Network Circle, Santa Clara, California 95054, Etats-Unis. Tous droits réservés.

Sun Microsystems, Inc. a les droits de propriété intellectuelle relatants à la technologie qui est décrit dans ce document. En particulier, et sans la limitation, ces droits de propriété intellectuelle peuvent inclure un ou plus des brevets américains énumérés à <http://www.sun.com/patents> et un ou les brevets plus supplémentaires ou les applications de brevet en attente dans les Etats-Unis et dans les autres pays.

Ce produit ou document est protégé par un copyright et distribué avec des licences qui en restreignent l'utilisation, la copie, la distribution, et la décompilation. Aucune partie de ce produit ou document ne peut être reproduite sous aucune forme, par quelque moyen que ce soit, sans l'autorisation préalable et écrite de Sun et de ses bailleurs de licence, s'il y en a.

Le logiciel détenu par des tiers, et qui comprend la technologie relative aux polices de caractères, est protégé par un copyright et licencié par des fournisseurs de Sun.

Des parties de ce produit pourront être dérivées des systèmes Berkeley BSD licenciés par l'Université de Californie. UNIX est une marque déposée aux Etats-Unis et dans d'autres pays et licenciée exclusivement par X/Open Company, Ltd.

Sun, Sun Microsystems, le logo Sun, Sun Fire, Solaris, VIS, Sun StorEdge, Solstice DiskSuite, Java, SunVTS et le logo Solaris sont des marques de fabrique ou des marques déposées de Sun Microsystems, Inc. aux Etats-Unis et dans d'autres pays.

Toutes les marques SPARC sont utilisées sous licence et sont des marques de fabrique ou des marques déposées de SPARC International, Inc. aux Etats-Unis et dans d'autres pays. Les produits portant les marques SPARC sont basés sur une architecture développée par Sun Microsystems, Inc.

L'interface d'utilisation graphique OPEN LOOK et Sun™ a été développée par Sun Microsystems, Inc. pour ses utilisateurs et licenciés. Sun reconnaît les efforts de pionniers de Xerox pour la recherche et le développement du concept des interfaces d'utilisation visuelle ou graphique pour l'industrie de l'informatique. Sun détient une licence non exclusive de Xerox sur l'interface d'utilisation graphique Xerox, cette licence couvrant également les licenciées de Sun qui mettent en place l'interface d'utilisation graphique OPEN LOOK et qui en outre se conforment aux licences écrites de Sun.

LA DOCUMENTATION EST FOURNIE "EN L'ÉTAT" ET TOUTES AUTRES CONDITIONS, DECLARATIONS ET GARANTIES EXPRESSES OU TACITES SONT FORMELLEMENT EXCLUES, DANS LA MESURE AUTORISEE PAR LA LOI APPLICABLE, Y COMPRIS NOTAMMENT TOUTE GARANTIE IMPLICITE RELATIVE A LA QUALITE MARCHANDE, A L'APTITUDE A UNE UTILISATION PARTICULIERE OU A L'ABSENCE DE CONTREFAÇON.

# Contents

---

**Preface** xvii

**1. System Overview** 1

About the Sun Fire V440 Server 1

CPUs and Memory 2

On-board Storage 2

PCI Subsystem 2

External Ports 3

Power Supplies 4

New Features 4

ALOM System Controller Card 4

Serial Management Port 5

Network Management Port 5

System Configuration Card 6

Hardware Disk Mirroring 6

Locating Front Panel Features 7

Security Lock 7

LED Status Indicators 8

Power Button 11

System Control Keyswitch	12
System Configuration Card Reader	14
Locating Back Panel Features	15
About Reliability, Availability, and Serviceability Features	16
Hot-Pluggable Components	17
1+1 Power Supply Redundancy	17
ALOM System Controller	18
Environmental Monitoring and Control	19
Automatic System Recovery	20
Sun StorEdge Traffic Manager	21
Hardware Watchdog Mechanism and XIR	21
Support for RAID Storage Configurations	22
Error Correction and Parity Checking	22
About Sun Cluster Software	22
About Sun Management Center Software	23
<b>2. Powering On and Powering Off the System</b>	<b>25</b>
How to Power On the System	25
How to Power On the System Remotely	29
How to Power Off the System	30
How to Power Off the System Remotely	33
How to Initiate a Reconfiguration Boot	34
How to Select a Boot Device	37
<b>3. Configuring the System Console</b>	<b>41</b>
About Communicating With the System	42
What the System Console Does	43
Using the System Console	43
About the <code>sc&gt;</code> Prompt	48

Access Through Multiple Controller Sessions	49
Ways of Reaching the <code>sc&gt;</code> Prompt	49
About the <code>ok</code> Prompt	49
Ways of Reaching the <code>ok</code> Prompt	50
Important: Accessing the <code>ok</code> Prompt Suspends the Solaris Operating Environment	53
For More Information	53
About Switching Between the ALOM System Controller and the System Console	53
How to Get to the <code>ok</code> Prompt	55
How to Use the Serial Management Port	56
How to Activate the Network Management Port	58
How to Access the System Console via a Terminal Server	59
How to Access the System Console via <code>tip</code> Connection	63
How to Modify the <code>/etc/remote</code> File	66
How to Access the System Console via an Alphanumeric Terminal	68
How to Verify Serial Port Settings on <code>ttyb</code>	70
How to Access the System Console via a Local Graphics Monitor	71
Reference for System Console OpenBoot Configuration Variable Settings	76
<b>4. Configuring Hardware</b>	<b>77</b>
About the CPU/Memory Modules	78
About the Memory Modules	78
Memory Interleaving	80
Independent Memory Subsystems	80
Configuration Rules	81
About the ALOM System Controller Card	81
Configuration Rules	84
About the PCI Cards and Buses	85

Configuration Rules	86
About the Ultra-4 SCSI Controller	87
About the System Configuration Card	87
How to Migrate a System Configuration Card From One System to Another System	88
About the Ultra-4 SCSI Backplane	89
Configuration Rules	90
About Hot-Pluggable Components	90
Disk Drives	90
Power Supplies	91
About Internal Disk Drives	91
Configuration Rules	93
About the Power Supplies	93
Configuration Rule	95
How to Perform a Power Supply Hot-Plug Operation	95
About the System Fans	97
Configuration Rule	98
About the Serial Ports	99
About the Ultra-4 SCSI Port	99
About the USB Ports	100
Configuration Rules	100
<b>5. Managing RAS Features and System Firmware</b>	<b>101</b>
About the ALOM System Controller Command Prompt	102
How to Log In to the ALOM System Controller	102
About the scadm Utility	104
How to View Environmental Information	105
How to Control the Locator LED	106
About Performing OpenBoot Emergency Procedures	107

OpenBoot Emergency Procedures for Systems With Non-USB Keyboards	108
OpenBoot Emergency Procedures for Systems With USB Keyboards	108
About Automatic System Recovery	110
Auto-Boot Options	110
Error Handling Summary	111
Reset Scenarios	112
Automatic System Recovery User Commands	113
How to Enable Automatic System Recovery	113
How to Disable Automatic System Recovery	114
How to Obtain Automatic System Recovery Information	115
How to Unconfigure a Device Manually	116
How to Reconfigure a Device Manually	118
How to Enable the Hardware Watchdog Mechanism and Its Options	119
About Multipathing Software	120
For More Information	121
<b>6. Managing Disk Volumes</b>	<b>123</b>
About Disk Volumes	123
About Volume Management Software	124
VERITAS Dynamic Multipathing	124
Sun StorEdge Traffic Manager	125
For More Information	125
About RAID Technology	126
Disk Concatenation	126
RAID 0: Disk Striping	127
RAID 1: Disk Mirroring	127
RAID 5: Disk Striping With Parity	128
Hot-Spares	128

About Hardware Disk Mirroring	128
Reference for Physical Disk Slot Numbers, Physical Device Names, and Logical Device Names	129
How to Create a Hardware Disk Mirror	130
How to Delete a Hardware Disk Mirror	132
How to Perform a Mirrored Disk Hot-Plug Operation	133
How to Perform a Non-Mirrored Disk Hot-Plug Operation	136
<b>7. Managing Network Interfaces</b>	<b>141</b>
About the Network Interfaces	141
About Redundant Network Interfaces	142
How to Attach a Twisted-Pair Ethernet Cable	143
How to Configure the Primary Network Interface	144
How to Configure Additional Network Interfaces	146
<b>A. Connector Pinouts</b>	<b>151</b>
Reference for the Serial Port Connector	152
Reference for the USB Connectors	153
Reference for the Gigabit Ethernet Connectors	154
Reference for the Network Management Connector	155
Reference for the Serial Management Connector	156
Reference for the Ultra-4 SCSI Connector	157
<b>B. System Specifications</b>	<b>159</b>
Reference for Physical Specifications	160
Reference for Electrical Specifications	160
Reference for Environmental Specifications	161
Reference for Agency Compliance Specifications	162
Reference for Clearance and Service Access Specifications	162



**C. OpenBoot Configuration Variables 163**

**Index 167**



# Figures

---

- FIGURE 1-1 Front Panel Features 7
- FIGURE 1-2 Front Panel System Status LEDs 8
- FIGURE 1-3 Four-Position System Control Keyswitch 12
- FIGURE 1-4 Back Panel Features 15
- FIGURE 3-1 Directing the System Console to Different Ports and Different Devices 44
- FIGURE 3-2 Serial Management Port (Default Console Connection) 45
- FIGURE 3-3 Alternative Console Ports (Require Additional Configuration) 46
- FIGURE 3-4 Separate System Console and System Controller “Channels” 54
- FIGURE 3-5 Patch Panel Connection Between a Terminal Server and a Sun Fire V440 Server 60
- FIGURE 3-6 *tip* Connection Between a Sun Fire V440 Server and Another Sun System 63
- FIGURE 4-1 Memory Module Groups 0 and 1 79
- FIGURE 4-2 ALOM System Controller Card 82
- FIGURE 4-3 ALOM System Controller Card Ports 83
- FIGURE 4-4 PCI Slots 86
- FIGURE 4-5 Internal Drive Bay Locations 92
- FIGURE 4-6 Power Supply Locations 93
- FIGURE 4-7 Fan Tray 0 and Fan Tray 1 98



# Tables

---

TABLE 1-1	System Status LEDs	9
TABLE 1-2	Power Supply LEDs	10
TABLE 1-3	Hard Disk Drive LEDs	10
TABLE 1-4	System Control Keypad Settings	13
TABLE 1-5	Ethernet LEDs	16
TABLE 1-6	Sun Management Center Features	24
TABLE 3-1	Ways of Communicating With the System	42
TABLE 3-2	Ways of Accessing the <code>ok</code> Prompt	56
TABLE 3-3	Pin Crossovers for Connecting to a Typical Terminal Server	61
TABLE 3-4	OpenBoot Configuration Variables That Affect the System Console	76
TABLE 4-1	Memory Module Groups 0 and 1	79
TABLE 4-2	PCI Bus Characteristics, Associated Bridge Chips, Motherboard Devices, and PCI Slots	85
TABLE 5-1	Stop Key Command Functions for Systems With Standard (Non-USB) Keyboards	108
TABLE 6-1	Disk Slot Numbers, Logical Device Names, and Physical Device Names	129
TABLE C-1	OpenBoot Configuration Variables Stored on the System Configuration Card	163



# Preface

---

The *Sun Fire V440 Server Administration Guide* is written for experienced system administrators. It includes general descriptive information about the Sun Fire™ V440 server and detailed instructions for configuring and administering the server. To use the information in this manual, you must have working knowledge of computer network concepts and terms, and advanced familiarity with the Solaris™ operating environment.

---

## How This Book Is Organized

The *Sun Fire V440 Server Administration Guide* is divided into the following chapters:

- Chapter 1 presents an illustrated overview of the system and a description of the system's reliability, availability, and serviceability (RAS) features, as well as new features introduced with this server.
- Chapter 2 describes how to power on and power off the system, and how to initiate a reconfiguration boot.
- Chapter 3 describes the system console and how to access it.
- Chapter 4 describes and illustrates system hardware components. It also includes configuration information for CPU/memory modules and dual inline memory modules (DIMMs).
- Chapter 5 describes the tools used to configure system firmware, including Sun™ Advanced Lights Out Manager (ALOM) system controller environmental monitoring, automatic system recovery (ASR), hardware watchdog mechanism, and multipathing software. In addition, it describes how to unconfigure and reconfigure a device manually.
- Chapter 6 describes how to manage internal disk volumes and devices.
- Chapter 7 provides instructions for configuring network interfaces.

This manual also includes the following reference appendixes:

- Appendix A details connector pinouts.
- Appendix B provides tables of various system specifications.
- Appendix C provides a list of all OpenBoot configuration variables, and a short description of each.

---

## Using UNIX Commands

This document might not contain information about basic UNIX® commands and procedures such as shutting down the system, booting the system, and configuring devices.

See one or more of the following for this information:

- *Solaris Handbook for Sun Peripherals*
- AnswerBook2™ online documentation for the Solaris operating environment
- Other software documentation that you received with your system

---

## Typographic Conventions

Typeface*	Meaning	Examples
AaBbCc123	The names of commands, files, and directories; on-screen computer output	Edit your <code>.login</code> file. Use <code>ls -a</code> to list all files. % You have mail.
<b>AaBbCc123</b>	What you type, when contrasted with on-screen computer output	% <b>su</b> Password:
<i>AaBbCc123</i>	Book titles, new words or terms, words to be emphasized	Read Chapter 6 in the <i>User's Guide</i> . These are called <i>class</i> options. You <i>must</i> be superuser to do this.
<code>AaBbCc123</code>	Command-line variable; replace with a real name or value	To delete a file, type <code>rm filename</code> .

---

\* The settings on your browser might differ from these settings.



---

# System Prompts

Type of Prompt	Prompt
C shell	<i>machine-name%</i>
C shell superuser	<i>machine-name#</i>
Bourne shell and Korn shell	\$
Bourne shell and Korn shell superuser	#
ALOM system controller	sc>
OpenBoot firmware	ok
OpenBoot Diagnostics	obdiag>

---

# Related Documentation

Application	Title	Part Number	On Sun Fire V440 Server Documentation CD
Late-breaking product information	<i>Sun Fire V440 Server Product Notes</i>	816-7733	✓
Cabling and power-on overview	<i>Sun Fire V440 Server Setup: Cabling and Power On</i>	816-7734	
System installation, including rack installation and cabling	<i>Sun Fire V440 Server Installation Guide</i>	816-7727	✓
Parts installation and removal	<i>Sun Fire V440 Server Parts Installation and Removal Guide</i>	816-7729	✓
Diagnostics and troubleshooting	<i>Sun Fire V440 Server Diagnostics and Troubleshooting Guide</i>	816-7730	✓

---

<b>Application</b>	<b>Title</b>	<b>Part Number</b>	<b>On Sun Fire V440 Server Documentation CD</b>
Two-post rackmounting	<i>Sun Fire V440 Server 2-Post Rackmounting Guide</i>	817-0952	✓
Sun Advanced Lights Out Manager (ALOM) system controller	<i>Sun Advanced Lights Out Manager (ALOM) 1.1 Online Help</i>	817-1960	✓
Solaris operating environment installation and platform-specific utilities	<i>Solaris 8 Sun Hardware Platform Guide</i>	817-1550	

---

---

## Accessing Sun Documentation

You can view, print, or purchase a broad selection of Sun documentation, including localized versions, at:

<http://www.sun.com/documentation>

---

**Note** – For important safety, compliance, and conformity information regarding the Sun Fire V440 server, see the *Sun Fire V440 Server Safety and Compliance Guide*, part number 816-7731, on the Documentation CD or online at the above location.

---

---

## Contacting Sun Technical Support

If you have technical questions about this product that are not answered in this document, go to:

<http://www.sun.com/service/contacting>

---

# Sun Welcomes Your Comments

Sun is interested in improving its documentation and welcomes your comments and suggestions. You can submit your comments by going to:

<http://www.sun.com/hwdocs/feedback>

Please include the title and part number of your document with your feedback:

*Sun Fire V440 Server Administration Guide*, part number 816-7728-10



## System Overview

---

This chapter introduces you to the Sun Fire™ V440 server and describes its features.

This chapter contains the following sections:

- “About the Sun Fire V440 Server” on page 1
- “New Features” on page 4
- “Locating Front Panel Features” on page 7
- “Locating Back Panel Features” on page 15
- “About Reliability, Availability, and Serviceability Features” on page 16
- “About Sun Cluster Software” on page 22
- “About Sun Management Center Software” on page 23

---

## About the Sun Fire V440 Server

The Sun Fire V440 server is a high-performance, shared memory, symmetric multiprocessing server that supports up to four UltraSPARC™ IIIi processors. The UltraSPARC IIIi processor implements the SPARC™ V9 Instruction Set Architecture (ISA) and the Visual Instruction Set extensions (Sun VIS™ software) that accelerate multimedia, networking, encryption, and Java™ software processing.

The system, which is mountable in a 4-post or 2-post rack, measures 7 inches high (4 rack units - RU), 17.6 inches wide, and (without its plastic bezel) 24 inches deep (22.225 cm x 44.7 cm x 60.96 cm). The system weighs approximately 75 lb (34.02 kg).

System reliability, availability, and serviceability (RAS) are enhanced by features that include hot-pluggable disk drives and redundant, hot-pluggable power supplies. A full list of RAS features is in the section, “About Reliability, Availability, and Serviceability Features” on page 16.

## CPUs and Memory

Processing power is provided by up to four CPU/memory modules. Each module incorporates one UltraSPARC III processor, and slots for up to four double data rate (DDR) dual inline memory modules (DIMMs).

System main memory is provided by up to 16 DDR synchronous dynamic random access memory DIMMs. The system supports 512-Mbyte and 1-Gbyte DIMMs. Total system memory is shared by all CPUs in the system and ranges from a minimum of 2 Gbytes (one CPU/memory module with four 512-Mbyte DIMMs) to a maximum of 16 Gbytes (four modules fully populated with 1-Gbyte DIMMs). For more information about system memory, see “About the Memory Modules” on page 78.

## On-board Storage

Internal disk storage is provided by up to four 1-inch (2.54-cm) high, hot-pluggable, Small Computer System Interface (SCSI) disk drives. The basic system includes an Ultra-4 SCSI disk backplane that accommodates four 36-Gbyte or 73-Gbyte disks capable of data transfer rates of up to 320 megabytes per second. The system also supports external mass-storage devices, with an external SCSI port located on the system’s back panel. Internal and external SCSI devices are on independent buses, providing better performance for both buses. See “About Internal Disk Drives” on page 91 and “Locating Back Panel Features” on page 15.

External multidisk storage subsystems and redundant array of independent disks (RAID) storage arrays can be supported by installing peripheral component interconnect (PCI) host adapter cards along with the appropriate system software. Software drivers supporting SCSI and other types of devices are included in the Solaris operating environment. In addition, the system supports internal hardware mirroring (RAID 1) using the on-board Ultra-4 SCSI controller. See “About RAID Technology” on page 126.

## PCI Subsystem

System I/O is handled by four separate Peripheral Component Interconnect (PCI) buses. These industry-standard buses support all of the system’s on-board I/O controllers in addition to six slots for PCI interface cards. Three of the PCI slots

operate at a 33-MHz clock rate, and three slots operate at a clock rate of either 33 MHz or 66 MHz. All slots comply with PCI Local Bus Specification Revision 2.2. For additional details, see “About the PCI Cards and Buses” on page 85.

## External Ports

The system provides two on-board Gigabit Ethernet ports, which support several modes of operations at 10, 100, and 1000 megabits per second (Mbps). Additional Ethernet interfaces or connections to other network types can be provided by installing the appropriate PCI interface cards. Multiple network interfaces can be combined with Solaris Internet Protocol (IP) network multipathing software to provide hardware redundancy and failover capability, as well as load balancing on outbound traffic. Should one of the interfaces fail, the software can automatically switch all network traffic to an alternate interface to maintain network availability. For more information about network connections, see “How to Configure the Primary Network Interface” on page 144 and “How to Configure Additional Network Interfaces” on page 146.

In addition to the two on-board Gigabit Ethernet ports, there is a 10BASE-T network management port (labeled NET MGT) on the system back panel of the Sun Advanced Lights Out Manager (ALOM) system controller card. This port is reserved for use with the ALOM system controller and the system console.

The Sun Fire V440 server provides two serial communication ports: One port is a general-purpose DB-9 connector (labeled `ttyb`) on the system back panel. The other port is an RJ-45 connector (labeled SERIAL MGT) on the back panel of the ALOM system controller card, and is reserved for use with the ALOM system controller and the system console. For more information, see “About the Serial Ports” on page 99.

The back panel also provides four Universal Serial Bus (USB) ports for connecting USB peripheral devices such as modems, printers, scanners, digital cameras, or a Sun Type-6 USB keyboard and mouse. The USB ports are USB 1.1 compliant, and support both synchronous mode and asynchronous mode. The ports enable data transmission at speeds of 1.5 Mbps and 12 Mbps. For additional details, see “About the USB Ports” on page 100.

The system console device can be either a standard alphanumeric terminal, terminal server, `tip` connection from another Sun system, or a local graphics monitor. The default connection is through the serial management port (labeled SERIAL MGT) on the back of the ALOM system controller card. You can also connect an alphanumeric terminal to the serial (DB-9) connector (as `ttyb`) on the system back panel. A local graphics monitor requires installation of a PCI graphics card, monitor, USB keyboard, and mouse. You can also access the system console through a network connection via the network management port. See “New Features” on page 4 for more information about the ALOM system controller card and its ports, and Chapter 3 for more information about configuring the system console.

# Power Supplies

The basic system includes two 680-watt power supplies, each with its own cooling fan. The power supplies are plugged in directly to the motherboard. One power supply provides sufficient power for a maximally configured system, though two power supplies must be present at all times to ensure proper system cooling.

The second power supply provides “1+1” redundancy, enabling the system to continue operating should either power supply fail. (If one power supply has failed, it must remain in the system to maintain system cooling until a replacement power supply is available.) A power supply in a redundant configuration is hot-pluggable, so that you can remove and replace a faulty power supply without shutting down the operating system or turning off the system power. For more information about the power supplies, see “About the Power Supplies” on page 93.

---

## New Features

The Sun Fire V440 server provides several new features. These features include the following:

- Sun Advanced Lights Out Manager (ALOM) system controller card
- Dedicated serial management port
- Dedicated network management port
- System configuration card
- Hardware disk mirroring capability

These features are described briefly in the following sections. More in-depth information about these features is presented elsewhere in this book.

## ALOM System Controller Card

The Sun Advanced Lights Out Manager (ALOM) system controller card enables system management and administration for the Sun Fire V440 server over a serial line or an Ethernet network. ALOM system controller provides remote system administration for geographically distributed or physically inaccessible systems. The firmware installed on the ALOM system controller card enables you to monitor the system, without having to install any supporting software.



The ALOM system controller card runs independently of the host system, and operates off of standby power from the system's power supplies. This allows the ALOM system controller to serve as a *lights out* management tool that continues to function even when the server operating system goes offline or when the server is powered off.

For more information about the ALOM system controller card, see the following sections:

- “About Reliability, Availability, and Serviceability Features” on page 16
- “About the ALOM System Controller Card” on page 81
- “About the ALOM System Controller Command Prompt” on page 102
- “How to Log In to the ALOM System Controller” on page 102
- “About the `scadm` Utility” on page 104

## Serial Management Port

The serial management port (SERIAL MGT) enables you to set up a system console device, without requiring you to configure an existing port. All power-on self-test (POST) and ALOM system controller messages are directed to the serial management port by default.

For more information about the serial management port, see the following sections:

- “Locating Back Panel Features” on page 15
- “About Communicating With the System” on page 42
- “How to Use the Serial Management Port” on page 56

## Network Management Port

The network management port (NET MGT) provides you with direct network access to the ALOM system controller card and its firmware, as well as access to the system console, power-on self-test (POST) output messages, and ALOM system controller messages. You can use the network management port to perform remote administration, including externally initiated resets (XIR).

For more information about the network management port, see the following sections:

- “Locating Back Panel Features” on page 15
- “About Communicating With the System” on page 42

## System Configuration Card

The system configuration card (SCC) stores system configuration variables and Ethernet MAC addresses on a removable plastic card, reducing replacement, service, and configuration time.

For more information about the SCC, see the following sections:

- “Locating Front Panel Features” on page 7
- “About the System Configuration Card” on page 87
- “How to Migrate a System Configuration Card From One System to Another System” on page 88

## Hardware Disk Mirroring

The on-board Ultra-4 SCSI controller provides internal hardware disk mirroring (RAID 1) capabilities between two internal disk drives, resulting in higher disk drive performance, reliability, and fault recovery.

For more information about hardware mirroring, see the following sections:

- “About the Ultra-4 SCSI Controller” on page 87
- “About RAID Technology” on page 126
- “How to Create a Hardware Disk Mirror” on page 130
- “How to Delete a Hardware Disk Mirror” on page 132
- “How to Perform a Mirrored Disk Hot-Plug Operation” on page 133

---

# Locating Front Panel Features

The illustration below shows the system features that you can access from the front panel. In the illustration, the system doors are removed.

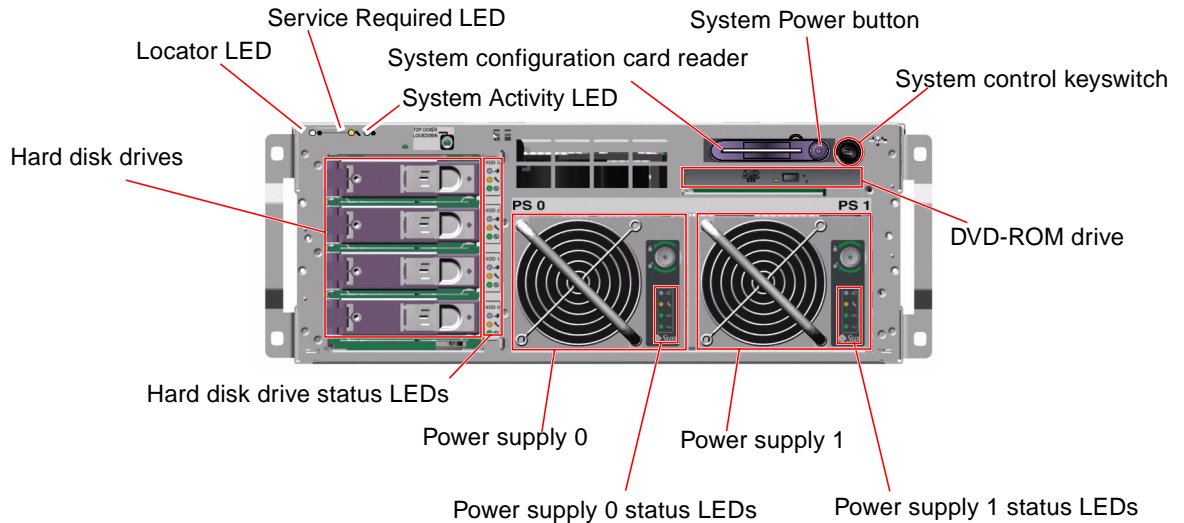

**FIGURE 1-1** Front Panel Features

For information about front panel controls and indicators, see “LED Status Indicators” on page 8. Also see the *Sun Fire V440 Server Parts Installation and Removal Guide* for more detailed information about servicing individual components.

## Security Lock

A front panel security lock secures the system doors and the top cover. The system doors can be locked with one of the three keys supplied with the system. The system doors can also be locked with the supplied mini-key remaining in the system control keyswitch.

# LED Status Indicators

Several LED status indicators on both the front and back panels provide general system status, alert you to system problems, and help you to determine the location of system faults.

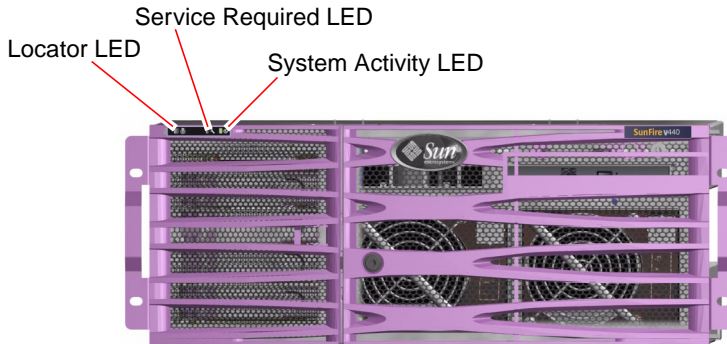

**FIGURE 1-2** Front Panel System Status LEDs

At the top left of the system as you look at its front are three general system status LEDs. Two of these LEDs, the system *Service Required* LED and the *System Activity* LED, provide a snapshot of the overall system status. A third LED, the *Locator* LED, helps you to locate a specific system quickly, even though it might be one of numerous systems in a room. The Locator LED is lit either by a Solaris command from the administrator, or by using the ALOM system controller shell command tool. For instructions, see “How to Control the Locator LED” on page 106.

Locator, Service Required, and System Activity LEDs are also found at the upper-left corner of the back panel. Also located on the back panel are LEDs for the system’s two power supplies and RJ-45 Ethernet ports.



The system Service Required LEDs work in conjunction with specific fault LEDs. For example, a power supply fault illuminates the associated power supply Service Required LED, as well as the system Service Required LED. Fault LEDs remain lit for any fault condition that results in a system shutdown.

See FIGURE 1-1, FIGURE 1-2, and FIGURE 1-4 for locations of the front panel and back panel LEDs.

The following tables list and describe the LEDs on the front panel: system status LEDs, power supply LEDs, and hard disk drive LEDs.





Listed from left to right, the system status LEDs operate as described in the following table.

**TABLE 1-1** System Status LEDs

Name	Icon	Description
Locator		This white LED is lit by Solaris command, by Sun Management Center software, or by Sun Advanced Lights Out Manager (ALOM) system controller software, to locate a system. See “How to Control the Locator LED” on page 106.
Service Required		<p>This amber LED lights when system hardware or software has detected a system fault. This LED lights for any faults or failures detected in the following areas:</p> <ul style="list-style-type: none"><li>• Motherboard</li><li>• CPU/memory module</li><li>• DIMM</li><li>• Hard disk drive</li><li>• PCI fan tray</li><li>• CPU blower assembly</li><li>• Power supply</li></ul> <p>In addition to the system Service Required LED, other fault LEDs might also be lit, depending on the nature of the fault. If the system Service Required LED is lit, check the status of other fault LEDs on the front panel to determine the nature of the fault. See the <i>Sun Fire V440 Server Diagnostics and Troubleshooting Guide</i> for more information.</p>
System Activity		This green LED lights when the ALOM system controller detects that the Solaris operating environment is running.



The following table describes the power supply LEDs.

**TABLE 1-2** Power Supply LEDs

Name	Icon	Description
OK-to-Remove		This blue LED lights when it is safe to remove and replace the power supply from the system. This LED is lit by ALOM command and only lights when the other power supply is functioning correctly.
Service Required		This amber LED lights when the system detects a fault in the monitored power supply. Note that the Service Required LEDs on the front and back panels also light when this occurs.
Power OK		This green LED lights when the power supply is on and outputting regulated DC power within specified limits.
Standby Available		This green LED lights when a proper AC voltage source is input to the power supply.

The following table describes the hard disk drive LEDs.

**TABLE 1-3** Hard Disk Drive LEDs

Name	Icon	Description
OK-to-Remove		This blue LED lights when the hard disk drive has been taken offline and is safe to remove from the system.
Service Required		Reserved for future use.
Activity		This green LED lights when the system is powered on and a disk is present in the monitored drive slot. This LED flashes slowly during the disk drive hot-plug procedure. It flashes rapidly when the disk is spinning up or down, or during read/write activity.

Further details about the diagnostic use of LEDs are discussed in the *Sun Fire V440 Server Diagnostics and Troubleshooting Guide*.

## Power Button

The system Power button is recessed to prevent accidentally turning the system on or off. The ability of the Power button to turn the system on or off is controlled by the system control keyswitch. The ALOM system controller can also control the power-on and power-off functions if environmental conditions are out of specification or if the ALOM system controller detects that the system configuration card (SCC) is missing or invalid. See the section, “System Control Keyswitch” on page 12.

If the operating system is running, pressing and releasing the Power button initiates a graceful software system shutdown. Pressing and holding in the Power button for four seconds causes an immediate hardware shutdown.



---

**Caution** – When possible, use the graceful shutdown method. Forcing an immediate hardware shutdown can cause disk drive corruption and loss of data.

---

# System Control Keyswitch

The four-position system control keyswitch on the front panel controls the power-on modes of the system. The system control keyswitch also prevents unauthorized users from powering off the system or reprogramming system firmware. In the following illustration, the system control keyswitch is in the Locked position.

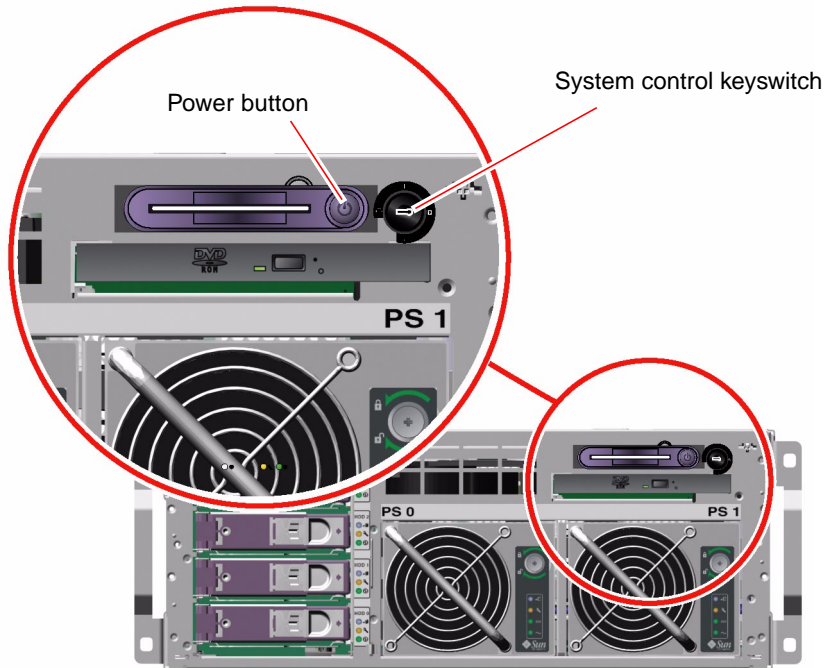

**FIGURE 1-3** Four-Position System Control Keyswitch

---





**Note** – If you use the mini-key, you can leave it in the system control keyswitch. However, you can secure the system only by locking the system doors with the longer main key and then removing it.

---



The following table describes the function of each system control keyswitch setting.

**TABLE 1-4** System Control Keyswitch Settings

Position	Icon	Description
Standby		<p>This setting forces the system to power off immediately and to enter standby mode. It also disables the system Power button. This setting is useful when AC/DC power is interrupted and you do not want the system to restart automatically when power is restored. With the system control keyswitch in any other position, if the system were running prior to losing power and the power state memory is enabled in the ALOM system controller, the system restarts automatically once power is restored.</p> <p>The Standby setting also prevents anyone from restarting the system during an ALOM system controller session. However, the ALOM system controller card continues to operate using the system's standby power. See:</p> <ul style="list-style-type: none"><li>• "How to Power On the System Remotely" on page 29</li><li>• "How to Power Off the System Remotely" on page 33</li></ul>
Normal		<p>This setting enables the system Power button, allowing you to power the system on or off. If the operating system is running, pressing and releasing the Power button initiates a graceful software system shutdown. Pressing and holding the Power button in for four seconds causes an immediate hardware power off.</p>
Locked		<p>This setting disables the system Power button to prevent unauthorized users from powering the system on or off. It also disables the keyboard L1-A (Stop-A) command, terminal Break key command, and ~# tip window command, preventing users from suspending system operation to access the system ok prompt. The Locked setting is recommended for normal day-to-day operations, and prevents unauthorized programming by write-protecting system firmware.</p> <p>The ALOM system controller can still affect the system power state via a password-secured ALOM session, even when the system control keyswitch is in the Locked position. This capability provides remote management of the system.</p>
Diagnostics		<p>This setting forces the power-on self-test (POST) and OpenBoot Diagnostics software to run firmware diagnostic tests at power on or during reset events. The Power button functions the same as when the system control keyswitch is in the Normal position.</p>

# System Configuration Card Reader

The system configuration card (SCC) reader contains the system configuration card. This plastic card stores the system's host ID, Ethernet MAC addresses for all on-board Ethernet devices, OpenBoot™ configuration variables, and ALOM system controller user and system configuration data. The card performs the same functions that were performed by the NVRAM module in previous Sun systems, along with enhanced system controller support. Using the SCC, you can transfer this configuration data from one system to another.



---

**Caution** – The system configuration card must be installed and in place at all times while the system is running. If you remove the SCC while the system is running, the system will power off within 30 seconds. In addition, if the system is in standby mode and the SCC is missing, the ALOM system controller prevents the system from being powered on.

---

For more information about the SCC, see:

- “About the System Configuration Card” on page 87
- “How to Migrate a System Configuration Card From One System to Another System” on page 88

---

# Locating Back Panel Features

The following illustration shows the system features that you can access from the back panel.

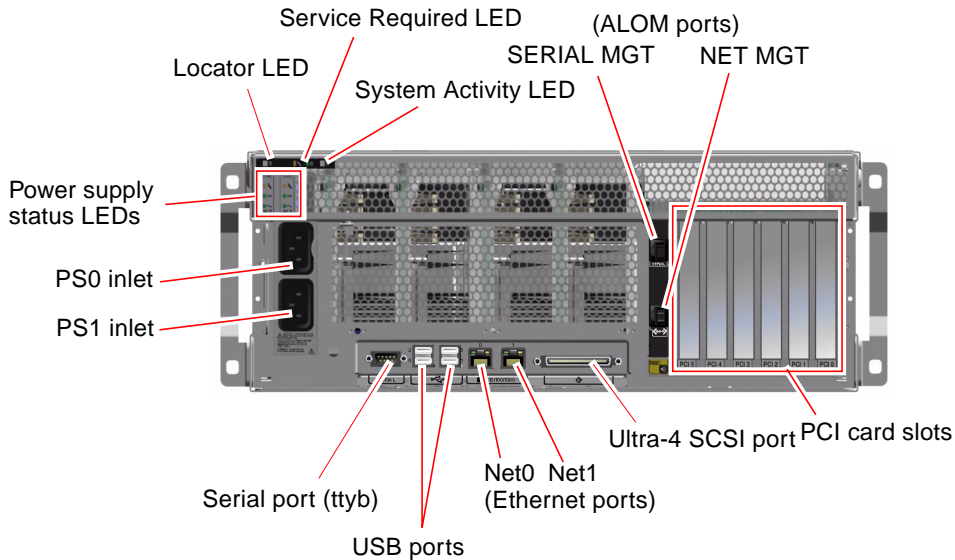

**FIGURE 1-4** Back Panel Features

The back panel includes these features:

- System status LEDs
- Inlets for both AC power supplies
- Six PCI card slots
- Eight external data ports, including the following:
  - One DB-9 serial port (ttyb)
  - Four USB ports
  - Two Gigabit Ethernet ports
  - One Ultra-4 SCSI port
- Serial management port (labeled SERIAL MGT), located on the back of the ALOM system controller card
- 10BASE-T network management port (labeled NET MGT), located on the back of the ALOM system controller card

System status LEDs—Locator, Service Required, and System Activity—are repeated on the back panel. In addition, the back panel includes four LEDs for each power supply and two LEDs for each on-board Ethernet interface. The network management port on the ALOM system controller has an Ethernet Link/Activity LED. See TABLE 1-1 and TABLE 1-2 for descriptions of the system status and power supply LEDs.

TABLE 1-5 lists and describes the Ethernet LEDs (from left to right) on the system back panel.

**TABLE 1-5** Ethernet LEDs

Name	Description
Link/Activity	This green LED lights when a link is established at the particular port with its link partner, and blinks to indicate activity.
Speed	This amber LED lights when a Gigabit Ethernet connection is established, and is off when a 10/100-Mbps Ethernet connection is established.

Details of the diagnostic use of LEDs are discussed in the *Sun Fire V440 Server Diagnostics and Troubleshooting Guide*.

---

## About Reliability, Availability, and Serviceability Features

Reliability, availability, and serviceability (RAS) are aspects of a system's design that affect its ability to operate continuously and to minimize the time necessary to service the system. Reliability refers to a system's ability to operate continuously without failures and to maintain data integrity. System availability refers to the ability of a system to recover to an operational state after a failure, with minimal impact. Serviceability relates to the time it takes to restore a system to service following a system failure. Together, reliability, availability, and serviceability features provide for near continuous system operation.

To deliver high levels of reliability, availability, and serviceability, the Sun Fire V440 server offers the following features:

- Hot-pluggable disk drives
- Redundant, hot-pluggable power supplies
- Sun Advanced Lights Out Manager (ALOM) system controller
- Environmental monitoring and fault protection

- Automatic system recovery (ASR) capabilities for PCI cards and system memory
- Hardware watchdog mechanism and externally initiated reset (XIR) capability
- Internal hardware disk mirroring (RAID 1)
- Support for disk and network multipathing with automatic failover
- Error correction and parity checking for improved data integrity
- Easy access to all internal replaceable components
- Full in-rack serviceability for nearly all components

For more information about using RAS features, see Chapter 5.

## Hot-Pluggable Components

Sun Fire V440 hardware is designed to support hot-plugging of internal disk drives and power supplies. By using the proper software commands, you can install or remove these components while the system is running. Hot-plug technology significantly increases the system's serviceability and availability, by providing you with the ability to do the following:

- Increase storage capacity dynamically to handle larger work loads and to improve system performance
- Replace disk drives and power supplies without service disruption

For additional information about the system's hot-pluggable components, see "About Hot-Pluggable Components" on page 90.

## 1+1 Power Supply Redundancy

The system features two hot-pluggable power supplies, either of which is capable of handling the system's entire load. Thus, the two power supplies provide "1+1" redundancy, enabling the system to continue operating should one of the power supplies or its AC power source fail.

---

**Note** – Two power supplies must be present at all times to ensure proper system cooling. Even if one power supply has failed, its fans obtain power from the other power supply and through the motherboard to maintain proper system cooling.

---

For more information about power supplies, redundancy, and configuration rules, see "About the Power Supplies" on page 93. For instructions on performing a power supply hot-plug operation, see "How to Perform a Power Supply Hot-Plug Operation" on page 95.

# ALOM System Controller

Sun Advanced Lights Out Manager (ALOM) system controller is a secure server management tool that comes preinstalled on the Sun Fire V440 server, in the form of a module with preinstalled firmware. It lets you monitor and control your server over a serial line or over a network. The ALOM system controller provides remote system administration for geographically distributed or physically inaccessible systems. You can connect to the ALOM system controller card using a local alphanumeric terminal, a terminal server, or a modem connected to its serial management port, or over a network using its 10BASE-T network management port.

When you first power on the system, the ALOM system controller card provides a default connection to the system console through its serial management port. After initial setup, you can assign an IP address to the network management port and connect the network management port to a network. You can run diagnostic tests, view diagnostic and error messages, reboot your server, and display environmental status information using the ALOM system controller software. Even if the operating system is down or the system is powered off, the ALOM system controller can send an email alert about hardware failures, or other important events that can occur on the server.

The ALOM system controller provides the following features:

- Default system console connection through its serial management port to an alphanumeric terminal, terminal server, or modem
- Network management port for remote monitoring and control over a network, after initial setup
- Remote system monitoring and error reporting, including diagnostic output
- Remote reboot, power-on, power-off, and reset functions
- Ability to monitor system environmental conditions remotely
- Ability to run diagnostic tests using a remote connection
- Ability to remotely capture and store boot and run logs, which you can review or replay later
- Remote event notification for overtemperature conditions, power supply faults, system shutdown, or system resets
- Remote access to detailed event logs

For more details about the ALOM system controller hardware, see “About the ALOM System Controller Card” on page 81.

For information about configuring and using the ALOM system controller, see the following:

- “About the ALOM System Controller Command Prompt” on page 102
- “How to Log In to the ALOM System Controller” on page 102
- “About the `scadm` Utility” on page 104

- *Sun Advanced Lights Out Manager (ALOM) Online Help*, which is on your Sun Fire V440 Server Documentation CD

---

**Note** – The Sun Fire V440 Server Documentation CD contains a compiled, interactive online help application for the Sun Advanced Lights Out Manager (ALOM) system controller.

---

## Environmental Monitoring and Control

The Sun Fire V440 server features an environmental monitoring subsystem designed to protect the server and its components against:

- Extreme temperatures
- Lack of adequate airflow through the system
- Operating with missing or misconfigured components
- Power supply failures
- Internal hardware faults

Monitoring and control capabilities are handled by the ALOM system controller firmware. This ensures that monitoring capabilities remain operational even if the system has halted or is unable to boot, and without requiring the system to dedicate CPU and memory resources to monitor itself. If the ALOM system controller fails, the operating system reports the failure and takes over limited environmental monitoring and control functions.

The environmental monitoring subsystem uses an industry-standard I<sup>2</sup>C bus. The I<sup>2</sup>C bus is a simple two-wire serial bus used throughout the system to allow the monitoring and control of temperature sensors, fans, power supplies, status LEDs, and the front panel system control keyswitch.

Temperature sensors are located throughout the system to monitor the ambient temperature of the system, the CPUs, and the CPU die temperature. The monitoring subsystem polls each sensor and uses the sampled temperatures to report and respond to any overtemperature or undertemperature conditions. Additional I<sup>2</sup>C sensors detect component presence and component faults.

The hardware and software together ensure that the temperatures within the enclosure do not exceed predetermined “safe operation” ranges. If the temperature observed by a sensor falls below a low-temperature warning threshold or rises above a high-temperature warning threshold, the monitoring subsystem software lights the system Service Required LEDs on the front and back panels. If the temperature condition persists and reaches a critical threshold, the system initiates a graceful system shutdown. In the event of a failure of the ALOM system controller, backup sensors are used to protect the system from serious damage, by initiating a forced hardware shutdown.

All error and warning messages are sent to the system console and logged in the `/var/adm/messages` file. Service Required LEDs remain lit after an automatic system shutdown to aid in problem diagnosis.

The monitoring subsystem is also designed to detect fan failures. The system features integral power supply fans, as well as two fan trays comprising one fan and two blowers. If any fan or blower fails, the monitoring subsystem detects the failure and generates an error message to the system console, logs the message in the `/var/adm/messages` file, and lights the Service Required LEDs.

The power subsystem is monitored in a similar fashion. Polling the power supply status periodically, the monitoring subsystem indicates the status of each supply's DC outputs, AC inputs, and presence.

---

**Note** – Two power supplies must be present at all times to ensure proper system cooling. Even if one power supply has failed, its fans obtain power from the other power supply and through the motherboard to maintain proper system cooling.

---

If a power supply problem is detected, an error message is sent to the system console and logged in the `/var/adm/messages` file. Additionally, LEDs located on each power supply light to indicate failures. The system Service Required LED lights to indicate a system fault. The ALOM system controller console alerts record power supply failures.

## Automatic System Recovery

The system provides automatic system recovery (ASR) from component failures in memory modules and PCI cards.

The ASR features enable the system to resume operation after experiencing certain nonfatal hardware faults or failures. Automatic self-test features enable the system to detect failed hardware components. An auto-configuring capability designed into the system's boot firmware enables the system to unconfigure failed components and to restore system operation. As long as the system can operate without the failed component, the ASR features enable the system to reboot automatically, without operator intervention.

During the power-on sequence, if a faulty component is detected, the component is marked as failed and, if the system can function, the boot sequence continues. In a running system, some types of failures can bring down the system. If this happens, the ASR functionality enables the system to reboot immediately if it is possible for the system to detect the failed component and operate without it. This prevents a faulty hardware component from keeping the entire system down or causing the system to crash repeatedly.



---

**Note** – ASR functionality is not enabled until you activate it. Control over the system ASR functionality is provided by several OpenBoot commands and configuration variables. For additional details, see “About Automatic System Recovery” on page 110.

---

## Sun StorEdge Traffic Manager

Sun StorEdge Traffic Manager, a feature found in the Solaris 8 and later operating environments, is a native multipathing solution for storage devices such as Sun StorEdge™ disk arrays. Sun StorEdge Traffic Manager provides the following features:

- Host-level multipathing
- Physical host controller interface (pHCI) support
- Sun StorEdge T3, Sun StorEdge 3510, and Sun StorEdge A5x00 support
- Load balancing

For more information, see “Sun StorEdge Traffic Manager” on page 125. Also consult your Solaris software documentation.

## Hardware Watchdog Mechanism and XIR

To detect and respond to a system hang, should one ever occur, the Sun Fire V440 server features a hardware “watchdog” mechanism, which is a hardware timer that is continually reset as long as the operating system is running. In the event of a system hang, the operating system is no longer able to reset the timer. The timer will then expire and cause an automatic externally initiated reset (XIR), eliminating the need for operator intervention. When the hardware watchdog mechanism issues the XIR, debug information is displayed on the system console. The hardware watchdog mechanism is present by default, but it requires some additional setup in the Solaris operating environment.

The XIR feature is also available for you to invoke manually at the ALOM system controller prompt. You use the ALOM system controller `reset -x` command manually when the system is unresponsive and an L1-A (Stop-A) keyboard command or alphanumeric terminal Break key does not work. When you issue the `reset -x` command manually, the system is immediately returned to the OpenBoot `ok` prompt. From there, you can use OpenBoot commands to debug the system.

For more information, see the following:

- “How to Enable the Hardware Watchdog Mechanism and Its Options” on page 119

## Support for RAID Storage Configurations

By attaching one or more external storage devices to the Sun Fire V440 server, you can use a redundant array of independent disks (RAID) software application such as Solstice DiskSuite™ or VERITAS Volume Manager to configure system disk storage in a variety of different RAID levels. Configuration options include RAID 0 (striping), RAID 1 (mirroring), RAID 0+1 (striping plus mirroring), RAID 1+0 (mirroring plus striping), and RAID 5 (striping with interleaved parity). You choose the appropriate RAID configuration based on the price, performance, reliability, and availability goals for your system. You can also configure one or more disk drives to serve as “hot spares” to fill in automatically in the event of a disk drive failure.

In addition to software RAID configurations, you can set up a hardware RAID 1 (mirroring) configuration for any pair of internal disk drives using the on-board Ultra-4 SCSI controller, providing a high-performance solution for disk drive mirroring.

For more information, see the following:

- “About Volume Management Software” on page 124
- “About RAID Technology” on page 126
- “How to Create a Hardware Disk Mirror” on page 130

## Error Correction and Parity Checking

DIMMs employ error-correcting code (ECC) to ensure high levels of data integrity. The system reports and logs correctable ECC errors. (A correctable ECC error is any single-bit error in a 128-bit field.) Such errors are corrected as soon as they are detected. The ECC implementation can also detect double-bit errors in the same 128-bit field and multiple-bit errors in the same nibble (4 bits). In addition to providing ECC protection for data, parity protection is also used on the PCI and UltraSCSI buses, and in the UltraSPARC IIIi CPU internal caches.

---

## About Sun Cluster Software

Sun Cluster software lets you connect up to eight Sun servers in a cluster configuration. A *cluster* is a group of nodes that are interconnected to work as a single, highly available and scalable system. A *node* is a single instance of Solaris

software. The software can be running on a standalone server or on a domain within a standalone server. With Sun Cluster software, you can add or remove nodes while online, and mix and match servers to meet your specific needs.

Sun Cluster software delivers high availability through automatic fault detection and recovery, and scalability, ensuring that mission-critical applications and services are always available when needed.

With Sun Cluster software installed, other nodes in the cluster will automatically take over and assume the workload when a node goes down. The software delivers predictability and fast recovery capabilities through features such as local application restart, individual application failover, and local network adapter failover. Sun Cluster software significantly reduces downtime and increases productivity by helping to ensure continuous service to all users.

The software lets you run both standard and parallel applications on the same cluster. It supports the dynamic addition or removal of nodes, and enables Sun servers and storage products to be clustered together in a variety of configurations. Existing resources are used more efficiently, resulting in additional cost savings.

Sun Cluster software allows nodes to be separated by up to 10 kilometers. This way, in the event of a disaster in one location, all mission-critical data and services remain available from the other unaffected locations.

For more information, see the documentation supplied with the Sun Cluster software.

---

## About Sun Management Center Software

Sun Management Center software is an open, extensible system monitoring and management tool. The software uses Java software protocol and Simple Network Management Protocol (SNMP) to provide enterprise-wide monitoring of Sun servers and workstations, including their subsystems, components, and peripheral devices.

Sun Management Center software extends and enhances the management capability of Sun's hardware and software products.

**TABLE 1-6** Sun Management Center Features

<b>Feature</b>	<b>Description</b>
System management	Monitors and manages the system at the hardware and operating system levels. Monitored hardware includes boards, tapes, power supplies, and disks.
Operating system management	Monitors and manages operating system parameters including load, resource usage, disk space, and network statistics.
Application and business system management	Provides technology to monitor business applications such as trading systems, accounting systems, inventory systems, and real-time control systems.
Scalability	Provides an open, scalable, and flexible solution to configure and manage multiple management administrative domains (consisting of many systems) spanning an enterprise. The software can be configured and used in a centralized or distributed fashion by multiple users.

Sun Management Center software is geared primarily toward system administrators who have large data centers to monitor or other installations that have many computer platforms to monitor. If you administer a more modest installation, you need to weigh Sun Management Center software's benefits against the requirement of maintaining a significant database (typically over 700 Mbytes) of system status information.

The servers being monitored must be up and running if you want to use Sun Management Center, since this tool relies on the Solaris operating environment. For instructions on using this tool to monitor a Sun Fire V440 server, see the *Sun Fire V440 Server Diagnostics and Troubleshooting Guide*. For more detailed information about the product, see the *Sun Management Center Software User's Guide*.

For the latest information about this product, go to the Sun Management Center Web site:

<http://www.sun.com/sunmanagementcenter>

# Powering On and Powering Off the System

---

This chapter describes how to power on and power off the system, and how to initiate a reconfiguration boot.

This chapter explains the following tasks:

- “How to Power On the System” on page 25
- “How to Power On the System Remotely” on page 29
- “How to Power Off the System” on page 30
- “How to Power Off the System Remotely” on page 33
- “How to Initiate a Reconfiguration Boot” on page 34
- “How to Select a Boot Device” on page 37

---

## How to Power On the System

### Before You Begin

Do not use this power-on procedure if you have just added any new internal option or external storage device, or if you have removed a storage device without replacing it. To power on the system under those circumstances, you must initiate a reconfiguration boot. For those instructions, see:

- “How to Initiate a Reconfiguration Boot” on page 34



---

**Caution** – Never move the system when the system power is on. Movement can cause catastrophic disk drive failure. Always power off the system before moving it.

---



---

**Caution** – Before you power on the system, make sure that the system doors and all panels are properly installed.

---

## What to Do

### 1. Turn on power to any external peripherals and storage devices.

Read the documentation supplied with the device for specific instructions.

### 2. Establish a connection to the system console.

If you are powering on the system for the first time, connect a device to the serial management port using one of the methods described in Chapter 3. Otherwise, use one of the methods for connecting to the system console, also described in Chapter 3.

### 3. Connect the AC power cords.

---

**Note** – As soon as the AC power cords are connected to the system, the ALOM system controller boots and displays its power-on self-test (POST) messages. Though the system power is still off, the ALOM system controller is up and running, and monitoring the system. Regardless of system power state, as long as the power cords are connected and providing standby power, the ALOM system controller is on and monitoring the system.

---

### 4. Unlock and open the right-side system door.

Insert the system key into the lock and rotate the key counterclockwise.

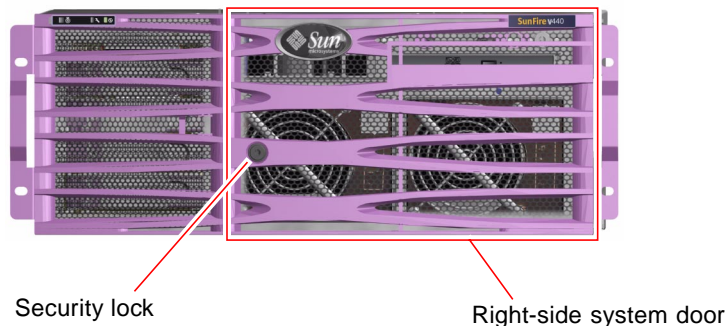

**5. Insert the system key into the system control keyswitch and turn the keyswitch to the Normal or Diagnostics position.**

See “System Control Keyswitch” on page 12 for information about each system control keyswitch setting.

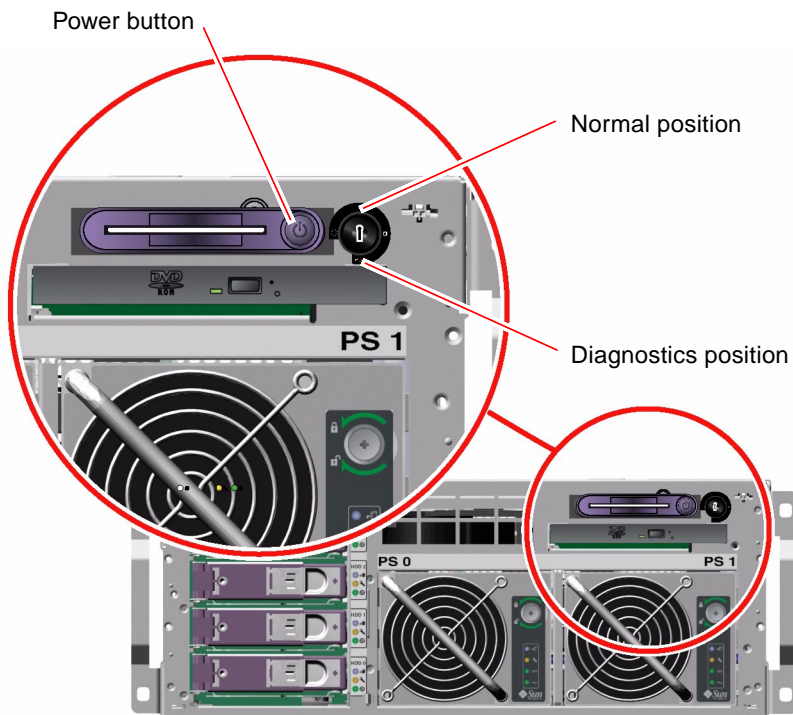

**6. Press and release the Power button to power on the system.**

The power supply Power OK LEDs light when power is applied to the system. Verbose POST output is immediately displayed to the system console if diagnostics are enabled at power-on, and the system console is directed to the serial and network management ports.

The system can take anywhere from 30 seconds to 20 minutes before text messages appear on the system monitor (if one is attached) or the system prompt appears on an attached terminal. This time depends on the system configuration (number of CPUs, memory modules, PCI cards, and console configuration) and the level of power-on self-test (POST) and OpenBoot Diagnostics tests being performed. The System Activity LED lights when the server is running under control of the Solaris operating system.

**7. Turn the system control keyswitch to the Locked position.**

This prevents anyone from accidentally powering off the system.

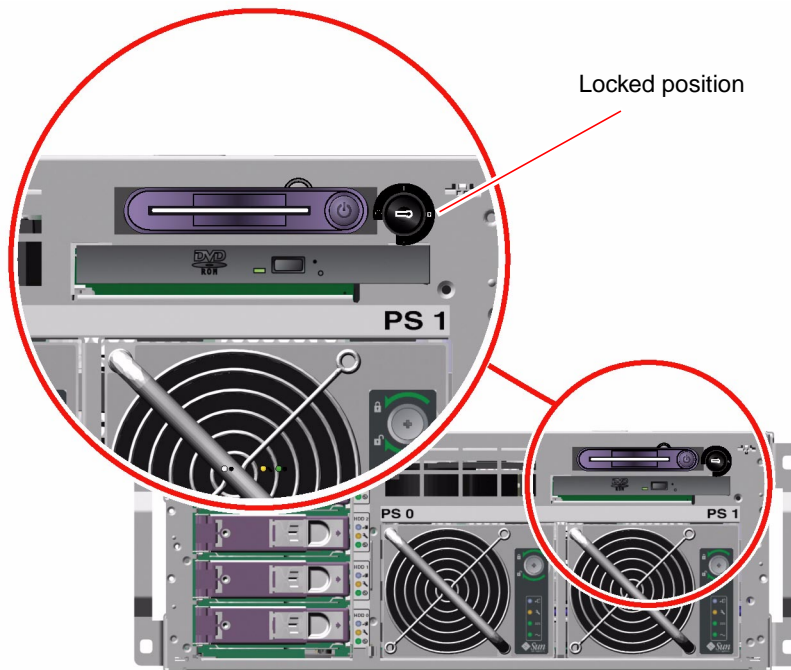

**8. Remove the system key from the system control keyswitch, close and lock the system doors, and keep the key in a secure place.**

You can close and lock the system doors while the mini-key remains in the system control keyswitch.

## What Next

To power off the system, complete this task:

- “How to Power Off the System” on page 30



---

# How to Power On the System Remotely

## Before You Begin

To issue software commands, you need to set up an alphanumeric terminal connection, a local graphics monitor connection, ALOM system controller connection, or a `tip` connection to the Sun Fire V440 server. See Chapter 3 for more information about connecting the Sun Fire V440 server to a terminal or similar device.

Do not use this power-on procedure if you have just added any new internal option or external storage device, or if you have removed a storage device without replacing it. To power on the system under those circumstances, you must initiate a reconfiguration boot. For those instructions, see:

- “How to Initiate a Reconfiguration Boot” on page 34



---

**Caution** – Before you power on the system, make sure that the system doors and all panels are properly installed.

---



---

**Caution** – Never move the system when the system power is on. Movement can cause catastrophic disk drive failure. Always power off the system before moving it.

---

For more information, see:

- “About Communicating With the System” on page 42
- “About the `sc>` Prompt” on page 48

## What to Do

1. Log in to the ALOM system controller.
2. Type the following command:

```
sc> poweron
```

## What Next

To power off the system remotely, see the following section:

- “How to Power Off the System Remotely” on page 33

---

# How to Power Off the System

## Before You Begin



---

**Caution** – Applications running on the Solaris operating environment can be adversely affected by a poorly executed system shutdown. Make sure that you stop and exit applications, and shut down the operating environment before powering off the system.

---

## What to Do

1. **Notify users that the system will be powered down.**
2. **Back up the system files and data, if necessary.**
3. **Unlock and open the right-side system door.**
4. **Ensure that the system control keyswitch is in the Normal or Diagnostics position.**

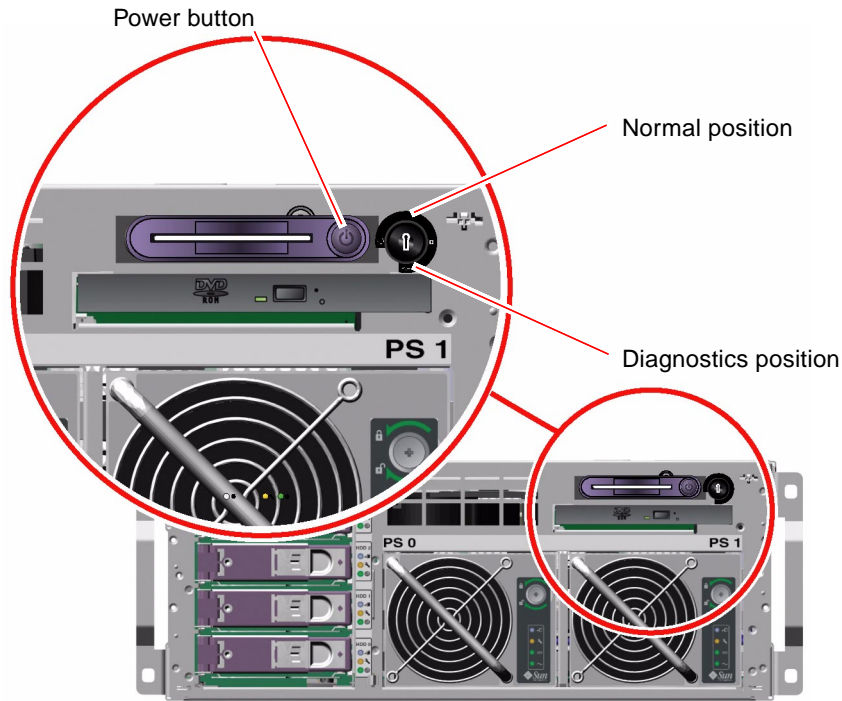

**5. Press and release the Power button.**

The system begins a graceful software system shutdown.

---

**Note** – Pressing and releasing the Power button initiates a graceful software system shutdown. Pressing and holding in the Power button for four seconds or turning the system control keyswitch to the Standby position causes an immediate hardware shutdown. Whenever possible, you should use the graceful shutdown method. Forcing an immediate hardware shutdown can cause disk drive corruption and loss of data. Use that method only as a last resort.

---

**6. Wait for the system to power off.**

The power supply Power OK LEDs go out when the system is powered off.

**7. Turn the system control keyswitch to the Standby position.**

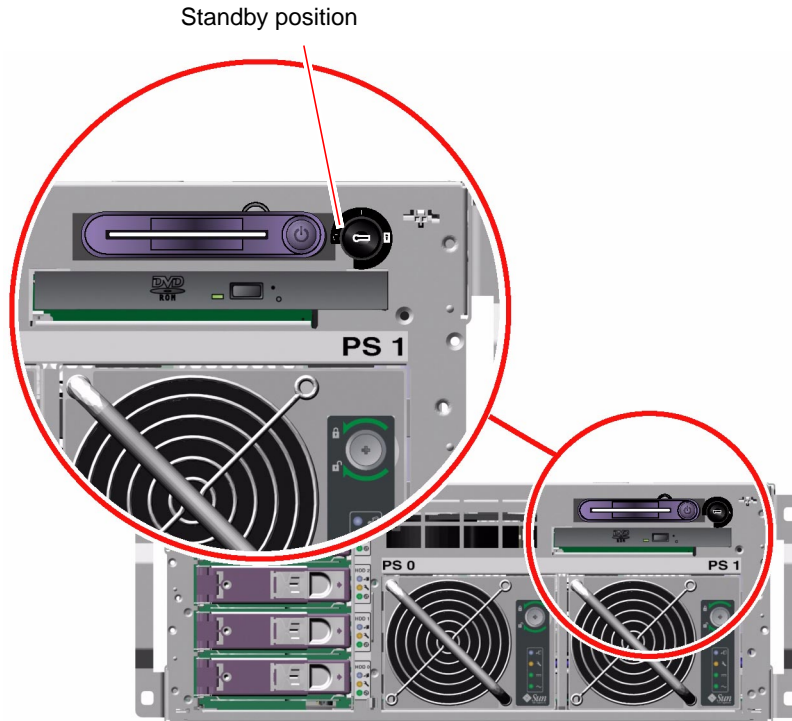

---

**Caution** – Be sure to turn the system control keyswitch to the Standby position before handling any internal components. Otherwise, it is possible for a remote ALOM system controller user to power on the system while you are working inside it. The Standby position is the only system control keyswitch position that prevents someone from using an ALOM system controller session to restart the system remotely.

---

- 8. Remove the system key from the system control keyswitch, close and lock the system doors, and keep the key in a secure place.**

You can close and lock the system doors while the mini-key remains in the system control keyswitch.

## What Next

Continue with your parts removal and installation, as needed.

---

# How to Power Off the System Remotely

## Before You Begin

To issue software commands, you need to set up an alphanumeric terminal connection, a local graphics monitor connection, ALOM system controller connection, or a `tip` connection to the Sun Fire V440 server. See Chapter 3 for more information about connecting the Sun Fire V440 server to a terminal or similar device.

You can power off the system remotely either from the `ok` prompt or from the ALOM system controller `sc>` prompt.



---

**Caution** – Applications running on the Solaris operating environment can be adversely affected by a poorly executed system shutdown. Make sure that you stop and exit applications, and shut down the operating environment before powering off the system.

---

For more information, see:

- “About Communicating With the System” on page 42
- “About the `ok` Prompt” on page 49
- “How to Get to the `ok` Prompt” on page 55
- “About the `sc>` Prompt” on page 48

## What to Do

- Complete one of the following two procedures.

### Powering Off the System From the `ok` Prompt

1. **Notify users that the system will be powered off.**
2. **Back up the system files and data, if necessary.**
3. **Get to the `ok` prompt.**

See “How to Get to the `ok` Prompt” on page 55.

4. Issue the following command:

```
ok power-off
```

## Powering Off the System From the ALOM System Controller Prompt

1. Notify users that the system will be powered off.
2. Back up the system files and data, if necessary.
3. Log in to the ALOM system controller.  
See “How to Use the Serial Management Port” on page 56.
4. Issue the following command:

```
sc> poweroff
```

---

## How to Initiate a Reconfiguration Boot

After installing any new internal option or external storage device, you must perform a reconfiguration boot so that the operating system is able to recognize the newly installed device(s). In addition, if you remove any device and do not install a replacement device prior to rebooting the system, you must perform a reconfiguration boot in order for the operating system to recognize the configuration change. This requirement also applies to any component that is connected to the system I<sup>2</sup>C bus to ensure proper environmental monitoring.

This requirement *does not* apply to any component that is:

- Installed or removed as part of a hot-plug operation
- Installed or removed before the operating system is installed
- Installed as an identical replacement for a component that is already recognized by the operating system

# Before You Begin

To issue software commands, you need to set up an alphanumeric terminal connection, a local graphics monitor connection, ALOM system controller connection, or a `tip` connection to the Sun Fire V440 server. See Chapter 3 for more information about connecting the Sun Fire V440 server to a terminal or similar device.



---

**Caution** – Before you power on the system, make sure that the system doors and all panels are properly installed.

---

This procedure assumes that you are accessing the system console using the serial management or network management port.

For more information, see:

- “About Communicating With the System” on page 42
- “About the `sc>` Prompt” on page 48
- “About the `ok` Prompt” on page 49
- “About Switching Between the ALOM System Controller and the System Console” on page 53
- “How to Get to the `ok` Prompt” on page 55

## What to Do

**1. Turn on power to any external peripherals and storage devices.**

Read the documentation supplied with the device for specific instructions.

**2. Turn on power to the alphanumeric terminal or local graphics monitor, or log in to the ALOM system controller.**

**3. Insert the system key into the system control keyswitch and turn the switch to the Diagnostics position.**

Use the Diagnostics position to run power-on self-test (POST) and OpenBoot Diagnostics tests to verify that the system functions correctly with the new part(s) you just installed. See “System Control Keyswitch” on page 12 for information about system control keyswitch settings.

**4. Press the Power button to power on the system.**

**5. If you are logged in to the `sc>` prompt, switch to the `ok` prompt. Type:**

```
sc> console
```

**6. When the system banner is displayed on the system console, immediately abort the boot process to access the system ok prompt.**

The system banner contains the Ethernet address and host ID. To abort the boot process, use one of the following methods:

- Hold down the Stop (or L1) key and press A on your keyboard.
- Press the Break key on the terminal keyboard.
- Type the `break` command from the `sc>` prompt.

**7. At the ok prompt, type the following commands:**

```
ok setenv auto-boot? false
ok reset-all
```

You must set the `auto-boot?` variable to `false` and issue the `reset-all` command to ensure that the system correctly initiates upon reboot. If you do not issue these commands, the system may fail to initialize, because the boot process was aborted in Step 6.

**8. At the ok prompt, type the following command:**

```
ok setenv auto-boot? true
```

You must set `auto-boot?` variable back to `true` so that the system boots automatically after a system reset.

**9. At the ok prompt, type the following command:**

```
ok boot -r
```

The `boot -r` command rebuilds the device tree for the system, incorporating any newly installed options so that the operating system will recognize them.

---

**Note** – The system can take anywhere from 30 seconds to 20 minutes before the system banner appears. This time depends on the system configuration (number of CPUs, memory modules, PCI cards) and the level of POST and OpenBoot Diagnostics tests being performed. For more information about OpenBoot configuration variables, see Appendix C.

---

**10. Turn the system control keyswitch to the Locked position.**

This prevents anyone from accidentally powering off the system.



11. **Remove the system key from the system control keyswitch, close and lock the system doors, and keep the key in a secure place.**

You can close and lock the system doors with the mini-key in the system control keyswitch.

## What Next

The system front panel LED indicators provide power-on status information. For information about the system LEDs, see:

- “LED Status Indicators” on page 8

If the system encounters a problem during startup, and the system control keyswitch is in the Normal position, try restarting the system in diagnostics mode to determine the source of the problem. Turn the system control keyswitch to the Diagnostics position and power cycle the system. See:

- “How to Power Off the System” on page 30

For information about system diagnostics and troubleshooting, see:

- *Sun Fire V440 Server Diagnostics and Troubleshooting Guide*

---

## How to Select a Boot Device

The boot device is specified by the setting of an OpenBoot configuration variable called `boot-device`. The default setting of this variable is `disk net`. Because of this setting, the firmware first attempts to boot from the system hard disk drive, and if that fails, from the on-board net0 Gigabit Ethernet interface.

## Before You Begin

Before you can select a boot device, you must complete system installation according to the instructions in the *Sun Fire V440 Server Installation Guide*.

This procedure assumes that you are familiar with the OpenBoot firmware and that you know how to enter the OpenBoot environment. For more information, see:

- “About the ok Prompt” on page 49

---

**Note** – The serial management port on the ALOM system controller card is preconfigured as the default system console port. For more information, see Chapter 3.

---

If you want to boot from a network, you must connect the network interface to the network. See:

- “How to Attach a Twisted-Pair Ethernet Cable” on page 143

## What to Do

- **At the `ok` prompt, type:**

```
ok setenv boot-device device-specifier
```

where the *device-specifier* is one of the following:

- `cdrom` – Specifies the DVD-ROM drive
- `disk` – Specifies the system boot disk (internal disk 0 by default)
- `disk0` – Specifies internal disk 0
- `disk1` – Specifies internal disk 1
- `disk2` – Specifies internal disk 2
- `disk3` – Specifies internal disk 3
- `net`, `net0`, `net1` – Specifies the network interfaces
- *full path name* – Specifies the device or network interface by its full path name

---

**Note** – The Solaris operating environment modifies the `boot-device` variable to its full path name, not the alias name. If you choose a non-default `boot-device` variable, the Solaris operating environment specifies the full device path of the boot device.

---

---

**Note** – You can also specify the name of the program to be booted as well as the way the boot program operates. For more information, see the *OpenBoot 4.x Command Reference Manual* in the *OpenBoot Collection AnswerBook* for your specific Solaris release.

---

If you want to specify a network interface other than an on-board Ethernet interface as the default boot device, you can determine the full path name of each interface by typing:

```
ok show-devs
```

The `show-devs` command lists the system devices and displays the full path name of each PCI device.

## What Next

For more information about using the OpenBoot firmware, see:

- *OpenBoot 4.x Command Reference Manual* in the *OpenBoot Collection AnswerBook* for your specific Solaris release
- *Sun Fire V440 Server Diagnostics and Troubleshooting Guide*



## Configuring the System Console

---

This chapter explains what the system console is, describes the different ways of configuring it on a Sun Fire V440 server, and helps you understand its relation to the system controller.

*Tasks* covered in this chapter include:

- “How to Get to the `ok` Prompt” on page 55
- “How to Use the Serial Management Port” on page 56
- “How to Activate the Network Management Port” on page 58
- “How to Access the System Console via a Terminal Server” on page 59
- “How to Access the System Console via `tip` Connection” on page 63
- “How to Modify the `/etc/remote` File” on page 66
- “How to Access the System Console via an Alphanumeric Terminal” on page 68
- “How to Verify Serial Port Settings on `ttyb`” on page 70
- “How to Access the System Console via a Local Graphics Monitor” on page 71

*Other information* in this chapter includes:

- “About Communicating With the System” on page 42
- “About the `sc>` Prompt” on page 48
- “About the `ok` Prompt” on page 49
- “About Switching Between the ALOM System Controller and the System Console” on page 53
- “Reference for System Console OpenBoot Configuration Variable Settings” on page 76

---

# About Communicating With the System

To install your system software or to diagnose problems, you need some way to interact at a low level with the system. The *system console* is Sun's facility for doing this. You use the system console to view messages and issue commands. There can be only one system console per computer.

The serial management port (SERIAL MGT) is the default port for accessing the system console upon initial system installation. After installation, you can configure the system console to accept input from and send output to different devices. See TABLE 3-1 for a summary.

**TABLE 3-1** Ways of Communicating With the System

<b>Devices Available for Accessing the System Console</b>	<b>During Installation*</b>	<b>After Installation</b>
A terminal server attached to the serial management port (SERIAL MGT) or <code>ttyb</code> . See the following: <ul style="list-style-type: none"><li>• "How to Use the Serial Management Port" on page 56</li><li>• "How to Access the System Console via a Terminal Server" on page 59</li><li>• "How to Verify Serial Port Settings on <code>ttyb</code>" on page 70</li><li>• "Reference for System Console OpenBoot Configuration Variable Settings" on page 76</li></ul>	✓	✓
An alphanumeric terminal or similar device attached to the serial management port (SERIAL MGT) or <code>ttyb</code> . See the following: <ul style="list-style-type: none"><li>• "How to Use the Serial Management Port" on page 56</li><li>• "How to Access the System Console via an Alphanumeric Terminal" on page 68</li><li>• "How to Verify Serial Port Settings on <code>ttyb</code>" on page 70</li><li>• "Reference for System Console OpenBoot Configuration Variable Settings" on page 76</li></ul>	✓	✓

**TABLE 3-1** Ways of Communicating With the System (Continued)

Devices Available for Accessing the System Console	During Installation*	After Installation
<p>A <code>tip</code> line attached to the serial management port (SERIAL MGT) or <code>tttyb</code>. See the following:</p> <ul style="list-style-type: none"> <li>• “How to Use the Serial Management Port” on page 56</li> <li>• “How to Access the System Console via <code>tip</code> Connection” on page 63</li> <li>• “How to Modify the <code>/etc/remote</code> File” on page 66</li> <li>• “How to Verify Serial Port Settings on <code>tttyb</code>” on page 70</li> <li>• “Reference for System Console OpenBoot Configuration Variable Settings” on page 76</li> </ul>	✓	✓
<p>An Ethernet line connected to the network management port (NET MGT). See the following:</p> <ul style="list-style-type: none"> <li>• “How to Activate the Network Management Port” on page 58</li> </ul>		✓
<p>A local graphics monitor (frame buffer card, graphics monitor, mouse, and so forth). See the following:</p> <ul style="list-style-type: none"> <li>• “How to Access the System Console via a Local Graphics Monitor” on page 71</li> <li>• “Reference for System Console OpenBoot Configuration Variable Settings” on page 76</li> </ul>		✓

\* After initial system installation, you can redirect the system console to take its input from and send its output to the serial port `tttyb`.

## What the System Console Does

The system console displays status and error messages generated by firmware-based tests during system startup. After those tests have been run, you can enter special commands that affect the firmware and alter system behavior. For more information about tests that run during the boot process, see the *Sun Fire V440 Server Diagnostics and Troubleshooting Guide*.

Once the operating environment is booted, the system console displays UNIX system messages and accepts UNIX commands.

## Using the System Console

To use the system console, you need some means of getting data in to and out of the system, which means attaching some kind of hardware to the system. Initially, you might have to configure that hardware, and load and configure appropriate software as well.

You also have to ensure that the system console is directed to the appropriate port on the Sun Fire V440 server's back panel—generally, the one to which your hardware console device is attached. (See FIGURE 3-1.) You do this by setting the `input-device` and `output-device` OpenBoot configuration variables.

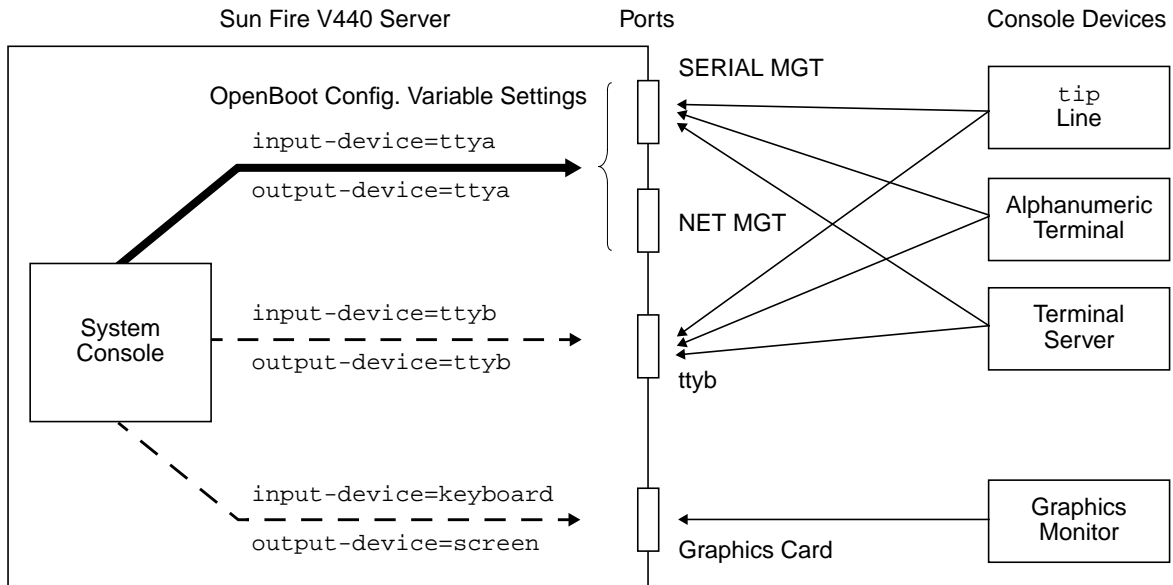

**FIGURE 3-1** Directing the System Console to Different Ports and Different Devices

The following subsections provide background information and references to instructions appropriate for the particular device you choose to access the system console. Instructions for attaching and configuring a device to access the system console are given later in this chapter.

## Default System Console Connection Through the Serial Management and Network Management Ports

On Sun Fire V440 servers, the system console comes preconfigured to allow input and output only by means of hardware devices connected to the serial or network management ports. However, because the network management port is not available until you assign it an IP address, your first connection must be to the serial management port.



Typically, you connect one of the following hardware devices to the serial management port:

- Terminal server
- Alphanumeric terminal or similar device
- A `tip` line connected to another Sun computer

This provides for secure access at the installation site.

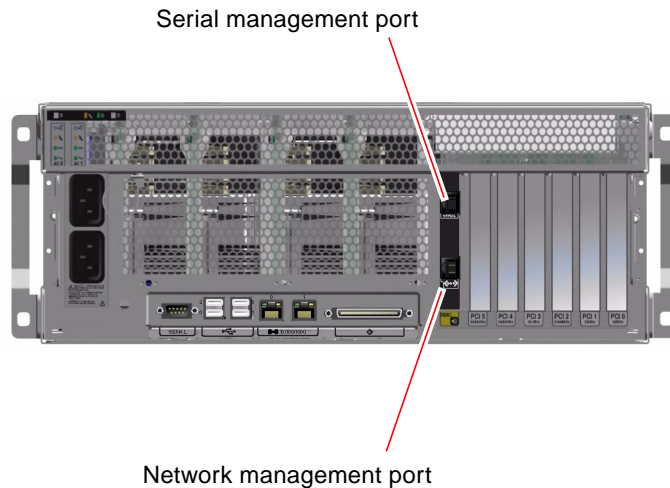

**FIGURE 3-2** Serial Management Port (Default Console Connection)

Using a `tip` line might be preferable to connecting an alphanumeric terminal, since `tip` lets you use windowing and operating system features on the machine being used to connect to the Sun Fire V440 server.

Although the Solaris operating environment sees the serial management port as `ttya`, the serial management port is not a general-purpose serial port. If you want to use a general-purpose serial port with your server—to connect a serial printer, for instance—use the regular 9-pin serial port on the back panel of the Sun Fire V440. The Solaris operating environment sees this port as `ttyb`.

For instructions on accessing the system console through a terminal server, see “How to Access the System Console via a Terminal Server” on page 59.

For instructions on accessing the system console through an alphanumeric terminal, see “How to Access the System Console via an Alphanumeric Terminal” on page 68.

For instructions on accessing the system console via a `tip` line, see “How to Access the System Console via `tip` Connection” on page 63.

## Access Through the Network Management Port

Once you have assigned an IP address to the network management port, you can connect an Ethernet-capable device to the system console through your network. This provides for remote monitoring and control. In addition, up to four simultaneous connections to the system controller `sc>` prompt are available through the network management port. For more information, see “How to Activate the Network Management Port” on page 58.

For more information about the system console and the ALOM system controller, see:

- “About the `sc>` Prompt” on page 48
- “About the `ok` Prompt” on page 49

## Alternative System Console Configuration

In the default configuration, system controller alerts and system console output appear interspersed in the same window. *After initial system installation*, you can redirect the system console to take its input from and send its output to the serial port `ttyb`, or to a graphics card’s port.

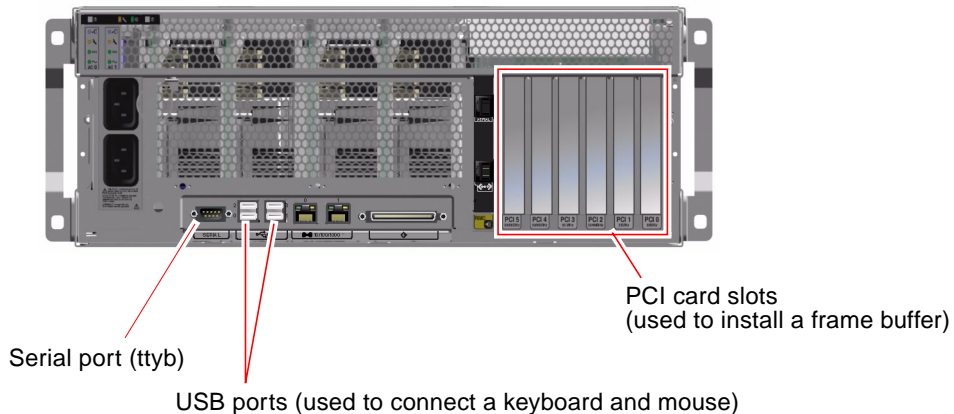

**FIGURE 3-3** Alternative Console Ports (Require Additional Configuration)

The chief advantage of redirecting the system console to another port is that it allows you to divide system controller alerts and system console output into two separate windows.

However, there are some serious disadvantages to alternative console configuration:

- POST output can only be directed to the serial management and network management ports. It cannot be directed to `tttyb` or to a graphics card's port.
- If you have directed the system console to `tttyb`, you cannot use this port for any other serial device.
- In a default configuration, the serial management and network management ports allow you to open up to four additional windows by which you can view, but not affect, system console activity. You cannot open these windows if the system console is redirected to `tttyb` or to a graphics card's port.
- In a default configuration, the serial management and network management ports allow you to switch between viewing system console and system controller output on the same device by typing a simple escape sequence or command. The escape sequence and commands do not work if the system console is redirected to `tttyb` or to a graphics card's port.
- The system controller keeps a log of console messages, but some messages are not logged if the system console is redirected to `tttyb` or to a graphic card's port. The omitted information could be important if you need to contact Sun customer service with a problem.

For all the preceding reasons, the best practice is to leave the system console in its default configuration.

You change the system console configuration by setting OpenBoot configuration variables. See "Reference for System Console OpenBoot Configuration Variable Settings" on page 76.

You can also set OpenBoot configuration variables using the ALOM system controller. For details, see the *Sun Advanced Lights Out Manager (ALOM) Online Help*.

## Accessing the System Console Through a Graphics Monitor

The Sun Fire V440 server is shipped without a mouse, keyboard, monitor, or frame buffer for the display of bitmapped graphics. To install a graphics monitor on the server, you must install a frame buffer card into a PCI slot, and attach a monitor, mouse, and keyboard to the appropriate back panel ports.

After starting the system, you might need to install the correct software driver for the PCI card you have installed. For detailed hardware instructions, see "How to Access the System Console via a Local Graphics Monitor" on page 71.

---

**Note** – Power-on self-test (POST) diagnostics cannot display status and error messages to a local graphics monitor.

---

---

## About the `sc>` Prompt

The ALOM system controller runs independently of the Sun Fire V440 server and regardless of system power state. When you connect a Sun Fire V440 server to AC power, the ALOM system controller immediately starts up, and begins monitoring the system.

---

**Note** – To view ALOM system controller boot messages, you must connect an alphanumeric terminal to the serial management port *before* connecting the AC power cords to the Sun Fire V440 server.

---

You can log in to the ALOM system controller at any time, regardless of system power state, as long as AC power is connected to the system and you have a way of interacting with the system. You can also access the ALOM system controller prompt (`sc>`) from the `ok` prompt or from the Solaris prompt, provided the system console is configured to be accessible through the serial management and network management ports. For more information, see the following:

- “How to Get to the `ok` Prompt” on page 55
- “About Switching Between the ALOM System Controller and the System Console” on page 53

The `sc>` prompt indicates that you are interacting with the ALOM system controller directly. It is the first prompt you see when you log in to the system through the serial management port or network management port, regardless of system power state.

---

**Note** – When you access the ALOM system controller for the first time, it forces you to create a user name and password for subsequent access. After this initial configuration, you will be prompted to enter a user name and password every time you access the ALOM system controller.

---

## Access Through Multiple Controller Sessions

Up to five ALOM system controller sessions can be active concurrently, one session through the serial management port and up to four sessions through the network management port. Users of each of these sessions can issue commands at the `sc>` prompt, but only one user at a time can access the system console, and then only if the system console is configured to be accessible through the serial and network management ports. For more information, see:

- “How to Use the Serial Management Port” on page 56
- “How to Activate the Network Management Port” on page 58.)

Any additional ALOM system controller sessions afford passive views of system console activity, until the active user of the system console logs out. However, the `console -f` command, if you enable it, allows users to seize access to the system console from one another. For more information, see the *Sun Advanced Lights Out Manager (ALOM) Online Help*.

## Ways of Reaching the `sc>` Prompt

There are several ways to get to the `sc>` prompt. These are:

- If the system console is directed to the serial management and network management ports, you can type the ALOM system controller escape sequence (`#.`).
- You can log in directly to the ALOM system controller from a device connected to the serial management port. See “How to Use the Serial Management Port” on page 56.
- You can log in directly to the ALOM system controller using a connection through the network management port. See “How to Activate the Network Management Port” on page 58.

---

## About the `ok` Prompt

A Sun Fire V440 server with the Solaris operating environment installed is capable of operating at different *run levels*. A synopsis of run levels follows. For a full description, see the Solaris system administration documentation.

Most of the time, you operate a Sun Fire V440 server at run level 2 or run level 3, which are multiuser states with access to full system and network resources. Occasionally, you might operate the system at run level 1, which is a single-user administrative state. However, the lowest operational state is run level 0. At this state, it is safe to turn off power to the system.

When a Sun Fire V440 server is at run level 0, the `ok` prompt appears. This prompt indicates that the OpenBoot firmware is in control of the system.

There are a number of scenarios in which OpenBoot firmware control can happen.

- By default, the system comes up under OpenBoot firmware control before the operating environment is installed.
- The system boots to the `ok` prompt when the `auto-boot?` OpenBoot configuration variable is set to `false`.
- The system transitions to run level 0 in an orderly way when the operating environment is halted.
- The system reverts to OpenBoot firmware control when the operating environment crashes.
- During the boot process, when there is a serious hardware problem that prevents the operating environment from running, the system reverts to OpenBoot firmware control.
- When a serious hardware problem develops while the system is running, the operating environment transitions smoothly to run level 0.
- You deliberately place the system under firmware control in order to execute firmware-based commands or to run diagnostic tests.

It is the last of these scenarios which most often concerns you as an administrator, since there will be times when you need to reach the `ok` prompt. The several ways to do this are outlined in “Ways of Reaching the `ok` Prompt” on page 50. For detailed instructions, see “How to Get to the `ok` Prompt” on page 55.

## Ways of Reaching the `ok` Prompt

There are several ways to get to the `ok` prompt, depending on the state of the system and the means by which you are accessing the system console. In order of desirability, these are:

- Graceful shutdown
- ALOM system controller `break` or `console` command
- L1-A (Stop-A) keys or Break key
- Externally initiated reset (XIR)
- Manual system reset

A discussion of each method follows. For instructions, see “How to Get to the ok Prompt” on page 55.

## Graceful Shutdown

The preferred method of reaching the `ok` prompt is to shut down the operating environment by issuing an appropriate command (for example, the `shutdown`, `init`, or `uadmin` command) as described in Solaris system administration documentation. You can also use the system Power button to initiate a graceful system shutdown.

Gracefully shutting down the system prevents data loss, enables you to warn users beforehand, and causes minimal disruption. You can usually perform a graceful shutdown, provided the Solaris operating environment is running and the hardware has not experienced serious failure.

You can also perform a graceful system shutdown from the ALOM system controller command prompt.

For more information, see:

- “How to Power Off the System” on page 30
- “How to Power Off the System Remotely” on page 33

## ALOM System Controller `break` or `console` Command

Typing `break` from the `sc>` prompt forces a running Sun Fire V440 server to drop into OpenBoot firmware control. If the operating system is already halted, you can use the `console` command instead of `break` to reach the `ok` prompt.

After forcing the system into OpenBoot firmware control, be aware that issuing certain OpenBoot commands (like `probe-scsi`, `probe-scsi-all`, or `probe-ide`) might hang the system.

## L1-A (Stop-A) Keys or Break Key

When it is impossible or impractical to shut down the system gracefully, you can get to the `ok` prompt by typing the L1-A (Stop-A) key sequence from a Sun keyboard, or, if you have an alphanumeric terminal attached to the Sun Fire V440 server, by pressing the Break key.

After forcing the system into OpenBoot firmware control, be aware that issuing certain OpenBoot commands (like `probe-scsi`, `probe-scsi-all`, or `probe-ide`) might hang the system.

---

**Note** – These methods of reaching the `ok` prompt will only work if the system console has been redirected to the appropriate port. For details, see “Reference for System Console OpenBoot Configuration Variable Settings” on page 76

---

## Externally Initiated Reset (XIR)

Use the ALOM system controller `reset -x` command to execute an externally initiated reset (XIR). Forcing an XIR might be effective in breaking the deadlock that is hanging up the system. However, an XIR also precludes the orderly shutdown of applications, and so it is not the preferred method of reaching the `ok` prompt, unless you are troubleshooting these types of system hangs. Generating an XIR has the advantage of allowing you to issue the `sync` command to produce a dump file of the current system state for diagnostic purposes.

For more information, see:

- *Sun Fire V440 Server Diagnostics and Troubleshooting Guide*
- *Sun Advanced Lights Out Manager (ALOM) Online Help*



---

**Caution** – Because an XIR precludes an orderly shutdown of applications, it should only be attempted if previously described methods do not work.

---

## Manual System Reset

Use the ALOM system controller `reset` command, or `poweron` and `poweroff` commands, to reset the server. Reaching the `ok` prompt by performing a manual system reset or by power-cycling the system should be the method of last resort. Doing this results in the loss of all system coherence and state information. A manual system reset could corrupt the server’s file systems, although the `fsck` command usually restores them. Use this method only when nothing else works.



---

**Caution** – Forcing a manual system reset results in loss of system state data, and should be attempted only as a last resort. After a manual system reset, all state information is lost, which inhibits troubleshooting the cause of the problem until the problem reoccurs.

---



## Important: Accessing the ok Prompt Suspends the Solaris Operating Environment

It is important to understand that when you access the ok prompt from a functioning Sun Fire V440 server, you are suspending the Solaris operating environment and placing the system under firmware control. Any processes that were running under the operating environment are also suspended, and *the state of such processes might not be recoverable*.

The diagnostic tests and commands you run from the ok prompt have the potential to affect the state of the system. This means that it is not always possible to resume execution of the operating environment from the point at which it was suspended. Although the go command will resume execution in most circumstances, in general, each time you drop the system down to the ok prompt, you should expect to have to reboot the system to get back to the operating environment.

As a rule, before suspending the operating environment, you should back up files, warn users of the impending shutdown, and halt the system in an orderly manner. However, it is not always possible to take such precautions, especially if the system is malfunctioning.

### For More Information

For more information about the OpenBoot firmware, see the *OpenBoot 4.x Command Reference Manual*. An online version of the manual is included with the *OpenBoot Collection AnswerBook* that ships with Solaris software.

---

## About Switching Between the ALOM System Controller and the System Console

The Sun Fire V440 server features two management ports, labeled SERIAL MGT and NET MGT, located on the server's back panel. If the system console is directed to use the serial management and network management ports (its default configuration), these ports provide access to both the system console and the ALOM system controller, each on separate "channels" (see FIGURE 3-4).

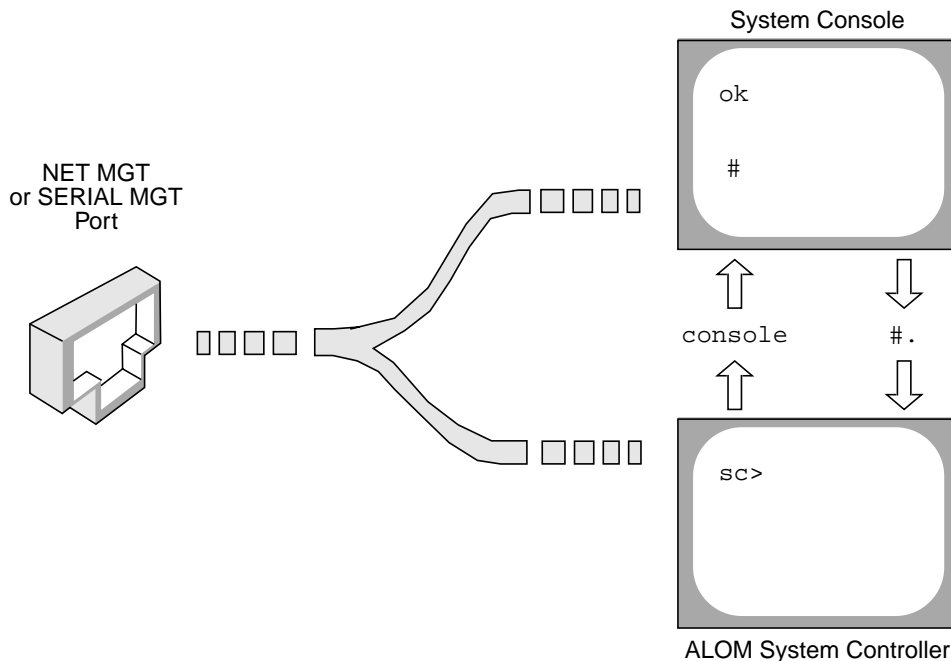

**FIGURE 3-4** Separate System Console and System Controller “Channels”

If the system console is configured to be accessible from the serial management and network management ports, when you connect through one of these ports you can access either the ALOM command-line interface or the system console. You can switch between the ALOM system controller and the system console at any time, but you cannot access both at the same time from a single terminal or shell tool.

The prompt displayed on the terminal or shell tool tells you which “channel” you are accessing:

- The # or % prompt indicates that you are at the system console and that the Solaris operating environment is running.
- The ok prompt indicates that you are at the system console and that the server is running under OpenBoot firmware control.
- The sc> prompt indicates that you are at the ALOM system controller.

---

**Note** – If no text or prompt appears, it may be the case that no console messages were recently generated by the system. If this happens, pressing the terminal’s Enter or Return key should produce a prompt.

---

To reach the system console from the ALOM system controller, type the `console` command at the `sc>` prompt. To reach the ALOM system controller from the system console, type the system controller escape sequence, which by default is `#.` (pound period).

For more information, see the following:

- “About Communicating With the System” on page 42
- “About the `sc>` Prompt” on page 48
- “About the `ok` Prompt” on page 49
- “How to Use the Serial Management Port” on page 56
- *Sun Advanced Lights Out Manager (ALOM) Online Help*

---

## How to Get to the `ok` Prompt

### Before You Begin

This procedure provides several ways of reaching the `ok` prompt. The methods are not equally desirable. For details about when to use each method, see:

- “About the `ok` Prompt” on page 49



---

**Caution** – Dropping the Sun Fire V440 server to the `ok` prompt suspends all application and operating system software. After you issue firmware commands and run firmware-based tests from the `ok` prompt, the system might not be able to resume where it left off.

---

If at all possible, back up system data before starting this procedure. Also exit or stop all applications and warn users of the impending loss of service. For information about the appropriate backup and shutdown procedures, see Solaris system administration documentation.

### What to Do

1. **Decide which method you need to use to reach the `ok` prompt.**

See “About the `ok` Prompt” on page 49 for details.

## 2. Refer to TABLE 3-2 for instructions.

**TABLE 3-2** Ways of Accessing the ok Prompt

Access Method	What to Do
Graceful shutdown of the Solaris operating environment	<ul style="list-style-type: none"><li>• From a shell or command tool window, issue an appropriate command (for example, the <code>shutdown</code> or <code>init</code> command) as described in Solaris system administration documentation.</li></ul>
L1-A (Stop-A) keys or Break key	<ul style="list-style-type: none"><li>• From a Sun keyboard connected directly to the Sun Fire V440 server, press the Stop and A keys simultaneously.* –or–</li><li>• From an alphanumeric terminal configured to access the system console, press the Break key.</li></ul>
ALOM system controller <code>console</code> or <code>break</code> command	<ul style="list-style-type: none"><li>• From the <code>sc&gt;</code> prompt, type the <code>break</code> command. The <code>console</code> command also works, provided the operating environment software is not running and the server is already under OpenBoot firmware control.</li></ul>
Externally initiated reset (XIR)	<ul style="list-style-type: none"><li>• From the <code>sc&gt;</code> prompt, type the <code>reset -x</code> command.</li></ul>
Manual system reset	<ul style="list-style-type: none"><li>• From the <code>sc&gt;</code> prompt, type the <code>reset</code> command.</li></ul>

\* Requires the OpenBoot configuration variable `input-device=keyboard`. For more information, see “How to Access the System Console via a Local Graphics Monitor” on page 71 and “Reference for System Console OpenBoot Configuration Variable Settings” on page 76.

## How to Use the Serial Management Port

This procedure assumes that the system console is directed to use the serial management and network management ports (the default configuration).

When you are accessing the system console using a device connected to the serial management port, your first point of access is the ALOM system controller and its `sc>` prompt. After connecting to the ALOM system controller, you can switch to the system console itself.

For more information about the ALOM system controller card, see:

- “About the ALOM System Controller Card” on page 81
- *Sun Advanced Lights Out Manager (ALOM) Online Help*

## Before You Begin

Make sure that the serial port on your connecting device is set to the following parameters:

- 9600 baud
- 8 bits
- No parity
- 1 stop bit
- No handshaking

## What to Do

1. **Establish an ALOM system controller session.**

See *Sun Advanced Lights Out Manager (ALOM) Online Help* for instructions.

2. **To connect to the system console, at the ALOM system controller command prompt, type:**

```
sc> console
```

The `console` command switches you to the system console.

3. **To switch back to the `sc>` prompt, type the `#.` escape sequence.**

```
ok #. [characters are not echoed to the screen]
```

## What Next

For instructions on how to use the ALOM system controller, see:

- *Sun Advanced Lights Out Manager (ALOM) Online Help*

---

# How to Activate the Network Management Port

## Before You Begin

You must assign an Internet Protocol (IP) address to the network management port before you can use it. If you are configuring the network management port for the first time, you must first connect to the ALOM system controller using the serial management port and assign an IP address to the network management port. You can either assign an IP address manually, or you can configure the port to obtain an IP address using the Dynamic Host Configuration Protocol (DHCP) from another server.

Data centers frequently devote a separate subnet to system management. If your data center has such a configuration, connect the network management port to this subnet.

---

**Note** – The network management port is a 10BASE-T port. The IP address assigned to the network management port is a unique IP address, separate from the main Sun Fire V440 server IP address, and is dedicated for use only with the ALOM system controller. For more information, see “About the ALOM System Controller Card” on page 81.

---

## What to Do

1. **Connect an Ethernet cable to the network management port.**
2. **Log in to the ALOM system controller through the serial management port.**  
For more information about connecting to the serial management port, see “How to Use the Serial Management Port” on page 56.
3. **Type one of the following commands:**

- If your network uses static IP addresses, type:

```
sc> setsc if_network true
sc> setsc netsc_ipaddr ip-address
sc> setsc netsc_ipnetmask ip-address
sc> setsc netsc_ipgateway ip-address
```

- If your network uses Dynamic Host Configuration Protocol (DHCP), type:

```
sc> setsc netsc_dhcp
```

4. To verify the network settings, type:

```
sc> shownetwork
```

5. Log out of the ALOM system controller session.

## What Next

To connect through the network management port, use the `telnet` command to the IP address you specified in Step 3 of the preceding procedure.

---

# How to Access the System Console via a Terminal Server

## Before You Begin

The following procedure assumes that you are accessing the system console by connecting a terminal server to the serial management port (SERIAL MGT) of the Sun Fire V440 server.

# What to Do

## 1. Complete the physical connection from the serial management port to your terminal server.

The serial management port on the Sun Fire V440 server is a data terminal equipment (DTE) port. The pinouts for the serial management port correspond with the pinouts for the RJ-45 ports on the Serial Interface Breakout Cable supplied by Cisco for use with the Cisco AS2511-RJ terminal server. If you use a terminal server made by another manufacturer, check that the serial port pinouts of the Sun Fire V440 server match those of the terminal server you plan to use.

If the pinouts for the server serial ports correspond with the pinouts for the RJ-45 ports on the terminal server, you have two connection options:

- Connect a serial interface breakout cable directly to the Sun Fire V440 server. See “How to Use the Serial Management Port” on page 56.
- Connect a serial interface breakout cable to a patch panel and use the straight-through patch cable (supplied by Sun) to connect the patch panel to the server.

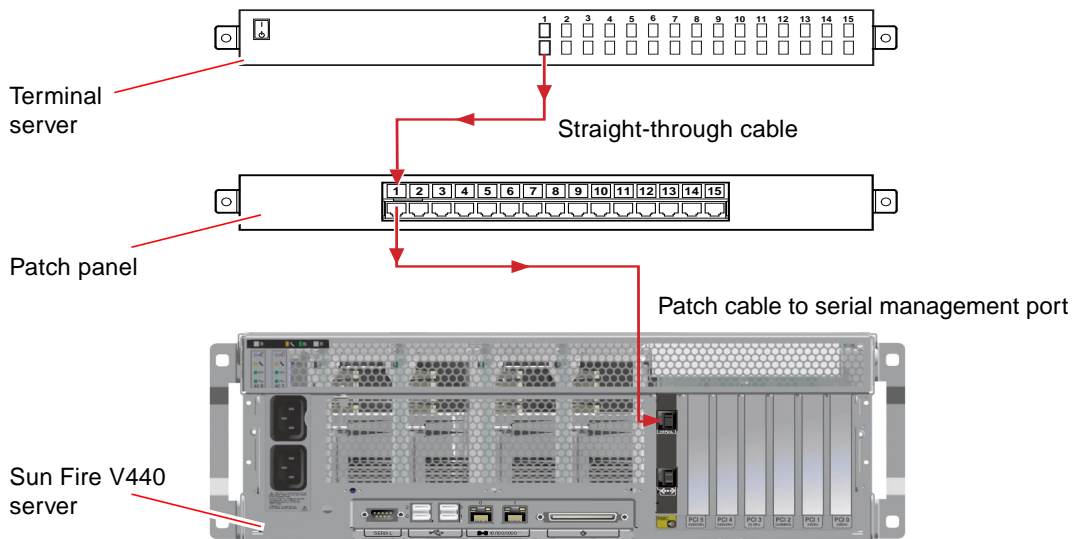

**FIGURE 3-5** Patch Panel Connection Between a Terminal Server and a Sun Fire V440 Server



If the pinouts for the serial management port *do not* correspond with the pinouts for the RJ-45 ports on the terminal server, you need to make a crossover cable that takes each pin on the Sun Fire V440 server serial management port to the corresponding pin in the terminal server's serial port.

TABLE 3-3 shows the crossovers that the cable must perform.

**TABLE 3-3** Pin Crossovers for Connecting to a Typical Terminal Server

Sun Fire V440 Serial Port (RJ-45 Connector) Pin	Terminal Server Serial Port Pin
Pin 1 (RTS)	Pin 1 (CTS)
Pin 2 (DTR)	Pin 2 (DSR)
Pin 3 (TXD)	Pin 3 (RXD)
Pin 4 (Signal Ground)	Pin 4 (Signal Ground)
Pin 5 (Signal Ground)	Pin 5 (Signal Ground)
Pin 6 (RXD)	Pin 6 (TXD)
Pin 7 (DSR /DCD)	Pin 7 (DTR)
Pin 8 (CTS)	Pin 8 (RTS)

**2. Open a terminal session on the connecting device, and type:**

```
% telnet IP-address-of-terminal-server port-number
```

For example, for a Sun Fire V440 server connected to port 10000 on a terminal server whose IP address is 192.20.30.10, you would type:

```
% telnet 192.20.30.10 10000
```

**3. If you want to use *ttyb* instead of the serial management port, do the following:**

**a. Redirect the system console by changing OpenBoot configuration variables.**

At the ok prompt, type the following commands:

```
ok setenv input-device ttyb
ok setenv output-device ttyb
```

---

**Note** – Redirecting the system console does not redirect POST output. You can only view POST messages from the serial and network management port devices.

---

---

**Note** – There are many other OpenBoot configuration variables. Although these variables do not affect which hardware device is used to access the system console, some of them affect which diagnostic tests the system runs and which messages the system displays at its console. For details, see the *Sun Fire V440 Server Diagnostics and Troubleshooting Guide*.

---

**b. To cause the changes to take effect, power off the system. Type:**

```
ok power-off
```

The system permanently stores the parameter changes and powers off.

---

**Note** – You can also power off the system using the front panel Power button.

---

**c. Connect the null modem serial cable to the `ttyb` port on the Sun Fire V440 server.**

If required, use the DB-9 or DB-25 cable adapter supplied with the server.

**d. Power on the system.**

See Chapter 2 for power-on procedures.

## What Next

Continue with your installation or diagnostic test session as appropriate. When you are finished, end your session by typing the terminal server's escape sequence and exit the window.

For more information about connecting to and using the ALOM system controller, see:

- *Sun Advanced Lights Out Manager (ALOM) Online Help*

If you have redirected the system console to `ttyb` and want to change the system console settings back to use the serial management and network management ports, see the following:

- "Reference for System Console OpenBoot Configuration Variable Settings" on page 76

---

# How to Access the System Console via `tip` Connection

## Before You Begin

This procedure assumes that you are accessing the Sun Fire V440 server system console by connecting the serial port of another Sun system to the serial management port (SERIAL MGT) of the Sun Fire V440 server (FIGURE 3-6).

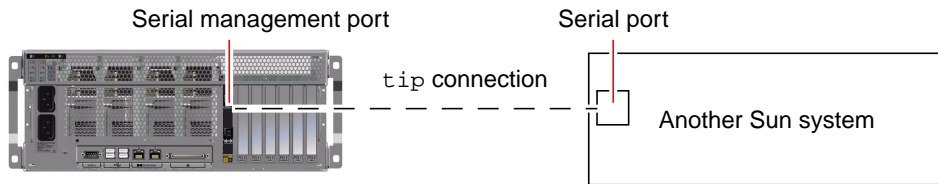

**FIGURE 3-6** `tip` Connection Between a Sun Fire V440 Server and Another Sun System

## What to Do

- 1. Connect the RJ-45 serial cable and, if required, the DB-9 or DB-25 adapter provided.**

The cable and adapter connect between another Sun system's serial port (typically `ttyb`) and the serial management port on the back panel of the Sun Fire V440 server. Pinouts, part numbers, and other details about the serial cable and adapter are provided in the *Sun Fire V440 Server Parts Installation and Removal Guide*.

- 2. Ensure that the `/etc/remote` file on the Sun system contains an entry for hardware.**

Most releases of Solaris operating environment software shipped since 1992 contain an `/etc/remote` file with the appropriate `hardware` entry. However, if the Sun system is running an older version of Solaris operating environment software, or if the `/etc/remote` file has been modified, you might need to edit it. See "How to Modify the `/etc/remote` File" on page 66 for details.

**3. In a shell tool window on the Sun system, type:**

```
% tip hardwire
```

The Sun system responds by displaying:

```
connected
```

The shell tool is now a `tip` window directed to the Sun Fire V440 server via the Sun system's serial port. This connection is established and maintained even when the Sun Fire V440 server is completely powered off or just starting up.

---

**Note** – Use a shell tool or a CDE terminal (such as `dtterm`), not a command tool. Some `tip` commands might not work properly in a command tool window.

---

**4. If you want to use `ttvb` on the Sun Fire V440 server instead of the serial management port, do the following:**

**a. Redirect the system console by changing the OpenBoot configuration variables.**

At the `ok` prompt on the Sun Fire V440 server, type the following commands:

```
ok setenv input-device ttyb
ok setenv output-device ttyb
```

---

**Note** – You can only access the `sc>` prompt and view POST messages from either the serial management port or the network management port.

---

---

**Note** – There are many other OpenBoot configuration variables. Although these variables do not affect which hardware device is used to access the system console, some of them affect which diagnostic tests the system runs and which messages the system displays at its console. For details, see the *Sun Fire V440 Server Diagnostics and Troubleshooting Guide*.

---

**b. To cause the changes to take effect, power off the system. Type:**

```
ok power-off
```

The system permanently stores the parameter changes and powers off.

---

**Note** – You can also power off the system using the front panel Power button.

---

**c. Connect the null modem serial cable to the `tttyb` port on the Sun Fire V440 server.**

If required, use the DB-9 or DB-25 cable adapter supplied with the server.

**d. Power on the system.**

See Chapter 2 for power-on procedures.

## What Next

Continue with your installation or diagnostic test session as appropriate. When you are finished using the `tip` window, end your `tip` session by typing `~.` (the tilde symbol followed by a period) and exit the window. For more information about `tip` commands, see the `tip` man page.

For more information about connecting to and using the ALOM system controller, see:

- *Sun Advanced Lights Out Manager (ALOM) Online Help*

If you have redirected the system console to `tttyb` and want to change the system console settings back to use the serial management and network management ports, see the following:

- “Reference for System Console OpenBoot Configuration Variable Settings” on page 76

---

# How to Modify the `/etc/remote` File

This procedure might be necessary if you are accessing the Sun Fire V440 server using a `tip` connection from a Sun system running an older version of the Solaris operating environment software. You might also need to perform this procedure if the `/etc/remote` file on the Sun system has been altered and no longer contains an appropriate `hardware` entry.

## Before You Begin

This procedure assumes that you are logged in as superuser to the system console of a Sun system that you intend to use to establish a `tip` connection to the Sun Fire V440 server.

## What to Do

1. **Determine the release level of Solaris operating environment software installed on the Sun system. Type:**

```
# uname -r
```

The system responds with a release number.

2. **Do one of the following, depending on the number displayed.**

- **If the number displayed by the `uname -r` command is 5.0 or higher:**

The Solaris operating environment software shipped with an appropriate entry for `hardware` in the `/etc/remote` file. If you have reason to suspect that this file was altered and the `hardware` entry modified or deleted, check the entry against the following example, and edit it as needed.

```
hardware:\
      :dv=/dev/term/b:br#9600:el=^C^S^Q^U^D:ie=%$:oe=^D:
```

---

**Note** – If you intend to use the Sun system’s serial port A rather than serial port B, edit this entry by replacing `/dev/term/b` with `/dev/term/a`.

---

- **If the number displayed by the `uname -r` command is less than 5.0:**

Check the `/etc/remote` file and add the following entry, if it does not already exist.

```
hardwire:\
      :dv=/dev/ttyb:br#9600:el=^C^S^Q^U^D:ie=%$:oe=^D:
```

---

**Note** – If you intend to use the Sun system’s serial port A rather than serial port B, edit this entry by replacing `/dev/ttyb` with `/dev/ttya`.

---

## What Next

The `/etc/remote` file is now properly configured. Continue establishing a `tip` connection to the Sun Fire V440 server system console. See:

- “How to Access the System Console via `tip` Connection” on page 63

If you have redirected the system console to `ttyb` and want to change the system console settings back to use the serial management and network management ports, see the following:

- “Reference for System Console OpenBoot Configuration Variable Settings” on page 76

---

# How to Access the System Console via an Alphanumeric Terminal

## Before You Begin

This procedure assumes that you are accessing the Sun Fire V440 server system console by connecting the serial port of an alphanumeric terminal to the serial management port (SERIAL MGT) of the Sun Fire V440 server.

## What to Do

1. **Attach one end of the serial cable to the alphanumeric terminal's serial port.**

Use a null modem serial cable or an RJ-45 serial cable and null modem adapter. Plug in this cable to the terminal's serial port connector.

2. **Attach the opposite end of the serial cable to the serial management port on the Sun Fire V440 server.**

3. **Connect the alphanumeric terminal's power cord to an AC outlet.**

4. **Set the alphanumeric terminal to receive:**

- 9600 baud
- 8 bits
- No parity
- 1 stop bit
- No handshake protocol

See the documentation accompanying your terminal for information about how to configure it.

5. ***If you want to use `ttyb` instead of the serial management port, do the following:***

- a. **Redirect the system console by changing the OpenBoot configuration variables.**

At the `ok` prompt, type the following commands:

```
ok setenv input-device ttyb
ok setenv output-device ttyb
```



---

**Note** – You can only access the `sc>` prompt and view POST messages from either the serial management port or the network management port.

---

---

**Note** – There are many other OpenBoot configuration variables. Although these variables do not affect which hardware device is used to access the system console, some of them affect which diagnostic tests the system runs and which messages the system displays at its console. For details, see the *Sun Fire V440 Server Diagnostics and Troubleshooting Guide*.

---

**b. To cause the changes to take effect, power off the system. Type:**

```
ok power-off
```

The system permanently stores the parameter changes and powers off.

---

**Note** – You can also power off the system using the front panel Power button.

---

**c. Connect the null modem serial cable to the `ttyb` port on the Sun Fire V440 server.**

If required, use the DB-9 or DB-25 cable adapter supplied with the server.

**d. Power on the system.**

See Chapter 2 for power-on procedures.

## What Next

You can issue system commands and view system messages using the alphanumeric terminal. Continue with your installation or diagnostic procedure, as needed. When you are finished, type the alphanumeric terminal's escape sequence.

For more information about connecting to and using the ALOM system controller, see:

- *Sun Advanced Lights Out Manager (ALOM) Online Help*

If you have redirected the system console to `ttyb` and want to change the system console settings back to use the serial management and network management ports, see the following:

- “Reference for System Console OpenBoot Configuration Variable Settings” on page 76

---

# How to Verify Serial Port Settings on `tttyb`

This procedure lets you verify the baud rate and other serial port settings used by the Sun Fire V440 server to communicate with a device attached to its `tttyb` port.

---

**Note** – The serial management port always operates at 9600 baud, 8 bits, with no parity and 1 stop bit.

---

## Before You Begin

You must be logged in to the Sun Fire V440 server, and the server must be running Solaris operating environment software.

## What to Do

1. Open a shell tool window.
2. Type:

```
# eeprom | grep tttyb-mode
```

3. Look for the following output:

```
tttyb-mode = 9600,8,n,1,-
```

This line indicates that the Sun Fire V440 server's serial port `tttyb` is configured for:

- 9600 baud
- 8 bits
- No parity
- 1 stop bit
- No handshake protocol

## What Next

For more information about serial port settings, see the `eeprom` man page. For more information about the `tttyb-mode` OpenBoot configuration variable, see Appendix C.

---

# How to Access the System Console via a Local Graphics Monitor

## Before You Begin

After initial system installation, you can install a local graphics monitor and configure it to access the system console. You *cannot* use a local graphics monitor to perform initial system installation, nor can you use a local graphics monitor to view power-on self-test (POST) messages.

To install a local graphics monitor, you must have:

- A supported PCI-based graphics frame buffer card and software driver.  
An 8/24-Bit Color Graphics PCI adapter frame buffer card (Sun part number X3768A or X3769A is currently supported)
- A monitor with appropriate resolution to support the frame buffer
- A Sun-compatible USB keyboard (Sun USB Type-6 keyboard)
- A Sun-compatible USB mouse (Sun USB mouse) and mouse pad

## What to Do

### 1. Install the graphics card into an appropriate PCI slot.

Installation must be performed by a qualified service provider. For further information, see the *Sun Fire V440 Server Parts Installation and Removal Guide* or contact your qualified service provider.

2. Attach the monitor's video cable to the graphics card's video port.  
Tighten the thumbscrews to secure the connection.

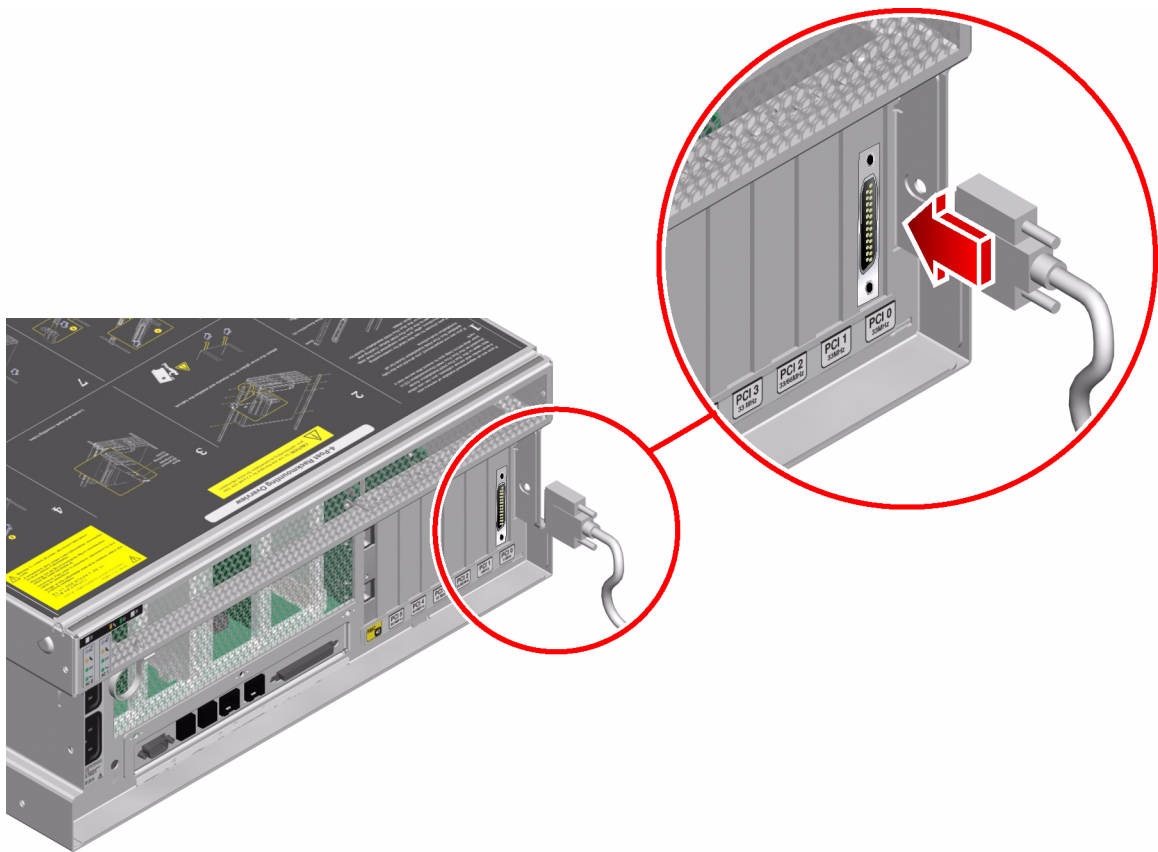

3. Connect the monitor's power cord to an AC outlet.
4. Connect the USB keyboard cable to any USB port on the Sun Fire V440 server back panel.

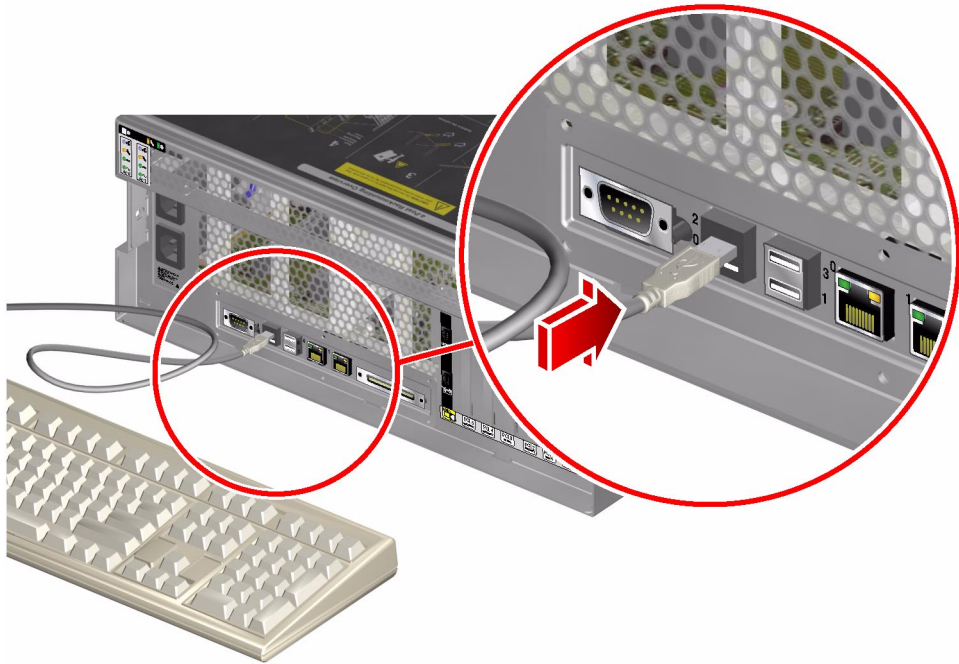

5. Connect the USB mouse cable to any USB port on the Sun Fire V440 server back panel.

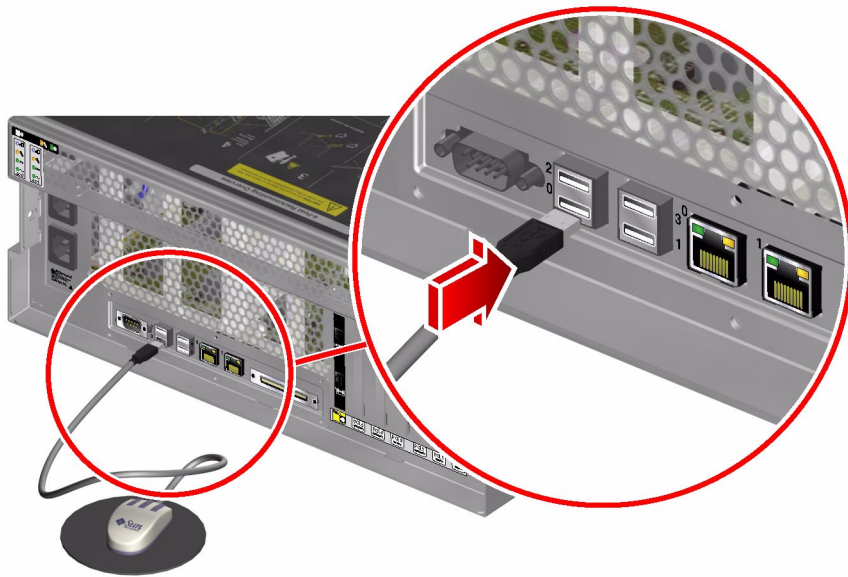

## 6. Get to the `ok` prompt.

For more information, see “How to Get to the `ok` Prompt” on page 55.

## 7. Set OpenBoot configuration variables appropriately.

From the existing system console, type:

```
ok setenv input-device keyboard
ok setenv output-device screen
```

---

**Note** – There are many other OpenBoot configuration variables. Although these variables do not affect which hardware device is used to access the system console, some of them affect which diagnostic tests the system runs and which messages the system displays at its console. For details, see the *Sun Fire V440 Server Diagnostics and Troubleshooting Guide*.

---

## 8. To cause the changes to take effect, type:

```
ok reset-all
```

The system stores the parameter changes, and boots automatically when the OpenBoot configuration variable `auto-boot?` is set to `true` (its default value).

---

**Note** – To store parameter changes, you can also power cycle the system using the front panel Power button.

---

## What Next

You can issue system commands and view system messages using your local graphics monitor. Continue with your installation or diagnostic procedure, as needed.

If you want to redirect the system console back to the serial management and network management ports, see:

- “Reference for System Console OpenBoot Configuration Variable Settings” on page 76

# Reference for System Console OpenBoot Configuration Variable Settings

The Sun Fire V440 system console is directed to the serial management and network management ports (SERIAL MGT and NET MGT) by default. However, you can redirect the system console to the serial DB-9 port (`ttyb`), or to a local graphics monitor, keyboard, and mouse. You can also redirect the system console back to the serial management and network management ports.

Certain OpenBoot configuration variables control from where system console input is taken and to where its output is directed. The table below shows how to set these variables in order to use the serial management and network management ports, `ttyb`, or a local graphics monitor as the system console connection.

**TABLE 3-4** OpenBoot Configuration Variables That Affect the System Console

OpenBoot Configuration Variable Name	Setting for Sending System Console Output to:		
	Serial and Network Management Ports	Serial Port ( <code>ttyb</code> )*	Local Graphics Monitor*
<code>output-device</code>	<code>ttya</code>	<code>ttyb</code>	<code>screen</code>
<code>input-device</code>	<code>ttya</code>	<code>ttyb</code>	<code>keyboard</code>

\*POST output will still be directed to the serial management port, as POST has no mechanism to direct its output to a graphics monitor.

The serial management port and network management port are present in the OpenBoot configuration variables as `ttya`. However, the serial management port does not function as a standard serial connection. If you want to connect a conventional serial device (such as a printer) to the system, you need to connect it to `ttyb`, *not* the serial management port. See “About the Serial Ports” on page 99 for more information.

It is important to note that the `sc>` prompt and POST messages are only available through the serial management port and network management port. In addition, the ALOM system controller `console` command is ineffective when the system console is redirected to `ttyb` or a local graphics monitor.

In addition to the OpenBoot configuration variables described in TABLE 3-4, there are other variables that affect and determine system behavior. These variables, which are stored on the system configuration card, are discussed in more detail in “About the System Configuration Card” on page 87.



## Configuring Hardware

---

This chapter provides hardware configuration information for the Sun Fire V440 server.

This chapter contains the following sections:

- “About the CPU/Memory Modules” on page 78
- “About the Memory Modules” on page 78
- “About the ALOM System Controller Card” on page 81
- “About the PCI Cards and Buses” on page 85
- “About the System Configuration Card” on page 87
- “How to Migrate a System Configuration Card From One System to Another System” on page 88
- “About the Ultra-4 SCSI Backplane” on page 89
- “About Hot-Pluggable Components” on page 90
- “About Internal Disk Drives” on page 91
- “About the Power Supplies” on page 93
- “About the System Fans” on page 97
- “About the USB Ports” on page 100

For instructions on performing a hot-plug procedure on a power supply, see:

- “How to Perform a Power Supply Hot-Plug Operation” on page 95

For configuration information about network interfaces, see:

- “How to Configure the Primary Network Interface” on page 144
- “How to Configure Additional Network Interfaces” on page 146

---

## About the CPU/Memory Modules

The system motherboard provides slots for up to four CPU/memory modules. Each CPU/memory module incorporates one UltraSPARC IIIi processor, and slots for up to four memory modules (DIMMs). The CPUs in the system are numbered from 0 to 3, depending on the slot where each CPU resides.

---

**Note** – CPU/memory modules on a Sun Fire V440 server are *not* hot-pluggable.

---

The UltraSPARC IIIi processor is a high-performance, highly integrated superscalar processor implementing the SPARC V9 64-bit architecture. The UltraSPARC IIIi processor can support both 2D and 3D graphics, as well as image processing, video compression and decompression, and video effects through the sophisticated Visual Instruction Set extension (Sun VIS software). The VIS software provides high levels of multimedia performance, including two streams of MPEG-2 decompression at full broadcast quality with no additional hardware support.

The Sun Fire V440 server employs a shared-memory multiprocessor architecture with all processors sharing the same physical address space. The system processors, main memory, and I/O subsystem communicate via a high-speed system interconnect bus. In a system configured with multiple CPU/memory modules, all main memory is accessible from any processor over the system bus. The main memory is logically shared by all processors and I/O devices in the system. However, memory is controlled and allocated by the CPU on its host module, that is, the DIMMs on CPU/memory module 0 are managed by CPU 0.

---

## About the Memory Modules

The Sun Fire V440 server uses 2.5-volt, high-capacity double data rate dual inline memory modules (DDR DIMMs) with error-correcting code (ECC). The system supports DIMMs with 512-Mbyte and 1-Gbyte capacities.

Each CPU/memory module contains slots for four DIMMs. Total system memory ranges from a minimum of 2 Gbytes (one CPU/memory module with four 512-Mbyte DIMMs) to a maximum of 16 Gbytes (four modules fully populated with 1-Gbyte DIMMs).

Within each CPU/memory module, the four DIMM slots are organized into groups of two. The system reads from, or writes to, both DIMMs in a group simultaneously. DIMMs, therefore, must be added in pairs. FIGURE 4-1 shows the DIMM slots and DIMM groups on a Sun Fire V440 server CPU/memory module. Adjacent slots belong to the same DIMM group. The two groups are designated 0 and 1.

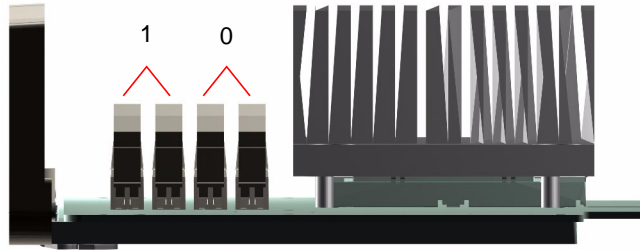

**FIGURE 4-1** Memory Module Groups 0 and 1

TABLE 4-1 lists the DIMMs on the CPU/memory module, and to which group each DIMM belongs.

**TABLE 4-1** Memory Module Groups 0 and 1

Label	Group	Physical Group
B1/D1	B1	1 (must be installed as a pair)
B1/D0		
B0/D1	B0	0 (must be installed as a pair)
B0/D0		

You must physically remove a CPU/memory module from the system before you can install or remove DIMMs. The DIMMs must be added in pairs within the same DIMM group, and each pair used must have two identical DIMMs installed—that is, both DIMMs in each group must be from the same manufacturer and must have the same density and capacity (for example, two 512-Mbyte DIMMs or two 1-Gbyte DIMMs).

---

**Note** – Each CPU/memory module must be populated with a minimum of two DIMMs, installed in either Group 0 or Group 1.

---



---

**Caution** – DIMMs are made of electronic components that are extremely sensitive to static electricity. Static from your clothes or work environment can destroy the modules. Do not remove a DIMM from its antistatic packaging until you are ready to install it on the CPU/memory module. Handle the modules only by their edges. Do not touch the components or any metal parts. Always wear an antistatic grounding strap when you handle the modules. For more information, see the *Sun Fire V440 Server Parts Installation and Removal Guide*.

---

For guidelines and complete instructions on how to install DIMMs in a CPU/memory module, see the *Sun Fire V440 Server Parts Installation and Removal Guide*.

For more information about identifying the physical DIMMs referenced in system console messages, see the *Sun Fire V440 Server Diagnostics and Troubleshooting Guide*.

## Memory Interleaving

You can maximize the system's memory bandwidth by taking advantage of its memory interleaving capabilities. The Sun Fire V440 server supports two-way interleaving. In most cases, higher interleaving results in improved system performance. However, actual performance results can vary depending on the system application. Two-way interleaving occurs automatically in any DIMM group where the DIMM capacities do not match the capacities used in any other group. For optimum performance, install identical DIMMs in all four slots in a CPU/memory module.

## Independent Memory Subsystems

Each Sun Fire V440 server CPU/memory module contains an independent memory subsystem. Memory controller logic incorporated into the UltraSPARC IIIi CPU allows each CPU to control its own memory subsystem.

The Sun Fire V440 server uses a shared memory architecture. During normal system operations, the total system memory is shared by all CPUs in the system.

## Configuration Rules

- DIMMs must be added in pairs.
- Each group used must have two identical DIMMs installed—that is, both DIMMs must be from the same manufacturer and must have the same density and capacity (for example, two 512-Mbyte DIMMs or two 1-Gbyte DIMMs).
- For maximum memory performance and to take full advantage of the Sun Fire V440 server’s memory interleaving features, use identical DIMMs in all four slots of a CPU/memory module.

---

**Note** – All internal options, except hard disk drives, must be installed only by qualified service personnel. For information about installing or removing DIMMs, see the *Sun Fire V440 Server Parts Installation and Removal Guide*.

---

---

## About the ALOM System Controller Card

The Sun Advanced Lights Out Manager (ALOM) system controller card enables access, monitoring, and control of the Sun Fire V440 server from a remote location. It is a fully independent processor card with its own resident firmware, self-diagnostics, and operating system.

In addition, the ALOM system controller card functions as the default console connection to the system, through its serial management port. For more information about using the ALOM system controller as the default console connection, see:

- “About Communicating With the System” on page 42
- “How to Use the Serial Management Port” on page 56

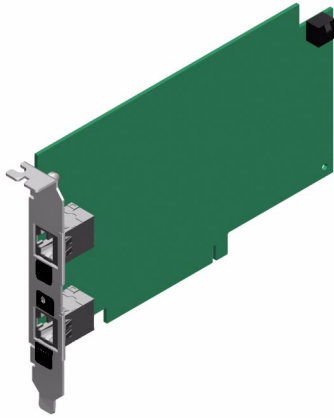

**FIGURE 4-2** ALOM System Controller Card

The ALOM system controller card features serial and 10BASE-T Ethernet interfaces that provide multiple ALOM system controller software users with simultaneous access to the Sun Fire V440 server. ALOM system controller software users are provided secure password-protected access to the system's Solaris and OpenBoot console functions. ALOM system controller users also have full control over power-on self-test (POST) and OpenBoot Diagnostics tests.



---

**Caution** – Although access to the ALOM system controller through the network management port is secure, access through the serial management port is not secure. Therefore, avoid connecting a serial modem to the serial management port.

---

---

**Note** – The ALOM system controller serial management port (labeled SERIAL MGT) and network management port (labeled NET MGT) are present in the Solaris operating environment device tree as `/dev/ttya`, and in the OpenBoot configuration variables as `ttya`. However, the serial management port does not function as a standard serial connection. If you want to attach a standard serial device to the system (such as a printer), you need to use the DB-9 connector on the system back panel, which corresponds to `/dev/ttyb` in the Solaris device tree, and as `ttyb` in the OpenBoot configuration variables. See “About the Serial Ports” on page 99 for more information.

---

The ALOM system controller card runs independently of the host server, and operates off of standby power from the server power supplies. The card features on-board devices that interface with the server environmental monitoring subsystem

and can automatically alert administrators to system problems. Together, these features enable the ALOM system controller card and ALOM system controller software to serve as a lights out management tool that continues to function even when the server operating system goes offline or when the server is powered off.

The ALOM system controller card plugs in to a dedicated slot on the motherboard and provides the following ports (as shown in FIGURE 4-3) through an opening in the system's back panel:

- Serial communication port via an RJ-45 connector (serial management port, labeled SERIAL MGT)
- 10-Mbps Ethernet port via an RJ-45 twisted-pair Ethernet (TPE) connector (network management port, labeled NET MGT) with green Link/Activity LED

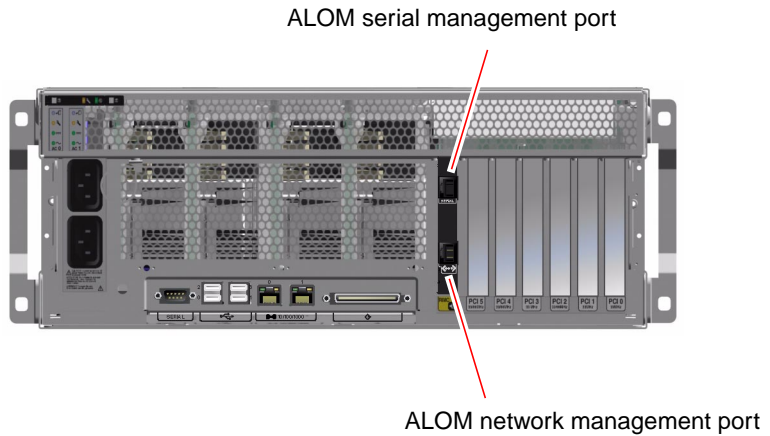

**FIGURE 4-3** ALOM System Controller Card Ports

# Configuration Rules

---



**Caution** – The system supplies power to the ALOM system controller card even when the system is powered off. To avoid personal injury or damage to the ALOM system controller card, you must disconnect the AC power cords from the system before servicing the ALOM system controller card.

---

- The ALOM system controller card is installed in a dedicated slot on the system motherboard. Never move the ALOM system controller card to another system slot, as it is *not* a PCI-compatible card.
- The ALOM system controller card is *not* a hot-pluggable component. Before installing or removing the ALOM system controller card, you must power off the system and disconnect all system power cords.
- The serial management port on the ALOM system controller cannot be used as a conventional serial port. If your configuration requires a standard serial connection, use the DB-9 port labeled “TTYB” instead.
- The 10BASE-T network management port on the ALOM system controller is reserved for use with the ALOM system controller and the system console. The network management port does not support connections to 100 Mbps or Gigabit networks. If your configuration requires a high-speed Ethernet port, use one of the Gigabit Ethernet ports instead. For information on configuring the Gigabit Ethernet ports, see Chapter 7.
- The ALOM system controller card must be installed in the system for the system to function properly.
- The ALOM system controller card is not a conventional PCI card. Do not attempt to install the ALOM system controller card into a PCI slot. In addition, do not attempt to install a PCI card into the ALOM system controller slot.

---

**Note** – All internal options, except hard disk drives, must be installed only by qualified service personnel. For information about installing or removing the ALOM system controller card, see the *Sun Fire V440 Server Parts Installation and Removal Guide*.

---



---

# About the PCI Cards and Buses

All system communication with storage peripherals and network interface devices is mediated by four buses, using two Peripheral Component Interconnect (PCI) bridge chips on the system motherboard. Each I/O bridge chip manages communication between the system main interconnect bus and two PCI buses, giving the system a total of four separate PCI buses. The four PCI buses support up to six PCI interface cards and four motherboard devices.

TABLE 4-2 describes the PCI bus characteristics and maps each bus to its associated bridge chip, integrated devices, and PCI card slots. All slots comply with PCI Local Bus Specification Revision 2.2.

---

**Note** – PCI cards in a Sun Fire V440 server are *not* hot-pluggable.

---

**TABLE 4-2** PCI Bus Characteristics, Associated Bridge Chips, Motherboard Devices, and PCI Slots

PCI Bridge	PCI Bus	Clock Rate (MHz)/ Bandwidth (bits)/ Voltage (V)	Integrated Devices	PCI Slot Number
0	PCI-1A	33 MHz/66 MHz* 64 bits 3.3V	Sun Gigabit Ethernet 1.0 (NET0)	5
0	PCI-1B	33 MHz/66 MHz 64 bits 3.3V	None	2, 4
1	PCI-2A	33 MHz 64 bits 5V	SouthBridge M1535D+ (DVD-ROM, SCC reader, USB ports, serial port (ttyb), I <sup>2</sup> C bus, system PROM)	0, 1, 3
1	PCI-2B	33 MHz/66 MHz 64 bits 3.3V	Sun Gigabit Ethernet 1.0 (NET1) LSI1030 Ultra-4 SCSI Controller	None

\* Installing a 33-MHz PCI card into a 66-MHz bus causes the bus to operate at 33 MHz.

FIGURE 4-4 shows the PCI card slots on the motherboard.

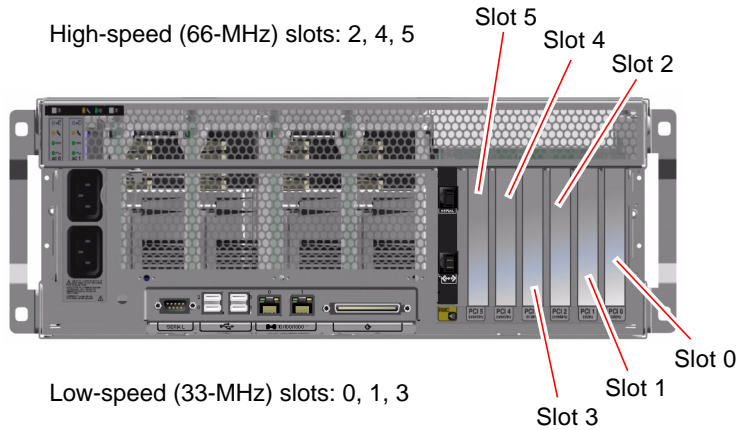

FIGURE 4-4 PCI Slots

## Configuration Rules

- All slots accept short or long PCI cards.
- 33-MHz slots accept 5V PCI cards; 66-MHz slots accept only 3.3V cards.
- All slots accept either 32-bit or 64-bit PCI cards.
- All slots comply with PCI Local Bus Specification Revision 2.2.
- All slots accept universal PCI cards.
- Each slot can supply up to 15 watts of power. The total power used for all six slots must not exceed 90 watts, in any combination of 5-volt and/or 3.3-volt cards.
- Compact PCI (cPCI) cards and SBus cards are not supported.
- You can improve overall system availability by installing redundant network or storage interfaces on separate PCI buses. For additional information, see “About Multipathing Software” on page 120.

---

**Note** – A 33-MHz PCI card plugged in to any of the 66-MHz slots causes that bus to operate at 33 MHz.

---

---

**Note** – All internal options, except hard disk drives, must be installed only by qualified service personnel. For information about installing or removing PCI cards, see the *Sun Fire V440 Server Parts Installation and Removal Guide*.

---

---

## About the Ultra-4 SCSI Controller

The Sun Fire V440 server uses an intelligent, two-channel 320-Mbyte per second Ultra-4 SCSI controller. Integrated into the motherboard, the controller resides on PCI Bus 2B and supports a 64-bit, 66-MHz PCI interface.

The on-board Ultra-4 SCSI controller provides hardware RAID mirroring (RAID 1) capability with higher performance than conventional software RAID mirroring. One pair of hard disk drives can be mirrored using the on-board Ultra-4 SCSI controller.

For more information about RAID configurations, see “About RAID Technology” on page 126. For more information about configuring hardware mirroring using the Ultra-4 SCSI controller, see “How to Create a Hardware Disk Mirror” on page 130.

---

## About the System Configuration Card

The system configuration card (SCC) contains unique network identity information, including the Ethernet MAC addresses and host ID (stored in `idprom`), the OpenBoot firmware configuration (stored in `nvr`), and ALOM system controller user and configuration data. It supplants the NVRAM module used on previous Sun systems. The SCC is housed in a slot behind the system doors, next to the system Power button (see “Locating Front Panel Features” on page 7).

A new system on the network can inherit an old system’s host ID and Ethernet MAC addresses through the old system’s SCC. Thus, migrating a SCC from one Sun Fire V440 server to another can smooth the transitions to a new or upgraded system, or quickly bring up a backup system if a primary system becomes unavailable, without disrupting the system’s identity on the network.

The system attempts to access the SCC while booting.

- The system will not power on without a properly formatted SCC present in the reader.
- If you remove the SCC while the system is running, the system will power down within 60 seconds.
- If the content of the `nvr` section is invalid, the system will be initialized with its default `nvr` configuration.
- If the content of the `idprom` section is invalid, OpenBoot firmware displays a warning message and the system will not auto-boot the Solaris software. However, you can boot the system from the `ok` prompt using the `boot` command.



---

**Caution** – Because the SCC is crucial for system operation, you must store the SCC safely if you have to remove it from the server, and replace it before restarting the server.

---

For a list of OpenBoot configuration variables stored on the SCC, see Appendix C.

For instructions on migrating a SCC from one system to another, see “How to Migrate a System Configuration Card From One System to Another System” on page 88.

---

# How to Migrate a System Configuration Card From One System to Another System

## Before You Begin

Read the section, “About the System Configuration Card” on page 87.

You can only migrate a system configuration card from one Sun Fire V440 server to another Sun Fire V440 server.

If the system configuration card needs to be replaced, you must contact a Sun service representative to obtain a new card with the server’s host ID and MAC address. Do not re-use an old SCC if you have replaced it with a new one with the same host ID and MAC address.



---

**Caution** – Do not handle the system configuration card unless you need to transfer it to another system. If you need to handle the card for this reason, avoid contact with the gold terminals on the underside of the card.

---



---

**Caution** – Never remove the system configuration card while the server is booting or running the Solaris operating environment. Either disconnect power from the server, or put the server into standby mode, before removing or inserting the SCC. If the SCC is removed while the system is running, the system will shut down if the SCC is not replaced within 60 seconds.

---

---

**Note** – All internal options, except hard disk drives, must be installed only by qualified service personnel. For information about installing or removing the system configuration card, see the *Sun Fire V440 Server Parts Installation and Removal Guide*.

---

## What to Do

- 1. Power off both servers.**

See “How to Power Off the System” on page 30.

- 2. Open the system doors on both servers.**

- 3. Remove the system configuration card from the old server and insert it into the new server.**

Be careful not to touch the metal contacts on the card.

- 4. Power on the new server.**

---

## About the Ultra-4 SCSI Backplane

The Sun Fire V440 server includes a single Ultra-4 SCSI backplane with connections for up to four internal hard disk drives, all of which are hot-pluggable.

The Ultra-4 SCSI backplane accepts four, low-profile (1.0-inch, 2.54-cm), UltraSCSI hard disk drives capable of up to 320-Mbyte per second throughput. Each hard disk drive is connected to the backplane via a standard 80-pin single connector attachment (SCA) interface. Incorporating all power and signal connections into a single connector, SCA technology makes it easy to add or remove hard disk drives from the system. Disks using SCA connectors provide better serviceability than disks using other types of connectors.

For information about installing or removing an UltraSCSI disk or disk backplane, see the *Sun Fire V440 Server Parts Installation and Removal Guide*.

## Configuration Rules

- The Ultra-4 SCSI backplane requires low-profile (1.0-inch, 2.54-cm) hard disk drives.
- The UltraSCSI disks are hot-pluggable.

---

**Note** – All internal options, except hard disk drives, must be installed only by qualified service personnel. For information about installing or removing the Ultra-4 SCSI backplane, see the *Sun Fire V440 Server Parts Installation and Removal Guide*.

---

---

## About Hot-Pluggable Components

In a Sun Fire V440 server, the hard disk drives and power supplies are *hot-pluggable* components. No other component of the system is hot-pluggable. Hot-pluggable components are those that you can install or remove while the system is running, without affecting the rest of the system's capabilities. However, you must prepare the operating system prior to the hot-plug operation by performing certain system administration tasks.

Each component is discussed in more detail in the sections that follow. Not discussed here are any devices that you can attach to the USB port, which are generally hot-pluggable.



---

**Caution** – The ALOM system controller card is *not* a hot-pluggable component. Before installing or removing an ALOM system controller card, you must power off the system and disconnect all AC power cords.

---

## Disk Drives

Sun Fire V440 server internal hard disk drives are hot-pluggable. However, certain software preparations are required prior to removing or installing a drive. To perform hard disk drive hot-plug operations, you use the Solaris `cfgadm` utility. The `cfgadm` utility is a command-line tool for managing hot-plug operations on Sun Fire V440 internal disk drives and external storage arrays. For more information about `cfgadm`, see the `cfgadm` man page.

For more information about the disk drives, see “About Internal Disk Drives” on page 91. For complete disk hot-plug procedures, see Chapter 6 and the *Sun Fire V440 Server Parts Installation and Removal Guide*.



---

**Caution** – When hot-plugging a hard disk drive, first ensure that the drive’s blue OK-to-Remove LED is lit. Then, after disconnecting the drive from the SCSI backplane, allow 30 seconds or so for the drive to spin down completely before removing it. Failing to let the drive spin down before removing it could damage the drive. For more information, see Chapter 6.

---

## Power Supplies

Sun Fire V440 server power supplies are hot-pluggable by qualified service personnel. Keep in mind that a power supply is hot-pluggable only when it is part of a redundant power configuration—a system configured with both power supplies in working condition. (Logically, you cannot hot-plug a power supply when it is the only one in the system that still works.)

---

**Note** – Two power supplies must be installed in the server to ensure proper cooling.

---

For additional information, see “About the Power Supplies” on page 93. For instructions on removing or installing power supplies, see the *Sun Fire V440 Server Parts Installation and Removal Guide*.

---

## About Internal Disk Drives

The Sun Fire V440 server supports up to four internal, hot-pluggable Ultra-4 SCSI hard disk drives, attached to a backplane. Drives are 3.5-inches wide and 1-inch high (8.89-cm x 2.54-cm). The system also includes an external Ultra-4 SCSI port. See “About the Ultra-4 SCSI Port” on page 99.

Internal disks have a storage capacity of up to 73 Gbytes each, with a rotation speed of 10,000 revolutions per minute. The maximum internal storage capacity is 292 Gbytes (using four 73-Gbyte disks), with larger capacities possible as disk storage capacities continue to grow.

The drives are supported by the 320-Mbyte per second Ultra-4 SCSI interface to the internal Ultra-4 SCSI controller on the system’s motherboard. The drives connect to the four-disk Ultra-4 SCSI backplane, which mounts to the back of the system’s disk cage.

Three LEDs are associated with each drive, indicating the drive's operating status, hot-plug readiness, and any fault conditions associated with the drive. See TABLE 1-3 for a description of these LEDs.

The following figure shows the system's four internal hard disk drives and LEDs. Disk drives are numbered 0, 1, 2, and 3, with drive 0 being the default system disk.

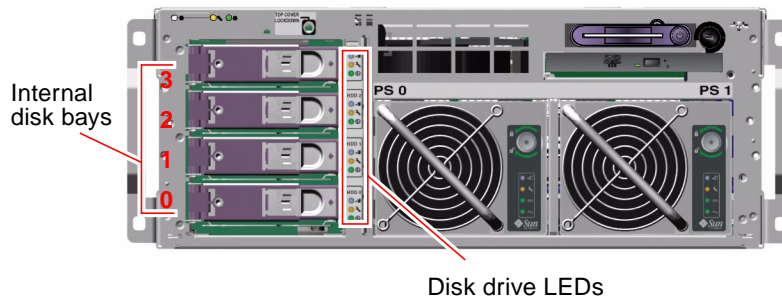

**FIGURE 4-5** Internal Drive Bay Locations

The hot-plug feature of the system's internal hard disk drives allows you to add, remove, or replace disks while the system continues to operate. This capability significantly reduces system downtime associated with hard disk drive replacement.

Disk drive hot-plug procedures involve software commands for preparing the system prior to removing a hard disk drive and for reconfiguring the operating environment after installing a drive. For detailed instructions, see Chapter 6 and the *Sun Fire V440 Server Parts Installation and Removal Guide*.

The Solaris Volume Manager software supplied as part of the Solaris operating environment lets you use internal hard disk drives in four software RAID configurations: RAID 0 (striping), RAID 1 (mirroring), RAID 0+1 (striping plus mirroring) and RAID 5 (striping with parity). You can also configure drives as *hot-spares*, disks installed and ready to operate if other disks fail. In addition, you can configure hardware mirroring using the system's Ultra-4 SCSI controller. For more information about all supported RAID configurations, see "About RAID Technology" on page 126. For more information about configuring hardware mirroring, see "How to Create a Hardware Disk Mirror" on page 130.



## Configuration Rules

- You must use Sun standard 3.5-inch wide and 1-inch high (8.89-cm x 2.54-cm) hard disk drives that are SCSI-compatible and run at 10,000 revolutions per minute (rpm). Drives must be either the single-ended or low-voltage differential (LVD) type.
- The SCSI target address (SCSI ID) of each hard disk drive is determined by the slot location where the drive is connected to the Ultra-4 SCSI backplane. There is no need to set any SCSI ID jumpers on the hard disk drives themselves.

---

## About the Power Supplies

The motherboard distributes DC power from the power supplies to all internal system components. The system's two standard power supplies—called power supply 0 and power supply 1—plug in directly to connectors on the motherboard. Both supplies share equally in satisfying the power demands of the system. AC power is brought into the system by way of two line cords between the system back panel and the motherboard.

The Sun Fire V440 server's power supplies are modular, hot-pluggable units. They are designed for fast, easy installation or removal by qualified service personnel, even while the system is fully operational. Power supplies are installed in bays at the front of the system, as shown in FIGURE 4-6.

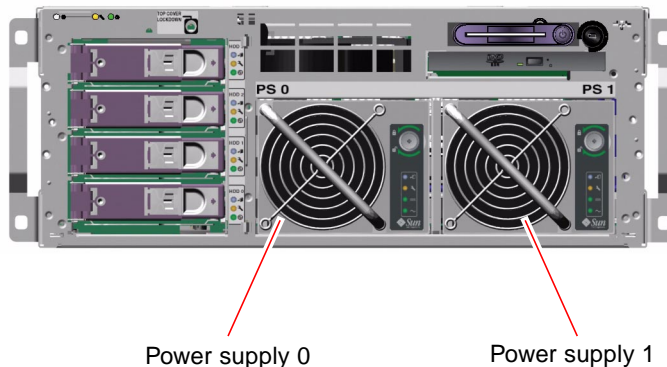

**FIGURE 4-6** Power Supply Locations

The power supplies operate over an AC input range of 100–240 VAC, 47-63 Hz. Each power supply is capable of providing up to 680 watts of DC power. The basic system configuration comes with two power supplies installed, either of which can satisfy the entire load of a fully configured system.

The power supplies provide +3.3-volt, +5-volt, +12-volt, -12-volt, and -5-volt standby outputs to the system. The +12-volt output powers point-of-load DC/DC converters that provide appropriate voltage to the system components. Output current is shared equally between both supplies via active current-sharing circuitry.

Each power supply has separate status LEDs to provide power and fault status information, and to indicate hot-plug readiness. See TABLE 1-2 for a description of power supply LEDs.

Power supplies in a redundant configuration feature a hot-plug capability. You can remove and replace a faulty power supply without shutting down the operating system or turning off the system power.

A power supply can be hot-plugged only when the other power supply is online and working properly. In addition, the cooling fans in each power supply are designed to operate independently of the power supplies. If a power supply fails, but its fans are still operable, the fans continue to operate by drawing power from the other power supply through the motherboard to provide adequate cooling to the system.

---

**Note** – You must issue a software command to prepare the power supply for removal. This allows the system to verify that the remaining power supply is online and working properly, before lighting the OK-to-Remove LED. For more information, see “How to Perform a Power Supply Hot-Plug Operation” on page 95.

---

For additional details, see “About Hot-Pluggable Components” on page 90. For information about removing and installing power supplies, see “How to Perform a Power Supply Hot-Plug Operation” on page 95, and your *Sun Fire V440 Server Parts Installation and Removal Guide*.

## Configuration Rule

- Good practice is to connect each power supply to a separate AC circuit, which enables the system to remain operational if one of the AC circuits fails. Consult your local electrical codes for any additional requirements.



---

**Caution** – If a power supply fails, leave the supply in its bay until you are ready to install a replacement. Two power supplies must be present at all times to ensure proper system cooling.

---

---

**Note** – All internal options, except hard disk drives, must be installed only by qualified service personnel. For information about installing or removing a power supply, see the *Sun Fire V440 Server Parts Installation and Removal Guide*.

---

---

## How to Perform a Power Supply Hot-Plug Operation

You must issue a software command to logically isolate the power supply before removing it.



---

**Caution** – Attempting to remove a power supply without issuing a software command to isolate it could damage the power supply.

---



---

**Caution** – Power supply hot-plug operations should only be conducted by qualified service personnel.

---

---

**Note** – In order to maintain proper system cooling, you must complete a power supply hot-plug operation within 10 minutes. Be sure that you have a replacement power supply ready before beginning the procedure.

---

## Before You Begin

Check the Service Required LEDs to verify which power supply has failed. The failed power supply will cause the amber system Service Required LED and power supply Service Required LED to light.



---

**Caution** – Do not attempt to remove a working power supply from a system if the other power supply has failed. Doing so will immediately shut down the system, and could result in loss of data.

---

To complete this procedure, you must refer to the following document:

- *Sun Fire V440 Server Parts Installation and Removal Guide*

## What to Do

1. **From the ALOM system controller prompt, type the following command:**

```
sc> removefru power-supply
```

For example:

```
sc> removefru PS1
```

This command brings power supply 1 offline. The OK-to-Remove LED on power supply 1 lights to indicate that the power supply is now offline and is ready for removal.



---

**Caution** – Do not attempt to remove a power supply if the OK-to-Remove LED is not lit.

---

2. **Remove the power supply, as described in the *Sun Fire V440 Server Parts Installation and Removal Guide*.**
3. **Install a new power supply, as described in the *Sun Fire V440 Server Parts Installation and Removal Guide*.**

The power supply OK-to-Remove LED goes out when the system detects the power supply and adds it to the device tree.

---

## About the System Fans

In addition to the power supply fans, the system is equipped with one fan (fan tray 0) for cooling disk drives and PCI cards, and two CPU/memory module blowers mounted on a fan tray (fan tray 1), for providing front-to-rear cooling of the system. The integral power supply fans provide additional cooling for the CPU/memory modules and the motherboard I/O bridge components. All fans and blowers must be present and operating to provide adequate cooling.

You must remove the top cover of the server to access the system fans. Power supplies are cooled separately, each power supply with its own internal fan.



---

**Caution** – Fans on a Sun Fire V440 server are *not* hot-pluggable. Attempting to replace a fan tray while the server is running poses an extreme risk of bodily injury, and could damage the system hardware and environmental monitoring components.

---



---

**Caution** – All fans and blowers *must* be present in the server at *all* times. After removing fan tray 0 or fan tray 1, you *must* install a replacement. In addition, the power supplies contain fans that are integral to system cooling. Failure to install a replacement system fan or power supply could lead to serious overheating and severe damage to the system. For more information, see “Environmental Monitoring and Control” on page 19 and the *Sun Fire V440 Server Parts Installation and Removal Guide*.

---



---

**Caution** – Fan trays and blowers contain sharp moving parts. Use extreme caution when servicing fan trays and blowers.

---

FIGURE 4-7 shows both system fans. For each fan in the system, the environmental monitoring subsystem monitors fan speed in revolutions per minute. The figure on the left shows fan tray 0, which cools the Ultra-4 SCSI backplane, hard disk drives, and PCI cards. The figure on the right shows fan tray 1, which cools the CPU/memory modules.

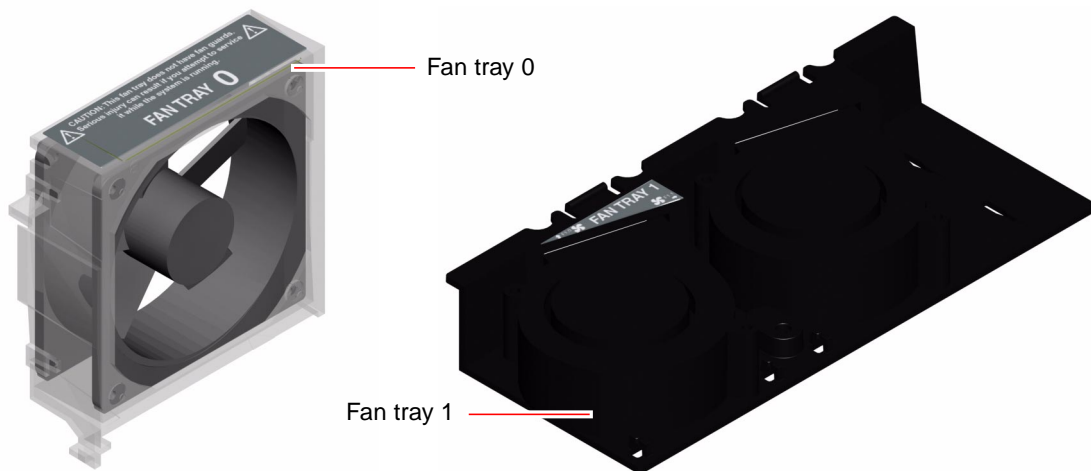

**FIGURE 4-7** Fan Tray 0 and Fan Tray 1

The system Service Required LED lights when a fault is detected in either system fan. The environmental subsystem monitors all fans and blowers in the system, and prints a warning and lights the system Service Required LED if any fan or blower falls below its nominal operating speed. This provides an early warning to an impending fan or blower failure, allowing you to schedule downtime for replacement before an overtemperature condition shuts down the system unexpectedly.

In addition, the environmental subsystem prints a warning and lights the system Service Required LED if internal temperature rises above a predetermined threshold, either due to fan failure or external environmental conditions. For additional details, see the *Sun Fire V440 Server Diagnostics and Troubleshooting Guide*.

## Configuration Rule

- The minimum system configuration requires both system fans operating—fan tray 0 for the UltraSCSI hard disk drives and PCI cards, and fan tray 1 for the CPU/memory modules.

---

**Note** – All internal components, except hard disk drives, must be installed and serviced only by qualified service personnel. For information about installing or removing system fans, see the *Sun Fire V440 Server Parts Installation and Removal Guide*.

---

---

## About the Serial Ports

The default console connection to the Sun Fire V440 server is through the RJ-45 serial management port (labeled SERIAL MGT) on the back panel of the ALOM system controller card. This port operates only at 9600 baud.

---

**Note** – The serial management port is not a standard serial port. For standard serial functionality, use the DB-9 port on the system back panel, which corresponds to `ttyb`.

---

The system also provides a standard serial communication port through a DB-9 port (labeled 10101) located on the back panel. This port corresponds to `ttyb`, and supports baud rates of 50, 75, 110, 134, 150, 200, 300, 600, 1200, 1800, 2400, 4800, 9600, 19200, 38400, 57600, 115200, 153600, 230400, 307200, and 460800. The port is accessible by connecting a serial cable to the back panel serial port connector.

For the serial port location, see “Locating Back Panel Features” on page 15. Also see “Reference for the Serial Port Connector” on page 152. For more information about the serial management port, see Chapter 3.

---

## About the Ultra-4 SCSI Port

The system includes a dedicated external Ultra-4 SCSI port. The port provides a standard 68-pin, alternative 2 shielded connection, located on the back panel. The port is accessible by connecting a SCSI cable to the Ultra-4 SCSI connector. The port supports external storage devices capable of data transfer rates up to 320 Mbytes per second.

For the Ultra-4 SCSI port location, see “Locating Back Panel Features” on page 15. Also see “Reference for the Ultra-4 SCSI Connector” on page 157.

---

## About the USB Ports

The system back panel provides four external Universal Serial Bus (USB) ports on two independent controllers to connect USB peripheral devices such as:

- Sun Type-6 USB keyboard
- Sun opto-mechanical three-button USB mouse
- Modems
- Printers
- Scanners
- Digital cameras

The USB ports are compliant with the Open Host Controller Interface (Open HCI) specification for USB Revision 1.1. The ports support isochronous and asynchronous modes, and enable data transmission at speeds of 1.5 Mbps and 12 Mbps. Note that the USB data transmission speed is significantly faster than that of the standard serial ports, which operate at a maximum rate of 460.8 Kbaud.

The USB ports are accessible by connecting a USB cable to a back panel USB connector. The connectors at each end of a USB cable are keyed so that you cannot connect them incorrectly. One connector plugs in to the system or USB hub. The other connector plugs in to the peripheral device. Up to 126 USB devices can be connected to each controller simultaneously, through the use of USB hubs. The USB ports provide power for smaller USB devices such as modems. Larger USB devices, such as scanners, require their own power source.

For the USB port locations, see “Locating Back Panel Features” on page 15. Also see “Reference for the USB Connectors” on page 153.

## Configuration Rules

- USB ports support hot-plugging. You can connect and disconnect the USB cable and peripheral devices while the system is running, without affecting system operations. However, you can only perform USB hot-plug operations while the operating system is running.
- USB hot-plug operations are not supported when the system ok prompt is displayed or before the system has completed booting.
- You can connect up to 126 devices to each of the two USB controllers, for a total of 252 USB devices per system.



# Managing RAS Features and System Firmware

---

This chapter describes how to manage reliability, availability, and serviceability (RAS) features and system firmware, including Sun Advanced Lights Out Manager (ALOM) system controller, automatic system recovery (ASR), and the hardware watchdog mechanism. In addition, this chapter describes how to unconfigure and reconfigure a device manually, and introduces multipathing software.

This chapter contains the following sections:

- “About the ALOM System Controller Command Prompt” on page 102
- “How to Log In to the ALOM System Controller” on page 102
- “About the `scadm` Utility” on page 104
- “How to View Environmental Information” on page 105
- “How to Control the Locator LED” on page 106
- “About Performing OpenBoot Emergency Procedures” on page 107
- “About Automatic System Recovery” on page 110
- “How to Enable Automatic System Recovery” on page 113
- “How to Disable Automatic System Recovery” on page 114
- “How to Obtain Automatic System Recovery Information” on page 115
- “How to Unconfigure a Device Manually” on page 116
- “How to Reconfigure a Device Manually” on page 118
- “How to Enable the Hardware Watchdog Mechanism and Its Options” on page 119
- “About Multipathing Software” on page 120

---

**Note** – This chapter does not cover detailed troubleshooting and diagnostic procedures. For information about fault isolation and diagnostic procedures, see the *Sun Fire V440 Server Diagnostics and Troubleshooting Guide*.

---

---

# About the ALOM System Controller Command Prompt

The ALOM system controller supports a total of five concurrent sessions per server: four connections available through the network management port and one connection through the serial management port.

---

**Note** – Some of the ALOM system controller commands are also available through the Solaris `scadm` utility. For more information, see the *Sun Advanced Lights Out Manager (ALOM) Online Help*.

---

After you log in to your ALOM account, the ALOM system controller command prompt (`sc>`) appears, and you can enter ALOM system controller commands. If the command you want to use has multiple options, you can either enter the options individually or grouped together, as shown in the following example. The commands are identical.

```
sc> poweroff -f -y
sc> poweroff -fy
```

---

# How to Log In to the ALOM System Controller

## Before You Begin

All environmental monitoring and control is handled by the ALOM system controller. The ALOM system controller command prompt (`sc>`) provides you with a way of interacting with the system controller. For more information about the `sc>` prompt, see:

- “About the `sc>` Prompt” on page 48

For instructions on connecting to the ALOM system controller, see:

- “How to Use the Serial Management Port” on page 56
- “How to Activate the Network Management Port” on page 58

## What to Do

---

**Note** – This procedure assumes that the system console is directed to use the serial management and network management ports (the default configuration).

---

1. **If you are logged in to the system console, type #. to get to the `sc>` prompt.**

Press the pound sign key, followed by the period key. Then press the Return key.

2. **At the login prompt, enter the login name and press Return.**

The default login name is `admin`.

```
Sun(tm) Advanced Lights Out Manager 1.1

Please login: admin
```

3. **At the password prompt, enter the password and press Return twice to get to the `sc>` prompt.**

```
Please Enter password:

sc>
```

---

**Note** – There is no default password. You must assign a password during initial system configuration. For more information, see your *Sun Fire V440 Server Installation Guide* and *Sun Advanced Lights Out Manager (ALOM) Online Help*.

---



---

**Caution** – In order to provide optimum system security, best practice is to change the default system login name and password during initial setup.

---

## What Next

Using the ALOM system controller, you can monitor the system, turn the Locator LED on and off, or perform maintenance tasks on the ALOM system controller card itself. For more information, see:

- *Sun Advanced Lights Out Manager (ALOM) Online Help*

---

## About the `scadm` Utility

The System Controller Administration (`scadm`) utility, which is part of the Solaris operating environment, enables you to perform many ALOM tasks while logged in to the host server. The `scadm` commands control several functions. Some functions allow you to view or set ALOM environment variables.

---

**Note** – Do not use the `scadm` utility while SunVTS diagnostics are running. See your Sun VTS documentation for more information.

---

You must be logged in to the system as root to use the `scadm` utility. The `scadm` utility uses the following syntax:

```
# scadm command
```

The `scadm` utility sends its output to `stdout`. You can also use `scadm` in scripts to manage and configure ALOM from the host system.

For more information about the `scadm` utility, refer to the following:

- `scadm` man page
- *Sun Advanced Lights Out Manager (ALOM) Online Help*

---

# How to View Environmental Information

## What to Do

1. Log in to the ALOM system controller.
2. Use the `showenvironment` command to display a snapshot of the server's environmental status.

```
sc> showenvironment

===== Environmental Status =====

-----
System Temperatures (Temperatures in Celsius):
-----
Sensor           Status   Temp LowHard LowSoft LowWarn HighWarn HighSoft HighHard
-----
C0.P0.T_CORE     OK       43   -20   -10    0     97     102    120
C1.P0.T_CORE     OK       50   -20   -10    0     97     102    120
C2.P0.T_CORE     OK       48   -20   -10    0     97     102    120
C3.P0.T_CORE     OK       51   -20   -10    0     97     102    120
C0.T_AMB         OK       26   -20   -10    0     60      65     75
C1.T_AMB         OK       26   -20   -10    0     60      65     75
C2.T_AMB         OK       25   -20   -10    0     60      65     75
C3.T_AMB         OK       26   -20   -10    0     50      55     70
SCSIBP.T_AMB     OK       23   -19   -11    0     65      75     85
MB.T_AMB         OK       27   -18   -10    0     65      75     85

.....
```

The information this command can display includes temperature, power supply status, front panel LED status, system control keyswitch position, and so on. The display uses a format similar to that of the UNIX command `prtdiag(1m)`.

---

**Note** – Some environmental information might not be available when the server is in standby mode.

---

---

**Note** – You do not need ALOM system controller user permissions to use this command.

---

The `showenvironment` command has one option: `-v`. If you use this option, ALOM returns more detailed information about the host server's status, including warning and shutdown thresholds.

---

## How to Control the Locator LED

You can control the Locator LED either from the Solaris command prompt or from the `sc>` prompt.

### What to Do

To turn on the Locator LED, do one of the following:

- **In the Solaris operating environment, log as root and type the following command:**

```
# /usr/sbin/setlocator -n
Locator LED is on.
```

- **From the ALOM system controller command prompt, type:**

```
sc> setlocator on
Locator LED is on.
```

To turn off the Locator LED, do one of the following:

- **In the Solaris operating environment, log in as root and type the following command:**

```
# /usr/sbin/setlocator -f
Locator LED is off.
```

- From the ALOM system controller command prompt, type:

```
sc> setlocator off  
Locator LED is off.
```

To display the state of the Locator LED, do one of the following:

- In the Solaris operating environment, log in as root and type the following command:

```
# /usr/sbin/showlocator  
Locator LED is on.
```

- From the ALOM system controller command prompt, type:

```
sc> showlocator  
Locator LED is on.
```

---

**Note** – You do not need user permissions to use the `setlocator` and `showlocator` commands.

---

---

## About Performing OpenBoot Emergency Procedures

The introduction of Universal Serial Bus (USB) keyboards with the newest Sun systems has made it necessary to change some of the OpenBoot emergency procedures. Specifically, the Stop-N, Stop-D, and Stop-F commands that were available on systems with non-USB keyboards are not supported on systems that use USB keyboards, such as the Sun Fire V440 server. If you are familiar with the earlier (non-USB) keyboard functionality, this section describes the analogous OpenBoot emergency procedures available in newer systems that use USB keyboards.

# OpenBoot Emergency Procedures for Systems With Non-USB Keyboards

TABLE 5-1 summarizes the Stop key command functions for systems that use standard (non-USB) keyboards.

**TABLE 5-1** Stop Key Command Functions for Systems With Standard (Non-USB) Keyboards

Standard (Non-USB) Keyboard Command	Description
Stop	Bypass POST. This command does not depend on security mode.
Stop-A	Abort.
Stop-D	Enter the diagnostic mode (set <code>diag-switch?</code> to true).
Stop-F	Enter Forth on <code>ttya</code> instead of probing. Use <code>fexit</code> to continue with the initialization sequence. Useful when there is a hardware problem.
Stop-N	Reset OpenBoot configuration variables to their default values.

# OpenBoot Emergency Procedures for Systems With USB Keyboards

The following sections describe how to perform the functions of the Stop commands on systems that use USB keyboards, such as the Sun Fire V440 server. These same functions are available through Sun Advanced Lights Out Manager (ALOM) system controller software.

## Stop-A Functionality

Stop-A (Abort) key sequence works the same as it does on systems with standard keyboards, except that it does not work during the first few seconds after the server is reset. In addition, you can issue the ALOM system controller break command. For more information, see “Ways of Reaching the ok Prompt” on page 50.



## Stop-N Functionality

Stop-N functionality is not available. However, the Stop-N functionality can be closely emulated by completing the following steps, provided the system console is configured to be accessible using either the serial management port or the network management port.

1. **Log in to the ALOM system controller.**
2. **Type the following command:**

```
sc> bootmode reset_nvram
sc>
SC Alert: SC set bootmode to reset_nvram, will expire
20030218184441.
bootmode
Bootmode: reset_nvram
Expires TUE FEB 18 18:44:41 2003
```

This command resets the default OpenBoot configuration variables.

3. **To reset the system, type the following command:**

```
sc> reset
Are you sure you want to reset the system [y/n]? y
sc> console
```

4. **To view console output as the system boots with default OpenBoot configuration variables, switch to console mode.**

```
sc> console

ok
```

5. **Type `set-defaults` to discard any customized IDPROM values and to restore the default settings for all OpenBoot configuration variables.**

## Stop-F Functionality

The Stop-F functionality is not available on systems with USB keyboards.

## Stop-D Functionality

The Stop-D (Diags) key sequence is not supported on systems with USB keyboards. However, the Stop-D functionality can be closely emulated by turning the system control keyswitch to the Diagnostics position. For more information, see “System Control Keyswitch” on page 12.

In addition, you can emulate Stop-D functionality using the ALOM system controller `bootmode diag` command. For more information, see the *Sun Advanced Lights Out Manager (ALOM) Online Help*.

---

## About Automatic System Recovery

The system provides for automatic system recovery (ASR) from failures in memory modules or PCI cards.

Automatic system recovery functionality enables the system to resume operation after experiencing certain nonfatal hardware faults or failures. When ASR is enabled, the system’s firmware diagnostics automatically detect failed hardware components. An auto-configuring capability designed into the OpenBoot firmware enables the system to unconfigure failed components and to restore system operation. As long as the system is capable of operating without the failed component, the ASR features enable the system to reboot automatically, without operator intervention.

---

**Note** – ASR is not activated until you enable it. See “How to Enable Automatic System Recovery” on page 113.

---

For more information about ASR, see the *Sun Fire V440 Server Diagnostics and Troubleshooting Guide*.

## Auto-Boot Options

The OpenBoot firmware stores a configuration variable on the system configuration card (SCC) called `auto-boot?`, which controls whether the firmware will automatically boot the operating system after each reset. The default setting for Sun platforms is `true`.

Normally, if a system fails power-on diagnostics, then `auto-boot?` is ignored and the system does not boot unless an operator boots the system manually. A manual boot is obviously not acceptable for booting a system in a degraded state. Therefore, the Sun Fire V440 server OpenBoot firmware provides a second setting,

`auto-boot-on-error?`. This setting controls whether the system will attempt a degraded boot when a subsystem failure is detected. Both the `auto-boot?` and `auto-boot-on-error?` switches must be set to `true` to enable an automatic degraded boot. To set the switches, type:

```
ok setenv auto-boot? true
ok setenv auto-boot-on-error? true
```

---

**Note** – The default setting for `auto-boot-on-error?` is `false`. Therefore, the system will not attempt a degraded boot unless you change this setting to `true`. In addition, the system will not attempt a degraded boot in response to any fatal nonrecoverable error, even if degraded booting is enabled. For examples of fatal nonrecoverable errors, see “Error Handling Summary” on page 111.

---

## Error Handling Summary

Error handling during the power-on sequence falls into one of the following three cases:

- If no errors are detected by POST or OpenBoot Diagnostics, the system attempts to boot if `auto-boot?` is `true`.
- If only nonfatal errors are detected by POST or OpenBoot Diagnostics, the system attempts to boot if `auto-boot?` is `true` and `auto-boot-on-error?` is `true`. Nonfatal errors include the following:
  - Ultra-4 SCSI subsystem failure. In this case, a working alternate path to the boot disk is required. For more information, see “About Multipathing Software” on page 120.
  - Ethernet interface failure.
  - USB interface failure.
  - Serial interface failure.
  - PCI card failure.
  - Memory failure. Given a failed DIMM, the firmware will unconfigure the entire logical bank associated with the failed module. Another nonfailing logical bank must be present in the system for the system to attempt a degraded boot. For more information, see “About the Memory Modules” on page 78.

---

**Note** – If POST or OpenBoot Diagnostics detects a nonfatal error associated with the normal boot device, the OpenBoot firmware automatically unconfigures the failed device and tries the next-in-line boot device, as specified by the `diag-device` configuration variable.

---

- If a fatal error is detected by POST or OpenBoot Diagnostics, the system does not boot regardless of the settings of `auto-boot?` or `auto-boot-on-error?`. Fatal nonrecoverable errors include the following:
  - Any CPU failed
  - All logical memory banks failed
  - Flash RAM cyclical redundancy check (CRC) failure
  - Critical field-replaceable unit (FRU) PROM configuration data failure
  - Critical system configuration card (SCC) read failure
  - Critical application-specific integrated circuit (ASIC) failure

For more information about troubleshooting fatal errors, see the *Sun Fire V440 Server Diagnostics and Troubleshooting Guide*.

## Reset Scenarios

Three OpenBoot configuration variables, `diag-switch?`, `obdiag-trigger`, and `post-trigger`, control whether the system runs firmware diagnostics in response to system reset events.

The standard system reset protocol bypasses POST and OpenBoot Diagnostics completely unless the variable `diag-switch?` is set to `true`, or the system control keyswitch is in the Diagnostics position. The default setting for this variable is `false`. Therefore, to enable ASR, which relies on firmware diagnostics to detect faulty devices, you must change this setting to `true`. For instructions, see “How to Enable Automatic System Recovery” on page 113.

To control which reset events, if any, automatically initiate firmware diagnostics, the OpenBoot firmware provides variables called `obdiag-trigger` and `post-trigger`. For detailed explanations of these variables and their uses, see the *Sun Fire V440 Server Diagnostics and Troubleshooting Guide*.

# Automatic System Recovery User Commands

The OpenBoot commands `.asr`, `asr-disable`, and `asr-enable` are available for obtaining ASR status information and for manually unconfiguring or reconfiguring system devices. For more information, see:

- “How to Unconfigure a Device Manually” on page 116
- “How to Reconfigure a Device Manually” on page 118
- “How to Obtain Automatic System Recovery Information” on page 115

---

## How to Enable Automatic System Recovery

The automatic system recovery (ASR) feature is not activated until you enable it at the system `ok` prompt.

### What to Do

1. At the `ok` prompt, type:

```
ok setenv diag-switch? true
ok setenv auto-boot? true
ok setenv auto-boot-on-error? true
```

2. Set the `obdiag-trigger` variable to any combination of `power-on-reset`, `error-reset`, and `user-reset`. For example, type:

```
ok setenv obdiag-trigger power-on-reset error-reset
```

---

**Note** – For more information about OpenBoot configuration variables, see the *Sun Fire V440 Server Diagnostics and Troubleshooting Guide*.

---

3. To cause the parameter changes to take effect, type:

```
ok reset-all
```

The system permanently stores the parameter changes and boots automatically when the OpenBoot configuration variable `auto-boot?` is set to `true` (its default value).

---

**Note** – To store parameter changes, you can also power cycle the system using the front panel Power button.

---

## What Next

To disable ASR, complete this task:

- “How to Disable Automatic System Recovery” on page 114

---

# How to Disable Automatic System Recovery

After you disable the automatic system recovery (ASR) feature, it is not activated again until you enable it at the system ok prompt.

## What to Do

1. At the `ok` prompt, type:

```
ok setenv auto-boot-on-error? false
```

2. To cause the parameter change to take effect, type:

```
ok reset-all
```

The system permanently stores the parameter change.

---

**Note** – To store parameter changes, you can also power cycle the system using the front panel Power button.

---

---

# How to Obtain Automatic System Recovery Information

Use the following procedure to retrieve information about the status of the automatic system recovery (ASR) feature.

## What to Do

- At the `ok` prompt, type:

```
ok .asr
```

In the `.asr` command output, any devices marked `disabled` have been manually unconfigured using the `asr-disable` command. The `.asr` command also lists devices that have failed firmware diagnostics and have been automatically unconfigured by the OpenBoot ASR feature.

## What Next

For more information, see:

- “About Automatic System Recovery” on page 110
- “How to Enable Automatic System Recovery” on page 113
- “How to Disable Automatic System Recovery” on page 114
- “How to Unconfigure a Device Manually” on page 116
- “How to Reconfigure a Device Manually” on page 118

---

# How to Unconfigure a Device Manually

To support a degraded boot capability, the OpenBoot firmware provides the `asr-disable` command, which enables you to unconfigure system devices manually. This command “marks” a specified device as *disabled*, by creating an appropriate *status* property in the corresponding device tree node. By convention, the Solaris operating environment does not activate a driver for any device so marked.

## What to Do

### 1. At the `ok` prompt, type:

```
ok asr-disable device-identifier
```

where the *device-identifier* is one of the following:

- Any full physical device path as reported by the OpenBoot `show-devs` command
- Any valid device alias as reported by the OpenBoot `devalias` command
- Any device identifier from the following table

---

**Note** – The device identifiers are not case-sensitive. You can type them as uppercase or lowercase characters.

---

Device Identifiers	Devices
<code>cpu0-bank0, cpu0-bank1, cpu0-bank2, cpu0-bank3, ... cpu3-bank0, cpu3-bank1, cpu3-bank2, cpu3-bank3</code>	Memory banks 0 – 3 for each CPU
<code>cpu0-bank*, cpu1-bank*, ... cpu3-bank*</code>	All memory banks for each CPU
<code>ob-ide</code>	On-board IDE controller
<code>ob-net0, ob-net1</code>	On-board Ethernet controllers
<code>ob-scsi</code>	On-board Ultra-4 SCSI controller
<code>pci-slot0, pci-slot1, ... pci-slot5</code>	PCI slots 0 – 5
<code>pci-slot*</code>	All PCI slots
<code>pci*</code>	All on-board PCI devices (on-board Ethernet, Ultra-4 SCSI) and all PCI slots



---

Device Identifiers (Continued)	Devices (Continued)
hba8, hba9	PCI bridge chips 0 and 1, respectively
ob-usb0, ob-usb1	USB devices
*	All devices

---

You can determine full physical device paths by typing:

```
ok show-devs
```

The `show-devs` command lists the system devices and displays the full path name of each device.

You can display a list of current device aliases by typing:

```
ok devalias
```

You can also create your own device alias for a physical device by typing:

```
ok devalias alias-name physical-device-path
```

where *alias-name* is the alias that you want to assign, and *physical-device-path* is the full physical device path for the device.

---

**Note** – If you manually disable a device using `asr-disable`, and then assign a different alias to the device, the device remains disabled even though the device alias has changed.

---

## 2. To cause the parameter change to take effect, type:

```
ok reset-all
```

The system permanently stores the parameter change.

---

**Note** – To store parameter changes, you can also power cycle the system using the front panel Power button.

---

## What Next

To reconfigure a device manually, complete this task:

- “How to Reconfigure a Device Manually” on page 118

---

## How to Reconfigure a Device Manually

You can use the OpenBoot `asr-enable` command to reconfigure any device that you previously unconfigured with the `asr-disable` command.

### What to Do

1. At the `ok` prompt, type:

```
ok asr-enable device-identifier
```

where the *device-identifier* is one of the following:

- Any full physical device path as reported by the OpenBoot `show-devs` command
- Any valid device alias as reported by the OpenBoot `devalias` command
- Any device identifier from the following table

---

**Note** – The device identifiers are not case-sensitive. You can type them as uppercase or lowercase characters.

---

Device Identifiers	Devices
<code>cpu0-bank0</code> , <code>cpu0-bank1</code> , <code>cpu0-bank2</code> , <code>cpu0-bank3</code> , ... <code>cpu3-bank0</code> , <code>cpu3-bank1</code> , <code>cpu3-bank2</code> , <code>cpu3-bank3</code>	Memory banks 0 – 3 for each CPU
<code>cpu0-bank*</code> , <code>cpu1-bank*</code> , ... <code>cpu3-bank*</code>	All memory banks for each CPU
<code>ob-ide</code>	On-board IDE devices
<code>ob-net0</code> , <code>ob-net1</code>	On-board Ethernet controllers
<code>ob-scsi</code>	On-board Ultra-4 SCSI controller
<code>pci-slot0</code> , <code>pci-slot1</code> , ... <code>pci-slot5</code>	PCI slots 0 – 5
<code>pci-slot*</code>	All PCI slots
<code>pci*</code>	All on-board PCI devices (on-board Ethernet, Ultra-4 SCSI) and all PCI slots

Device Identifiers (Continued)	Devices (Continued)
hba8, hba9	PCI bridge chips 0 and 1, respectively
ob-usb0, ob-usb1	USB devices
*	All devices

# How to Enable the Hardware Watchdog Mechanism and Its Options

## Before You Begin

For background information about the hardware watchdog mechanism and related externally initiated reset (XIR) functionality, see:

- “Hardware Watchdog Mechanism and XIR” on page 21

## What to Do

To enable the hardware watchdog mechanism:

1. Edit the `/etc/system` file to include the following entry:

```
set watchdog_enable = 1
```

2. Bring the system to the `ok` prompt by typing the following:

```
# init 0
```

3. Reboot the system so that the changes can take effect.

To have the hardware watchdog mechanism automatically reboot the system in case of system hangs:

- At the `ok` prompt, type the following:

```
ok setenv error-reset-recovery = boot
```

To generate automated crash dumps in case of system hangs:

- **At the `ok` prompt, type the following:**

```
ok setenv error-reset-recovery = none
```

The `sync` option leaves you at the `ok` prompt in order to debug the system. For more information about OpenBoot configuration variables, see Appendix C.

---

## About Multipathing Software

Multipathing software lets you define and control redundant physical paths to I/O devices, such as storage devices and network interfaces. If the active path to a device becomes unavailable, the software can automatically switch to an alternate path to maintain availability. This capability is known as *automatic failover*. To take advantage of multipathing capabilities, you must configure the server with redundant hardware, such as redundant network interfaces or two host bus adapters connected to the same dual-ported storage array.

For the Sun Fire V440 server, three different types of multipathing software are available:

- Solaris IP Network Multipathing software provides multipathing and load-balancing capabilities for IP network interfaces.
- VERITAS Volume Manager software includes a feature called Dynamic Multipathing (DMP), which provides disk multipathing as well as disk load balancing to optimize I/O throughput.
- Sun StorEdge Traffic Manager is an architecture fully integrated within the Solaris operating environment (beginning with the Solaris 8 release) that enables I/O devices to be accessed through multiple host controller interfaces from a single instance of the I/O device.

## For More Information

For information about setting up redundant hardware interfaces for networks, see “About Redundant Network Interfaces” on page 142.

For instructions on how to configure and administer Solaris IP Network Multipathing, consult the *IP Network Multipathing Administration Guide* provided with your specific Solaris release.

For information about VERITAS Volume Manager and its DMP feature, see “About Volume Management Software” on page 124 and refer to the documentation provided with the VERITAS Volume Manager software.

For information about Sun StorEdge Traffic Manager, see “Sun StorEdge Traffic Manager” on page 21 and refer to your Solaris operating environment documentation.



## Managing Disk Volumes

---

This chapter describes redundant array of independent disks (RAID) concepts, how to manage disk volumes, and how to configure hardware mirroring using the on-board Ultra-4 SCSI controller.

This chapter contains the following sections:

- “About Disk Volumes” on page 123
- “About Volume Management Software” on page 124
- “About RAID Technology” on page 126
- “About Hardware Disk Mirroring” on page 128
- “Reference for Physical Disk Slot Numbers, Physical Device Names, and Logical Device Names” on page 129
- “How to Create a Hardware Disk Mirror” on page 130
- “How to Delete a Hardware Disk Mirror” on page 132
- “How to Perform a Mirrored Disk Hot-Plug Operation” on page 133
- “How to Perform a Non-Mirrored Disk Hot-Plug Operation” on page 136

---

### About Disk Volumes

*Disk volumes* are logical disk devices comprising one or more physical disks or partitions from several different disks.

Once you create a volume, the operating system uses and maintains the volume as if it were a single disk. By providing this logical volume management layer, the software overcomes the restrictions imposed by physical disk devices.

Sun's volume management products also provide RAID data redundancy and performance features. RAID is a technology that helps protect against disk and hardware failures. Through RAID technology, volume management software is able to provide high data availability, excellent I/O performance, and simplified administration.

---

## About Volume Management Software

Volume management software lets you create disk volumes. Sun Microsystems offers two different volume management applications for use on the Sun Fire V440 server:

- VERITAS Volume Manager software
- Solaris Volume Manager software

Sun's volume management applications offer the following features:

- Support for several types of RAID configurations, which provide varying degrees of availability, capacity, and performance
- Hot-spare facilities, which provide for automatic data recovery when disks fail
- Performance analysis tools, which enable you to monitor I/O performance and isolate bottlenecks
- A graphical user interface (GUI), which simplifies storage management
- Support for online resizing, which enables volumes and their file systems to grow and shrink online
- Online reconfiguration facilities, which let you change to a different RAID configuration or modify characteristics of an existing configuration

## VERITAS Dynamic Multipathing

VERITAS Volume Manager software actively supports multiported disk arrays. It automatically recognizes multiple I/O paths to a particular disk device within an array. Called Dynamic Multipathing (DMP), this capability provides increased reliability by providing a path failover mechanism. If one connection to a disk is lost, VERITAS Volume Manager continues to access the data over the remaining connections. This multipathing capability also provides greater I/O throughput by automatically balancing the I/O load uniformly across multiple I/O paths to each disk device.



# Sun StorEdge Traffic Manager

A newer alternative to DMP that is also supported by the Sun Fire V440 server is Sun StorEdge Traffic Manager software. Sun StorEdge Traffic Manager is a server-based dynamic path failover software solution, used to improve the overall availability of business applications. Sun StorEdge Traffic Manager (previously known as multiplexed input/output, or MPxIO) is included in the Solaris operating environment.

The Sun StorEdge Traffic Manager software integrates multiple path I/O capabilities, automatic load balancing, and path failover functions into one package for Sun servers connected to supported Sun StorEdge systems. Sun StorEdge Traffic Manager can provide you with increased system performance and availability for building mission-critical storage area networks (SANs).

The Sun StorEdge Traffic Manager architecture provides the following capabilities:

- Helps protect against I/O outages due to I/O controller failures. Should one I/O controller fail, Sun StorEdge Traffic Manager automatically switches to an alternate controller.
- Increases I/O performance by load balancing across multiple I/O channels.

Sun StorEdge T3, Sun StorEdge 3510, and Sun StorEdge A5x00 storage arrays are all supported by Sun StorEdge Traffic Manager on a Sun Fire V440 server. Supported I/O controllers are single and dual fibre-channel network adapters, including the following:

- PCI Single Fibre-Channel Host Adapter (Sun part number x6799A)
- PCI Dual Fibre-Channel Network Adapter (Sun part number x6727A)
- 2GByte PCI Single Fibre-Channel Host Adapter (Sun part number x6767A)
- 2GByte PCI Dual Fibre-Channel Network Adapter (Sun part number x6768A)

---

**Note** – Sun StorEdge Traffic Manager is not supported for boot disks containing the root (/) file system. You can use hardware mirroring or VERITAS Volume Manager instead. See “How to Create a Hardware Disk Mirror” on page 130 and “About Volume Management Software” on page 124.

---

## For More Information

See the documentation supplied with the VERITAS Volume Manager and Solaris Volume Manager software. For more information about Sun StorEdge Traffic Manager, see your Solaris system administration documentation.

---

# About RAID Technology

VERITAS Volume Manager and Solstice DiskSuite software support RAID technology to optimize performance, availability, and cost per user. RAID technology reduces recovery time in the event of file system errors, and increases data availability even in the event of a disk failure. There are several levels of RAID configurations that provide varying degrees of data availability with corresponding trade-offs in performance and cost.

This section describes some of the most popular and useful of those configurations, including:

- Disk concatenation
- Disk striping (RAID 0)
- Disk mirroring (RAID 1)
- Disk striping with parity (RAID 5)
- Hot-spares

## Disk Concatenation

Disk concatenation is a method for increasing logical volume size beyond the capacity of one disk drive by creating one large volume from two or more smaller drives. This lets you create arbitrarily large partitions.

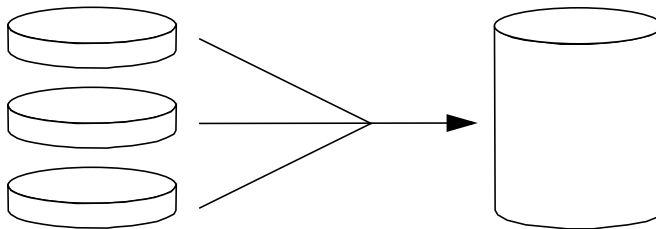

Using this method, the concatenated disks are filled with data sequentially, with the second disk being written to when no space remains on the first, the third when no space remains on the second, and so on.

## RAID 0: Disk Striping

Disk striping (RAID 0) is a technique for increasing system throughput by using several disk drives in parallel. Whereas in non-striped disks the operating system writes a single block to a single disk, in a striped arrangement, each block is divided and portions of the data are written to different disks simultaneously.

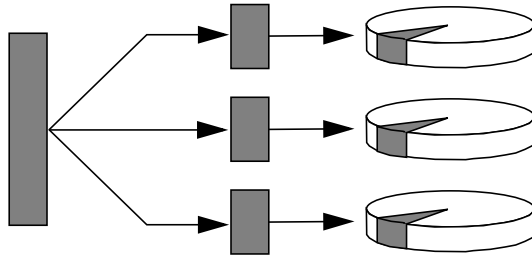

System performance using RAID 0 will be better than using RAID 1 or 5, but the possibility of data loss is greater because there is no way to retrieve or reconstruct data stored on a failed disk drive.

## RAID 1: Disk Mirroring

Disk mirroring (RAID 1) is a technique that uses data redundancy—two complete copies of all data stored on two separate disks—to protect against loss of data due to disk failure. One logical volume is duplicated on two separate disks.

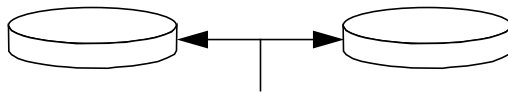

Whenever the operating system needs to write to a mirrored volume, both disks are updated. The disks are maintained at all times with exactly the same information. When the operating system needs to read from the mirrored volume, it reads from whichever disk is more readily accessible at the moment, which can result in enhanced performance for read operations.

On the Sun Fire V440 server, you can configure hardware disk mirroring using the on-board Ultra-4 SCSI controller. This provides higher performance than with conventional software mirroring using volume management software. For more information, see:

- “How to Create a Hardware Disk Mirror” on page 130
- “How to Delete a Hardware Disk Mirror” on page 132
- “How to Perform a Mirrored Disk Hot-Plug Operation” on page 133

RAID 1 offers the highest level of data protection, but storage costs are high, and write performance compared to RAID 0 or RAID 5 is reduced since all data must be stored twice.

## RAID 5: Disk Striping With Parity

RAID 5 is an implementation of disk striping in which parity information is included with each disk write. The advantage of this technique is that if any one disk in a RAID 5 array fails, all the information about the failed drive can be reconstructed from the data and parity on the remaining disks.

System performance using RAID 5 will fall between that of RAID 0 and RAID 1; however, RAID 5 provides limited data redundancy. If more than one disk fails, all data is lost.

## Hot-Spares

In a *hot-spares* arrangement, one or more disk drives are installed in the system but are unused during normal operation. This configuration is also referred to as *hot relocation*. Should one of the active drives fail, the data on the failed disk is automatically reconstructed and generated on a hot-spare disk, enabling the entire data set to maintain its availability.

---

## About Hardware Disk Mirroring

On the Sun Fire V440 server, the Ultra-4 SCSI controller supports internal hardware disk mirroring using the Solaris operating environment `raidctl` utility.

A hardware disk mirror created under the `raidctl` utility behaves slightly differently than one created using volume management software. Under a software mirror, each device has its own entry in the virtual device tree, and read/write operations are performed to both virtual devices. Under hardware disk mirroring,

only one device (the *master*) appears in the device tree. The mirrored device (the *slave*) is invisible to the operating system, and is accessed only by the Ultra-4 SCSI controller.



---

**Caution** – Creating or restoring a disk mirror destroys all data previously stored on the disk drive.

---

---

## Reference for Physical Disk Slot Numbers, Physical Device Names, and Logical Device Names

In order to perform a disk hot-plug procedure, you must know the physical or logical device name for the drive that you want to install or remove. If your system encounters a disk error, often you can find messages about failing or failed disks in the system console. This information is also logged in the `/var/adm/messages` file(s).

These error messages typically refer to a failed hard disk drive by its physical device name (such as `/devices/pci@1f,700000/scsi@2/sd@1,0`) or by its logical device name (such as `c1t1d0`). In addition, some applications might report a disk slot number (0 through 3).

You can use TABLE 6-1 to associate internal disk slot numbers with the logical and physical device names for each hard disk drive.

**TABLE 6-1** Disk Slot Numbers, Logical Device Names, and Physical Device Names

Disk Slot Number	Logical Device Name*	Physical Device Name
Slot 0	<code>c1t0d0</code>	<code>/devices/pci@1f,700000/scsi@2/sd@0,0</code>
Slot 1	<code>c1t1d0</code>	<code>/devices/pci@1f,700000/scsi@2/sd@1,0</code>
Slot 2	<code>c1t2d0</code>	<code>/devices/pci@1f,700000/scsi@2/sd@2,0</code>
Slot 3	<code>c1t3d0</code>	<code>/devices/pci@1f,700000/scsi@2/sd@3,0</code>

\* The logical device names might appear differently on your system, depending on the number and type of add-on disk controllers installed.

---

# How to Create a Hardware Disk Mirror

Perform this procedure to create an internal hardware disk mirror configuration on your system.

## Before You Begin

Verify which disk drive corresponds with which logical device name and physical device name. See:

- “Reference for Physical Disk Slot Numbers, Physical Device Names, and Logical Device Names” on page 129
- **To verify that a hardware disk mirror does not exist already, type:**

```
# raidctl
No RAID volumes found.
```

The example above indicates that no RAID volume exists. In another case:

```
# raidctl
RAID      RAID   RAID   Disk
Volume    Status Disk    Status
-----
c1t1d0    DEGRADEDc1t1d0  OK
                c1t2d0  DEGRADED
```

The example above indicates a hardware mirror has degraded at disk c1t2d0.

---

**Note** – The logical device names might appear differently on your system, depending on the number and type of add-on disk controllers installed.

---

# What to Do

## 1. Type the following command:

```
# raidctl -c master slave
```

For example:

```
# raidctl -c c1t0d0 c1t1d0
```

When you create a RAID mirror, the slave drive (in this case, `c1t1d0`) disappears from the Solaris device tree.

## 2. To check the status of a RAID mirror, type the following command:

```
# raidctl
  RAID      RAID      RAID      Disk
  Volume    Status    Disk      Status
-----
  c1t0d0    RESYNCING c1t0d0    OK
                   c1t1d0    OK
```

The example above indicates that the RAID mirror is still resynchronizing with the backup drive.

The example below shows that the RAID mirror is completely restored and online.

```
# raidctl
  RAID      RAID      RAID      Disk
  Volume    Status    Disk      Status
-----
  c1t0d0    OK       c1t0d0    OK
                   c1t1d0    OK
```

# What Next

Under RAID 1 (disk mirroring), all data is duplicated on both drives. If a disk fails, replace it with a working drive and restore the mirror. For instructions, see:

- “How to Perform a Mirrored Disk Hot-Plug Operation” on page 133

For more information about the `raidctl` utility, see the `raidctl(1M)` man page.

---

## How to Delete a Hardware Disk Mirror

Perform this procedure to remove a hardware disk mirror configuration from your system.

### Before You Begin

Verify which disk drive corresponds with which logical device name and physical device name. See:

- “Reference for Physical Disk Slot Numbers, Physical Device Names, and Logical Device Names” on page 129

### What to Do

1. Determine the name of the mirrored volume. Type the following command:

```
# raidctl
RAID      RAID      RAID      Disk
Volume    Status    Disk      Status
-----
c1t0d0    OK        c1t0d0    OK
          c1t1d0    OK
```

In this example, the mirrored volume is `c1t0d0`.

---

**Note** – The logical device names might appear differently on your system, depending on the number and type of add-on disk controllers installed.

---



2. To delete the volume, type the following command:

```
# raidctl -d mirrored-volume
```

For example:

```
# raidctl -d c1t0d0  
RAID Volume 'c1t0d0' deleted
```

3. To confirm that you have deleted the RAID array, type the following command:

```
# raidctl
```

For example:

```
# raidctl  
No RAID volumes found
```

## What Next

For more information, see the `raidctl(1M)` man page.

---

# How to Perform a Mirrored Disk Hot-Plug Operation

## Before You Begin

Verify which disk drive corresponds with which logical device name and physical device name. See:

- “Reference for Physical Disk Slot Numbers, Physical Device Names, and Logical Device Names” on page 129

You need to refer to the following document to perform this procedure:

- *Sun Fire V440 Server Parts Installation and Removal Guide*

## What to Do



---

**Caution** – Make sure that the disk drive OK-to-Remove LED is lit, indicating that the disk drive is offline. If the disk drive is still online, you risk removing the disk during a read/write operation, which could result in data loss.

---

1. To confirm a failed disk, type the following command:

```
# raidctl
```

For example:

```
# raidctl
RAID      RAID      RAID      Disk
Volume    Status    Disk      Status
-----
c1t1d0    DEGRADED  c1t1d0    OK
                   c1t2d0    DEGRADED
```

This example indicates that the disk mirror has degraded due to a failure in disk c1t2d0.

---

**Note** – The logical device names might appear differently on your system, depending on the number and type of add-on disk controllers installed.

---

2. **Remove the disk drive, as described in the *Sun Fire V440 Server Parts Installation and Removal Guide*.**

There is no need to issue a software command to bring the drive offline when the drive has failed and the OK-to-Remove LED is lit.

3. **Install a new disk drive, as described in the *Sun Fire V440 Server Parts Installation and Removal Guide*.**

The RAID utility automatically restores the data to the disk.

4. To check the status of a RAID rebuild, type the following command:

```
# raidctl
```

For example:

```
# raidctl
RAID      RAID      RAID      Disk
Volume    Status    Disk      Status
-----
c1t1d0    RESYNCING c1t1d0    OK
                   c1t2d0    OK
```

This example indicates that RAID volume `c1t1d0` is resynchronizing.

If you issue the command again some minutes later, it indicates that the RAID mirror is finished resynchronizing and is back online:

```
# raidctl
RAID      RAID      RAID      Disk
Volume    Status    Disk      Status
-----
c1t1d0    OK        c1t1d0    OK
                   c1t2d0    OK
```

## What Next

For more information, see the `raidctl(1M)` man page.

---

# How to Perform a Non-Mirrored Disk Hot-Plug Operation

## Before You Begin

Verify which disk drive corresponds with which logical device name and physical device name. See:

- “Reference for Physical Disk Slot Numbers, Physical Device Names, and Logical Device Names” on page 129

Make sure that no applications or processes are accessing the disk drive.

You need to refer to the following document to perform this procedure:

- *Sun Fire V440 Server Parts Installation and Removal Guide*
- **To view the status of the SCSI devices, type the following command:**

```
# cfgadm -al
```

For example:

```
# cfgadm -al
Ap_Id          Type          Receptacle  Occupant    Condition
c0             scsi-bus     connected   configured  unknown
c0::dsk/c0t0d0 CD-ROM       connected   configured  unknown
c1             scsi-bus     connected   configured  unknown
c1::dsk/c1t0d0 disk         connected   configured  unknown
c1::dsk/c1t1d0 disk         connected   configured  unknown
c1::dsk/c1t2d0 disk         connected   configured  unknown
c1::dsk/c1t3d0 disk         connected   configured  unknown
c2             scsi-bus     connected   configured  unknown
c2::dsk/c2t2d0 disk         connected   configured  unknown
usb0/1         unknown      empty       unconfigured ok
usb0/2         unknown      empty       unconfigured ok
usb1/1         unknown      empty       unconfigured ok
usb1/2         unknown      empty       unconfigured ok
#
```

---

**Note** – The logical device names might appear differently on your system, depending on the number and type of add-on disk controllers installed.

---

The `-al` options return the status of all SCSI devices, including buses and USB devices. (In this example, no USB devices are connected to the system.)

Note that while you can use the Solaris operating environment `cfgadm` `install_device` and `cfgadm remove_device` commands to perform a disk drive hot-plug procedure, these commands issue the following warning message when you invoke these commands on a bus containing the system disk:

```
# cfgadm -x remove_device c0::dsk/clt1d0
Removing SCSI device: /devices/pci@1f,4000/scsi@3/sd@1,0
This operation will suspend activity on SCSI bus: c0
Continue (yes/no)? y
dev = /devices/pci@1f,4000/scsi@3/sd@1,0
cfgadm: Hardware specific failure: failed to suspend:
      Resource                Information
-----
/dev/dsk/clt0d0s0    mounted filesystem "/"
/dev/dsk/clt0d0s6    mounted filesystem "/usr"
```

This warning is issued because these commands attempt to quiesce the Ultra-4 SCSI bus, but the Sun Fire V440 server firmware prevents it. This warning message can be safely ignored in the Sun Fire V440 server, but the following procedure avoids this warning message altogether.

## What to Do

1. To remove the disk drive from the device tree, type the following command:

```
# cfgadm -c unconfigure Ap-ld
```

For example:

```
# cfgadm -c unconfigure c1::dsk/clt3d0
```

This example removes `clt3d0` from the device tree. The blue OK-to-Remove LED lights.

2. To verify that the device has been removed from the device tree, type the following command:

```
# cfgadm -al
Ap_Id          Type          Receptacle  Occupant    Condition
c0             scsi-bus     connected   configured  unknown
c0::dsk/c0t0d0 CD-ROM       connected   configured  unknown
c1             scsi-bus     connected   configured  unknown
c1::dsk/c1t0d0 disk         connected   configured  unknown
c1::dsk/c1t1d0 disk         connected   configured  unknown
c1::dsk/c1t2d0 disk         connected   configured  unknown
c1::dsk/c1t3d0 unavailable  connected   unconfigured unknown
c2             scsi-bus     connected   configured  unknown
c2::dsk/c2t2d0 disk         connected   configured  unknown
usb0/1         unknown      empty       unconfigured ok
usb0/2         unknown      empty       unconfigured ok
usb1/1         unknown      empty       unconfigured ok
usb1/2         unknown      empty       unconfigured ok
#
```

Note that c1t3d0 is now unavailable and unconfigured. The corresponding disk drive OK-to-Remove LED is lit.

3. Remove the disk drive, as described in the *Sun Fire V440 Server Parts Installation and Removal Guide*.  
The blue OK-to-Remove LED goes out when you remove the disk drive.
4. Install a new disk drive, as described in the *Sun Fire V440 Server Parts Installation and Removal Guide*.
5. To configure the new disk drive, type the following command:

```
# cfgadm -c configure Ap-Id
```

For example:

```
# cfgadm -c configure c1::dsk/c1t3d0
```

The green Activity LED flashes as the new disk at c1t3d0 is added to the device tree.

6. To verify that the new disk drive is in the device tree, type the following command:

```
# cfdadm -al
Ap_Id          Type          Receptacle  Occupant    Condition
c0             scsi-bus     connected   configured  unknown
c0::dsk/c0t0d0 CD-ROM       connected   configured  unknown
c1             scsi-bus     connected   configured  unknown
c1::dsk/c1t0d0 disk         connected   configured  unknown
c1::dsk/c1t1d0 disk         connected   configured  unknown
c1::dsk/c1t2d0 disk         connected   configured  unknown
c1::dsk/c1t3d0 disk         connected   configured  unknown
c2             scsi-bus     connected   configured  unknown
c2::dsk/c2t2d0 disk         connected   configured  unknown
usb0/1         unknown      empty       unconfigured ok
usb0/2         unknown      empty       unconfigured ok
usb1/1         unknown      empty       unconfigured ok
usb1/2         unknown      empty       unconfigured ok
#
```

Note that c1t3d0 is now listed as configured.





---

# Managing Network Interfaces

---

This chapter describes how to manage network interfaces.

This chapter contains the following sections:

- “About the Network Interfaces” on page 141
  - “About Redundant Network Interfaces” on page 142
  - “How to Attach a Twisted-Pair Ethernet Cable” on page 143
  - “How to Configure the Primary Network Interface” on page 144
  - “How to Configure Additional Network Interfaces” on page 146
- 

## About the Network Interfaces

The Sun Fire V440 server provides two on-board Sun Gigabit Ethernet interfaces, which reside on the system motherboard and conform to the IEEE 802.3z Ethernet standard. For an illustration of the Ethernet ports, see FIGURE 1-4. The Ethernet interfaces operate at 10 Mbps, 100 Mbps, and 1000 Mbps.

Two back panel ports with RJ-45 connectors provide access to the on-board Ethernet interfaces. Each interface is configured with a unique Media Access Control (MAC) address. Each connector features two LEDs, as described in TABLE 1-5. Additional Ethernet interfaces or connections to other network types are available by installing the appropriate PCI interface cards.

The system’s on-board interfaces can be configured for redundancy, or an additional network interface card can serve as a redundant network interface for one of the system’s on-board interfaces. If the active network interface becomes unavailable, the system can automatically switch to the redundant interface to maintain availability. This capability is known as *automatic failover* and must be configured at the Solaris operating environment level. In addition, this configuration provides outbound data load balancing for increased performance. For additional details, see “About Redundant Network Interfaces” on page 142.

The Ethernet driver is installed automatically during the Solaris installation procedure.

For instructions on configuring the system network interfaces, see:

- “How to Configure the Primary Network Interface” on page 144
- “How to Configure Additional Network Interfaces” on page 146

---

## About Redundant Network Interfaces

You can configure your system with redundant network interfaces to provide a highly available network connection. Such a configuration relies on special Solaris software features to detect a failed or failing network interface and automatically switch all network traffic over to the redundant interface. This capability is known as automatic failover.

To set up redundant network interfaces, you can enable automatic failover between the two similar interfaces using the IP Network Multipathing feature of the Solaris operating environment. For additional details, see “About Multipathing Software” on page 120. You can also install a pair of identical PCI network interface cards, or add a single card that provides an interface identical to one of the two on-board Ethernet interfaces.

To ensure maximum redundancy, each on-board Ethernet interface resides on a different PCI bus. To help further maximize system availability, make sure that any additional network interfaces added for redundancy also reside on separate PCI buses, which are supported by separate PCI bridges. For additional details, see “About the PCI Cards and Buses” on page 85.

---

# How to Attach a Twisted-Pair Ethernet Cable

## Before You Begin

You must complete this task:

- Install the server into the rack, following instructions in the *Sun Fire V440 Server Installation Guide*.

## What to Do

1. **Locate the RJ-45 twisted-pair Ethernet (TPE) connector for the appropriate Ethernet interface—the left connector (net0) or the right connector (net1).**

See “Locating Back Panel Features” on page 15. For a PCI Ethernet adapter card, see the documentation supplied with the card.

2. **Connect a Category-5 unshielded twisted-pair (UTP) cable to the appropriate RJ-45 connector on the system back panel.**

You should hear the connector tab click into place. The UTP cable length must not exceed 100 meters (328 feet).

3. **Connect the other end of the cable to the RJ-45 outlet of the appropriate network device.**

You should hear the connector tab click into place.

Consult your network documentation if you need more information about how to connect to your network.

## What Next

If you are installing your system, complete the installation procedure, as described in the *Sun Fire V440 Server Installation Guide*.

If you are adding an additional network interface to the system, you need to configure that interface. See:

- “How to Configure Additional Network Interfaces” on page 146

---

# How to Configure the Primary Network Interface

## Before You Begin

For background information, see:

- *Sun Fire V440 Server Installation Guide*
- “About the Network Interfaces” on page 141

If you are using a PCI network interface card, see the documentation supplied with the card.

## What to Do

1. **Choose a network port, using the following table as a guide.**

Ethernet Port	PCI Bus/Clock Rate	OpenBoot PROM devalias	Device Path
1	PCI 2B/66 MHz	net1	/pci@1f,700000/network@1
0	PCI 1A/66 MHz	net0	/pci@1c,600000/network@2

2. **Attach an Ethernet cable to the port you chose.**

See “How to Attach a Twisted-Pair Ethernet Cable” on page 143.

3. **Choose a network host name for the system and make a note of it.**

You need to furnish the name in a later step.

The host name must be unique within the network. It can consist only of alphanumeric characters and the dash (-). Do not use a dot in the host name. Do not begin the name with a number or a special character. The name must not be longer than 30 characters.

4. **Determine the unique Internet Protocol (IP) address of the network interface and make a note of it.**

You need to furnish the address in a later step.

An IP address must be assigned by the network administrator. Each network device or interface must have a unique IP address.

During installation of the Solaris operating environment, the software automatically detects the system's on-board network interfaces and any installed PCI network interface cards for which native Solaris device drivers exist. The operating environment then asks you to select one of the interfaces as the primary network interface and prompts you for its host name and IP address. You can configure only one network interface during installation of the operating environment. You must configure any additional interfaces separately, after the operating environment is installed. For more information, see "How to Configure Additional Network Interfaces" on page 146.

## What Next

After completing this procedure, the primary network interface is ready for operation. However, in order for other network devices to communicate with the system, you must enter the system's IP address and host name into the namespace on the network name server. For information about setting up a network name service, consult:

- *Solaris Naming Configuration Guide* for your specific Solaris release

The device driver for the system's on-board Sun Gigabit Ethernet interfaces is automatically installed with the Solaris release. For information about operating characteristics and configuration parameters for this driver, refer to the following document:

- *Platform Notes: The Sun GigaSwift Ethernet Device Driver*

This document is available on the *Solaris on Sun Hardware AnswerBook*, which is provided on the Solaris Supplement CD for your specific Solaris release.

If you want to set up an additional network interface, you must configure it separately, after installing the operating environment. See:

- "How to Configure Additional Network Interfaces" on page 146

---

**Note** – The Sun Fire V440 server conforms to the Ethernet 10/100BASE-T standard, which states that the Ethernet 10BASE-T link integrity test function should always be enabled on both the host system and the Ethernet hub. If you have problems establishing a connection between this system and your hub, verify that the Ethernet hub also has the link test function enabled. Consult the manual provided with your hub for more information about the link integrity test function.

---

---

# How to Configure Additional Network Interfaces

## Before You Begin

Perform the following tasks to prepare an additional network interface:

- Install the Sun Fire V440 server as described in the *Sun Fire V440 Server Installation Guide*.
- If you are setting up a redundant network interface, see “About Redundant Network Interfaces” on page 142.
- If you need to install a PCI network interface card, follow the installation instructions in the *Sun Fire V440 Server Parts Installation and Removal Guide*.
- Attach an Ethernet cable to the appropriate port on the system back panel. See “How to Attach a Twisted-Pair Ethernet Cable” on page 143. If you are using a PCI network interface card, see the documentation supplied with the card.

---

**Note** – All internal options, except hard disk drives, must be installed by qualified service personnel only. Installation procedures for these components are covered in the *Sun Fire V440 Server Parts Installation and Removal Guide*.

---

## What to Do

### 1. Choose a network host name for each new interface.

You need to furnish the name in a later step.

The host name must be unique within the network. It can consist only of alphanumeric characters and the dash (-). Do not use a dot in the host name. Do not begin the name with a number or a special character. The name must not be longer than 30 characters.

Usually an interface host name is based on the system host name. For example, if the system is assigned the host name `sunrise`, the added network interface could be named `sunrise-1`. For more information, see the installation instructions accompanying the Solaris software.

**2. Determine the Internet Protocol (IP) address for each new interface.**

You need to furnish the IP address in a later step.

An IP address must be assigned by your network administrator. Each interface on a network must have a unique IP address.

**3. Boot the operating system, if it is not already running.**

Be sure to perform a reconfiguration boot if you just added a new PCI network interface card. See “How to Initiate a Reconfiguration Boot” on page 34.

**4. Log in to the system as superuser.**

**5. Create an appropriate `/etc/hostname` file for each new network interface.**

The name of the file you create should be of the form `/etc/hostname.typenum`, where *type* is the network interface type identifier (some common types are *ce*, *le*, *hme*, *eri*, and *ge*) and *num* is the device instance number of the interface according to the order in which it was installed in the system.

For example, the file names for the system’s Gigabit Ethernet interfaces are `/etc/hostname.ce0` and `/etc/hostname.ce1`. If you add a PCI Fast Ethernet adapter card as a third interface, its file name should be `/etc/hostname.eri0`. At least one of these files—the primary network interface—should exist already, having been created automatically during the Solaris installation process.

---

**Note** – The documentation accompanying the network interface card should identify its type. Alternatively, you can enter the `show-devs` command from the `ok` prompt to obtain a list of all installed devices.

---

**6. Edit the `/etc/hostname` file(s) created in Step 5 to add the host name(s) determined in Step 1.**

Following is an example of the `/etc/hostname` files required for a system called `sunrise`, which has two on-board Sun Gigabit Ethernet interfaces (`ce0` and `ce1`) and a PCI Fast Ethernet adapter card (`eri2`). A network connected to the on-board `ce0` and `ce1` interfaces will know the system as `sunrise` and `sunrise-1`, while networks connected to the PCI-based `eri0` interface will know the system as `sunrise-2`.

```
sunrise # cat /etc/hostname.ce0
sunrise
sunrise # cat /etc/hostname.ce1
sunrise-1
sunrise # cat /etc/hostname.eri0
sunrise-2
```

## 7. Create an entry in the `/etc/hosts` file for each active network interface.

An entry consists of the IP address and the host name for each interface.

The following example shows an `/etc/hosts` file with entries for the three network interfaces used as examples in this procedure.

```
sunrise # cat /etc/hosts
#
# Internet host table
#
127.0.0.1    localhost
129.144.10.57 sunrise loghost
129.144.14.26 sunrise-1
129.144.11.83 sunrise-2
```

## 8. Manually configure and enable each new interface using the `ifconfig` command.

For example, for the interface `eri0`, type:

```
# ifconfig eri0 inet ip-address netmask ip-netmask broadcast +
```

For more information, see the `ifconfig(1M)` man page.

## What Next

After completing this procedure, any new network interfaces are ready for operation. However, in order for other network devices to communicate with the system through the new interface, the IP address and host name for each new interface must be entered into the namespace on the network name server. For information about setting up a network name service, consult:

- *Solaris Naming Configuration Guide* for your specific Solaris release

The `ce` device driver for each of the system's on-board Sun Gigabit Ethernet interfaces is automatically configured during Solaris installation. For information about operating characteristics and configuration parameters for these drivers, refer to the following document:

- *Platform Notes: The Sun GigaSwift Ethernet Device Driver*

This document is available on the *Solaris on Sun Hardware AnswerBook*, which is provided on the Solaris Supplement CD for your specific Solaris release.



---

**Note** – The Sun Fire V440 server conforms to the Ethernet 10/100BASE-T standard, which states that the Ethernet 10BASE-T link integrity test function should always be enabled on both the host system and the Ethernet hub. If you have problems establishing a connection between this system and your Ethernet hub, verify that the hub also has the link test function enabled. Consult the manual provided with your hub for more information about the link integrity test function.

---



## Connector Pinouts

---

This appendix provides reference information about the system back panel ports and pin assignments.

Topics covered in this appendix include:

- “Reference for the Serial Port Connector” on page 152
- “Reference for the USB Connectors” on page 153
- “Reference for the Gigabit Ethernet Connectors” on page 154
- “Reference for the Network Management Connector” on page 155
- “Reference for the Serial Management Connector” on page 156
- “Reference for the Ultra-4 SCSI Connector” on page 157

---

# Reference for the Serial Port Connector

The serial port connector is a DB-9 connector that can be accessed from the back panel.

## Serial Port Connector Diagram



## Serial Port Connector Signals

Pin	Signal Description	Pin	Signal Description
1	Data Carrier Detect	6	Data Set Ready
2	Receive Data	7	Request to Send
3	Transmit Data	8	Clear to Send
4	Data Terminal Ready	9	Ring Indicate
5	Ground		

---

# Reference for the USB Connectors

Four Universal Serial Bus (USB) double-stacked connectors are located on the motherboard and can be accessed from the back panel.

## USB Connector Diagram

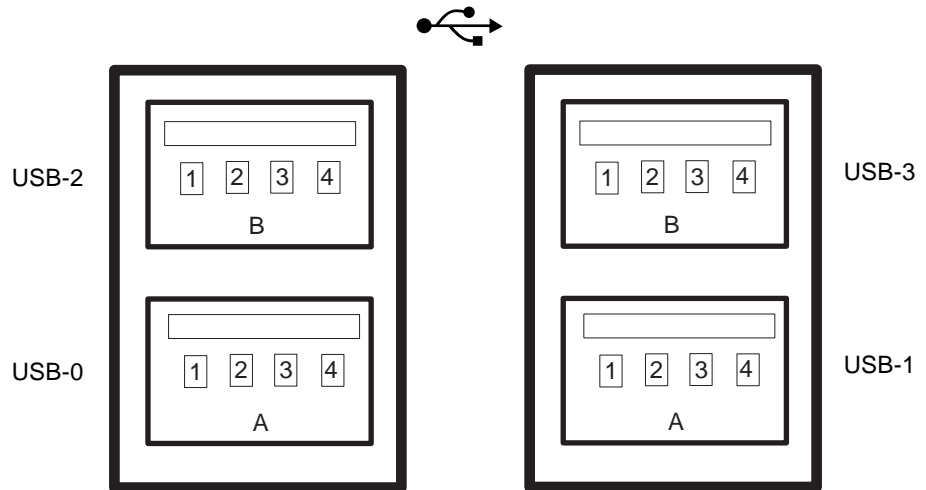

## USB Connector Signals

Pin	Signal Description	Pin	Signal Description
A1	+5 V (fused)	B1	+5 V (fused)
A2	USB0/1-	B2	USB2/3-
A3	USB0/1+	B3	USB2/3+
A4	Ground	B4	Ground

---

# Reference for the Gigabit Ethernet Connectors

Two RJ-45 Gigabit Ethernet connectors are located on the system motherboard and can be accessed from the back panel. The Ethernet interfaces operate at 10 Mbps, 100 Mbps, and 1000 Mbps.

## Gigabit Ethernet Connector Diagram

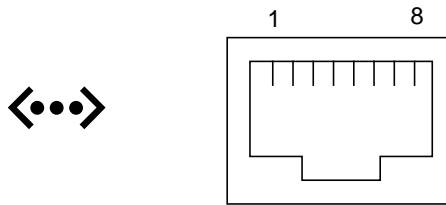

## Gigabit Ethernet Connector Signals

Pin	Signal Description	Pin	Signal Description
1	Transmit/Receive Data 0 +	5	Transmit/Receive Data 2 -
2	Transmit/Receive Data 0 -	6	Transmit/Receive Data 1 -
3	Transmit/Receive Data 1 +	7	Transmit/Receive Data 3 +
4	Transmit/Receive Data 2 +	8	Transmit/Receive Data 3 -

---

# Reference for the Network Management Connector

The network management connector (labeled NET MGT) is an RJ-45 connector located on the ALOM card and can be accessed from the back panel.

## Network Management Connector Diagram

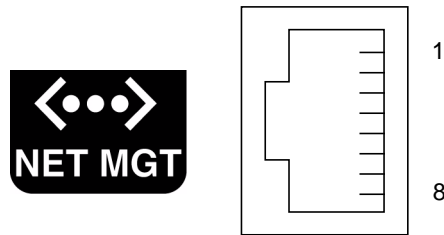

## Network Management Connector Signals

Pin	Signal Description	Pin	Signal Description
1	Transmit Data +	5	Common Mode Termination
2	Transmit Data -	6	Receive Data -
3	Receive Data +	7	Common Mode Termination
4	Common Mode Termination	8	Common Mode Termination

---

# Reference for the Serial Management Connector

The serial management connector (labeled SERIAL MGT) is an RJ-45 connector located on the ALOM card and can be accessed from the back panel.

## ALOM Serial Management Connector Diagram

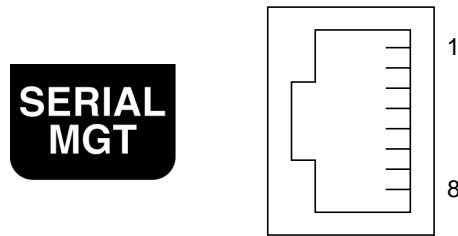

## Serial Management Connector Signals

Pin	Signal Description	Pin	Signal Description
1	Request to Send	5	Ground
2	Data Terminal Ready	6	Receive Data
3	Transmit Data	7	Data Set Ready
4	Ground	8	Clear to Send



---

# Reference for the Ultra-4 SCSI Connector

The Ultra-4 SCSI serial data connector is located on the motherboard and can be accessed from the back panel.

## Ultra-4 SCSI Connector Diagram

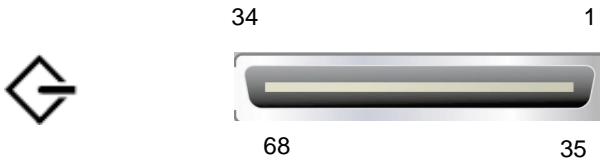

## SCSI Connector Signals

Pin	Signal Description	Pin	Signal Description
1	Data12 +	35	Data12 -
2	Data13 +	36	Data13 -
3	Data14 +	37	Data14 -
4	Data15 +	38	Data15 -
5	Parity1 +	39	Parity1 -
6	Data0 +	40	Data0 -
7	Data1 +	41	Data1 -
8	Data2 +	42	Data2 -
9	Data3 +	43	Data3 -
10	Data4 +	44	Data4 -
11	Data5 +	45	Data5 -

<b>Pin</b>	<b>Signal Description</b>	<b>Pin</b>	<b>Signal Description</b>
12	Data6 +	46	Data6 –
13	Data7 +	47	Data7 –
14	Parity0 +	48	Parity0 –
15	Ground	49	Ground
16	DIFF_SENSE	50	Ground
17	TERM_PWR	51	TERM_PWR
18	TERM_PWR	52	TERM_PWR
19	(N/C)	53	(N/C)
20	Ground	54	Ground
21	ATN +	55	ATN –
22	Ground	56	Ground
23	BSY +	57	BSY –
24	ACK +	58	ACK –
25	RST +	59	RST –
26	MSG +	60	MSG –
27	SEL +	61	SEL –
28	CD +	62	CD –
29	REQ +	63	REQ –
30	I/O +	64	I/O –
31	Data8 +	65	Data8 –
32	Data9 +	66	Data9 –
33	Data10 +	67	Data10 –
34	Data11 +	68	Data11 –

## System Specifications

---

This appendix provides the following specifications for the Sun Fire V440 server:

- “Reference for Physical Specifications” on page 160
- “Reference for Electrical Specifications” on page 160
- “Reference for Environmental Specifications” on page 161
- “Reference for Agency Compliance Specifications” on page 162
- “Reference for Clearance and Service Access Specifications” on page 162

---

## Reference for Physical Specifications

The dimensions and weight of the system are as follows.

Measurement	U.S.	Metric
Height	6.85 in	17.4 cm
Width	17.48 in	44.4 cm
Depth	25 in	63.5 cm
Weight:		
Minimum	70 lbs	31 kg
Maximum	82 lbs	37.2 kg
Power Cord	8.2 ft	2.5 m

---

## Reference for Electrical Specifications

The following table provides the electrical specifications for the system. All specifications pertain to a fully configured system operating at 50 Hz or 60 Hz.

Parameter	Value
Input	
Nominal Frequencies	50 or 60 Hz
Nominal Voltage Range	100 to 240 VAC
Maximum Current AC RMS *	9.3A @ 100 VAC
	7.7A @ 120 VAC
	4.6A @ 200 VAC
	4.45A @ 208 VAC
	4.2A @ 220 VAC
	4.0A @ 230 VAC
	3.65A @ 240 VAC
Output	
+12 VDC	0.5 to 45A
-12 VDC	0 to 0.8A
+5 VDC	0.5 to 28A
-5 VDC	0.5 to 50A

Parameter	Value
Maximum DC Output of Power Supply	680W
Maximum AC Power Consumption	925W for operation @ 100 VAC to 240 VAC
Maximum Heat Dissipation	3157 Btu/hr for operation @ 200 VAC to 240 VAC

\* Refers to total input current required for both AC inlets when operating with dual power supplies or current required for a single AC inlet when operating with a single power supply.

## Reference for Environmental Specifications

The operating and non-operating environmental specifications for the system are as follows.

Parameter	Value
<b>Operating</b>	
Temperature	5°C to 40° C (41°F to 104°F) noncondensing—IEC 60068-2-1&2
Humidity	20% to 80% RH noncondensing; 27°C max wet bulb—IEC 60068-2-3&56
Altitude	0 to 3000 meters (0 to 10,000 feet)—IEC 60068-2-13
Vibration (random)	0.0001 g <sup>2</sup> /Hz, 5 to 500 Hz, -12db/octave slope 150 to 500 Hz
Shock	3.0 g peak, 11 milliseconds half-sine pulse—IEC 60068-2-27
<b>Non-Operating</b>	
Temperature	-40°C to 60°C (-40°F to 140°F) noncondensing—IEC 60068-2-1&2
Humidity	93% RH noncondensing; 38°C max wet bulb—IEC 60068-2-3&56
Altitude	0 to 12,000 meters (0 to 40,000 feet)—IEC 60068-2-13
Vibration	0.001 g <sup>2</sup> /Hz, 5 to 150 Hz, -12db/octave slope 150 to 200 Hz
Shock	15.0g peak, 11 milliseconds half-sine pulse; 1.0 inch roll-off front to back, 0.5 inch roll-off side to side—IEC 60068-2-27
Handling Drops	60 mm, 1 drop per corner, 4 corners—IEC 60068-2-31
Threshold Impact	0.85m/s, 3 impacts per caster, all 4 casters, 25 mm step-up—ETE 1010-01

---

## Reference for Agency Compliance Specifications

The system complies with the following specifications.

Category	Relevant Standards
Safety	UL 60950, CB Scheme IEC 950, CSA C22.2 950 from UL TUV EN 60950
RFI/EMI	47 CFR 15B Class A EN55022 Class A VCCI Class B ICES-003 AS/NZ 3548 CNS 13438 KSC 5858
Immunity	IEC 1000 EN55024 IEC 61000-4-2 IEC 61000-4-3 IEC 61000-4-4 IEC 61000-4-5 IEC 61000-4-6 IEC 61000-4-8 IEC 61000-4-11

---

---

## Reference for Clearance and Service Access Specifications

Minimum clearances needed for servicing the system are as follows.

Blockage	Required Clearance
Front of System	36 in (91.4 cm)
Back of System	36 in (91.4 cm)

---

# OpenBoot Configuration Variables

TABLE C-1 describes the OpenBoot firmware configuration variables stored on the system configuration card (SCC). The OpenBoot configuration variables are printed here in the order in which they appear when you issue the `showenv` command.

**TABLE C-1** OpenBoot Configuration Variables Stored on the System Configuration Card

Variable	Possible Values	Default Value	Description
<code>test-args</code>	<i>variable name</i>	none	Default test arguments passed to OpenBoot Diagnostics. For more information and a list of possible test argument values, see the <i>Sun Fire V440 Server Diagnostics and Troubleshooting Guide</i> .
<code>diag-passes</code>	0-n	1	Defines the number of times self-test method(s) are performed.
<code>local-mac-address?</code>	true, false	false	If true, network drivers use their own MAC address, not the server MAC address.
<code>fcode-debug?</code>	true, false	false	If true, include name fields for plug-in device FCodes.
<code>silent-mode?</code>	true, false	false	Suppress all messages if true and <code>diag-switch?</code> is false.
<code>scsi-initiator-id</code>	0-15	7	SCSI ID of the Ultra-4 SCSI controller.
<code>oem-logo?</code>	true, false	false	If true, use custom OEM logo, otherwise, use Sun logo.
<code>oem-banner?</code>	true, false	false	If true, use custom OEM banner.
<code>ansi-terminal?</code>	true, false	true	If true, enable ANSI terminal emulation.
<code>screen-#columns</code>	0-n	80	Sets number of columns on screen.
<code>screen-#rows</code>	0-n	34	Sets number of rows on screen.

**TABLE C-1** OpenBoot Configuration Variables Stored on the System Configuration Card (Continued)

Variable	Possible Values	Default Value	Description
ttyb-rts-dtr-off	true, false	false	If true, operating system does not assert rts (request-to-send) and dtr (data-transfer-ready) on ttyb.
ttyb-ignore-cd	true, false	true	If true, operating system ignores carrier-detect on ttyb.
ttya-rts-dtr-off	true, false	false	If true, operating system does not assert rts (request-to-send) and dtr (data-transfer-ready) on serial management port.
ttya-ignore-cd	true, false	true	If true, operating system ignores carrier-detect on serial management port.
ttyb-mode	<i>baud-rate, bits, parity, stop, handshake</i>	9600,8,n,1,-	ttyb (baud rate, number of bits, parity, number of stops, handshake).
ttya-mode	9600,8,n,1,-	9600,8,n,1,-	Serial management port (baud rate, bits, parity, stop, handshake). The serial management port only works at the default values.
output-device	ttya, ttyb, screen	ttya	Power-on output device.
input-device	ttya, ttyb, keyboard	ttya	Power-on input device.
auto-boot-on-error?	true, false	false	If true, boot automatically after system error.
load-base	0-n	16384	Address.
auto-boot?	true, false	true	If true, boot automatically after power on or reset.
boot-command	<i>variable name</i>	boot	Action following a boot command.
diag-file	<i>variable name</i>	none	File from which to boot if diag-switch? is true.
diag-device	<i>variable name</i>	net	Device from which to boot if diag-switch? is true.
boot-file	<i>variable name</i>	none	File from which to boot if diag-switch? is false.
boot-device	<i>variable name</i>	disk net	Device(s) from which to boot if diag-switch? is false.
use-nvramrc?	true, false	false	If true, execute commands in NVRAMRC during server start-up.



**TABLE C-1** OpenBoot Configuration Variables Stored on the System Configuration Card *(Continued)*

Variable	Possible Values	Default Value	Description
nvrnrc	<i>variable name</i>	none	Command script to execute if use-nvrnrc? is true.
security-mode	none, command, full	none	Firmware security level.
security-password	<i>variable name</i>	none	Firmware security password if security-mode is not none (never displayed) - <i>do not set this directly.</i>
security-#badlogins	<i>variable name</i>	none	Number of incorrect security password attempts.
post-trigger	error-reset, power-on-reset, user-reset, all-resets	power-on-reset	Sets trigger events that will cause POST to run, provided diag-switch? is true. POST will not run if diag-switch? is false, regardless of the post-trigger setting.
diag-script	all, normal, none	normal	Specifies the set of tests which OpenBoot Diagnostics will run. Selecting all is equivalent to running test-all from the OpenBoot command line.
diag-level	none, min, max	min	Defines how diagnostic tests are run.
diag-switch?	true, false	false	If true: <ul style="list-style-type: none"><li>• Run in diagnostic mode</li><li>• After a boot request, boot diag-file from diag-device</li></ul> If false: <ul style="list-style-type: none"><li>• Run in non-diagnostic mode</li><li>• After a boot request, boot boot-file from boot-device</li></ul>
obdiag-trigger	error-reset, power-on-reset, user-reset, all-resets	error-reset	Sets trigger events that will cause OpenBoot Diagnostics to run, provided diag-switch? is true, and diag-script is not none. OpenBoot Diagnostics does not run if diag-switch? is false or if diag-script is none, regardless of the obdiag-trigger setting.
error-reset-recovery	boot, sync, none	boot	Command to execute following a system reset generated by an error.



# Index

---

## A

- Activity (disk drive LED), 10, 138
- Activity (system status LED), 8, 9, 27
- Advanced Lights Out Manager (ALOM)
  - about, 4, 18, 81
  - commands, *See* `sc>` prompt
  - configuration rules, 84
  - connections, 3
  - escape sequence (#.), 49
  - features, 18
  - invoking `xir` command from, 21
  - logging in, 102
  - multiple connections to, 49
  - ports, 83
  - remote power-off, 33, 35
  - remote power-on, 29
  - `sc>` prompt, *See* `sc>` prompt
- agency compliance specifications, 162
- ALOM, *See* Sun Advanced Lights Out Manager (ALOM)
- alphanumeric terminal
  - accessing system console from, 3, 68
  - baud verification, 70
  - remote power-off, 33, 35
  - remote power-on, 29
  - setting baud rate, 68
- `asr-disable` (OpenBoot command), 116
- `auto-boot` (OpenBoot configuration variable), 50, 110

- automatic system recovery (ASR)
  - about, 20, 110
  - commands, 113
  - disabling, 114
  - enabling, 113
  - obtaining recovery information, 115

## B

- back panel
  - Ethernet LEDs, 16
  - features, 15
  - illustration, 15
  - system status LEDs, table, 9
- boot device, selecting, 37
- `boot-device` (OpenBoot configuration variable), 37
- `bootmode diag` (`sc>` command), 110
- `bootmode reset_nvram` (`sc>` command), 109
- `break` (`sc>` command), 51
- Break key (alphanumeric terminal), 56

## C

- cables, keyboard and mouse, 74
- `cfgadm` (Solaris command), 136
- `cfgadm install_device` (Solaris command),
  - cautions against using, 137
- `cfgadm remove_device` (Solaris command),
  - cautions against using, 137
- Cisco L2511 Terminal Server, connecting, 60

- clearance specifications, 162
- command prompts, explained, 54
- communicating with the system
  - about, 42
  - options, table, 42
- concatenation of disks, 126
- console (`sc>` command), 51
- console configuration, connection alternatives
  - explained, 46
- console `-f` (`sc>` command), 49
- CPU, about, 2
  - See also* UltraSPARC IIIi processor
- CPU/memory modules, about, 78

## D

- DB-9 connector (for `ttyb` port), 3
- default system console configuration, 44
- device identifiers, listed, 116
- device reconfiguration, manual, 118
- device trees, rebuilding, 36
- device unconfiguration, manual, 116
- DHCP (Dynamic Host Configuration Protocol), 58
- `diag-device` (OpenBoot configuration variable), 112
- Diagnostics (system control keyswitch position), 13
- DIMMs (dual inline memory modules)
  - about, 2
  - configuration rules, 81
  - error correcting, 22
  - groups, illustrated, 79
  - interleaving, 80
  - parity checking, 22
- disk configuration
  - concatenation, 126
  - hot-plug, 92
  - hot-spares, 92, 128
  - mirroring, 22, 92, 126
  - RAID 0, 22, 92, 127
  - RAID 1, 22, 92, 127
  - RAID 5, 22, 128
  - striping, 22, 92, 127
- disk drive LEDs, *See* disk drives, LEDs

- disk drives
  - about, 2, 90, 91
  - caution, 25, 29
  - configuration rules, 93
  - hot-plug, 92
  - LEDs, 10
    - Activity, 10, 138
    - OK-to-Remove, 10, 134, 137, 138
    - Service Required, 10
  - LEDs, table, 10
  - locating drive bays, 92
  - logical device names, table, 129
  - selecting a boot device, 37
- disk hot-plug
  - mirrored disk, 133
  - non-mirrored disk, 136
- disk mirror (RAID 0), *See* hardware disk mirror
- disk slot number, reference, 129
- disk striping with parity (RAID 5), 128
- disk volumes
  - about, 123
  - deleting, 133
- DMP (Dynamic Multipathing), 124
- double-bit errors, 22
- `dtterm` (Solaris utility), 64
- dual inline memory modules (DIMMs), *See* DIMMs
- Dynamic Host Configuration Protocol (DHCP)
  - client on network management port, 58, 59
- Dynamic Multipathing (DMP), 124

## E

- ECC (error-correcting code), 22
- electrical specifications, 160
- environmental information, viewing, 105
- environmental monitoring and control, 19
- environmental monitoring subsystem, 19
- environmental specifications, 161
- error handling, summary, 111
- error messages
  - correctable ECC error, 22
  - log file, 20
  - power-related, 20
- error-correcting code (ECC), 22

- error-reset-recovery (OpenBoot configuration variable), 120
- escape sequence (#.), ALOM system controller, 49
- /etc/hostname file, 147
- /etc/hosts file, 148
- /etc/remote file, 63
  - modifying, 66
- Ethernet
  - cable, attaching, 143
  - configuring interface, 144
  - interfaces, 141
  - LEDs
    - Link/Activity, 16
    - Speed, 16
  - LEDs, table, 16
  - link integrity test, 145, 149
  - using multiple interfaces, 145
- Ethernet ports
  - about, 3, 141
  - configuring redundant interfaces, 142
  - Gigabit Ethernet ports, about, 15
  - outbound load balancing, 3
- externally initiated reset (XIR)
  - invoking from `sc>` prompt, 52
  - invoking through network management port, 5
  - manual command, 21

## F

- fan trays
  - about, 97
  - configuration rules, 98
  - illustration, 98
- fans, monitoring and control, 19
- front panel
  - disk drive LEDs, table, 10
  - illustration, 7
  - LEDs, 8
  - Power button, 11
  - power supply LEDs, table, 10
  - security lock, 7
  - system control keyswitch, 12
  - system status LEDs, table, 9
- `fsck` (Solaris command), 52

## G

- `go` (OpenBoot command), 53
- graceful system halt, 51, 56
- graphics card, *See* graphics monitor; PCI graphics card
- graphics monitor
  - accessing system console from, 71
  - configuring, 3
  - connecting to PCI graphics card, 72
  - restrictions against using for initial setup, 71
  - restrictions against using to view POST output, 71

## H

- halt, gracefully, advantages of, 51, 56
- hardware disk mirror
  - about, 6, 128
  - checking the status of, 131
  - creating, 130
  - hot-plug operation, 133
  - removing, 132
- hardware watchdog mechanism, 21
  - enabling, 119
- hot-plug operation
  - non-mirrored disk drive, 136
  - on hardware disk mirror, 133
  - power supply, 95
- hot-pluggable components, about, 17, 90
- hot-spares (disk drives), 128
  - See also* disk configuration

## I

- I<sup>2</sup>C bus, 19
- `ifconfig` (Solaris command), 148
- independent memory subsystems, 80
- `init` (Solaris command), 51, 56
- `input-device` (OpenBoot configuration variable), 61, 75, 76
- internal disk drive bays, locating, 92
- Internet Protocol (IP) network multipathing, 3

## K

- keyboard
  - attaching, 73
  - Sun Type-6 USB, 3
- keyboard sequences
  - L1-A, 50, 51, 56, 91
  - Stop-A (non-USB keyboard sequence), *See* L1-A keyboard sequence
  - Stop-D (non-USB keyboard sequence), 108
  - Stop-F (non-USB keyboard sequence), 108
  - Stop-N (non-USB keyboard sequence), 108
- keys
  - mini-key, 7
  - system, 7
- keyswitch, *See* system control keyswitch

## L

- L1-A keyboard sequence, 50, 51, 56, 91
- LEDs
  - Activity (disk drive LED), 10, 138
  - Activity (system status LED), 8, 9, 27
  - disk drive, table, 10
  - front panel, 8
  - Link/Activity (Ethernet LED), 16
  - Locator (system status LED), 8, 9, 106
  - OK-to-Remove (disk drive LED), 10, 134, 137, 138
  - OK-to-Remove (power supply LED), 10, 96
  - Power OK (power supply LED), 10, 31
  - power supplies, table, 10
  - Service Required (disk drive LED), 10
  - Service Required (power supply LED), 10, 96
  - Service Required (system status LED), 8, 9
  - Speed (Ethernet LED), 16
  - Standby Available (power supply LED), 10
  - system status, illustrated, 8
  - system status, table, 9
- light-emitting diodes, *See* LEDs
- link integrity test, 145, 149
- Link/Activity (Ethernet LED), 16
- local graphics monitor
  - remote power-off, 33, 35
  - remote power-on, 29

- Locator (system status LED)
  - about, 8
  - controlling, 106
  - controlling from `sc>` prompt, 106, 107
  - controlling from Solaris, 106, 107
- Locked (system control keyswitch position), 13
- logging in to the Advanced Lights Out Manager (ALOM), 102
- logical device name (disk drive), reference, 129

## M

- manual device reconfiguration, 118
- manual device unconfiguration, 116
- manual system reset, 52, 56
- memory interleaving
  - about, 80
  - See also* DIMMs (dual inline memory modules)
- memory modules, *See* DIMMs (dual inline memory modules)
- memory subsystems, 80
- mini-key, 7
- mirrored disk, 22, 92, 126
- monitor, attaching, 71
- monitored hardware, 24
- monitored software properties, 24
- mouse
  - attaching, 74
  - USB device, 3
- moving the system, cautions, 25, 29
- multiple ALOM sessions, 49
- multiple-bit errors, 22
- Multiplexed I/O (MPxIO), 125

## N

- NET MGT, *See* network management port (NET MGT)
- network
  - name server, 148
  - primary interface, 145
- network interfaces
  - about, 141
  - configuring additional, 146

- configuring primary, 144
- redundant, 142
- network management port (NET MGT)
  - about, 3, 5
  - activating, 58
  - advantages over serial management port, 46
  - configuration rules, 84
  - configuring IP address, 59
  - configuring using Dynamic Host Configuration Protocol (DHCP), 58
  - issuing an externally initiated reset (XIR) from, 5
  - locating, 15
- non-mirrored disk hot-plug operation, 136
- Normal (system control keyswitch position), 13

## O

- ok prompt
  - about, 49
  - accessing via ALOM break command, 50, 51
  - accessing via Break key, 50, 51
  - accessing via externally initiated reset (XIR), 52
  - accessing via graceful system shutdown, 51
  - accessing via L1-A (Stop-A) keys, 50, 51, 91
  - accessing via manual system reset, 50, 52
  - risks in using, 53
  - suspension of Solaris operating environment, 53
  - ways to access, 50, 55
- OK-to-Remove (disk drive LED), 10, 134, 137, 138
- OK-to-Remove (power supply LED), 10, 96
- on-board storage, 2
  - See also* disk drives; disk volumes; internal drive bays, locating
- 1+1 redundancy, power supplies, 4
- OpenBoot commands
  - asr-disable, 116
  - go, 53
  - power-off, 62, 64, 69
  - probe-ide, 51
  - probe-scsi, 51
  - probe-scsi-all, 51
  - reset-all, 75, 113, 114, 117
  - set-defaults, 109
  - setenv, 61, 75
  - show-devs, 39, 117, 147
  - showenv, 163

- OpenBoot configuration variables
  - auto-boot, 50, 110
  - boot-device, 37
  - described, table, 163
  - diag-device, 112
  - error-reset-recovery, 120
  - input-device, 61, 75, 76
  - output-device, 61, 75, 76
  - system console settings, 76
  - ttyb-mode, 71
- OpenBoot emergency procedures
  - non-USB keyboard commands, 108
  - performing, 107
  - USB keyboard commands, 108
- OpenBoot firmware
  - scenarios for control, 50
  - selecting a boot device, 37
- operating environment software, suspending, 53
- output-device (OpenBoot configuration variable), 61, 75, 76

## P

- parity, 68, 70, 128
- parity protection
  - PCI buses, 22
  - UltraSCSI bus, 22
  - UltraSPARC IIIi CPU internal cache, 22
- patch panel, terminal server connection, 60
- PCI buses
  - about, 2, 85
  - characteristics, table, 85
  - parity protection, 22
- PCI cards
  - about, 85
  - configuration rules, 86
  - device names, 39, 117
  - frame buffers, 71
  - slots for, 15, 85
- PCI graphics card
  - configuring to access system console, 71
  - connecting graphics monitor to, 72
- physical device name (disk drive), 129
- physical specifications, 160
- port settings, verifying on ttyb, 70

ports, external, 3  
    *See also* serial management port (SERIAL MGT);  
        network management port (NET MGT); ttyb  
        port; UltraSCSI port; USB ports

POST, *See* power-on self-test (POST)

power  
    specifications, 160  
    turning off, 30  
    turning off remotely, 33  
    turning on, 25  
    turning on remotely, 29

Power button, 11, 31

Power OK (power supply LED), 10, 27, 31

power supplies  
    1+1 redundancy, 4  
    about, 4, 91, 93  
    AC inlets, 15  
    as hot-pluggable components, 91  
    configuration rules, 95  
    fault monitoring, 20  
    hot-plug operation, performing, 95  
    LEDs, described, 10  
    LEDs, table, 10  
    output capacity, 160  
    presence required for system cooling, 4  
    redundancy, 4, 17  
    role in system cooling, 4

power-off (OpenBoot command), 62, 64, 69

poweroff (sc> command), 52

poweron (sc> command), 52

power-on self-test (POST)  
    default port for messages, 5  
    output messages, 5

primary network interface, configuring, 144

probe-ide (OpenBoot command), 51

probe-scsi (OpenBoot command), 51

probe-scsi-all (OpenBoot command), 51

## R

RAID (redundant array of independent disks)  
    disk concatenation, 126  
    hardware mirror, *See* hardware disk mirror  
    storage configurations, 22  
    striping, 127

RAID 0 (striping), 127

RAID 1 (mirroring), 6, 127

*See also* hardware disk mirror

RAID 5 (striping with parity), 128

raidctl (Solaris command), 130 to 135

reconfiguration boot, 34

redundant array of independent disks, *See* RAID  
    (redundant array of independent disks)

redundant network interfaces, 142

reliability, availability, and serviceability (RAS), 16  
    to 22

reset  
    manual system, 52, 56  
    scenarios, 112

reset (sc> command), 52

reset -x (sc> command), 52

reset-all (OpenBoot command), 75, 113, 114,  
    117

RJ-45 serial communication, 99

RJ-45 twisted-pair Ethernet (TPE) connector, 143

run levels  
    explained, 49  
    ok prompt and, 49

## S

safety agency compliance, 162

sc> commands

    bootmode diag, 110

    bootmode reset\_nvram, 109

    break, 51

    console, 51, 109

    console -f, 49

    poweroff, 52

    poweron, 52

    reset, 52, 109

    reset -x, 52

    setlocator, 106, 107

    setsc, 59

    showlocator, 107

    shownetwork, 59



- sc> prompt
  - about, 48, 102
  - accessing from network management port, 49
  - accessing from serial management port, 49
  - multiple sessions, 49
  - system console escape sequence (#.), 49
  - system console, switching between, 53
  - ways to access, 49
- scadm (Solaris utility), 104
- security lock, 7
- serial management port (SERIAL MGT)
  - about, 3, 5
  - acceptable console device connections, 45
  - as default communication port on initial startup, 42
  - as default console connection, 99
  - baud rate, 99
  - configuration parameters, 57
  - configuration rules, 84
  - default system console configuration, 44
  - locating, 15
  - using, 56
- SERIAL MGT, *See* serial management port
- serial ports, 99
  - See also* serial management port (SERIAL MGT); ttyb port
- service access specifications, 162
- Service Required (disk drive LED), 10
- Service Required (power supply LED), 10, 96
- Service Required (system status LED), 8, 9
- set-defaults (OpenBoot command), 109
- setenv (OpenBoot command), 61, 75
- setlocator (sc> command), 107
- setlocator (Solaris command), 106
- setsc (sc> command), 59
- show-devs (OpenBoot command), 39, 117, 147
- showenv (OpenBoot command), 163
- shownetwork (sc> command), 59
- shutdown (Solaris command), 51, 56
- single-bit errors, 22
- software properties monitored by Sun Management Center software, 24
- Solaris commands
  - cfgadm, 136
  - cfgadm install\_device, cautions against using, 137
  - cfgadm remove\_device, cautions against using, 137
  - fsck, 52
  - ifconfig, 148
  - init, 51, 56
  - raidctl, 130 to 135
  - scadm, 104
  - setlocator, 106
  - showlocator, 107
  - shutdown, 51, 56
  - sync, 52
  - tip, 63, 64
  - uadmin, 51
  - uname, 66
  - uname -r, 66
- Solaris Volume Manager, 92, 124, 125
- Solstice DiskSuite, 92, 126
- specifications, 159 to 162
  - agency compliance, 162
  - clearance, 162
  - electrical, 160
  - environmental, 161
  - physical, 160
  - service access, 162
- Speed (Ethernet LED), 16
- Standby (system control keyswitch position), 13, 31
- Standby Available (power supply LED), 10
- Stop (non-USB keyboard) command, 108
- Stop-A (non-USB keyboard sequence)
  - See* L1-A keyboard sequence
- Stop-A (USB keyboard functionality), 108
- Stop-D (non-USB keyboard command), 108
- Stop-D (USB keyboard functionality), 110
- Stop-F (non-USB keyboard command), 108
- Stop-F (USB keyboard functionality), 109
- Stop-N (non-USB keyboard command), 108
- Stop-N (USB keyboard functionality), 109
- storage, on-board, 2
- striping of disks, 22, 92, 127
- Sun Cluster software, 22
- Sun Management Center software, 23, 24
- Sun StorEdge 3310, 125
- Sun StorEdge A5x00, 125
- Sun StorEdge T3, 125
- Sun StorEdge Traffic Manager software (TMS), 125

- Sun Type-6 USB keyboard, 3
- suspending the operating environment
  - software, 53
- sync (Solaris command), 52
- system configuration card (SCC)
  - about, 6, 87
  - configuring, 88
  - migrating from one system to another, 88
- system configuration card (SCC) reader, 14
- system console
  - about, 3
  - accessing via alphanumeric terminal, 68
  - accessing via graphics monitor, 71
  - accessing via terminal server, 42, 59
  - accessing via `tip` connection, 45, 63
  - alphanumeric terminal connection, 42, 68
  - alternate configurations, 46
  - alternative connections (illustration), 46
  - configuring local graphics monitor to access, 71
  - connection using graphics monitor, 47
  - default configuration explained, 42, 44
  - default connections, 44
  - defined, 42
  - devices used for connection to, 3
  - Ethernet attachment through network management port, 43
  - graphics monitor connection, 43, 47
  - multiple view sessions, 49
  - network management port connection, 46
  - redirecting output to `tttyb` (terminal server connection), 61
  - `sc>` prompt, switching between, 53
  - setting OpenBoot configuration variables for, 76
- system control keyswitch
  - about, 12
  - Diagnostics position, 13, 27
  - Locked position, 13, 28
  - mini-key, 7
  - Normal position, 13
  - settings, table, 13
  - Standby position, 13, 31
- system doors, 7
- system fans, 97
- system keys, 7
- system reset scenarios, 112
- system specifications, *See* specifications

- system status LEDs
  - Activity, 8, 9, 27
  - as environmental fault indicators, 20
  - Locator, 8, 9, 106, 107
  - See also* LEDs
  - Service Required, 8, 9
  - table, 9

## T

- temperature sensors, 19
- terminal server
  - accessing system console from, 45, 59
  - connection through patch panel, 60
  - connection through serial management port, 3
  - pinouts for crossover cable, 61
- thermistors, 19
- `tip` (Solaris command), 64
- `tip` connection
  - accessing system console, 3, 45, 63
  - accessing terminal server, 63
  - remote power-off, 33, 35
  - remote power-on, 29
- `tttyb` port
  - about, 3, 99
  - baud rates, 99
  - redirecting console output (terminal server connection), 61
  - verifying baud rate, 70
  - verifying settings on, 70
- `tttyb-mode` (OpenBoot configuration variable), 71

## U

- `uadmin` (Solaris command), 51
- Ultra-4 SCSI backplane
  - about, 89
  - configuration rules, 90
- Ultra-4 SCSI controller, 6, 87
- Ultra-4 SCSI port
  - about, 15, 99
  - data transfer rates, 99
- UltraSCSI bus parity protection, 22
- UltraSCSI disk drives supported, 89

UltraSPARC IIIi processor  
  about, 78  
  internal cache parity protection, 22  
uname (Solaris command), 66  
uname -r (Solaris command), 66  
USB ports  
  about, 3, 100  
  configuration rules, 100  
  connecting to, 100

## **V**

VERITAS Volume Manager, 22, 124, 125  
volume management software, 124

## **W**

watchdog, hardware, *See* hardware watchdog  
  mechanism

## **X**

XIR, *See* externally initiated reset (XIR)

