



# Sun Fire™ 6800 System and Sun Fire Cabinet Rackmount Placement Matrix

---

Sun Microsystems, Inc.  
4150 Network Circle  
Santa Clara, CA 95054 U.S.A.

Part No. 816-2062-18  
June 2003, [Revision 01](#)

Send comments about this document to: <http://www.sun.com/hwdocs/feedback>

Copyright 2003 Sun Microsystems, Inc., 4150 Network Circle, Santa Clara, CA 95054 U.S.A. All rights reserved.

This product or document is protected by copyright and distributed under licenses restricting its use, copying, distribution, and decompilation. No part of this product or document may be reproduced in any form by any means without prior written authorization of Sun and its licensors, if any. Third-party software, including font technology, is copyrighted and licensed from Sun suppliers.

Parts of the product may be derived from Berkeley BSD systems, licensed from the University of California. UNIX is a registered trademark in the U.S. and other countries, exclusively licensed through X/Open Company, Ltd.

Sun, Sun Microsystems, the Sun logo, AnswerBook2, docs.sun.com, Sun Fire, Sun StorEdge, and Solaris are trademarks, registered trademarks, or service marks of Sun Microsystems, Inc. in the U.S. and other countries. All SPARC trademarks are used under license and are trademarks or registered trademarks of SPARC International, Inc. in the U.S. and other countries. Products bearing SPARC trademarks are based upon an architecture developed by Sun Microsystems, Inc.

The OPEN LOOK and Sun™ Graphical User Interface was developed by Sun Microsystems, Inc. for its users and licensees. Sun acknowledges the pioneering efforts of Xerox in researching and developing the concept of visual or graphical user interfaces for the computer industry. Sun holds a non-exclusive license from Xerox to the Xerox Graphical User Interface, which license also covers Sun's licensees who implement OPEN LOOK GUIs and otherwise comply with Sun's written license agreements.

U.S. Government Rights-Commercial use. Government users are subject to the Sun Microsystems, Inc. standard license agreement and applicable provisions of the FAR and its supplements.

DOCUMENTATION IS PROVIDED "AS IS" AND ALL EXPRESS OR IMPLIED CONDITIONS, REPRESENTATIONS AND WARRANTIES, INCLUDING ANY IMPLIED WARRANTY OF MERCHANTABILITY, FITNESS FOR A PARTICULAR PURPOSE OR NON-INFRINGEMENT, ARE DISCLAIMED, EXCEPT TO THE EXTENT THAT SUCH DISCLAIMERS ARE HELD TO BE LEGALLY INVALID.

Copyright 2003 Sun Microsystems, Inc., 4150 Network Circle, Santa Clara, CA 95054 Etats-Unis. Tous droits réservés.

Ce produit ou document est protégé par un copyright et distribué avec des licences qui en restreignent l'utilisation, la copie, la distribution, et la décompilation. Aucune partie de ce produit ou document ne peut être reproduite sous aucune forme, par quelque moyen que ce soit, sans l'autorisation préalable et écrite de Sun et de ses bailleurs de licence, s'il y en a. Le logiciel détenu par des tiers, et qui comprend la technologie relative aux polices de caractères, est protégé par un copyright et licencié par des fournisseurs de Sun.

Des parties de ce produit pourront être dérivées des systèmes Berkeley BSD licenciés par l'Université de Californie. UNIX est une marque déposée aux Etats-Unis et dans d'autres pays et licenciée exclusivement par X/Open Company, Ltd.

Sun, Sun Microsystems, le logo Sun, AnswerBook2, docs.sun.com, Sun Fire, Sun StorEdge, et Solaris sont des marques de fabrique ou des marques déposées, ou marques de service, de Sun Microsystems, Inc. aux Etats-Unis et dans d'autres pays. Toutes les marques SPARC sont utilisées sous licence et sont des marques de fabrique ou des marques déposées de SPARC International, Inc. aux Etats-Unis et dans d'autres pays. Les produits portant les marques SPARC sont basés sur une architecture développée par Sun Microsystems, Inc.

L'interface d'utilisation graphique OPEN LOOK et Sun™ a été développée par Sun Microsystems, Inc. pour ses utilisateurs et licenciés. Sun reconnaît les efforts de pionniers de Xerox pour la recherche et le développement du concept des interfaces d'utilisation visuelle ou graphique pour l'industrie de l'informatique. Sun détient une licence non exclusive de Xerox sur l'interface d'utilisation graphique Xerox, cette licence couvrant également les licenciés de Sun qui mettent en place l'interface d'utilisation graphique OPEN LOOK et qui en outre se conforment aux licences écrites de Sun.

CETTE PUBLICATION EST FOURNIE "EN L'ETAT" ET AUCUNE GARANTIE, EXPRESSE OU IMPLICITE, N'EST ACCORDEE, Y COMPRIS DES GARANTIES CONCERNANT LA VALEUR MARCHANDE, L'APTITUDE DE LA PUBLICATION A REPOUDRE A UNE UTILISATION PARTICULIERE, OU LE FAIT QU'ELLE NE SOIT PAS CONTREFAISANTE DE PRODUIT DE TIERS. CE DENI DE GARANTIE NE S'APPLIQUERAIT PAS, DANS LA MESURE OU IL SERAIT TENU JURIDIQUEMENT NUL ET NON AVENU.



# Contents

---

- Preface 9**
  
- 1. Safety, Tools, and Configuration Requirements 1-1**
  - 1.1 Safety Precautions 1-1
  - 1.2 System Precautions 1-2
  - 1.3 Tools Required 1-2
  - 1.4 Device properties 1-3
  - 1.5 Configuration Requirements 1-5
  
- 2. Sun Fire 6800 System Rackmount Matrix 2-1**
  
- 3. Sun Fire 4810 System Rackmount Placement Matrix 3-1**
  
- 4. Sun Fire 4800 System Rackmount Placement Matrix 4-1**
  
- 5. Sun Fire 3800 System Rackmount Placement Matrix 5-1**
  
- 6. Sun Fire 4800/3800 Systems Rackmount Placement Matrix 6-1**
  
- A. Functional Power and Data Wiring Diagrams -1**
  - A.1 Sun Fire 6800 System Power Wiring Diagrams A-1
  - A.2 Sun Fire Cabinet System Power Wiring Diagrams A-6



# Figures

---

- FIGURE 1-1 Computer Equipment Mechanical Lift 1-4
- FIGURE 2-1 Sun Fire 6800 System—Front View 2-1
- FIGURE 3-1 Sun Fire 4810 Rackmounted System—Front View 3-1
- FIGURE 4-1 Sun Fire 4800 Rackmounted System—Front View 4-1
- FIGURE 5-1 Two Sun Fire 3800 Rackmounted Systems—Front View 5-1
- FIGURE 5-2 Sun Fire 3800 System Mounting Bracket Detail 5-2
- FIGURE 6-1 Sun Fire 4800/3800 Rackmounted Systems—Front View 6-1
- FIGURE 6-2 Sun Fire 3800 System Mounting Bracket Detail 6-2
- FIGURE A-1 Two RTU Assemblies and Two Independent AC Power Sources A-2
- FIGURE A-2 Two RTU Assemblies and One AC Power Sources A-2
- FIGURE A-3 RTU and RTS Modules A-3
- FIGURE A-4 Sun Fire 6800 System and One, Two or Three Sun StorEdge D240 Media Trays A-4
- FIGURE A-5 Sun Fire 6800 System and One Sun StorEdge D240 Media Tray and One Sun StorEdge A1000 Array or Sun StorEdge D1000 Array or Sun StorEdge T3 Array A-5
- FIGURE A-6 Two RTU Assemblies and Two Independent AC Power Sources A-6
- FIGURE A-7 Two RTU Assemblies and One AC Power Sources A-6
- FIGURE A-8 One RTU Assembly and Two Independent AC Power Sources A-7
- FIGURE A-9 One RTU Assembly and One AC Power Sources A-7
- FIGURE A-10 One Sun Fire 4810/4800/3800 System and One or Two Sun StorEdge D240 Media Trays A-8
- FIGURE A-11 One Sun Fire 4810/4800/3800 System, One Sun StorEdge D240 Media Tray, and One Sun StorEdge A1000 Array or Sun StorEdge D1000 Array or Sun StorEdge T3 Array A-9

- FIGURE A-12 One Sun Fire 4810/4800/3800 System, Two Sun StorEdge D240 Media Trays, and Two Sun StorEdge A1000 Arrays or Sun StorEdge D1000 Arrays or Sun StorEdge T3 Arrays A-10
- FIGURE A-13 Two Sun Fire 3800 Systems and One To Four Sun StorEdge D240 Media Trays A-11
- FIGURE A-14 Two Sun Fire 3800 Systems, Two Sun StorEdge D240 Media Trays, and One or Two Sun StorEdge A1000 Arrays or Sun StorEdge D1000 Arrays or Sun StorEdge T3 Arrays A-12
- FIGURE A-15 Three Sun Fire 3800 Systems and Three Sun StorEdge D240 Media Trays A-13
- FIGURE A-16 One Sun Fire 4800 System and One Sun Fire 3800 System and One or Two Sun StorEdge D240 Media Trays A-14
- FIGURE A-17 One Sun Fire 3800 System and FrameManager Data Connections A-15
- FIGURE A-18 One Sun Fire 4800 System and FrameManager Data Connections A-16
- FIGURE A-19 One Sun Fire 4810 System and FrameManager Data Connections A-17

# Tables

---

TABLE 1-1	Safety Precautions	1-1
TABLE 1-2	Sun Fire 6800/4810/4800/3800 Systems, Sun Fire Cabinet and Sun StorEdge Devices Properties	1-3
TABLE 2-1	Sun Fire 6800 System With Sun StorEdge D240 Media Trays	2-2
TABLE 2-2	Sun Fire 6800 System With Sun StorEdge D240 Media Tray and Sun StorEdge D1000 Array or Sun StorEdge A1000 Array	2-2
TABLE 2-3	Sun Fire 6800 System With Sun StorEdge D240 Media Tray and Sun StorEdge T3 Array	2-3
TABLE 3-1	Sun Fire 4810 System With Sun StorEdge D240 Media Trays	3-2
TABLE 3-2	Sun Fire 4810 System With Sun StorEdge D240 Media Tray and Sun StorEdge D1000 or A1000 or T3 Array	3-2
TABLE 3-3	Sun Fire 4810 System With Sun StorEdge D240 Media Trays and Sun StorEdge T3 Dual Array	3-3
TABLE 3-4	Sun Fire 4810 System With Sun StorEdge D240 Media Trays and Two Sun StorEdge T3 Arrays	3-3
TABLE 3-5	Sun Fire 4810 System With Sun StorEdge D240 Media Trays and Sun StorEdge D1000 or A1000 Arrays	3-4
TABLE 3-6	Sun Fire 4810 System With Sun StorEdge D240 Media Tray and Sun StorEdge D1000 or A1000 Array and Sun StorEdge T3 Array	3-4
TABLE 4-1	Sun Fire 4800 System With One or Two Sun StorEdge D240 Media Trays	4-2
TABLE 4-2	Sun Fire 4800 System With Sun StorEdge D240 Media Tray and One Sun StorEdge D1000 or A1000 or T3 Array	4-2
TABLE 4-3	Sun Fire 4800 System With Sun StorEdge D240 Media Trays and One Sun StorEdge T3 Dual Array	4-3

TABLE 4-4	Sun Fire 4800 System With Sun StorEdge D240 Media Trays and Sun StorEdge T3 Arrays	4-4
TABLE 4-5	Sun Fire 4800 System With Sun StorEdge D240 Media Trays and Sun StorEdge D1000 or A1000 Arrays	4-4
TABLE 4-6	Sun Fire 4800 System With Sun StorEdge D240 Media Tray and Sun StorEdge D1000 or A1000 Array and Sun StorEdge T3 Array	4-5
TABLE 5-1	Rackmounting Order	5-2
TABLE 5-2	Sun Fire 3800 System With Sun StorEdge D240 Media Trays	5-3
TABLE 5-3	Sun Fire 3800 System With Sun StorEdge D240 Media Trays and Sun StorEdge D1000 or A1000 or T3 Array	5-3
TABLE 5-4	Sun Fire 3800 System With Sun StorEdge D240 Media Trays and Sun StorEdge A1000 or D1000 Arrays	5-4
TABLE 5-5	Sun Fire 3800 System With Sun StorEdge D240 Media Trays and Sun StorEdge A1000 or D1000 Array and Sun StorEdge T3 Array	5-5
TABLE 5-6	Sun Fire 3800 System With Sun StorEdge D240 Media Trays and Sun StorEdge T3 Dual Array Unit	5-6
TABLE 5-7	Sun Fire 3800 System With Sun StorEdge D240 Media Trays and Sun StorEdge T3 Arrays	5-7
TABLE 5-8	Two Sun Fire 3800 Systems With Sun StorEdge D240 Media Trays and Sun StorEdge T3 Arrays	5-8
TABLE 5-9	Two Sun Fire 3800 Systems With Sun StorEdge D240 Media Trays and Sun StorEdge D1000 or A1000 Arrays	5-9
TABLE 5-10	One or Two Sun Fire 3800 Systems With One To Four Sun StorEdge D240 Media Trays	5-10
TABLE 5-11	Two Sun Fire 3800 Systems With Sun StorEdge D240 Media Trays and Sun StorEdge T3 Dual Array Unit	5-11
TABLE 5-12	Three Sun Fire 3800 Systems With Sun StorEdge D240 Arrays	5-12
TABLE 6-1	Sun Fire 4800/3800 Systems With One or Two Sun StorEdge D240 Media Trays	6-2



# Preface

---

This book describes where to install Sun™ StorEdge™ products into the Sun Fire™ 6800 system, or the Sun Fire Cabinet. Also described is where to install the Sun Fire 4810/4800/3800 systems into the Sun Fire Cabinet. For example, where to install a Sun Fire 3800 system, a Sun StorEdge D240 media tray and a Sun StorEdge D1000 array into a Sun Fire Cabinet are covered in this book. This book also presents power wiring diagrams for connecting power cables between the respective systems and storage products to the redundant transfer unit(s) (RTU) within the cabinet.

---

## Who Should Use This Book



---

**Caution** – This book is written for qualified service-trained maintenance providers. If you are not a qualified service-trained maintenance provider and you service the system, your warranty on the system will be void.

---

---

## How This Book Is Organized

This book contains the following chapters:

Chapter 1 describes the safety precautions and tools you will need.

Chapter 2 describes the Sun Fire 6800 system and where storage devices are mounted.

Chapter 3 describes the Sun Fire 4810 system and where storage devices are mounted.

Chapter 4 describes the Sun Fire 4800 system and where storage devices are mounted.

Chapter 5 describes the Sun Fire 3800 system and where storage devices are mounted.

Chapter 6 describes the Sun Fire 4800/3800 systems and where storage devices are mounted.

Appendix A describes all of the power wiring configurations.

---

## Related Documentation

---

<b>Application</b>	<b>Title</b>
Installation	<i>Sun Fire 6800 System Installation Guide</i>
	<i>Sun Fire 4810/4800/3800 Systems Installation Guide</i>
	<i>Sun Fire 4810/4800/3800 Systems Cabinet Mounting Guide</i>

---

---

## Accessing Sun Documentation

You can view, print, or purchase a broad selection of Sun documentation, including localized versions, at:

<http://www.sun.com/documentation>

---

## Contacting Sun Technical Support

If you have technical questions about this product that are not answered in this document, go to:

<http://www.sun.com/service/contacting>

---

# Sun Welcomes Your Comments

Sun is interested in improving its documentation and welcomes your comments and suggestions. You can submit your comments by going to:

<http://www.sun.com/hwdocs/feedback>

Please include the title and part number of your document with your feedback:

*Sun Fire 6800 System and Sun Fire Cabinet Rackmount Placement Matrix* , part number 816-2062-18

---

# Notes, Cautions, and Warnings



---

**Caution** – This equipment contains lethal voltage. Accidental contact with centerplane, card cage, and drive areas can result in serious injury or death.

---



---

**Caution** – Improper handling by unqualified personnel can cause serious damage to this equipment. Unqualified personnel who tamper with this equipment may be held liable for any resultant damage to the equipment.

---



---

**Caution** – The Sun Fire Cabinet should be pushed from the front only to prevent tipping the cabinet over.

---



---

**Caution** – Always use a computer mechanical lift for installing all systems or storage devices weighing more than 50 lbs (22.7 kg).

---

Individuals who remove any outer panels or open covers to access this equipment must observe all safety precautions and ensure compliance with skill level requirements, certification, and all applicable local and national laws.

For system compliance class and conformity information, refer to the system installation guide that came with your system.

Procedures contained in this document must be performed by qualified service-trained maintenance providers.

# Safety, Tools, and Configuration Requirements

---

This chapter describes the safety and system precautions you must take when mounting the systems or storage devices. It lists the tools and equipment you will need. It also discusses important configuration rules and requirements.

---

## 1.1 Safety Precautions

For your protection, observe the following safety precautions when servicing your equipment:

- Follow all cautions, warnings, and instructions marked on the equipment.
- Never push objects of any kind through openings in the equipment as they may touch dangerous voltage points or short out components that could result in fire or electric shock.
- Refer servicing of equipment to qualified personnel.

To protect both yourself and the equipment, observe the following safety precautions:

**TABLE 1-1** Safety Precautions

Item	Problem	Precaution
ESD wrist or foot strap	Electro-Static Discharge (ESD)	Each system except for the Sun Fire 3800 has an ESD socket. Connect the ESD banana connector to your system and wear the wrist strap or foot strap when handling printed circuit boards.
ESD mat	ESD	An approved ESD mat provides protection from static damage when used with a wrist strap or foot strap. The mat also cushions and protects small parts that are attached to printed circuit boards.

---

## 1.2 System Precautions

Ensure that the voltage and frequency of the power outlet to be used matches the electrical rating labels on the equipment.

Wear an ESD wrist/foot strap when handling any magnetic storage devices, CPU/Memory boards, or other printed circuit boards.

Use only properly grounded power outlets as described in the installation guides.



---

**Caution** – DO NOT make mechanical or electrical modifications to the system or the cabinet. Sun Microsystems™ is not responsible for regulatory compliance of modified cabinets.

---



---

**Caution** – The chassis AC power cord(s) must remain connected to ensure a proper ground.

---

---

## 1.3 Tools Required

For the procedures in this document, you will need these tools:

- Mechanical computer equipment lift
- Screwdriver, Phillips No. 2
- Screwdriver, Phillips No. 2 with six-inch shank
- ESD mat
- ESD grounding wrist strap or foot strap

## 1.4 Device properties

The following table describes all of the important properties of the systems and the various storage devices to be installed in the Sun Fire 6800 system and the Sun Fire cabinet.

The configurations in TABLE 1-2 have been tested, approved, and are supported by Sun Microsystems Inc.

**TABLE 1-2** Sun Fire 6800/4810/4800/3800 Systems, Sun Fire Cabinet and Sun StorEdge Devices Properties

Devices	Rack Units	Maximum Weights (Includes Mounting Brackets)	Power Cords Required	Maximum Devices Per Sun Fire 6800 System	Maximum Devices Per Sun Fire Cabinet <sup>1</sup>
Sun Fire cabinet	N/A	325 lbs (147 kg)	2 to 4	N/A	N/A
Sun Fire 6800 system	31	1030 lbs (467.2 kg)	4	1	N/A
Sun Fire 4810 system	21	326 lbs (147.87 kg)	3	N/A	1
Sun Fire 4800 system	18	302 lbs (137 kg)	3	N/A	1
Sun Fire 3800 system	9	209 lbs (94.8 kg)	3	N/A	3
Sun Fire V480 system	5	97 lbs (44 kg)	2	N/A	2
Sun Fire 280R system	4	75 lbs (34.0 kg)	2	N/A	3
Sun Enterprise 420R system	4	65 lbs. (29.5 kg)	2	N/A	3
Sun StorEdge A1000 array	4	80 lbs (36.28 kg)	2	1	2
Sun StorEdge D1000 array	4	80 lbs (36.28 kg)	2	1	2
Sun StorEdge T3 single array	4	87 lbs (39.46 kg)	2	1	2
Sun StorEdge T3 dual array	7	179 lbs (81.2 kg)	4	N/A	1
Sun StorEdge D240 media tray	2	50 lbs (22.68 kg)	2	3	4
Sun Netra T1 AC200/DC200	1	20 lbs (9.0 kg)	1	3	7
Sun Fire V100/V120 Server	1	20 lbs (9.0 kg)	1	3	15
RTU (with 2 RTs)	3	50 lbs (22.68 kg)	2	N/A	2

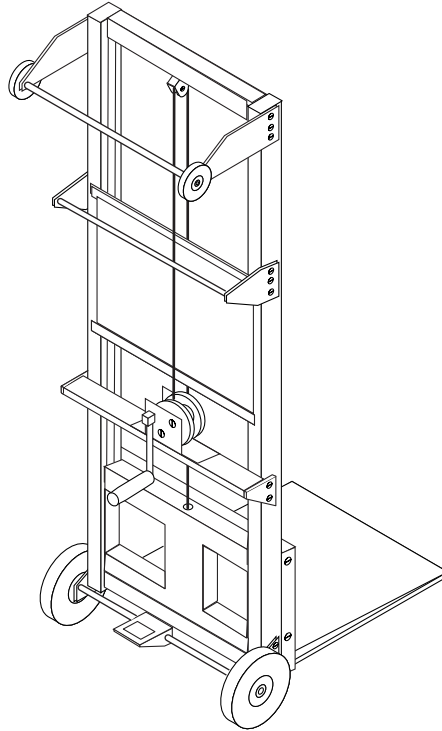
1. These numbers will vary depending on what system is installed in the Sun Fire Cabinet.



---

**Caution** – To prevent personal injury, use a computer equipment mechanical lift and two people to move any system or array weighing more than 50 lbs (22.7 kg) safely into the cabinet. See FIGURE 1-1.

---



**FIGURE 1-1** Computer Equipment Mechanical Lift



---

## 1.5 Configuration Requirements

Systems must be installed in the cabinet from the bottom up.

Storage devices must be installed directly above server systems in the cabinet, and installed from the bottom up.

Sun StorEdge D240 media trays must be installed from the top of the cabinet down.

The Sun Fire cabinet does not support any side-to-side cooled devices such as the Sun Enterprise™ 3500/4500/5500/6500 or Sun StorEdge A5X00 array. Only front-to-back cooled products are supported.

Up to three Sun Fire 3800 systems are supported in the Sun Fire Cabinet.

For maximum compute density, the Sun Fire 3800 systems should be mounted in the Sun Fire Cabinet. The Sun Fire 3800 system is also designed to fit in racks which meet the requirements of EIA-310-D.

The Sun Fire 3800 system rack mounting kits are designed to be used in the Sun Fire Cabinet, are not adjustable and may or may not work in other racks. When considering third party rack mounting, the third party thermal guidelines and the third party rack mounting guidelines should be reviewed.

The Sun Fire 280R, Sun Enterprise 420R, Sun Netra T1 AC200/DC200, and Sun Fire V100/V120 servers must be mounted above the Sun Fire systems.

Front plastic filler panels must be installed to fill in any open spaces within the Sun Fire cabinet. The 1RU plastic filler panel comes with the Sun Fire cabinet. If mounting either the Sun Fire 280R, Sun Enterprise 420R, Sun Netra T1 AC200/DC200, or Sun Fire V100/V120 server in a cabinet with two Sun Fire 3800 systems, you will need a 1/2 RU metal filler panel.



---

**Caution** – All empty spaces in the cabinet must be filled with front plastic filler panels to prevent the recycling of heated exhausted cooling air from the rear of the system.

---

Maximum amperes supported from each RTU (with two RTSs installed) is 24 amperes. Each RTU has eight switched, two unswitched, and two dedicated Sun Fire 6800 outlets. A second RTU must be installed when more than 24 amperes are required or more than eight switched outlets are required.

Maximum weight capacity of a cabinet is 1200 pounds.

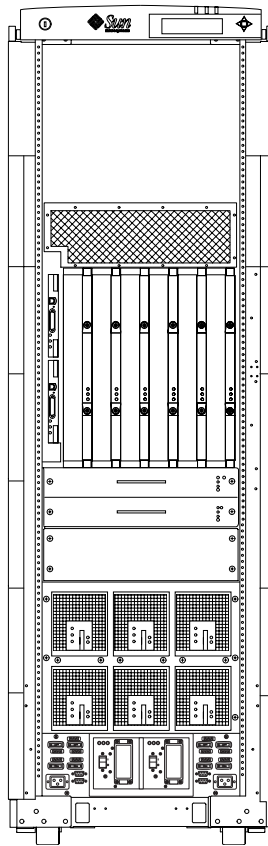
---

**Note** – Before you begin, carefully read each of the procedures in this manual. If you have not performed similar operations on comparable equipment, *do not attempt* to perform these procedures.

---

# Sun Fire 6800 System Rackmount Matrix

This chapter describes where to mount various storage devices within the Sun Fire 6800 system cabinet.



**FIGURE 2-1** Sun Fire 6800 System—Front View



---

**Caution** – Empty space in the cabinet must be filled with filler panels to prevent the recycling of heated, exhausted air from the rear of the system. Filler panels range from 1 RU to 5 RU in size.

---

---

**Note** – (\*) Indicates the key hole slot used for rail locations.

---

**TABLE 2-1** Sun Fire 6800 System With Sun StorEdge D240 Media Trays

System/Storage Device	Rack Hole Numbers Used To Mount Rails	Rack Holes To Mount Device	Used Rack Units	Available Rack Units
Sun Fire 6800 system			31	
Sun StorEdge D240 media tray #1	110, *113	111, 112	2	
Sun StorEdge D240 media tray #2	104, *107	105, 106	2	
Sun StorEdge D240 media tray #3	98, *101	99, 102	2	
Total			37	1

See FIGURE A-4 for power wiring diagram for TABLE 2-1.

**TABLE 2-2** Sun Fire 6800 System With Sun StorEdge D240 Media Tray and Sun StorEdge D1000 Array or Sun StorEdge A1000 Array

System/Storage Device	Rack Hole Numbers Used To Mount Rails	Rack Holes To Mount Device	Used Rack Units	Available Rack Units
Sun Fire 6800 system			31	
Sun StorEdge D240 media tray	110, *113	111, 112	2	
Sun StorEdge D1000 array or Sun StorEdge A1000 array	96, *99	98, 101	4	
Total			37	1

See FIGURE A-5 for power wiring diagram for TABLE 2-2 and TABLE 2-3.

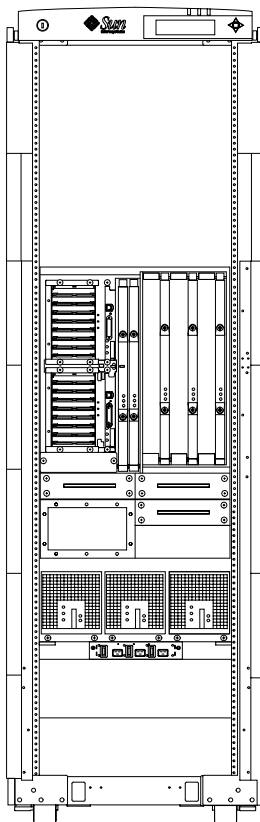
**TABLE 2-3** Sun Fire 6800 System With Sun StorEdge D240 Media Tray and Sun StorEdge T3 Array

<b>System/Storage Device</b>	<b>Rack Hole Numbers Used To Mount Rails</b>	<b>Rack Holes To Mount Device</b>	<b>Used Rack Units</b>	<b>Available Rack Units</b>
Sun Fire 6800 system			31	
Sun StorEdge D240 media tray	110, *113	111, 112	2	
Sun StorEdge T3 array	98, *102	99, 102	4	
<b>Total</b>			<b>37</b>	<b>1</b>



## Sun Fire 4810 System Rackmount Placement Matrix

This chapter describes where to mount various storage devices within the Sun Fire 4810 system cabinet.



**FIGURE 3-1** Sun Fire 4810 Rackmounted System—Front View



---

**Caution** – Empty space in the cabinet must be filled with filler panels to prevent the recycling of heated, exhausted air from the rear of the system. Filler panels range from 1 RU to 5 RU in size.

---

---

**Note** – (\*) Indicates the key hole slot used for rail location.

---

See for power wiring diagram for TABLE 3-1.

**TABLE 3-1** Sun Fire 4810 System With Sun StorEdge D240 Media Trays

	<b>Rack Hole Numbers Used To Mount Rails</b>	<b>Rack Holes To Mount Device</b>	<b>Used Rack Units</b>	<b>Available Rack Units</b>
RTU Rear	*1, 7		3	
RTU Front (for reference only)	*10, 16		3	
Sun Fire 4810 system	20, *22		21	
Sun StorEdge D240 media tray #1	110, *113	111, 112	2	
Sun StorEdge D240 media tray #2	104, *107	105, 106	2	
Total			31	7

See FIGURE A-11 for power wiring diagram for TABLE 3-2.

**TABLE 3-2** Sun Fire 4810 System With Sun StorEdge D240 Media Tray and Sun StorEdge D1000 or A1000 or T3 Array

	<b>Rack Hole Numbers Used To Mount Rails</b>	<b>Rack Holes To Mount Device</b>	<b>Used Rack Units</b>	<b>Available Rack Units</b>
RTU Rear	*1, 7		3	
RTU Front (for reference only)	*10, 16		3	
Sun Fire 4810 system	20, *22		21	
Sun StorEdge D240 media tray	110, *113	111, 112	2	
Sun StorEdge A1000 or Sun StorEdge D1000 or Sun StorEdge T3 array	84, *87 84, *87 86, *90	86, 89 86, 89 87, 90	4	
Total			33	5



See FIGURE A-12 for power wiring diagram for TABLE 3-3.

**TABLE 3-3** Sun Fire 4810 System With Sun StorEdge D240 Media Trays and Sun StorEdge T3 Dual Array

	<b>Rack Hole Numbers Used To Mount Rails</b>	<b>Rack Holes To Mount Device</b>	<b>Used Rack Units</b>	<b>Available Rack Units</b>
RTU Rear	*1, 7		3	
RTU Front	*10, 16		3	
Sun Fire 4810 system	20, *22		21	
Sun StorEdge D240 media tray #1	110, *113	111, 112	2	
Sun StorEdge D240 media tray #2	104, *107	105, 106	2	
Sun StorEdge T3 dual array	85, 90, *100	85, 90	7	
Total			38	0

See FIGURE A-12 for power wiring diagram for TABLE 3-4.

**TABLE 3-4** Sun Fire 4810 System With Sun StorEdge D240 Media Trays and Two Sun StorEdge T3 Arrays

	<b>Rack Hole Numbers Used To Mount Rails</b>	<b>Rack Holes To Mount Device</b>	<b>Used Rack Units</b>	<b>Available Rack Units</b>
RTU Rear	*1, 7		3	3
RTU Front	*10, 16		3	3
Sun Fire 4810 system	20, *22		21	21
Sun StorEdge D240 media tray #1	110, *113	111, 112	2	2
Sun StorEdge D240 media tray #2	104, *107	105, 106		2
Sun StorEdge T3 array #1	86, *90	87, 90	4	4
Sun StorEdge T3 array #2	98, *102	99, 102	4	
Total			37	35 1 or 3

See FIGURE A-12 for power wiring diagram for TABLE 3-5 and TABLE 3-6.

**TABLE 3-5** Sun Fire 4810 System With Sun StorEdge D240 Media Trays and Sun StorEdge D1000 or A1000 Arrays

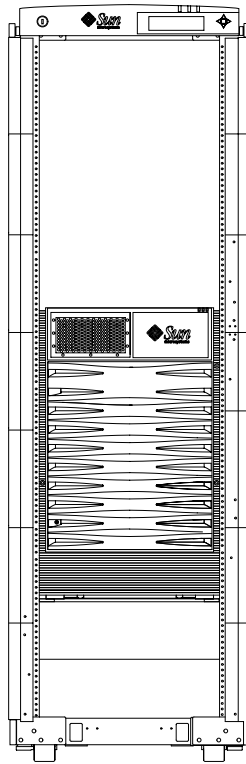
	<b>Rack Hole Numbers Used To Mount Rails</b>	<b>Rack Holes To Mount Device</b>	<b>Used Rack Units</b>		<b>Available Rack Units</b>
RTU Rear	*1, 7		3	3	
RTU Front	*10, 16		3	3	
Sun Fire 4810 system	20, *22		21	21	
Sun StorEdge D240 media tray #1	110, *113	111, 112	2	2	
Sun StorEdge D240 media tray #2	104, *107	105, 106		2	
Sun StorEdge D1000 array or Sun StorEdge A1000 array	84, *87	86, 89	4	4	
Sun StorEdge D1000 array or Sun StorEdge A1000 array	96, *99	98, 101	4		
Total			37	35	1 or 3

**TABLE 3-6** Sun Fire 4810 System With Sun StorEdge D240 Media Tray and Sun StorEdge D1000 or A1000 Array and Sun StorEdge T3 Array

	<b>Rack Hole Numbers Used To Mount Rails</b>	<b>Rack Holes To Mount Device</b>	<b>Used Rack Units</b>	<b>Available Rack Units</b>
RTU Rear	*1, 7		3	
RTU Front	*10, 16		3	
Sun Fire 4810 system	20, *22		21	
Sun StorEdge D240 media tray	110, *113	111, 112	2	
Sun StorEdge A1000 array or Sun StorEdge D1000 array	84, *87	86, 89	4	
Sun StorEdge T3 array	98, *102	99, 102	4	
Total			37	1

# Sun Fire 4800 System Rackmount Placement Matrix

This chapter describes where to mount various storage devices within the Sun Fire 4800 system cabinet.



**FIGURE 4-1** Sun Fire 4800 Rackmounted System—Front View



---

**Caution** – The Sun Fire 4800 system must always have a 1/2 RU front metal filler panel in the space above it. Empty space in the cabinet must be filled with filler panels to prevent the recycling of heated, exhausted air from the rear of the system. Filler panels range from 1 RU to 5 RU in size.

---

---

**Note** – (\*) Indicates the key hole slot used for rail location.

---

See for power wiring diagram for TABLE 4-1.

**TABLE 4-1** Sun Fire 4800 System With One or Two Sun StorEdge D240 Media Trays

	<b>Rack Hole Numbers Used To Mount Rails</b>	<b>Rack Holes To Mount Device</b>	<b>Used Rack Units</b>	<b>Available Rack Units</b>
RTU Rear	*1, 7		3	
RTU Front (for reference only)	*10, 16		3	
Sun Fire 4800 system	21, *24 *66, 68		18	
Sun Fire 1/2 RU filler panel	71 (tabs down)			
Sun StorEdge D240 media tray #1	110, *113	111, 112	2	
Sun StorEdge D240 media tray #2	104, *107	105, 106	2	
Total			28	10

See FIGURE A-11 for power wiring diagram for TABLE 4-2.

**TABLE 4-2** Sun Fire 4800 System With Sun StorEdge D240 Media Tray and One Sun StorEdge D1000 or A1000 or T3 Array

	<b>Rack Hole Numbers Used To Mount Rails</b>	<b>Rack Holes To Mount Device</b>	<b>Used Rack Units</b>	<b>Available Rack Units</b>
RTU Rear	*1, 7		3	
RTU Front (for reference only)	*10, 16		3	
Sun Fire 4800 system	21, *24 *66, 68		18	
Sun Fire 1/2 RU filler panel	71 (tabs down)			

See FIGURE A-11 for power wiring diagram for TABLE 4-2.

**TABLE 4-2** Sun Fire 4800 System With Sun StorEdge D240 Media Tray and One Sun StorEdge D1000 or A1000 or T3 Array

	<b>Rack Hole Numbers Used To Mount Rails</b>	<b>Rack Holes To Mount Device</b>	<b>Used Rack Units</b>	<b>Available Rack Units</b>
Sun StorEdge D240 media tray	110, *113	111, 112	2	
Sun StorEdge D1000 array or Sun StorEdge A1000 array or Sun StorEdge T3	75, *78 75, *78 77, 81	77, 80 77, 80 78, 81	4	
<b>Total</b>			30	8

See FIGURE A-12 for power wiring diagram for TABLE 4-3 and TABLE 4-4.

**TABLE 4-3** Sun Fire 4800 System With Sun StorEdge D240 Media Trays and One Sun StorEdge T3 Dual Array

	<b>Rack Hole Numbers Used To Mount Rails</b>	<b>Rack Holes To Mount Device</b>	<b>Used Rack Units</b>	<b>Available Rack Units</b>
RTU Rear	*1, 7		3	
RTU Front	*10, 16		3	
Sun Fire 4800 system	21, *24 *66, 68		18	
Sun Fire 1/2 RU filler panel	71 (tabs down)			
Sun StorEdge D240 media tray #1	110, *113	111, 112	2	
Sun StorEdge D240 media tray #2	104, *107	105, 106	2	
Sun StorEdge T3 dual array	76, 81, *91	76, 81	7	
<b>Total</b>			35	3

**TABLE 4-4** Sun Fire 4800 System With Sun StorEdge D240 Media Trays and Sun StorEdge T3 Arrays

	<b>Rack Hole Numbers Used To Mount Rails</b>	<b>Rack Holes To Mount Device</b>	<b>Used Rack Units</b>			<b>Available Rack Units</b>
RTU Rear	*1, 7		3	3	3	
RTU Front	*10, 16		3	3	3	
Sun Fire 4800 system	21, *24 *66, 68		18	18	18	
Sun Fire 1 RU filler panel	72		1	1	1	
Sun StorEdge D240 media tray #1	110, *113	111, 112	2	2	2	
Sun StorEdge D240 media tray #2	104, *107	105, 106		2	2	
Sun StorEdge T3 array #1	77, *81	78, 81	4	4	4	
Sun StorEdge T3 array #2	89, *93	90, 93	4		4	
<b>Total</b>			<b>35</b>	<b>33</b>	<b>37</b>	<b>3 or 5 or 1</b>

See FIGURE A-12 for power wiring diagram for TABLE 4-5 and TABLE 4-6.

**TABLE 4-5** Sun Fire 4800 System With Sun StorEdge D240 Media Trays and Sun StorEdge D1000 or A1000 Arrays

	<b>Rack Hole Numbers Used To Mount Rails</b>	<b>Rack Holes To Mount Device</b>	<b>Used Rack Units</b>			<b>Available Rack Units</b>
RTU Rear	*1, 7		3	3	3	
RTU Front	*10, 16		3	3	3	
Sun Fire 4800 system	21, *24 *66, 68		18	18	18	
Sun Fire 1/2 RU filler panel	71 (tabs down)					
Sun StorEdge D240 media tray #1	110, *113	111, 112	2	2	2	
Sun StorEdge D240 media tray #2	104, *107	105, 106		2	2	
Sun StorEdge D1000 array or Sun StorEdge A1000 array	75, *78	77, 80	4	4	4	
Sun StorEdge D1000 array or Sun StorEdge A1000 array	87, *90	89, 92	4		4	
<b>Total</b>			<b>34</b>	<b>32</b>	<b>36</b>	<b>4 or 6 or 2</b>

**TABLE 4-6** Sun Fire 4800 System With Sun StorEdge D240 Media Tray and Sun StorEdge D1000 or A1000 Array and Sun StorEdge T3 Array

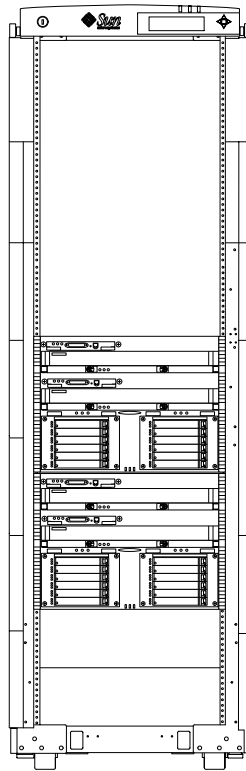
	<b>Rack Hole Numbers Used To Mount Rails</b>	<b>Rack Holes To Mount Device</b>	<b>Used Rack Units</b>	<b>Available Rack Units</b>
RTU Rear	*1, 7		3	
RTU Front	*10, 16		3	
Sun Fire 4800 system	21, *24 *66, 68		18	
Sun Fire 1 RU filler panel	72		1	1
Sun StorEdge D240 media tray	110, *113	111, 112	2	
Sun StorEdge D1000 array or Sun StorEdge A1000 array	75, *78	77, 80	4	
Sun StorEdge T3 array	89, *93	90, 93	4	
<b>Total</b>			<b>35</b>	<b>3</b>





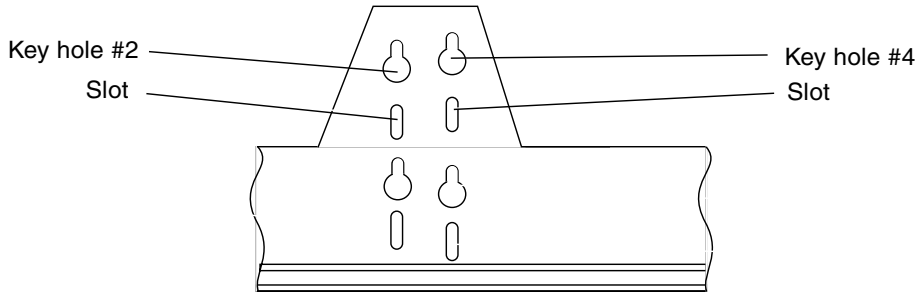
# Sun Fire 3800 System Rackmount Placement Matrix

This chapter describes where to mount various storage devices within the Sun Fire 3800 system cabinet.



**FIGURE 5-1** Two Sun Fire 3800 Rackmounted Systems—Front View

This section contains hole assignments for Sun Fire 3800 systems and Sun storage products that can be mounted in the Sun Fire cabinet. Supported configurations are listed in the following tables. Front and rear holes are the same.



**FIGURE 5-2** Sun Fire 3800 System Mounting Bracket Detail

Each bracket is labeled “RIGHT” or “LEFT”. The orientation is when viewed from the front of the system.

**TABLE 5-1** Rackmounting Order

Sun Fire 3800 System Mounting Position	Hole Count From Bottom of Cabinet
System #3 (top)	Top screw: use bracket key hole #4 at cabinet hole #78 Bottom screw: in slot at cabinet hole #72
System #2 (middle)	Top screw: use bracket key hole #2 at cabinet hole #52 Bottom screw: in slot at cabinet hole #47
System #1 (bottom)	Top screw: use bracket key hole #4 at cabinet hole #26 Bottom screw: in slot at cabinet hole #20

**Note** – (\*) Indicates the key hole used for rail location.



**Caution** – When two Sun Fire 3800 systems are installed, you must always have a 1/2 RU metal filler panel in the space above it. Empty space in the cabinet must be filled with filler panels to prevent the recycling of heated, exhausted air from the rear of the system. Filler panels range from 1 RU to 5 RU in size.

See for power wiring diagram for TABLE 5-2.

**TABLE 5-2** Sun Fire 3800 System With Sun StorEdge D240 Media Trays

	<b>Rack Hole Numbers Used To Mount Rails</b>	<b>Rack Holes To Mount Device</b>	<b>Used Rack Units</b>	<b>Available Rack Units</b>
RTU Rear	*1, 7		3	
RTU Front (for reference only)	*10, 16		3	
Sun Fire 3800 system	See TABLE 5-1		9	
Sun StorEdge D240 media tray #1	110, *113	111, 112	2	
Sun StorEdge D240 media tray #2	104, *107	105, 106	2	
Total			19	19

See FIGURE A-11 for power wiring diagram for TABLE 5-3.

**TABLE 5-3** Sun Fire 3800 System With Sun StorEdge D240 Media Trays and Sun StorEdge D1000 or A1000 or T3 Array

	<b>Rack Hole Numbers Used To Mount Rails</b>	<b>Rack Holes To Mount Device</b>	<b>Used Rack Units</b>	<b>Available Rack Units</b>
RTU Rear	*1, 7		3	
RTU Front (for reference only)	*10, 16		3	
Sun Fire 3800 system	See TABLE 5-1		9	
Sun StorEdge D240 media tray	110, *113	111, 112	2	
Sun StorEdge D1000 array or Sun StorEdge A1000 array or Sun StorEdge T3 array	48, *51	50, 53	4	
	49, *53	50, 53		
Total			21	17

See FIGURE A-12 for power wiring diagram for TABLE 5-4.

**TABLE 5-4** Sun Fire 3800 System With Sun StorEdge D240 Media Trays and Sun StorEdge A1000 or D1000 Arrays

	<b>Rack Hole Numbers Used To Mount Rails</b>	<b>Rack Holes To Mount Device</b>	<b>Used Rack Units</b>			<b>Available Rack Units</b>
RTU Rear	*1, 7		3	3	3	
RTU Front	*10, 16		3	3	3	
Sun Fire 3800 system	See TABLE 5-1		9	9	9	
Sun StorEdge D240 media tray #1	110, *113	111, 112	2	2	2	
Sun StorEdge D240 media tray #2	104, *107	105, 106		2	2	
Sun StorEdge A1000 array or Sun StorEdge D1000 array #1	48, *51	50, 53	4	4	4	
Sun StorEdge A1000 array or Sun StorEdge D1000 array #2	60, *63	62, 65	4		4	
<b>Total</b>			<b>25</b>	<b>23</b>	<b>27</b>	<b>13 or 15 or 11</b>

See FIGURE A-12 for power wiring diagram for TABLE 5-5.

**TABLE 5-5** Sun Fire 3800 System With Sun StorEdge D240 Media Trays and Sun StorEdge A1000 or D1000 Array and Sun StorEdge T3 Array

	<b>Rack Hole Numbers Used To Mount Rails</b>	<b>Rack Holes To Mount Device</b>	<b>Used Rack Units</b>	<b>Available Rack Units</b>
RTU Rear	*1, 7		3	
RTU Front	*10, 16		3	
Sun Fire 3800 system	See TABLE 5-1		9	
Sun StorEdge D240 media tray #1	110, *113	111, 112	2	
Sun StorEdge D240 media tray #2	104, *107	105, 106	2	
Sun StorEdge A1000 array or Sun StorEdge D1000 array	48, *51	50, 53	4	
Sun StorEdge T3 array	62, *66	63, 66	4	
<b>Total</b>			<b>27</b>	<b>11</b>

See FIGURE A-12 for power wiring diagram for TABLE 5-6.

**TABLE 5-6** Sun Fire 3800 System With Sun StorEdge D240 Media Trays and Sun StorEdge T3 Dual Array Unit

	<b>Rack Hole Numbers Used To Mount Rails</b>	<b>Rack Holes To Mount Device</b>	<b>Used Rack Units</b>	<b>Available Rack Units</b>
RTU Rear	*1, 7		3	
RTU Front	*10, 16		3	
Sun Fire 3800 system	See TABLE 5-1		9	
Sun StorEdge D240 media tray #1	110, *113	111, 112	2	
Sun StorEdge D240 media tray #2	104, *107	105, 106	2	
Sun StorEdge T3 dual array unit	49, 54, *64	49, 54	7	
Total			26	12

See FIGURE A-12 for power wiring diagram for TABLE 5-7.

**TABLE 5-7** Sun Fire 3800 System With Sun StorEdge D240 Media Trays and Sun StorEdge T3 Arrays

	<b>Rack Hole Numbers Used To Mount Rails</b>	<b>Rack Holes To Mount Device</b>	<b>Used Rack Units</b>			<b>Available Rack Units</b>
RTU Rear	*1, 7		3	3	3	
RTU Front	*10, 16		3	3	3	
Sun Fire 3800 system	See TABLE 5-1		9	9	9	
Sun StorEdge D240 media tray #1	110, *113	111, 112	2	2	2	
Sun StorEdge D240 media tray #2	104, *107	105, 106		2	2	
Sun StorEdge T3 array #1	49, *53	50, 53	4	4	4	
Sun StorEdge T3 array #2	61, *65	62, 65	4		4	
<b>Total</b>			<b>25</b>	<b>23</b>	<b>27</b>	<b>13 or 15 or 11</b>

See FIGURE A-13 for power wiring diagram for TABLE 5-8.

**TABLE 5-8** Two Sun Fire 3800 Systems With Sun StorEdge D240 Media Trays and Sun StorEdge T3 Arrays

	<b>Rack Hole Numbers Used To Mount Rails</b>	<b>Rack Holes To Mount Device</b>	<b>Used Rack Units</b>			<b>Available Rack Units</b>
RTU Rear	*1, 7		3	3	3	
RTU Front	*10, 16		3	3	3	
Sun Fire 3800 system #1	See TABLE 5-1		9	9	9	
Sun Fire 3800 system #2	See TABLE 5-1		9	9	9	
Sun Fire 1/2 RU filler panel	72 (tabs up)					
Sun StorEdge D240 media tray #1	110, *113	111, 112	2	2	2	
Sun StorEdge D240 media tray #2	104, *107	105, 106		2	2	
Sun StorEdge T3 array #1	76, *80	77, 80	4	4	4	
Sun StorEdge T3 array #2	88, *92	89, 92	4		4	
<b>Total</b>			<b>34</b>	<b>32</b>	<b>36</b>	<b>4 or 6 or 2</b>



See FIGURE A-14 for power wiring diagram for TABLE 5-9.

**TABLE 5-9** Two Sun Fire 3800 Systems With Sun StorEdge D240 Media Trays and Sun StorEdge D1000 or A1000 Arrays

	<b>Rack Hole Numbers Used To Mount Rails</b>	<b>Rack Holes To Mount Device</b>	<b>Used Rack Units</b>			<b>Available Rack Units</b>
RTU Rear	*1, 7		3	3	3	
RTU Front	*10, 16		3	3	3	
Sun Fire 3800 system #1	See TABLE 5-1		9	9	9	
Sun Fire 3800 system #2	See TABLE 5-1		9	9	9	
Sun StorEdge D240 media tray #1	110, *113	111, 112	2	2	2	
Sun StorEdge D240 media tray #2	104, *107	105, 106		2	2	
Sun StorEdge A1000 array or Sun StorEdge D1000 array #1	75, *78	77, 80	4	4	4	
Sun StorEdge A1000 array or Sun StorEdge D1000 array #2	87, *90	89, 92	4		4	
<b>Total</b>			<b>34</b>	<b>32</b>	<b>36</b>	<b>4 or 6 or 2</b>

See FIGURE A-13 for power wiring diagram for TABLE 5-10.

**TABLE 5-10** One or Two Sun Fire 3800 Systems With One To Four Sun StorEdge D240 Media Trays

	<b>Rack Hole Numbers Used To Mount Rails</b>	<b>Rack Holes To Mount Device</b>	<b>Used Rack Units</b>		<b>Available Rack Units</b>
RTU Rear	*1, 7		3	3	
RTU Front	*10, 16		3	3	
Sun Fire 3800 system #1	See TABLE 5-1		9	9	
Sun Fire 3800 system #2	See TABLE 5-1			9	
Sun StorEdge D240 media tray #1	110, *113	111, 112	2	2	
Sun StorEdge D240 media tray #2	104, *107	105, 106	2	2	
Sun StorEdge D240 media tray #3	98, *101	99, 100	2	2	
Sun StorEdge D240 media tray #4	92, *95	93, 94	2	2	
<b>Total</b>			<b>23</b>	<b>32</b>	<b>15 or 6</b>

See FIGURE A-14 for power wiring diagram for TABLE 5-11.

**TABLE 5-11** Two Sun Fire 3800 Systems With Sun StorEdge D240 Media Trays and Sun StorEdge T3 Dual Array Unit

	<b>Rack Hole Numbers Used To Mount Rails</b>	<b>Rack Holes To Mount Device</b>	<b>Used Rack Units</b>	<b>Available Rack Units</b>
RTU Rear	*1, 7		3	
RTU Front	*10, 16		3	
Sun Fire 3800 system #1	See TABLE 5-1		9	
Sun Fire 3800 system #2	See TABLE 5-1		9	
Sun StorEdge D240 media tray #1	110, *113	111, 112	2	
Sun StorEdge D240 media tray #2	104, *107	105, 106	2	
Sun StorEdge T3 dual array unit	76, 81, *91	76, 81	7	
<b>Total</b>			<b>35</b>	<b>3</b>

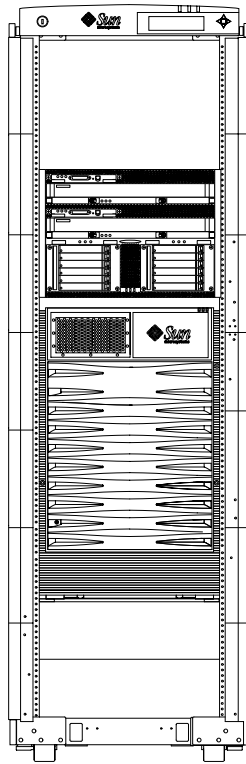
See FIGURE A-15 for power wiring diagram for TABLE 5-12.

**TABLE 5-12** Three Sun Fire 3800 Systems With Sun StorEdge D240 Arrays

	<b>Rack Hole Numbers Used To Mount Rails</b>	<b>Rack Holes To Mount Device</b>	<b>Used Rack Units</b>	<b>Available Rack Units</b>
RTU Rear	*1, 7		3	
RTU Front	*10, 16		3	
Sun Fire 3800 system #1	SEE Table 5-1		8.5	
Sun Fire 3800 system #2	SEE Table 5-1		8.5	
Sun Fire 3800 system #3	SEE Table 5-1		8.5	
Sun StorEdge D240 array #1	110, *113	111, 112	2	
Sun StorEdge D240 array #2	104, *107	105, 106	2	
Sun StorEdge D240 array #3	98, *101	99, 100	2	
Total			38	0

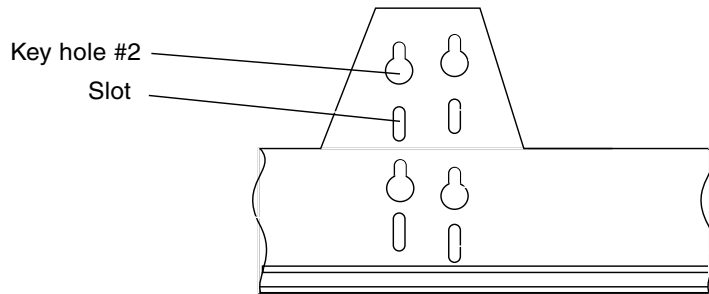
## Sun Fire 4800/3800 Systems Rackmount Placement Matrix

This chapter describes where to mount various storage devices within the Sun Fire 4800/3800 systems cabinet.



**FIGURE 6-1** Sun Fire 4800/3800 Rackmounted Systems—Front View

This section contains hole assignments for Sun Fire 3800 system and the Sun Fire 4800 system mounted in the Sun Fire cabinet. Front and rear holes are the same



**FIGURE 6-2** Sun Fire 3800 System Mounting Bracket Detail

Each bracket is labeled “RIGHT” or “LEFT”. The orientation is when viewed from the front of the system.



**Caution** – The Sun Fire 4800 system must always have a 1/2 RU front metal filler panel in the space above it. Empty space in the cabinet must be filled with filler panels to prevent the recycling of heated, exhausted air from the rear of the system. Filler panels range from 1 RU to 5 RU in size.

**Note** – (\*) Indicates the key hole (#2 for 3800 system only) used for rail location.

See FIGURE A-16 for power wiring diagram for TABLE 6-1..

**TABLE 6-1** Sun Fire 4800/3800 Systems With One or Two Sun StorEdge D240 Media Trays

	Rack Hole Numbers Used To Mount Rails	Rack Holes To Mount Device	Used Rack Units	Available Rack Units
RTU Rear	*1, 7		3	
RTU Front	*10, 16		3	
Sun Fire 4800 system	21, *24 *66, 68		18	
Sun Fire 1/2 RU filler panel	71 (tabs down)			
Sun Fire 3800 system	74, *79		9	

**TABLE 6-1** Sun Fire 4800/3800 Systems With One or Two Sun StorEdge D240 Media Trays (Continued)

	<b>Rack Hole Numbers Used To Mount Rails</b>	<b>Rack Holes To Mount Device</b>	<b>Used Rack Units</b>	<b>Available Rack Units</b>
Sun StorEdge D240 media tray #1	110, *113	111, 112	2	
Sun StorEdge D240 media tray #2	104, *107	105, 106	2	
Total			37	1





# Functional Power and Data Wiring Diagrams

---

This appendix provides functional power wiring diagrams of the Sun Fire 6800 system and the Sun Fire cabinet with Sun Fire 4810/4800/3800 systems and SunStorEdge products.

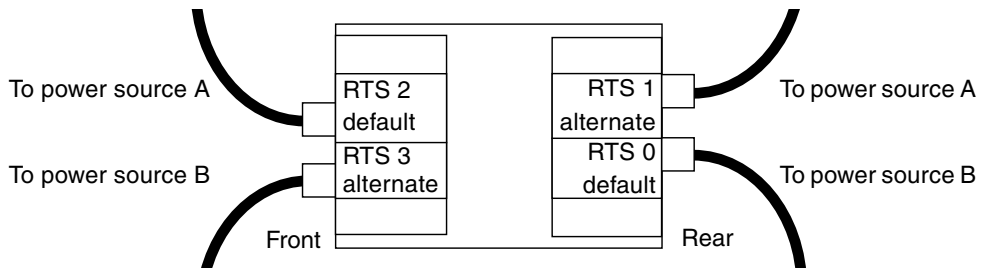
---

## A.1 Sun Fire 6800 System Power Wiring Diagrams

The Sun Fire 6800 system is already mounted in its own exclusive cabinet. The following diagrams show how to connect the power cables from the RTUs in the cabinet to the system, cabinet fan trays, and various storage products.

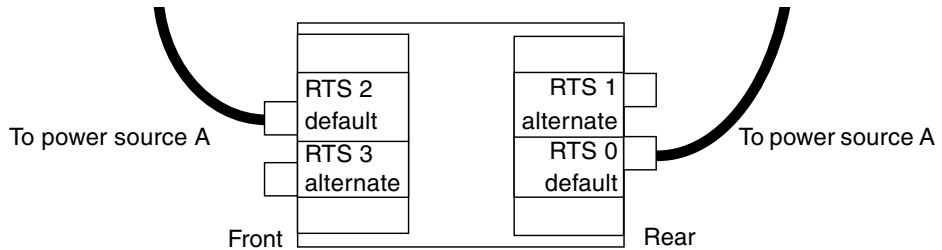
The Sun Fire 6800 system has dual Redundant Transfer Units (RTUs) with four Redundant Transfer Switches (RTSs). Two totally independent AC power sources are needed for input power redundancy. The AC power sources must be derived from independent power company utility feeds and Sun recommends that each be backed up with an on-line UPS. The power sources are not independent if they are only distinguished by having separate circuit breakers. One RTS hooked to an AC power source and the second RTS hooked to a UPS that is connected to the same AC power source is not supported because when the UPS is by-passed for maintenance both RTSs will be hooked up to the same source. If both RTSs are hooked to one utility feed then both lines must be backed up with on-line UPSs to ensure input power redundancy.

- In configurations with two RTU assemblies and two independent AC power sources there will be four cables to connect, two on the front, and two on the rear of the system (FIGURE A-1).



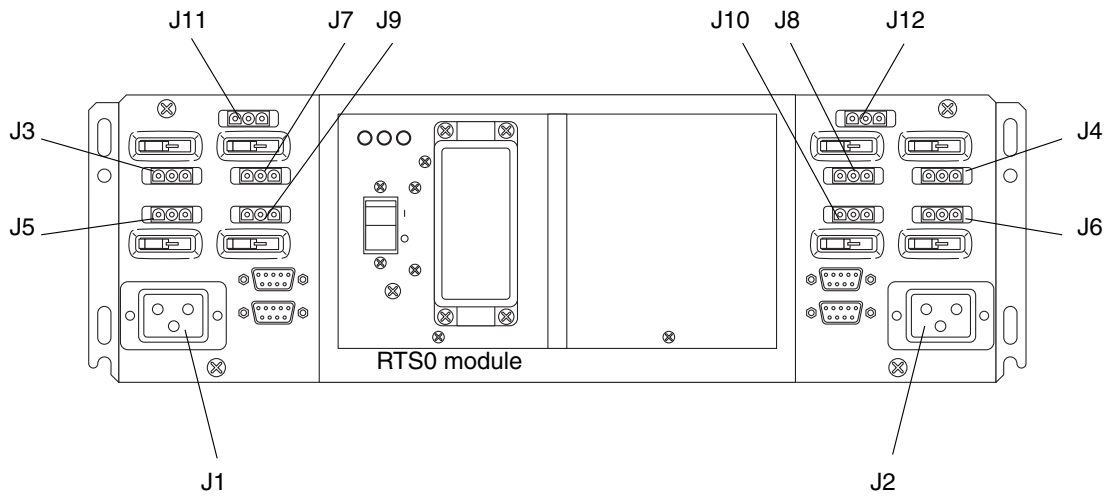
**FIGURE A-1** Two RTU Assemblies and Two Independent AC Power Sources

- In configurations with two RTU assemblies and one AC power sources there will be two cables to connect, one in the front (on the left), and one in the rear of the system (on the left) (FIGURE A-2). **Connecting the alternate RTS units to outlets that use the same power source as the default RTS units is not supported and will adversely affect reliability.**



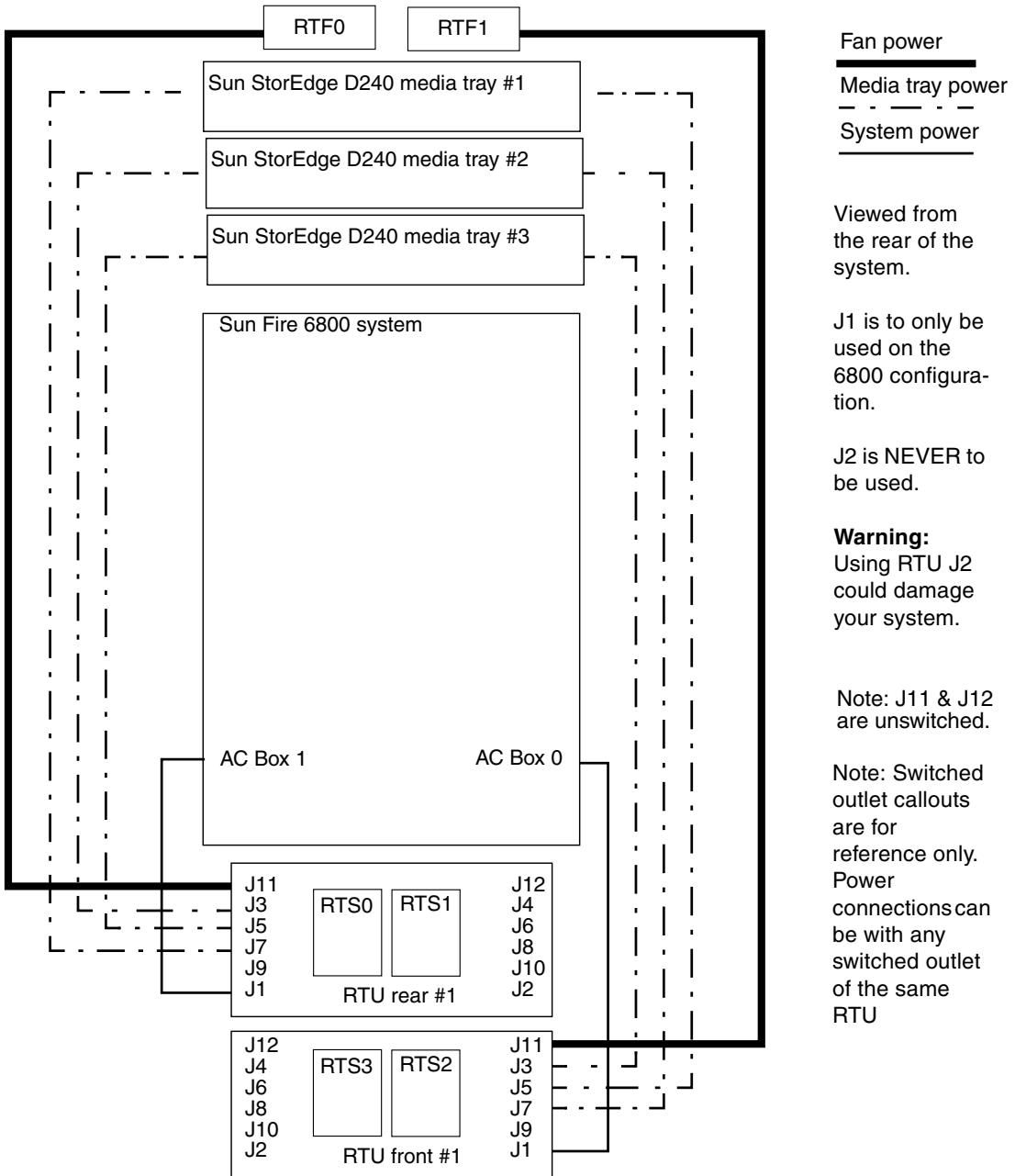
**FIGURE A-2** Two RTU Assemblies and One AC Power Sources

Every piece of support equipment requires its own customer-supplied circuit breaker and receptacle(s).

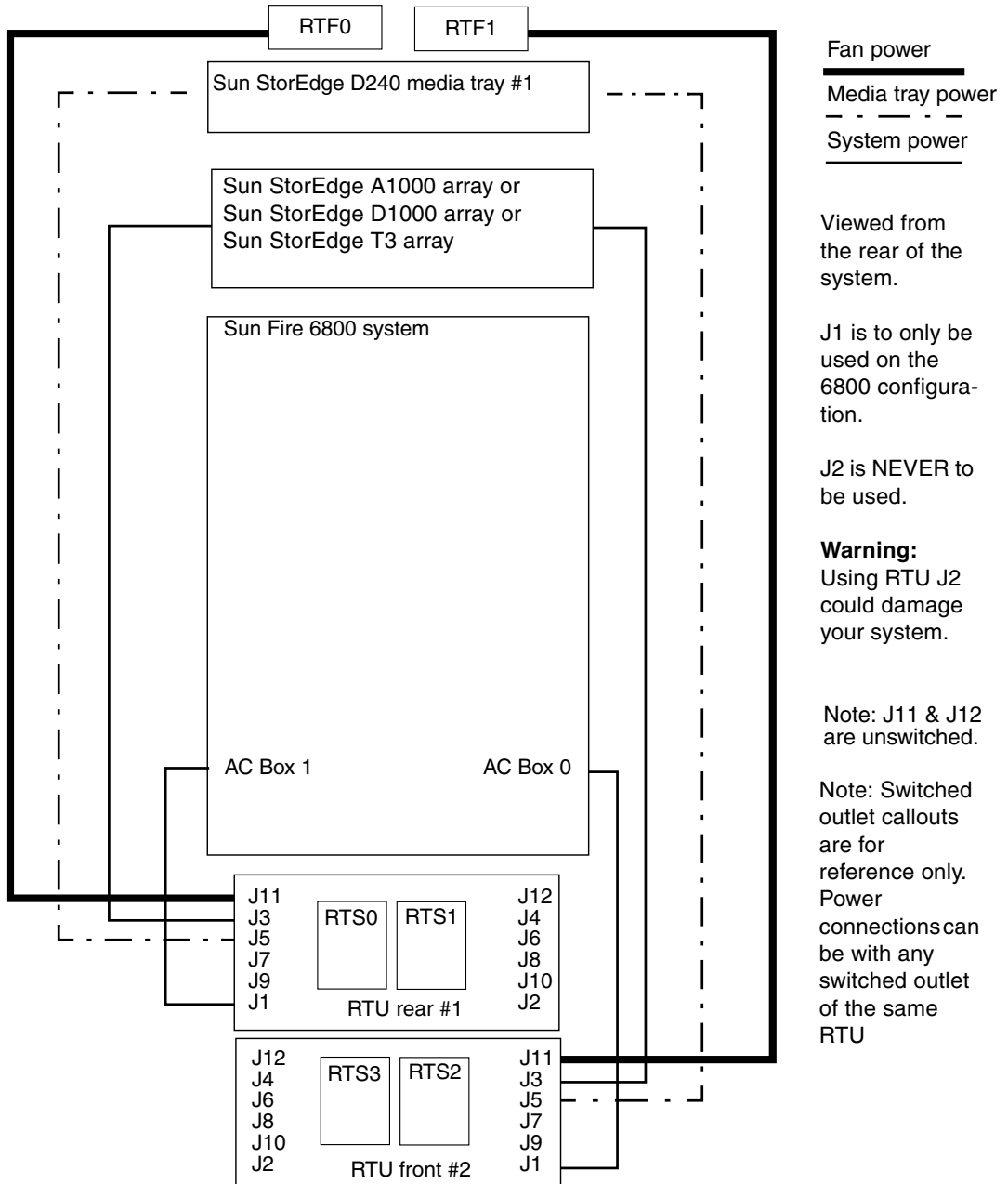


J1 is only for use with the Sun Fire 6800 system only. J2 is never to be used.

**FIGURE A-3** RTU and RTS Modules



**FIGURE A-4** Sun Fire 6800 System and One, Two or Three Sun StorEdge D240 Media Trays



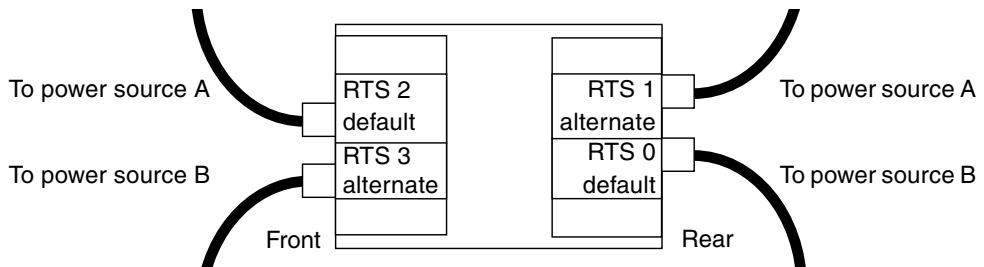
**FIGURE A-5** Sun Fire 6800 System and One Sun StorEdge D240 Media Tray and One Sun StorEdge A1000 Array or Sun StorEdge D1000 Array or Sun StorEdge T3 Array

---

## A.2 Sun Fire Cabinet System Power Wiring Diagrams

The Sun Fire 4810/4800/3800 systems can be mounted in the Sun Fire cabinet. The following diagrams show how to connect the power cables from the RTUs in the cabinet to the system, cabinet fan trays, and various storage products.

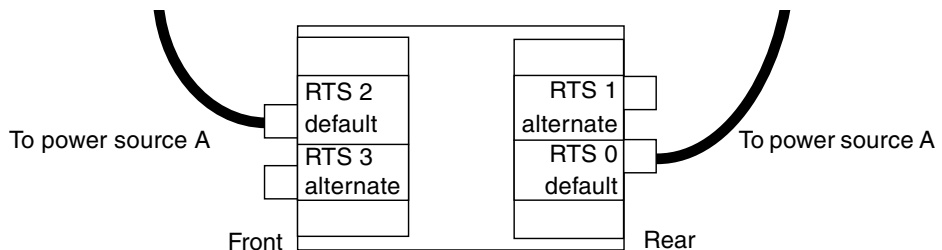
- In configurations with two RTU assemblies and two independent AC power sources there will be four cables to connect, two on the front, and two on the rear of the system (FIGURE A-6).



**FIGURE A-6** Two RTU Assemblies and Two Independent AC Power Sources

- In configurations with two RTU assemblies and one AC power sources there will be two cables to connect, one in the front (on the left), and one in the rear of the system (on the left) (FIGURE A-7).

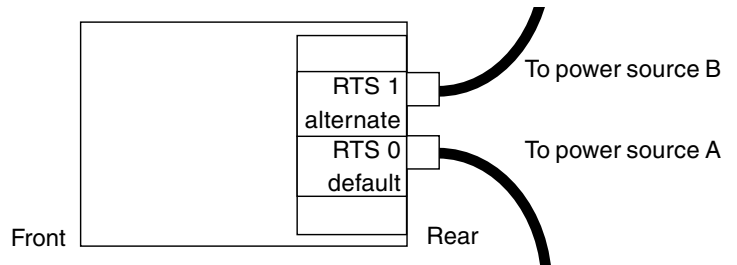
**Connecting the alternate RTS units to outlets that use the same power source as the default RTS units is not supported and will adversely affect reliability.**



**FIGURE A-7** Two RTU Assemblies and One AC Power Sources

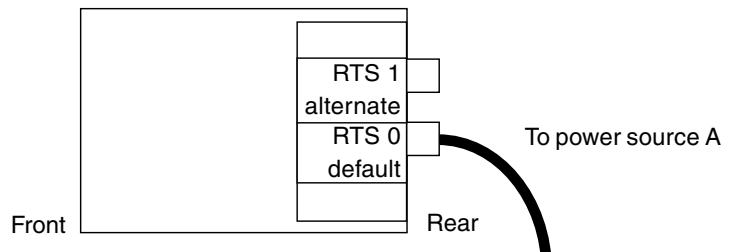
- **Connecting the alternate RTS unit to an outlet that uses the same power source as the default RTS unit is not supported and will adversely affect reliability.**

- In configurations with one RTU assembly and two independent AC power sources there will be two cables to connect, both in the rear of the system (FIGURE A-8).



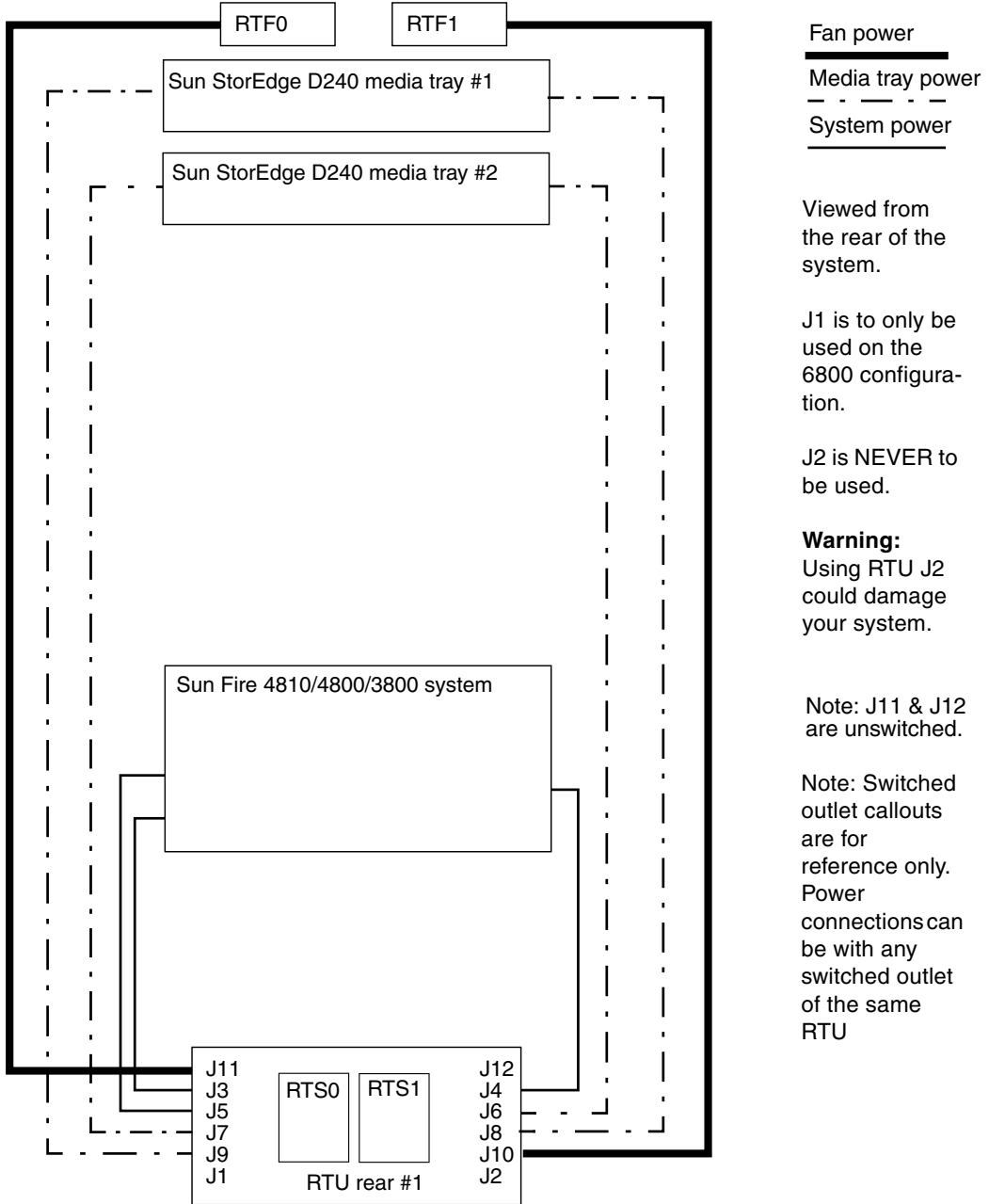
**FIGURE A-8** One RTU Assembly and Two Independent AC Power Sources

- In configurations with one RTU assembly and one AC power sources there will be only one cable to connect (in the rear of the system on the left) (FIGURE A-9).



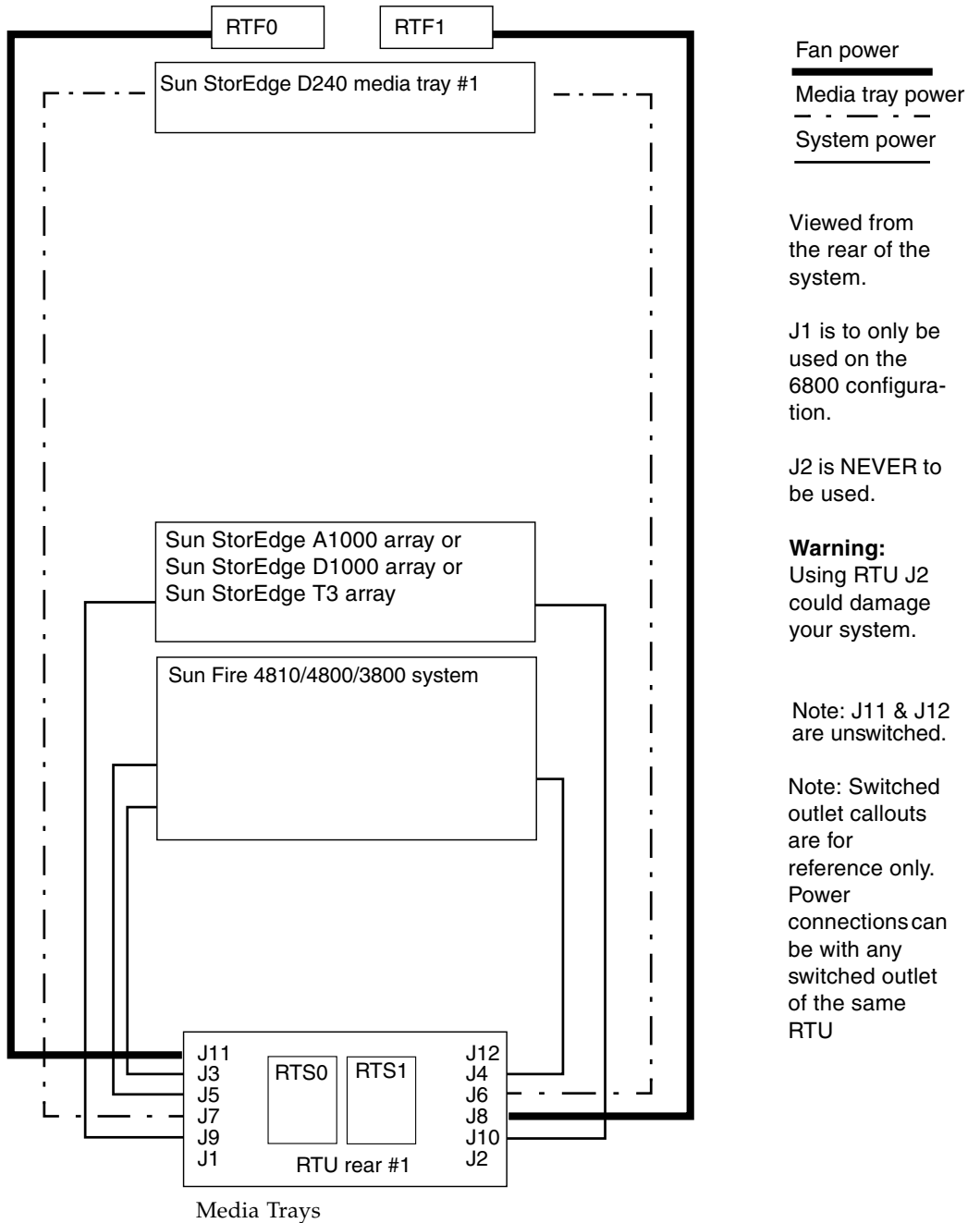
**FIGURE A-9** One RTU Assembly and One AC Power Sources

- Every piece of support equipment requires its own customer-supplied circuit breaker and receptacle(s).

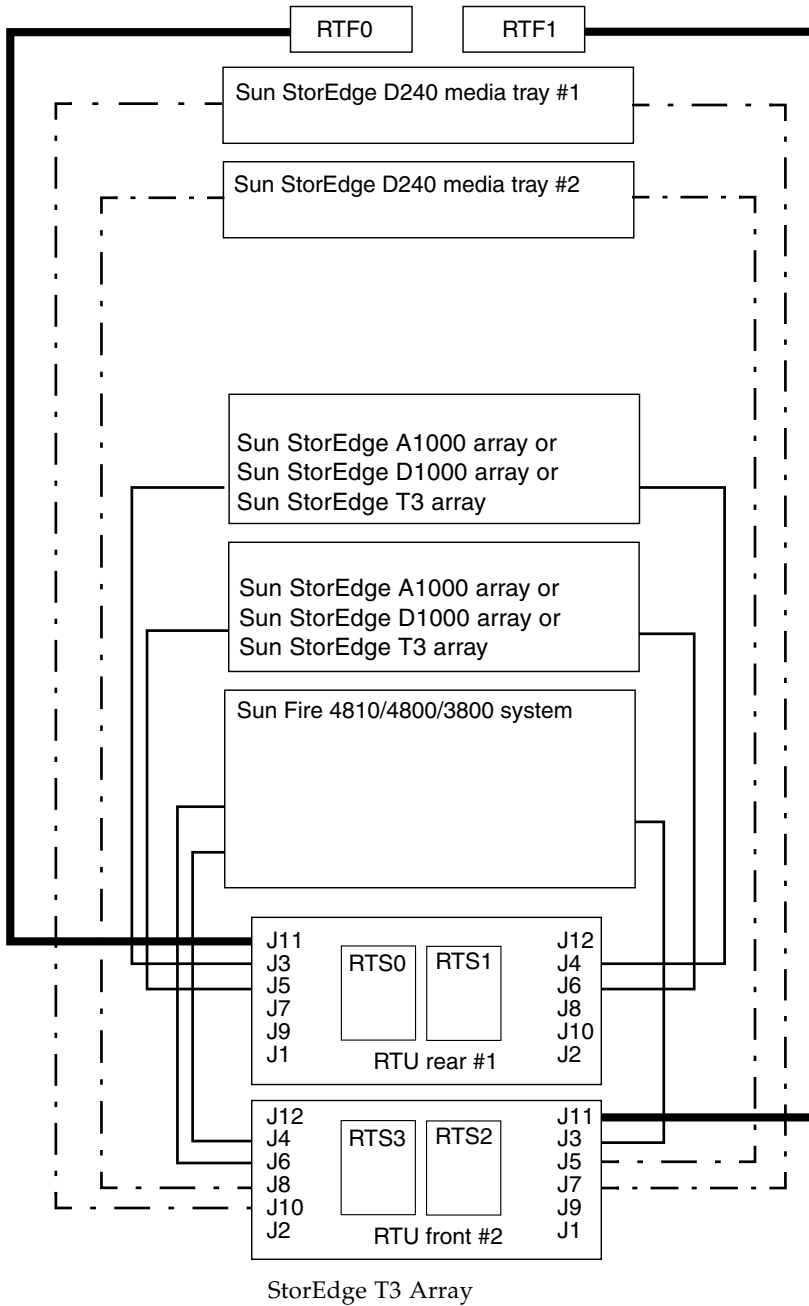


**FIGURE A-10** One Sun Fire 4810/4800/3800 System and One or Two Sun StorEdge D240





**FIGURE A-11** One Sun Fire 4810/4800/3800 System, One Sun StorEdge D240 Media Tray, and One Sun StorEdge A1000 Array or Sun StorEdge D1000 Array or Sun



Fan power  
Media tray power  
System power

Viewed from the rear of the system.

J1 is to only be used on the 6800 configuration.

J2 is NEVER to be used.

**Warning:**  
 Using RTU J2 could damage your system.

Note: J11 & J12 are unswitched.

Note: Switched outlet callouts are for reference only. Power connections can be with any switched outlet of the same RTU

StorEdge T3 Array

**FIGURE A-12** One Sun Fire 4810/4800/3800 System, Two Sun StorEdge D240 Media Trays, and Two Sun StorEdge A1000 Arrays or Sun StorEdge D1000 Arrays or Sun StorEdge T3 Arrays

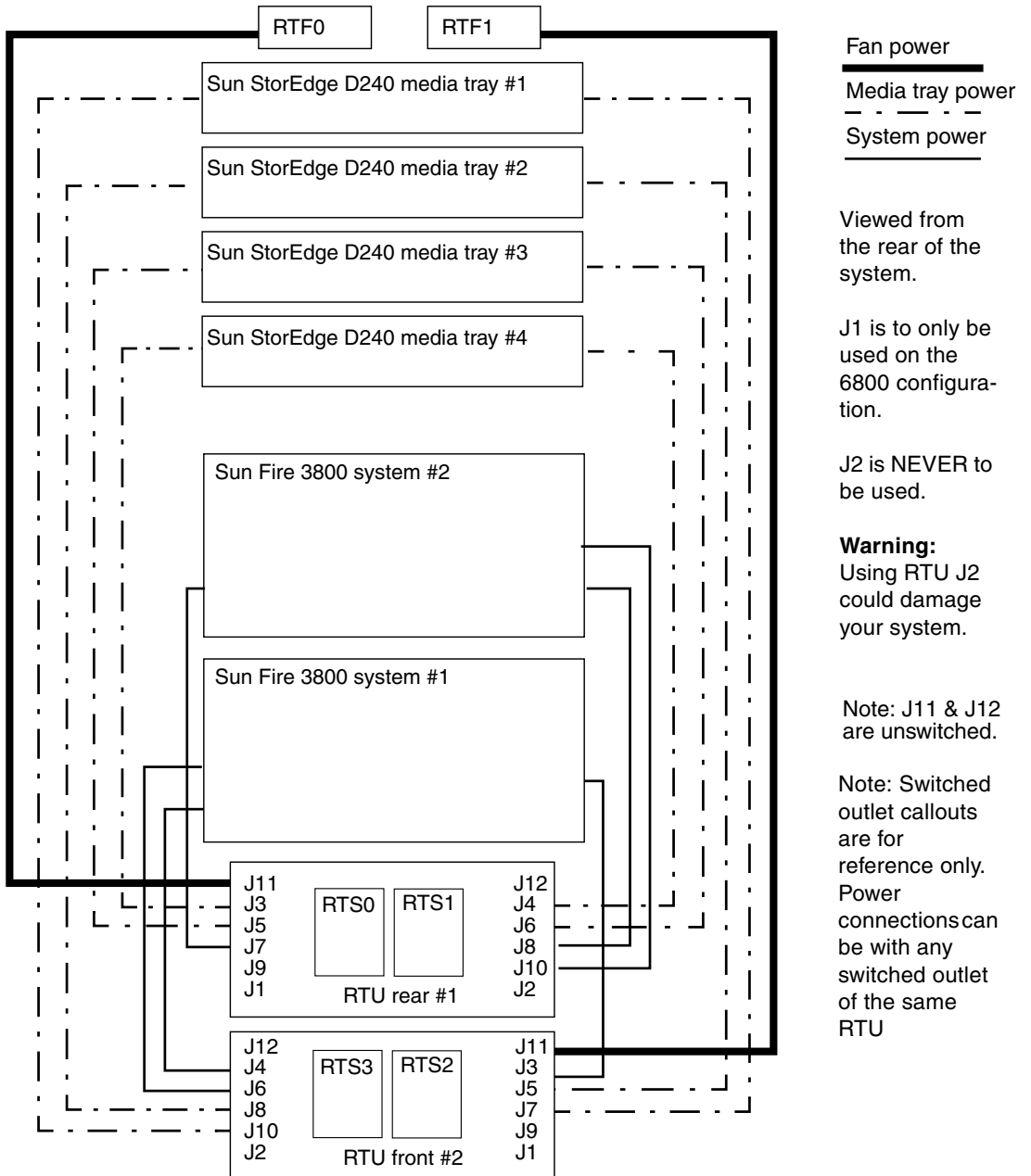
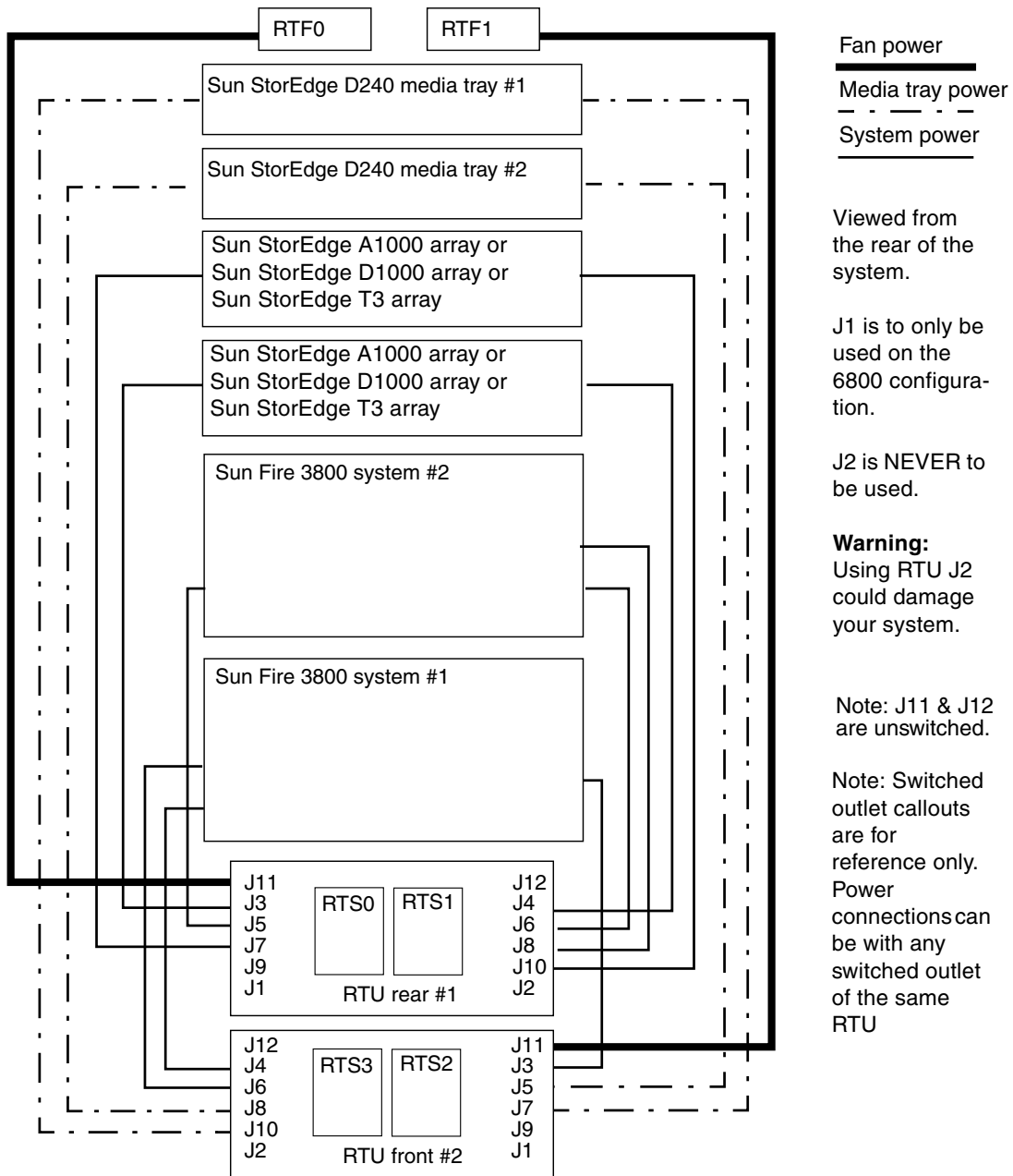
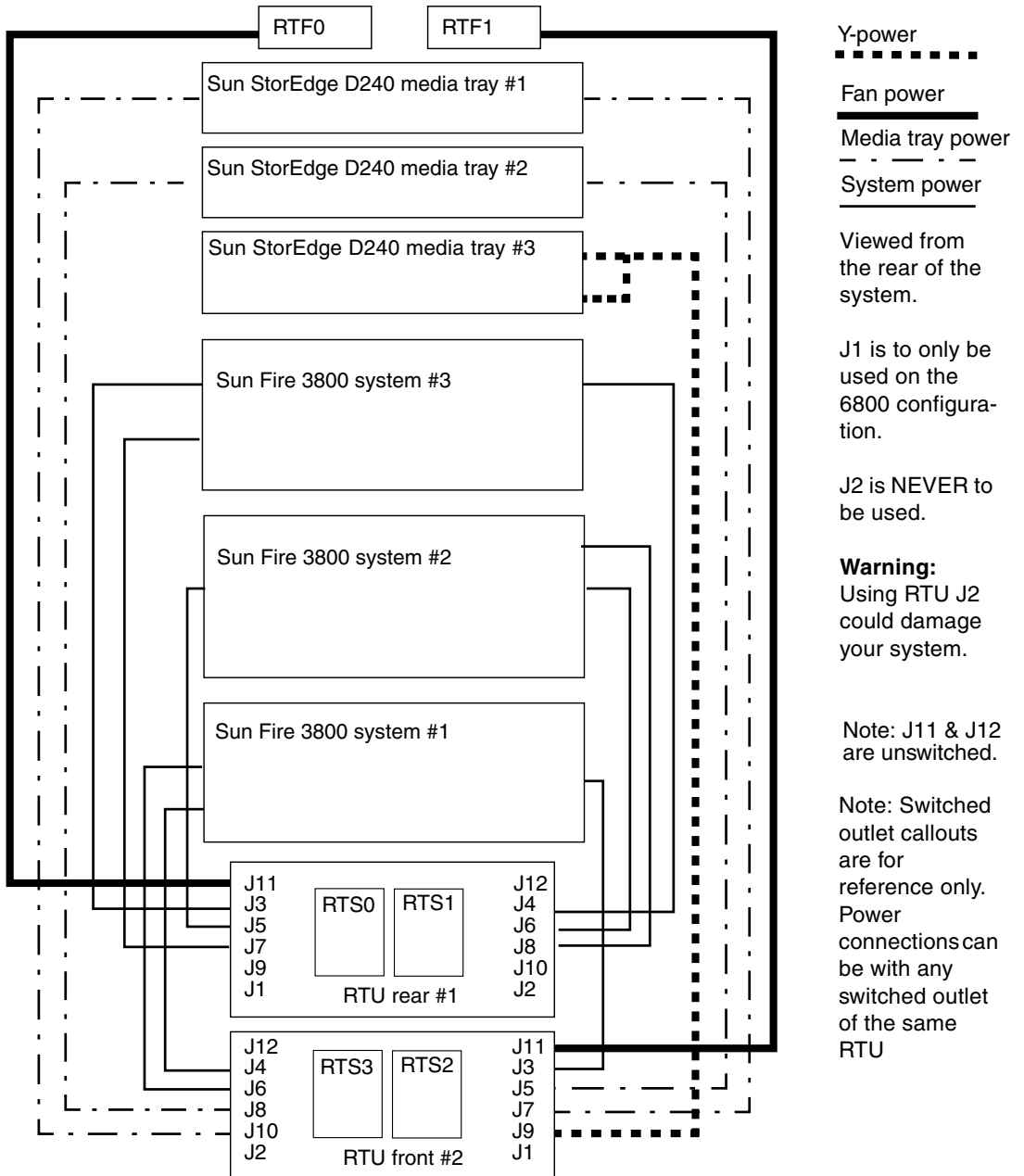


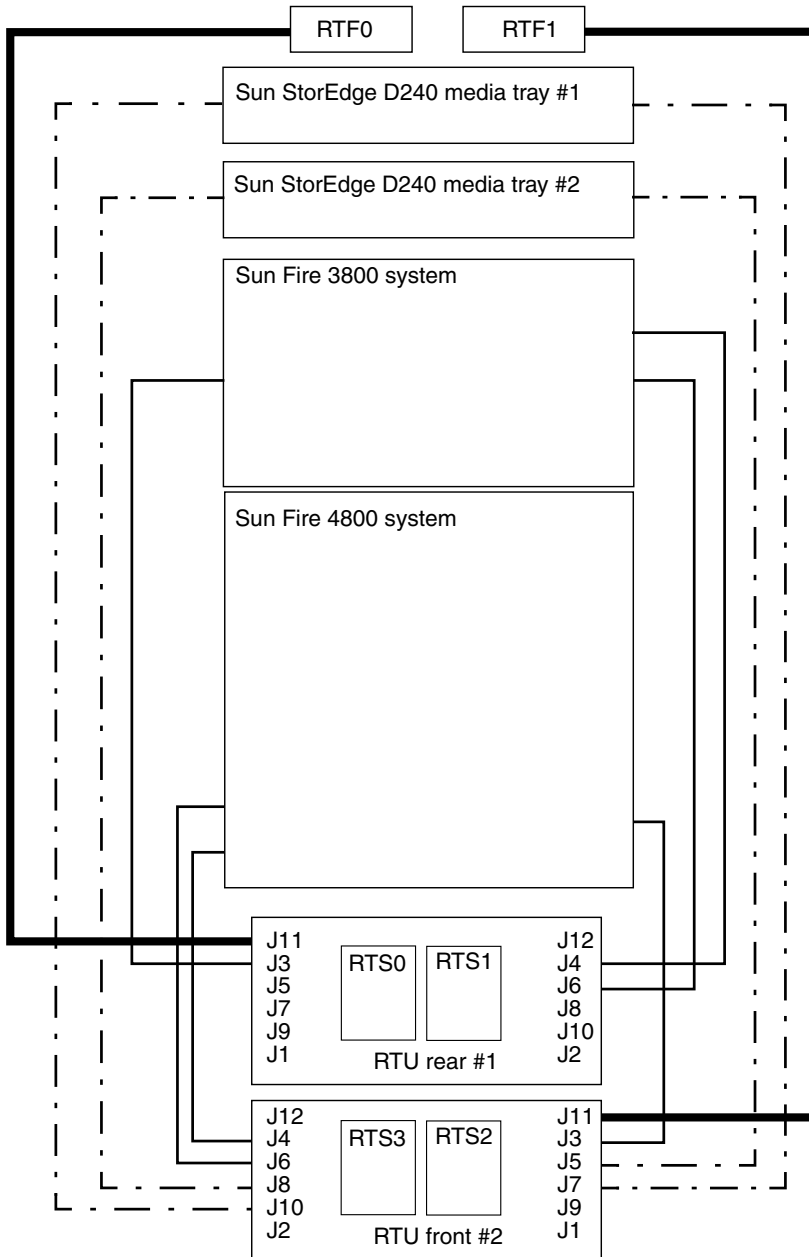
FIGURE A-13 Two Sun Fire 3800 Systems and One To Four Sun StorEdge D240 Media Trays



**FIGURE A-14** Two Sun Fire 3800 Systems, Two Sun StorEdge D240 Media Trays, and One or Two Sun StorEdge A1000 Arrays or Sun StorEdge D1000 Arrays or Sun StorEdge T3 Arrays



**FIGURE A-15** Three Sun Fire 3800 Systems and Three Sun StorEdge D240 Media Trays



Fan power  
Media tray power  
System power

Viewed from the rear of the system.

J1 is to only be used on the 6800 configuration.

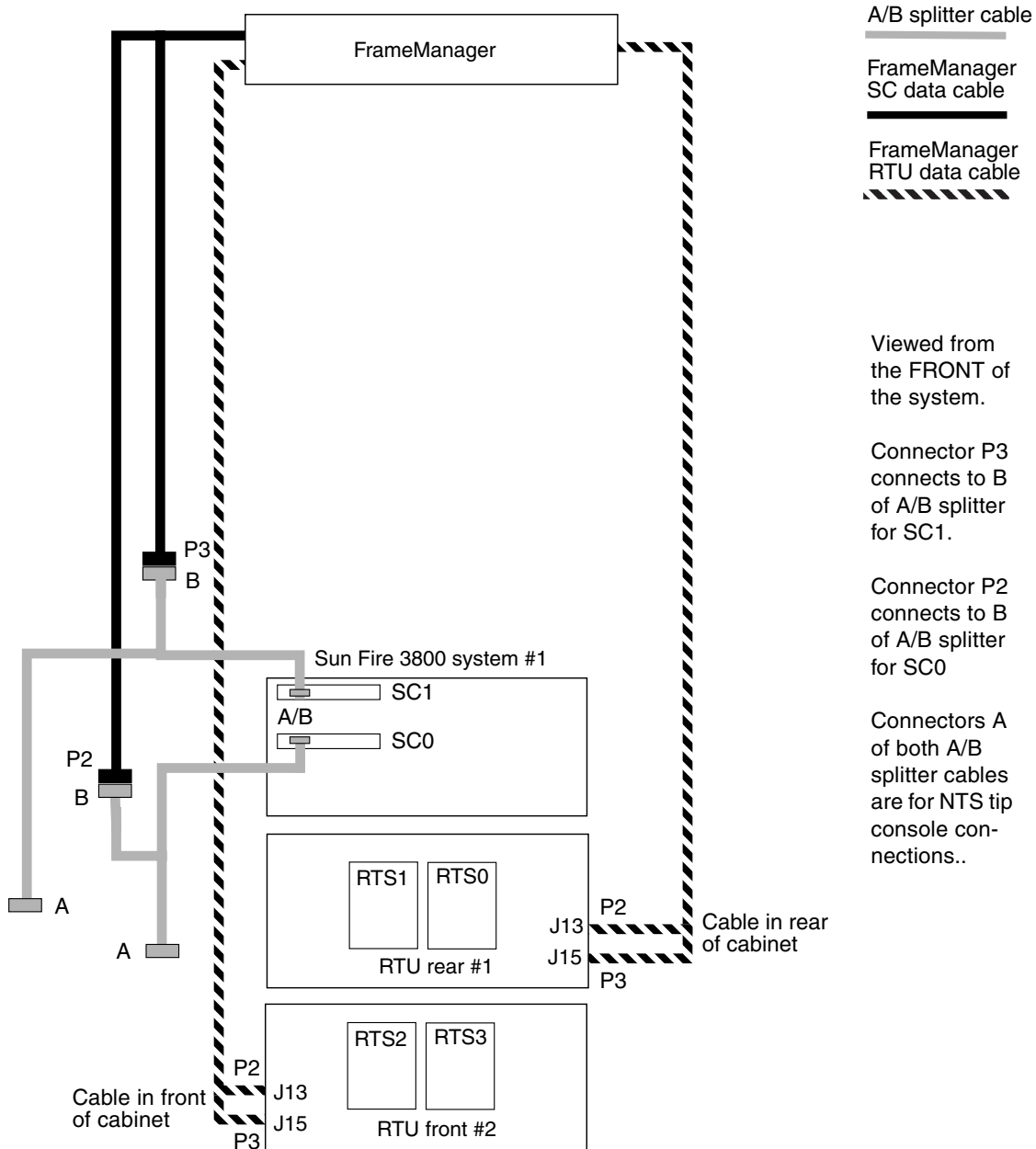
J2 is NEVER to be used.

**Warning:**  
 Using RTU J2 could damage your system.

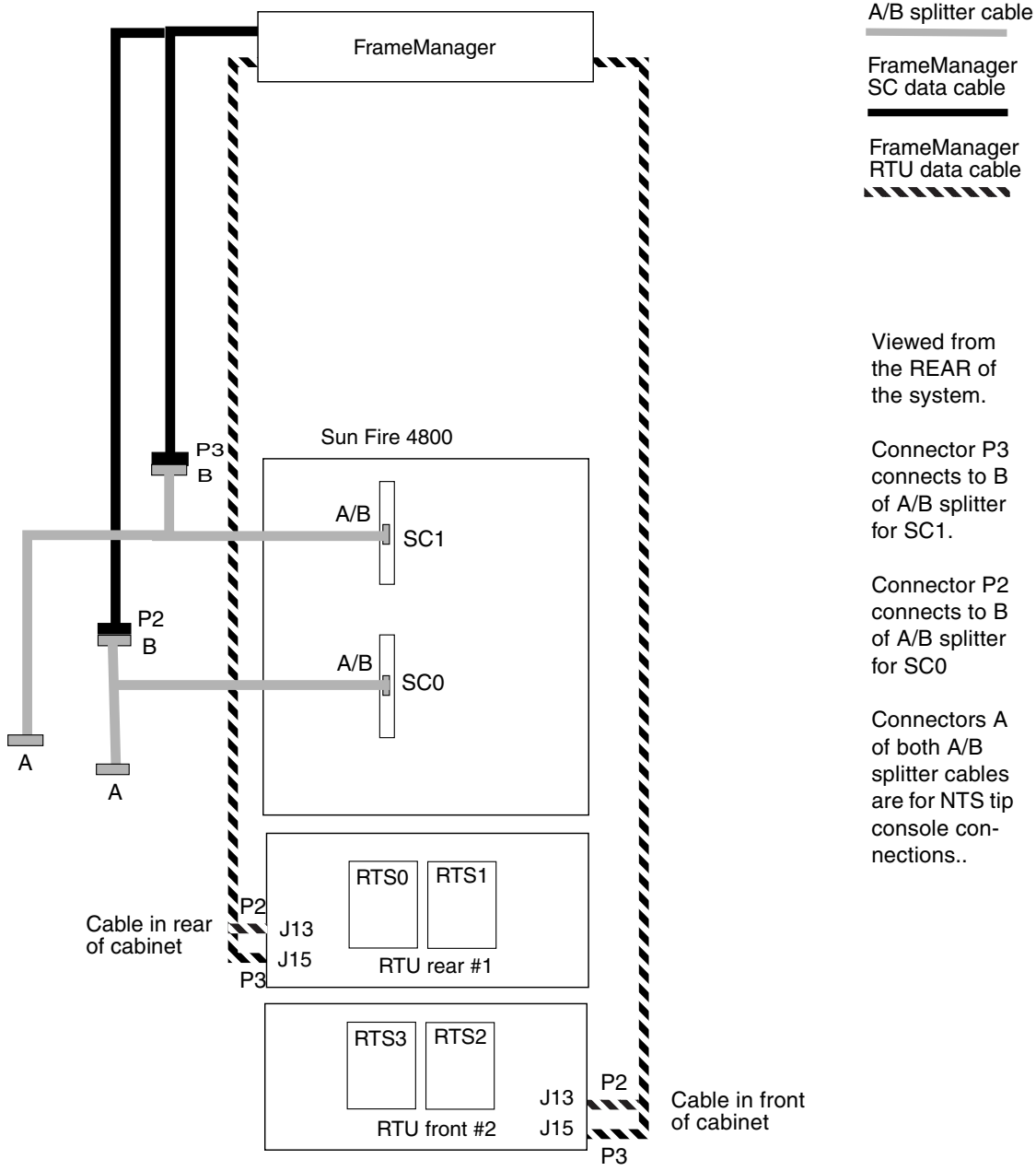
Note: J11 & J12 are unswitched.

Note: Switched outlet callouts are for reference only. Power connections can be with any switched outlet of the same RTU

**FIGURE A-16** One Sun Fire 4800 System and One Sun Fire 3800 System and One or Two Sun StorEdge D240 Media Trays

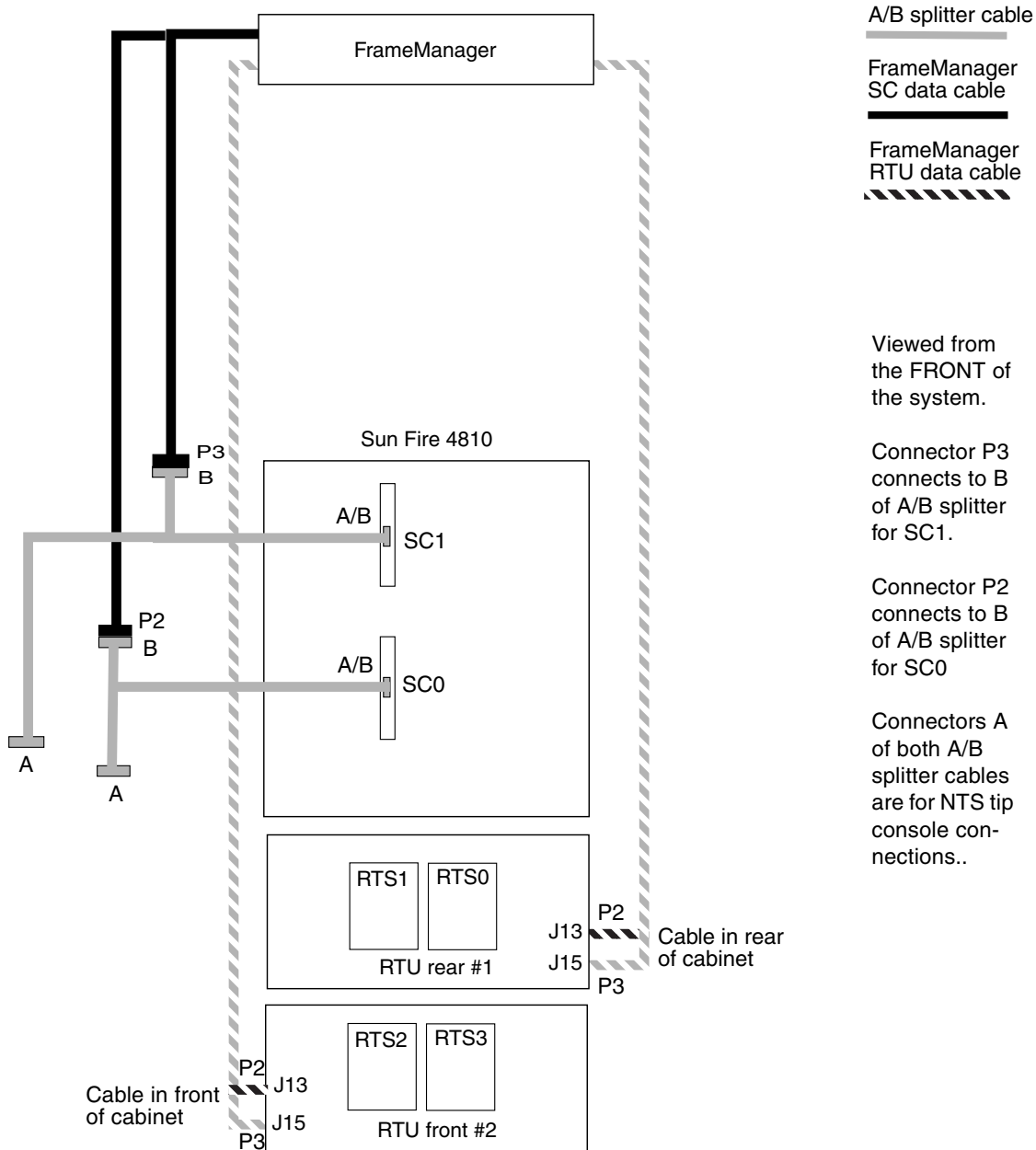


**FIGURE A-17** One Sun Fire 3800 System and FrameManager Data Connections



**FIGURE A-18** One Sun Fire 4800 System and FrameManager Data Connections





**FIGURE A-19** One Sun Fire 4810 System and FrameManager Data Connections

