

Sun Flash PROM Guide for Workstations and Workgroup Servers—Standalone Version

For Sun Ultra™ 1, 2, 5, 10, 30, 60, 80 Systems
Sun Enterprise™ 220R, 250, 420R Systems
Ultra Enterprise™ 450 System
Sun Blade™ 100, 1000 Systems
Sun Fire™ V210, V240, 280R, V440, V480, V490,
V880, V890 Systems
Sun Netra™ T4, 240 Systems

Sun Microsystems, Inc.
www.sun.com

Part No. 802-3233-27
Revision A, September 2004



Copyright 2004 Sun Microsystems, Inc., 4150 Network Circle, Santa Clara, California 95054, U.S.A. All rights reserved.

Sun Microsystems, Inc. has intellectual property rights relating to technology that is described in this document. In particular, and without limitation, these intellectual property rights may include one or more of the U.S. patents listed at <http://www.sun.com/patents> and one or more additional patents or pending patent applications in the U.S. and in other countries.

This document and the product to which it pertains are distributed under licenses restricting their use, copying, distribution, and decompilation. No part of the product or of this document may be reproduced in any form by any means without prior written authorization of Sun and its licensors, if any.

Third-party software, including font technology, is copyrighted and licensed from Sun suppliers.

Parts of the product may be derived from Berkeley BSD systems, licensed from the University of California. UNIX is a registered trademark in the U.S. and in other countries, exclusively licensed through X/Open Company, Ltd.

Sun, Sun Microsystems, the Sun logo, AnswerBook2, docs.sun.com, Sun Fire, Sun Ultra, Sun Enterprise, Ultra Enterprise, Sun Blade, Sun Netra, OpenBoot, Solaris, VIS, Sun StorEdge, Solstice DiskSuite, Java, Sun VTS and the Solaris logo are trademarks or registered trademarks of Sun Microsystems, Inc. in the U.S. and in other countries.

All SPARC trademarks are used under license and are trademarks or registered trademarks of SPARC International, Inc. in the U.S. and in other countries. Products bearing SPARC trademarks are based upon an architecture developed by Sun Microsystems, Inc.

The OPEN LOOK and Sun™ Graphical User Interface was developed by Sun Microsystems, Inc. for its users and licensees. Sun acknowledges the pioneering efforts of Xerox in researching and developing the concept of visual or graphical user interfaces for the computer industry. Sun holds a non-exclusive license from Xerox to the Xerox Graphical User Interface, which license also covers Sun's licensees who implement OPEN LOOK GUIs and otherwise comply with Sun's written license agreements.

U.S. Government Rights—Commercial use. Government users are subject to the Sun Microsystems, Inc. standard license agreement and applicable provisions of the FAR and its supplements.

DOCUMENTATION IS PROVIDED "AS IS" AND ALL EXPRESS OR IMPLIED CONDITIONS, REPRESENTATIONS AND WARRANTIES, INCLUDING ANY IMPLIED WARRANTY OF MERCHANTABILITY, FITNESS FOR A PARTICULAR PURPOSE OR NON-INFRINGEMENT, ARE DISCLAIMED, EXCEPT TO THE EXTENT THAT SUCH DISCLAIMERS ARE HELD TO BE LEGALLY INVALID.

Copyright 2004 Sun Microsystems, Inc., 4150 Network Circle, Santa Clara, California 95054, Etats-Unis. Tous droits réservés.

Sun Microsystems, Inc. a les droits de propriété intellectuels relatants à la technologie qui est décrit dans ce document. En particulier, et sans la limitation, ces droits de propriété intellectuels peuvent inclure un ou plus des brevets américains énumérés à <http://www.sun.com/patents> et un ou les brevets plus supplémentaires ou les applications de brevet en attente dans les Etats-Unis et dans les autres pays.

Ce produit ou document est protégé par un copyright et distribué avec des licences qui en restreignent l'utilisation, la copie, la distribution, et la décompilation. Aucune partie de ce produit ou document ne peut être reproduite sous aucune forme, par quelque moyen que ce soit, sans l'autorisation préalable et écrite de Sun et de ses bailleurs de licence, s'il y en a.

Le logiciel détenu par des tiers, et qui comprend la technologie relative aux polices de caractères, est protégé par un copyright et licencié par des fournisseurs de Sun.

Des parties de ce produit pourront être dérivées des systèmes Berkeley BSD licenciés par l'Université de Californie. UNIX est une marque déposée aux Etats-Unis et dans d'autres pays et licenciée exclusivement par X/Open Company, Ltd.

Sun, Sun Microsystems, le logo Sun, AnswerBook2, docs.sun.com, Sun Fire, Sun Ultra, Sun Enterprise, Ultra Enterprise, Sun Blade, Sun Netra, OpenBoot, Solaris, VIS, Sun StorEdge, Solstice DiskSuite, Java, Sun VTS, et le logo de Solaris sont des marques de fabrique ou des marques déposées de Sun Microsystems, Inc. aux Etats-Unis et dans d'autres pays.

Toutes les marques SPARC sont utilisées sous licence et sont des marques de fabrique ou des marques déposées de SPARC International, Inc. aux Etats-Unis et dans d'autres pays. Les produits portant les marques SPARC sont basés sur une architecture développée par Sun Microsystems, Inc.

L'interface d'utilisation graphique OPEN LOOK et Sun™ a été développée par Sun Microsystems, Inc. pour ses utilisateurs et licenciés. Sun reconnaît les efforts de pionniers de Xerox pour la recherche et le développement du concept des interfaces d'utilisation visuelle ou graphique pour l'industrie de l'informatique. Sun détient une licence non exclusive de Xerox sur l'interface d'utilisation graphique Xerox, cette licence couvrant également les licenciées de Sun qui mettent en place l'interface d'utilisation graphique OPEN LOOK et qui en outre se conforment aux licences écrites de Sun.

LA DOCUMENTATION EST FOURNIE "EN L'ÉTAT" ET TOUTES AUTRES CONDITIONS, DECLARATIONS ET GARANTIES EXPRESSES OU TACITES SONT FORMELLEMENT EXCLUES, DANS LA MESURE AUTORISEE PAR LA LOI APPLICABLE, Y COMPRIS NOTAMMENT TOUTE GARANTIE IMPLICITE RELATIVE A LA QUALITE MARCHANDE, A L'APTITUDE A UNE UTILISATION PARTICULIERE OU A L'ABSENCE DE CONTREFAÇON.

Contents

- 1. Changing Flash PROM Jumpers 1-1**
 - 1.1 Introduction 1-1
 - 1.2 Changing Flash PROM Jumpers 1-2
 - 1.2.1 Changing Jumper or Keyswitch Settings 1-2
 - 1.3 Flash PROM Jumper Locations and Settings 1-6
 - 1.3.1 Flash PROM Jumper Locations 1-6
 - 1.3.2 Flash PROM Jumper Settings 1-17

- 2. Updating the Flash PROM Using Utility Version 2.0 or Later 2-1**
 - 2.1 Updating the Flash PROM 2-1
 - 2.1.1 Before You Begin 2-1
 - 2.1.2 What to Do 2-2
 - 2.2 Error Messages 2-9
 - 2.2.1 Example 1—Write-Protect/Write-Enable Jumper Message on System With No Front Panel Keyswitch 2-9
 - 2.2.2 Example 2—Write-Protect/Write-Enable Jumper Message on System With Front Panel Keyswitch 2-10
 - 2.2.3 Example 3—NVRAM Configuration Variable 2-10
 - 2.2.4 Example 4—Flash PROM Sectors Protected 2-11

- 3. Setting Up a Flash PROM Boot Server 3-1**

3.1	Using Volume Manager to Install Flash PROM Packages	3-1
3.1.1	Checking Volume Manager Status	3-2
3.1.2	Installing Packages With Volume Manager	3-2
3.1.3	Installing Packages Without Volume Manager	3-3
3.2	Booting the Utility From the Server	3-4
3.2.1	Booting the Utility as a Client	3-4
3.2.2	Booting the Utility as a Server	3-4
3.3	Package Names and Contents	3-5
A.	Power Interruption During Updating	A-1
B.	Updating the Flash PROM Using Utility Versions Earlier Than 2.0	B-1

Changing Flash PROM Jumpers

This document accompanies the standalone CD-ROM containing the new firmware code for updating your system's flash PROM. This document is intended for:

- Network administrators
- System administrators
- Network and system service providers
- Advanced system users

This chapter describes the procedure for manually changing flash PROM jumper settings (or front panel keyswitch settings) in your system.

Note – The procedures in this document apply to the so-called “Standalone Flash PROM Utility.” This utility is what you typically use to perform a firmware update from CD-ROM or a downloaded image. These procedures do not apply to the flash PROM utility that is bundled with the Solaris™ Operating System.

1.1 Introduction

Sun Ultra™, Sun Enterprise™, Ultra Enterprise™, Sun Blade™, Sun Fire™, and Sun Netra™ systems that conform to the Sun4U™ architecture use flash programmable read-only memory (PROM). Flash PROMs enable you to:

- Reprogram specific code blocks
- Remotely reprogram the PROM chip over a local area network (LAN)

1.2 Changing Flash PROM Jumpers

The Sun Ultra, Sun Enterprise, Ultra Enterprise, Sun Blade, Sun Fire, and Sun Netra systems are equipped with flash PROM jumpers. These flash PROM jumpers are usually located on the motherboard, though this varies from system to system. These jumpers enable you to:

- Select or deselect the flash PROM
- Enable or disable updating of the flash PROM
- Select the location of the flash PROM code for system booting

1.2.1 Changing Jumper or Keyswitch Settings

Before updating the flash PROM, use this procedure to change the write-protect/write-enable jumper or keyswitch setting.

TABLE 1-1 Sun4U Architecture Jumper and Keyswitch Settings

Server/Workstation	Write-Protect/ Write-Enable	Front Panel Keyswitch?	Jumper	Reference
Sun Enterprise 250	Write-enable	Yes	J2704	page 1-18
Ultra Enterprise 450	Write-enable	Yes	J3103	page 1-18
Sun Blade 1000	Write-enable	No	J2103	page 1-20
Sun Fire V210	Write-protect	No	JP11	page 1-19
Sun Fire V240	Write-protect	Yes	JP11	page 1-19
Sun Netra 240	Write-protect	Yes	JP11	page 1-19
Sun Fire 280R	Write-enable	Yes	J2103	page 1-20
Sun Netra T4	Write-enable	Yes	J2103	page 1-20
Sun Fire V440	Write-enable	Yes	J4205	page 1-19
Sun Fire V480	Write-enable	Yes	J1104	page 1-19
Sun Fire V490	Write-enable	Yes	J1104	page 1-19
Sun Fire V880	Write-enable	Yes	J3003	page 1-20
Sun Fire V890	Write-enable	Yes	J3003	page 1-20

1. Halt the system by typing `init 0` at the superuser prompt.
2. Power off the system.



Caution – Use proper grounding procedures, such as wearing an antistatic wrist strap to avoid electrostatically damaging system components.

3. If necessary, remove the system cover from the Sun Enterprise 250, Ultra Enterprise 450, Sun Fire V240, Sun Netra 240, Sun Fire 280R, Sun Netra T4, Sun Fire V440, Sun Fire V480, Sun Fire V490, Sun Fire V880, or Sun Fire V890 system (see the following note).

Note – Sun Enterprise 250, Ultra Enterprise 450, Sun Fire V240, Sun Netra 240, Sun Fire 280R, Sun Netra T4, Sun Fire V440, Sun Fire V480, Sun Fire V490, Sun Fire V880, or Sun Fire V890 servers: The default position for the write-protect/write-enable jumper on the motherboard is write-enable. Therefore, unless you have reset the jumper to the write-protect position at an earlier time, it is not necessary to remove the system cover before updating the flash PROM. Instead, set the front panel keyswitch to Power-On (I) and continue with the procedure in Chapter 2.

Note – Sun Blade 1000 and Sun Fire V210: The default position for the write-protect/write-enable jumper on the motherboard is in the write-enable position. Therefore, unless you reset the jumper to the write-protect position at an earlier time, it is not necessary to remove the access panel before updating the flash PROM.

4. Locate the flash PROM jumpers on the motherboard or system board in your system.

Refer to the table below to find the appropriate diagram for your system.

For This System or Systems...	Reference
Sun Ultra 1 or Ultra 1 Creator	FIGURE 1-2 on page 1-6
Sun Ultra 2	FIGURE 1-3 on page 1-7
Sun Ultra 5 or Ultra 10	FIGURE 1-4 on page 1-7
Sun Ultra 30	FIGURE 1-5 on page 1-8
Sun Ultra 60	FIGURE 1-6 on page 1-9
Sun Ultra 80	FIGURE 1-7 on page 1-9
Sun Enterprise 220R	FIGURE 1-6 on page 1-9

For This System or Systems...	Reference
Sun Enterprise 250	FIGURE 1-8 on page 1-10
Sun Enterprise 420R	FIGURE 1-7 on page 1-9
Ultra Enterprise 450	FIGURE 1-9 on page 1-10
Sun Blade 100	FIGURE 1-10 on page 1-11
Sun Blade 1000	FIGURE 1-11 on page 1-12
Sun Fire V210	FIGURE 1-12 on page 1-13
Sun Fire V240	FIGURE 1-12 on page 1-13
Sun Netra 240	FIGURE 1-12 on page 1-13
Sun Fire 280R	FIGURE 1-11 on page 1-12
Sun Netra T4	FIGURE 1-11 on page 1-12
Sun Fire V440	FIGURE 1-13 on page 1-14
Sun Fire V480	FIGURE 1-14 on page 1-15
Sun Fire V490	FIGURE 1-14 on page 1-15
Sun Fire V880	FIGURE 1-15 on page 1-16
Sun Fire V890	FIGURE 1-15 on page 1-16

5. **Compare your system's existing jumper settings with the settings and functions described in [TABLE 1-2 on page 1-17](#).**
6. **If an installed plug-in card in your system covers the flash PROM jumpers, remove the card from the system before changing the desired jumpers.**
Refer to your system's service or reference manual for instructions.
7. **Use a pair of small needlenose pliers to move the jumper to the desired pins.**
For systems covered in this guide, you set the write-protect/write-enable jumper to write-enable by moving the jumper to pins 2 and 3 (see [FIGURE 1-1](#)).

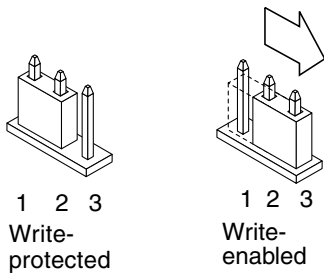

FIGURE 1-1 Setting the Write-Protect/Write-Enable Jumper to the Write-Enable Position

Note – Sun Fire V210, Sun Fire V240, and Sun Netra 240 servers use a two pin jumper. When the jumper is fitted, it is in the write-protected position. When the jumper is not fitted, it is in the write-enabled position.

Note – When you are finished updating the flash PROM, return the flash PROM write-protect/write-enable jumper to the write-protect position to ensure system security. If your system is a Sun Enterprise 250, Ultra Enterprise 450, Sun Fire V240, Sun Netra 240, Sun Fire 280R, Sun Fire V440, Sun Fire V480, Sun Fire V490, Sun Fire V880, or Sun Fire V890, do not change the jumper; instead, return the front panel keyswitch to the Locked position (🔒).

- 8. If you removed a plug-in card from the system before changing the jumper, replace the card now.**

Refer to your system's service or reference manual for instructions.

- 9. Remove your wrist strap and if necessary, replace the system cover.**

1.3 Flash PROM Jumper Locations and Settings

This section provides figures that illustrate the locations of flash PROM jumpers and a table that describes the settings for those jumpers on various Sun systems.

1.3.1 Flash PROM Jumper Locations

The following figures depict the locations of flash PROM jumpers on various Sun systems.

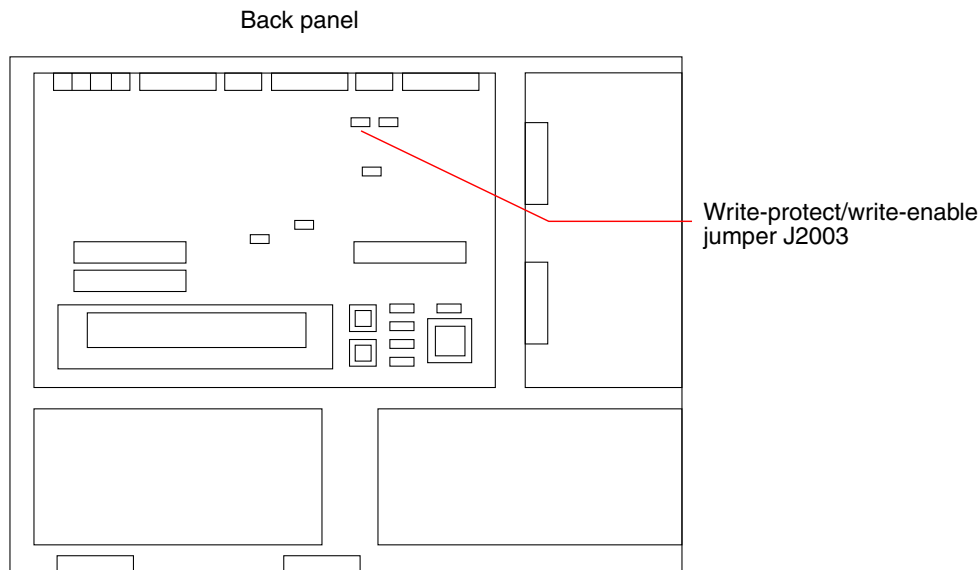

FIGURE 1-2 Sun Ultra 1/Ultra 1 Creator Flash PROM Jumper Location on Motherboard

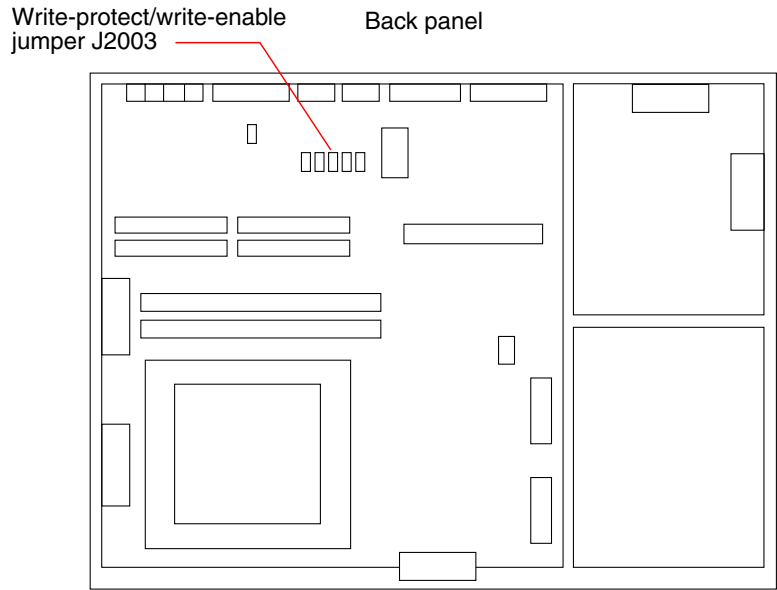

FIGURE 1-3 Sun Ultra 2 Flash PROM Jumper Location on Motherboard

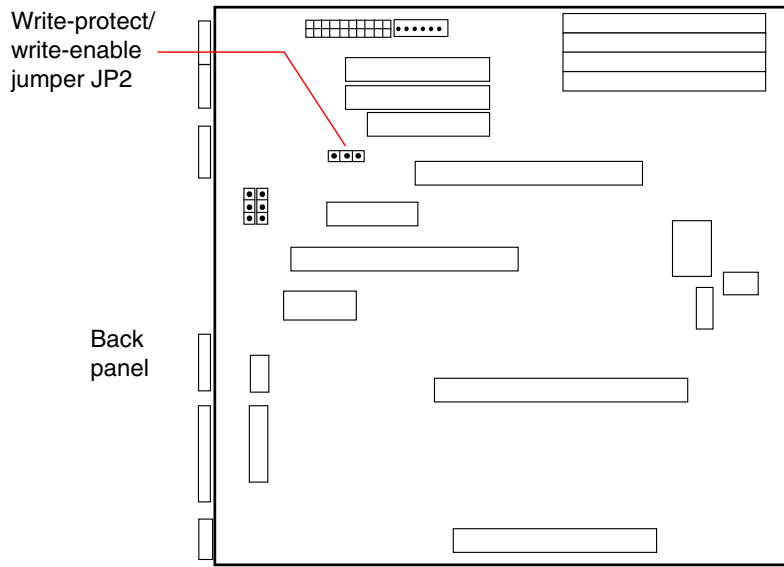

FIGURE 1-4 Sun Ultra 5/Ultra 10 Flash PROM Jumper Location on Motherboard

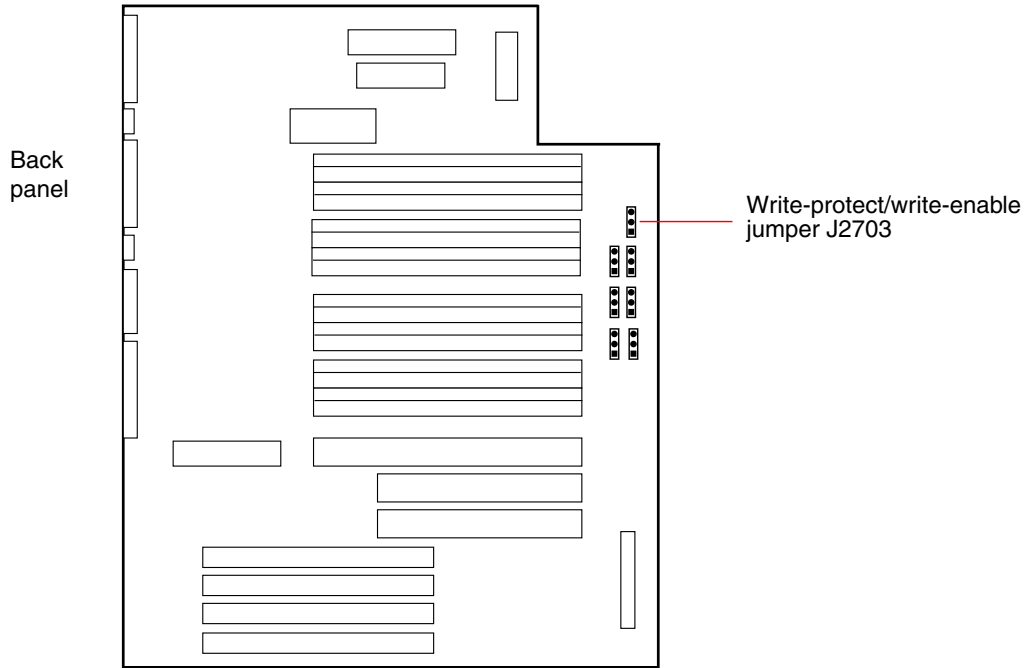

FIGURE 1-5 Sun Ultra 30 Flash PROM Jumper Location on Motherboard

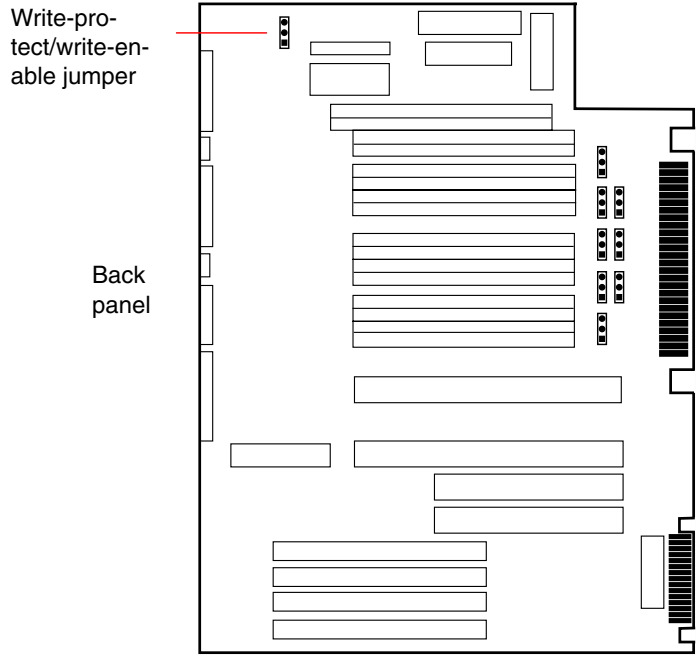

FIGURE 1-6 Sun Ultra 60/Sun Enterprise 220R Flash PROM Jumper Location on Motherboard

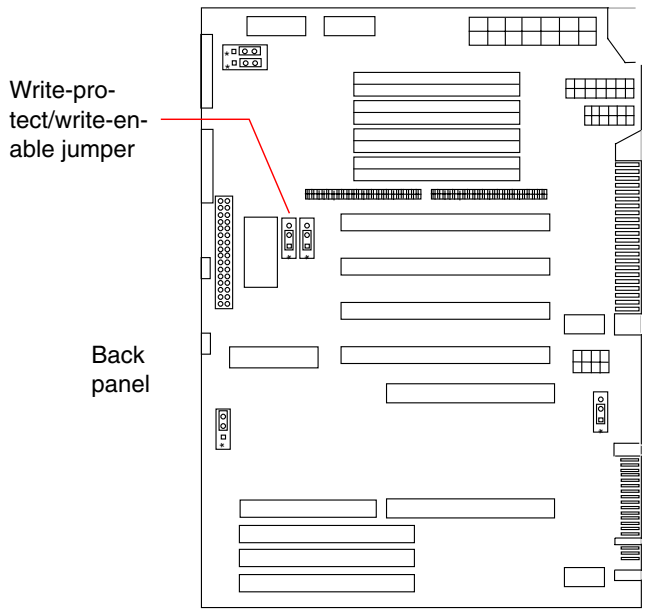

FIGURE 1-7 Sun Ultra 80/Sun Enterprise 420R Flash PROM Jumper Location on Motherboard

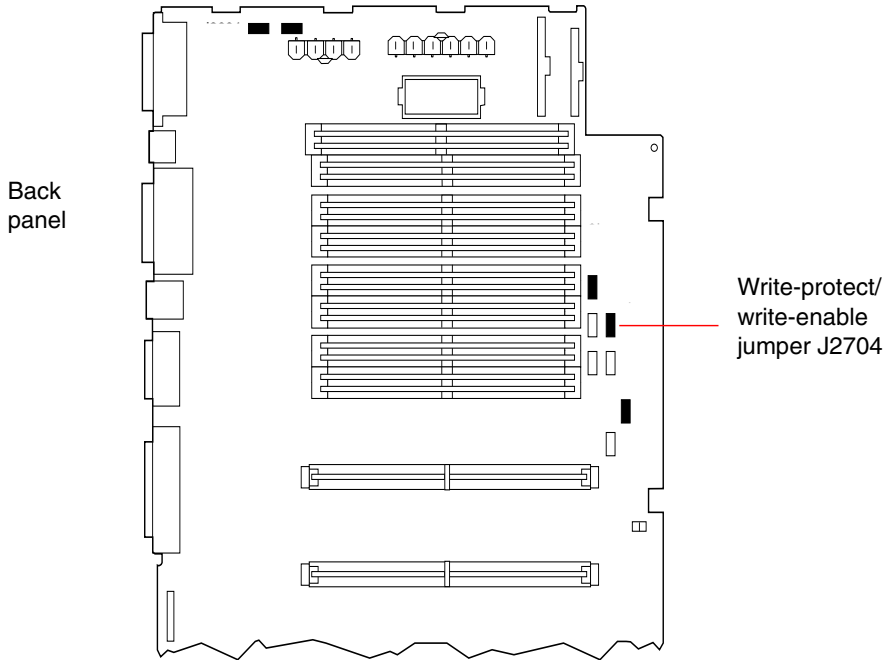

FIGURE 1-8 Sun Enterprise 250 Flash PROM Jumper Location on Motherboard

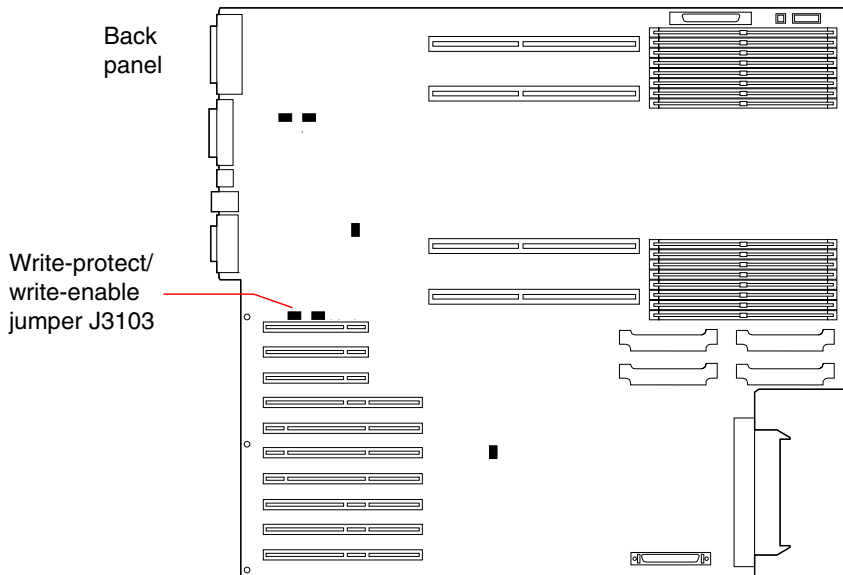

FIGURE 1-9 Ultra Enterprise 450 Flash PROM Jumper Location on Motherboard

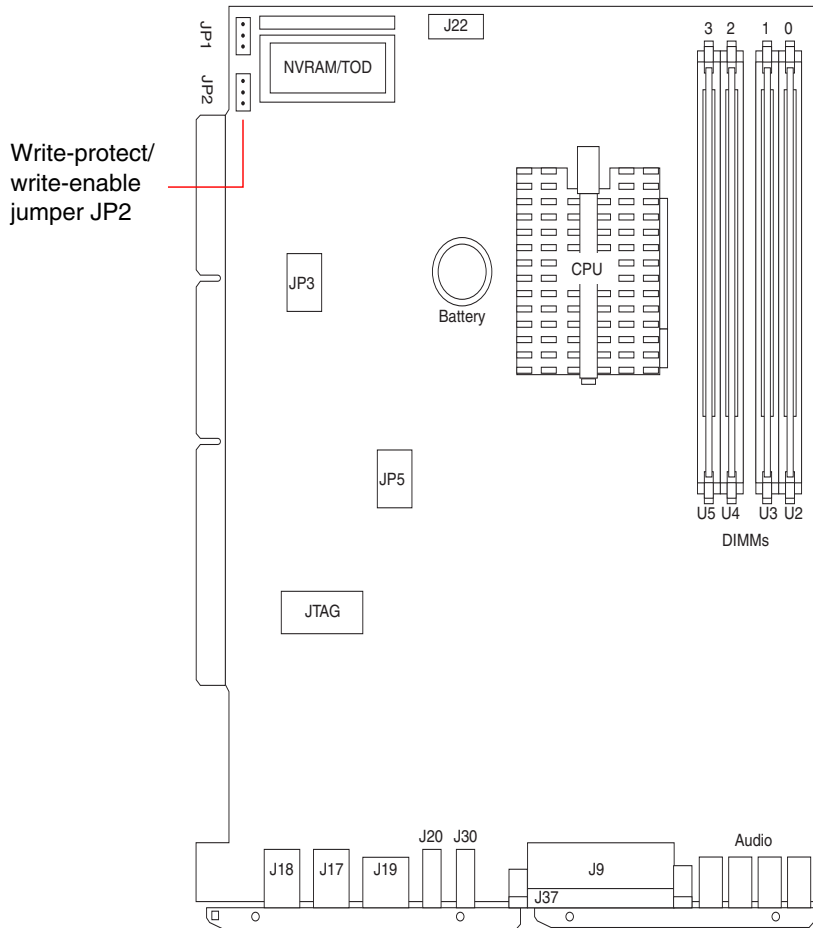

FIGURE 1-10 Sun Blade 100 Flash PROM Jumper Location on Motherboard

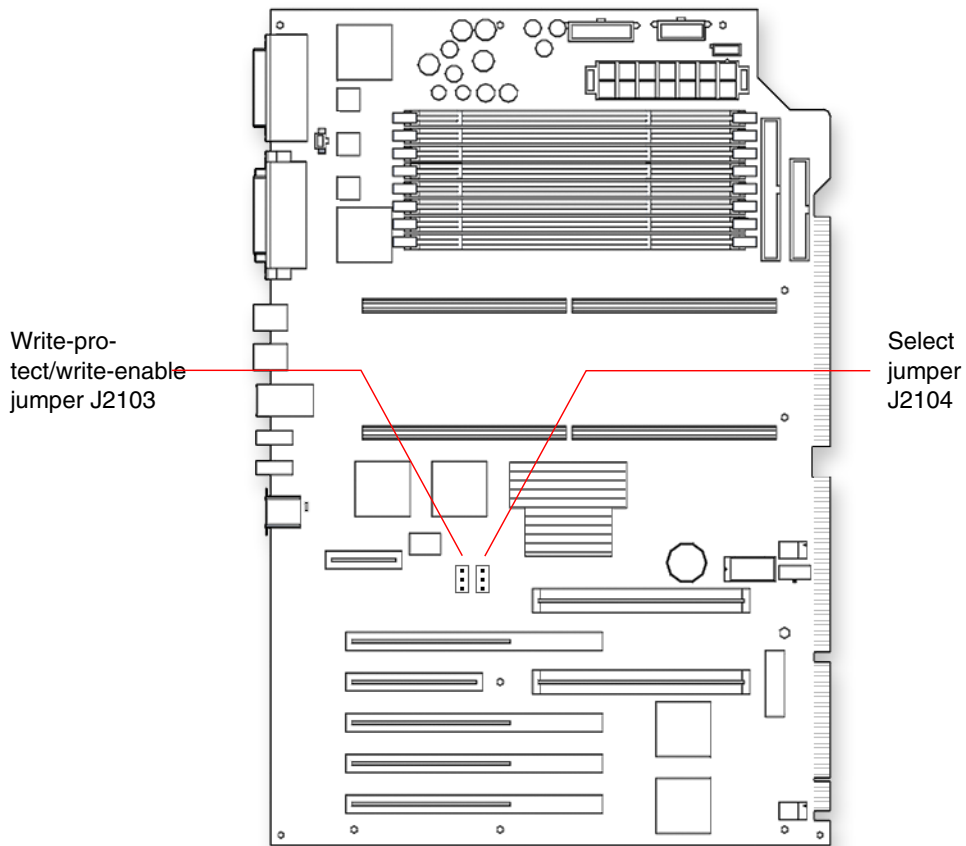

FIGURE 1-11 Sun Blade 1000/Sun Fire 280R/Sun Netra T4 Flash PROM Jumper Location on Motherboard

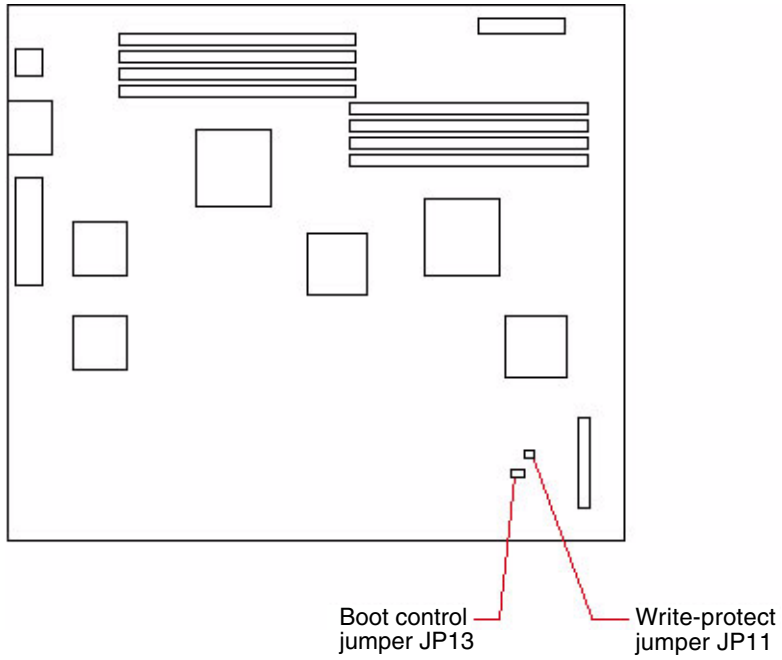

FIGURE 1-12 Sun Fire V210/V240/Sun Netra 240 Flash PROM Jumper Location on Motherboard

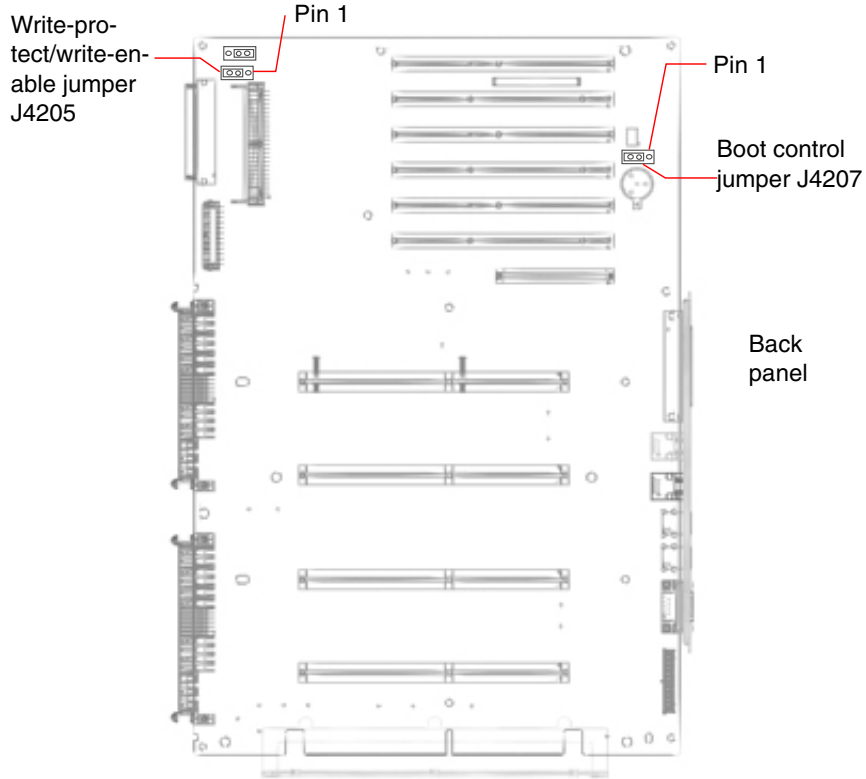
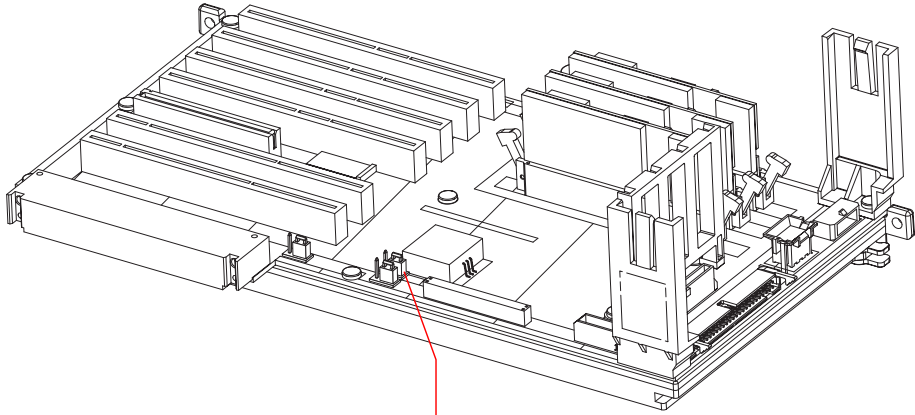

FIGURE 1-13 Sun Fire V440 Flash PROM Jumper Location on Motherboard



Write-pro-
tect/write-en-
able jumper
J1104

FIGURE 1-14 Sun Fire V480V490 Flash PROM Jumper Location on the PCI Riser Board

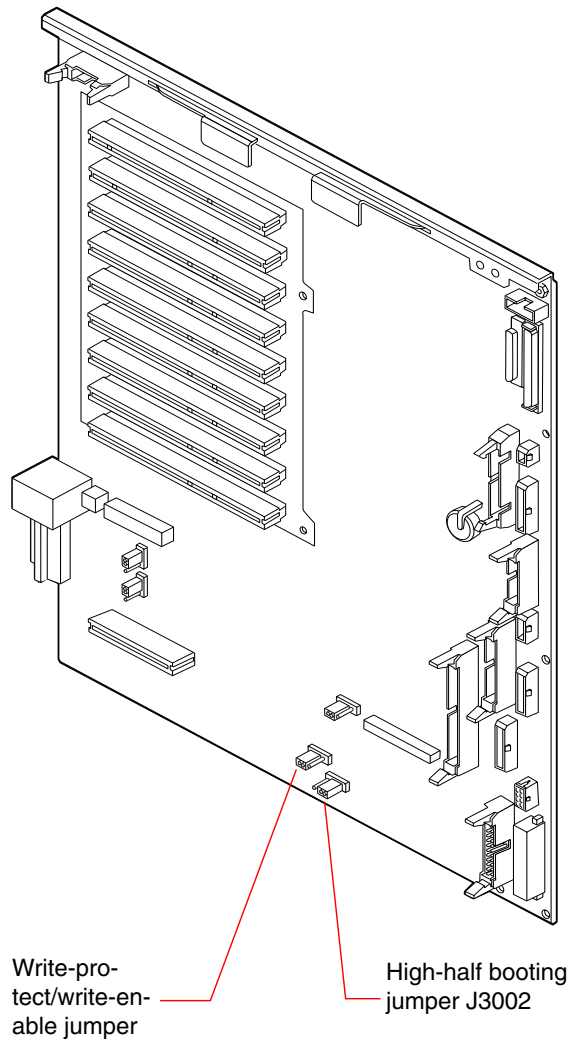

FIGURE 1-15 Sun Fire V880 and Sun Fire V890 Flash PROM Jumper Locations on the System I/O Board

1.3.2 Flash PROM Jumper Settings

TABLE 1-2 describes the flash PROM jumper settings for various Sun systems.

TABLE 1-2 Flash PROM Jumper Settings for Various Sun Systems

System(s)	Jumper	Name	Pins 1 + 2 Select	Pins 2 + 3 Select	Default Jumper on Pins
Ultra 1, Ultra 1 Creator, and Ultra 2	J2003	Write-protect/ write-enable	Write-protect	Write-enable	1 + 2
	J2204	Boot control	High-half booting	Normal booting	2 + 3 (see note below)
	<i>Do not</i> change the position of jumper J2204 unless directed to do so by the instructions in Appendix . The position of jumper J2204 does not need to be changed unless the programming sequence is interrupted.				
Ultra 5 and Ultra 10	JP2	Write-protect/ write-enable	Write-protect	Write-enable	1 + 2
Ultra 30 and Ultra 60/Enterprise 220R	J2703	Write-protect/ write-enable	Write-protect	Write-enable	1 + 2
	J2804	Boot control	High-half booting	Normal booting	2 + 3 (see note below)
	<i>Do not</i> change the position of jumper J2804 unless directed to do so by the instructions in Appendix . The position of jumper J2804 does not need to be changed unless the programming sequence is interrupted.				
Ultra 80/Enterprise 420R	J3001	Write-protect/ write-enable	Write-protect	Write-enable	1 + 2
	J3102	Boot control	High-half booting	Normal booting	2 + 3 (see note below)
	<i>Do not</i> change the position of jumper J3102 unless directed to do so by the instructions in Appendix . The position of jumper J3102 does not need to be changed unless the programming sequence is interrupted.				

TABLE 1-2 Flash PROM Jumper Settings for Various Sun Systems (*Continued*)







System(s)	Jumper	Name	Pins 1 + 2 Select	Pins 2 + 3 Select	Default Jumper on Pins
Enterprise 250	J2704	Write-protect/ write-enable	Write-protect	Write-enable	2 + 3 (see note* below)
	J2804	Boot control	High-half booting	Normal booting	2 + 3 (see note** below)
	<p>*Jumper J2704 is factory-set so that the flash PROM is write-enabled. You use the keyswitch located on the front panel to write-protect the flash PROM. When the switch is set to the Locked position (), the flash PROM is write-protected. When the switch is set to the Power-On position () or to the Diagnostics position (), the flash PROM is write-enabled.</p> <p>**Do not change the position of jumper J2804 unless directed to do so by the instructions in Appendix . The position of jumper J2804 does not need to be changed unless the programming sequence is interrupted.</p>				
Ultra Enterprise 450	J3103	Write-protect/ write-enable	Write-protect	Write-enable	2 + 3 (see note* below)
	J5501	Boot control	High-half booting	Normal booting	2 + 3 (see note** below)
	<p>*Jumper J3103 is factory-set so that the flash PROM is write-enabled. You use the keyswitch located on the front panel to write-protect the flash PROM. When the switch is set to the Locked position (), the flash PROM is write-protected. When the switch is set to the Power-On position () or to the Diagnostics position (), the flash PROM is write-enabled.</p> <p>**Do not change the position of jumper J5501 unless directed to do so by the instructions in Appendix . The position of jumper J5501 does not need to be changed unless the programming sequence is interrupted.</p>				
Sun Blade 100	JP2	Write-protect/ write-enable	Write-protect	Write-enable	1 + 2

TABLE 1-2 Flash PROM Jumper Settings for Various Sun Systems (*Continued*)













System(s)	Jumper	Name	Pins 1 + 2 Select	Pins 2 + 3 Select	Default Jumper on Pins
Sun Fire V210/V240/Sun Netra 240	JP11	Write-protect/ write-enable	Write-protect	n/a	1 + 2 (see note* below)
	JP13	Boot control	Normal booting	High-half booting	1 + 2 (see note** below)
	<p>*Jumper JP11 is factory-set so that the flash PROM is write-enabled. You use the keyswitch located on the front panel to write-protect the flash PROM. When the switch is set to the Locked position (), the flash PROM is write-protected. When the switch is set to the Power-On position () or to the Diagnostics position (), the flash PROM is write-enabled.</p> <p>**Do not change the position of jumper JP13 unless directed to do so by the instructions in Appendix . The position of jumper JP31 does not need to be changed unless the programming sequence is interrupted.</p>				
Sun Fire V440	J4205	Write-protect/ write-enable	Write-protect	Write-enable	2 + 3 (see note* below)
	J4207	Boot control	High-half booting	Normal booting	2 + 3 (see note** below)
	<p>*Jumper J4205 is factory-set so that the flash PROM is write-enabled. You use the keyswitch located on the front panel to write-protect the flash PROM. When the switch is set to the Locked position (), the flash PROM is write-protected. When the switch is set to the Power-On position () or to the Diagnostics position (), the flash PROM is write-enabled.</p> <p>**Do not change the position of jumper J4207 unless directed to do so by the instructions in Appendix . The position of jumper J4207 does not need to be changed unless the programming sequence is interrupted.</p>				
Sun Fire V480/V490	J1104	Write-protect/ write-enable	Write-protect	Write-enable	2 + 3 (see note below)
	<p>Jumper J1104 is factory-set so that the flash PROM is write-enabled. You use the keyswitch located on the front panel to write-protect the flash PROM. When the switch is set to the Locked position (), the flash PROM is write-protected. When the switch is set to the Power-On position () or to the Diagnostics position (), the flash PROM is write-enabled.</p>				

TABLE 1-2 Flash PROM Jumper Settings for Various Sun Systems (Continued)

System(s)	Jumper	Name	Pins 1 + 2 Select	Pins 2 + 3 Select	Default Jumper on Pins
Sun Fire V880 and Sun Fire V890 - System I/O Board	J3003	Write-protect/write-enable	Write-protect	Write-enable	2 + 3 (see note* below)
	J3002	Boot control	High-half booting	Normal booting	2 + 3 (see note** below)
	<p>*Jumper J3003 is factory-set so that the flash PROM is write-enabled. You use the keyswitch located on the front panel to write-protect the flash PROM. When the switch is set to the Locked position (), the flash PROM is write-protected. When the switch is set to the Power-On position () or to the Diagnostics position (), the flash PROM is write-enabled.</p> <p>**Do not change the position of jumper J3002 unless directed to do so by the instructions in Appendix . The position of jumper J3002 does not need to be changed unless the programming sequence is interrupted.</p>				
Sun Blade 1000/Sun Fire 280R and Sun Netra T4	J2103	Write-protect	Write-enable	2 + 3	Flash PROM program enable
	J2104	Select	No Select	2 + 3	X or Logic Set

Updating the Flash PROM Using Utility Version 2.0 or Later

This chapter explains how to update your system's firmware using Flash PROM Update Utility Version 2.0 or later. It also gives examples of what to do if an error occurs during the update process.

2.1 Updating the Flash PROM

This section explains how to update the flash PROM.

2.1.1 Before You Begin

If you are running a version of the Flash PROM Update utility earlier than version 2.0, *do not use these instructions*. Refer instead to the instructions in [Appendix B "Updating the Flash PROM Using Utility Versions Earlier Than 2.0."](#) You'll find the version number of the Flash PROM Update utility displayed in the utility's banner.

Before you can update your system's flash PROM, you must ensure that the appropriate jumper (or front panel keyswitch) is set to allow the PROM to be written. The PROM cannot be updated if write-protection is enabled. Refer to ["Changing Flash PROM Jumpers"](#) on page 1-2.

2.1.2 What to Do

1. Power on the system.

The banner screen is displayed, and the system might attempt to autoboot, depending on how the system's non-volatile RAM (NVRAM) configuration variables are set.

The banner screen identifies the system type, the amount of memory installed, the Host ID, and the Ethernet address. Note that the information displayed is different for every system.

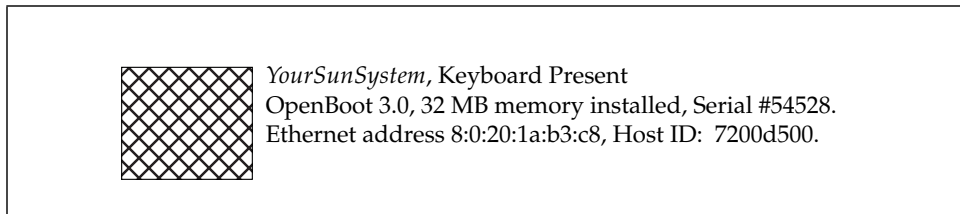

2. Press Stop-A (or press the Break key if running from a terminal connected to a serial port) to abort the autoboot sequence.

Note – The Stop-A command function operates on USB keyboards and non-USB keyboards. The reaction time for the command functions on USB keyboards might appear slower.

3. Insert the flash PROM CD into the CD-ROM drive.

4. At the ok prompt, type `boot cdrom` to start the Flash PROM Update utility.

```
Type help for more information
ok boot cdrom

Rebooting with command:
boot /sbus@1f,0/espdma@e,8400000/esp@e,8800000/sd@6,0:f
flash/SUNW,XXX-XXXX-latest
```

Note – The boot path shown in the example above will vary depending on your system and its hardware configuration.

A hard drive or network are also possible sources of booting, depending on your system configuration. See [“Booting the Utility From the Server” on page 3-4](#) for more information.

The initial utility banner screen is then displayed.

```
Standalone Flash PROM Update Utility, Rev. 2.x
Ultra(tm) 1
Ultra(tm) 2
Ultra(tm) 5/10
Ultra(tm) 30
Ultra(tm) 60 / E220R
Ultra(tm) 80 / E420R
Ultra(tm) Enterprise(tm) 250
Ultra(tm) Enterprise(tm) 450
Sun Blade(tm) 100
Sun Blade(tm) 1000
Sun Fire(tm) V210
Sun Fire(tm) V240
Sun Netra(tm) 240
Sun Fire(tm) 280R
Sun Netra(tm) T4
Sun Fire(tm) V440
Sun Fire(tm) V480
Sun Fire(tm) V490
Sun Fire(tm) V880
Sun Fire(tm) V890
```

```
This utility allows you to interactively update the firmware
revisions in specific system Flash PROM components.
```

```
Type h for help, q to quit, Return or Enter to continue:
```

5. Type h to view the help screen or press Return to continue.

If you view the help screen, the following information is displayed.

If the update completes normally then most customized values contained in the NVRAM will be retained. The following parameters are the exceptions;

* If you are using the PROM-level security feature, you ***MUST*** re-enter the 'security-password' value after the update but before turning the security feature back on! (Use the PROM's 'password' command.)

* 'use-nvramrc?' will always be set to 'false' (which is the default value).

If for some reason the utility is unable to retain a customized value other than those mentioned above, then a detailed message will be printed during the update, indicating the parameter name and its post-update value. If the update process is interrupted then it is possible that one or more of the customized values may be lost. For this reason it is recommended that you make a paper copy of any customized NVRAM values. You may 'quit' out of the program now if you need to create the list. (Use the 'printenv' command at the PROM's ok prompt to list all parameters.)

WARNING: If the contents of the system's CPU Flash PROM(s) have been previously modified by methods other than the flash update utilities released by Sun, then running this utility may render the system useless!

Type h for help, q to quit, Return or Enter to continue:

6. If you viewed this help screen, press Return to continue.

Every precaution should be taken to prevent the loss of system power during the Flash PROM programming process!

Type h for help, q to quit, Return or Enter to continue:

7. Type h for further information or press Return to continue.

If you view the help screen, the following information is displayed.

```
WARNING: If power is interrupted when the Flash PROM is being
reprogrammed, you MAY have to change a hardware jumper on the
system board if the system does not boot. If this program is
interrupted before it completes, you MUST reboot this program to
allow it to complete its reprogramming of the Flash PROM - even
if the system appears to function properly.
```

```
Type h for help, q to quit, Return or Enter to continue:
```

8. If you viewed this help screen, press Return to continue.

The firmware selection menu is displayed, as shown in the example below. The menu lists the OpenBoot™ PROM and POST revisions currently existing in your system and the revisions available on the CD.

Firmware Release(s) Currently Existing in the System	Firmware Release(s) Available for Installation	Install?
OBP 3.11.6 1997/12/08 10:42	OBP 3.17.1 1998/11/10 19:10	no
POST 2.2.8 1997/12/09 15:56	POST 2.3.1 1998/08/07 16:33	no

```
Type sa if you wish to select all available firmware releases for
installation. Type h for help, quit to exit, or cont to continue:
```

9. Type h for further information before making a selection.

If you view the help screen, the following information is displayed.

```
Usage: < ActionCode DeviceCode(s) | ServiceCode >
```

```
ActionCodes: s = select; d = deselect
```

```
DeviceCodes: o = OpenBoot (OBP); p = POST; a = all
```

```
ServiceCodes: quit = Exit the program.
```

```
cont = Continue with the program after making selections.
```

```
Type the letter h for help.
```

```
Command:
```

10. Read dates and version numbers in the firmware selection menu, then take one of the actions described below:

- If the revisions and date codes of OpenBoot PROM and/or POST shown in the Available for Installation column are later than those shown in the Currently Existing in the System column, you must update OpenBoot PROM and/or POST to the latest releases available. Go to [Step 11](#).
- If the revisions and date codes of OpenBoot PROM and/or POST shown in the Available for Installation column are the same or earlier than those shown in the Currently Existing in the System column, no firmware update is required. Type `quit` to exit the Flash PROM update utility, then go to [Step 15](#).

11. Type the appropriate code for your update. Update OpenBoot PROM and POST, type `sa` (select all).

Note – Always update both OpenBoot PROM and POST to the latest recommended firmware releases.

The firmware selection menu is then displayed with YES in the Install? column for each item that you selected for updating. The example below shows the selection menu after both OpenBoot PROM and POST have been selected for update.

Firmware Release(s) Currently Existing in the System	Firmware Release(s) Available for Installation	Install?
OBP 3.11.6 1997/12/08 10:42	OBP 3.17.1 1998/11/10 19:10	YES
POST 2.2.8 1997/12/09 15:56	POST 2.3.1 1998/08/07 16:33	YES

Type `sa` if you wish to select all available firmware releases for installation. Type `h` for help, `quit` to exit, or `cont` to continue:

12. At the command prompt, type `cont` to continue the utility.

An information screen is displayed.

The Flash programming process is about to begin.

Type `h` for help, `q` to quit, Return or Enter to continue:

13. Type h for more information or press Return to continue.

If you view the help screen, the following information is displayed.

```
This program will issue a reset command after the Flash PROM has
been successfully reprogrammed. If an error occurs during
programming then an error message will be printed and the program
will exit without issuing the reset command.
```

```
WARNING: If power is interrupted when the Flash PROM is being
reprogrammed, you MAY have to change a hardware jumper on the
system board if the system does not boot. If this program is
interrupted before it completes, you MUST reboot this program to
allow it to complete its reprogramming of the Flash PROM - even
if the system appears to function properly.
```

```
Refer to the following document for a complete set of
instructions; "Sun(tm) Flash PROM Guide for Workstations and
Workgroup Servers - Standalone Version"
```

```
The Flash programming process is about to begin.
```

```
Type h for help, q to quit, Return or Enter to continue:
```

14. If you viewed this help screen, press Return to continue.

As the utility updates the flash PROM firmware, progress information is displayed on the screen, as in the following example.

```
Erasing the top half of the Flash PROM.
Programming OBP into the top half of the Flash PROM.
Verifying OBP in the top half of the Flash PROM.
```

```
Erasing the bottom half of the Flash PROM.
Programming OBP into the bottom half of Flash PROM.
Verifying OBP in the bottom half of the Flash PROM.
```

```
Erasing the top half of the Flash PROM.
Programming POST into the top half of Flash PROM.
Verifying POST in the top half of the Flash PROM.
```

```
Programming was successful.
```

```
Resetting...
```

Note – The following example does not apply to Sun Blade 100, Sun Blade 1000, Sun Fire 280R, Sun Netra T4, Sun Fire V480, Sun Fire V880, or Sun Fire V890 systems.

```
Restoring previous NVRAM environment settings...
#power-cycles =      10
auto-boot? =        false
security-#badlogins = 0
keymap =             <custom keymap>
OK
Resetting...
```

Note – The text in the above example appears only if you are running the utility from a serial port A connection (for example, a TIP or telnet connection); the text does not appear if you are running the utility from a standard console interface. The NVRAM variables listed in the `Restoring previous NVRAM environment settings` section above are examples. You may see a different set of variables listed, depending on what has been customized in your system.

If there were no errors during the update, the system resets. If there were errors (for example, if any of the PROM's security features were enabled), the system does not reset and an error message is displayed. See [“Error Messages” on page 2-9](#).

Note – The NVRAM configuration variable, `use-nvramrc?`, might be modified to its default value (`False`) during the update process.

Note – If power to your site is interrupted during flash PROM updating, see [Appendix](#) for system recovery instructions.

15. After successful updating, return the flash PROM write-protect/write-enable jumper to the write-protect position to ensure system security (see Chapter 1). If your system is a Sun Enterprise 250, Ultra Enterprise 450, Sun Fire V240, Sun Netra 240, Sun Fire 280R, Sun Fire V440, Sun Fire V480, Sun Fire V490, Sun Fire V880, or Sun Fire V890, do not change the jumper. Instead, return the front panel keyswitch to the Locked position ().

2.2 Error Messages

If the flash PROM is write-protected or if the NVRAM configuration variable `security-mode` is enabled and an attempt is made to update the flash PROM, one of the following error messages is displayed.

2.2.1 Example 1—Write-Protect/Write-Enable Jumper Message on System With No Front Panel Keyswitch

The following is an example of an error message received when the utility is loaded onto a system that has no front panel keyswitch, and when the motherboard write-protect/write-enable jumper is not set to write-enable.

```
Could not communicate with the Flash PROM on the system board.  
  
It is possible that the part is defective, or that the Flash PROM  
is write protected via the hardware 'Write Protect/Enable' jumper.  
Check the setting of the CPU board jumper <Jxxx>.  
  
Program terminated  
ok
```

Note – The jumper number shown in the above example (<Jxxx>) will change, depending on your hardware platform. See [“Changing Flash PROM Jumpers”](#) on [page 1-2](#) for instructions on setting jumpers.

2.2.2 Example 2—Write-Protect/Write-Enable Jumper Message on System With Front Panel Keyswitch

The following is an example of an error message received when the utility is loaded onto a system with a front panel keyswitch (Sun Enterprise 250, Ultra Enterprise 450, Sun Fire V240, Sun Netra 240, Sun Fire 280R, Sun Fire V440, Sun Fire V480, Sun Fire V490, Sun Fire V880, or Sun Fire V890), and when the keyswitch is not set to write-enable.

```
Could not communicate with the Flash PROM on the system board.  
  
It is possible that the part is defective, or that the Flash PROM  
is write protected via the hardware 'Write Protect/Enable' jumper.  
Verify that the front panel keyswitch is not in a secure position,  
and if necessary, check the setting of the CPU board jumper </jxxx>.  
  
Program terminated  
ok
```

Note – The jumper number shown in the above example (</jxxx>) will change, depending on your hardware platform. See [“Changing Flash PROM Jumpers” on page 1-2](#) for instructions on setting jumpers or keyswitches.

2.2.3 Example 3—NVRAM Configuration Variable

The following is an example of an error message received when the utility is loaded but system security is set via the `security-mode` NVRAM configuration variable.

```
**ERROR: System security is set:  
System firmware was not modified.
```

2.2.4 Example 4—Flash PROM Sectors Protected

The following is an example of an error message received when the utility is loaded onto a system for which flash PROM sectors were programmed as protected at the factory. For example, if one or more sectors are programmed as write-protected at a vendor site (prior to having the flash PROM soldered onto the system board), then the utility will not be able to update the flash PROM, even if the write-protect/write-enable jumper is set to write-enable.

```
The FLASH PROM device in this system cannot be reprogrammed.  
You need to contact your service provider for information on  
updating the FLASH PROM device in this system. For further  
details, please refer to the latest revision of "Sun(tm) Flash PROM  
Guide for Workstations and Workgroup Servers - Standalone  
Version".
```

```
Protected sectors: 0 1 6 7 10 11 12 13
```

```
Program terminated
```

Note – The sectors shown above are examples. The sectors displayed for your system may vary.

If you encounter this error, it is necessary to replace the system motherboard to upgrade the firmware. Contact Sun Service or your service provider for more information.

Setting Up a Flash PROM Boot Server

The procedures in this chapter are optional. Use this chapter only if you want to set up a boot server so that clients can boot the Flash PROM utility from the network. This chapter does not contain the procedure for setting up a client server. See your software documentation for the client server setup procedure.

Note – These procedures apply only to networks running the Solaris Operating System.

3.1 Using Volume Manager to Install Flash PROM Packages

If Volume Manager is running on your system, you can use its automount CD feature when installing flash PROM packages to your server. Use the following procedure to determine whether Volume Manager is running on your system, then install the packages either with or without Volume Manager.

3.1.1 Checking Volume Manager Status

1. Use the operating system `ps` utility to determine whether Volume Manager (`vold`) is running.

Consult the man pages for `ps` if necessary.

2. If Volume Manager is not running, but you would like to use its automount CD feature:

- a. Log in as superuser with the `su` command and your superuser password.

- b. As superuser, start Volume Manager. Type:

```
/etc/init.d/volmgt start
```

3.1.2 Installing Packages With Volume Manager

1. Insert the Flash Update CD into the CD-ROM drive.

The CD is mounted automatically by Volume Manager.

The mount point is `/cdrom`.

2. To add a package, type:

```
/usr/sbin/pkgadd -d <device> -R <root_path> <package_name>
```

For example:

```
/usr/sbin/pkgadd -d  
/cdrom/cdrom0/s0/SMCC -R /flash SUNWflnel
```

The `<root_path>` depends on how the partitions were set up. To determine your `<root_path>`, look at the root path that is specified in the server's `/etc/bootparams` file. In the example above, the packages would be directed to the previously nonexistent standalone flash directory.



Caution – Always use the `-R <root_path>` option in the `pkgadd` command and specify a path other than `"/` (top-level root directory). If the `-R` option is left out or if the `"/` directory is specified then the system running the `pkgadd` command will no longer boot to the Solaris Operating System. That is, you will have to reload the Solaris Operating System completely, or recover from your backup resources.

3. Remove the CD from the CD-ROM drive. Type:

```
eject cdrom
```

3.1.3 Installing Packages Without Volume Manager

Note – You must run all of the commands in this procedure as superuser.

1. Use the `su` command and your superuser password to become superuser.

2. If the `/cdrom` directory is not already present, create it. Type:

```
mkdir /cdrom
```

3. Mount the CD. Type:

```
mount -o ro -F hsfs /dev/dsk/c0t6d0s0 /cdrom
```

4. Change directories to the CD. Type:

```
cd /cdrom/SMCC
```

5. To add a package, type:

```
/usr/sbin/pkgadd -d <device> -R <root_path> <package_name>
```

For example:

```
/usr/sbin/pkgadd -d /cdrom/cdrom0/s0/SMCC -R /flash SUNWflnel
```

The `<root_path>` depends on how the partitions were set up. To determine your `<root_path>`, look at the root path that is specified in the server's `/etc/bootparams` file. In the example illustrated above, the packages would be directed to the previously nonexistent standalone flash directory.



Caution – Always use the `-R <root_path>` option in the `pkgadd` command and specify a path other than `"/` (top-level root directory). If the `-R` option is left out or if the `"/` directory is specified then the system running the `pkgadd` command will no longer boot to the Solaris Operating System. That is, you will have to reload the Solaris Operating System completely, or recover from your backup resources.

6. When finished, exit the `cdrom` directory. Type:

```
cd /
```

7. Unmount the CD. Type:

```
umount /cdrom
```

8. Remove the CD from the CD-ROM drive. Type:

```
eject cdrom
```

3.2 Booting the Utility From the Server

Note – Do not move files from the directories into which `pkgadd` has placed them.

3.2.1 Booting the Utility as a Client

The following instructions assume you copied the system binary for your platform into the `root_path` directory specified in the `pkgadd` command line:

- **Set up your clients to boot from the system binary for your platform.**

3.2.2 Booting the Utility as a Server

If the flash PROM utility package was installed on a standalone basis, you must supply some or all of the `root_path` information in your boot command.

- If the default `root_path` was used in the `pkgadd` command line, the package was added to the `/` directory. Since the system automatically looks for the boot file in `/platform/sun4u`, you must specify only the `flash/<PlatformNumber-latest>` portion in the boot command, where `PlatformNumber-latest` is the number given for your platform in the "Number" column of [TABLE 3-1 on page 3-6](#). Typing the word, "latest" provides a link to the latest version of the software on the CD.

For example, if your boot disk is `disk3` and your system is an Ultra 1 Creator 3D, Model 200E, to boot the utility from the PROM monitor, type:

```
boot disk3 flash/SUNW,501-4134-latest
```

This command is equivalent to typing:

```
boot disk3 /platform/sun4u/flash/SUNW,501-4134-latest
```

- If the `root_path` was specified as other than `/`, you must supply the `root_path` as a prefix to `/platform/sun4u/flash/<PlatformNumber-latest>`. For example, if you specified `/Flash` as the `root_path` on `disk2` of an Ultra 60 system, then from the PROM monitor you would boot the utility with the following command:

```
boot disk2 /Flash/platform/sun4u/flash/SUNW,501-4450-latest
```

3.3 Package Names and Contents

Two packages are available for each hardware platform:

- A package name ending with the letter “l” contains only the latest firmware revisions.
- A package name ending with the letter “b” contains the latest firmware revisions *and* all previously released revisions.

Typically, only the latest revisions are used, meaning that only the package ending with “l” is added. See [TABLE 3-1 on page 3-6](#) for platform numbers and packages.

Note – *Do not* add a “b” package or load old firmware revisions unless your system administrator directs you to do so.

If you are directed to load an old firmware revision, you must boot the image directly:

```
# boot cdrom flash/SUNW,501-xxxx-yy
```

In the above example, *xxxx* is a number that represents the platform, and *yy* is a number that indicates the specific firmware revision to be booted.

TABLE 3-1 Platform Numbers and Packages

Platform	Number	Packages
Ultra 1 Model 140	SUNW,501-2836	SUNWflnel SUNWflneb
Ultra 1 Model 170	SUNW,501-3082	SUNWflnel SUNWflneb
Ultra 1 Creator Model 140E	SUNW,501-4291	SUNWfle1l SUNWfle1b
Ultra 1 Creator Model 170E	SUNW,501-2486	SUNWfle1l SUNWfle1b
Ultra 1 Creator Model 200E	SUNW,501-4134	SUNWfle2l SUNWfle2b
Ultra 1 Creator 3D Model 140E	SUNW,501-4291	SUNWfle1l SUNWfle1b
Ultra 1 Creator 3D Model 170E	SUNW,501-2486	SUNWfle1l SUNWfle1b
Ultra 1 Creator 3D Model 200E	SUNW,501-4134	SUNWfle2l SUNWfle2b
Ultra Enterprise 1 Model 140	SUNW,501-2836	SUNWflnel SUNWflneb
Ultra Enterprise 1 Model 170	SUNW,501-3082	SUNWflnel SUNWflneb
Ultra 2 Creator, all models	SUNW,501-3132	SUNWflpul SUNWflpub
Ultra 2 Creator 3D, all models	SUNW,501-3132	SUNWflpul SUNWflpub
Ultra Enterprise 2, all models	SUNW,501-3132	SUNWflpul SUNWflpub
Ultra 5/Ultra 10, all models	SUNW,375-0009	SUNWfldal SUNWfldab
Ultra 30, all models	SUNW,501-3139	SUNWflqu1 SUNWflqub
Ultra 60/Sun Enterprise 220R,all models	SUNW,501-4450	SUNWfldel SUNWfldelb
Ultra 80/Sun Enterprise 420R,all models	SUNW,501-5168	SUNWflqr1 SUNWflqrb

TABLE 3-1 Platform Numbers and Packages (Continued)

Platform	Number	Packages
Sun Enterprise 250, all models	SUNW,501-4681	SUNWflja1 SUNWfljab
Ultra Enterprise 450, all models	SUNW,501-2996	SUNWflta1 SUNWfltab
Sun Blade 100	SUNW,501-0096	SUNWflgrb SUNWflgr1
Sun Blade 1000	SUNW,501-4143	SUNWflexb SUNWflexl
Sun Fire 280R	SUNW,501-4143	SUNWflexb SUNWflexl
Sun Netra T4	SUNW,501-4143	SUNWflexb SUNWflexl
Sun Fire V480	SUNW,501-5819	SUNWflchb SUNWflchl
Sun Fire V490	SUNW,501-5819	SUNWflchb SUNWflchl
Sun Fire V880	SUNW,501-4300	SUNWfldkb SUNWfldk1
Sun Fire V890	SUNW,501-4300	SUNWfldkb SUNWfldk1

Power Interruption During Updating

A.1 Power Interruption Recovery Scenarios

If power to your system is interrupted during updating of the flash PROM:

1. Turn the power switch to the Standby position to prevent power surge to the system when power is restored.
2. After power is restored to the system location, return the power switch to the Power-On position.

After power is restored, one of the following two recovery scenarios should happen on your system. Follow the instructions described for the appropriate scenario.

A.1.1 Scenario 1—System Recovers After Power Restoration

If your system attempts to autoboot after power is restored, or if it returns to the flash PROM's ok prompt, you *must* complete the programming process by rebooting the flash PROM utility. See [“Updating the Flash PROM” on page 2-1](#).

A.1.2 Scenario 2—System Does Not Recover After Power Restoration

If your system does not boot or return to the `ok` prompt after power is restored:

Note – The Ultra 5, Ultra 10, and Sun Blade 100 systems do not have jumpers for high-half booting. If your system is an Ultra 5, Ultra 10, or Sun Blade 100, you must contact your service provider.

1. **If the update was being run via a serial port and the system also has a frame buffer and keyboard installed, or if the system has a keyboard and more than one frame buffer installed:**
 - a. **Connect a monitor to each frame buffer.**
 - b. **Confirm that output has been redirected to one of the frame buffers.**
 - The NVRAM configuration variables *might* have been modified because of the firmware update just before power was lost. If this happened, then the system output was possibly redirected to a device other than the one originally used to display it. This could only have happened if a keyboard was connected to the system.
 - If there is no keyboard connected to the system and the NVRAM configuration variables are set to their default values, then system input and output are directed to serial port A.
2. **If output cannot be found on any of the installed frame buffers, follow the procedure in the section “[Changing Jumper or Keyswitch Settings](#)” on page 1-2 to set the boot control jumper to boot from the half of the PROM that is not currently selected:**
 - If the jumper is set for “high-half booting,” move it to “normal booting.”
 - If the jumper is set for “normal booting,” move it to “high-half booting.”
3. **Power on the system.**
 - If the system recovers, complete the updating process by rebooting the flash PROM utility. See “[Updating the Flash PROM](#)” on page 2-1.
 - If the system does not recover, repeat [Step 1](#) and [Step 2](#).
4. **If the system *still* does not recover after you complete [Step 1](#) and [Step 2](#) a second time, contact your service provider.**

Updating the Flash PROM Using Utility Versions Earlier Than 2.0

B.1 Updating the Flash PROM

Note – Before you can update your system’s flash PROM, you must set the appropriate jumper (or front panel keyswitch) to disable write-protection. Refer to [“Changing Flash PROM Jumpers” on page 1-2](#).

1. Power on the system.

The banner screen is displayed, and the system might attempt to autoboot, depending on how the system’s non-volatile RAM (NVRAM) configuration variables are set.

The banner screen identifies the system type, the amount of memory installed, the Host ID, and the Ethernet address. Note that the information displayed is different for every system.

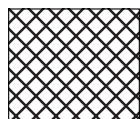

YourSunSystem, Keyboard Present
OpenBoot 3.0, 32 MB memory installed, Serial #54528.
Ethernet address 8:0:20:1a:b3:c8, Host ID: 7200d500.

2. Press Stop-A (or press the Break key if running from a terminal connected to a serial port) to abort the autoboot sequence.

Note – The Stop-A command function operates on USB keyboards and non-USB keyboards. The reaction time for the command functions on USB keyboards might appear slower.

3. Insert the flash PROM CD into the CD-ROM drive.
4. At the `ok` prompt, type `boot cdrom` to start the Flash PROM Update utility.

```
Type help for more information
ok boot cdrom

Now rebooting to load correct binary.
Resetting...

Rebooting with command:
boot /sbus@1f,0/espdma@e,8400000/esp@e,8800000/sd@6,0:f
flash/SUNW,XXX-XXXX-latest
```

Note – The boot path shown in the example above will vary depending on your system and its hardware configuration.

A hard drive or network are also possible sources of booting, depending on your system configuration. See [“Booting the Utility From the Server”](#) on page 3-4 for more information.

The initial utility banner screen is then displayed.

```
Standalone Flash PROM Update Utility, Rev. 1.y
```

```
Ultra(tm) 1  
Ultra(tm) 2  
Ultra(tm) 5/10  
Ultra(tm) 30  
Ultra(tm) 60 / E220R  
Ultra(tm) 80 / E420R  
Ultra(tm) Enterprise(tm) 250  
Ultra(tm) Enterprise(tm) 450
```

This utility allows you to interactively update the firmware revisions in specific system Flash PROM components.

Type h for help, q to quit, Return or Enter to continue:

5. Type h to view the help screen or press Return to continue.

If you view the help screen, the following information is displayed.

```
This program is used to update the firmware in this system's CPU PROM.
```

```
Updating the CPU Flash PROM may cause the contents of the NVRAM configuration variables to be reset to their default values (except variable 'diag-switch?', which may be set to 'true'). If you have customized NVRAM contents which must be retained, then you will need to save (or note) the contents of the NVRAM before the Flash PROM gets updated and restore the NVRAM contents after the update.
```

```
NOTE: Failure to note and restore the NVRAM values may cause the system to behave in an unexpected manner after the update.
```

```
WARNING: If the contents of the system's CPU Flash PROM(s) have been modified by methods other than this utility, then running this utility may render the system useless!
```

```
Type h for help, q to quit, Return or Enter to continue:
```

6. If you viewed this help screen, press Return to continue.

Every precaution should be taken to prevent the loss of system power during the Flash PROM programming process!

Type h for help, q to quit, Return or Enter to continue:

7. Type h for further information or press Return to continue.

If you view the help screen, the following information is displayed.

WARNING: If power is interrupted when the Flash PROM is being reprogrammed, you MAY have to change a hardware jumper on the system board if the system does not boot. If this program is interrupted before it completes, you MUST reboot this program to allow it to complete its reprogramming of the Flash PROM - even if the system appears to boot normally.

Type h for help, q to quit, Return or Enter to continue:

8. If you viewed the help screen, press Return to continue.

The firmware selection menu is displayed, as shown in the example below. The menu lists the OpenBoot firmware and POST revisions currently existing in your system and the revisions available on the CD.

Firmware Release(s) Currently Existing in the System	Firmware Release(s) Available for Installation	Install?
OBP 3.3.9 1996/07/07 11:21	OBP 3.5.0 1996/12/18 09:10	no
POST 1.0.4 1996/07/10 13:16	POST 1.0.7 1996/12/17 18:10	no

Type sa if you wish to select all available firmware releases for installation. Type h for help, quit to exit, or cont to continue:

9. Type h for further information before making a selection.

If you view the help screen, the following information is displayed.

```

Usage: < ActionCode DeviceCode(s) | ServiceCode >

ActionCodes:  s = select; d = deselect
DeviceCodes:  o = OpenBoot (OBP); p = POST; a = all
ServiceCodes: quit = Exit the program.
               cont = Continue the program.

Type the letter h for help.
Command:

```

10. Read dates and version numbers in the firmware selection menu, then take one of the actions described below:

- If the revisions and date codes of OpenBoot firmware and/or POST shown in the Available for Installation column are later than those shown in the Currently Existing in the System column, you must update OpenBoot firmware and/or POST to the latest releases available. **Go to Step 11.**
- If the revisions and date codes of OpenBoot firmware and/or POST shown in the Available for Installation column are the same or earlier than those shown in the Currently Existing in the System column, no firmware update is required. **Type quit to exit the Flash PROM utility, then go to Step 15.**

11. Type the appropriate code for your update.

- To update OpenBoot firmware and POST, type **sa** (select all).
- To update OpenBoot firmware only, type **so** (select OpenBoot).
- To update POST only, type **sp** (select POST).
- If no update is required, type **quit** to exit the utility.

The firmware selection menu is displayed with YES in the Install? column for each item that you selected for updating. The example below shows the selection screen after both OpenBoot firmware and POST have been selected for update.

```

      Firmware Release(s)           Firmware Release(s)
Currently Existing in the System   Available for Installation /  Install?
-----
OBP 3.3.9 1996/07/07 11:21         OBP 3.5.0 1996/12/18 09:10         YES
POST 1.0.4 1996/07/10 13:16       POST 1.0.7 1996/12/17 18:10       YES

Type sa if you wish to select all available firmware releases for
installation. Type h for help, quit to exit, or cont to continue:

```

12. At the command prompt, type `cont` to continue the utility.

An information screen is displayed.

```
The Flash programming process is about to begin.  
  
Type h for help, q to quit, Return or Enter to continue:
```

13. Type `h` for more information or press Return to continue.

If you view the help screen, the following information is displayed.

```
This program will issue a reset command after the Flash PROM has  
been successfully reprogrammed. If an error occurs during  
programming then an error message will be printed and the program  
will exit without attempting to reboot.  
  
WARNING: If power is interrupted when the Flash PROM is being  
reprogrammed, you MAY have to change a hardware jumper on the  
system board if the system does not boot. If this program is  
interrupted before it completes, you MUST reboot this program to  
allow it to complete its reprogramming of the Flash PROM - even  
if the system appears to boot normally.  
  
Refer to the "Ultra(tm) Systems Flash PROM Programming Guide" for  
a complete set of instructions.  
  
The Flash programming process is about to begin.  
  
Type h for help, q to quit, Return or Enter to continue:
```

Note – The *Ultra Systems Flash PROM Programming Guide* referenced in the above screen text is the former title of this document, the *Sun Flash PROM Guide for Workstations and Workgroup Servers—Standalone Version*.

14. If you viewed this help screen, press Return to continue.

As the utility updates the flash PROM, the percentage completed is displayed on the screen.

```
100% complete.  
Programming was successful: Rebooting...  
  
Resetting...
```

If there were no errors during the update, and if there are no customized NVRAM configuration variables, the system resets. If there were errors (for example, if any of the PROM's security features were enabled), the system does not reset and an error message is displayed. Refer to [“Error Messages” on page B-9](#) for error message examples.

The following information might be displayed on the screen.

```
**IMPORTANT** As a consequence of the firmware upgrade that just  
took place, it is very possible (but not certain) that the  
customized values in the configuration variables will revert to  
their *default values* upon the next system power-cycle or soft-  
reset. (The exception is that "diag-switch?" may be automatically  
set to "true".) If this happens then it could have a significant  
effect on the behavior of the system after the power-cycle/soft-  
reset.
```

```
Following is a list of the system's NVRAM configuration variables  
which have been customized (i.e. they are different than the  
default values). You may wish to write down the values of the  
indicated configuration variables so that they may be restored (if  
necessary) after the next power-cycle or soft-reset. (Type "help  
system" at the PROM monitor's ok prompt to get information about  
setting the configuration variables.
```

The system does not reset if any assigned default values of the PROM's NVRAM configuration variables have been modified. Instead, the system's customized NVRAM configuration variables are listed on the screen. An example listing is given below (the actual display will vary, depending on the system's setup).

```
Variable Name  Customized Value
fcode-debug?   true
auto-boot?    false
use-nvramrc?   true
nvramrc       <type 'printenv nvramrc' to see full buffer contents>
```

NOTE The "use-nvramrc?" variable is active (true) and the "nvramrc" buffer is not empty, so you will want to evaluate whether or not to reinstall the code in nvramrc if the configuration variables are indeed reset to their default values - and if they are *not* reset to default values then you may also want to evaluate if the contents of nvramrc are still valid and necessary. For help on restoring/modifying the contents of nvramrc, type "help nvram" at the PROM's ok prompt.

The NVRAM configuration variables might be modified during the reboot process. Such change might cause the system to boot differently than it would have prior to the firmware update. For example, the flash PROM updating procedure might result in automatically setting the `diag-switch?` NVRAM parameters to `true`. If this occurs, the system might attempt to boot from the network (`net`), which is the default setting.

If the system attempts to boot from the network:

1. Press Stop-A.
2. At the `ok` prompt, type `setenv diag-switch? false`

Also, assignment of console input/output devices might be modified such that output is no longer visible on a previously assigned output device.

Note – If power to your site is interrupted during updating, see [Appendix A](#) for system recovery instructions.

15. **After successful updating, return the flash PROM write-protect/write-enable jumper to the write-protect position to ensure system security. If your system is a Sun Enterprise 250 or Ultra Enterprise 450, do not change the jumper. Instead, return the front panel keyswitch to the Locked position (🔒).**

B.2 Error Messages

If the flash PROM is write-protected or if the NVRAM configuration variable `security-mode` is enabled and an attempt is made to update the flash PROM, one of the following error messages is displayed.

B.2.1 Example 1—Write-Protect/Write-Enable Jumper

The following is an example of an error message received when the utility is loaded but the write-protect/write-enable jumper is not set to write-enable.

```
Could not communicate with the Flash PROM on the system board.
```

```
It is possible that the part is defective, or that the Flash PROM  
is write protected via the hardware 'Write Protect/Enable'  
jumper.
```

```
UNABLE TO PROCEED WITH THE REQUESTED FIRMWARE MODIFICATIONS
```

```
Program terminated  
ok
```

B.2.2 Example 2—NVRAM Configuration Variable

The following is an example of an error message received when the utility is loaded but system security is set via the `security-mode` NVRAM configuration variable.

```
**ERROR: System security is set:  
System firmware was not modified.
```