

Netra t 1120/1125

Installation and Basic Maintenance Guide



THE NETWORK IS THE COMPUTER™

Sun Microsystems, Inc.

901 San Antonio Road
Palo Alto, CA 94303-4900 USA
650 960-1300 Fax 650 969-9131

Part No.: 805-6803-10
Revision A, August 1998

Copyright 1998 Sun Microsystems Computer Company • 901 San Antonio Road • Palo Alto • California 94303 • U.S.A. 415-960-1300 • Fax 415 969-9131. All rights reserved.

This product or document is protected by copyright and distributed under licenses restricting its use, copying, distribution, and decompilation. No part of this product or document may be reproduced in any form by any means without prior written authorization of Sun and its licensors, if any.

Portions of this product may be derived from the UNIX[®] system, licensed from Novell, Inc., and from the Berkeley 4.3 BSD system, licensed from the University of California. UNIX is a registered trademark in the United States and in other countries and is exclusively licensed by X/Open Company Ltd. Third-party software, including font technology in this product, is protected by copyright and licensed from Sun's suppliers. RESTRICTED RIGHTS: Use, duplication, or disclosure by the U.S. Government is subject to restrictions of FAR 52.227-14(g)(2)(6/87) and FAR 52.227-19(6/87), or DFAR 252.227-7015(b)(6/95) and DFAR 227.7202-3(a).

Sun, Sun Microsystems, the Sun logo, Solaris, Netra and the Netra logo are trademarks or registered trademarks of Sun Microsystems, Inc. in the United States and in other countries. All SPARC trademarks are used under license and are trademarks or registered trademarks of SPARC International, Inc. in the United States and in other countries. Products bearing SPARC trademarks are based upon an architecture developed by Sun Microsystems, Inc.

The OPEN LOOK[®] and Sun[™] Graphical User Interfaces were developed by Sun Microsystems, Inc. for its users and licensees. Sun acknowledges the pioneering efforts of Xerox Corporation in researching and developing the concept of visual or graphical user interfaces for the computer industry. Sun holds a nonexclusive license from Xerox to the Xerox Graphical User Interface, which license also covers Sun's licensees who implement OPEN LOOK GUIs and otherwise comply with Sun's written license agreements.

THIS PUBLICATION IS PROVIDED "AS IS" WITHOUT WARRANTY OF ANY KIND, EITHER EXPRESS OR IMPLIED, INCLUDING, BUT NOT LIMITED TO, THE IMPLIED WARRANTIES OF MERCHANTABILITY, FITNESS FOR A PARTICULAR PURPOSE, OR NON-INFRINGEMENT.

Copyright 1998 Sun Microsystems Computer Company • 901 San Antonio Road • Palo Alto • California 94303 U.S.A. • 415-960-1300 • Fax 415 969-9131. Tous droits réservés.

Ce produit ou document est protégé par un copyright et distribué avec des licences qui en restreignent l'utilisation, la copie et la décompilation. Aucune partie de ce produit ou de sa documentation associée ne peut être reproduite sous aucune forme, par quelque moyen que ce soit, sans l'autorisation préalable et écrite de Sun et de ses bailleurs de licence, s'il y en a.

Des parties de ce produit pourront être dérivées du système UNIX[®] licencié par Novell, Inc. et du système Berkeley 4.3 BSD licencié par l'Université de Californie. UNIX est une marque enregistrée aux Etats-Unis et dans d'autres pays, et licenciée exclusivement par X/Open Company Ltd. Le logiciel détenu par des tiers, et qui comprend la technologie relative aux polices de caractères, est protégé par un copyright et licencié par des fournisseurs de Sun.

Sun, Sun Microsystems, le logo Sun, Solaris, Netra et le logo Netra sont des marques déposées ou enregistrées de Sun Microsystems, Inc. aux Etats-Unis et dans d'autres pays. Toutes les marques SPARC, utilisées sous licence, sont des marques déposées ou enregistrées de SPARC International, Inc. aux Etats-Unis et dans d'autres pays. Les produits portant les marques SPARC sont basés sur une architecture développée par Sun Microsystems, Inc.

Les utilisateurs d'interfaces graphiques OPEN LOOK[®] et Sun[™] ont été développés de Sun Microsystems, Inc. pour ses utilisateurs et licenciés. Sun reconnaît les efforts de pionniers de Xerox Corporation pour la recherche et le développement du concept des interfaces d'utilisation visuelle ou graphique pour l'industrie de l'informatique. Sun détient une licence non exclusive de Xerox sur l'interface d'utilisation graphique, cette licence couvrant aussi les licenciés de Sun qui mettent en place les utilisateurs d'interfaces graphiques OPEN LOOK et qui en outre se conforment aux licences écrites de Sun.

CETTE PUBLICATION EST FOURNIE "EN L'ETAT" SANS GARANTIE D'AUCUNE SORTE, NI EXPRESSE NI IMPLICITE, Y COMPRIS, ET SANS QUE CETTE LISTE NE SOIT LIMITATIVE, DES GARANTIES CONCERNANT LA VALEUR MARCHANDE, L'APTITUDE DES PRODUITS A REpondre A UNE UTILISATION PARTICULIERE OU LE FAIT QU'ILS NE SOIENT PAS CONTREFAISANTS DE PRODUITS DE TIERS.



Contents

Figures vii

Tables ix

Preface xi

- 1. About System Installation 1**
- 2. System Installation 3**
 - Before you Install the Netra t 1120/1125 3
 - Environmental Considerations 4
 - Dimensions 4
 - Forced Air Cooling Requirements 5
 - Mechanical Considerations 7
 - Mounting Flanges 7
 - To Remove the Sacrificial Shipping Plates 8
- 3. Electrical Supply Installation 13**
 - System Switch 13
 - DC Source Site Requirements 14
 - DC Supply and Ground Conductor 15
 - Dual Grounding Environment 16

Power and Grounding Connections	16
AC Source Site Requirements	19
Grounding	19
Grounding in an IT Power System (e.g. Norway)	19
Dual Grounding Environment	20
4. External I/O Connections	23
Connector Layout	23
Serial Connectors	24
Media Independent Interface (MII) Connector	25
Cable-Type Connectivity	26
External Cable Length	26
Twisted-Pair Ethernet (TPE) Connector	27
TPE Cable-Type Connectivity	27
SCSI Connector	28
SCSI Implementation	29
SCSI Cabling and Configuration	30
SCSI Cabling Procedure	30
SCSI-2 (Fast Wide SCSI) External Devices	31
Alarms Port	32
Parallel Interface	33
5. Installing Netra t 11xx Alarms Software	35
Local Installation	35
Network Installation	35
Installation Procedure	36
Local Installation	36
Network Installation	37
Installing SunVTS	38

6. Replacing the Air Filters 39

Index 41

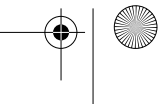
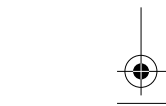
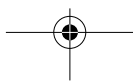
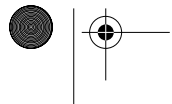
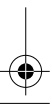
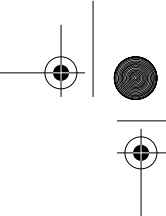
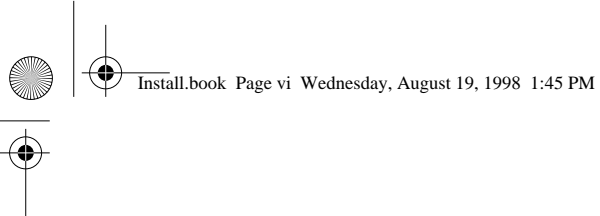

Figures

FIGURE 2-1	Rackmount Netra t 1120/1125 Airflow Requirements (front and rear)	5
FIGURE 2-2	Rackmount Netra t 1120/1125 Airflow Requirements (open rack)	6
FIGURE 2-3	Rackmount Netra t 1120/1125 Airflow Requirements (closed rack)	6
FIGURE 2-4	Sacrificial Shipping Plates	8
FIGURE 2-5	Netra t 1120/1125 19-inch Configuration (all dimensions shown in mm)	9
FIGURE 2-6	Netra t 1120/1125 23-inch Configuration (all dimensions shown in mm)	10
FIGURE 2-7	Netra t 1120/1125 24-inch Configuration (all dimensions shown in mm)	11
FIGURE 2-8	Netra t 1120/1125 IEC917 Configuration (all dimensions shown in mm)	12
FIGURE 3-1	Netra t 1120 Power and Grounding Connections	16
FIGURE 3-2	Netra t 1125 Grounding Points	20
FIGURE 3-3	System Power-On (Front Panel)	21
FIGURE 3-4	System Power-off (Front Panel)	22
FIGURE 4-1	Back Panel Connectors	23
FIGURE 4-2	DB-25 Serial Connectors	24
FIGURE 4-3	40-Pin Miniature-D MII Connector	25
FIGURE 4-4	RJ45 TPE Socket	27
FIGURE 4-5	68-Pin SCSI Connector	28
FIGURE 4-6	Connecting External Mass Storage Devices	31
FIGURE 4-7	Alarms Connector Configuration	32

FIGURE 4-8 DB-25 Parallel Connector 33

FIGURE 6-1 Replacing the Air Filters 40

Tables

TABLE 3-1	Netra t 1120 Power and Grounding Connections	16
TABLE 4-1	Serial Connector Pinouts, RS423/RS232	24
TABLE 4-2	Connector Pinouts	25
TABLE 4-3	MII External Cable Lengths	26
TABLE 4-5	TPE STP-5 Cable Lengths	27
TABLE 4-4	TPE Connector Pinouts	27
TABLE 4-6	68-Pin SCSI Connector Pinouts	28
TABLE 4-7	Determining SCSI Bus Length	30
TABLE 4-8	Alarms Connector Line Assignments	32
TABLE 4-9	Parallel Connector Pinouts	33

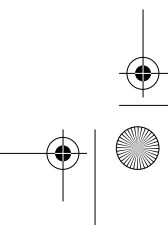
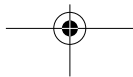
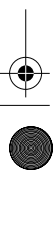
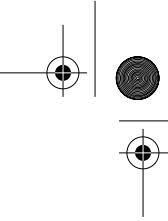
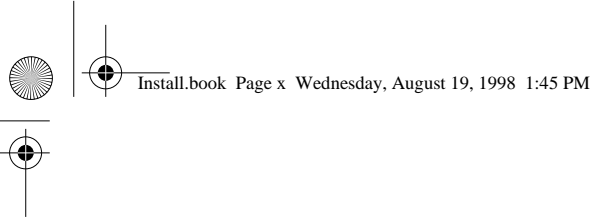

Preface

The *Netra t 1120/1125 Installation and Basic Maintenance Guide* describes the installation and basic maintenance procedures for the Netra t 1120 (order code N04) and Netra t 1125 (order code N03).

Note – This Guide does not apply to the version of Netra t 1120 supplied as order code N02.

Note – All illustrations in this guide are of the Netra t 1125, except where the two types of system differ, in which case examples of both are shown.

Who Should Use This Guide

This guide is intended to be read by installation engineers, software support engineers and service personnel. It is not intended for the end-user of the system.

How This Guide Is Organized

The guide is arranged as follows:

Chapter 1, “About System Installation”, describes the software and hardware features supported in this release of the Netra t 1120/1125 system.

Chapter 2, “System Installation”, covers all environmental and site requirements.

Chapter 3, “Electrical Supply Installation”, describes the required electrical installation.

Chapter 4, “External I/O Connections”, provides information on external I/O connectors.

Chapter 5, “Installing Netra t 11xx Alarms Software”, describes the steps required to install a software release.

Chapter 6, “Replacing the Air Filters”, shows how to replace the air filters.

Accompanying Documentation

- Netra t 1120/1125 Compliance and Safety Manual (805-6806-10)

Note – Read the Netra t 1120/1125 *Compliance and Safety Manual* before doing anything else.

- Netra t 1120/1125 User’s Guide (805-6802-10)
 - Netra t 1120/1125 Service Manual (805-6804-10)
 - Netra t 1120/1125 System Reference Manual (805-6805-10)
-

Conventions used in this Guide

The following table shows the type changes and symbols used in this guide.

TABLE P-1 Typographic Conventions

Typeface or Symbol	Meaning	Example
AaBbCc123	The names of commands, files, and directories; on-screen computer output	Edit your <code>.login</code> file. Use <code>ls -a</code> to list all files. system% You have mail.
AaBbCc123	What you type, as opposed to on-screen computer output	system% su Password:
<i>AaBbCc123</i>	Command-line placeholder: replace with a real name or value	To delete a file, type <code>rm filename</code> .

TABLE P-1 Typographic Conventions

Typeface or Symbol	Meaning	Example
<i>AaBbCc123</i>	Book titles, new words or terms, or words to be emphasized	Read Chapter 6 in <i>User's Guide</i> . These are called <i>class</i> options. You <i>must</i> be root to do this.
%	UNIX C shell prompt	system%
\$	UNIX Bourne and Korn shell prompt	system\$
#	super-user prompt, all shells	system#

Symbols

Note – A note provides information which should be considered by the reader.



Caution – Cautions identified by this Attention icon carry information about procedures or events which if not considered may cause damage to the data or hardware of your system.



Caution – Cautions identified by this Hazard icon carry information about procedures which must be followed to reduce the risk of electric shock and danger to personal health. Follow all instructions carefully.

1125

Paragraphs accompanied by this 1125 icon apply only to Netra t 1125 systems.

1120

Paragraphs accompanied by this 1120 icon apply only to Netra t 1120 systems.

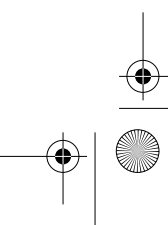
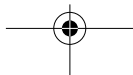
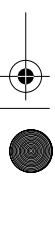
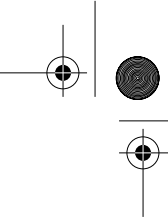
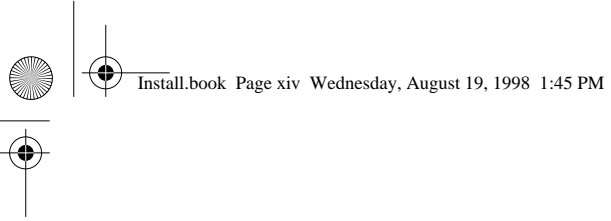

CHAPTER 1

About System Installation

Note – New systems are shipped pre-installed with JumpStart software; see the *JumpStart Quick Reference Guide* for more details. For instructions on how to install the Netra t 11xx software, refer to Chapter 5, "Installing Netra t 11xx Alarms Software".

The Netra t 1120/1125 release software consists of a CD-ROM:

- Netra t 11xx Alarms software (X-Option No. X6905A)
 - Alarms driver
 - Alarms utilities
 - Manual pages `tsalarm(7D)`, `tsctl(1M)`, `tsdog(1M)`, `tsmonitor(1M)`, `tsstate(1M)` and `tsunlock(1M)`.

The Netra t 11xx software release occupies approximately 25Mbytes in addition to the standard Solaris installation.

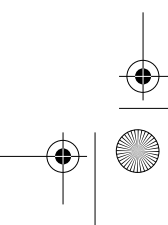
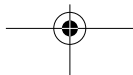
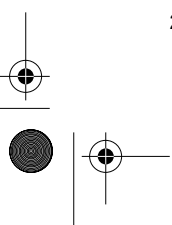
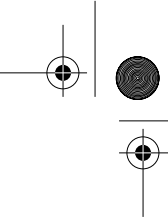
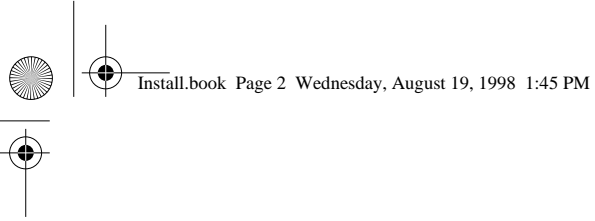

CHAPTER **2**

System Installation

This section provides information on what should be considered when choosing a location for a Netra t 1120/1125 system.

Before you Install the Netra t 1120/1125

Before you install the system, verify that the correct power supply is available. Refer to Chapter 3, "Electrical Supply Installation", for further information.

Environmental Considerations

The system can be installed in an environment with the following specific parameter ranges:

- Ambient temperature
 - operating: 5° to 40°C
 - exceptional operating limit: -5° to 55°C^{1, 2}
 - storage: -40° to 70°C
- Relative humidity
 - operating: 5 to 80% non-condensing³
 - storage: 10 to 95% non-condensing
- Elevation
 - operating: -300 to +3000m
 - storage: -300 to +12000m

Dimensions

- Height: 177mm (7in.) 4U NOM
- Width: 431.8mm (17in.)
- Depth: 496.1mm (19.53in.)
- Weight: maximum 23kg (51lb)

These dimensions are for the product in its normal 19-inch configuration, but without slide handles fitted; other rack sizes require the use of central rack-mount flange adaptors. The overall width of these flanges varies according to the rack size.

1. Error-free operation of the removable media devices is from 0° to 40°C.
2. No more than 96 hours duration at extremes and at elevations less than 1800m.
3. Subject to a maximum absolute humidity of 0.024kg of water per kg of dry air.

Forced Air Cooling Requirements

1. Adequate airflow through the host equipment frame must be ensured. The Netra t 1120/1125 utilizes internal fans that can achieve a maximum airflow of 150cfm in free air.
2. The air is drawn through the front of the Netra t 1120/1125 enclosure and expelled from the rear of the enclosure.
3. The inlet and exhaust ventilation areas must be a minimum of 200cm² each.
4. To maintain adequate airflow we strongly recommend that you inspect and, if necessary, replace the air filter on a regular basis. See Chapter 6, "Replacing the Air Filters" for further information. (Air filters (Pack of 10) Part No. F250-1351.)
5. If the Netra t 1120/1125 computer system is fully enclosed by its host equipment rack, the host rack must have ventilation openings in the front door. This permits unrestricted access to an external air source.

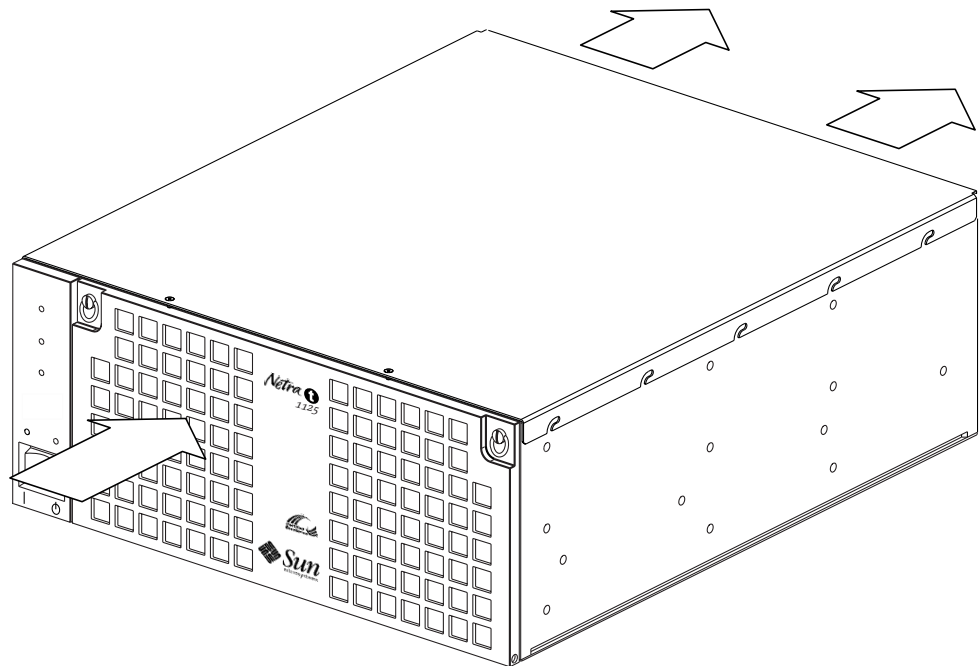

FIGURE 2-1 Rackmount Netra t 1120/1125 Airflow Requirements (front and rear)

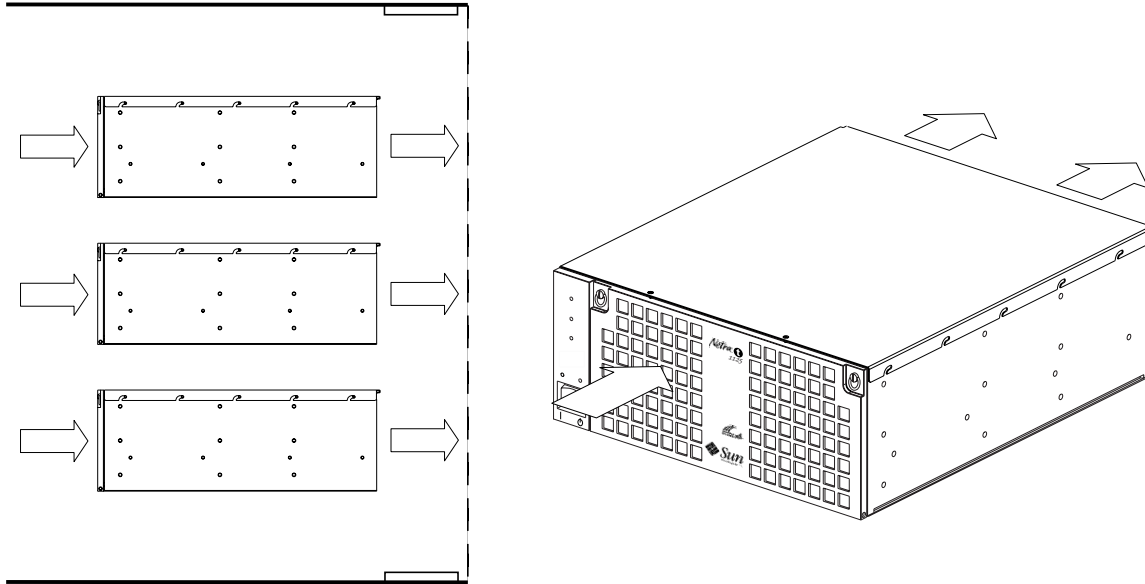

FIGURE 2-2 Rackmount Netra t 1120/1125 Airflow Requirements (open rack)

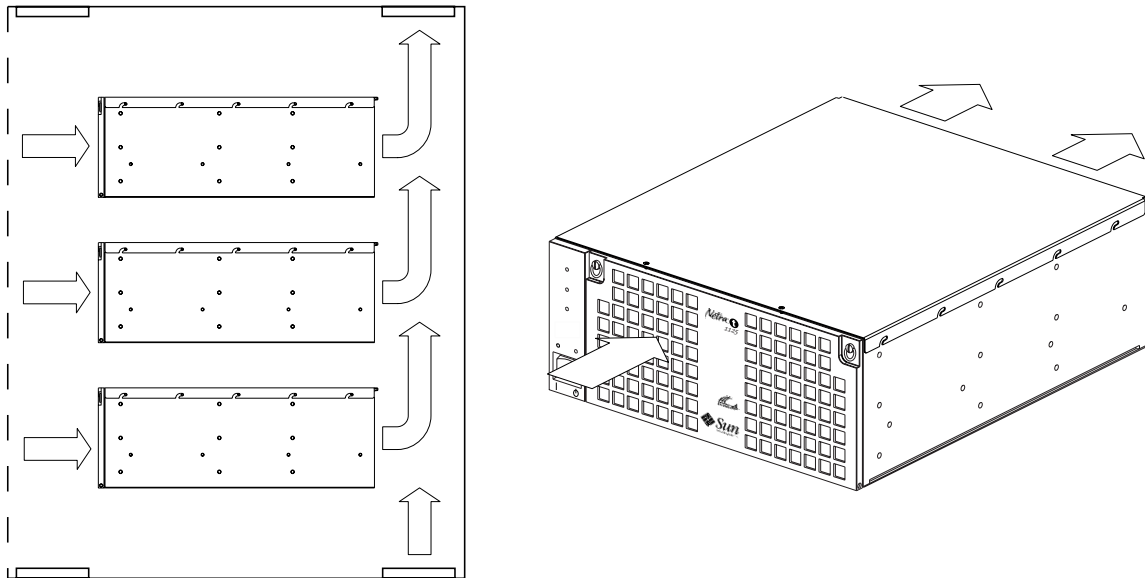

FIGURE 2-3 Rackmount Netra t 1120/1125 Airflow Requirements (closed rack)

Mechanical Considerations



Caution – The Netra t 1120/1125 system, when fully loaded, can weigh up to 23kg (51lb); hence mechanical assistance may be required if installing a fully-loaded unit.

Mounting Flanges

The Netra t 1120/1125 chassis has been designed for a wide variety of mounting options/rack sizes. A choice of mounting flanges to suit 19-inch, 23-inch, 24-inch or 600-mm nominal frame widths can be ordered as required:

- X-Option X6901A (19-inch configuration)
- X-Option X6902A (23-inch configuration)
- X-Option X6903A (24-inch configuration)
- X-Option X6904A (600mm configuration)

Select the mounting position most suitable for the rack type and seismic environment. There are four fixing locations provided on a Netra t 1120/1125; one at the front, two in the centre and one at the rear. If the front location is required, first ensure that, if fitted, the sacrificial shipping plates have been removed (see FIGURE 2-4 on page 8). Where possible, the two sacrificial shipping plates should only be removed *after* mounting the system in a rack.

Fit the mounting flanges in the selected position using the six M5 countersunk screws provided with the mounting kit and a Phillips No. 1 screwdriver. If required, you can fit the supplied handles to the mounting flanges before fitting flanges to the system or, alternatively, fit them to the mounted flanges.

To mount slides, all eight (four per side) M4 screws should be fitted. The recommended tightening torque for the M4 recess screws is 1.7Nm (1.25lbf-ft).

The chassis must be secured within the rack frame using screws suitable for the equipment frame. They must be a minimum size of M5 (10/32) depending on the frame requirement. All screws must be fitted; there are positions provided for a total of eight screws (four per side). The recommended tightening torque value for M5 recess head screws is 4.0Nm (3.0lbf-ft).



Caution – For installations located in earthquake risk zones 3 and 4, a minimum of two hard mounting locations (four flanges) must be used.

To Remove the Sacrificial Shipping Plates

Where possible, the two sacrificial shipping plates should only be removed *after* mounting the system in a rack. Remove the two M5 screws securing each plate to the system.

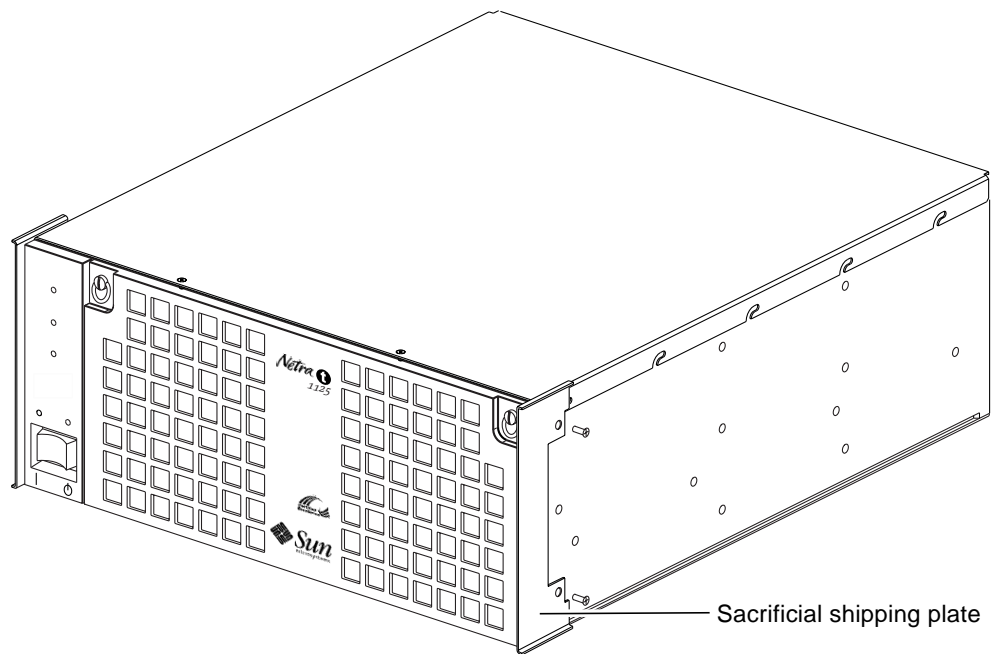

FIGURE 2-4 Sacrificial Shipping Plates

Note – Please retain the plates and system packaging for future use.

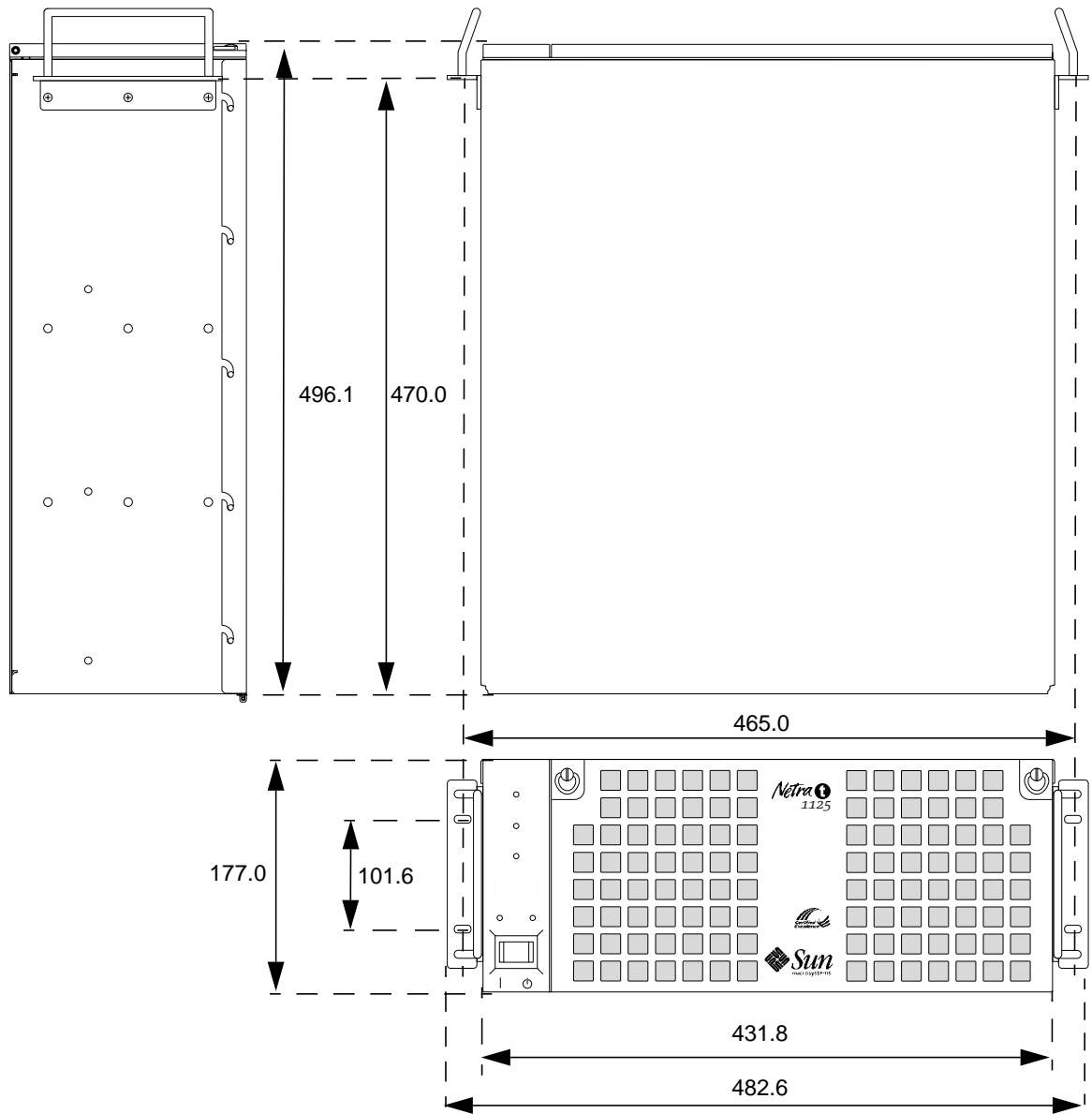

FIGURE 2-5 Netra t 1120/1125 19-inch Configuration (all dimensions shown in mm)

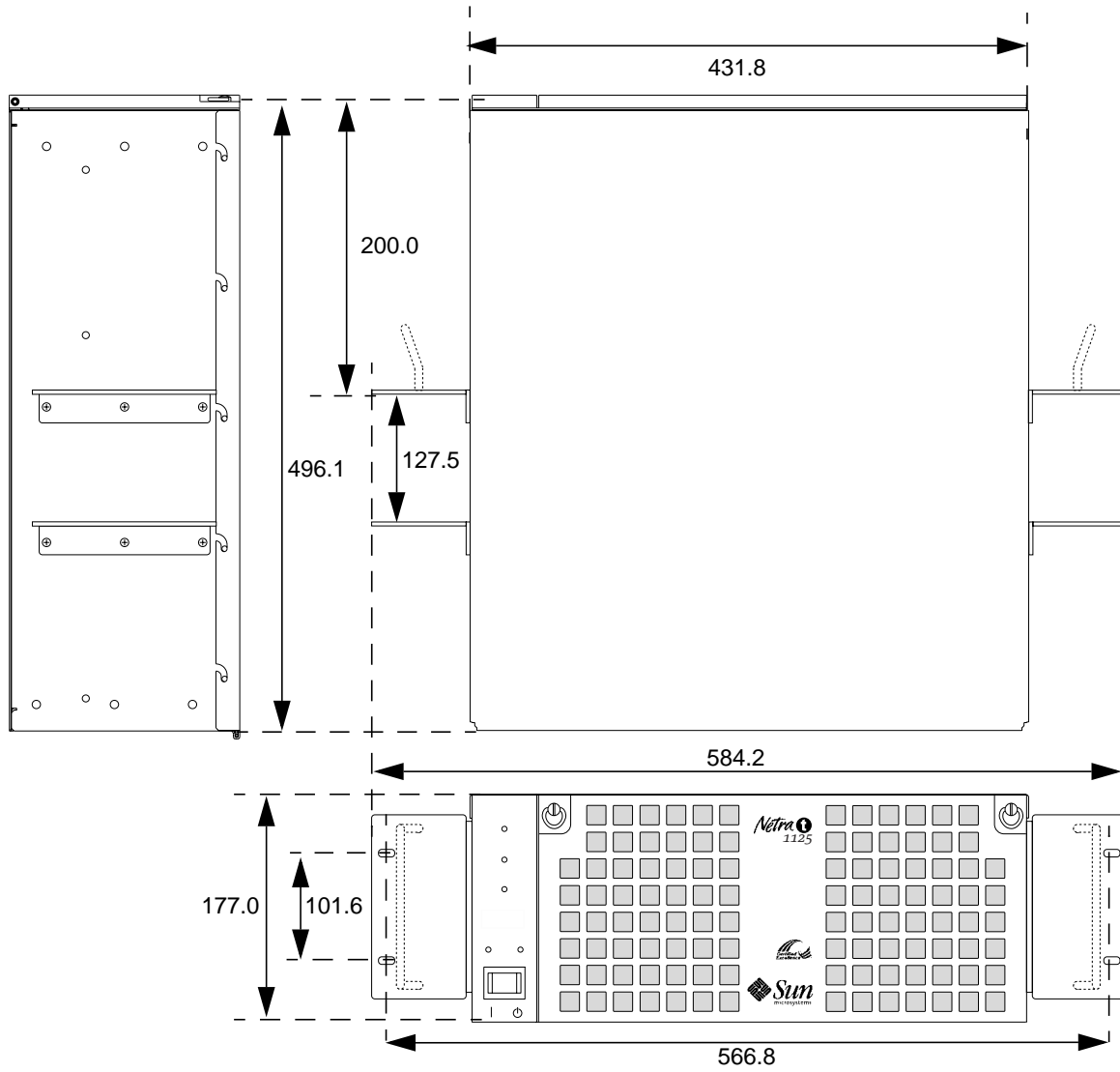

FIGURE 2-6 Netra t 1120/1125 23-inch Configuration (all dimensions shown in mm)

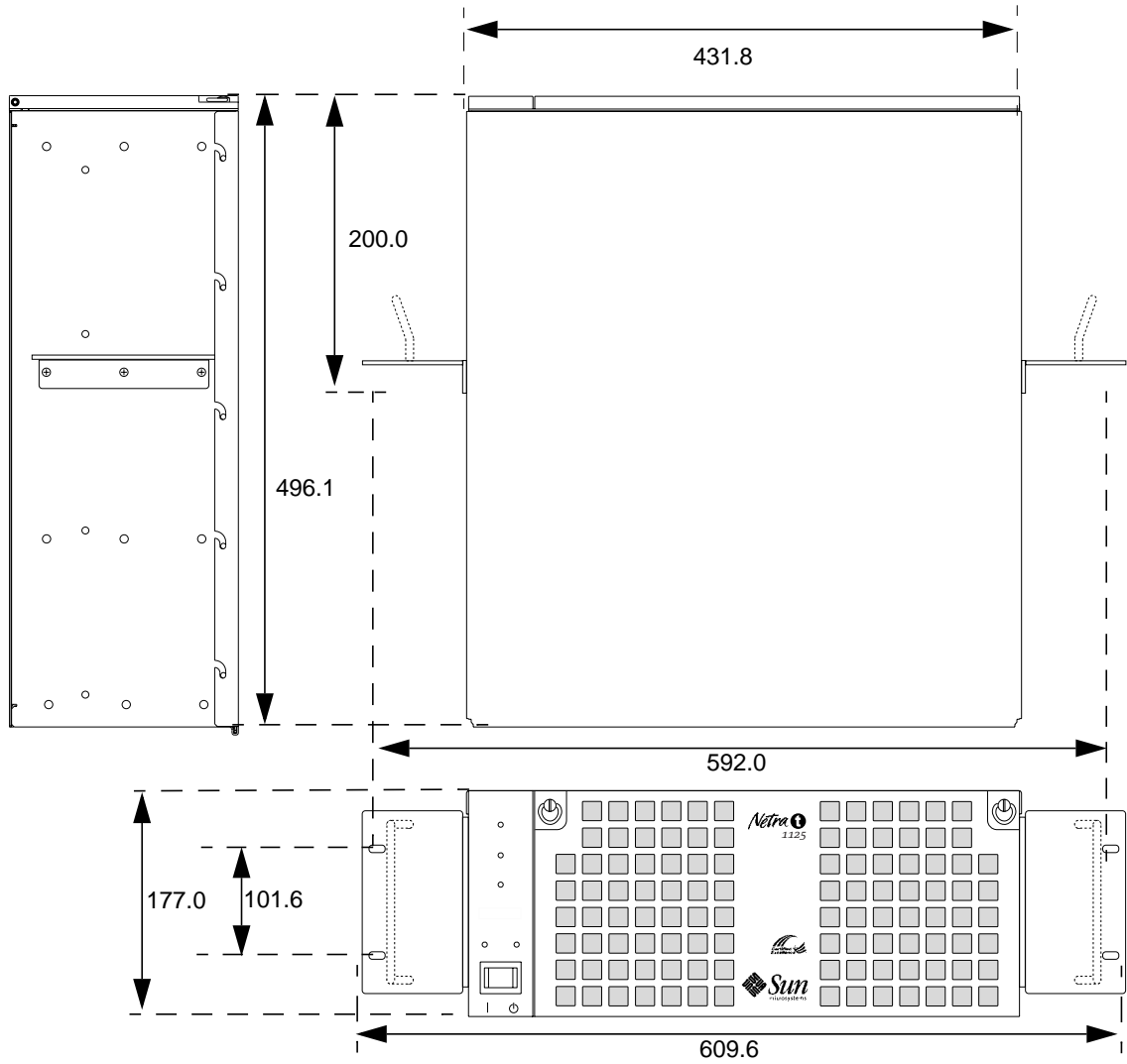

FIGURE 2-7 Netra t 1120/1125 24-inch Configuration (all dimensions shown in mm)

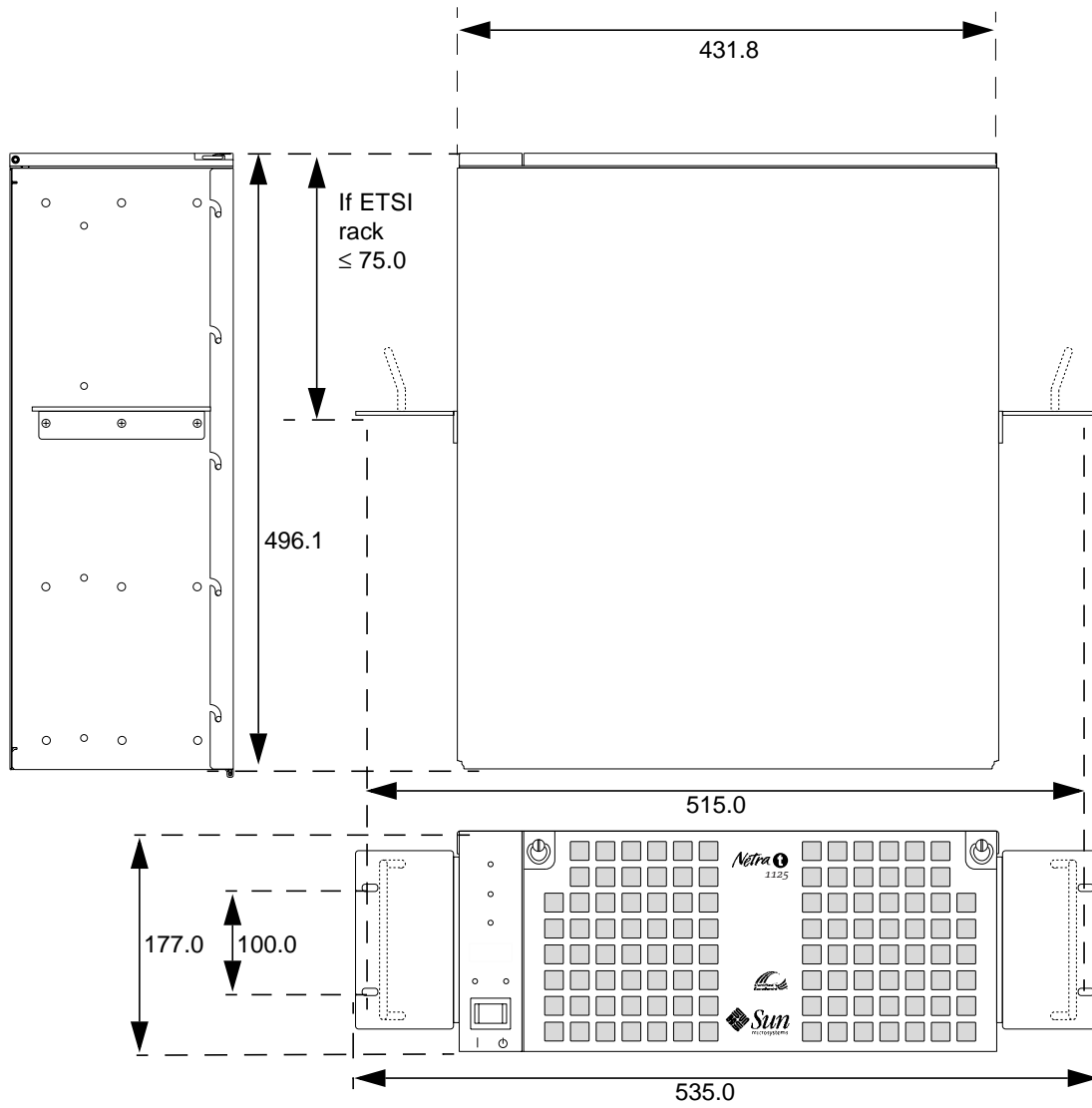

FIGURE 2-8 Netra t 1120/1125 IEC917 Configuration (all dimensions shown in mm)

CHAPTER 3

Electrical Supply Installation

This chapter provides information about electrical supply installation.

System Switch

The system switch of the Netra t 1120/1125 system functions as a standby device enabling and disabling the power module outputs. The system switch is a rocker, momentary switch.

The system does not contain any integral circuit breakers. Removal of the input power connector(s) is the only means of isolating the system from power.

1120

Both connections must be broken to isolate the system.

Alternatively, the system can be isolated using the external circuit breaker(s).

Note – The ON/STBY switch handles low voltage signals only; the high-power circuits do not pass through this switch.

1120

The Netra t 1120 has a pair of Amp 2-way Universal MATE-N-LOK II connectors, one for each power feed, together with a pair of 10-32 UNF (M5) threaded studs to act as a chassis ground point. The mating connectors are specified in the section “DC Source Site Requirements” on page 14.

1125

The Netra t 1125 has an IEC 320 appliance coupler for connection to mains power, together with a pair of 10-32 UNF (M5) threaded studs to act as an additional chassis ground point (for IT power system installations). The mating connectors are specified in the section “AC Source Site Requirements” on page 19.

1120

DC Source Site Requirements

The DC source site requirements are as follows:

- Suitable for use in -48Vdc nominal or -60Vdc nominal systems.
- The supply source must be electrically isolated from any AC source.
- The DC source must be reliably connected to earth (i.e. battery room positive bus is connected to the grounding electrode).
- Must be capable of providing up to 750W of continuous power per feed pair.

Overcurrent protection requirements:

- Overcurrent protection devices must be provided as part of each host equipment rack.
- Circuit breakers must be located between DC source and the Netra t 1120 system.
 - Option 1 – Two 20A double-pole fast trip DC rated circuit breakers (one per feed pair). This is the recommended option.
 - Option 2 – Two 20A single-pole fast trip DC rated circuit breakers (one per ungrounded supply conductor) in the -Ve supply conductor.
- Circuit breakers must not trip when presented with inrush current of 55A lasting 5 μ s.

Note – Overcurrent devices must meet applicable national and local electrical safety codes and be approved for the intended application.

Required Connection Materials

DC branch circuits:

- Two Amp 2-way Universal MATE-N-LOK II mating connectors (one per feed pair); (part number: 770017-1 with high current contact pins 193841-1) are supplied with the shipkit with each system.

Grounding:

- One Thomas & Betts two-hole lug (part number: 54204-UB) suitable for 8AWG conductor or UL/CSA approved equivalent having 5/8-inch pitch. Torque value: 3.5Nm maximum.
- A Thomas & Betts crimping tool (part number: TBM 5-S), or approved equivalent is required to secure the lug on to the cable.
- An earthing bus bar that is near the equipment and easily accessible.

Dual Grounding Environment

- Additional Thomas & Betts two-hole lug for logic 0V studs.



Caution – External filtering and/or surge suppression devices may be required on the power feeds where branch circuit electromagnetic characteristics are unknown.

DC Supply and Ground Conductor

The requirements are:

- Suitable conductor material: copper only.
- Supply conductors: 14 AWG (between the Netra t 1120 and circuit breaker).
- Ground conductor: 8 AWG.
- Cable insulation rating: minimum 75°C, Low Smoke Fume (LSF), Flame Retardant.
- Cable type shall be one of:
 - UL style 1028 or other UL 1581(VW-1) compliant equivalent, or
 - IEEE 383 compliant, or
 - IEEE 1202-1991 compliant or classified.
- Branch circuit cable insulation color: per applicable national electrical codes.
- Grounding cable insulation color: green/yellow.



Note – Do not open the top access cover unless the system has been powered down and all power cables have been removed.

Dual Grounding Environment

To be compatible with isolated ground environments (requiring isolation between logic 0V and chassis ground), the fitted grounding bridge plate must be removed and individual connections made to logic 0V and chassis ground studs. The grounding bridge plate is located on the rear of the unit.

Power and Grounding Connections

The following table shows which cables should be connected to which pins on each connector:

TABLE 3-1 Netra t 1120 Power and Grounding Connections

Connector/pin	Conductor
Input A/1	RTN FEED A
Input A/2	-48V FEED A
Input B/1	RTN FEED B
Input B/2	-48V FEED B

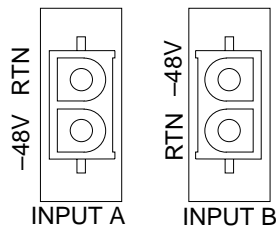
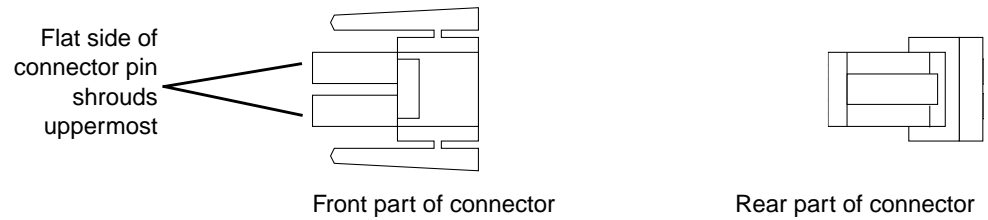

FIGURE 3-1 Netra t 1120 Power and Grounding Connections

▼ To Assemble the Power and Grounding Connector

1. Identify the front and rear parts of the connector and their correct orientation.



2. Strip 5mm of insulation from the cables, insert the tinned bare ends into the pins, and solder the pins to the wires.

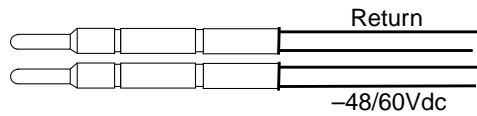

3. From the back of the rear part of the connector, push the pins in until they are fully engaged.

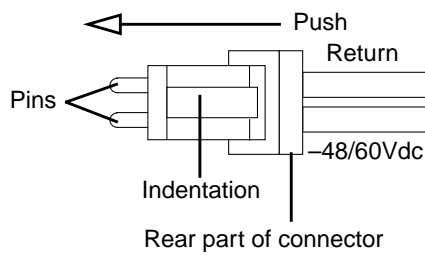

4. Hold the front part of the connector with the flat side of the pin shrouds on the uppermost.

5. Push the front and rear parts together to assemble the connector.

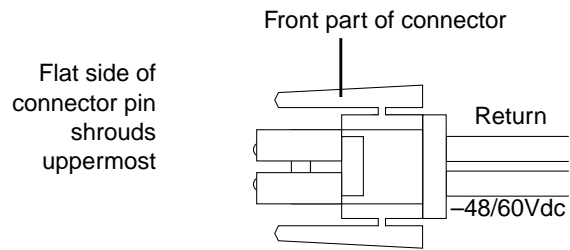
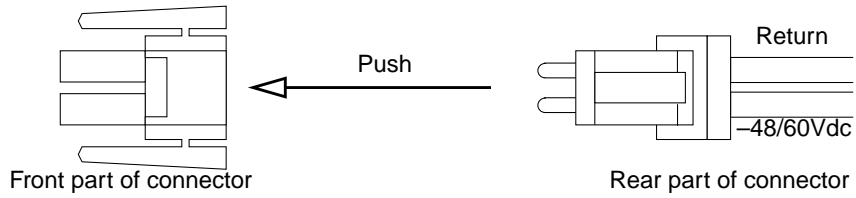

1125

AC Source Site Requirements

The AC source site requirements are as follows:

- Overcurrent protection devices must be provided as part of each host equipment rack.
- Circuit breakers must be located between the AC source and the Netra t 1125 system.
- Circuit breakers must not trip when presented with inrush current of 20A lasting 2ms.

Note – Overcurrent devices must meet applicable national and local electrical safety codes and be approved for the intended application.

The disconnect device for servicing is defined as:

- The appliance inlet on the rear of the system, or
- The circuit breakers in the rack in which the system is mounted, or
- The mains plug.

It must be ensured that these remain accessible after installation.



Caution – External filtering and/or surge suppression devices may be required on the power feeds where branch circuit electromagnetic characteristics are unknown.

Grounding

The safety earth path is established by the connection of the grounding conductor within the AC power cord to a “reliably” earthed socket outlet located near the equipment.

Grounding in an IT Power System (e.g. Norway)

The safety earth path is established by connection of a green/yellow insulated copper conductor (min. 1mm²) fitted between the chassis earth stud on the rear of the unit near the earth symbol (see FIGURE 3-2 on page 20) and a “reliable” earth

point located near the equipment. An AC socket outlet protected by a double pole double throw circuit breaker may be required by national and/or local electrical authorities.



Note – Do not open the top access cover unless the system has been powered down and all power cables have been removed.

Dual Grounding Environment

To be compatible with isolated ground environments (requiring isolation between logic 0V and chassis ground), the fitted grounding bridge plate must be removed and individual connections made to logic 0V and chassis ground studs. The grounding bridge plate is located on the rear of the unit (see FIGURE 3-2).

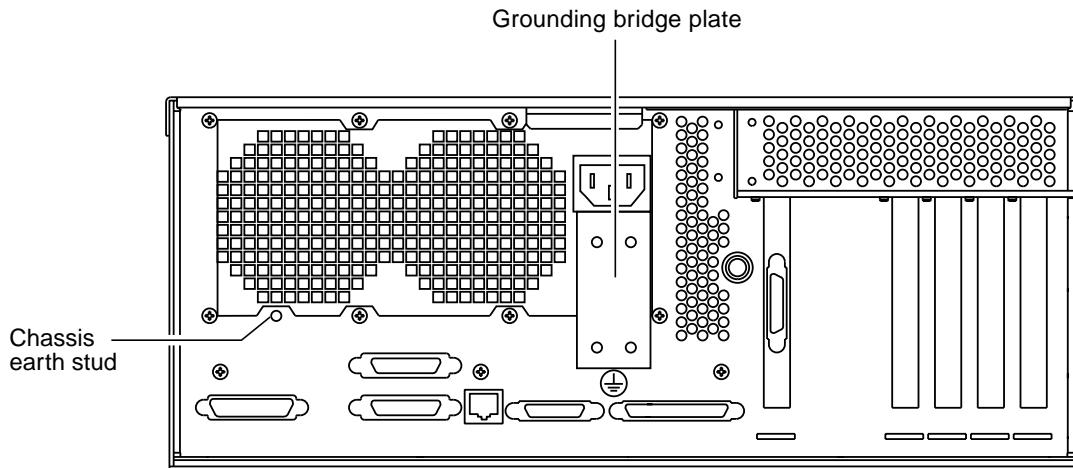

FIGURE 3-2 Netra t 1125 Grounding Points

▼ To Power On the System

1120

1. Prior to powering on, inspect the supply conductors for correct polarity and mechanical security.

2. Activate the external circuit breaker(s), or

1125

plug it into the mains supply.

3. Momentarily set the front panel ON/STBY system switch to the ON | position and hold it until the system starts to power up.

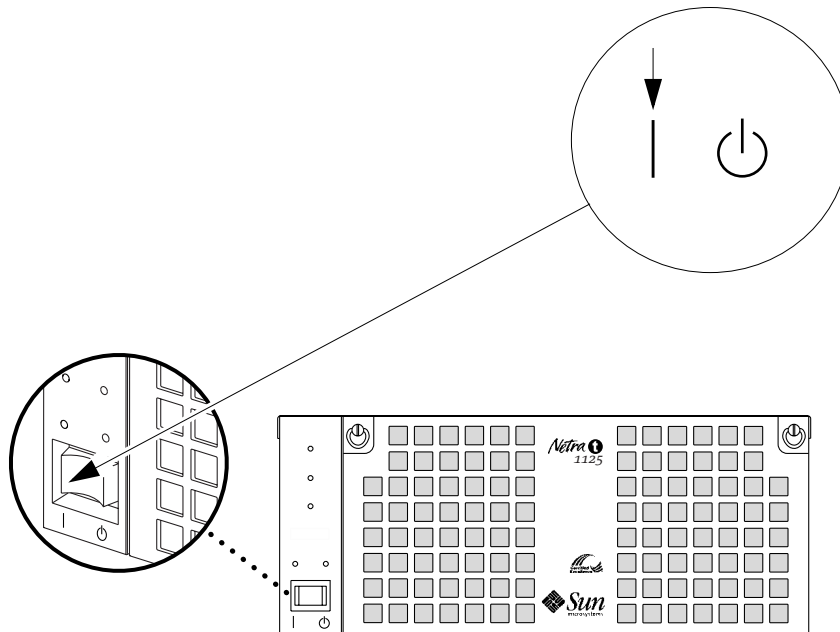



FIGURE 3-3 System Power-On (Front Panel)

▼ To Power Off the System



Caution – Prior to turning off system power, exit from the operating system. Failure to do so may result in data loss.

1. Where necessary, notify the users that the system is going down.
2. Back up system files and data.
3. Halt the operating system.
4. Momentarily set the front panel ON/STBY system switch to the STBY  position until the system powers down.
5. Verify that the Power LED is off.
6. Disconnect the AC or DC power connector(s) from the rear of the system, or open the external circuit breaker(s).



Caution – Regardless of the position of the ON/STBY switch, where an AC power cord remains connected to the system, potentially dangerous voltages are always present within the power supply.

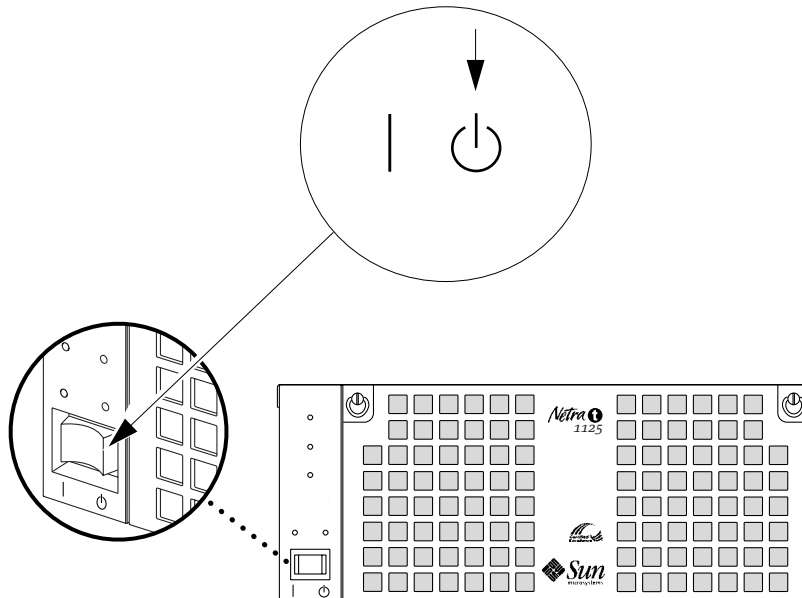

FIGURE 3-4 System Power-off (Front Panel)

CHAPTER 4

External I/O Connections

This chapter provides information about external I/O connections.

Connector Layout

FIGURE 4-1 shows the locations of the Netra t 1120/1125 system back panel connectors.

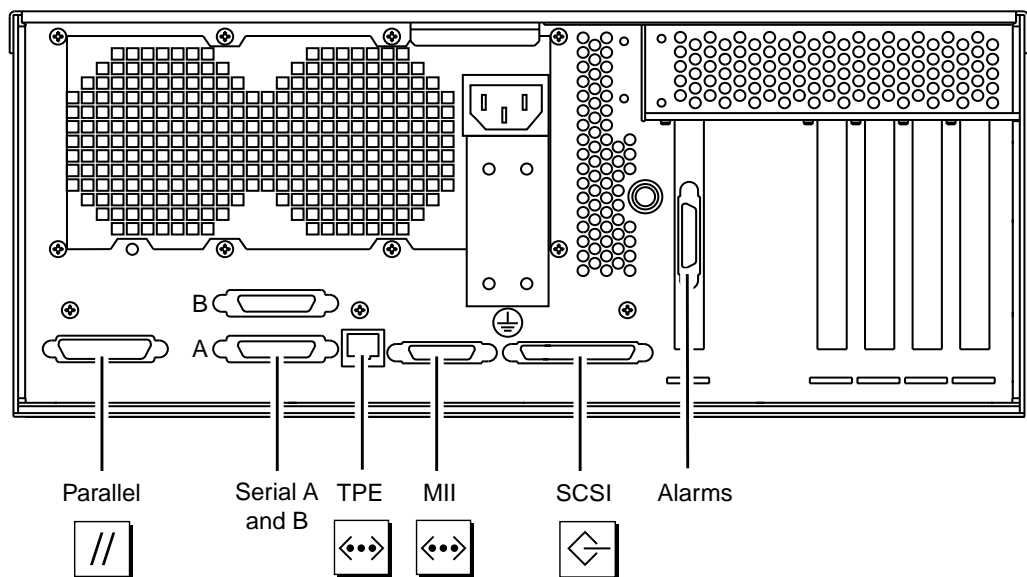

FIGURE 4-1 Back Panel Connectors

Serial Connectors

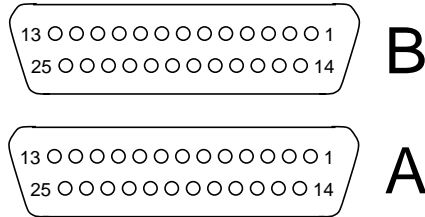

FIGURE 4-2 DB-25 Serial Connectors

TABLE 4-1 Serial Connector Pinouts, RS423/RS232

Pin	Function	I/O	Signal Description
1	none	none	Not connected
2	TxD	O	Transmit Data
3	RxD	I	Receive Data
4	RTS	O	Ready To Send
5	CTS	I	Clear To Send
6	DSR	I	Data Set Ready
7	Gnd		Signal Ground
8	DCD	I	Data Carrier Detect
9-14	none	none	Not connected
15	TRxC	I	Transmit Clock
16	none	none	Not connected
17	RTxC	I	Receive Clock
18-19	none	none	Not connected
20	DTR	O	Data Terminal Ready
21-23	none	none	Not connected
24	TxC	O	Transmit Clock
25	none	none	Not connected

Note: For information about serial port jumpers on the Netra t 1120/1125 system main logic board, see the Netra t 1120/1125 *System Reference Manual*.

Media Independent Interface (MII) Connector

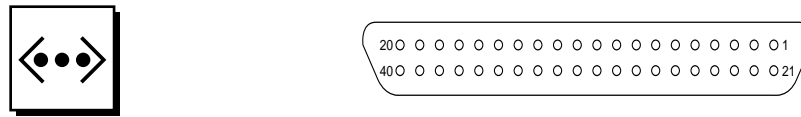

FIGURE 4-3 40-Pin Miniature-D MII Connector

TABLE 4-2 Connector Pinouts

Pin	Function	Pin	Function
1	+5V	18	COL
2	MDIO	19	CRS
3	MDC	20	+5V
4	RXD<3>	21	+5V
5	RXD<2>	22	Signal Ground
6	RXD<1>	23	Signal Ground
7	RXD<0>	24	Signal Ground
8	RX_DV	25	Signal Ground
9	RX_CLK	26	Signal Ground
10	RX_ER	27	Signal Ground
11	TX_ER	28	Signal Ground
12	TX_CLK	29	Signal Ground
13	TX_EN	30	Signal Ground
14	TXD<0>	31	Signal Ground
15	TXD<1>	32	Signal Ground
16	TXD<2>	33	Signal Ground
17	TXD<3>	34	Signal Ground

TABLE 4-2 Connector Pinouts (*Continued*)

Pin	Function	Pin	Function
35	Ground	38	Signal Ground
36	Ground	39	Signal Ground
37	Ground	40	+5V

Cable-Type Connectivity

The following types of Ethernet cable can be connected to the 40-pin MII connector:

- Fiber (connected to an external transceiver)
- Shielded twisted-pair (STP).

External Cable Length

TABLE 4-3 MII External Cable Lengths

Cable Type	Application(s)	Max Length (Metric)	Max Length (Imperial)
40-conductor (20 signal-ground twisted-pair) shielded (STP)	All external MII	0.5m	20in
Shielded twisted-pair category 5 (STP-5, "data grade")	10BASE-T	1000m	3282ft
Shielded twisted-pair category 5 (STP-5, "data grade")	100BASE-T	100m	327ft

Twisted-Pair Ethernet (TPE) Connector



FIGURE 4-4 RJ45 TPE Socket

TABLE 4-4 TPE Connector Pinouts

Pin	Description	Pin	Description
1	Transmit Data +	5	Common Mode Termination
2	Transmit Data -	6	Receive Data -
3	Receive Data +	7	Common Mode Termination
4	Common Mode Termination	8	Common Mode Termination

TPE Cable-Type Connectivity

The following types of twisted-pair Ethernet cable can be connected to the 8-pin TPE connector:

- For 10BASE-T applications, shielded twisted-pair (STP) cable:
 - Category 3 (STP-3, “voice grade”)
 - Category 4 (STP-4)
 - Category 5 (STP-5, “data grade”)
- For 100BASE-T applications, shielded twisted-pair category 5 (STP-5, “data grade”) cable.

TABLE 4-5 TPE STP-5 Cable Lengths

Cable Type	Application(s)	Max Length (Metric)	Max Length (Imperial)
Shielded twisted pair category 5 (STP-5, “data grade”)	10BASE-T	1000m	3282ft
Shielded twisted pair category 5 (STP-5, “data grade”)	100BASE-T	100m	327ft

SCSI Connector

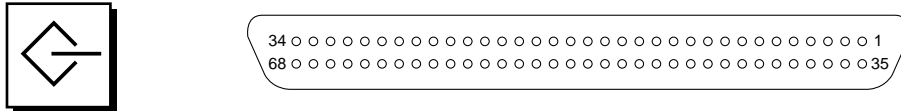

FIGURE 4-5 68-Pin SCSI Connector

TABLE 4-6 68-Pin SCSI Connector Pinouts

Pin	Signal Name	Pin	Signal Name
1	Ground	21	Ground
2	Ground	22	Ground
3	Ground	23	Ground
4	Ground	24	Ground
5	Ground	25	Ground
6	Ground	26	Ground
7	Ground	27	Ground
8	Ground	28	Ground
9	Ground	29	Ground
10	Ground	30	Ground
11	Ground	31	Ground
12	Ground	32	Ground
13	Ground	33	Ground
14	Ground	34	Ground
15	Ground	35	-DB<12>
16	Ground	36	-DB<13>
17	TERMPWR	37	-DB<14>
18	TERMPWR	38	-DB<15>
19	Not connected	39	-PAR<1>
20	Ground	40	-DB<0>

TABLE 4-6 68-Pin SCSI Connector Pinouts (*Continued*)

Pin	Signal Name	Pin	Signal Name
41	-DB<1>	55	-ATN
42	-DB<2>	56	Ground
43	-DB<3>	57	-BSY
44	-DB<4>	58	-ACK
45	-DB<5>	59	-RST
46	-DB<6>	60	-MSG
47	-DB<7>	61	-SEL
48	-PAR<0>	62	-CD
49	Ground	63	-REQ
50	TERM.DIS	64	-IO
51	TERMPWR	65	-DB<8>
52	TERMPWR	66	-DB<9>
53	Reserved	67	-DB<10>
54	Ground	68	-DB<11>

Note – All signals shown in TABLE 4-6 on page 28 are active low.

SCSI Implementation

- SCSI-3 Fast-20 (UltraSCSI) parallel interface
- 16-bit SCSI bus
- 40Mbps data transfer rate
- Support for 16 SCSI addresses:
 - Target 0 to 6 and 8 to F for devices
 - Target 7 reserved for SCSI host adapter on main logic board
- Support for up to four internal SCSI devices (including the host adapter):
 - SCSI disk drive target 0 (lower drive slot)
 - SCSI disk drive target 1 (upper drive slot)
 - SCSI CD-ROM drive target 6 or SCSI tape drive target 5
- Support for external 8-bit and 16-bit SCSI devices via 68-pin SCSI connector.

SCSI Cabling and Configuration

The SCSI-3 Fast-20 (UltraSCSI) specification requires that the external SCSI bus length be limited to 3m (10ft) for less than five devices (internal and external), and 1.5m (5ft) for five to eight devices. When SCSI-3 and SCSI-2 devices are connected to the Netra t 1120/1125 system SCSI bus, the system enables each device to operate at its respective data transfer rate. The last external SCSI device in a daisy-chain must be terminated internally (active termination) or with an external terminator according to Forced-Perfect Termination (FPT) technology.

SCSI Cabling Procedure

1. Count the number of SCSI devices on the system SCSI bus. Be sure to count the host adapter as a SCSI device.
2. Determine the total SCSI bus length.

TABLE 4-7 Determining SCSI Bus Length

SCSI Implementation	Bus Width	Data Transfer Rate, Mb/s	Number of Devices	SCSI Bus Length
SCSI-2, Fast	8 bits	10	1-8	6.0m
SCSI-2, Fast/Wide	16 bits	20	1-8	6.0m
SCSI-3 Parallel Interface, Fast-20 Wide (UltraSCSI) (WideUltra)	16 bits	40	1-4	3.0m
SCSI-3 Parallel Interface, Fast-20 Wide (UltraSCSI) (WideUltra)	16 bits	40	5-8*	1.5m

* The maximum number of single-ended/differential SCSI devices is 16.

3. Verify the cable type used to connect external SCSI devices. You must use Fast-20 SCSI cable(s).

Ensure that the total SCSI cable length does not exceed the permissible total SCSI bus length.

SCSI-2 (Fast Wide SCSI) External Devices

If you connect SCSI-2 (Fast Wide SCSI, 20Mb data transfer rate) external devices to a Netra t 1120/1125 system, follow these cabling and configuration guidelines (as shown in FIGURE 4-6) to ensure proper device addressing and operation:

- If all external mass storage devices use 68-pin connectors, connect all non-Sun devices to the Netra t 1120/1125 system first and follow them with Sun devices. Sun devices use auto-termination.
- If external mass storage devices consist of 68-pin Sun devices and 50-pin devices, connect the Sun 68-pin devices to the Netra t 1120/1125 system first and terminate the daisy chain with the 50-pin device and its terminator.
- The total SCSI bus length for all external SCSI devices is 6.0m (19.7ft).

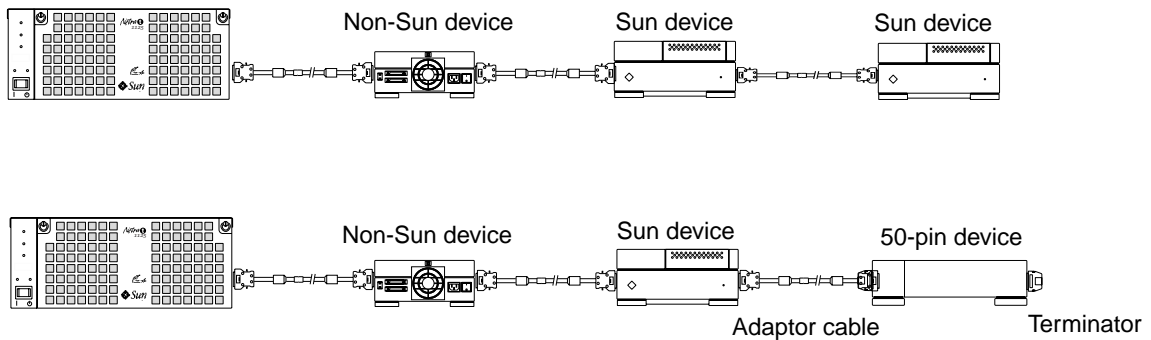

FIGURE 4-6 Connecting External Mass Storage Devices

Alarms Port

The alarms connector is located on the alarms card. This connector is a male DB-15 and TABLE 4-8 lists each connector line assignment.

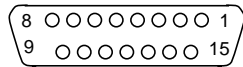

FIGURE 4-7 Alarms Connector Configuration

TABLE 4-8 Alarms Connector Line Assignments

Pin	Signal Name	Pin	Signal Name
1	RESET+	9	ALARM1 COM
2	RESET-	10	ALARM1 NC
3	Not connected	11	ALARM2 NO
4	Not connected	12	ALARM2 COM
5	ALARM3 COM	13	ALARM2 NC
6	ALARM3 NO	14	Not connected
7	ALARM3 NC	15	Not connected
8	ALARM1 NO		

Parallel Interface

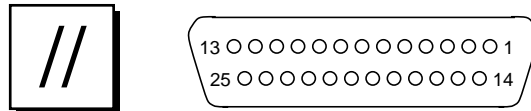
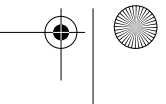
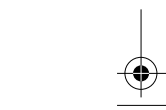
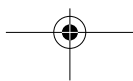
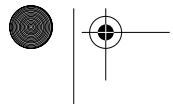
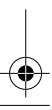
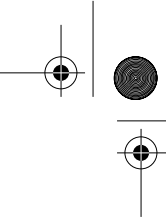
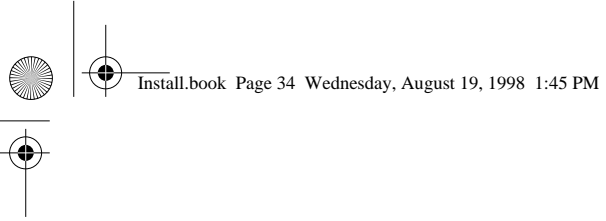

FIGURE 4-8 DB-25 Parallel Connector

TABLE 4-9 Parallel Connector Pinouts

Pin	Description	Pin	Description
1	Data_Strobe_L	14	AFXN_L
2	Data0	15	ERROR_L
3	Data1	16	RESET_L
4	Data2	17	IN_L
5	Data3	18	Ground
6	Data4	19	Ground
7	Data5	20	Ground
8	Data6	21	Ground
9	Data7	22	Ground
10	ACK_L	23	Ground
11	BUSY	24	Ground
12	PERROR	25	Ground
13	SELECT_L		



CHAPTER 5

Installing Netra t 11xx Alarms Software

This chapter describes all the steps necessary to install a Netra t 1120 Alarms software release. The reader should be familiar with the Solaris operating environment.

Note – New systems are shipped pre-installed with JumpStart software. For instructions on how to install the Netra t 11xx Alarm software, see “Installation Procedure” on page 36.

The release software consists of a CD-ROM:

- Netra t 11xx Alarms software (X-Option No. X6905A) containing:
 - Alarms driver
 - Alarms utilities
 - Manual pages `tsalarm(7D)`, `tsctl(1M)`, `tsdog(1M)`, `tsmonitor(1M)`, `tsstate(1M)` and `tsunlock(1M)`.

Local Installation

To perform a local Netra t 11xx installation, it is necessary that the machine be equipped with a CD-ROM drive.

Network Installation

To perform a Netra t 11xx network installation, it is necessary that the server be equipped with a CD-ROM drive.

Installation Procedure

This section describes the steps necessary to install the release software on a Netra t 11xx system:

- Local installation of the Netra t 11xx Alarms software.
- Network installation of the Netra t 11xx Alarms software.

Local Installation

1. **Become root.**
2. **Place the Netra t 11xx release CD-ROM in CD-ROM drive.**
3. **Add the packages to the system:**

```
% pkgadd -d /cdrom/t11xx_rel_1_y all
```

where *xx* indicates a two-digit product code and *y* indicates a minor release number.

4. **Verify that the packages have been installed successfully:**

```
% pkgchk -v SUNWtsa1[m|r|u]
```

Network Installation

1. On the Server, become *root*:
2. Place the Netra t 11xx release CD-ROM in the CD-ROM drive.
3. Create a directory in */export*.

For example:

```
% mkdir /export/t11xx_software
```

where *xx* indicates a two-digit product code.

Note – The directory */export* should be visible to machines on the network.

4. Copy the contents of the Netra t 11xx CD-ROM into the new directory:

For example:

```
% cp -r /cdrom/t11xx_rel_1_y/* /export/t11xx_software
```

where *xx* indicates a two-digit product code and *y* indicates a minor release number.

5. On the client, mount the Netra t 11xx software directory on a suitable directory:

```
% mount -F nfs -o ro <server_name>:/export/t11xx_software /mnt
```

6. Then, add the packages to the system:

```
% pkgadd -d /mnt all
```

7. Verify that the packages have been installed successfully:

```
% pkgchk -v SUNWtsal[m|r|u]
```

Installing SunVTS

Note – You must install the SunVTS software before installing the Netra t 11xx vts files.

1. **Install the SunVTS software according to the instructions given in the *SunVTS 2.1 User's Guide*.**
2. **You will need to be logged in as *root* in order to perform the installation.**
3. **Place the Netra t 11xx release CD-ROM in the CD-ROM drive.**
4. **Change to the `tsvts` directory:**

```
% cd /cdrom/t11xx_rel_1_y/tsvts
```

where *xx* indicates a two-digit product code and *y* indicates a minor release number.

5. **Execute the install script to add additional vts files:**

```
% ./tsvts_install
```

This script will verify correct installation. See *SunVTS 2.1 User's Guide* Revision A Part No. 805-1631-10 for further information.

CHAPTER 6

Replacing the Air Filters

This chapter describes how to replace the air filters.



1120

Regardless of the position of the ON/STBY switch, where a DC power cord remains connected to the system DC voltage is always present within the power supply.

1125

Regardless of the position of the ON/STBY switch, where an AC power cord remains connected to the system potentially dangerous voltages are always present within the power supply
To Replace the Air Filters

To maintain adequate airflow we strongly recommend that you inspect and, if necessary, replace the air filters regularly.

1. **Open the front door of the Netra t 1120/1125 system by turning the catches counter-clockwise through 90°, and hinge the door downwards.**

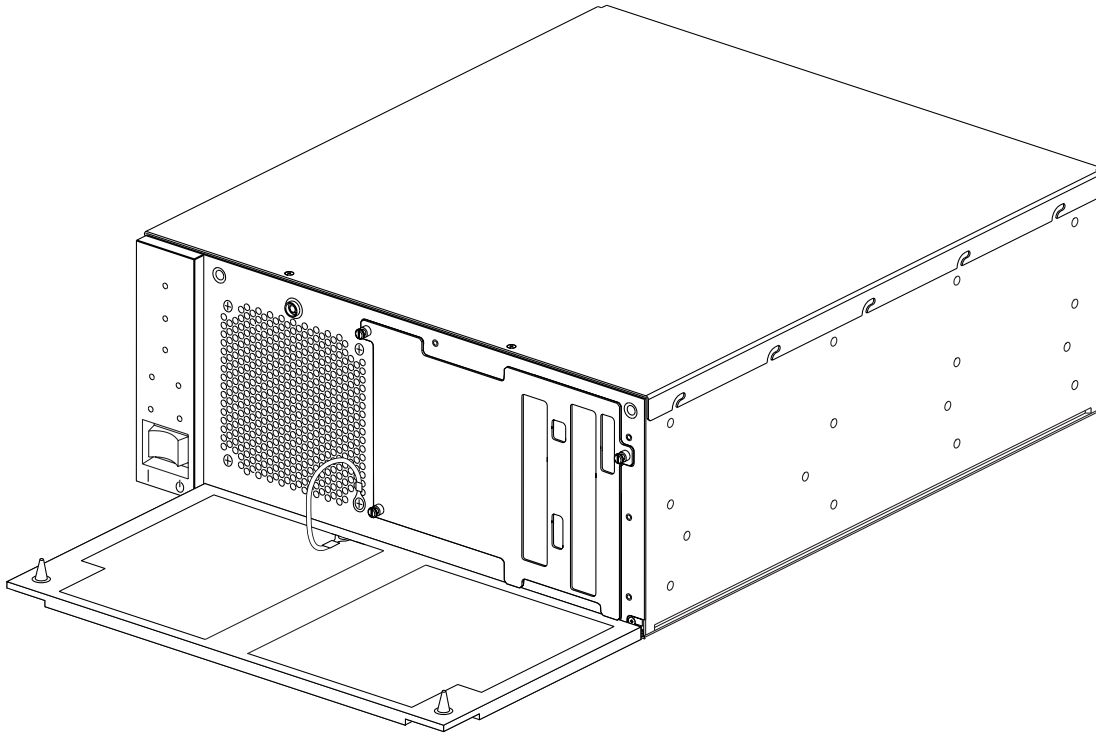

FIGURE 6-1 Replacing the Air Filters

2. **Remove the existing air filters and replace them with the new air filters (Part No. F250-1392). Ensure that the edges of the filters are tucked into the retaining flanges on the front door.**
3. **Close the front door of the system.**

Index

A

- air filter replacement, 39
- airflow requirements, 5, 6
- alarms card
 - connector, 32
- alarms port, 32

B

- back panel layout, 23

C

- cable lengths
 - MII, 26
 - STP-5, 27
- cables
 - external lengths, 26
 - MII, 26
 - SCSI, 30
- connectivity
 - TPE, 27
- connectors
 - alarms card, 32
 - layout, 23
 - MII, 25
 - parallel, 33
 - SCSI, 28
 - serial, 24
 - TPE, 27

- cooling, 5

D

- dimensions, 4
 - 19-inch configuration, 9
 - 23-inch configuration, 10
 - 24-inch configuration, 11
 - IEC917 configuration, 12

E

- electricity supply installation, 13
- elevation, 4
- environment, 4
 - cooling, 5
- Ethernet
 - cable connectivity, 26
 - TPE connectivity, 27
 - TPE connector, 27
- external cable
 - lengths, 27

F

- forced air cooling, 5

G

- grounding connections, 16
- grounding requirements, 15, 19

H

- humidity, 4

I

- installation
 - electricity supply, 13
 - environment, 4
 - local, 36
 - media, 35
 - network, 37
 - release software, 36
 - requirements, 3
 - software, 35
 - SunVTS, 38

M

- Media Independent Interface, *See* MII
- media, installation, 35
- MII
 - connector, 25
- mounting flanges, 7

O

- ON/STBY switch, 13
- overcurrent protection, 14

P

- parallel port
 - connector, 33
 - pin configuration, 33
- pinouts
 - alarms card connector, 32
 - MII connector, 25
 - parallel connector, 33

- SCSI connector, 28
- serial connector, 24
- TPE connector, 27

power

- AC source requirements, 19
- AC supply and ground, 19
- connectors, 13
- DC source requirements, 14
- DC supply and ground, 15
- power switch, 13
- power-off, 22
- power-on, 21

S

- SCSI
 - cabling, 30
 - cabling procedure, 30
 - configuration, 30
 - connector, 28
 - implementation, 29
 - SCSI-2 devices, 31
- serial port
 - connectors, 24
- shipping plates, 8
- software
 - installation, 35
 - release, 1
- system
 - back panel, 23
 - installation, 3
 - power off, 22
 - power on, 21

T

- temperature, 4
- TPE connector, 27
- Twisted-Pair Ethernet, *See* TPE