



Sun Ray™ 100 Enterprise Appliance User's Guide

Sun Microsystems, Inc.
901 San Antonio Road
Palo Alto, CA 94303
U.S.A. 650-960-1300

Part No. 806-5237-10
June 2000, [Revision A](#)

[Send comments about this document to: docfeedback@sun.com](mailto:docfeedback@sun.com)

Copyright 2000 Sun Microsystems, Inc., 901 San Antonio Road • Palo Alto, CA 94303-4900 USA. All rights reserved.

This product or document is protected by copyright and distributed under licenses restricting its use, copying, distribution, and decompilation. No part of this product or document may be reproduced in any form by any means without prior written authorization of Sun and its licensors, if any. Third-party software, including font technology, is copyrighted and licensed from Sun suppliers.

Parts of the product may be derived from Berkeley BSD systems, licensed from the University of California. UNIX is a registered trademark in the U.S. and other countries, exclusively licensed through X/Open Company, Ltd. For Netscape Communicator™, the following notice applies: Copyright 1995 Netscape Communications Corporation. All rights reserved.

Sun, Sun Microsystems, the Sun logo, AnswerBook2, docs.sun.com, Solaris, and Sun Ray are trademarks, registered trademarks, or service marks of Sun Microsystems, Inc. in the U.S. and other countries. All SPARC trademarks are used under license and are trademarks or registered trademarks of SPARC International, Inc. in the U.S. and other countries. Products bearing SPARC trademarks are based upon an architecture developed by Sun Microsystems, Inc.

The OPEN LOOK and Sun™ Graphical User Interface was developed by Sun Microsystems, Inc. for its users and licensees. Sun acknowledges the pioneering efforts of Xerox in researching and developing the concept of visual or graphical user interfaces for the computer industry. Sun holds a non-exclusive license from Xerox to the Xerox Graphical User Interface, which license also covers Sun's licensees who implement OPEN LOOK GUIs and otherwise comply with Sun's written license agreements.



As an Energy Star® Partner, Sun Microsystems, Inc. has determined that this product meets the Energy Star® guidelines for energy efficiency.

RESTRICTED RIGHTS: Use, duplication, or disclosure by the U.S. Government is subject to restrictions of FAR 52.227-14(g)(2)(6/87) and FAR 52.227-19(6/87), or DFAR 252.227-7015(b)(6/95) and DFAR 227.7202-3(a).

DOCUMENTATION IS PROVIDED "AS IS" AND ALL EXPRESS OR IMPLIED CONDITIONS, REPRESENTATIONS AND WARRANTIES, INCLUDING ANY IMPLIED WARRANTY OF MERCHANTABILITY, FITNESS FOR A PARTICULAR PURPOSE OR NON-INFRINGEMENT, ARE DISCLAIMED, EXCEPT TO THE EXTENT THAT SUCH DISCLAIMERS ARE HELD TO BE LEGALLY INVALID.



Contents

Safety and Compliance Statements v

Sun Ray 100 Enterprise Appliance User's Guide en-1

Sun Ray 100 Enterprise Appliance User's Guide (French) fr-1

Sun Ray 100 Enterprise Appliance User's Guide (German) de-1

Sun Ray 100 Enterprise Appliance User's Guide (Italian) it-1

Sun Ray 100 Enterprise Appliance User's Guide (Spanish) es-1

Sun Ray 100 Enterprise Appliance User's Guide (Swedish) sv-1

Sun Ray 100 Enterprise Appliance User's Guide (Japanese) ja-1

Sun Ray 100 Enterprise Appliance User's Guide (Korean) ko-1

Sun Ray 100 Enterprise Appliance User's Guide (Simplified Chinese) zh-1

Sun Ray 100 Enterprise Appliance User's Guide (Trad. Chinese) zh_TW-1

Safety Agency Compliance Statements

Read this section before beginning any procedure. The following text provides safety precautions to follow when installing a Sun Microsystems product.

Safety Precautions

For your protection, observe the following safety precautions when setting up your equipment:

- Follow all cautions and instructions marked on the equipment.
- Ensure that the voltage and frequency of your power source match the voltage and frequency inscribed on the equipment's electrical rating label.
- Never push objects of any kind through openings in the equipment. Dangerous voltages may be present. Conductive foreign objects could produce a short circuit that could cause fire, electric shock, or damage to your equipment.

Symbols

The following symbols may appear in this book:



Caution – There is risk of personal injury and equipment damage. Follow the instructions.



Caution – Hazardous voltages are present. To reduce the risk of electric shock and danger to personal health, follow the instructions.

Modifications to Equipment

Do not make mechanical or electrical modifications to the equipment. Sun Microsystems is not responsible for regulatory compliance of a modified Sun product.



Caution – Do not operate Sun products without the top cover in place. Failure to take this precaution may result in personal injury and system damage.

Placement of a Sun Product



Caution – Do not block or cover the openings of your Sun product. Never place a Sun product near a radiator or heat register. Failure to follow these guidelines can cause overheating and affect the reliability of your Sun product.



Caution – The workplace-dependent noise level defined in DIN 45 635 Part 1000 must be 70Db(A) or less.

SELV Compliance

Safety status of I/O connections comply to SELV requirements.

Power Cord Connection



Caution – Sun products are designed to work with single-phase power systems having a grounded neutral conductor. To reduce the risk of electric shock, do not plug Sun products into any other type of power system. Contact your facilities manager or a qualified electrician if you are not sure what type of power is supplied to your building.



Caution – Not all power cords have the same current ratings. Household extension cords do not have overload protection and are not meant for use with computer systems. Do not use household extension cords with your Sun product.



Caution – Your Sun product is shipped with a grounding type (three-wire) power cord. To reduce the risk of electric shock, always plug the cord into a grounded power outlet.

Declaration of Conformity

Compliance ID: Model 103

Product Name: Sun Ray 100

This product has been tested and complies with the following rules and requirements.

EMC

USA—FCC Class B

This device complies with Part 15 of the FCC Rules. Operation is subject to the following two conditions:

1. This device may not cause harmful interference.
2. This device must accept any interference received, including interference that may cause undesired operation.

European Union—EC

This equipment complies with the following requirements of the EMC Directive 89/336/EEC:

EN55022/CISPR22 (1985)	Class B
EN55024/CISPR24 (1997)	Pass

Safety

This equipment complies with the following requirements of the Low Voltage Directive 73/23/EEC:

EC Type Examination Certificates:

EN60950/IEC950 (1993)
EN60950 w/Worldwide CB
Scheme Deviations

Supplementary Information

This product was tested and complies with all the requirements for the CE Mark (when connected to a Sun workstation or server).

/S/

Dennis P. Symanski DATE
Manager, Product Compliance

Sun Microsystems, Inc.
901 San Antonio Road, M/S UMPK15-102
Palo Alto, CA 94303, USA

Tel: 650-786-3255
Fax: 650-786-3723

/S/

John Shades DATE
Quality Assurance Manager

Sun Microsystems Scotland, Limited
Springfield, Linlithgow
West Lothian, EH49 7LR
Scotland, United Kingdom

Tel: 0506-670000
Fax: 0506 760011

Regulatory Compliance Statements

Your Sun product is marked to indicate its compliance class:

- Federal Communications Commission (FCC) — USA
- Industry Canada Equipment Standard for Digital Equipment (ICES-003) - Canada
- Voluntary Control Council for Interference (VCCI) — Japan
- Bureau of Standards Metrology and Inspection (BSMI) — Taiwan

Please read the appropriate section that corresponds to the marking on your Sun product before attempting to install the product.

FCC Class B Notice

This device complies with FCC CFR Title 47 Part 2 and Part 15, Subpart B, Class B of the FCC Rules. Operation is subject to the following two conditions:

1. This device may not cause harmful interference.
2. This device must accept any interference received, including interference that may cause undesired operation.

Note: This equipment has been tested and found to comply with the limits for a Class B digital device, pursuant to Part 15 of the FCC Rules. These limits are designed to provide reasonable protection against harmful interference in a residential installation. This equipment generates, uses and can radiate radio frequency energy and, if not installed and used in accordance with the instructions, may cause harmful interference to radio communications. However, there is no guarantee that interference will not occur in a particular installation. If this equipment does cause harmful interference to radio or television reception, which can be determined by turning the equipment off and on, the user is encouraged to try to correct the interference by one or more of the following measures:

- Reorient or relocate the receiving antenna.
- Increase the separation between the equipment and receiver.
- Connect the equipment into an outlet on a circuit different from that to which the receiver is connected.
- Consult the dealer or an experienced radio/television technician for help.

Shielded Cables: Connections between the unit and peripherals must be made using shielded cables in order to maintain compliance with FCC radio frequency emission limits. Networking connections can be made using unshielded twisted pair (UTP) cables.

Modifications: Any modifications made to this device that are not approved by Sun Microsystems, Inc. may void the authority granted to the user by the FCC to operate this equipment.

ICES-003 Class B Notice - Avis NMB-003, Classe B

This Class B digital apparatus complies with Canadian ICES-003.

Cet appareil numérique de la classe B est conforme à la norme NMB-003 du Canada.

クラス B VCCI 基準について

クラス B VCCI の表示  があるワークステーションおよびオプション製品は、クラス B 情報技術装置です。これらの製品には、下記の項目が該当します。

この装置は、情報処理装置等電波障害自主規制協議会 (VCCI) の基準に基づくクラス B 情報技術装置です。この装置は、家庭環境で使用することを目的としていますが、この装置がラジオやテレビジョン受信機に近接して使用されると、受信障害を引き起こすことがあります。取扱説明書に従って正しい取り扱いをしてください。

BSMI Class B Notice

This device complies with Taiwanese BSMI Class B specifications. Under BSMI rules, no special conditions apply to the operation of a Class B device.

Sun Ray 100 Enterprise Appliance User's Guide

This guide provides the following information to help you get started with your new Sun Ray™ 100 enterprise appliance:

- “Overview and Setup” on page en-1
- “Troubleshooting” on page en-6
- “Adjusting the Session or Display” on page en-10
- “Display Modes” on page en-14
- “Maintaining the Appliance” on page en-14
- “Specifications” on page en-15

Overview and Setup

Package Contents

Please make sure the following items are included in the packing carton. If any items are missing, contact your dealer.

- Sun Ray 100 enterprise appliance
- Ethernet cable
- This manual
- Optional accessory kit, including:
 - Power cord
 - Keyboard and palm rest
 - Mouse
 - Mousepad
 - Keyboard/mouse operation guide
 - Ergonomics guide

Front Panel Components

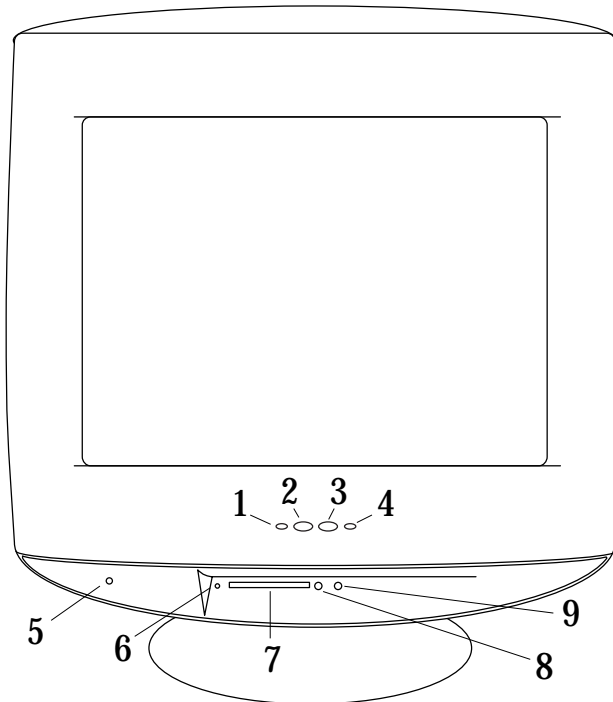

FIGURE 1 Front Panel of the Sun Ray 100 Enterprise Appliance

1. Menu button—Opens the Display Menu.
2. Brightness/Previous button—Can be used to adjust Brightness, or to move to the previous selection in the Display Menu.
3. Contrast/Next button—Can be used to adjust Contrast, or to move to the next selection in the Display Menu.
4. Access Function button—Accesses functions and submenus in the Display Menu.
5. Power LED—Illuminates when the appliance is powered on.
6. Smart card LED—Illuminates when a smart card is inserted.
7. Smart card reader—Accepts a valid smart card.
8. Headphone output—Designed to work with low impedance stereo headphones.
9. Microphone input—Adjust microphone volume through software (see page en-10).

Back Panel Components

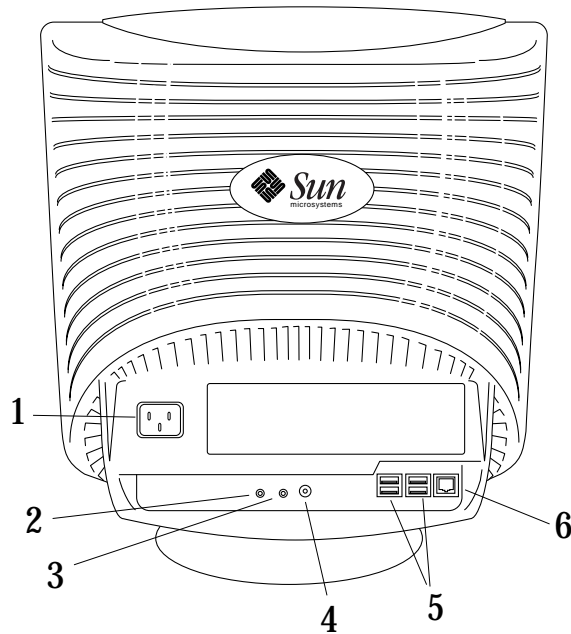

FIGURE 2 Back Panel of the Sun Ray 100 Enterprise Appliance

1. Power in—Connect the power cord to this receptacle.
2. Stereo audio signal line-in 1/8 inch (3.5 mm) stereo mini-plug—Input from an audio input device.
3. Stereo audio signal line-out 1/8 inch (3.5 mm) stereo mini-plug—Output to an audio device.
4. Video in—Input for a device that provides a composite video signal.
5. USB ports 1, 2, 3, and 4—Standard USB ports for peripherals.
6. Network connector—100BASE-T Ethernet cable receptacle (RJ-45).

Setting Up the Appliance

After carefully removing the Sun Ray 100 enterprise appliance from the packing carton, set it up using the following procedures.

Note – Your appliance operates by communicating over the network with a server on which the Sun Ray administration software has been installed. If the appliance does not operate correctly after the following procedure, check with your system administrator to make sure the Sun Ray enterprise server has been set up.

To Set Up the Appliance

1. **Connect the power cord to the power port on the back of the appliance.**
2. **Connect the keyboard and mouse to any of the USB ports.**
3. **Connect the Ethernet cable to the Ethernet port.**
4. **Plug the power cord into a nearby outlet.**

If the appliance displays an image, installation is complete.

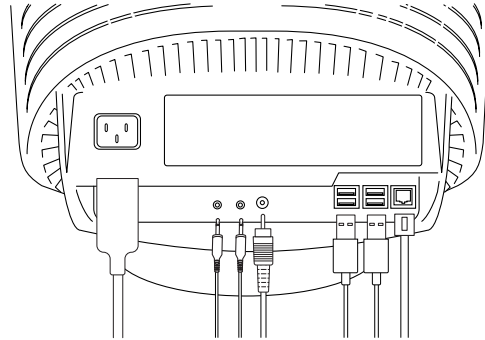

FIGURE 3 Back Panel Cabling of the Sun Ray 100 Enterprise Appliance (optional cables in middle grouping are shown for reference)

To Insert a Smart Card

- Insert the smart card with the square circuit facing down and oriented toward the card slot.

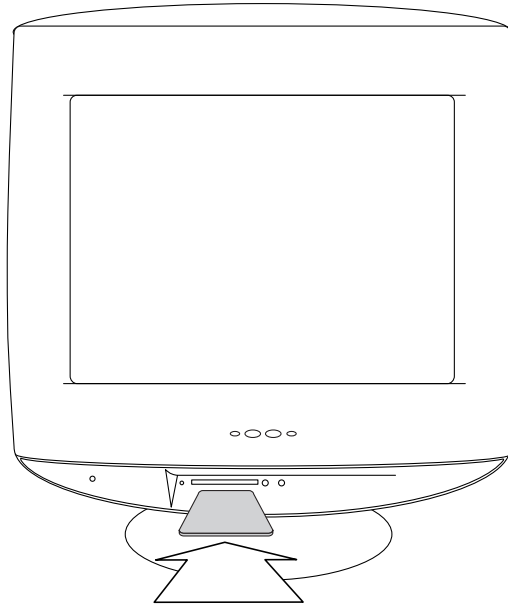

FIGURE 4 Inserting a Smart Card in the Sun Ray 100 Enterprise Appliance

Troubleshooting







Before calling for service, check the information in this section to see if you can solve the problem yourself. If you do need assistance, please contact Sun technical support.



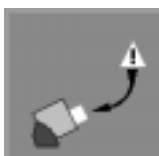

TABLE 1 Troubleshooting Tips

Problem	Solution
There is no picture.	<ul style="list-style-type: none">• Check to see that the appliance is plugged in.• The appliance may be in PowerSaver mode. Move the mouse to activate the display.
The picture is too light or too dark.	Adjust the brightness or contrast settings. See page en-12.
The picture is too small or too large, causing some icons to disappear from view.	<ul style="list-style-type: none">• Adjust the size settings. See H-size and V-Size on page en-12.• The Sun Ray enterprise server may be using a display mode that is not optimal for the Sun Ray 100 appliance. Open the Sun Ray Settings window by pressing Shift+Props on your keyboard or by typing <code>/opt/SUNWut/bin/utsettings</code> in a terminal window. Select the Display category, then select the desired setting. See “Display Modes” on page en-14 for available display modes. (Note: To change the display mode for all appliances, ask your system administrator to use the <code>utxconfig</code> command, which is fully described in the Sun Ray system administration documentation.)
The colors are distorted with dark or shadowed areas.	<ul style="list-style-type: none">• Activate the Degauss feature. See page en-13.• Adjust the color temperature. See page en-12.
There is no response from the keyboard or mouse.	<ul style="list-style-type: none">• Disconnect the keyboard or mouse, wait 15 seconds, then reconnect.• Disconnect the power cord, wait 15 seconds, then reconnect.
The power indicator is yellow for more than 3 seconds.	A hardware fault has occurred. Contact your system administrator for a replacement unit. See “LED Indicators” on page en-9 for more information.
The power indicator is blinking green.	The unit is inoperable. Contact your system administrator to correct the problem. See “LED Indicators” on page en-9 for more information.

Status Icons

The icons below indicate the boot status of the appliance.

Icon	What it means	Action to take
	The unit is starting up.	Wait. If the unit does not start within a short time, contact your system administrator.
	The server is currently downloading to the unit's PROM.	Wait. The unit will restart when downloading is complete.
	A unit failure has occurred. The unit tried to download from the server to the PROM, but failed.	Contact your system administrator.
	The unit does not detect an Ethernet signal. The unit's Ethernet address is displayed.	Check that the Ethernet cable is correctly plugged into the back of the unit and into the correct network outlet. If the problem persists, contact your system administrator.
	The unit cannot communicate with the server software.	Contact your system administrator.
	The sound has been muted.	Press the Mute key again or use the Settings screen (page en-10) to unmute the sound.

Icon	What it means	Action to take
	The volume has been changed.	Press either of the volume keys or use the Settings screen (page en-10) to adjust the volume.
	The unit's Ethernet address is displayed when the three audio volume control keys are pressed simultaneously or the Ethernet cable is initially plugged in.	The address disappears after 15 seconds.
	Prompt for smart card insertion.	Insert smart card.
	Unit cannot read smart card.	Insert smart card properly. Clean contacts on smart card and reinsert. Contact your system administrator.
	You are denied access.	Contact your system administrator.

LED Indicators

The Sun Ray 100 enterprise appliance has two LED indicators (Power/Fault and Smart Card), whose states are shown in the table below.

LED	State	What it means
Power/Fault	Off	The unit is not plugged in.
	Yellow	The LED briefly lights for 2-3 seconds at power on while the unit checks the hardware. If this LED stays on, or lights at any other time, a hardware fault has occurred. Contact your system administrator for a replacement unit.
	Green	The unit is powered on and the hardware is functioning normally.
	Blinking	The unit is inoperable. Contact your system administrator to correct the problem.
Smart Card	Off	No smart card is inserted.
	On	The smart card has been inserted correctly.
	Blinking	It is safe to enter your secure PIN now (secure smart card installations only).

PowerSaver

The Sun Ray 100 enterprise appliance has a built-in power management system called PowerSaver. This system saves energy by switching the appliance into a low-power mode when it has not been used for a certain amount of time. The table below shows the characteristics of normal and PowerSaver modes. To return the appliance to normal mode, move the mouse or press a key on the keyboard.

TABLE 2 Power States of the Sun Ray 100 Enterprise Appliance

State	Display	Power Indicator	Approximate Power Consumption
Normal operation	Active	Green	95W typical (120W maximum)
PowerSaver	Blanked	Green	29W

Adjusting the Session or Display

The Sun Ray 100 enterprise appliance has two on-screen controls that enable you to adjust the features on your desktop:

- The Settings screen enables you to adjust features of the Sun Ray session.
- The Display Menu enables you to adjust characteristics of the screen image.

Adjusting Session Attributes

The Settings screen enables you to control the following features of your Sun Ray session:

- Audio input and output
- Mouse speed
- Display resolution and frequency
- Video input

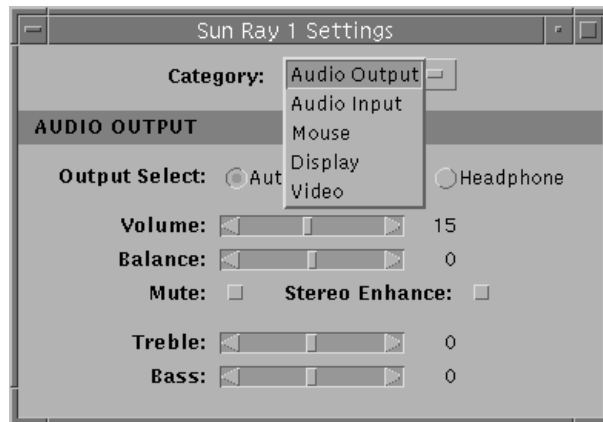

FIGURE 5 Sun Ray 100 Enterprise Appliance Settings Screen

To Use the Settings Screen

1. **Open the Settings screen using one of the following methods:**
 - Press Shift+Props on the keyboard.

- Open a terminal window and type:

```
% /opt/SUNWut/bin/utsettings
```

2. Select the category, then the setting you want.

Contact your system administrator if you have questions.

Adjusting the Display

The Display Menu, accessed by the buttons on the front of the appliance, enables you to adjust characteristics of the screen image. Display changes are indicated by on-screen adjustment icons. Some functions have submenus.

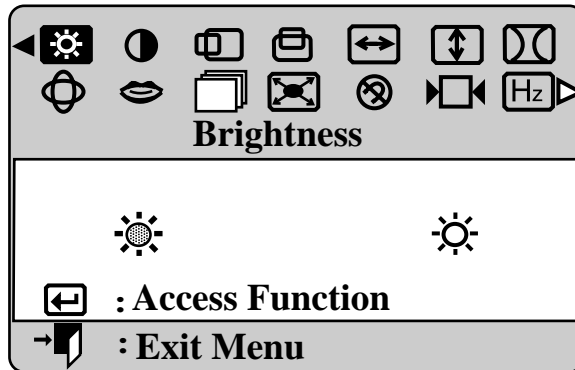

FIGURE 6 Sun Ray 100 Enterprise Appliance Display Menu

To Access the Display Menu

1. With the menu off, push the Menu button to open the menu system and display the main function menu.
2. Push the Next button to move to the next icon or push the Previous button to move back to the previous icon. As you move from one icon to another, the function name changes to reflect the function or group of functions represented by that icon. See the table below to view a complete list of all the functions offered by this appliance.
3. Push the Access Function button once to select the adjustment function, then use the Next and Previous buttons to make your changes. On-screen calibration numbers show the effect of your adjustment.

4. Push the Menu button once to return to the main menu to select another function, or push the Menu button two or three times to exit from the Display Menu.

TABLE 3 Display Menu Functions















Icon	Description	Functions
	Brightness—Background brightness of screen.	- Decreases brightness + Increases brightness
	Contrast—Contrast of screen image.	- Decreases contrast + Increases contrast
	Horizontal Position—Horizontal screen position.	- Moves screen left + Moves screen right
	Vertical Position—Vertical screen position.	- Moves screen down + Moves screen up
	Horizontal Size—Horizontal screen size.	- Decreases size + Increases size
	Vertical Size—Vertical screen size.	- Decreases size + Increases size
	Pincushion—Straightens screen vertical edges.	- Curves image inward + Curves image outward
	Display Timing—Controls the frequency of display updates.	- Factory timing + User timing Note: To change the display mode, use the Settings screen described on page en-10.
	Advanced	
	<ul style="list-style-type: none"> • Color Temperature—Adjusts on-screen color temperature. 	- 9300k more blue + 6500k more red
	<ul style="list-style-type: none"> • Language—Selects the language to be used in the Display Menu. 	- and + scroll through on-screen language options: <ul style="list-style-type: none"> • English • Deutsch • Francais • Italiano • Português • Español • Svenska • Russian • Korean
	<ul style="list-style-type: none"> • Halftone—Activates halftone color in the Display Menu. 	- Off + On

TABLE 3 Display Menu Functions *(Continued)*

Icon	Description	Functions
	<p>Moiré</p> <ul style="list-style-type: none"> • H- Moiré—Corrects for on-screen moiré pattern. • V- Moiré—Corrects for on-screen moiré pattern. 	<ul style="list-style-type: none"> - and + clear Horizontal Moiré - and + clear Vertical Moiré
	<p>Degauss—Removes color distortion caused by magnetic fields.</p>	<ul style="list-style-type: none"> - and + remove color distortion Do not use more than once in 30 minutes.
	<p>Recall—Returns appliance to original settings.</p>	<ul style="list-style-type: none"> - No + Yes
	<p>Geometry</p> <ul style="list-style-type: none"> • Parallelogram • Rotation • Pinbalance • V-Linearity 	<ul style="list-style-type: none"> - Skews screen image left + Skews screen image right - Rotates entire screen left + Rotates entire screen right - Curves vertical lines to left + Curves vertical lines to right - Compresses image at top of screen + Compresses image at bottom of screen
	<p>Trapezoid—Width of top and bottom of screen.</p>	<ul style="list-style-type: none"> - Widens bottom of screen + Widens top of screen

Display Modes

The following display modes are supported by the Sun Ray 100 enterprise appliance. To adjust the display mode, use the Settings screen described on page en-10.

Note – For most applications, the optimum display mode is 1024 x 768 at 85Hz.

TABLE 4 Display Modes

Display Mode	Vertical Frequency (Hz)
800x600	85.000
1024x768	85.000
1152x900	76.150
1280x1024	76.000

Maintaining the Appliance



Caution – To avoid risk of electric shock, do not disassemble the cabinet. The unit is designed not to be user-serviceable. User maintenance is restricted to cleaning as explained below.

To Clean the Appliance

1. **Unplug the appliance from the power outlet before cleaning.**
2. **To clean the display screen, lightly dampen a soft, clean cloth with water or mild detergent. If possible, use a special screen cleaning tissue or solution suitable for the antistatic coating.**
3. **To clean the cabinet, use a cloth lightly dampened with a mild detergent.**



Caution – Never use flammable cleaning material to clean your Sun Ray 100 enterprise appliance or any other electrical apparatus.

Specifications

The table below lists the specifications of the Sun Ray 100 enterprise appliance.

TABLE 5 Specifications

Item	Description
Display	<ul style="list-style-type: none">• 17" (43cm) full square picture tube• 16" (40.6cm) viewable• 0.26mm dot pitch• 1280x1024 maximum resolution• Unlimited colors• Silica-coated with antistatic properties (TCO: multilayer coating)• Medium-short persistence phosphor
Weight	System—17kg maximum With carton—20kg maximum
Power consumption	120W maximum (95W typical, 30W in Power Saver mode)
Electrical ratings	~100-240V, 47-63Hz, 1.8A
Environmental considerations	Operating environment <ul style="list-style-type: none">• Temperature— -5C to 40C (41F to 104F)• Humidity—5% to 93%RH• Altitude—0m to 3.2km (0ft to 10,500ft) Storage environment <ul style="list-style-type: none">• Temperature— -20C to 6C (-4F to 140F)• Humidity—5% to 93%RH• Altitude—0m to 12.5km (0ft to 41,000ft)
Acoustic noise	3.0B Declared Sound Power per ISO 9296-1988

Sun Ray 100 Enterprise Appliance User's Guide (French)

Sun Ray 100 Enterprise Appliance User's Guide (German)



Sun Ray 100 Enterprise Appliance User's Guide (Italian)

Sun Ray 100 Enterprise Appliance User's Guide (Spanish)

Sun Ray 100 Enterprise Appliance User's Guide (Swedish)

Sun Ray 100 Enterprise Appliance User's Guide (Japanese)

Sun Ray 100 Enterprise Appliance User's Guide (Korean)

Sun Ray 100 Enterprise Appliance User's Guide (Simplified Chinese)

Sun Ray 100 Enterprise Appliance User's Guide (Traditional Chinese)

Copyright 2000 Sun Microsystems, Inc., 901 San Antonio Road • Palo Alto, CA 94303-4900 Etats-Unis. Tous droits réservés.

Ce produit ou document est protégé par un copyright et distribué avec des licences qui en restreignent l'utilisation, la copie, la distribution, et la décompilation. Aucune partie de ce produit ou document ne peut être reproduite sous aucune forme, par quelque moyen que ce soit, sans l'autorisation préalable et écrite de Sun et de ses bailleurs de licence, s'il y en a. Le logiciel détenu par des tiers, et qui comprend la technologie relative aux polices de caractères, est protégé par un copyright et licencié par des fournisseurs de Sun.

Des parties de ce produit pourront être dérivées des systèmes Berkeley BSD licenciés par l'Université de Californie. UNIX est une marque déposée aux Etats-Unis et dans d'autres pays et licenciée exclusivement par X/Open Company, Ltd. La notice suivante est applicable à Netscape Communicator™: Copyright 1995 Netscape Communications Corporation. Tous droits réservés.

Sun, Sun Microsystems, the Sun logo, AnswerBook2, docs.sun.com, Solaris, et Sun Ray sont des marques de fabrique ou des marques déposées, ou marques de service, de Sun Microsystems, Inc. aux Etats-Unis et dans d'autres pays. Toutes les marques SPARC sont utilisées sous licence et sont des marques de fabrique ou des marques déposées de SPARC International, Inc. aux Etats-Unis et dans d'autres pays. Les produits portant les marques SPARC sont basés sur une architecture développée par Sun Microsystems, Inc.

L'interface d'utilisation graphique OPEN LOOK et Sun™ a été développée par Sun Microsystems, Inc. pour ses utilisateurs et licenciés. Sun reconnaît les efforts de pionniers de Xerox pour la recherche et le développement du concept des interfaces d'utilisation visuelle ou graphique pour l'industrie de l'informatique. Sun détient une licence non exclusive de Xerox sur l'interface d'utilisation graphique Xerox, cette licence couvrant également les licenciés de Sun qui mettent en place l'interface d'utilisation graphique OPEN LOOK et qui en outre se conforment aux licences écrites de Sun.

CETTE PUBLICATION EST FOURNIE "EN L'ETAT" ET AUCUNE GARANTIE, EXPRESSE OU IMPLICITE, N'EST ACCORDEE, Y COMPRIS DES GARANTIES CONCERNANT LA VALEUR MARCHANDE, L'APTITUDE DE LA PUBLICATION A REpondre A UNE UTILISATION PARTICULIERE, OU LE FAIT QU'ELLE NE SOIT PAS CONTREFAISANTE DE PRODUIT DE TIERS. CE DENI DE GARANTIE NE S'APPLIQUERAIT PAS, DANS LA MESURE OU IL SERAIT TENU JURIDIQUEMENT NUL ET NON AVENU.

