

Sun StorEdge™ 5310 NAS Gateway System

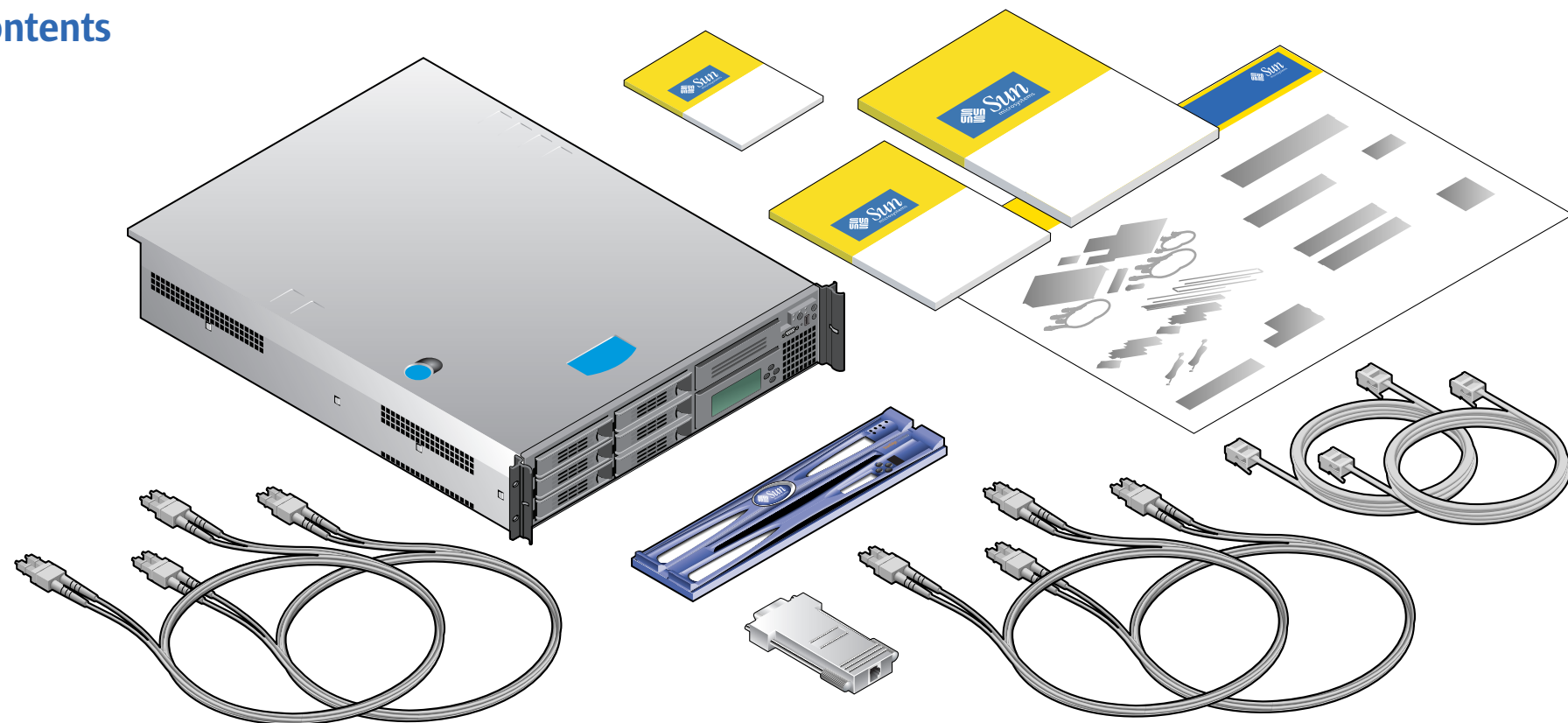

HARDWARE

Contents



Rackmount Kit

(Optional) Part No. XTA-5200-2URK-19U

Supported cabinets:

- Sun StorEdge™ 72-inch Expansion Cabinet (SG-XARY030A)
- Sun Rack 900 (SR9-XKL038A-IP, SR9-XKM038A-IP)
- Sun Rack 1000 (SRK-XRS038A-IP, SRK-XAZ042A-IP)

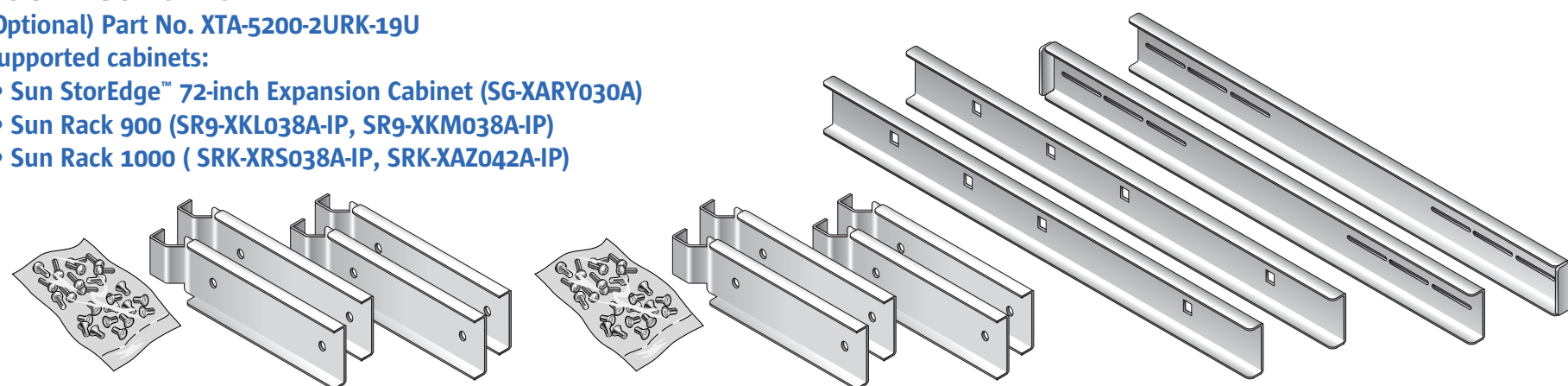

AC Power Cords

(Ordered Separately)

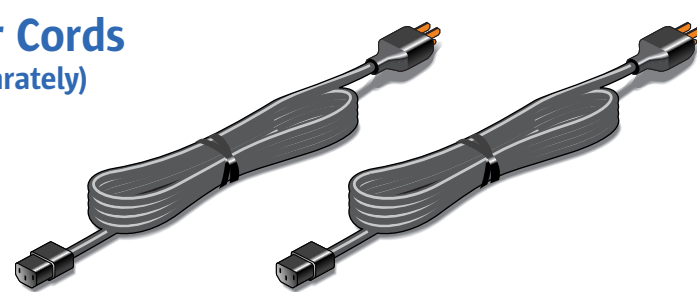

Front Panel Controls

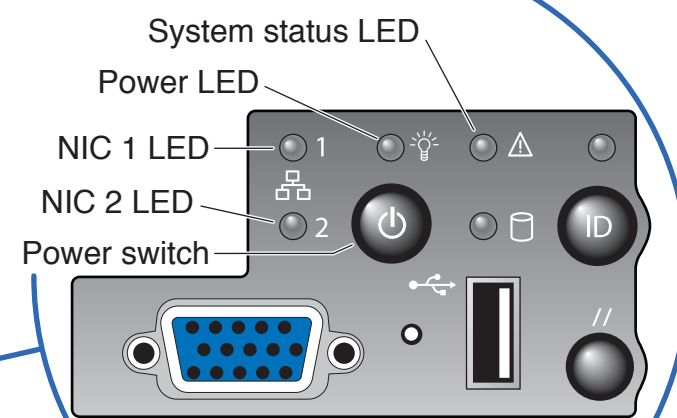
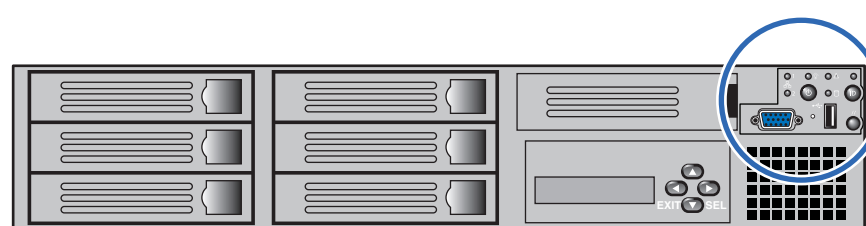

CONFIGURATIONS

Ports

Optional cards

- Single server:
 - Optical gigabit Ethernet
- Dual server:
 - 10/100 BASE-T Heartbeat port
 - Optical gigabit Ethernet

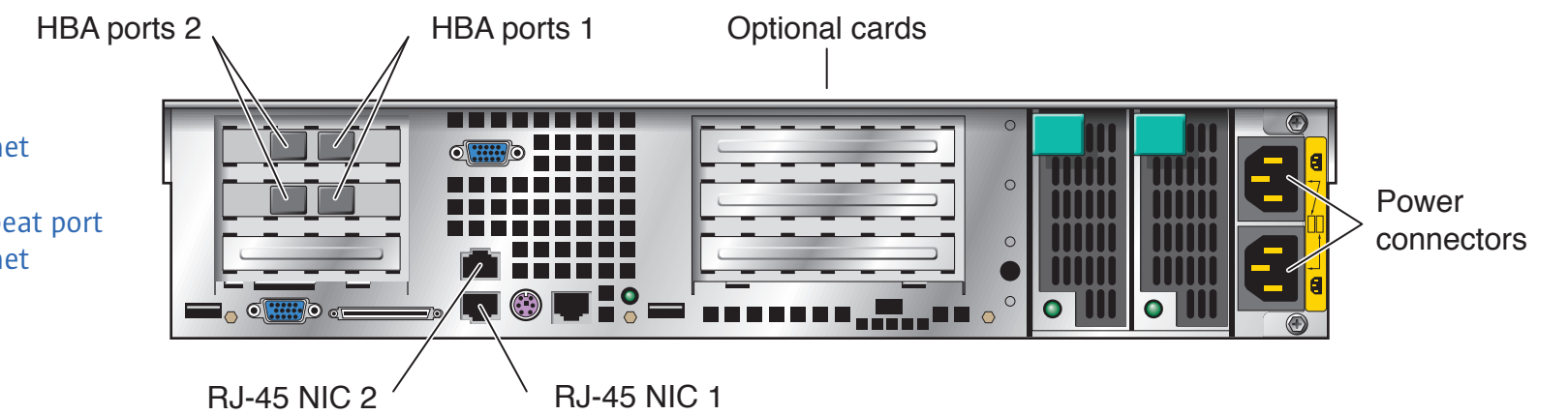

Single Server

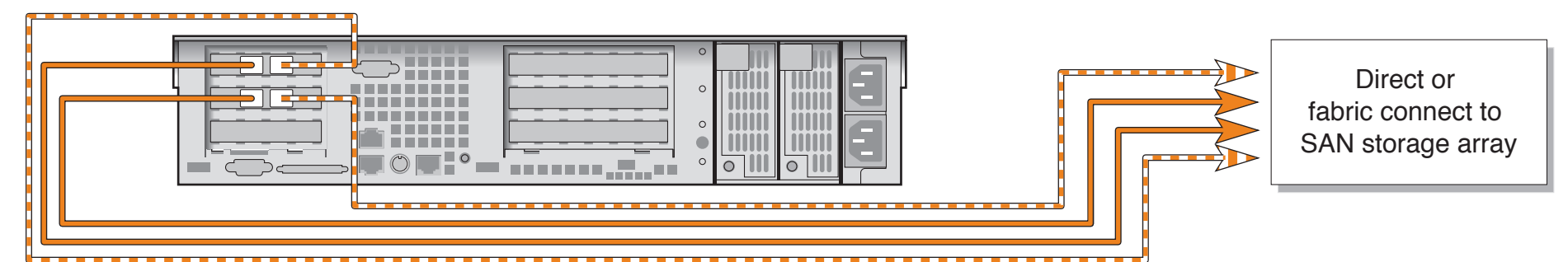

Dual Server

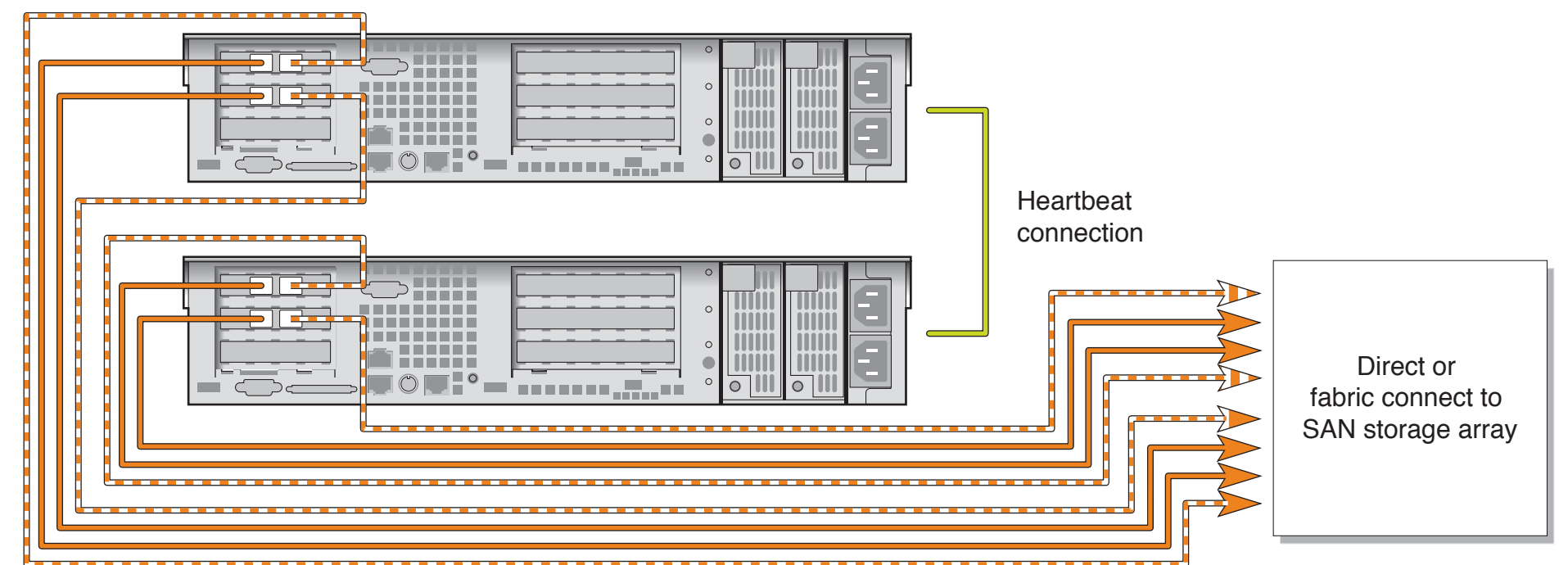

819-3237-10



See the *Sun StorEdge 5310 NAS Getting Started Guide* for detailed cabling diagrams of all supported configurations, network setup instructions, and power-on procedures. Documentation is also available from: http://www.sun.com/hwdocs/Network_Storage_Solutions/nas