

You'll be entered into a quarterly drawing for **free** Cisco Press books by returning this survey! Cisco is dedicated to customer satisfaction and would like to hear your thoughts on these printed manuals. Please visit the Cisco Product Comments on-line survey at [www.cisco.com/go/crc](http://www.cisco.com/go/crc) to submit your comments about accessing Cisco technical manuals. Thank you for your time.

### General Information

- 1 Years of networking experience: \_\_\_\_\_ Years of experience with Cisco products: \_\_\_\_\_
- 2 I have these network types: \_\_\_\_\_ LAN \_\_\_\_\_ Backbone \_\_\_\_\_ WAN  
\_\_\_\_\_ Other: \_\_\_\_\_
- 3 I have these Cisco products: \_\_\_\_\_ Switches \_\_\_\_\_ Routers  
\_\_\_\_\_ Other (specify models): \_\_\_\_\_
- 4 I perform these types of tasks: \_\_\_\_\_ H/W installation and/or maintenance \_\_\_\_\_ S/W configuration  
\_\_\_\_\_ Network management \_\_\_\_\_ Other: \_\_\_\_\_
- 5 I use these types of documentation: \_\_\_\_\_ H/W installation \_\_\_\_\_ H/W configuration \_\_\_\_\_ S/W configuration  
\_\_\_\_\_ Command reference \_\_\_\_\_ Quick reference \_\_\_\_\_ Release notes \_\_\_\_\_ Online help  
\_\_\_\_\_ Other: \_\_\_\_\_
- 6 I access this information through: \_\_\_\_\_ % Cisco.com \_\_\_\_\_ % CD-ROM \_\_\_\_\_ % Printed manuals  
\_\_\_\_\_ % Other: \_\_\_\_\_
- 7 I prefer this access method: \_\_\_\_\_ Cisco.com \_\_\_\_\_ CD-ROM \_\_\_\_\_ Printed manuals  
\_\_\_\_\_ Other: \_\_\_\_\_
- 8 I use the following three product features the most: \_\_\_\_\_  
\_\_\_\_\_  
\_\_\_\_\_

### Document Information

Document Title: Catalyst 3750 Switch Hardware Installation Guide

Part Number: 78-15136-02 S/W Release (if applicable): <Software Release>

On a scale of 1–5 (5 being the best), please let us know how we rate in the following areas:

- \_\_\_\_\_ The document is complete. \_\_\_\_\_ The information is accurate.  
\_\_\_\_\_ The information is well organized. \_\_\_\_\_ The information I wanted was easy to find.  
\_\_\_\_\_ The document is written at my \_\_\_\_\_ The information I found was useful to my job.  
\_\_\_\_\_ technical level of understanding.

Please comment on our lowest scores: \_\_\_\_\_  
\_\_\_\_\_  
\_\_\_\_\_

### Mailing Information

Organization \_\_\_\_\_ Date \_\_\_\_\_

Contact Name \_\_\_\_\_

Mailing Address \_\_\_\_\_

City \_\_\_\_\_ State/Province \_\_\_\_\_ Zip/Postal Code \_\_\_\_\_

Country \_\_\_\_\_ Phone ( ) \_\_\_\_\_ Extension \_\_\_\_\_

E-mail \_\_\_\_\_ Fax ( ) \_\_\_\_\_

May we contact you further concerning our documentation? \_\_\_\_\_ Yes \_\_\_\_\_ No

You can also send us your comments by e-mail to [bug-doc@cisco.com](mailto:bug-doc@cisco.com), or by fax to **408-527-8089**.

When mailing this card from outside of the United States, please enclose in an envelope addressed to the location on the back of this card with the required postage or fax to 1-408-527-8089.

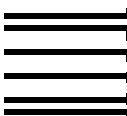

NO POSTAGE  
NECESSARY  
IF MAILED  
IN THE  
UNITED STATES

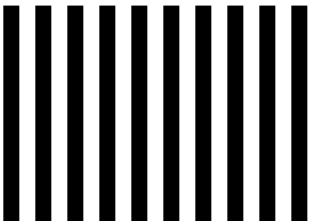

**BUSINESS REPLY MAIL**

FIRST-CLASS MAIL PERMIT NO. 4631 SAN JOSE CA

POSTAGE WILL BE PAID BY ADDRESSEE

DOCUMENT RESOURCE CONNECTION  
CISCO SYSTEMS INC  
170 WEST TASMAN DR  
SAN JOSE CA 95134-9916





# **Catalyst 3750 Switch Hardware Installation Guide**

August 2003

## **Corporate Headquarters**

Cisco Systems, Inc.  
170 West Tasman Drive  
San Jose, CA 95134-1706  
USA  
<http://www.cisco.com>  
Tel: 408 526-4000  
800 553-NETS (6387)  
Fax: 408 526-4100

Customer Order Number: DOC-7815136=  
Text Part Number: 78-15136-02



THE SPECIFICATIONS AND INFORMATION REGARDING THE PRODUCTS IN THIS MANUAL ARE SUBJECT TO CHANGE WITHOUT NOTICE. ALL STATEMENTS, INFORMATION, AND RECOMMENDATIONS IN THIS MANUAL ARE BELIEVED TO BE ACCURATE BUT ARE PRESENTED WITHOUT WARRANTY OF ANY KIND, EXPRESS OR IMPLIED. USERS MUST TAKE FULL RESPONSIBILITY FOR THEIR APPLICATION OF ANY PRODUCTS.

THE SOFTWARE LICENSE AND LIMITED WARRANTY FOR THE ACCOMPANYING PRODUCT ARE SET FORTH IN THE INFORMATION PACKET THAT SHIPPED WITH THE PRODUCT AND ARE INCORPORATED HEREIN BY THIS REFERENCE. IF YOU ARE UNABLE TO LOCATE THE SOFTWARE LICENSE OR LIMITED WARRANTY, CONTACT YOUR CISCO REPRESENTATIVE FOR A COPY.

The following information is for FCC compliance of Class A devices: This equipment has been tested and found to comply with the limits for a Class A digital device, pursuant to part 15 of the FCC rules. These limits are designed to provide reasonable protection against harmful interference when the equipment is operated in a commercial environment. This equipment generates, uses, and can radiate radio-frequency energy and, if not installed and used in accordance with the instruction manual, may cause harmful interference to radio communications. Operation of this equipment in a residential area is likely to cause harmful interference, in which case users will be required to correct the interference at their own expense.

The following information is for FCC compliance of Class B devices: The equipment described in this manual generates and may radiate radio-frequency energy. If it is not installed in accordance with Cisco's installation instructions, it may cause interference with radio and television reception. This equipment has been tested and found to comply with the limits for a Class B digital device in accordance with the specifications in part 15 of the FCC rules. These specifications are designed to provide reasonable protection against such interference in a residential installation. However, there is no guarantee that interference will not occur in a particular installation.

Modifying the equipment without Cisco's written authorization may result in the equipment no longer complying with FCC requirements for Class A or Class B digital devices. In that event, your right to use the equipment may be limited by FCC regulations, and you may be required to correct any interference to radio or television communications at your own expense.

You can determine whether your equipment is causing interference by turning it off. If the interference stops, it was probably caused by the Cisco equipment or one of its peripheral devices. If the equipment causes interference to radio or television reception, try to correct the interference by using one or more of the following measures:

- Turn the television or radio antenna until the interference stops.
- Move the equipment to one side or the other of the television or radio.
- Move the equipment farther away from the television or radio.
- Plug the equipment into an outlet that is on a different circuit from the television or radio. (That is, make certain the equipment and the television or radio are on circuits controlled by different circuit breakers or fuses.)

Modifications to this product not authorized by Cisco Systems, Inc. could void the FCC approval and negate your authority to operate the product.

The Cisco implementation of TCP header compression is an adaptation of a program developed by the University of California, Berkeley (UCB) as part of UCB's public domain version of the UNIX operating system. All rights reserved. Copyright © 1981, Regents of the University of California.

NOTWITHSTANDING ANY OTHER WARRANTY HEREIN, ALL DOCUMENT FILES AND SOFTWARE OF THESE SUPPLIERS ARE PROVIDED "AS IS" WITH ALL FAULTS. CISCO AND THE ABOVE-NAMED SUPPLIERS DISCLAIM ALL WARRANTIES, EXPRESSED OR IMPLIED, INCLUDING, WITHOUT LIMITATION, THOSE OF MERCHANTABILITY, FITNESS FOR A PARTICULAR PURPOSE AND NONINFRINGEMENT OR ARISING FROM A COURSE OF DEALING, USAGE, OR TRADE PRACTICE.

IN NO EVENT SHALL CISCO OR ITS SUPPLIERS BE LIABLE FOR ANY INDIRECT, SPECIAL, CONSEQUENTIAL, OR INCIDENTAL DAMAGES, INCLUDING, WITHOUT LIMITATION, LOST PROFITS OR LOSS OR DAMAGE TO DATA ARISING OUT OF THE USE OR INABILITY TO USE THIS MANUAL, EVEN IF CISCO OR ITS SUPPLIERS HAVE BEEN ADVISED OF THE POSSIBILITY OF SUCH DAMAGES.

CCIP, CCSP, the Cisco Arrow logo, the Cisco *Powered* Network mark, Cisco Unity, Follow Me Browsing, FormShare, and StackWise are trademarks of Cisco Systems, Inc.; Changing the Way We Work, Live, Play, and Learn, and iQuick Study are service marks of Cisco Systems, Inc.; and Aironet, ASIST, BPX, Catalyst, CCDA, CCDP, CCIE, CCNA, CCNP, Cisco, the Cisco Certified Internetwork Expert logo, Cisco IOS, the Cisco IOS logo, Cisco Press, Cisco Systems, Cisco Systems Capital, the Cisco Systems logo, Empowering the Internet Generation, Enterprise/Solver, EtherChannel, EtherSwitch, Fast Step, GigaStack, Internet Quotient, IOS, IP/TV, iQ Expertise, the iQ logo, iQ Net Readiness Scorecard, LightStream, MGX, MICA, the Networkers logo, Networking Academy, Network Registrar, *Packet*, PIX, Post-Routing, Pre-Routing, RateMUX, Registrar, ScriptShare, SlideCast, SMARTnet, StrataView Plus, Stratm, SwitchProbe, TeleRouter, The Fastest Way to Increase Your Internet Quotient, TransPath, and VCO are registered trademarks of Cisco Systems, Inc. and/or its affiliates in the U.S. and certain other countries.

All other trademarks mentioned in this document or Web site are the property of their respective owners. The use of the word partner does not imply a partnership relationship between Cisco and any other company. (0304R)

*Catalyst 3750 Switch Hardware Installation Guide*

Copyright © 2003, Cisco Systems, Inc. All rights reserved.





**Cisco Limited Lifetime Hardware Warranty Terms** xi

**Preface** xv

Audience xv

Purpose xv

Conventions xvi

Related Publications xxiii

Obtaining Documentation xxiii

    Cisco.com xxiv

    Documentation CD-ROM xxiv

    Ordering Documentation xxiv

    Documentation Feedback xxv

Obtaining Technical Assistance xxv

    Cisco.com xxvi

    Technical Assistance Center xxvi

        Cisco TAC Website xxvii

        Cisco TAC Escalation Center xxvii

Obtaining Additional Publications and Information xxviii

---

**CHAPTER 1**

**Using Express Setup** 1-1

Taking Out What You Need 1-2

Powering On the Switch 1-3

Starting Express Setup 1-4

Configuring the Switch Settings 1-9

Verifying Switch IP Address (Optional) 1-10

- Rerunning Express Setup 1-11
- Where to Go Next 1-12
  - Other Switch Home Page Features 1-12
  - Installing or Connecting Devices to the Switch 1-12

---

**CHAPTER 2**

**Product Overview 2-1**

- Features 2-1
- Front Panel Description 2-3
  - 10/100 and 10/100/1000 Ports 2-6
  - SFP Module Slots 2-7
    - SFP Modules 2-7
  - LEDs 2-8
    - System LED 2-9
    - RPS LED 2-9
    - Master LED 2-10
    - Port LEDs and Modes 2-10
- Rear Panel Description 2-14
  - StackWise Ports 2-15
  - Power Connectors 2-16
    - Internal Power Supply Connector 2-16
    - Cisco RPS Connector 2-16
  - Console Port 2-17
- Management Options 2-18
  - Network Configurations 2-19

---

**CHAPTER 3**

**Switch Installation 3-1**

- Preparing for Installation 3-1
  - Warnings 3-2
  - EMC Regulatory Statements 3-4



U.S.A.	3-4
Taiwan	3-4
Japan	3-4
Korea	3-5
Hungary	3-5
Installation Guidelines	3-6
Verifying Package Contents	3-7
Verifying Switch Operation	3-8
Connecting a PC or Terminal to the Console Port	3-8
Powering On the Switch and Running POST	3-10
Powering Off the Switch and Disconnecting the Console Port	3-11
Planning the Stack	3-12
Planning Considerations	3-12
Powering Considerations	3-13
Cabling Considerations	3-14
Recommended Cabling Configurations	3-15
Installing the Switch	3-17
Rack Mounting	3-18
Removing Screws from the Switch	3-19
Attaching Brackets to the Catalyst 3750G-24TS Switch	3-20
Attaching Brackets to the Catalyst 3750-24TS, 3750G-24T, 3750G-12S, and 3750-48TS Switches	3-25
Mounting the Switch in a Rack	3-28
Attaching the Cable Guide	3-30
Wall Mounting	3-32
Attaching the Brackets to the Switch for Wall-Mounting	3-32
Attaching the RPS Connector Cover	3-33
Mounting the Switch on a Wall	3-34
Table or Shelf Mounting	3-36
Connecting StackWise Cable to StackWise Ports	3-37

- Installing and Removing SFP Modules **3-40**
  - Installing SFP Modules into SFP Module Slots **3-41**
  - Removing SFP Modules from SFP Module Slots **3-43**
- Connecting to the 10/100 and 10/100/1000 Ports **3-44**
- Connecting to an SFP Module **3-46**
  - Connecting to a Fiber-Optic SFP Module **3-47**
  - Connecting to 1000BASE-T SFP Modules **3-48**
- Where to Go Next **3-50**

---

**CHAPTER 4**

**Troubleshooting 4-1**

- Understanding POST Results **4-1**
- Clearing the Switch IP Address and Configuration **4-2**
- Diagnosing Problems **4-3**
- Replacing a Failed Stack Member **4-7**

---

**APPENDIX A**

**Technical Specifications A-1**

---

**APPENDIX B**

**Connector and Cable Specifications B-1**

- Connector Specifications **B-1**
  - 10/100/1000 Ports **B-1**
    - Connecting to 10BASE-T- and 100BASE-TX-Compatible Devices **B-2**
    - Connecting to 1000BASE-T Devices **B-2**
  - 10/100 Ports **B-3**
  - SFP Module Ports **B-5**
  - Console Port **B-6**
- Cable and Adapter Specifications **B-6**
  - Two Twisted-Pair Cable Pinouts **B-6**
  - Four Twisted-Pair Cable Pinouts for 10/100 Ports **B-7**
  - Four Twisted-Pair Cable Pinouts for 1000BASE-T Ports **B-8**

- Crossover Cable and Adapter Pinouts **B-9**
- Identifying a Crossover Cable **B-9**
- Adapter Pinouts **B-10**

---

**APPENDIX C****Managing the Switch by Using the Cluster Management Suite C-1**

- Connecting to an Ethernet Port **C-2**
- Launching the Switch Home Page **C-3**
- CMS Requirements **C-5**
  - Recommended Configuration for Web-Based Management **C-6**
  - Operating System and Browser Support **C-6**
  - Supported Java Plug-Ins **C-7**
  - Java Plug-In Notes **C-8**
- Where to Go Next **C-8**

---

**APPENDIX D****Quick Setup By Using the CLI-Based Setup Program D-1**

- Methods for Accessing the CLI **D-2**
  - Accessing the CLI Through Express Setup (Unconfigured Switch Only) **D-2**
  - Accessing the CLI Through the Console Port **D-3**
- Taking Out What You Need **D-4**
- Stacking the Switches (Optional) **D-5**
- Connecting to the Console Port **D-7**
- Starting the Terminal Emulation Software **D-9**
- Connecting to a Power Source **D-9**
- Entering the Initial Configuration Information **D-10**
  - IP Settings **D-10**
  - Completing the Setup Program **D-11**

**APPENDIX E**

**Translated Safety Warnings E-1**

Attaching the Cisco RPS (model PWR300-AC-RPS-N1) E-1

Attaching the Cisco RPS (model PWR675-AC-RPS-N1) E-2

Installation Warning E-4

Installation Instructions E-5

Jewelry Removal Warning E-6

Stacking the Chassis Warning E-8

Main Disconnecting Device E-10

Grounded Equipment Warning E-11

Installing or Replacing the Unit E-12

Overtemperature Warning E-14

Working During Lightning Activity E-16

Product Disposal Warning E-17

Chassis Warning for Rack-Mounting and Servicing E-19

Redundant Power Supply Connection Warning E-24

Switch Installation Warning E-25

Restricted Area E-27

Ethernet Cable Shielding in Offices E-28

Laser Beam Exposure E-30

Laser Radiation E-31

E-32

**INDEX**



# Cisco Limited Lifetime Hardware Warranty Terms

---

There are special terms applicable to your hardware warranty and various services that you can use during the warranty period. Follow these steps to access and download the *Cisco Information Packet* and your warranty document from Cisco.com.

1. Launch your browser, and go to this URL:

[http://www.cisco.com/univercd/cc/td/doc/es\\_inpk/cetrans.htm](http://www.cisco.com/univercd/cc/td/doc/es_inpk/cetrans.htm)

The Warranties and License Agreements page appears.

2. To read the *Cisco Information Packet*, follow these steps:

- a. Click the **Information Packet Number** field, and make sure that the part number 78-5235-02F0 is highlighted.
- b. Select the language in which you would like to read the document.
- c. Click **Go**.

The Cisco Limited Warranty and Software License page from the Information Packet appears.

- d. Read the document online, or click the **PDF** icon to download and print the document in Adobe Portable Document Format (PDF).



---

**Note**

You must have Adobe Acrobat Reader to view and print PDF files. You can download the reader from Adobe's website: <http://www.adobe.com>

---

3. To read translated and localized warranty information about your product, follow these steps:
  - a. Enter this part number in the Warranty Document Number field:  
78-6310-02C0
  - b. Select the language in which you would like to view the document.
  - c. Click **Go**.  
The Cisco warranty page appears.
  - d. Read the document online, or click the **PDF** icon to download and print the document in Adobe Portable Document Format (PDF).

You can also contact the Cisco service and support website for assistance:

[http://www.cisco.com/public/Support\\_root.shtml](http://www.cisco.com/public/Support_root.shtml).

#### **Duration of Hardware Warranty**

A Cisco product hardware warranty is supported for as long as the original end user continues to own or use the product, provided that the fan and power supply warranty is limited to five (5) years. In the event of a discontinuance of product manufacture, the Cisco warranty support is limited to five (5) years from the announcement of the discontinuance.

#### **Replacement, Repair, or Refund Policy for Hardware**

Cisco or its service center will use commercially reasonable efforts to ship a replacement part within ten (10) working days after receipt of the Return Materials Authorization (RMA) request. Actual delivery times can vary, depending on the customer location.

Cisco reserves the right to refund the purchase price as its exclusive warranty remedy.

**To Receive a Return Materials Authorization (RMA) Number**

Contact the company from whom you purchased the product. If you purchased the product directly from Cisco, contact your Cisco Sales and Service Representative.

Complete the information below, and keep it for reference.

Company product purchased from	
Company telephone number	
Product model number	
Product serial number	
Maintenance contract number	







## Preface

---

### Audience

This guide is for the networking or computer technician responsible for installing the Catalyst 3750 switches. We assume that you are familiar with the concepts and terminology of Ethernet and local area networking.

### Purpose

This guide documents the hardware features of the Catalyst 3750 family of switches. It describes the physical and performance characteristics of each switch, explains how to install a switch, and provides troubleshooting information.

This guide does not describe system messages that you might receive or how to configure your switch. For more information, refer to the switch software configuration guide, the switch command reference, and the switch system message guide on the Cisco.com Product Documentation home page. For information about the standard Cisco IOS Release 12.1 commands, refer to the IOS documentation set from the Cisco.com home page at **Service and Support > Technical Documents**. On the Cisco Product Documentation home page, select Release **12.1** from the Cisco IOS Software drop-down list.

# Conventions

This document uses these conventions and symbols for notes, cautions, and warnings:



**Note**

Means *reader take note*. Notes contain helpful suggestions or references to materials not contained in this manual.



**Caution**

Means *reader be careful*. In this situation, you might do something that could result in equipment damage or loss of data.



**Warning**

## IMPORTANT SAFETY INSTRUCTIONS

**This warning symbol means danger. You are in a situation that could cause bodily injury. Before you work on any equipment, be aware of the hazards involved with electrical circuitry and be familiar with standard practices for preventing accidents. Use the statement number provided at the end of each warning to locate its translation in the translated safety warnings that accompanied this device.**

## SAVE THESE INSTRUCTIONS

**Waarschuwing**

## BELANGRIJKE VEILIGHEIDSINSTRUCTIES

**Dit waarschuwingssymbool betekent gevaar. U verkeert in een situatie die lichamelijk letsel kan veroorzaken. Voordat u aan enige apparatuur gaat werken, dient u zich bewust te zijn van de bij elektrische schakelingen betrokken risico's en dient u op de hoogte te zijn van de standaard praktijken om ongelukken te voorkomen. Gebruik het nummer van de verklaring onderaan de waarschuwing als u een vertaling van de waarschuwing die bij het apparaat wordt geleverd, wilt raadplegen.**

## BEWAAR DEZE INSTRUCTIES

**Varoitus TÄRKEITÄ TURVALLISUUSOHJEITA**

Tämä varoitusmerkki merkitsee vaaraa. Tilanne voi aiheuttaa ruumiillisia vammoja. Ennen kuin käsittelet laitteistoa, huomioi sähköpiirien käsittelemiseen liittyvät riskit ja tutustu onnettomuuksien yleisiin ehkäisytapoihin. Turvallisuusvaroitusten käännökset löytyvät laitteen mukana toimitettujen käännettyjen turvallisuusvaroitusten joukosta varoitusten lopussa näkyvien lausuntonumeroiden avulla.

**SÄILYTÄ NÄMÄ OHJEET****Attention IMPORTANTES INFORMATIONS DE SÉCURITÉ**

Ce symbole d'avertissement indique un danger. Vous vous trouvez dans une situation pouvant entraîner des blessures ou des dommages corporels. Avant de travailler sur un équipement, soyez conscient des dangers liés aux circuits électriques et familiarisez-vous avec les procédures couramment utilisées pour éviter les accidents. Pour prendre connaissance des traductions des avertissements figurant dans les consignes de sécurité traduites qui accompagnent cet appareil, référez-vous au numéro de l'instruction situé à la fin de chaque avertissement.

**CONSERVEZ CES INFORMATIONS****Warnung WICHTIGE SICHERHEITSHINWEISE**

Dieses Warnsymbol bedeutet Gefahr. Sie befinden sich in einer Situation, die zu Verletzungen führen kann. Machen Sie sich vor der Arbeit mit Geräten mit den Gefahren elektrischer Schaltungen und den üblichen Verfahren zur Vorbeugung vor Unfällen vertraut. Suchen Sie mit der am Ende jeder Warnung angegebenen Anweisungsnummer nach der jeweiligen Übersetzung in den übersetzten Sicherheitshinweisen, die zusammen mit diesem Gerät ausgeliefert wurden.

**BEWAHREN SIE DIESE HINWEISE GUT AUF.**

**Avvertenza      IMPORTANTI ISTRUZIONI SULLA SICUREZZA**

**Questo simbolo di avvertenza indica un pericolo. La situazione potrebbe causare infortuni alle persone. Prima di intervenire su qualsiasi apparecchiatura, occorre essere al corrente dei pericoli relativi ai circuiti elettrici e conoscere le procedure standard per la prevenzione di incidenti. Utilizzare il numero di istruzione presente alla fine di ciascuna avvertenza per individuare le traduzioni delle avvertenze riportate in questo documento.**

**CONSERVARE QUESTE ISTRUZIONI****Advarsel      VIKTIGE SIKKERHETSINSTRUKSJONER**

**Dette advarselssymbolet betyr fare. Du er i en situasjon som kan føre til skade på person. Før du begynner å arbeide med noe av utstyret, må du være oppmerksom på farene forbundet med elektriske kretser, og kjenne til standardprosedyrer for å forhindre ulykker. Bruk nummeret i slutten av hver advarsel for å finne oversettelsen i de oversatte sikkerhetsadvarslene som fulgte med denne enheten.**

**TA VARE PÅ DISSE INSTRUKSJONENE****Aviso      INSTRUÇÕES IMPORTANTES DE SEGURANÇA**

**Este símbolo de aviso significa perigo. Você está em uma situação que poderá ser causadora de lesões corporais. Antes de iniciar a utilização de qualquer equipamento, tenha conhecimento dos perigos envolvidos no manuseio de circuitos elétricos e familiarize-se com as práticas habituais de prevenção de acidentes. Utilize o número da instrução fornecido ao final de cada aviso para localizar sua tradução nos avisos de segurança traduzidos que acompanham este dispositivo.**

**GUARDE ESTAS INSTRUÇÕES**

**¡Advertencia! INSTRUCCIONES IMPORTANTES DE SEGURIDAD**

Este símbolo de aviso indica peligro. Existe riesgo para su integridad física. Antes de manipular cualquier equipo, considere los riesgos de la corriente eléctrica y familiarícese con los procedimientos estándar de prevención de accidentes. Al final de cada advertencia encontrará el número que le ayudará a encontrar el texto traducido en el apartado de traducciones que acompaña a este dispositivo.

**GUARDE ESTAS INSTRUCCIONES****Varning! VIKTIGA SÄKERHETSANVISNINGAR**

Denna varningssignal signalerar fara. Du befinner dig i en situation som kan leda till personskada. Innan du utför arbete på någon utrustning måste du vara medveten om farorna med elkretsar och känna till vanliga förfaranden för att förebygga olyckor. Använd det nummer som finns i slutet av varje varning för att hitta dess översättning i de översatta säkerhetsvarningar som medföljer denna anordning.

**SPARA DESSA ANVISNINGAR****Figyelem FONTOS BIZTONSÁGI ELOÍRÁSOK**

Ez a figyelmeztető jel veszélyre utal. Sérülésveszélyt rejtő helyzetben van. Mielőtt bármely berendezésen munkát végezte, legyen figyelemmel az elektromos áramkörök okozta kockázatokra, és ismerkedjen meg a szokásos balesetvédelmi eljárásokkal. A kiadványban szereplő figyelmeztetések fordítása a készülékhez mellékelt biztonsági figyelmeztetések között található; a fordítás az egyes figyelmeztetések végén látható szám alapján kereshető meg.

**ORIZZE MEG EZEKET AZ UTASÍTÁSOKAT!**

## Предупреждение

**ВАЖНЫЕ ИНСТРУКЦИИ ПО СОБЛЮДЕНИЮ ТЕХНИКИ БЕЗОПАСНОСТИ**

Этот символ предупреждения обозначает опасность. То есть имеет место ситуация, в которой следует опасаться телесных повреждений. Перед эксплуатацией оборудования выясните, каким опасностям может подвергаться пользователь при использовании электрических цепей, и ознакомьтесь с правилами техники безопасности для предотвращения возможных несчастных случаев. Воспользуйтесь номером заявления, приведенным в конце каждого предупреждения, чтобы найти его переведенный вариант в переводе предупреждений по безопасности, прилагаемом к данному устройству.

**СОХРАНИТЕ ЭТИ ИНСТРУКЦИИ**

## 警告

重要的安全性说明

此警告符号代表危险。您正处于可能受到严重伤害的工作环境中。在您使用设备开始工作之前，必须充分意识到触电的危险，并熟练掌握防止事故发生的标准工作程序。请根据每项警告结尾提供的声明号码来找到此设备的安全性警告说明的翻译文本。

请保存这些安全性说明

## 警告

安全上の重要な注意事項

「危険」の意味です。人身事故を予防するための注意事項が記述されています。装置の取り扱い作業を行うときは、電気回路の危険性に注意し、一般的な事故防止策に留意してください。警告の各国語版は、各注意事項の番号を基に、装置に付属の「Translated Safety Warnings」を参照してください。

これらの注意事項を保管しておいてください。

# Related Publications

You can order printed copies of documents with a DOC-xxxxxx= number. For more information, see the “[Ordering Documentation](#)” section on page xxii.

These documents provide complete information about the switch and are available from this Cisco.com site:

<http://www.cisco.com/univercd/cc/td/doc/product/lan/cat3750/index.htm>

- *Release Notes for the Catalyst 3750 Switch* (not orderable but available on Cisco.com)

**Note**

---

Before installing, configuring, or upgrading the switch, refer to the release notes on Cisco.com for the latest information.

---

- *Catalyst 3750 Switch Software Configuration Guide* (order number DOC-7815164=)
- *Catalyst 3750 Switch Command Reference* (order number DOC-7815165=)
- *Catalyst 3750 Switch System Message Guide* (order number DOC-7815166=)
- Cluster Management Suite (CMS) online help (available only from the switch CMS software)
- *Catalyst 3750 Switch Hardware Installation Guide* (order number DOC-7815136=)
- *Cisco Small Form-Factor Pluggable Modules Installation Notes* (order number DOC-7815160=)
- *Cisco Small Form-Factor Pluggable Modules Compatibility Matrix* (not orderable but available on Cisco.com)
- *Compatibility Matrix for 1000BASE-T Small Form-Factor Pluggable Modules* (not orderable but available on Cisco.com)

# Obtaining Documentation

Cisco provides several ways to obtain documentation, technical assistance, and other technical resources. These sections explain how to obtain technical information from Cisco Systems.

## Cisco.com

You can access the most current Cisco documentation on the World Wide Web at this URL:

<http://www.cisco.com/univercd/home/home.htm>

You can access the Cisco website at this URL:

<http://www.cisco.com>

International Cisco websites can be accessed from this URL:

[http://www.cisco.com/public/countries\\_languages.shtml](http://www.cisco.com/public/countries_languages.shtml)

## Documentation CD-ROM

Cisco documentation and additional literature are available in a Cisco Documentation CD-ROM package, which may have shipped with your product. The Documentation CD-ROM is updated regularly and may be more current than printed documentation. The CD-ROM package is available as a single unit or through an annual or quarterly subscription.

Registered Cisco.com users can order a single Documentation CD-ROM (product number DOC-CONDOCCD=) through the Cisco Ordering tool:

[http://www.cisco.com/en/US/partner/ordering/ordering\\_place\\_order\\_ordering\\_tool\\_launch.html](http://www.cisco.com/en/US/partner/ordering/ordering_place_order_ordering_tool_launch.html)

All users can order annual or quarterly subscriptions through the online Subscription Store:

<http://www.cisco.com/go/subscription>

## Ordering Documentation

You can find instructions for ordering documentation at this URL:

[http://www.cisco.com/univercd/cc/td/doc/es\\_inpck/pdi.htm](http://www.cisco.com/univercd/cc/td/doc/es_inpck/pdi.htm)

You can order Cisco documentation in these ways:

- Registered Cisco.com users (Cisco direct customers) can order Cisco product documentation from the Networking Products MarketPlace:



<http://www.cisco.com/en/US/partner/ordering/index.shtml>

- Nonregistered Cisco.com users can order documentation through a local account representative by calling Cisco Systems Corporate Headquarters (California, USA.) at 408 526-7208 or, elsewhere in North America, by calling 800 553-NETS (6387).

## Documentation Feedback

You can submit comments electronically on Cisco.com. On the Cisco Documentation home page, click **Feedback** at the top of the page.

You can send your comments in e-mail to [bug-doc@cisco.com](mailto:bug-doc@cisco.com).

You can submit comments by using the response card (if present) behind the front cover of your document or by writing to the following address:

Cisco Systems  
Attn: Customer Document Ordering  
170 West Tasman Drive  
San Jose, CA 95134-9883

We appreciate your comments.

## Obtaining Technical Assistance

For all customers, partners, resellers, and distributors who hold valid Cisco service contracts, the Cisco Technical Assistance Center (TAC) provides 24-hour, award-winning technical support services, online and over the phone. Cisco.com features the Cisco TAC website as an online starting point for technical assistance.

## Cisco TAC Website

The Cisco TAC website (<http://www.cisco.com/tac>) provides online documents and tools for troubleshooting and resolving technical issues with Cisco products and technologies. The Cisco TAC website is available 24 hours a day, 365 days a year.

Accessing all the tools on the Cisco TAC website requires a Cisco.com user ID and password. If you have a valid service contract but do not have a login ID or password, register at this URL:

<http://tools.cisco.com/RPF/register/register.do>

## Opening a TAC Case

The online TAC Case Open Tool (<http://www.cisco.com/tac/caseopen>) is the fastest way to open P3 and P4 cases. (Your network is minimally impaired or you require product information). After you describe your situation, the TAC Case Open Tool automatically recommends resources for an immediate solution. If your issue is not resolved using these recommendations, your case will be assigned to a Cisco TAC engineer.

For P1 or P2 cases (your production network is down or severely degraded) or if you do not have Internet access, contact Cisco TAC by telephone. Cisco TAC engineers are assigned immediately to P1 and P2 cases to help keep your business operations running smoothly.

To open a case by telephone, use one of the following numbers:

Asia-Pacific: +61 2 8446 7411 (Australia: 1 800 805 227)

EMEA: +32 2 704 55 55

USA: 1 800 553-2447

For a complete listing of Cisco TAC contacts, go to this URL:

<http://www.cisco.com/warp/public/687/Directory/DirTAC.shtml>

## TAC Case Priority Definitions

To ensure that all cases are reported in a standard format, Cisco has established case priority definitions.

Priority 1 (P1)—Your network is “down” or there is a critical impact to your business operations. You and Cisco will commit all necessary resources around the clock to resolve the situation.

Priority 2 (P2)—Operation of an existing network is severely degraded, or significant aspects of your business operation are negatively affected by inadequate performance of Cisco products. You and Cisco will commit full-time resources during normal business hours to resolve the situation.

Priority 3 (P3)—Operational performance of your network is impaired, but most business operations remain functional. You and Cisco will commit resources during normal business hours to restore service to satisfactory levels.

Priority 4 (P4)—You require information or assistance with Cisco product capabilities, installation, or configuration. There is little or no effect on your business operations.

## Obtaining Additional Publications and Information

Information about Cisco products, technologies, and network solutions is available from various online and printed sources.

- The *Cisco Product Catalog* describes the networking products offered by Cisco Systems, as well as ordering and customer support services. Access the *Cisco Product Catalog* at this URL:

[http://www.cisco.com/en/US/products/products\\_catalog\\_links\\_launch.html](http://www.cisco.com/en/US/products/products_catalog_links_launch.html)

- Cisco Press publishes a wide range of networking publications. Cisco suggests these titles for new and experienced users: *Internetworking Terms and Acronyms Dictionary*, *Internetworking Technology Handbook*, *Internetworking Troubleshooting Guide*, and the *Internetworking Design Guide*. For current Cisco Press titles and other information, go to Cisco Press online at this URL:

<http://www.ciscopress.com>

- Packet magazine is the Cisco quarterly publication that provides the latest networking trends, technology breakthroughs, and Cisco products and solutions to help industry professionals get the most from their networking investment. Included are networking deployment and troubleshooting tips, configuration examples, customer case studies, tutorials and training, certification information, and links to numerous in-depth online resources. You can access Packet magazine at this URL:

<http://www.cisco.com/go/packet>

- iQ Magazine is the Cisco bimonthly publication that delivers the latest information about Internet business strategies for executives. You can access iQ Magazine at this URL:

<http://www.cisco.com/go/iqmagazine>

- Internet Protocol Journal is a quarterly journal published by Cisco Systems for engineering professionals involved in designing, developing, and operating public and private internets and intranets. You can access the Internet Protocol Journal at this URL:

[http://www.cisco.com/en/US/about/ac123/ac147/about\\_cisco\\_the\\_internet\\_protocol\\_journal.html](http://www.cisco.com/en/US/about/ac123/ac147/about_cisco_the_internet_protocol_journal.html)

- Training—Cisco offers world-class networking training. Current offerings in network training are listed at this URL:

<http://www.cisco.com/en/US/learning/index.html>



# Using Express Setup

---

This chapter provides a quick, step-by-step setup procedure for a standalone switch or a switch stack.



## Note

---

Express Setup is supported on switches running Cisco IOS Release 12.1(14)EA1 or later. If you are installing a new switch, refer to the Cisco IOS release label on the rear panel of the switch to determine the release.

For quick setup instructions for switches running releases earlier than Cisco IOS Release 12.1(14)EA1, go to [Appendix D, “Quick Setup By Using the CLI-Based Setup Program.”](#)

---

The setup procedure includes these steps:

- [Taking Out What You Need, page 1-2](#)
- [Powering On the Switch, page 1-3](#)
- [Starting Express Setup, page 1-4](#)
- [Configuring the Switch Settings, page 1-9](#)
- [Where to Go Next, page 1-12](#)

**Caution**

Do not start Express Setup when there are any devices connected to the switch or connect a switch that is already in Express Setup mode to any device other than the PC or workstation that is being used to configure it. The switch acts as a DHCP server during the Express Setup procedure, and only the PC or workstation connected to the switch after Express Startup is started should receive a DHCP address from the switch.

## Taking Out What You Need

Remove the items shown in [Figure 1-1](#) from the shipping container.

**Figure 1-1 Catalyst 3750 Switch and AC Power Cord**

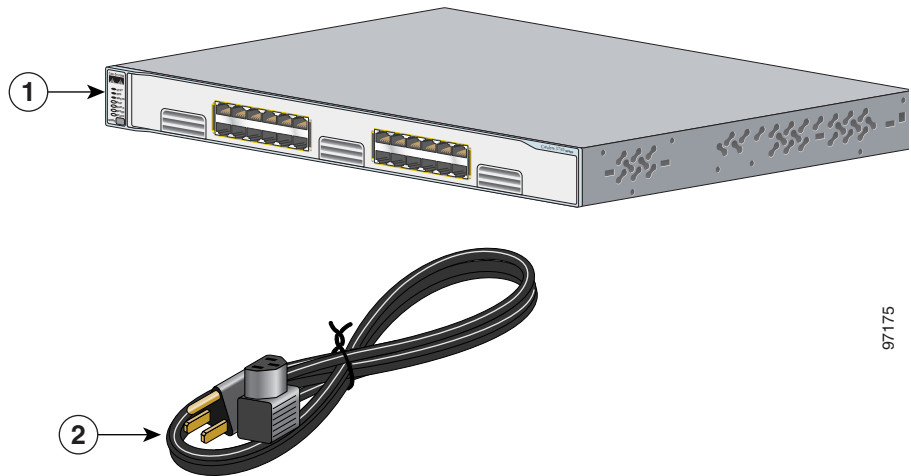

97175

1	Switch	2	AC power cord
---	--------	---	---------------

You also need to provide an Ethernet (Category 5) straight-through cable (not included), as shown in [Figure 1-2](#), to connect the switch to your PC or workstation.

Figure 1-2 Ethernet Cable



89887

## Powering On the Switch

Complete these steps to power on the switch:

- Step 1** Connect one end of the AC power cord to the power connector on the switch rear panel, as shown in [Figure 1-3](#).

Figure 1-3 Connecting the Power

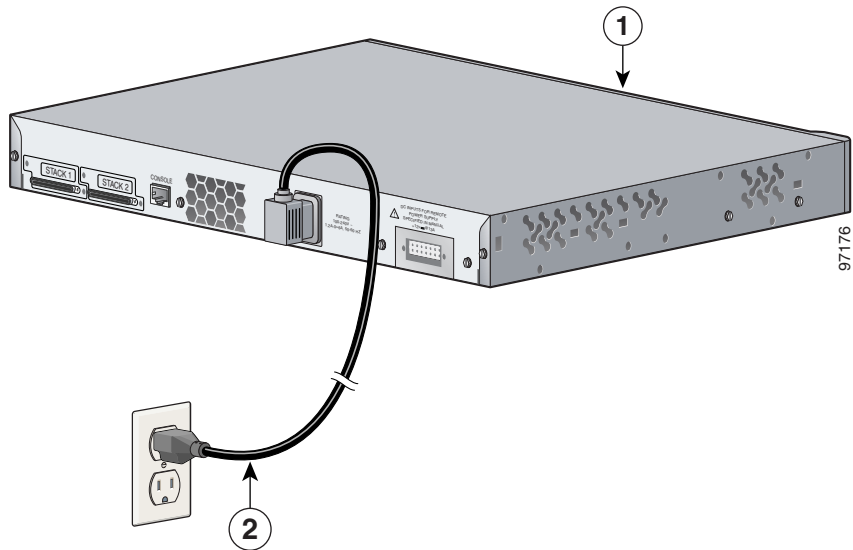

97176

1	Switch	2	AC power cord
---	--------	---	---------------

**Step 2** Connect the other end of the power cable to a grounded AC outlet.

---

After the switch powers on, it begins the power-on self-test (POST), a series of tests that run automatically to ensure that the switch functions properly.

POST lasts approximately 1 minute. When POST is complete, only the SYST and STAT LEDs remain green. The MASTR LED is also green on a single switch or on a stack master switch.

The SYST LED turns amber if the POST fails. If the POST fails, see [Chapter 4, “Troubleshooting,”](#) to determine a course of action.

## Starting Express Setup

Express Setup is a browser-based program that you can use to set up and configure the switch. You assign the IP information so that the switch can connect to local routers and the Internet. The IP address is also required if you plan to further configure the switch.

You do not create a username with Express Setup. Express Setup provides the minimum configuration to configure a switch. To create a username for the switch, use the Cluster Management Suite (CMS) or the command-line interface (CLI).



### Note

Before starting Express Setup, verify that the switch has passed POST and that the SYST and STAT LEDs are green. For information about troubleshooting a POST failure, see the [“Understanding POST Results”](#) section on page 4-2. You cannot start Express Setup until POST has completed.

---



### Caution

Do not start Express Setup when there are any devices connected to the switch. The switch acts as a DHCP server during the Express Setup procedure, and only the PC or workstation connected to the switch after Express Startup is started should receive a DHCP address from the switch.

---



Follow these steps to start the Express Setup program:

- Step 1** Verify that no devices are connected to the switch.
- Step 2** Press and hold the Mode button, as shown in [Figure 1-4](#), until the four LEDs above the Mode button turn green. This takes approximately 3 seconds.

**Figure 1-4** Starting Express Setup

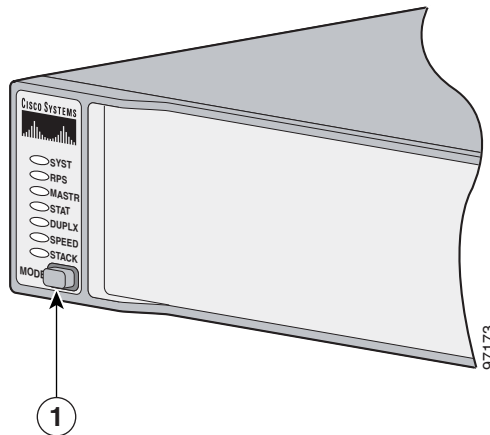

**1** Mode button

- Step 3** Release the Mode button.



**Note**

If all of the LEDs begin to blink after you press the Mode button, release it. Blinking LEDs mean that the switch has already been configured and cannot go into Express Setup mode. For more information, see the [“Clearing the Switch IP Address and Configuration”](#) section on page 4-2.

- Step 4** Connect the Ethernet cable (not included) to a 10/100 Ethernet port or small form-factor pluggable (SFP) module port on the front panel of the switch, as shown in [Figure 1-5](#).

**Caution**

Do not connect the switch to any device other than the PC or workstation being used to configure it.

**Figure 1-5** Connecting the Switch and PC or Workstation Ethernet Ports

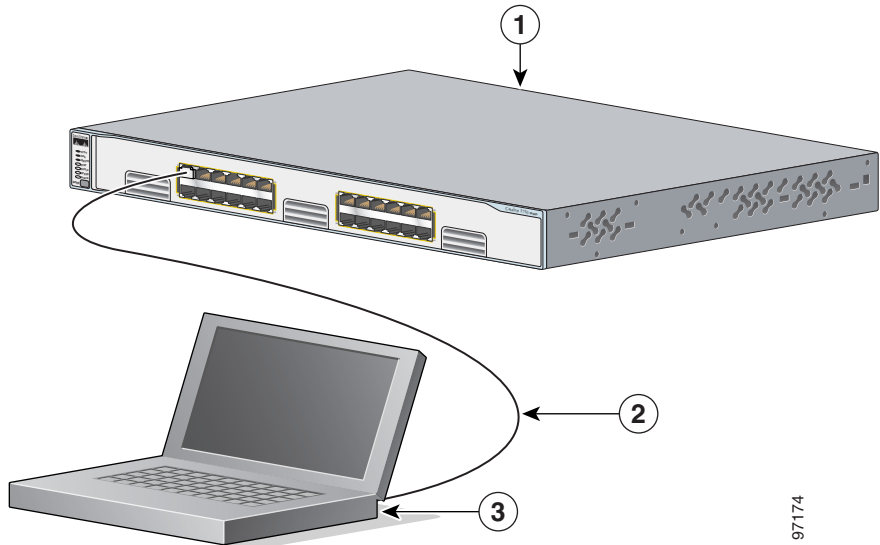

97174

<b>1</b>	Switch	<b>3</b>	PC or workstation
<b>2</b>	Ethernet cable		

- Step 5** Connect the other end of the cable to the Ethernet port on the PC or workstation. Verify that the port status LEDs on both connected Ethernet ports are green.
- Step 6** Wait approximately 30 seconds *after* the port LEDs turn green, and launch a web browser on your PC or workstation.
- Step 7** Enter the IP address **10.0.0.1**, as shown in [Figure 1-6](#), and press **Enter**.

**Figure 1-6 Entering the IP Address**

The Express Setup home page appears, as shown in [Figure 1-7](#).

**Figure 1-7 Express Setup Home Page**

 A screenshot of the Express Setup home page. On the left is a navigation menu with links: HOME, EXPRESS SETUP (highlighted), CLUSTER MANAGEMENT SUITE, TOOLS, and HELP RESOURCES. The main content area is titled "Express Setup" and contains the following sections:
 

- Management Interface:** VLAN1 - Default
- IP Address:** [text input field]
- IP Subnet Mask:** [dropdown menu]
- Default Gateway:** [text input field]
- Switch Password:** [text input field]
- Confirm Switch Password:** [text input field]
- Optional Settings**
- Host Name:** [text input field]
- System Contact:** [text input field]
- System Location:** [text input field]
- Telnet Access:**  Enable  Disable
- Telnet Password:** [text input field]
- Confirm Telnet Password:** [text input field]
- SNMP:**  Enable  Disable
- SNMP Read Community:** [text input field]
- SNMP Write Community:** [text input field]

 At the bottom right of the form are "Save" and "Cancel" buttons.

If the Express Setup does not run, or the Express Setup home page does not appear in your browser:

- Did you wait 30 seconds after connecting the switch and PC or workstation before entering the IP address in your browser?
  - If not, wait 30 seconds, and re-enter **10.0.0.1** in the browser, and press **Enter**.
- Did you enter the wrong address in the browser, or is there an error message displayed in the browser window?

Re-enter **10.0.0.1** in the browser, and press **Enter**.

- Did you connect a crossover instead of a straight-through Ethernet cable between an Ethernet port of the switch and the Ethernet port of the PC or workstation, as shown [Figure 1-5](#).



---

**Note** See [Figure B-11 on page B-9](#) for instructions on identifying a crossover cable.

---



---

**Note** On switches running Cisco IOS Release 12.1(14)EA1 or later, you can use the **mdix auto** command in the CLI to enable the automatic crossover feature. When the automatic crossover feature is enabled, the switch detects the required cable type for copper Ethernet connections and configures the interfaces accordingly. Therefore, you can use either a crossover or a straight-through cable for connections to a copper 10/100 or 10/100/1000 port on the switch, regardless the type of device on the other end of the connection.

The automatic crossover feature is disabled by default. For configuration information for this feature, refer to the switch software configuration guide or the switch command reference.

---

If not, reconnect the cable to the Ethernet port on the switch and PC or workstation. Wait 30 seconds before entering **10.0.0.1** in the browser.

- Did you verify that POST successfully ran before starting Express Setup?  
If not, make sure that only the SYST and STAT LEDs are green before pressing the Mode button to begin Express Setup.



---

**Note** The rest of this chapter explains how to configure a switch by using the Express Setup web page. To configure the switch by using the command-line interface (CLI)-based setup program, see [Appendix D, “Quick Setup By Using the CLI-Based Setup Program.”](#)

---

# Configuring the Switch Settings

The Management Interface field displays **VLAN1-Default**. This is the management interface through which you manage the switch and to which you assign IP information.

Follow these steps to configure your switch with Express Setup:

- 
- Step 1** Contact your system administrator and obtain the IP address, the IP subnet mask, and the default gateway for your switch.
  - Step 2** Enter the IP address of the switch in the **IP Address** field.
  - Step 3** Click the drop-down arrow in the **IP Subnet Mask** field, and select an **IP Subnet Mask**.
  - Step 4** Enter the IP address for the default gateway in the **Default Gateway** field.

A gateway (router or dedicated network device) is a system that connects a network on one subnet to one or more networks on a different subnet.

**Note**

You must specify a default gateway if the management workstation and the switch are on different IP segments.

- 
- Step 5** Enter your password in the **Switch Password** field.  
The password can be from 1 to 25 alphanumeric characters, can start with a number, is case sensitive, allows embedded spaces, but does not allow embedded spaces at the beginning or end.
  - Step 6** Enter your password again in the **Confirm Switch Password** field.  
You do not enter a username for the switch. After the switch is configured with an IP address, you can use CMS to configure a username.
  - Step 7** (Optional) Enter a host name for the switch in the **Host Name** field. The host name is limited to 31 characters; embedded spaces are not allowed.
  - Step 8** (Optional) Enter the name of your system contact in the **System Contact** field. This identifies the system administrator for the switch or network.
  - Step 9** (Optional) Enter your system location in the **System Location** field. This identifies the physical location of the switch.

- Step 10** (Optional) Click **Enable** in the **Telnet Access** field if you are going to use Telnet to manage the switch by using the CLI. If you enable Telnet access, you must enter a Telnet password:
- Enter a password in the **Telnet Password** field. The Telnet password can be from 1 to 25 alphanumeric characters, is case sensitive, allows embedded spaces, but does not allow embedded spaces at the beginning or end.
  - Enter the Telnet password again in the **Confirm Telnet Password** field.
- Step 11** (Optional) Click **Enable** to configure Simple Network Management Protocol (SNMP). Enable SNMP only if you plan to manage switches by using Cisco Works or another SNMP-based network-management system.
- If you enable SNMP, you must enter a community string in either the **SNMP Read Community** field, the **SNMP Write Community** field, or both. SNMP community strings authenticate access to MIB objects. Embedded spaces are not allowed in SNMP community strings. If you set the SNMP read community, users can access MIB objects, but cannot modify them. If you set the SNMP write community, users can access and modify MIB objects.
- Step 12** Click **Save** to save your settings to the switch, or click **Cancel** to clear your settings.
- 

The switch exits Express Setup mode.

Your switch is now configured with the new IP address. You can install the switch in your production network.

## Verifying Switch IP Address (Optional)

After you have installed the switch in your network, follow these steps to verify the IP address configured on your switch:

- 
- Step 1** Launch a web browser on a PC or workstation that is connected the network.
- Step 2** Enter the IP address of your switch (for example: *172.20.139.142.*) The switch home page appears, as shown in Figure 1-8.

Figure 1-8 Switch Home Page

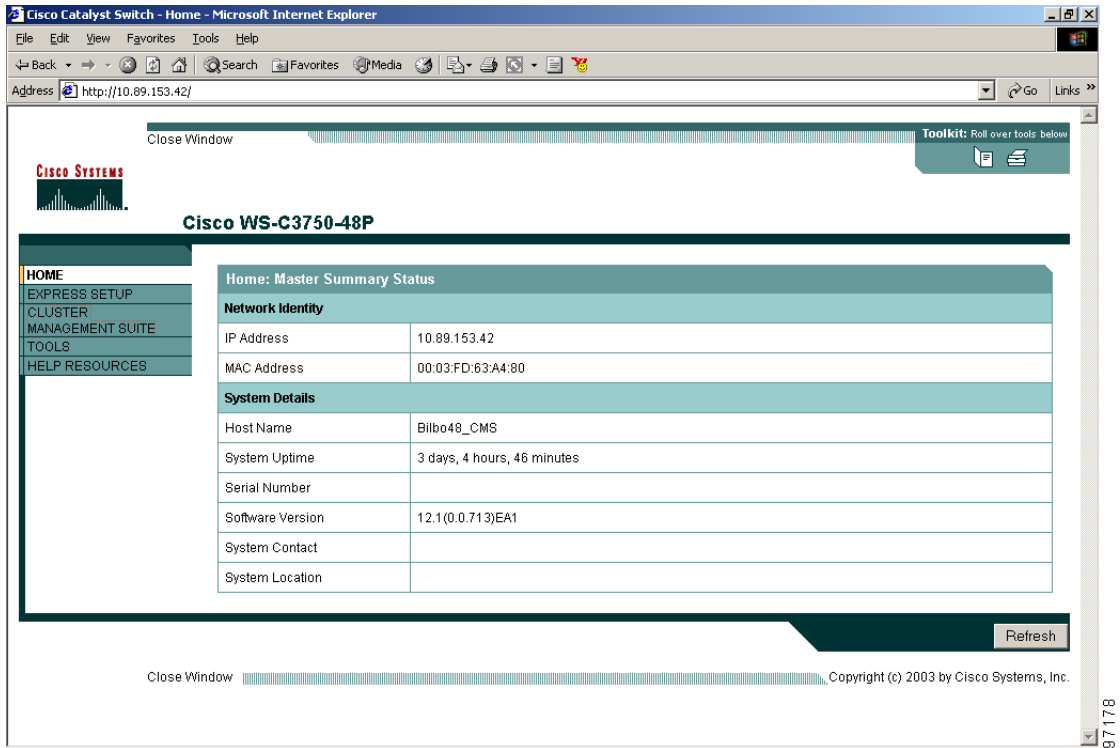

## Rerunning Express Setup

If you did not click Save at the end of the [Configuring the Switch Settings](#) section, you can rerun Express Setup by clicking **Express Setup** on the Switch home page.

If you have entered a wrong IP address or need to change the IP address of your switch, you can clear the IP address on your switch by following the steps in the [“Clearing the Switch IP Address and Configuration”](#) section on page 4-2.

# Where to Go Next

After you have saved your configuration to the switch, you can install the switch or further configure it by using CMS or the CLI.

## Other Switch Home Page Features

These additional features are available from the switch home page, as shown on the left menu bar in [Figure 1-8 on page 1-11](#):

- **Cluster Management Suite**—Launch the CMS, through which you can configure and monitor a switch or switch clusters, display network topologies to gather link information, and display switch images to modify switch- and port-level settings. For more information, refer to the switch software configuration guide

For CMS requirements, see [Appendix C, “Managing the Switch by Using the Cluster Management Suite.”](#)

- **Tools**—Access diagnostic and monitoring tools such as Telnet and Extended Ping.
- **Help Resources**—Access Catalyst 3750 documentation.

## Installing or Connecting Devices to the Switch

For detailed installation procedures on mounting your switch on or under a desk or on a wall, or connecting devices to the switch, see [Chapter 3, “Installation.”](#)





## Product Overview

---

The Catalyst 3750 family of switches—also referred to as the *switches*—are stackable Ethernet switches to which you can connect devices like Cisco IP Phones, Cisco Wireless Access Points workstations, and other network devices such as servers, routers, and other switches. This chapter provides a functional overview of the Catalyst 3750 switch models. These topics are included:

- [Features, page 2-1](#)
- [Front Panel Description, page 2-3](#)
- [Rear Panel Description, page 2-14](#)
- [Management Options, page 2-18](#)

## Features

The switches can be deployed as backbone switches, aggregating 10BASE-T, 100BASE-TX, and 1000BASE-T Ethernet traffic from other network devices. Refer to the switch software configuration guide for examples showing how you might deploy the switches in your network.

Figure 2-1 through Figure 2-5 show the Catalyst 3750 switches.

These are the switch features:

- Hardware
  - Catalyst 3750-24TS—24 10/100 Ethernet ports and 2 small form-factor pluggable (SFP) module slots
  - Catalyst 3750G-24T—24 10/100/1000 Ethernet ports
  - Catalyst 3750G-24TS—24 10/100/1000 Ethernet ports and 4 SFP module slots
  - Catalyst 3750-48TS—48 10/100 Ethernet ports and 4 SFP module slots
  - Catalyst 3750G-12S—12 SFP module slots
- The switches support these SFP modules:
  - 1000BASE-SX
  - 1000BASE-LX
  - 1000BASE-T



---

**Note** When installed in Catalyst 3750 switches, 1000BASE-T small form-factor pluggable (SFP) modules can either operate at 10, 100, or 1000 Mbps in full-duplex mode or in half-duplex mode at 10 or 100 Mbps.

---

- Configuration
  - For 10/100 ports, autonegotiates the speed and duplex settings
  - For 10/100/1000 ports, autonegotiates the speed and supports only full-duplex mode
- The Catalyst 3750 switches support stacking. You can stack up to nine switches in a stack by cabling the StackWise ports. StackWise ports are not user-configurable.
- Switches are hot-swappable
- Power redundancy
  - Connection for optional Cisco RPS 300 redundant power system that operates on AC input and supplies backup DC power output to the Catalyst 3750-24TS, 3750G-24T, 3750-48TS, and 3750G-12S switches.



**Note** The Cisco RPS 300 does not support the Catalyst 3750G-24TS switch.

- Connection for optional Cisco RPS 675 redundant power system that operates on AC input and supplies backup DC power output to the family of Catalyst 3750 switches.

## Front Panel Description

The Catalyst 3750-24TS 10/100 ports are numbered 1 through 24. The ports are grouped in pairs. The first member of the pair (port 1) is above the second member (port 2) on the far left, as shown in [Figure 2-1](#). Port 3 is above port 4, and so on. The SFP port numbers are numbered 1 (left) and 2 (right).

**Figure 2-1 Catalyst 3750-24TS Front Panel**

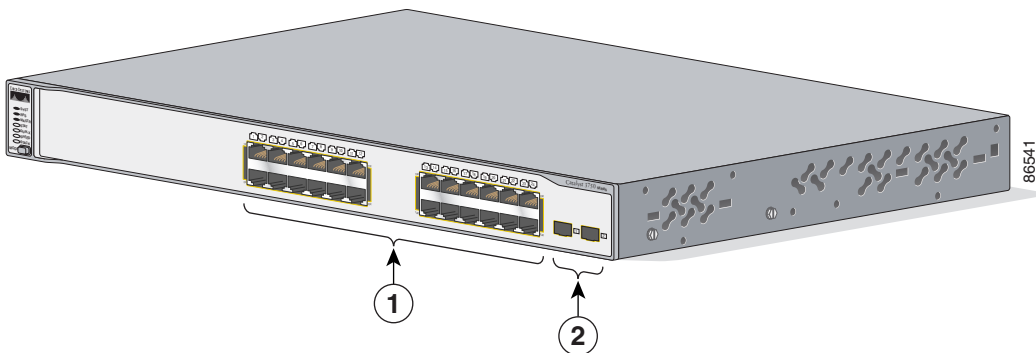

<b>1</b>	10/100 ports	<b>2</b>	SFP module ports
----------	--------------	----------	------------------

The 10/100/1000 ports on the Catalyst 3750G-24T and 3750G-24TS are grouped in pairs. The first member of the pair (port 1) is above the second member (port 2) on the left, as shown in [Figure 2-2](#) and [Figure 2-3](#). Port 3 is above port 4, and so on. In [Figure 2-3](#) the SFP port are numbered 25 to 28.

Figure 2-2 Catalyst 3750G-24T Front Panel

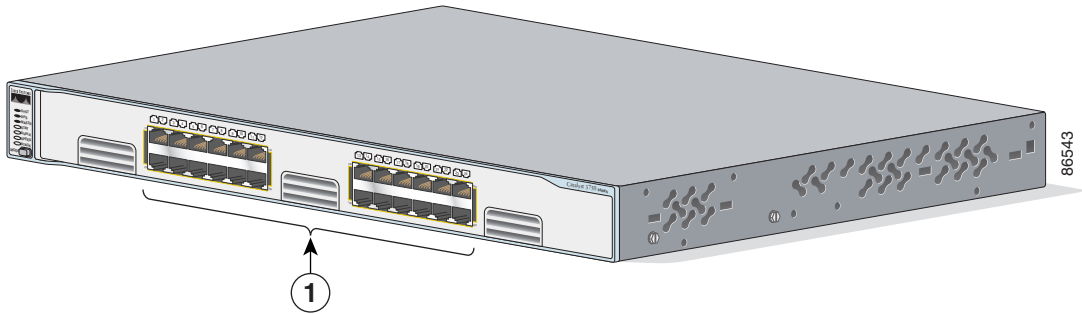

<b>1</b>	10/100/1000 ports
----------	-------------------

Figure 2-3 Catalyst 3750G-24TS Front Panel

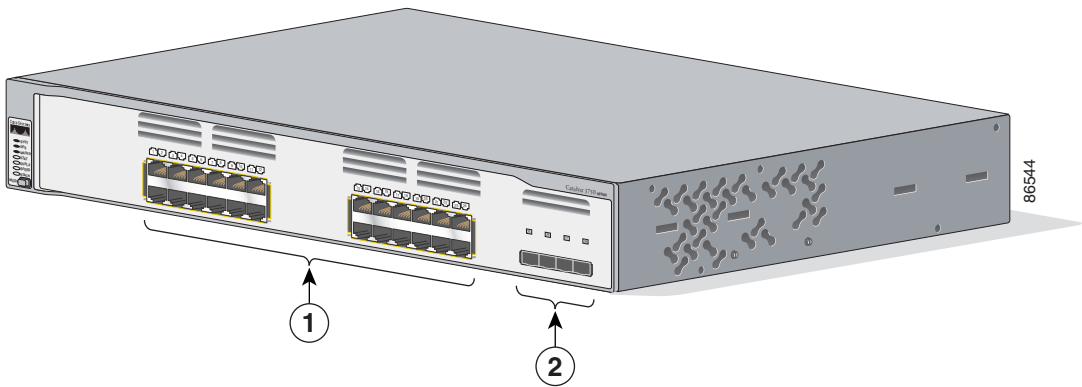

<b>1</b>	10/100 ports	<b>2</b>	SFP module ports
----------	--------------	----------	------------------

The Catalyst 3750G-12S SFP module slots are numbered 1 through 12. The ports are grouped in three sets of four, as shown in [Figure 2-4](#).

Figure 2-4 Catalyst 3750G-12S Front Panel

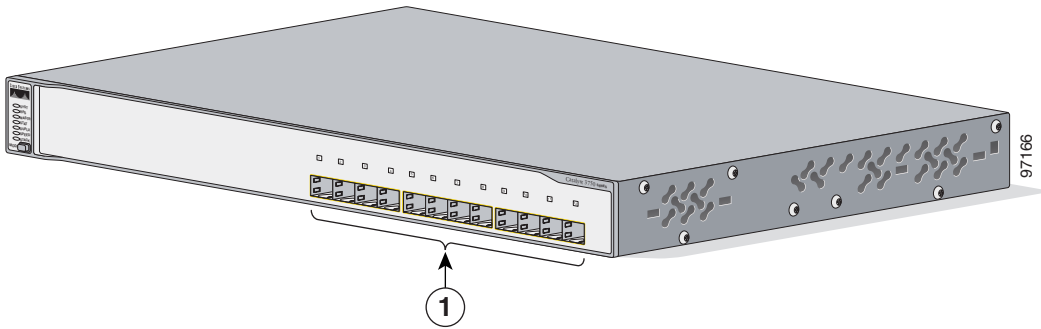

<b>1</b>	SFP module ports
----------	------------------

The Catalyst 3750-48TS 10/100 ports are numbered 1 through 48. The ports are grouped in pairs. The first member of the pair (port 1) is above the second member (port 2) on the far left, as shown in Figure 2-1. Port 3 is above port 4, and so on. The SFP port numbers are 1 (top) and 2 (bottom) and so on.

Figure 2-5 Catalyst 3750-48TS Front Panel

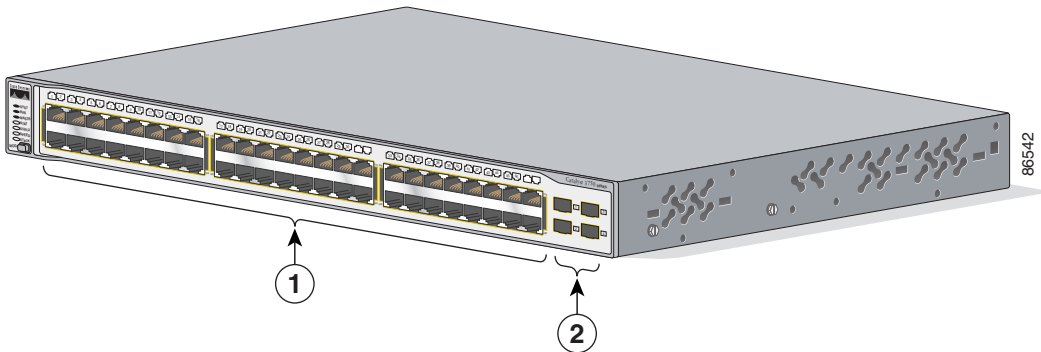

<b>1</b>	10/100 ports	<b>2</b>	SFP module ports
----------	--------------	----------	------------------

## 10/100 and 10/100/1000 Ports

You can set the 10/100 on the switch to operate in any combination of half duplex, full duplex, 10 Mbps or 100 Mbps. You can set the 10/100/1000 ports to operate in 10 Mbps, 100 Mbps, or 1000 Mbps in full duplex. You can also set these ports for speed and duplex autonegotiation in compliance with IEEE 802.3ab. (The default setting is autonegotiate.) When set for autonegotiation, the port senses the speed and duplex settings of the attached device and advertises its own capabilities. If the connected device also supports autonegotiation, the switch port negotiates the best connection (that is, the fastest line speed that both devices support and full-duplex transmission if the attached device supports it) and configures itself accordingly. In all cases, the attached device must be within 328 feet (100 meters).

**Note**

---

100BASE-TX and 1000BASE-T traffic requires Category 5 cable. 10BASE-T traffic can use Category 3 or Category 4 cables.

When connecting the switch to workstations, servers, routers, and Cisco IP Phones, be sure that the cable is a straight-through cable. When connecting the switch to switches or hubs, use a crossover cable. When using a straight-through or crossover cable for 1000BASE-T connections, be sure to use a twisted four-pair, Category 5 cable for proper operation. Pinouts for the cables are described in [Appendix B, “Connector and Cable Specifications.”](#)

---

**Note**

---

On switches running Cisco IOS Release 12.1(14)EA1 or later, you can use the **mdix auto** command in the CLI to enable the automatic crossover feature. When the automatic crossover feature is enabled, the switch detects the required cable type for copper Ethernet connections and configures the interfaces accordingly. Therefore, you can use either a crossover or a straight-through cable for connections to a copper 10/100 or 10/100/1000 port on the switch, regardless the type of device on the other end of the connection.

The automatic crossover feature is disabled by default. For configuration information for this feature, refer to the switch software configuration guide or the switch command reference.

---

## SFP Module Slots

The SFP module slots support the SFP modules listed in the Catalyst 3750 release notes.

## SFP Modules

The Catalyst 3750 switch uses Gigabit Ethernet SFP modules to establish fiber-optic connections. These transceiver modules are field-replaceable, providing the uplink interfaces when inserted in an SFP module slot. You can use the SFP modules for Gigabit uplink connections to other switches. You use fiber-optic cables with LC or MT-RJ connectors to connect to a fiber-optic SFP module. You use Category 5 cable with RJ-45 connectors to connect to a copper SFP module.

The Catalyst 3750 models support these Cisco SFP options:

- 1000BASE-LX
- 1000BASE-SX
- 1000BASE-T

For more information about these SFP modules, refer to your SFP module documentation.

## LEDs

You can use the switch LEDs to monitor switch activity and its performance. [Figure 2-6](#) shows the Catalyst 3750-24TS, 3750G-24T, 3750G-24TS, 3750G-12S, and 3750-48TS LEDs and the Mode button that you use to select one of the port modes.

All of the LEDs described in this section are visible on the Cluster Management Suite (CMS) home page. The switch software guide describes how to use CMS to configure and monitor individual switches and switch clusters.

**Figure 2-6 Catalyst 3750 LEDs**

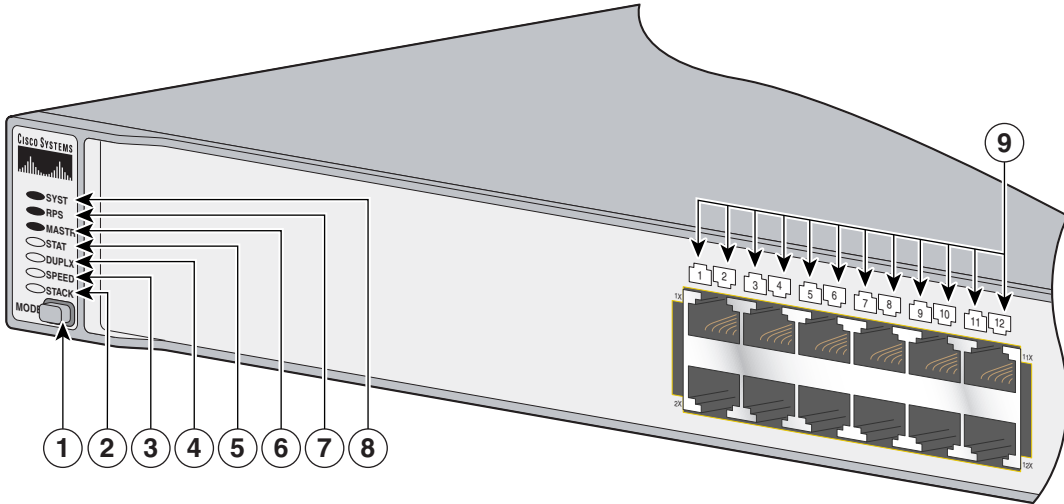

86545

1	Mode button	6	Master LED
2	Stack LED	7	RPS LED
3	Speed LED	8	System LED
4	Duplex LED	9	Port LED
5	Status LED		



## System LED

The System LED shows whether the system is receiving power and is functioning properly. [Table 2-1](#) lists the LED colors and their meanings.

**Table 2-1 System LED**

Color	System Status
Off	System is not powered on.
Green	System is operating normally.
Amber	System is receiving power but is not functioning properly.

For information on the System LED colors during power-on self-test (POST), see the [“Connecting to the 10/100 and 10/100/1000 Ports”](#) section on page 3-44.

## RPS LED

The RPS LED shows the RPS status. [Table 2-2](#) lists the LED colors and their meanings.

**Table 2-2 RPS LED**

Color	RPS Status
Off	RPS is off or not properly connected.
Green	RPS is connected and ready to provide back-up power, if required.
Flashing green	RPS is connected but is unavailable because it is providing power to another device (redundancy has been allocated to a neighboring device).
Amber	The RPS is in standby mode or in a fault condition. Press the Standby/Active button on the RPS, and the LED should turn green. If it does not, the RPS fan could have failed. Contact Cisco Systems.
Flashing amber	The internal power supply in a switch has failed, and the RPS is providing power to the switch (redundancy has been allocated to this device).

For more information about the Cisco RPS 300, refer to the *Cisco RPS 300 Redundant Power System Hardware Installation Guide*. For more information about the Cisco RPS 675, refer to the *Cisco RPS 675 Redundant Power System Hardware Installation Guide*.

**Note**

The Cisco RPS 300 does not support the Catalyst 3750G-24TS switches.

## Master LED

The Master LED shows the stack master status. [Table 2-2](#) lists the LED colors and their meanings.

**Table 2-3 Master LED**

Port Mode	Description
Off	Switch is not the stack master.
Green	Switch is the stack master or a standalone switch.
Amber	An error occurred when the switch was selecting the stack master switch or a stack error.

## Port LEDs and Modes

Each RJ-45 port and SFP module slot has a port LED. These port LEDs, as a group or individually, display information about the switch and about the individual ports. The port modes determine the type of information displayed through the port LEDs. [Table 2-4](#) lists the mode LEDs and their associated port mode and meaning.

To select or change a mode, press the Mode button until the desired mode is highlighted. When you change port modes, the meanings of the port LED colors also change. [Table 2-5](#) explains how to interpret the port LED colors in different port modes.

If your switches are stacked and you press the Mode button on any one of the switches in the stack, all the switches in the stack change to display the same selected mode. For example, if you press the mode button on the stack master to display SPEED, all the other switches in the stack also display SPEED.

Table 2-4 Port Mode LEDs

Mode LED	Port Mode	Description
STAT	Port status	The port status. This is the default mode.
DUPLX	Port duplex mode	The port duplex mode: full duplex or half duplex. <b>Note</b> The 10/100/1000 ports operate only in full-duplex mode.
SPEED	Port speed	The port operating speed: 10, 100, or 1000 Mbps.
STACK	Stack Member Status StackWise Port Status	The stack member status. The StackWise port status. See the “Stack LED” section on <a href="#">page 2-12</a> for more information.

Table 2-5 Meaning of LED Colors in Different Modes on the Switch

Port Mode	LED Color	Meaning
STAT (port status)	Off	No link, or port was administratively shut down.
	Green	Link present.
	Flashing green	Activity. Port is transmitting or receiving data.
	Alternating green-amber	Link fault. Error frames can affect connectivity, and errors such as excessive collisions, CRC errors, and alignment and jabber errors are monitored for a link-fault indication.
	Amber	Port is blocked by Spanning Tree Protocol (STP) and is not forwarding data. <b>Note</b> After a port is reconfigured, the port LED can remain amber for up to 30 seconds as STP checks the switch for possible loops.
	Flashing amber	Port is blocked by STP and is transmitting or receiving packets.
DUPLX (duplex)	Off	Port is operating in half duplex.
	Green	Port is operating in full duplex.

Table 2-5 Meaning of LED Colors in Different Modes on the Switch (continued)

Port Mode	LED Color	Meaning
SPEED	<b>10/100 and 10/100/1000 ports</b>	
	Off	Port is operating at 10 Mbps.
	Green	Port is operating at 100 Mbps.
	Flashing green	Port is operating at 1000 Mbps.
	<b>SFP ports</b>	
	Off	Port is operating at 10 Mbps.
	Green	Port is operating at 100 Mbps.
	Flashing green	Port is operating at 1000 Mbps.  <b>Note</b> When installed in Catalyst 3750 switches, 1000BASE-T SFP modules can operate at 10, 100, or 1000 Mbps in full-duplex mode or in half-duplex mode at 10 or 100 Mbps.
STACK (stack member)	Off	No stack member corresponding to that member number.
	Flashing Green	Selected switch's member number.
	Green	Member number of other stack member switches.

## Stack LED

The stack LED shows the sequence of member switches in a stack. Up to nine switches can be members of a stack. The first nine port LEDs show the position of a switch in a stack. [Figure 2-7](#) shows a magnified view of the LEDs on the first switch, which is member number 8 of the stack. For example, if you press the Mode button to select the stack member on this switch, the port LED 8 flashes green because this represents the member number of this switch. The port LEDs 3 and 4 are solid green, as these represent the member numbers of other switches in the stack. The other port LEDs are off because there are no more members in the stack.

When the stack LED is selected, the representative stack LEDs are green when the StackWise ports (on the switch rear panel) are up, and the representative stack LEDs are amber when the ports are down:

- SFP port LEDs 1 and 2 on the Catalyst 3750-24TS switch show the status for StackWise ports 1 and 2, respectively.

- SFP port LEDs 3 and 4 on the Catalyst 3750-48TS switch show the status for StackWise ports 1 and 2, respectively.
- SFP port LEDs 27 and 28 on the Catalyst 3750G-24TS switch show the status for StackWise ports 1 and 2, respectively.
- The 10/100/1000 port LEDs 23 and 24 on the Catalyst 3750G-24T switch show the status for StackWise ports 1 and 2, respectively.
- SFP port LEDs 11 and 12 on the Catalyst 3750G-12S switch show the status for StackWise ports 1 and 2, respectively.

**Note**

If both the port LEDs are green on all the switches in the stack, the stack is operating at full bandwidth (32 Gbps). If any of the port LEDs are not green, the stack is not operating at full bandwidth.

**Figure 2-7 Stack LED**

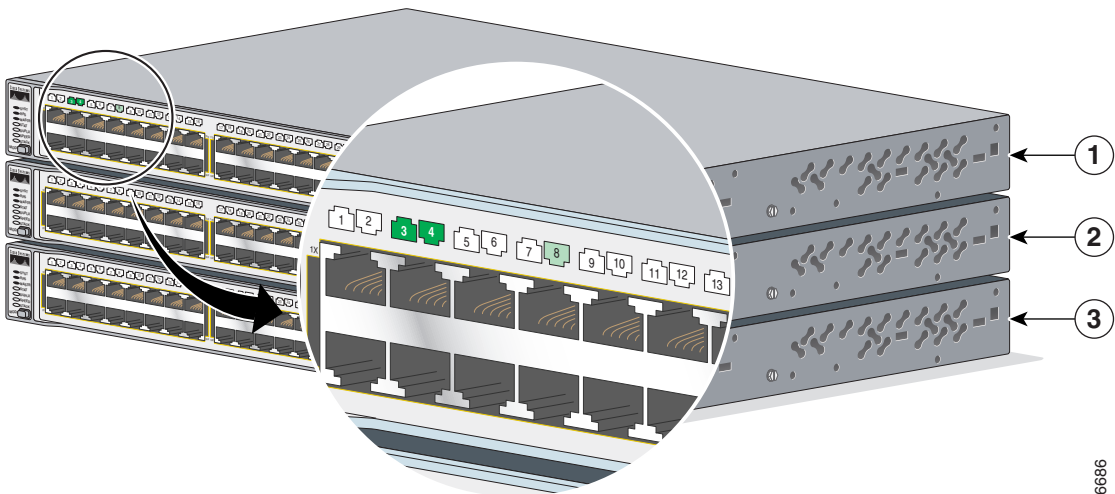

939393

<b>1</b>	Stack member 8	<b>3</b>	Stack member 4
<b>2</b>	Stack member 3		

# Rear Panel Description

The switch rear panels have an AC power connector, an RPS connector, an RJ-45 console port, and two StackWise ports. (See [Figure 2-8](#) and [Figure 2-9](#).)

**Figure 2-8** Catalyst 3750-24TS, 3750G-24T, 3750G-12S, and 3750-48TS Rear Panel

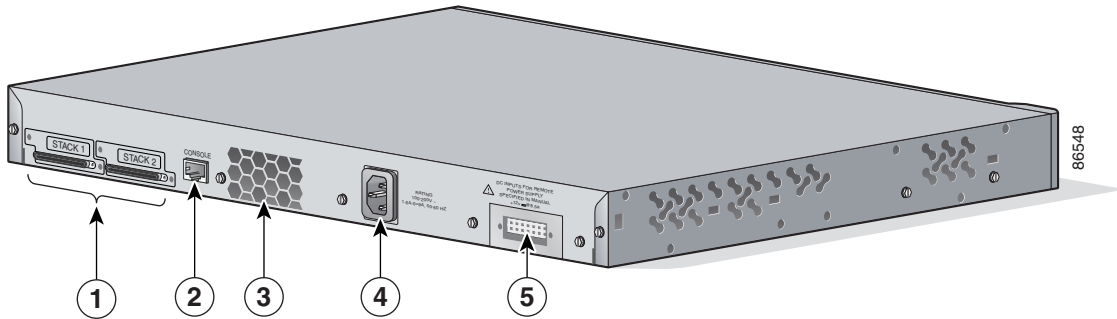

<b>1</b>	StackWise ports	<b>4</b>	AC power connector
<b>2</b>	RJ-45 console port	<b>5</b>	RPS connector
<b>3</b>	Fan exhaust		

Figure 2-9 Catalyst 3750G-24TS Rear Panel

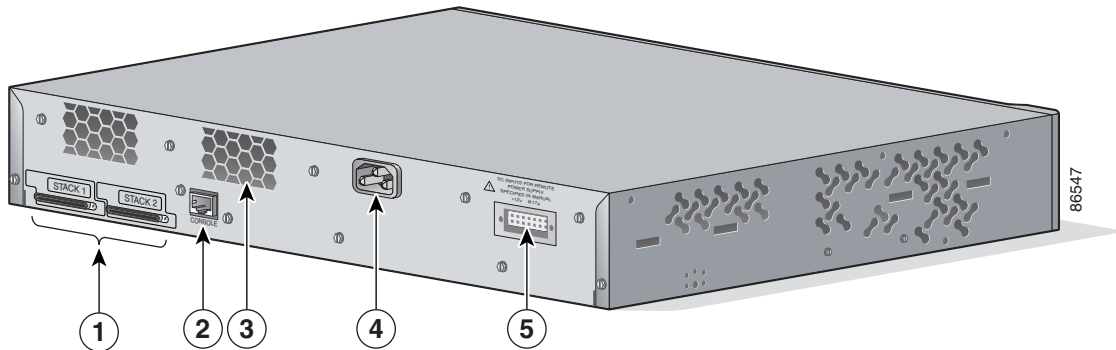

1	StackWise ports	4	AC power connector
2	RJ-45 console port	5	RPS connector
3	Fan exhaust		

## StackWise Ports

The Catalyst 3750 switch ships with a 0.5-meter StackWise cable (72-2632-XX CABASY) that you can use to connect the StackWise ports.



### Caution

Use only approved cables (CAB-STACK-50CM, CAB-STACK-1M, or CAB-STACK-3M), and connect only to similar Cisco equipment. Equipment might be damaged if connected to other nonapproved Cisco cables or equipment.

You can order these StackWise cables from your Cisco sales representative:

- CAB-STACK-50CM= (0.5-meter cable)
- CAB-STACK-1M= (1-meter cable)
- CAB-STACK-3M= (3-meter cable)

## Power Connectors

The switch is powered through the internal power supply. You can also connect the Cisco RPS 300 or the Cisco RPS 675 to provide backup power if the switch internal power supply should fail.

**Note**

---

The Catalyst 3750 switch and the Cisco RPS 300 or RPS 675 should be connected to the same AC power source.

---

## Internal Power Supply Connector

The internal power supply is an autoranging unit that supports input voltages between 100 and 240 VAC. Use the supplied AC power cord to connect the AC power connector to an AC power outlet.

## Cisco RPS Connector

Specific Cisco RPS modes support specific Catalyst 3750 switches:

- Cisco RPS 300 (model PWR300-AC-RPS-N1) supports the Catalyst 3750-24TS, 3750G-24T, 3750G-12S, and 3750-48TS switches.
- Cisco RPS 675 (model PWR675-AC-RPS-N1=) supports the Catalyst 3750 family of switches.

## Cisco RPS 300

The Cisco RPS 300 has two output levels: –48V and 12V with a total maximum output power of 300W. Use the supplied RPS connector cable to connect the RPS to the switch.

**Note**

---

The Cisco RPS 300 does not support the Catalyst 3750G-24TS switches.

---

**Warning**

---

**Attach only the Cisco RPS (model PWR300-AC-RPS-N1) to the RPS receptacle.**

---



The RPS is a redundant power system that can support six external network devices and provides power to one failed device at a time. It automatically senses when the internal power supply of a connected device fails and provides power to the failed device, preventing loss of network traffic. For more information on the Cisco RPS 300, refer to the *Cisco RPS 300 Redundant Power System Hardware Installation Guide*.

## Cisco RPS 675

The Cisco RPS 675 has two output levels: –48V and 12V with a total maximum output power of 675W. Use the supplied RPS connector cable to connect the RPS to the switch.



### Warning

---

**Attach only the Cisco RPS (model PWR675-AC-RPS-N1=) to the RPS receptacle.**

---

The RPS is a redundant power system that can support six external network devices and provides power to one failed device at a time. It automatically senses when the internal power supply of a connected device fails and provides power to the failed device, preventing loss of network traffic. For more information on the Cisco RPS 675, refer to the *Cisco RPS 675 Redundant Power System Hardware Installation Guide*.

## Console Port

You can connect the switch to a PC by means of the console port and the supplied RJ-45-to-DB-9 female cable. If you want to connect the switch console port to a terminal, you need to provide an RJ-45-to-DB-25 female DTE adapter. You can order a kit (part number ACS-DSBUASYN=) containing that adapter from Cisco. For console port and adapter pinout information, see the [“Connector and Cable Specifications” section on page B-1](#).

# Management Options

The Catalyst 3750 switches offer several management options:

- Cluster Management Suite (CMS)

CMS is a graphical user interface that can be launched from anywhere in your network through a web browser such as Netscape Communicator or Microsoft Internet Explorer. CMS is already installed on the switch, and no additional installation is required. From CMS, you can fully configure and monitor a switch or switch clusters, display network topologies to gather link information, and display switch images to modify switch- and port-level settings. For more information, refer to the switch software configuration guide on Cisco.com, and the online help for this application.

- Cisco IOS command-line interface (CLI)

The switch CLI is based on Cisco IOS software and is enhanced to support desktop-switching features. You can fully configure and monitor the switch and switch cluster members from the CLI. You can access the CLI either by connecting your management station directly to the switch console port or by using Telnet from a remote management station. Refer to the *Catalyst 3750 Switch Command Reference* on Cisco.com for more information.

- CiscoView application

The CiscoView device-management application displays the switch image that you can use to set configuration parameters and to view switch status and performance information. The CiscoView application, which you purchase separately, can be a standalone application or part of a Simple Network Management Protocol (SNMP) platform. Refer to the CiscoView documentation for more information.

- SNMP network management

You can manage switches from a SNMP-compatible management station that is running platforms such as HP OpenView or SunNet Manager. The switch supports a comprehensive set of Management Information Base (MIB) extensions and four Remote Monitoring (RMON) groups. Refer to the switch software configuration guide on Cisco.com and the documentation that came with your SNMP application for more information.

- Cisco Intelligence Engine 2100 (IE2100)

Cisco IE200 Series Configuration Registrar is a network management device that works with embedded CNS agents in the switch software. You can automate initial configurations and configuration updates by generating switch-specific configuration changes, sending them to the switch, executing the configuration change, and logging the results.

## Network Configurations

Refer to the switch software configuration guide on Cisco.com for network configuration concepts and examples of using the switch to create dedicated network segments and interconnecting the segments through Gigabit Ethernet connections.





# Switch Installation

---

This chapter describes how to start your switch and how to interpret the power-on self-test (POST) that ensures proper operation. It describes the planning and cabling considerations to keep in mind while planning your stack. It describes how to install the switch and make connections to the switch. Read the topics and perform the procedures in this order:

- [Preparing for Installation, page 3-1](#)
- [Verifying Switch Operation, page 3-8](#)
- [Planning the Stack, page 3-12](#)
- [Installing the Switch, page 3-17](#)
- [Connecting StackWise Cable to StackWise Ports, page 3-37](#)
- [Connecting to the 10/100 and 10/100/1000 Ports, page 3-44](#)
- [Connecting to an SFP Module, page 3-46](#)
- [Where to Go Next, page 3-50](#)

## Preparing for Installation

This section covers these topics:

- [Warnings, page 3-2](#)
- [EMC Regulatory Statements, page 3-4](#)
- [Installation Guidelines, page 3-6](#)

- [Verifying Package Contents, page 3-7](#)
- [Verifying Switch Operation, page 3-8](#)

## Warnings

These warnings are translated into several languages in [Appendix E, “Translated Safety Warnings.”](#)



Warning

---

**This equipment is to be installed and maintained by service personnel only as defined by AS/NZS 3260 Clause 1.2.14.3 Service Personnel.**

---



Warning

---

**Only trained and qualified personnel should be allowed to install or replace this equipment.**

---



Warning

---

**Read the installation instructions before you connect the system to its power source.**

---



Warning

---

**Before working on equipment that is connected to power lines, remove jewelry (including rings, necklaces, and watches). Metal objects will heat up when connected to power and ground and can cause serious burns or weld the metal object to the terminals.**

---



Warning

---

**Do not stack the chassis on any other equipment. If the chassis falls, it can cause severe bodily injury and equipment damage.**

---



Warning

---

**The plug-socket combination must be accessible at all times because it serves as the main disconnecting device.**

---

**Warning**

To prevent the switch from overheating, do not operate it in an area that exceeds the maximum recommended ambient temperature of 113° F (45° C). To prevent airflow restriction, allow at least 3 inches (7.6 cm) of clearance around the ventilation openings.

**Warning**

When installing or replacing the unit, the ground connection must always be made first and disconnected last.

**Warning**

This equipment is intended to be grounded. Ensure that the host is connected to earth ground during normal use.

**Warning**

Do not work on the system or connect or disconnect cables during periods of lightning activity.

**Warning**

Ultimate disposal of this product should be handled according to all national laws and regulations.

**Warning**

Attach only the Cisco RPS (model PWR675-AC-RPS-N1) to the RPS receptacle.

**Warning**

Class 1 laser product

**Warning**

Avoid exposure to the laser beam.

## EMC Regulatory Statements

This section includes specific regulatory statements about the Catalyst 3750 family of switches.

### U.S.A.

U.S. regulatory information for this product is in the front matter of this manual.

### Class A Notice for Taiwan and Other Traditional Chinese Markets

#### Warning

---

**This is a Class A Information Product, when used in residential environment, it may cause radio frequency interference, under such circumstances, the user may be requested to take appropriate countermeasures.**

警告 這是甲類資訊產品，在居住環境中使用時，可能會造成射頻干擾，在這種情況下，使用者會被要求採取某些適當的對策。

---

### Japan

This is a Class A product based on the standard of the Voluntary Control Council for Interference by Information Technology Equipment (VCCI). If this equipment is used in a domestic environment, radio disturbance may arise. When such trouble occurs, the user may be required to take corrective actions.

この装置は、情報処理装置等電波障害自主規制協議会（VCCI）の基準に基づくクラスA情報技術装置です。この装置を家庭環境で使用すると電波妨害を引き起こすことがあります。この場合には使用者が適切な対策を講ずるよう要求されることがあります。

46464



## Class A Notice for Korea

### Warning

---

**This is a Class A Device and is registered for EMC requirements for industrial use. The seller or buyer should be aware of this. If this type was sold or purchased by mistake, it should be replaced with a residential-use type.**

주의 A급 기기 이 기기는 업무용으로 전자파 적합 등록을 한 기기이  
오니 판매자 또는 사용자는 이 점을 주의하시기 바라며 만약  
잘못 판매 또는 구입하였을 때에는 가정용으로 교환하시기 바랍니다.

---

## Class A Notice for Hungary

### Warning

---

**This equipment is a class A product and should be used and installed properly according to the Hungarian EMC Class A requirements (MSZEN55022). Class A equipment is designed for typical commercial establishments for which special conditions of installation and protection distance are used.** Statement 256

### Figyelem

**Figyelmeztetés a felhasználói kézikönyv számára: Ez a berendezés "A" osztályú termék, felhasználására és üzembe helyezésére a magyar EMC "A" osztályú követelményeknek (MSZ EN 55022) megfelelően kerülhet sor, illetve ezen "A" osztályú berendezések csak megfelelő kereskedelmi forrásból származhatnak, amelyek biztosítják a megfelelő speciális üzembe helyezési körülményeket és biztonságos üzemelési távolságok alkalmazását.**

---

## Installation Guidelines

When determining where to place the switch, be sure to observe these requirements:

- For 10/100 and 10/100/1000 ports, cable lengths from the switch to connected devices are up to 328 feet (100 meters).
- Copper 1000BASE-T SFP modules use standard four twisted-pair, Category 5 cable at lengths up to 328 feet (100 meters).
- [Table 3-1](#) lists the cable specifications for 1000BASE-SX and 1000BASE-LX fiber-optic SFP connections. Each port must match the wave-length specifications on the other end of the cable, and the cable must not exceed the stipulated cable length for reliable communications.

**Table 3-1 Fiber-Optic SFP Module Port Cabling Specifications**

SFP Module	Wavelength (nanometers)	Fiber Type	Core Size (micron)	Modal Bandwidth (MHz/km)	Cable Distance
1000BASE-SX	850	MMF	62.5	160	722 feet (220 m)
			62.5	200	902 feet (275 m)
			50.0	400	1640 feet (500 m)
			50.0	500	1804 feet (550 m)
1000BASE-LX/LH	1300	MMF <sup>1</sup>	62.5	500	1804 feet (550 m)
			50.0	400	1804 feet (550 m)
		SMF	50.0	500	1804 feet (550 m)
			9/10	—	32,810 feet (10 km)

1. A mode-conditioning patch cord is required. Using an ordinary patch cord with MMF, 1000BASE-LX/LH SFP modules, and a short link distance can cause transceiver saturation, resulting in an elevated bit error rate (BER). When using the LX/LH SFP module with 62.5-micron diameter MMF, you must also install a mode-conditioning patch cord between the SFP module and the MMF cable on both the sending and receiving ends of the link. The mode-conditioning patch cord is required for link distances greater than 984 feet (300 m).

- Operating environment is within the ranges listed in [Appendix A, “Technical Specifications.”](#)
- Clearance to front and rear panels is such that
  - Front-panel indicators can be easily read.
  - Access to ports is sufficient for unrestricted cabling.

Make sure that there is access to the rear of the rack if you are planning to stack the switches. If you do not have access to the rear panel, make sure you cable the switches before you rack mount them.

- Rear-panel power connector is within reach of an AC power receptacle.
- Cabling is away from sources of electrical noise, such as radios, power lines, and fluorescent lighting fixtures. Make sure the cabling is safely away from other devices that might damage the cables.
- Airflow around the switch and through the vents is unrestricted.
- Temperature around the unit does not exceed 113°F (45°C).

**Note**

---

If the switch is installed in a closed or multirack assembly, the temperature around it might be greater than normal room temperature.

---

## Verifying Package Contents

**Note**

---

Carefully remove the contents from the shipping container, and check each item for damage. If any item is missing or damaged, contact your Cisco representative or reseller for support. Return all packing material to the shipping container, and save it.

---

The switch is shipped with these items:

- This *Catalyst 3750 Switch Hardware Installation Guide*
- *About the Catalyst 3750 Documentation* flyer
- AC power cord (AC-powered switches)
- One RJ-45-to-DB-9 adapter cable
- Mounting kit containing:
  - Four rubber feet for mounting the switch on a table
  - Two 19-inch rack-mounting brackets
  - Four Phillips flat-head screws for attaching the brackets to the switch (Catalyst 3750G-24TS switch)

- Six Phillips flat-head screws for attaching the brackets to the switch (Catalyst 3750-24TS, 3750G-24T, and 3750-48TS switches)
- Four Phillips machine screws for attaching the brackets to a rack
- One cable guide and one black Phillips machine screw for attaching the cable guide to one of the mounting brackets
- One redundant power system (RPS) connector cover (for wall mounting)
- Two Phillips pan-head screws (for attaching the RPS cover)
- Four Phillips truss-head screws (for wall-mounting brackets)
- StackWise cable: 0.5-meter, 1-meter, or 3-meter cable.



---

**Note** If you don't specify the length of the StackWise cable, the 0.5-meter cable is supplied by default.

---

## Verifying Switch Operation

Before installing the switch in a rack, on a wall, or on a table or shelf, you should power the switch and verify that the switch passes POST. These sections describe the steps required to connect a PC to the switch console port, and to power on the switch and observe POST:

- [Connecting a PC or Terminal to the Console Port, page 3-8](#)
- [Powering On the Switch and Running POST, page 3-10](#)

### Connecting a PC or Terminal to the Console Port

To connect a PC to the console port, use the supplied RJ-45-to-DB-9 adapter cable. To connect the switch console port to a terminal, you need to provide a RJ-45-to-DB-25 female DTE adapter. You can order a kit (part number ACS-DSBUASYN=) containing that adapter from Cisco. For console port and adapter pinout information, see the [“Cable and Adapter Specifications” section on page B-6](#).

The terminal-emulation software—frequently a PC application such as Hyperterminal or Procomm Plus—makes communication between the switch and your PC or terminal possible.

Follow these steps to connect the PC or terminal to the switch:

- 
- Step 1** Configure the baud rate and character format of the PC or terminal to match these console port default characteristics:
- 9600 baud
  - 8 data bits
  - 1 stop bit
  - No parity
  - None (flow control)
- After you have gained access to the switch, you can change the console baud rate through the **Administration > Console Baud Rate** window in the Cluster Management Suite (CMS).
- Step 2** Using the supplied RJ-45-to-DB-9 adapter cable, insert the RJ-45 connector into the console port, as shown in [Figure 3-1](#).
- Step 3** Attach the DB-9 female DTE adapter of the RJ-45-to-DB-9 adapter cable to a PC, or attach an appropriate adapter to the terminal.
- Step 4** Start the terminal-emulation program if you are using a PC or terminal.
-

Figure 3-1 Connecting to the Console Port

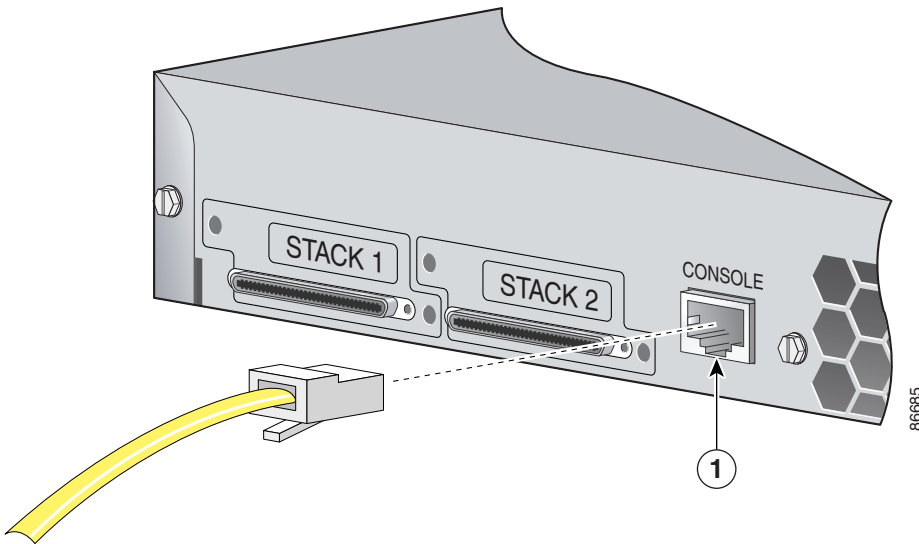

1	Console port
---	--------------

## Powering On the Switch and Running POST

If your configuration has an RPS, connect the switch and the RPS to the same AC power source. See the [“Power Connectors” section on page 2-16](#), and refer to the Cisco RPS documentation for more information.



### Note

Always put the RPS in standby mode when you are connecting devices to it and in active mode during normal operation.

To power on the switch, follow these steps:

- Step 1** Make sure that you have started the terminal emulation software program (such as ProComm, HyperTerminal, tip, or minicom) from your management station. See the [“Connecting a PC or Terminal to the Console Port” section on page 3-8](#) for information on connecting to the switch console port.
- Step 2** Connect one end of the AC power cord to the AC power connector on the switch.

**Step 3** Connect the other end of the power cord to an AC power outlet.

If you are installing the Catalyst 3750-24TS, 3750G-24T, 3750G-12S, or 3750-48TS switches, you can use the Cisco RPS 300.



**Warning**

---

**Attach only the Cisco RPS 300 (model PWR300-AC-RPS-N1) to the RPS receptacle**

---

If you are installing the Catalyst 3750-24TS, 3750G-24T, 3750G-24T, 3750G-12S, or 3750-48TS switches, you can use the Cisco RPS 675.



**Warning**

---

**Attach only the Cisco RPS 675 (model PWR675-AC-RPS-N1=) to the RPS receptacle**

---

As the switch powers on, it begins POST, a series of tests that run automatically to ensure that the switch functions properly. When the switch begins POST, the System, the RPS, the Master, the Status, the Duplex LEDs turn amber for 2 seconds. The Speed and the Stack LEDs turn green for 2 seconds.

As POST continues, the System LED flashes green, and the other LEDs turn off. The port LEDs turn solid green, and each port LED turns off as the test successfully checks each port. If there is a failure associated with a particular port, that port LED turns amber, and the system LED turns amber.

When POST is complete, only the SYST and STAT LEDs are green. The MASTR LED is also green on a single switch or on a stack master switch.

If a switch fails POST, the System LED turns amber. The RPS LED turns either solid amber or blinking amber. Other LEDs are off. If POST fails, see [Chapter 4, “Troubleshooting,”](#) to determine a course of action.

## Powering Off the Switch and Disconnecting the Console Port

Disconnect the power cord from the switch. Disconnect the cable from the switch console port. Install the switch in a rack, on a wall, or on a table or shelf as described in the [“Installing the Switch”](#) section on page 3-17.

# Planning the Stack

If you plan to stack your switches, read these sections:

- [Planning Considerations, page 3-12](#)
- [Powering Considerations, page 3-13](#)
- [Cabling Considerations, page 3-14](#)
- [Recommended Cabling Configurations, page 3-15](#)

## Planning Considerations

Before connecting the Catalyst 3750 switches in a stack, observe these planning considerations:

- Size of the switch. For switch dimensions, go to [Appendix A, “Technical Specifications.”](#) The Catalyst 3750-24TS, 3750G-24TS, and 3750-48TS switches are the same depth, and the Catalyst 3750G-12S and 3750G-24T switches are deeper than the other switches. Stacking switches of the same size together will make it easier to cable the switches.
- Length of cable. Depending on the configurations you have, you might need different sized cables. If you don't specify the length of the StackWise cable, the 0.5-meter cable is supplied by default. If you require the 1-meter cable or 3-meter cable, you can order it from your Cisco supplier. For cable numbers, see the [“StackWise Ports” section on page 2-15](#). The [“Recommended Cabling Configurations” section on page 3-15](#) provides examples of recommended configurations.

- Access to the rear ports for unrestricted cabling.

Make sure that there is access to the rear of the rack if you are planning to stack the switches. If you do not have access to the rear panel, make sure you cable the switches before you rack-mount them.

- For concepts and procedures to manage switch stacks, refer to the switch software configuration guide.



## Powering Considerations

Consider the following guidelines before you power the switches in a stack:

- The sequence in which the switches are initially powered on might affect the switch that becomes the stack master.
- If you want a particular switch to become the stack master, power on that switch first. This switch becomes the stack master and remains the stack master until a master re-election is required. After approximately 10 seconds power on the remaining switches in the stack.
- If you have no preference as to which switch becomes the stack master, power on the all the switches in the stack within a 10-second timeframe. These switches participate in the stack master election. Switches powered on after the 10-second timeframe do not participate in the election.
- Power off a switch before you add it to or remove it from an existing switch stack.

**Note**

---

For conditions that can cause a stack master re-election or to manually elect the stack master, refer to the “Managing Switch Stacks” chapter in the switch software configuration guide.

---

## Cabling Considerations

The illustrations in this section display cabling configuration examples that show the stack bandwidth and possible stack partitioning.

Figure 3-2 shows an example of a stack of Catalyst 3750 switches that provides full bandwidth and redundant StackWise cable connections.

**Figure 3-2 Example of a Stack with Full Bandwidth Connections**

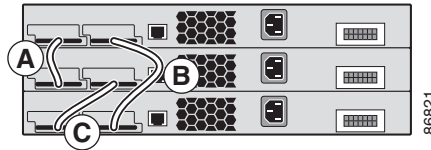

Figure 3-3 shows an example of a stack of Catalyst 3750 switches with incomplete StackWise cabling connections. This stack provides only half bandwidth and does not have redundant connections.

**Figure 3-3 Example of a Stack with Half Bandwidth Connections**

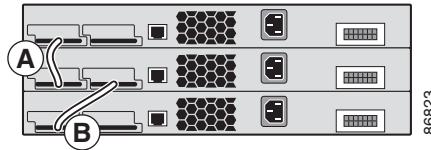
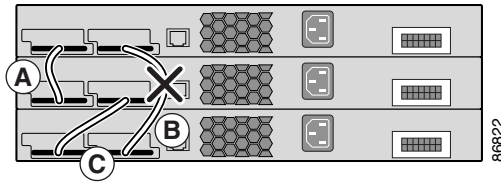
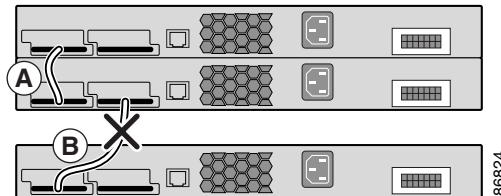

Figure 3-4 and Figure 3-5 show examples of stacks of Catalyst 3750 switches with failover conditions. In Figure 3-4, the StackWise cable is bad in link B; therefore, this stack provides only half bandwidth and does not have redundant connections. In Figure 3-5 link B is bad; therefore, this stack partitions into two stacks with switch 1 and switch 3 being stack masters.

**Figure 3-4** Example of a Stack with a Failover Condition**Figure 3-5** Example of a Partitioned Stack with a Failover Condition

## Recommended Cabling Configurations

This section describes the recommended cabling configurations for stacking the switches.

### Stacking Switches in Vertical Racks or on a Table

[Figure 3-6](#) is an example of a recommended configuration using the supplied 0.5-meter StackWise cable. In this example, the switches are stacked in a vertical rack or on a table. This configuration provides redundant connections.

**Figure 3-6** Stacking the Switches in a Vertical Rack or on a Table Using the 0.5-meter StackWise Cable

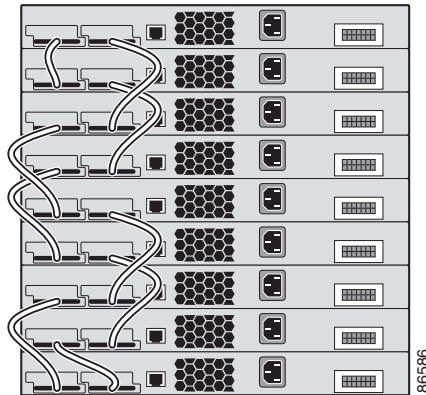

The configuration examples in [Figure 3-7](#) use the 3-meter StackWise cable in addition to the supplied 0.5-meter StackWise cable. This configuration also provides redundant connections.

**Figure 3-7** Stacking the Catalyst 3750 Switches in a Vertical Rack or on a Table Using 0.5-meter and 3-meter StackWise Cables

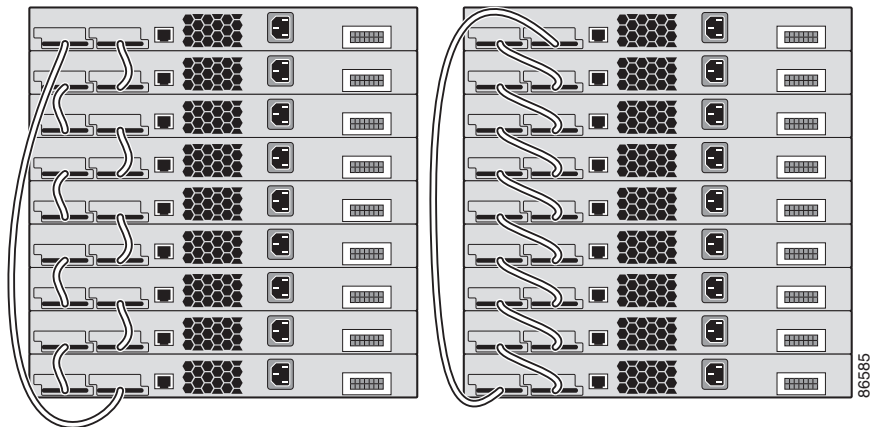

## Side-by-Side Mounting in a Rack or on a Wall

Figure 3-8 and Figure 3-9 are examples of recommended configurations where the switches are rack- or wall-mounted side-by-side. Use the 1-meter and 3-meter StackWise cables to connect the switches. These configuration provide redundant connections.

**Figure 3-8** Stacking up to Eight Switches in a Side-by-Side Mounting Configuration

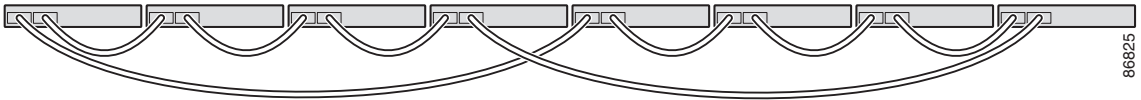

**Figure 3-9** Stacking Nine Switches in a Side-by-Side Mounting Configuration

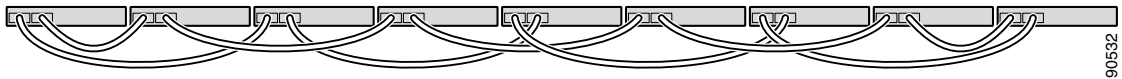

## Installing the Switch

This section describes these installation procedures:

- [Rack Mounting, page 3-18](#)
- [Wall Mounting, page 3-32](#)
- [Table or Shelf Mounting, page 3-36](#)

## Rack Mounting



### Warning

---

**To prevent bodily injury when mounting or servicing this unit in a rack, you must take special precautions to ensure that the system remains stable. The following guidelines are provided to ensure your safety:**

- **This unit should be mounted at the bottom of the rack if it is the only unit in the rack.**
  - **When mounting this unit in a partially filled rack, load the rack from the bottom to the top with the heaviest component at the bottom of the rack.**
  - **If the rack is provided with stabilizing devices, install the stabilizers before mounting or servicing the unit in the rack.**
- 

To install the switch in a 19-inch or 24-inch rack (24-inch racks require optional mounting hardware), follow the instructions described in these procedures:

- [Removing Screws from the Switch, page 3-19](#)
- [Attaching Brackets to the Catalyst 3750G-24TS Switch, page 3-20](#)
- [Attaching Brackets to the Catalyst 3750-24TS, 3750G-24T, 3750G-12S, and 3750-48TS Switches, page 3-25](#)
- [Mounting the Switch in a Rack, page 3-28](#)
- [Attaching the Cable Guide, page 3-30](#)



### Note

---

Installing the switch in a 24-inch rack requires an optional bracket kit not included with the switch. You can order a kit containing the 24-inch rack-mounting brackets and hardware from Cisco. For the Catalyst 3750G-24TS switches, order part number RCKMNT-3550-1.5RU=. For the Catalyst 3750-24TS, 3750G-24T, 3750G-12S, and 3750-48TS switches, order part number RCKMNT-1RU=.

---

## Removing Screws from the Switch

If you plan to install the switch in a rack, you must first remove screws in the switch chassis so that mounting brackets can be attached. [Figure 3-10](#) and [Figure 3-11](#) show how to remove the chassis screws in a one-rack-unit (RU) switch.

**Figure 3-10** Removing Screws from the Catalyst 3750-24TS, 3750G-24T, and 3750-48TS Switches

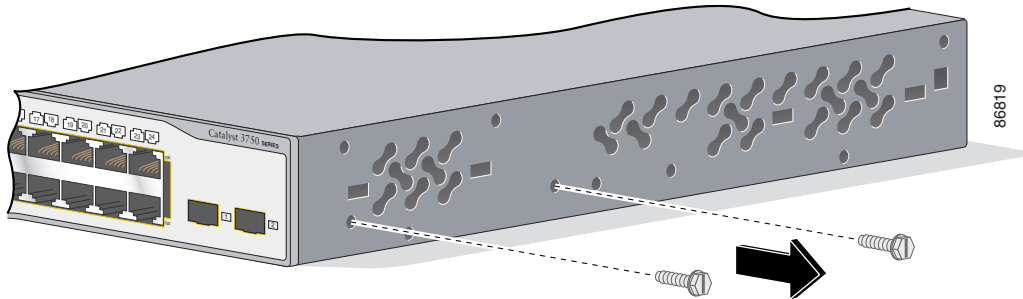

**Figure 3-11** Removing Screws from the Catalyst 3750G-12S Switch

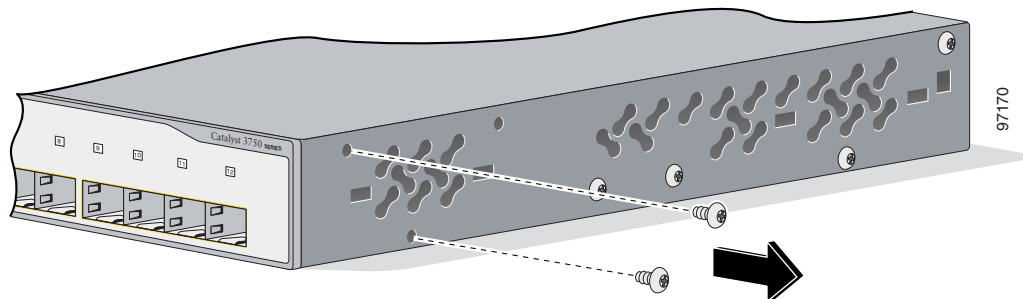
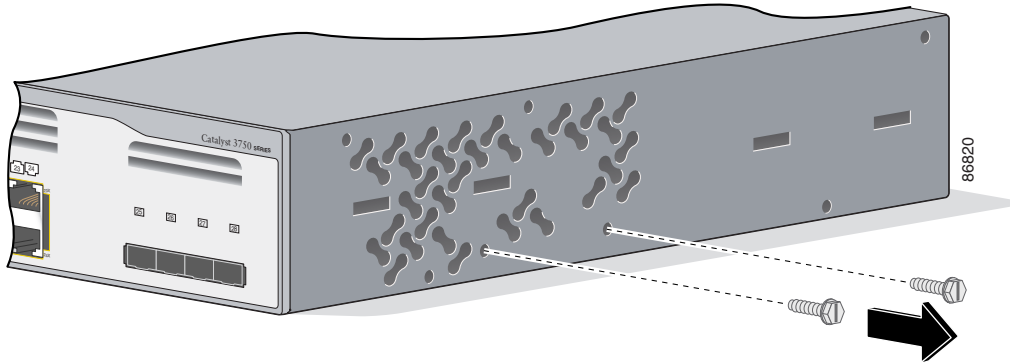

Figure 3-12 shows how to remove the chassis screws in a 1.5-RU switch.

**Figure 3-12 Removing Screws from the 3750G-24TS Switch**



## Attaching Brackets to the Catalyst 3750G-24TS Switch

The bracket orientation and the brackets that you use depend on whether you are attaching the brackets for a 19-inch or a 24-inch rack. For 19-inch racks, use part number 700-11523-XX; for 24-inch racks, use part number 700-12398-XX.

Figure 3-13 through Figure 3-18 show how to attach each type bracket to one side of the switch. Follow the same steps to attach the second bracket to the opposite side.

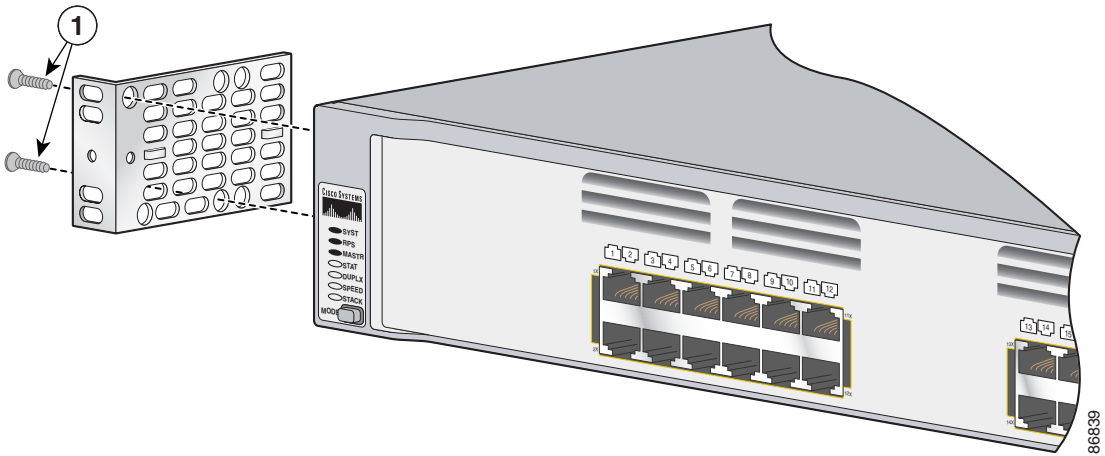

**Figure 3-13 Attaching Brackets for 19-inch Racks, Front Panel Forward**

<b>1</b>	Phillips flat-head screws
----------	---------------------------

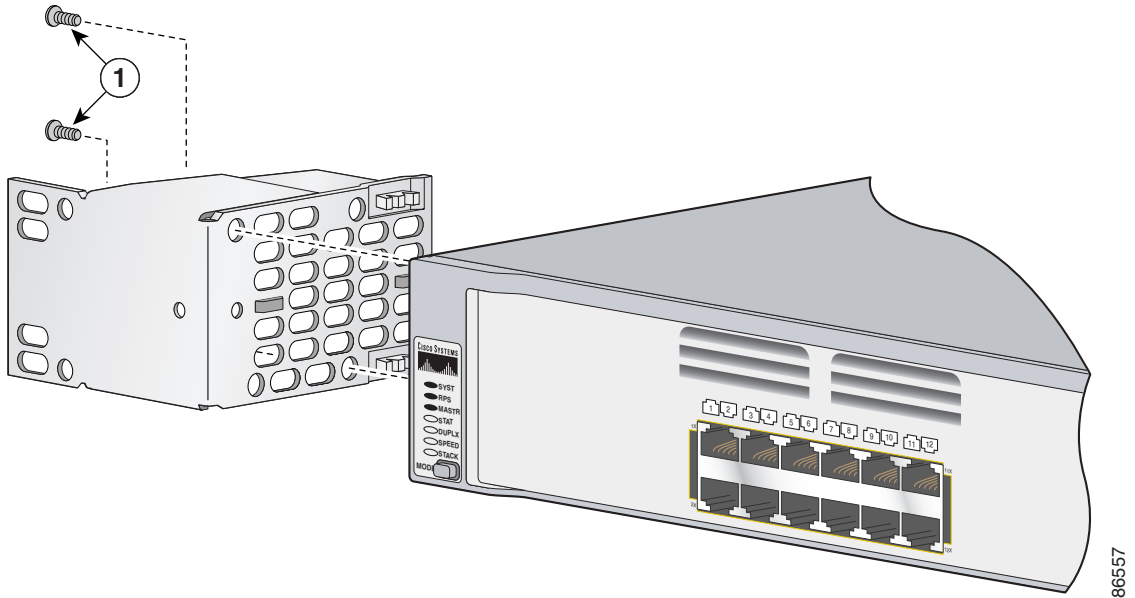
**Figure 3-14 Attaching Brackets for 24-Inch Racks, Front Panel Forward**

86557

- |          |                           |
|----------|---------------------------|
| <b>1</b> | Phillips flat-head screws |
|----------|---------------------------|

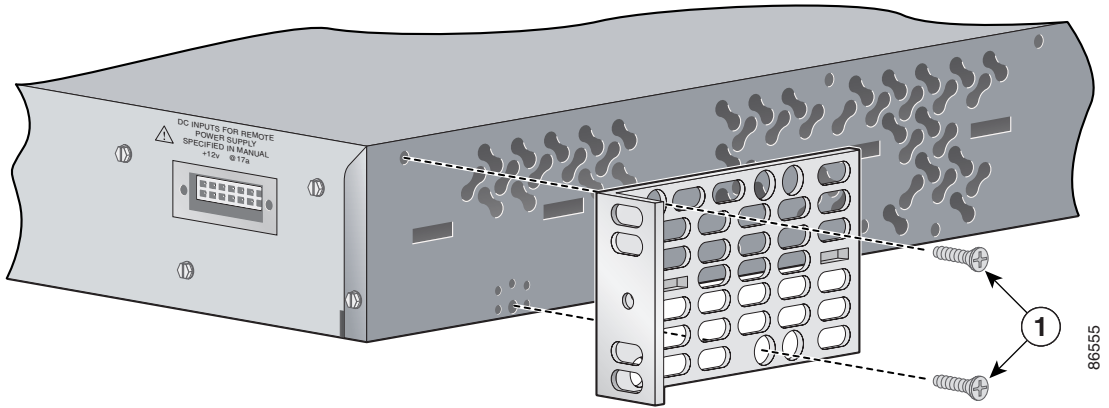
**Figure 3-15 Attaching Brackets for 19-Inch Racks, Rear Panel Forward**

---

**1** Phillips flat-head screws

---

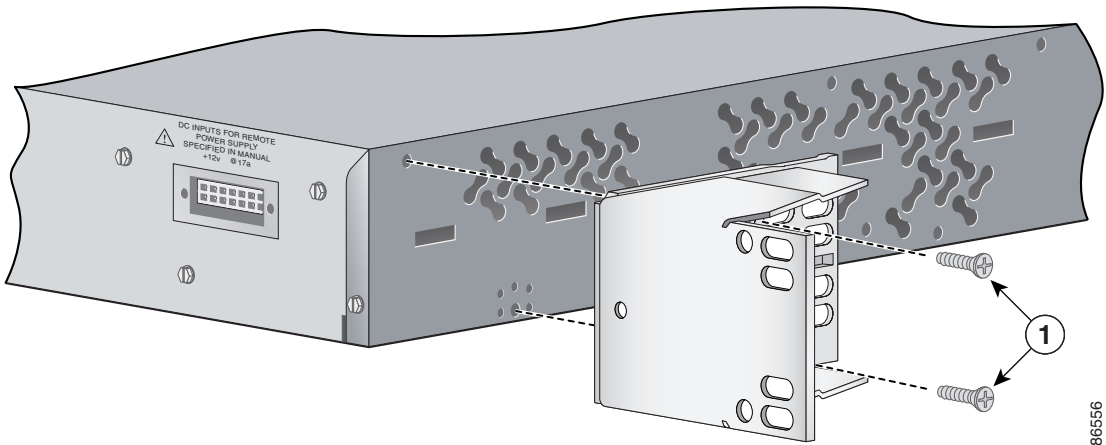
**Figure 3-16 Attaching Brackets for 24-Inch Racks, Rear Panel Forward**

---

**1** Phillips flat-head screws

---

## Installing the Switch

**Figure 3-17 Attaching Brackets for 19-Inch Telco Racks**

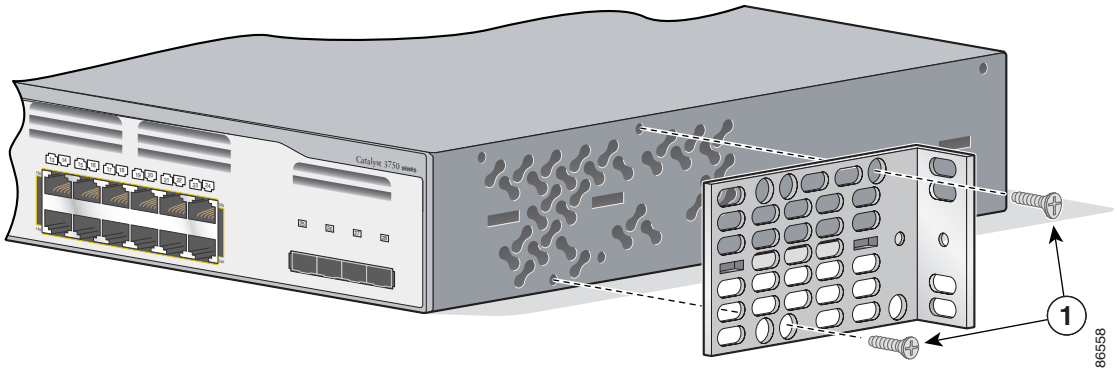

- 1 Phillips flat-head screws

**Figure 3-18 Attaching Brackets for 24-Inch Telco Racks**

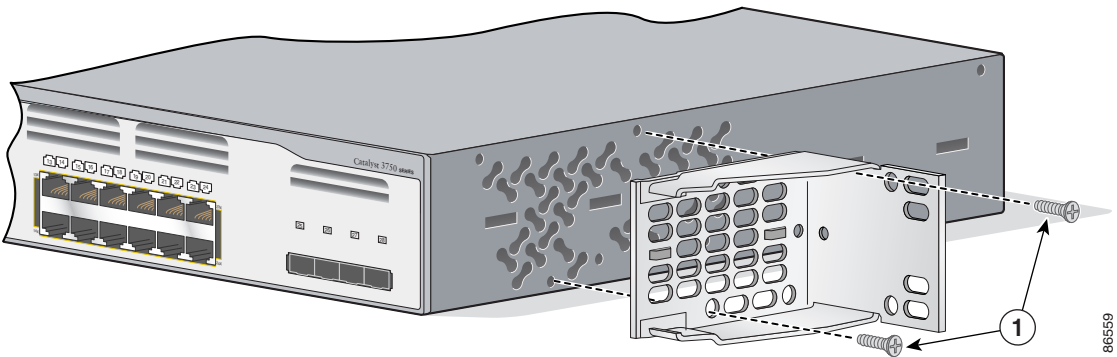

- 1 Phillips flat-head screws

## Attaching Brackets to the Catalyst 3750-24TS, 3750G-24T, 3750G-12S, and 3750-48TS Switches

The bracket orientation and the brackets you use depend on whether you are attaching the brackets for a 19-inch or a 24-inch rack. For 19-inch racks, use bracket part number 700-8209-XX; for 24-inch racks, use bracket part number 700-13248-XX. [Figure 3-19](#) through [Figure 3-25](#) show how to attach each type bracket to one side of the switch. Follow the same steps to attach the second bracket to the opposite side.

**Figure 3-19 Attaching Brackets for 19-Inch Racks, Front Panel Forward**

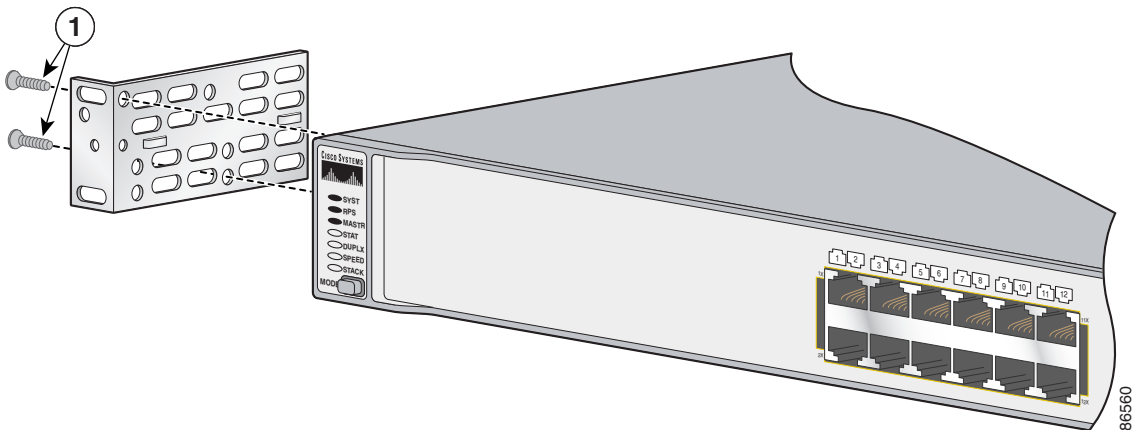

1	Phillips flat-head screws
---	---------------------------

## Installing the Switch

**Figure 3-20 Attaching Brackets for 24-Inch Racks, Front Panel Forward**

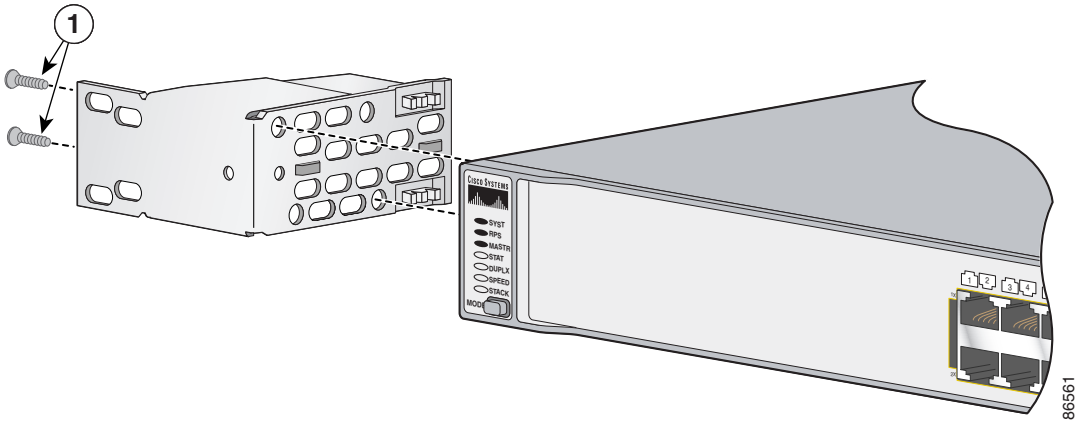

**1** Phillips flat-head screws

**Figure 3-21 Attaching Brackets for 19-Inch Racks, Rear Panel Forward**

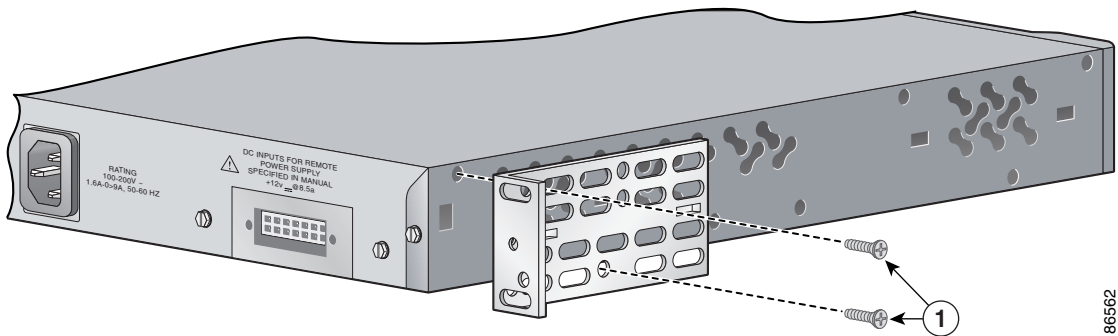

**1** Phillips flat-head screws

**Figure 3-22 Attaching Brackets for 24-Inch Racks, Rear Panel Forward**

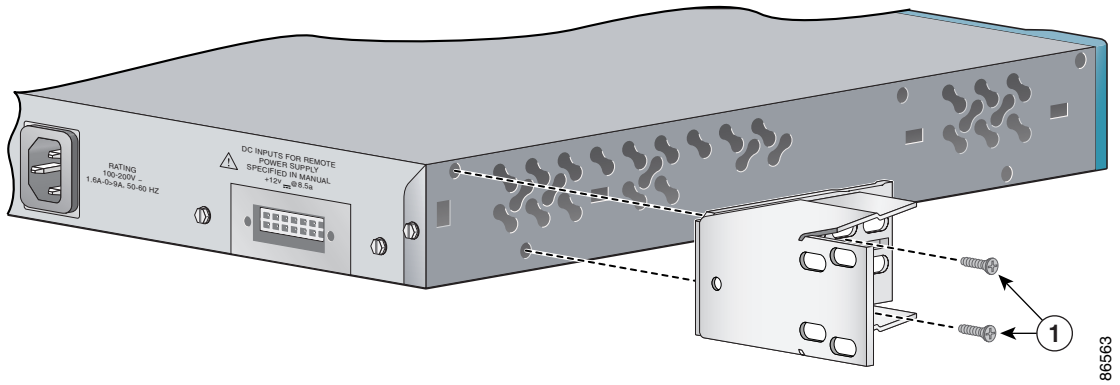

86563

- |          |                           |
|----------|---------------------------|
| <b>1</b> | Phillips flat-head screws |
|----------|---------------------------|

**Figure 3-23 Attaching Brackets for 19-Inch Telco Racks to Catalyst 3750-24TS, 3750G-24T, and 3750-48TS Switches**

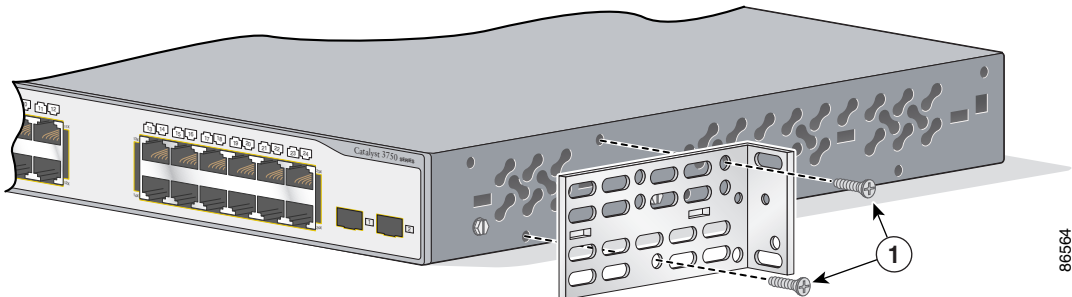

86564

- |          |                           |
|----------|---------------------------|
| <b>1</b> | Phillips flat-head screws |
|----------|---------------------------|

**Figure 3-24 Attaching Brackets for 19-Inch Racks to a Catalyst 3750G-12S switch**

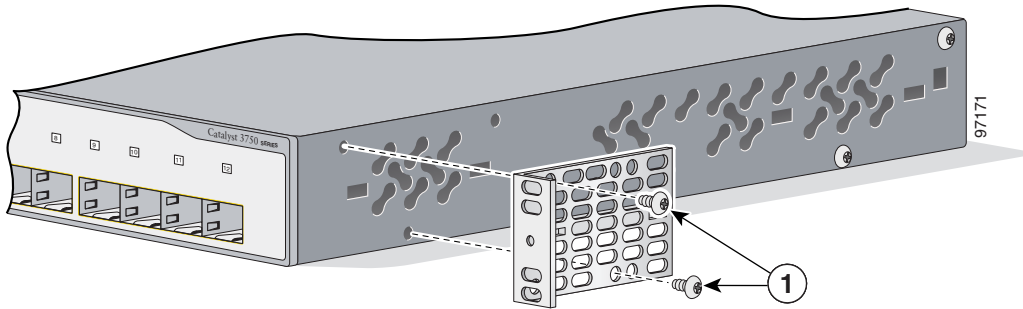

**1** Phillips truss-head screws

**Figure 3-25 Attaching Brackets for 24-Inch Telco Racks**

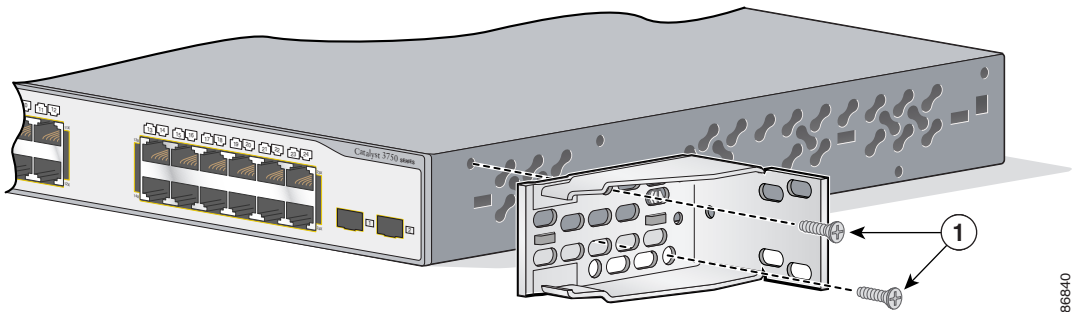

**1** Phillips flat-head screws

## Mounting the Switch in a Rack

After the brackets are attached to the switch, use the four supplied number-12 Phillips machine screws to securely attach the brackets to the rack, as shown in [Figure 3-26](#) and [Figure 3-27](#).

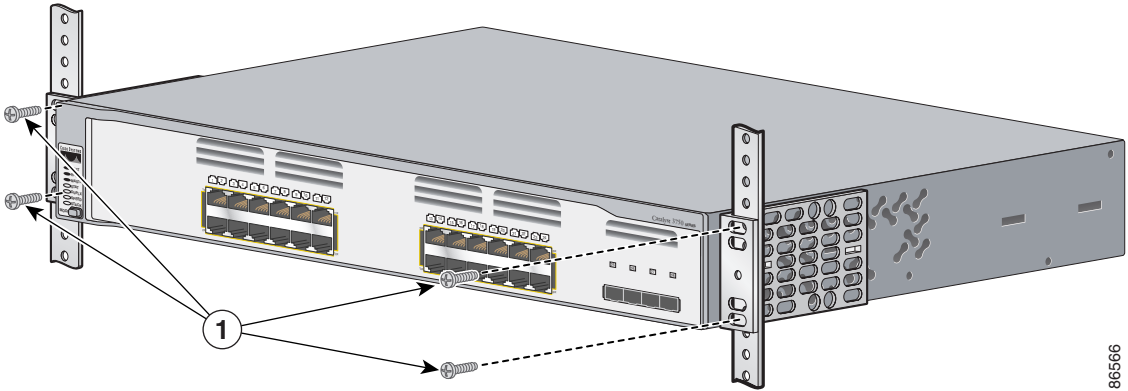

**Figure 3-26** Mounting the Catalyst 3750G-24TS Switch in a Rack

**1** Phillips machine screws

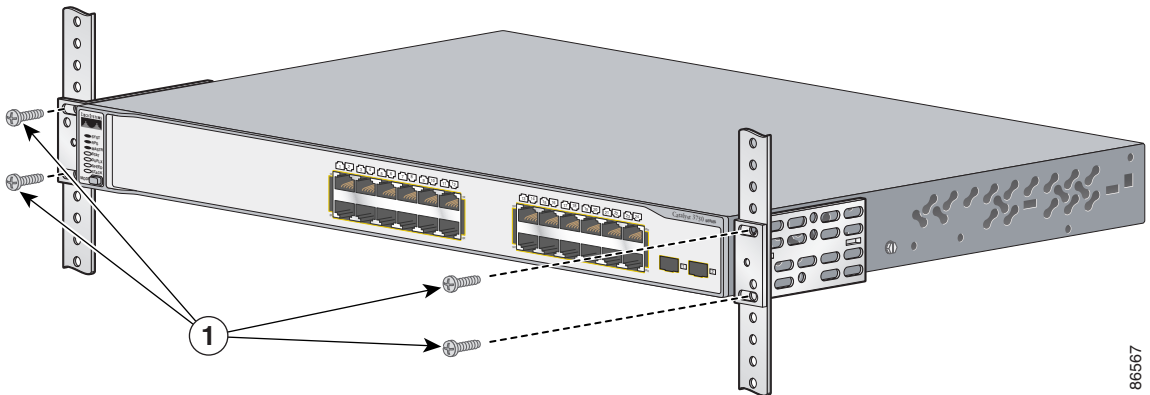
**Figure 3-27** Mounting the Catalyst 3750-24TS, 3750G-24T, 3750G-12S, and 3750-48TS Switches in a Rack

**1** Phillips machine screws

After the switch is mounted in the rack, you might need to perform these tasks to complete the installation, run the setup program, and access the switch:

- (Optional) Connect the switches in the stacks. See the [“Connecting StackWise Cable to StackWise Ports”](#) section on page 3-37.
- Connect to the console port, and start the emulation software. See the [“Connecting to the Console Port”](#) section on page 1-4 and the [“Starting the Terminal Emulation Software”](#) section on page 1-6.
- Power on the switch. See the [“Connecting to a Power Source”](#) section on page 1-6. If the switches are stacked, see the [“Powering Considerations”](#) section on page 3-13.
- Run the setup program. See the [“Completing the Setup Program”](#) section on page D-11.
- Connect to the front-panel ports. See the [“Connecting to the 10/100 and 10/100/1000 Ports”](#) section on page 3-44 and the [“Connecting to an SFP Module”](#) section on page 3-46 to complete the installation.

To use the CLI, enter commands at the *Switch>* prompt through the console port by using a terminal program or through the network by using Telnet. For configuration information, refer to the switch software configuration guide or the switch command reference. To use CMS, go to the [“Accessing the Switch from Your Browser”](#) section on page 1-13.

## Attaching the Cable Guide

We recommend attaching the cable guide to prevent the cables from obscuring the front panel of the switch and the other devices installed in the rack. Use the supplied black screw, as shown in [Figure 3-28](#) and [Figure 3-29](#) to attach the cable guide to the left or right bracket.

**Figure 3-28** Attaching the Cable Guide on the Catalyst 3750-24TS, 3750G-24T, 3750G-24TS, and 3750G-12S Switches

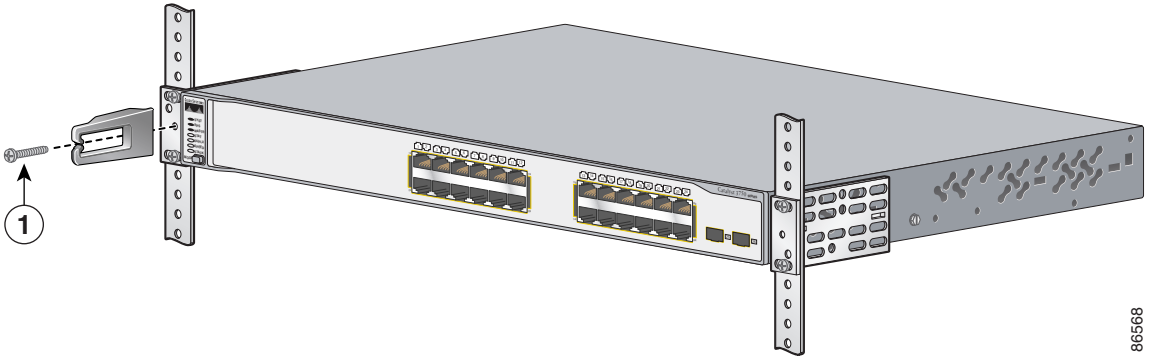

86568

<b>1</b>	Cable guide screws
----------	--------------------

**Note**

The Catalyst 3750-48 switch ships with a special cable guide, as shown in [Figure 3-29](#). This cable guide secures up to 48 cables. Use the supplied black screw to mount it on the left bracket.

**Figure 3-29** Attaching the Cable Guide on the Catalyst 3750-48TS Switch

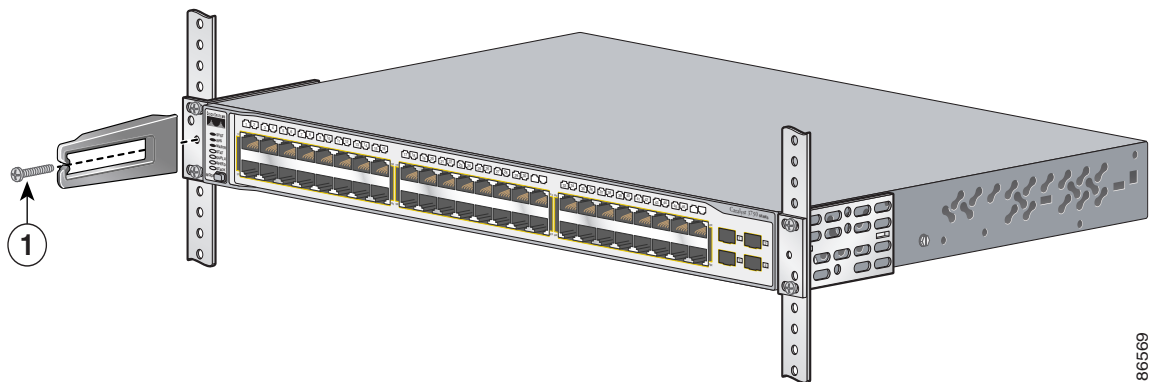

86569

<b>1</b>	Cable guide screws
----------	--------------------

## Wall Mounting

To install the switch on a wall, follow the instructions in these procedures:

- [Attaching the Brackets to the Switch for Wall-Mounting, page 3-32](#)
- [Attaching the RPS Connector Cover, page 3-33](#)
- [Mounting the Switch on a Wall, page 3-34](#)



### Note

The illustrations in this section show the Catalyst 3750G-24TS switch as an example. All the Catalyst 3750 switches are wall-mounted following the same procedures.

## Attaching the Brackets to the Switch for Wall-Mounting

[Figure 3-30](#) shows how to attach a 19-inch bracket to one side of the switch. Follow the same steps to attach the second bracket to the opposite side.

**Figure 3-30 Attaching the 19-inch Brackets for Wall-Mounting**

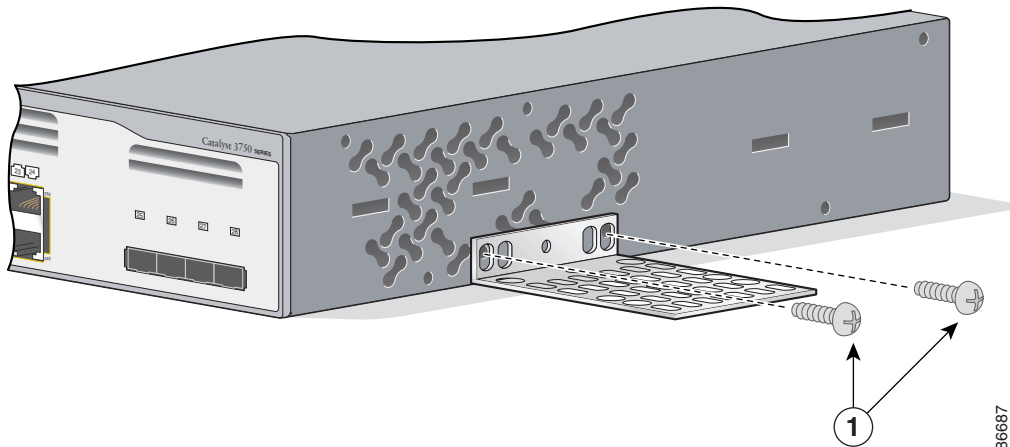

<b>1</b>	Phillips truss-head screws
----------	----------------------------

## Attaching the RPS Connector Cover

If you are not using an RPS with your switch, use the two Phillips pan-head screws to attach the RPS connector cover to the back of the switch, as shown in [Figure 3-31](#) and [Figure 3-32](#).



### Warning

If an RPS is not connected to the switch, install an RPS connector cover on the back of the switch.

**Figure 3-31 Attaching the RPS Connector Cover on the Catalyst 3750G-24TS Switch**

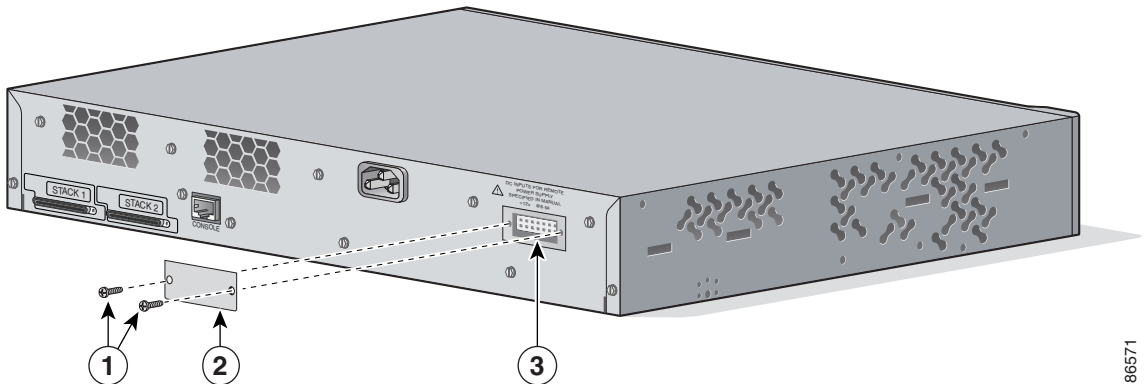

86571

<b>1</b>	Phillips pan-head screws	<b>3</b>	RPS connector
<b>2</b>	RPS connector cover		

**Figure 3-32** Attaching the RPS Connector Cover on the Catalyst 3750G-12S, 3750-24TS, 3750G-24T, and the 3750-48TS Switches

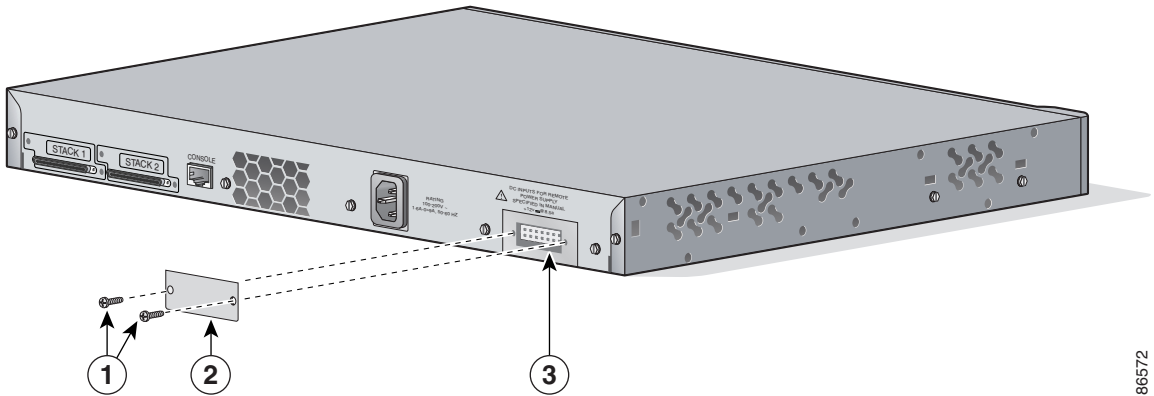

86572

<b>1</b>	Phillips pan-head screws	<b>3</b>	RPS connector
<b>2</b>	RPS connector cover		

## Mounting the Switch on a Wall

For the best support of the switch and cables, make sure the switch is attached securely to wall studs or to a firmly attached plywood mounting backboard. Mount the switch with the front panel facing up, as shown in [Figure 3-33](#).



### Warning

To comply with safety regulations, mount the switches on a wall with the front panel facing up.

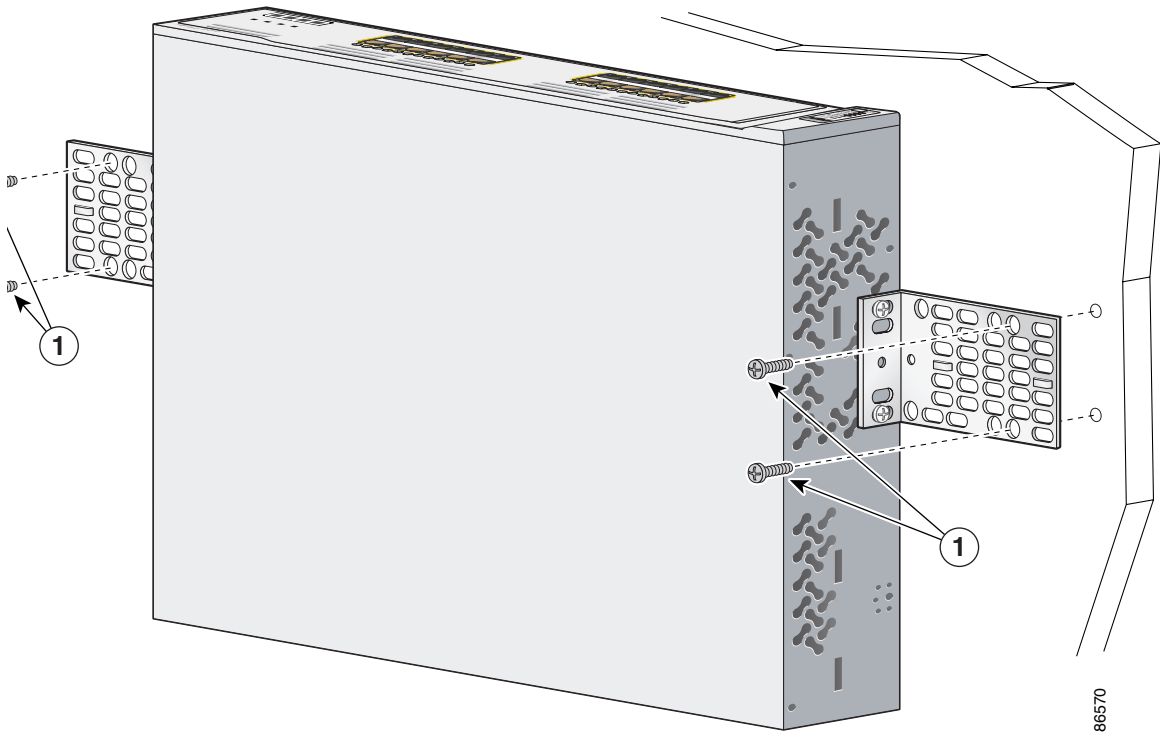
**Figure 3-33** Mounting the Switch on a Wall

<b>1</b>	User-supplied screws
----------	----------------------

After the switch is mounted on the wall, you might need to perform these tasks to complete the installation, run the setup program, and access the switch:

- (Optional) Connect the switches in the stacks. See the [“Connecting StackWise Cable to StackWise Ports”](#) section on page 3-37.
- Connect to the console port, and start the emulation software. See the [“Connecting to the Console Port”](#) section on page 1-4 and the [“Starting the Terminal Emulation Software”](#) section on page 1-6.
- Power on the switch. See the [“Connecting to a Power Source”](#) section on page 1-6. If the switches are stacked, see the [“Powering Considerations”](#) section on page 3-13.

- Run the setup program. See the “[Completing the Setup Program](#)” section on page D-11.
- Connect to the front-panel ports. See the “[Connecting to the 10/100 and 10/100/1000 Ports](#)” section on page 3-44 and the “[Connecting to an SFP Module](#)” section on page 3-46 to complete the installation.

To use the CLI, enter commands at the *Switch>* prompt through the console port by using a terminal program or through the network by using Telnet. For configuration information, refer to the switch software configuration guide or the switch command reference. To use CMS, go to the “[Launching the Switch Home Page](#)” section on page C-3.

## Table or Shelf Mounting

Follow these steps to install the switch on a table or shelf:

---

**Step 1** Locate the adhesive strip with the rubber feet in the mounting-kit envelope. Attach the four rubber feet to the recessed areas on the bottom of the unit.

**Step 2** Place the switch on the table or shelf near an AC power source.

After the switch is mounted on the table, you might need to perform these tasks to complete the installation, run the setup program, and access the switch:

- (Optional) Connect the switches in the stacks. See the “[Connecting StackWise Cable to StackWise Ports](#)” section on page 3-37.
  - Connect to the console port, and start the emulation software. See the “[Connecting to the Console Port](#)” section on page 1-4 and the “[Starting the Terminal Emulation Software](#)” section on page 1-6.
  - Power on the switch. See the “[Connecting to a Power Source](#)” section on page 1-6. If the switches are stacked, see the “[Powering Considerations](#)” section on page 3-13.
  - Run the setup program. See the “[Completing the Setup Program](#)” section on page D-11.
  - Connect to the front-panel ports. See the “[Connecting to the 10/100 and 10/100/1000 Ports](#)” section on page 3-44 and the “[Connecting to an SFP Module](#)” section on page 3-46 to complete the installation.
-



To use the CLI, enter commands at the *Switch>* prompt through the console port by using a terminal program or through the network by using Telnet. For configuration information, refer to the switch software configuration guide or the switch command reference. To use CMS, go to the [“Launching the Switch Home Page” section on page C-3](#).

## Connecting StackWise Cable to StackWise Ports

Follow these steps to connect the StackWise cable to the StackWise ports:

- 
- Step 1** Remove the dust covers from the StackWise cables and StackWise ports, and store them for future use.
- Step 2** Insert one end of the StackWise cable into the StackWise port on the back of the switch.



---

**Note** Always use a Cisco-approved StackWise cable to connect the switches.

---

- Step 3** Use the window in the StackWise cable to align the connector correctly. Secure the screws tightly.
- Step 4** Insert the other end of the cable into the connector of the other switch, and secure the screws tightly.



---

**Caution** Removing and installing the StackWise cable can shorten its useful life. Do not remove and insert the cable more often than is absolutely necessary.

---



---

**Note** When the connectors are not being used, replace the dust covers on them to protect them from dust.

---

**Figure 3-34** Inserting the StackWise Cable in a StackWise Port

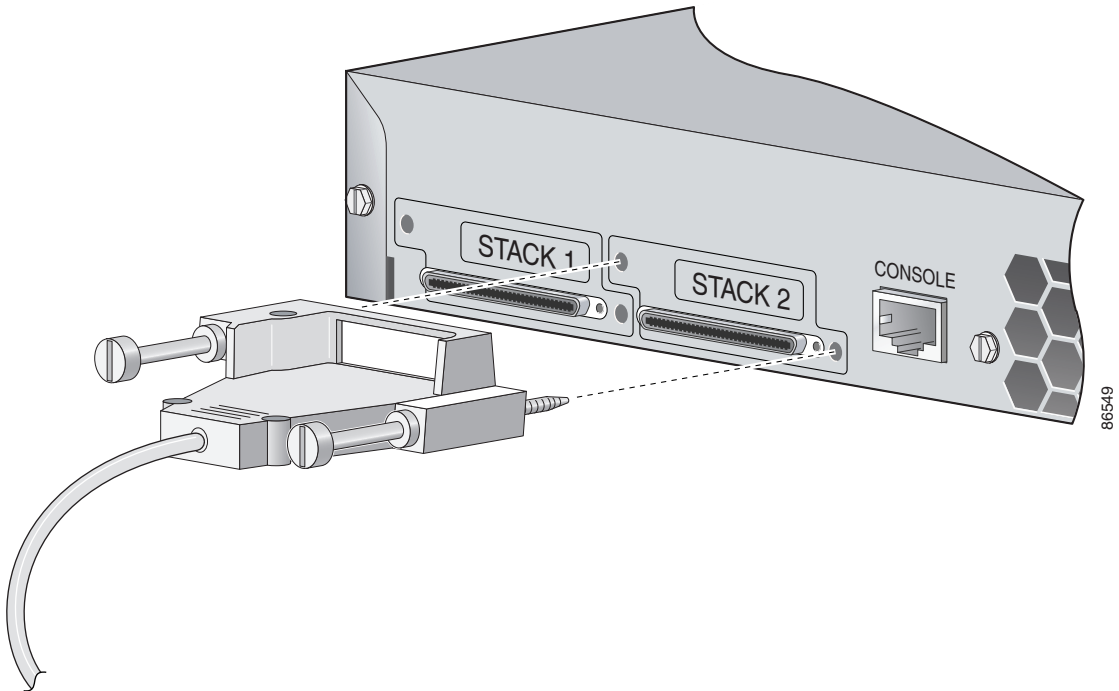

When you need to remove the StackWise cable from the connector, make sure to fully unscrew the screws before removing the connector. Also make sure that you remove the correct screws from the StackWise port. See [Figure 3-35](#) for correct removal procedures and [Figure 3-36](#) for incorrect removal procedures.

Figure 3-35 Correct Removal of the StackWise Cable from a StackWise Port

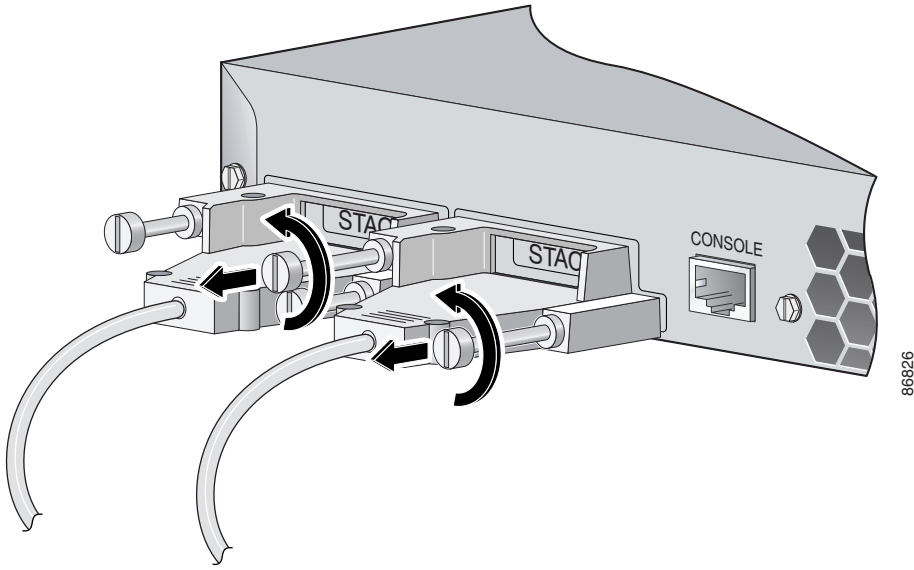

**Figure 3-36** *Incorrect Removal of a StackWise Cable from a StackWise Port*

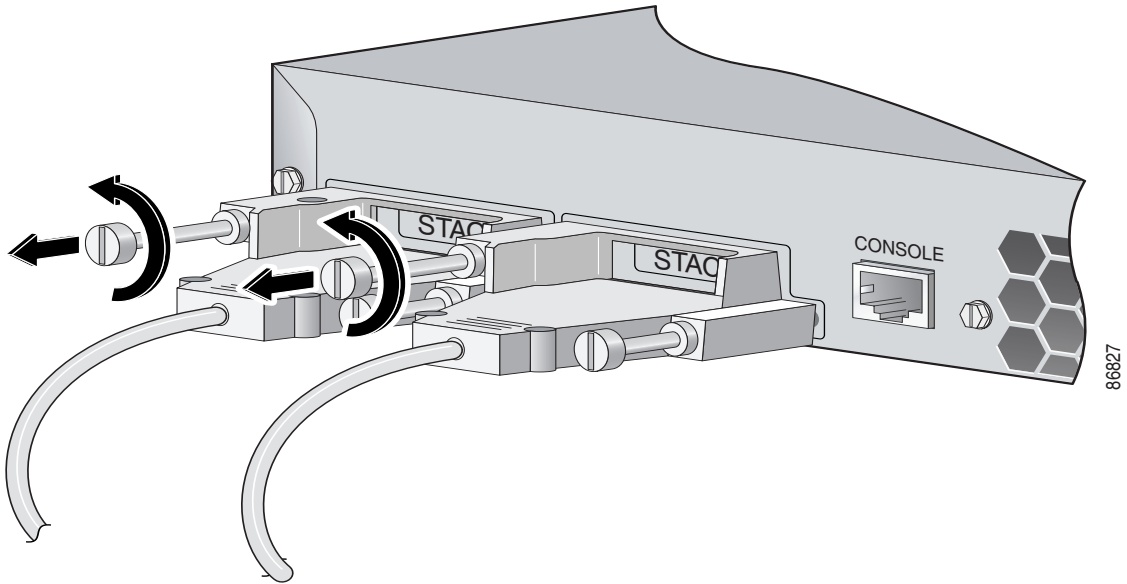

## Installing and Removing SFP Modules

These sections describe how to install and remove SFP modules. SFP modules are inserted into SFP module slots on the front of the Catalyst 3750 switches. These field-replaceable modules provide uplink interfaces.

You can use any combination of SFP modules. Refer to the Catalyst 3750 release notes for the list of SFP modules that the Catalyst 3750 switch supports. Each port must match the wave-length specifications on the other end of the cable, and the cable must not exceed the stipulated cable length for reliable communications. See the [“Installation Guidelines” section on page 3-6](#) for cable stipulations for SFP connections.

Use only Cisco SFP modules on the Catalyst 3750 switch. Each SFP module has an internal serial EEPROM that is encoded with security information. This encoding provides a way for Cisco to identify and validate that the SFP module meets the requirements for the switch.

For detailed instructions on installing, removing, and cabling the SFP module, refer to your SFP module documentation.

## Installing SFP Modules into SFP Module Slots

Figure 3-37 shows an SFP module that has a bale-clasp latch.



### Caution

We strongly recommend that you do not install or remove fiber-optic SFP modules with cables attached because of the potential damage to the cables, the cable connector, or the optical interfaces in the SFP module. Disconnect all cables before removing or installing an SFP module.

Removing and installing an SFP module can shorten its useful life. Do not remove and insert SFP modules more often than is absolutely necessary.

**Figure 3-37 SFP Module with a Bale-Clasp Latch**

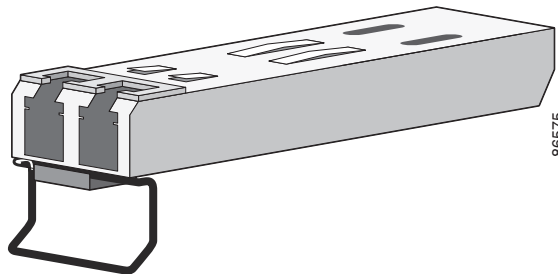

To insert an SFP module into the SFP module slot, follow these steps:

- Step 1** Attach an ESD-preventive wrist strap to your wrist and to a bare metal surface on the chassis.
- Step 2** Find the send (TX) and receive (RX) markings that identify the top side of the SFP module.



**Note** On some SFP modules, the send and receive (TX and RX) markings might be replaced by arrows that show the direction of the connection, either send or receive (TX or RX).

**Step 3** Align the SFP module in front of the slot opening.

**Step 4** Insert the SFP module into the slot until you feel the connector on the module snap into place in the rear of the slot.

**Figure 3-38** Installing an SFP Module into an SFP Module Slot

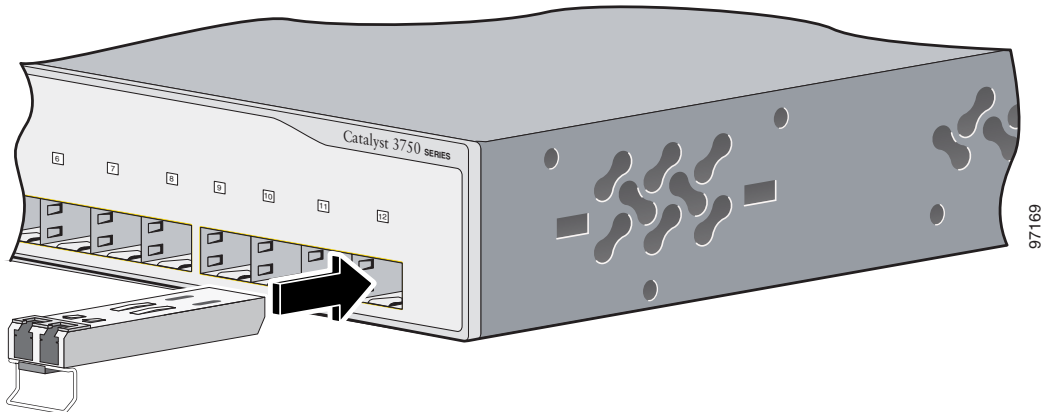

**Step 5** For fiber-optic SFP modules, remove the dust plugs from the optical ports, and store them for later use.



**Caution**

Do not remove the dust plugs from the fiber-optic SFP module port or the rubber caps from the fiber-optic cable until you are ready to connect the cable. The plugs and caps protect the SFP module ports and cables from contamination and ambient light.

- Step 6** Insert the cable connector into the SFP module:
- For fiber-optic SFP modules, insert the LC or MT-RJ cable connector into the SFP module.
  - For copper SFP modules, insert the RJ-45 cable connector into the SFP module.



---

**Note** When connecting to 1000BASE-T SFP modules, be sure to use a twisted four-pair, Category 5 cable.

---

## Removing SFP Modules from SFP Module Slots

To remove an SFP module from a module receptacle, follow these steps:

---

**Step 1** Attach an ESD-preventive wrist strap to your wrist and to a bare metal surface on the chassis.

**Step 2** Disconnect the cable from the SFP module.



---

**Tip** For reattachment, note which cable connector plug is send (TX) and which is receive (RX).

---

**Step 3** For fiber-optic SFP modules, insert a dust plug into the optical ports of the SFP module to keep the optical interfaces clean.

**Step 4** Unlock and remove the SFP module, as shown in [Figure 3-39](#).

If the module has a bale-clasp latch, pull the bale out and down to eject the module. If the bale-clasp latch is obstructed and you cannot use your index finger to open it, use a small, flat-blade screwdriver or other long, narrow instrument to open the bale-clasp latch.

**Figure 3-39** Removing a Bale-Clasp Latch SFP Module by Using a Flat-Blade Screwdriver

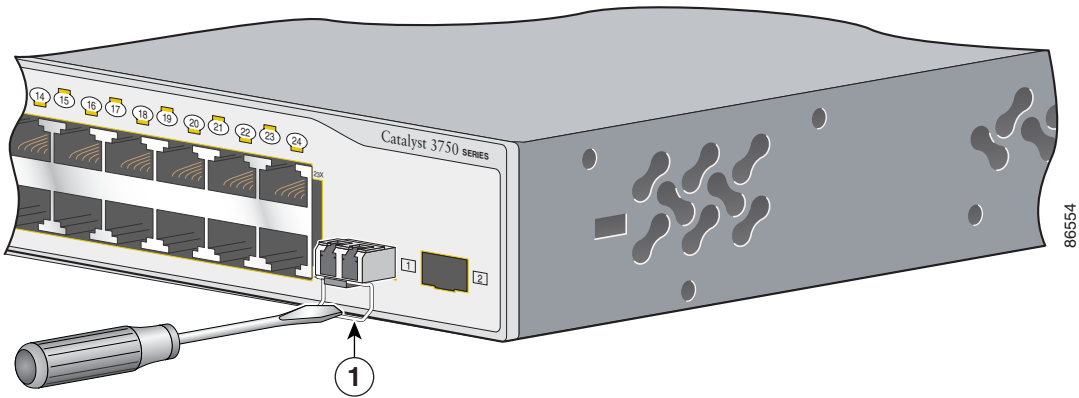

<b>1</b>	Bale clasp
----------	------------

- Step 5** Grasp the SFP module between your thumb and index finger, and carefully remove it from the module slot.
- Step 6** Place the removed SFP module in an antistatic bag or other protective environment.

## Connecting to the 10/100 and 10/100/1000 Ports

The switch 10/100 and 10/100/1000 ports configure themselves to operate at the speed of attached devices. If the attached ports do not support autonegotiation, you can explicitly set the speed and duplex parameters. Connecting devices that do not autonegotiate or that have their speed and duplex parameters manually set can reduce performance or result in no linkage.

To maximize performance, choose one of these methods for configuring the Ethernet ports:

- Let the ports autonegotiate both speed and duplex.
- Set the port speed and duplex parameters on both ends of the connection.



Follow these steps to connect to 10BASE-T, 100BASE-TX or 1000BASE-T devices:

**Caution**

To prevent electrostatic-discharge (ESD) damage, follow your normal board and component handling procedures.

**Step 1**

When connecting to workstations, servers, routers, and Cisco IP Phones, connect a straight-through cable to an RJ-45 connector on the front panel. (See [Figure 3-40](#).) When connecting to switches or repeaters, use a crossover cable. (See the “[Cable and Adapter Specifications](#)” section on [page B-6](#) for cable-pinout descriptions.)

**Note**

When connecting to 1000BASE-T-compatible devices, be sure to use a twisted four-pair, Category 5 cable.

**Note**

On switches running Cisco IOS Release 12.1(14)EA1 or later, you can use the **mdix auto** command in the CLI to enable the automatic crossover feature. When the automatic crossover feature is enabled, the switch detects the required cable type for copper Ethernet connections and configures the interfaces accordingly. Therefore, you can use either a crossover or a straight-through cable for connections to a copper 10/100 or 10/100/1000 port on the switch, regardless the type of device on the other end of the connection.

The automatic crossover feature is disabled by default. For configuration information for this feature, refer to the switch software configuration guide or the switch command reference.

**Step 2**

Connect the other end of the cable to an RJ-45 connector on the other device. The port LED turns on when both the switch and the connected device have established link.

The port LED is amber while Spanning Tree Protocol (STP) discovers the topology and searches for loops. This takes about 30 seconds, and then the port LED turns green. If the port LED does not turn on, the device at the other end

might not be turned on, or there might be a cable problem or a problem with the adapter installed in the attached device. See [Chapter 4, “Troubleshooting,”](#) for solutions to cabling problems.

- Step 3** Reconfigure and reboot the connected device if necessary.
- Step 4** Repeat Steps 1 through 3 to connect each device.
- 

**Figure 3-40** Connecting to an Ethernet Port

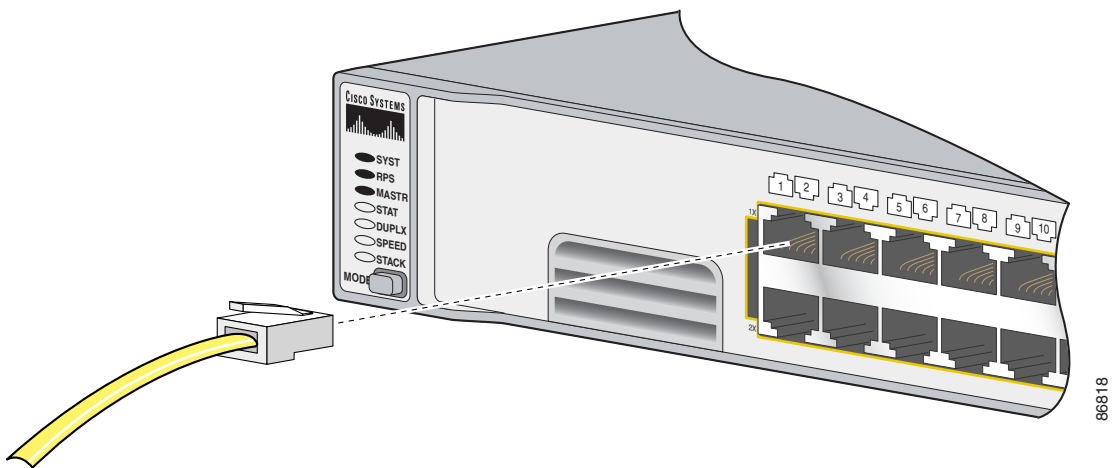

## Connecting to an SFP Module

This section describes how to connect to SFP modules. For instructions on how to connect to fiber-optic SFP modules, see the [“Connecting to 1000BASE-T SFP Modules”](#) section. For instructions on how to connect to 1000BASE-T SFP modules, see the [“Connecting to 1000BASE-T SFP Modules”](#) section.

For instructions about how to install or remove an SFP module, see the [“Installing and Removing SFP Modules”](#) section on page 3-40.

## Connecting to a Fiber-Optic SFP Module

Follow these steps to connect a fiber-optic cable to an SFP module:

**Caution**

Do not remove the rubber plugs from the SFP module port or the rubber caps from the fiber-optic cable until you are ready to connect the cable. The plugs and caps protect the SFP module ports and cables from contamination and ambient light.

Before connecting to the SFP module, be sure that you understand the port and cabling stipulations in [“Installation Guidelines”](#) section on page 3-6 and in the [“SFP Module Slots”](#) section on page 2-7. See [Appendix B, “Connector and Cable Specifications”](#) for information about the LC on the SFP module.

- 
- Step 1** Remove the rubber plugs from the module port and fiber-optic cable, and store them for future use.
  - Step 2** Insert one end of the fiber-optic cable into the SFP module port (see [Figure 3-41](#)).
  - Step 3** Insert the other cable end into a fiber-optic receptacle on a target device.
  - Step 4** Observe the port status LED.

The LED turns green when the switch and the target device have an established link.

The LED turns amber while the STP discovers the network topology and searches for loops. This process takes about 30 seconds, and then the port LED turns green.

If the LED is off, the target device might not be turned on, there might be a cable problem, or there might be problem with the adapter installed in the target device. See [Chapter 4, “Troubleshooting,”](#) for solutions to cabling problems.

Figure 3-41 Connecting to an SFP Module Port

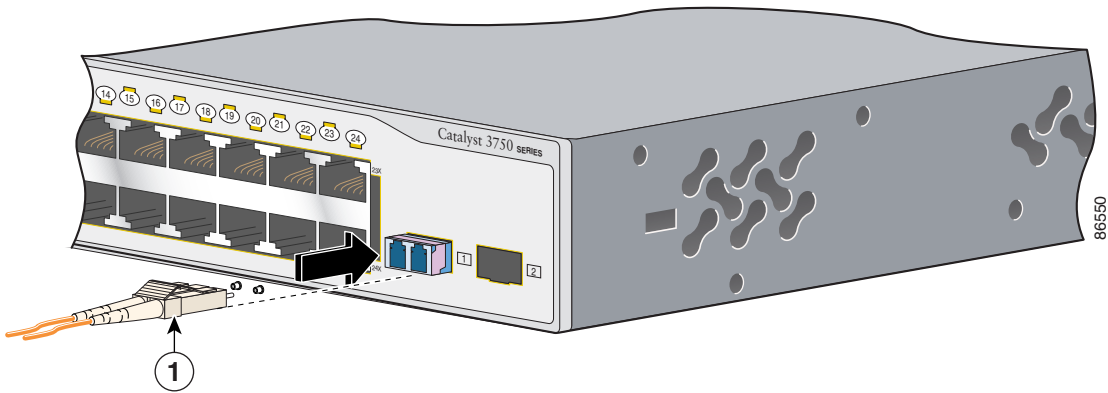

---

**1** LC connector
 

---

**Step 5** If necessary, reconfigure and restart the switch or target device.



**Caution**

For detailed instructions on removing the SFP modules, refer to your SFP documentation.

---

## Connecting to 1000BASE-T SFP Modules

Follow these steps to connect a Category 5 cable to a 1000BASE-T SFP module:



**Caution**

To prevent ESD damage, follow your normal board and component handling procedures.

---

- Step 1** When connecting to servers, workstations, and routers, insert a four twisted-pair, straight-through cable in the RJ-45 connector. When connecting to switches or repeaters, insert a four twisted-pair, crossover cable.



- Note** When connecting to a 1000BASE-T device, be sure to use a four twisted-pair, Category 5 cable.

**Figure 3-42** Connecting to an SFP Module Port

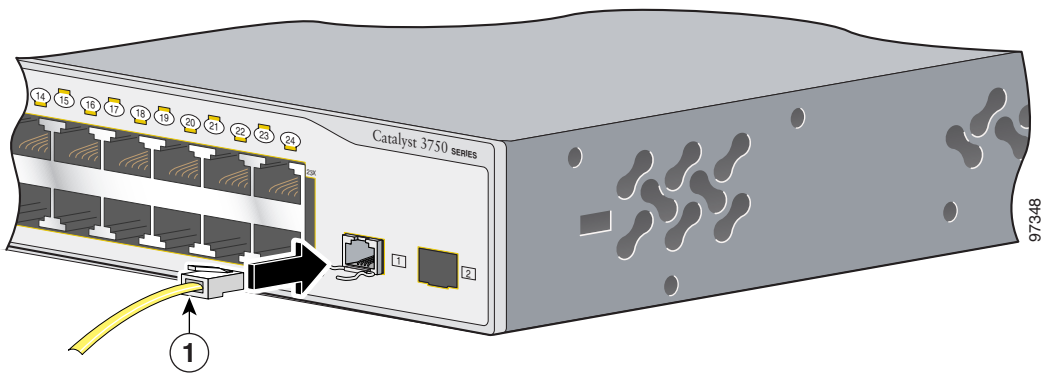

<b>1</b>	RJ-45 connector
----------	-----------------

- Step 2** Insert the other cable end in an RJ-45 connector on a target device.

- Step 3** Observe the port status LED.

The LED turns green when the switch and the target device have an established link.

The LED turns amber while the STP discovers the network topology and searches for loops. This process takes about 30 seconds, and then the port LED turns green.

If the LED is off, the target device might not be turned on, there might be a cable problem, or there might be problem with the adapter installed in the target device. See [Chapter 4, “Troubleshooting,”](#) for solutions to cabling problems.

- Step 4** If necessary, reconfigure and restart the switch or target device.

## Where to Go Next

If the default configuration is satisfactory, the switch does not need further configuration. You can use any of these management options to change the default configuration:

- Start CMS as described in the switch software configuration guide, and configure the switch as a member of a cluster or as an individual switch.
- Use the CLI to configure the switch as a member of a cluster or as an individual switch from the console. Refer to the *Catalyst 3750 Switch Command Reference* on Cisco.com for information on using the CLI with a Catalyst 3750 switch.
- Start an SNMP application such as the CiscoView application.



## Troubleshooting

---

The LEDs on the front panel provide troubleshooting information about the switch. They show failures in the power-on self-test (POST), port-connectivity problems, and overall switch performance. For a full description of the switch LEDs, see the [“LEDs” section on page 2-8](#).

You can also get statistics from the browser interface, from the command-line interface (CLI), or from a Simple Network Management Protocol (SNMP) workstation. Refer to the software configuration guide, the switch command reference guide on Cisco.com, or the documentation that came with your SNMP application for details.

This chapter describes these topics for troubleshooting problems:

- [Understanding POST Results, page 4-1](#)
- [Clearing the Switch IP Address and Configuration, page 4-2](#)
- [Replacing a Failed Stack Member, page 4-7](#)

## Understanding POST Results

As the switch powers on, it begins POST, a series of tests that run automatically to ensure that the switch functions properly. When the switch begins POST, the System, the RPS, the Master, the Status, and the Duplex LEDs turn amber for 2 seconds. The Speed and the Stack LEDs turn green for 2 seconds.

As POST continues, the System LED blinks green, and the other LEDs turn off. The port LEDs turn solid green, and each port LED turns off as the test successfully checks each port. If there is a failure associated with a particular port, that port LED turns amber.

When POST is complete, only the SYST and STAT LEDs remain green. The MASTR LED is also green on a single switch or on a stack master switch.

**Note**

---

For information on operating status for the LEDs, go to the “LEDs” section on [page 2-8](#).

---

If a switch fails POST, the System LED turns amber. The RPS LED turns either solid amber or blinking amber. Other LEDs are off.

**Note**

---

POST failures are usually fatal. Call Cisco Systems if your switch does not pass POST.

---

## Clearing the Switch IP Address and Configuration

If you have configured a new switch with a wrong IP address, or all the switch LEDs start blinking when you are trying to enter Express Setup mode, you can clear the IP address that is configured on the switch.

**Note**

---

This procedure will clear the IP address and all configuration information stored on the switch. Do not follow this procedure unless you want to completely reconfigure the switch.

---

To clear the IP address and the switch configuration information, follow these steps:

- 
- Step 1** Press and hold the Mode button, as shown in [Figure 1-4 on page 1-5](#).  
The switch LEDs begin blinking after about 2 seconds.





---

**Note** If the switch is not configured, the mode buttons are all green. You can omit Step 2 and run Express Setup to configure the switch.

---

**Step 2** Continue holding down the Mode button. The LEDs stop blinking after 8 additional seconds, and then the switch reboots.

---



---

**Note** These steps only work on a previously-configured switch.

---

The switch now behaves like an unconfigured switch. You can configure the switch by using Express Setup as described in these sections.

- [“Starting Express Setup” section on page 1-4](#)
- [“Configuring the Switch Settings” section on page 1-9](#)
- [“Verifying Switch IP Address \(Optional\)” section on page 1-10](#)

You can also configure the switch by using the command-line interface (CLI) setup procedure described in these sections:

- [“Starting the Terminal Emulation Software” section on page D-9](#)
- [“Entering the Initial Configuration Information” section on page D-10](#)

## Diagnosing Problems

Common switch problems fall into these categories:

- Poor performance
- No connectivity
- Corrupted software

[Table 4-1](#) describes how to detect and resolve these problems.

Table 4-1 Common Problems and Solutions

Symptom	Possible Cause	Resolution
Poor performance or excessive errors	Duplex autonegotiation mismatch.	Refer to the switch software configuration guide for information on identifying autonegotiation mismatches.
	<b>Cabling distance exceeded</b> <ul style="list-style-type: none"> <li>• Port statistics show excessive frame check sequence (FCS), late-collision, or alignment errors.</li> <li>• For 10/100 and 10/100/1000BASE-T connections: <ul style="list-style-type: none"> <li>– The distance between the port and the attached device exceeds 328 feet (100 meters).</li> <li>– If the switch is attached to a repeater, the total distance between the two end stations exceeds the cabling guidelines.</li> </ul> </li> <li>• For SFP port connections: <ul style="list-style-type: none"> <li>– The distance between the SFP port and the attached device exceeds the SFP cabling guidelines.</li> </ul> </li> </ul>	<ul style="list-style-type: none"> <li>• Refer to the switch software configuration guide for information on displaying port statistics.</li> <li>• Reduce the cable length to within the recommended distances.</li> <li>• Refer to your repeater documentation for cabling guidelines.</li> <li>• Refer to your SFP documentation for cabling guidelines.</li> </ul>
	<b>Bad adapter in attached device</b> <ul style="list-style-type: none"> <li>• Excessive errors found in port statistics.</li> <li>• STP checking for possible loops.</li> </ul>	<ul style="list-style-type: none"> <li>• Run adapter card diagnostic utility.</li> <li>• Wait 30 seconds for the port LED to turn green.</li> </ul>

**Table 4-1 Common Problems and Solutions (continued)**

Symptom	Possible Cause	Resolution
<b>No connectivity</b>	<p><b>Incorrect or bad cable</b></p> <p>These are results of no link at both ends:</p> <ul style="list-style-type: none"> <li>• A crossover cable was used when a straight-through was required, or vice-versa.</li> <li>• The cable is wired incorrectly.</li> <li>• A crossover or straight-through cable is wired incorrectly.</li> <li>• STP checking for possible loops.</li> </ul>	<ul style="list-style-type: none"> <li>• For the correct pinouts and the proper application of crossover vs. straight-through cables, see the <a href="#">“Two Twisted-Pair Cable Pinouts”</a> section on page B-6.</li> <li>• Replace with a tested good cable.</li> <li>• For 1000BASE-T connections, be sure to use a twisted four-pair, Category 5 cable.</li> <li>• Wait 30 seconds for the port LED to turn green.</li> </ul>
<b>Unreadable characters on the management console</b>	Incorrect baud rate.	Reset the emulation software to 9600 baud.
<b>Amber system LED</b>	Fatal POST error detected.	Contact Cisco Systems.

Table 4-1 Common Problems and Solutions (continued)

Symptom	Possible Cause	Resolution
The switch port is placed in error-disabled state after SFP is inserted	Bad or non-Cisco-approved SFP.	Remove the SFP module from the switch, and replace it with a Cisco-approved module. Use the <b>errdisable recovery cause gbic-invalid</b> global configuration command to verify the port status, and enter a time interval to recover from the error-disable state.  Refer to the switch command reference guide for information on the <b>errdisable recovery</b> command.
Switch does not recognize the SFP module	The SFP module might be installed upside down.  The SFP module does not snap into the slot.	Verify that the SFP module is not installed upside down.  Remove the SFP module. Inspect for physical damage to the connector, the module, and the module slot.  Replace the SFP module with a known good SFP module.
No stack link between switches or high error rate between switches in the stack	Poor cable connection.  Bad StackWise cable or damaged StackWise port.	Secure the thumb screws on the StackWise cables. See <a href="#">Figure 3-35</a> .  Remove the StackWise cable, and inspect the cable and StackWise port for bent pins or damaged connectors.  If the StackWise cable is bad, replace it with a known good cable.

# Replacing a Failed Stack Member

If you need to replace a failed stack member, you can hot swap or replace the switch by following this procedure:

- 
- Step 1** Get a replacement switch that has the same model number as the failed switch.
  - Step 2** Power down the failed switch.
  - Step 3** Make sure the replacement switch is powered off, and then connect the replacement switch to the stack.



**Note** If you had manually set the member numbers for any members in the stack, you need to manually assign the replacement switch the same member number as the failed switch. To assign the member number manually, refer to the switch software configuration guide.

---

- Step 4** Make the same Ethernet and Gigabit Ethernet connections on the replacement switch (as were on the failed switch).
  - Step 5** Power on the replacement switch.
- 

The replacement switch will have the same configuration for all the interfaces as the failed switch and will function the same as the failed switch.





# Technical Specifications

This appendix lists the switch technical specifications in [Table A-2](#), [Table A-3](#), [Table A-4](#), [Table A-5](#), and the regulatory agency approvals in [Table A-6](#).

**Table A-1** *Specifications for the Catalyst 3750G-12S Switch*

<b>Environmental Ranges</b>	
Operating temperature	32 to 113°F (0 to 45°C)
Storage temperature	-13 to 158°F (-25 to 70°C)
Relative humidity	10 to 85% (noncondensing)
Operating altitude	Up to 10,000 ft (3049 m)
Storage altitude	Up to 15,000 ft (4573 m)
<b>Power Requirements</b>	
AC input voltage	100 to 240 VAC (autoranging) 1.2A/0.6A, 50 to 60 Hz
DC input voltages for RPS 300	---+12V---@13A
DC input voltages for RPS 675	---+12V---@13A
Power consumption	120 W, 409 BTUs per hour
Power rating	0.120 kVA

**Table A-1 Specifications for the Catalyst 3750G-12S Switch (continued)**

<b>Environmental Ranges</b>	
<b>Physical Dimensions</b>	
Weight	10 lb (4.55 kg)
Dimensions (H x D x W)	1.73 x 12.83 x 17.5 in. (4.39 x 32.59 x 44.45 cm)

**Table A-2 Specifications for the Catalyst 3750-24TS Switch**

<b>Environmental Ranges</b>	
Operating temperature	32 to 113°F (0 to 45°C)
Storage temperature	-13 to 158°F (-25 to 70°C)
Relative humidity	10 to 85% (noncondensing)
Operating altitude	Up to 10,000 ft (3049 m)
Storage altitude	Up to 15,000 ft (4573 m)
<b>Power Requirements</b>	
AC input voltage	100 to 240 VAC (autoranging) 1.2A/0.6A, 50 to 60 Hz
DC input voltages for RPS 300	+++12V+++@8.5A
DC input voltages for RPS 675	+++12V+++@8.5A
Power consumption	50W, 171 BTUs per hour
Power rating	0.083 kVA



**Table A-2 Specifications for the Catalyst 3750-24TS Switch (continued)**

<b>Environmental Ranges</b>	
<b>Physical Dimensions</b>	
Weight	8 lb (3.6 kg)
Dimensions (H x D x W)	1.73 x 11.83 x 17.5 in. (4.39 x 30.05 x 44.45 cm)

**Table A-3 Specifications for the Catalyst 3750G-24T Switch**

<b>Environmental Ranges</b>	
Operating temperature	32 to 113°F (0 to 45°C)
Storage temperature	-13 to 158°F (-25 to 70°C)
Relative humidity	10 to 85% (noncondensing)
Operating altitude	Up to 10,000 ft (3049 m)
Storage altitude	Up to 15,000 ft (4573 m)
<b>Power Requirements</b>	
AC input voltage	100 to 240 VAC (autoranging) 1.6A/0.9A, 50 to 60 Hz
DC input voltage for RPS 300	+++12V---@13A
DC input voltages for RPS 675	+++12V---@13A
Power consumption	165W, 563 BTUs per hour
Power rating	0.165 kVA
<b>Physical Dimensions</b>	
Weight	10 lb (4.55 kg)
Dimensions (H x D x W)	1.73 x 12.83 x 17.5 in. (4.39 x 32.59 x 44.45 cm)

**Table A-4 Specifications for the Catalyst 3750G-24TS Switch**

<b>Environmental Ranges</b>	
Operating temperature	32 to 113°F (0 to 45°C)
Storage temperature	-13 to 158°F (-25 to 70°C)
Relative humidity	10 to 85% (noncondensing)
Operating altitude	Up to 10,000 ft (3049 m)
Storage altitude	Up to 15,000 ft (4573 m)
<b>Power Requirements</b>	
AC input voltage	100 to 240 VAC (autoranging) 2.3A/1.5A, 50 to 60 Hz
DC input voltages for RPS 675	---+12V--- @17A
Power consumption	190W, 650 BTUs per hour
Power rating	0.190 kVA
<b>Physical Dimensions</b>	
Weight	12.5 lb (5.68 kg)
Dimensions (H x D x W)	2.59 x 11.60 x 17.5 in. (6.59 x 29.46 x 44.45 cm)

**Table A-5 Specifications for the Catalyst 3750-48TS Switch**

<b>Environmental Ranges</b>	
Operating temperature	32 to 113°F (0 to 45°C)
Storage temperature	-13 to 158°F (-25 to 70°C)
Relative humidity	10 to 85% (noncondensing)
Operating altitude	Up to 10,000 ft (3049 m)
Storage altitude	Up to 15,000 ft (4573 m)
<b>Power Requirements</b>	
AC input voltage	100 to 240 VAC (autoranging) 1.2A/0.6A, 50 to 60 Hz

**Table A-5 Specifications for the Catalyst 3750-48TS Switch (continued)**

<b>Environmental Ranges</b>	
DC input voltages for RPS 300	===+12V@8.5A
DC input voltages for RPS 675	===+12V==@8.5A
Power consumption	75W, 256 BTUs per hour
Power rating	0.075 kVA
<b>Physical Dimensions</b>	
Weight	9.1 lb (4.1 kg)
Dimensions (H x D x W)	1.73 x 11.83 x 17.5 in. (4.39 x 30.05 x 44.45 cm)

**Table A-6 Catalyst 3750 Switch Agency Approvals**

<b>Safety</b>	<b>EMC</b>
UL to UL 60950, Third Edition	FCC Part 15 Class A
c-UL to CAN/CSA -C22.2 No. 60950-00, Third Edition	EN 55022 1998 Class A (CISPR 22)
	EN 55024 1998 Class A (CISPR 24)
TUV/GS to EN 60950:2000	VCCI Class A
CB to IEC 60950 with all country deviations	AS/NZS 3548 Class A
NOM to NOM-019-SCFI	CNS13438 Class A
CE Marking	CE
	MIC





# Connector and Cable Specifications

---

This appendix describes the Catalyst 3750 switch ports and the cables and adapters that you use to connect the switch to other devices.

## Connector Specifications

These sections describe the connectors used with the Catalyst 3750 switches.

### 10/100/1000 Ports

The 10/100/1000 Ethernet ports on Catalyst 3750 switches use standard RJ-45 connectors. [Figure B-1](#) shows the pinout.



#### Note

On switches running Cisco IOS Release 12.1(14)EA1 or later, you can use the **mdix auto** command in the CLI to enable the automatic crossover feature. When the automatic crossover feature is enabled, the switch detects the required cable type for copper Ethernet connections and configures the interfaces accordingly. Therefore, you can use either a crossover or a straight-through cable for connections to a copper 10/100 or 10/100/1000 port on the switch, regardless the type of device on the other end of the connection.

The automatic crossover feature is disabled by default. For configuration information for this feature, refer to the switch software configuration guide or the switch command reference.

---

## Connecting to 10BASE-T- and 100BASE-TX-Compatible Devices

When connecting the ports to 10BASE-T- and 100BASE-TX-compatible devices, such as servers, workstations, and routers, you can use a two or four twisted-pair, straight-through cable wired for 10BASE-T and 100BASE-TX. [Figure B-5](#) shows the two twisted-pair, straight-through cable schematics. [Figure B-7](#) shows the four twisted-pair, straight-through cable schematics.

When connecting the ports to 10BASE-T- and 100BASE-TX-compatible devices, such as switches or repeaters, you can use a two or four twisted-pair, crossover cable. [Figure B-6](#) shows the two twisted-pair, crossover cable schematics. [Figure B-10](#) shows the four twisted-pair, crossover cable schematics.

You can use Category 3, 4, or 5 cabling when connecting to 10BASE-T-compatible devices. You must use Category 5 cabling when connecting to 100BASE-TX-compatible devices.

## Connecting to 1000BASE-T Devices

When connecting the ports to 1000BASE-T devices, such as servers, workstations, and routers, you must use a four twisted-pair, Category 5, straight-through cable wired for 10BASE-T, 100BASE-TX, and 1000BASE-T. [Figure B-9](#) shows the straight-through cable schematics.

When connecting the ports to other devices, such as switches or repeaters, you must use a four twisted-pair, Category 5, crossover cable. [Figure B-10](#) shows the crossover cable schematics.

**Note**

---

Be sure to use a four twisted-pair, Category 5 cable when connecting to a 1000BASE-T-compatible device.

---

**Note**

---

Use a straight-through cable to connect two ports only when one port is designated with an X. Use a crossover cable to connect two ports when both ports are designated with an X or when both ports do not have an X.

---

**Figure B-1 10/100/1000 Port Pinouts**

Pin	Label	1 2 3 4 5 6 7 8
1	TP0+	
2	TP0-	
3	TP1+	
4	TP2+	
5	TP2-	
6	TP1-	
7	TP3+	
8	TP3-	

60915

## 10/100 Ports

The 10/100 Ethernet ports use standard RJ-45 connectors and Ethernet pinouts with internal crossovers, as shown by an **X** in the port name. These ports have the transmit (TD) and receive (RD) signals internally crossed so that a twisted-pair straight-through cable and adapter can be attached to the port. [Figure B-2](#) shows the pinout.



### Note

On switches running Cisco IOS Release 12.1(14)EA1 or later, you can use the **mdix auto** command in the CLI to enable the automatic crossover feature. When the automatic crossover feature is enabled, the switch detects the required cable type for copper Ethernet connections and configures the interfaces accordingly. Therefore, you can use either a crossover or a straight-through cable for connections to a copper 10/100 or 10/100/1000 port on the switch, regardless the type of device on the other end of the connection.

The automatic crossover feature is disabled by default. For configuration information for this feature, refer to the switch software configuration guide or the switch command reference.

When connecting 10/100 ports to compatible devices such as servers, workstations, and routers, you can use a two or four twisted-pair straight-through cable wired for 10BASE-T and 100BASE-TX. [Figure B-5](#) shows the two twisted-pair straight-through cable schematics. [Figure B-7](#) shows the four twisted-pair straight-through cable schematics.

When connecting the ports to other devices, such as switches or repeaters, you can use a two or four twisted-pair crossover cable. [Figure B-6](#) shows the two twisted-pair crossover cable schematics. [Figure B-7](#) shows the four twisted-pair crossover cable schematics.

You can use Category 3, 4, or 5 cabling when connecting to 10BASE-T-compatible devices. You must use Category 5 cabling when connecting to 100BASE-TX-compatible devices.

**Note**

Use a straight-through cable to connect two ports only when one port is designated with an X. Use a crossover cable to connect two ports when both ports are designated with an X or when both ports do not have an X.

**Figure B-2 10/100 Port Pinouts**

Pin	Label	1 2 3 4 5 6 7 8
1	RD+	
2	RD-	
3	TD+	
4	NC	
5	NC	
6	TD-	
7	NC	
8	NC	

H5318



## SFP Module Ports

The Catalyst 3750 switch uses SFP modules for fiber-optic and copper uplink ports. Refer to the Catalyst 3750 release notes for a list of supported SFP modules.

**Figure B-3** Fiber-Optic SFP Module LC Connector

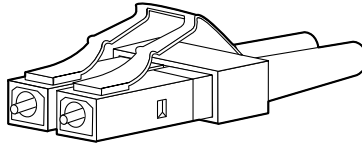

58476



### Warning

**Invisible laser radiation may be emitted from disconnected fibers or connectors. Do not stare into beams or view directly with optical instruments.**

**Figure B-4** Copper SFP Module RJ-45 Connector

Pin	Label	1	2	3	4	5	6	7	8
1	TP0+								
2	TP0-								
3	TP1+								
4	TP2+								
5	TP2-								
6	TP1-								
7	TP3+								
8	TP3-								

60915

## Console Port

The console port uses an 8-pin RJ-45 connector, which is described in [Table B-1](#) and [Table B-2](#). The supplied RJ-45-to-DB-9 adapter cable is used to connect the console port of the switch to a console PC. You need to provide a RJ-45-to-DB-25 female DTE adapter if you want to connect the switch console port to a terminal. You can order a kit (part number ACS-DSBUASYN=) containing that adapter from Cisco. For console port and adapter pinout information, see [Table B-1](#) and [Table B-2](#).

## Cable and Adapter Specifications

These sections describe the cables and adapters used with Catalyst 3750 switches.

### Two Twisted-Pair Cable Pinouts

[Figure B-5](#) and [Figure B-6](#) show the schematics of two twisted-pair cables for 10/100 ports.

**Figure B-5 Two Twisted-Pair Straight-Through Cable Schematic**

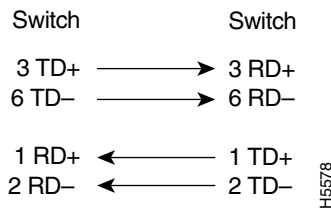

**Figure B-6 Two Twisted-Pair Crossover Cable Schematic**

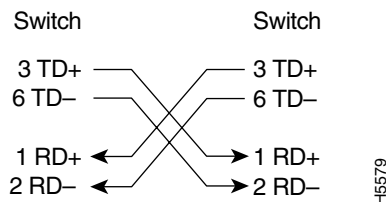

## Four Twisted-Pair Cable Pinouts for 10/100 Ports

Figure B-7 and Figure B-8 show the schematics of four twisted-pair cables for 10/100 ports.

**Figure B-7 Four Twisted-Pair Straight-Through Cable Schematic for 10/100 Ports**

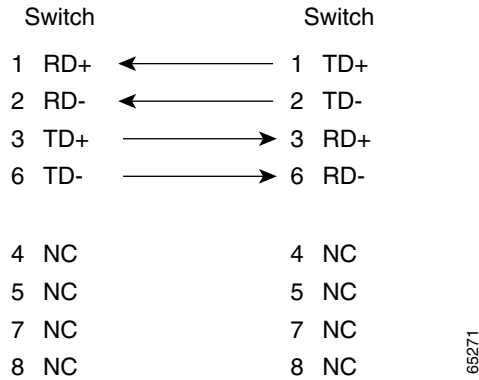

**Figure B-8 Four Twisted-Pair Crossover Cable Schematic for 10/100 Ports**

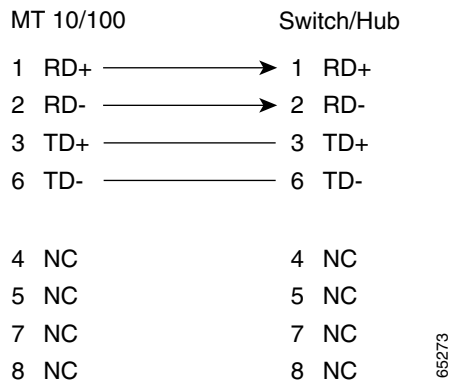

## Four Twisted-Pair Cable Pinouts for 1000BASE-T Ports

Figure B-9 and Figure B-10 show the schematics of four twisted-pair cables for 10/100/1000 ports on Catalyst 3750 switches.

**Figure B-9 Four Twisted-Pair Straight-Through Cable Schematic for 10/100/1000 Ports**

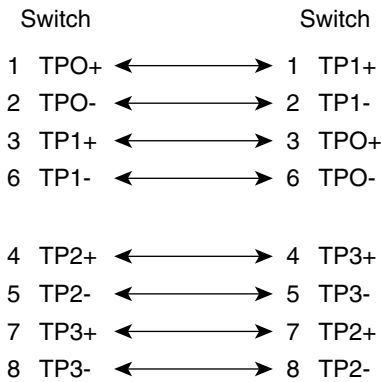

65272

**Figure B-10 Four Twisted-Pair Crossover Cable Schematics for 10/100/1000 Ports**

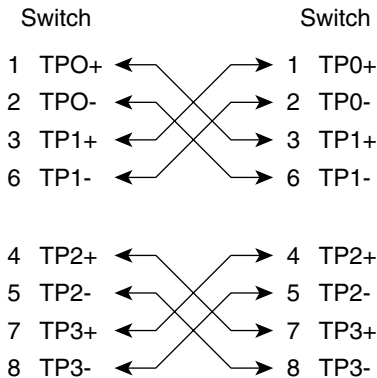

65274

# Crossover Cable and Adapter Pinouts

This section describes how to identify a crossover cable and also describes the adapter pinouts.

## Identifying a Crossover Cable

To identify a crossover cable, compare the two modular ends of the cable. Hold the cable ends side-by-side, with the tab at the back. The wire connected to the pin on the outside of the left plug should be the same color as the wire connected to the pin on the outside of the right plug. (See [Figure B-11](#).)

**Figure B-11** Identifying a Crossover Cable

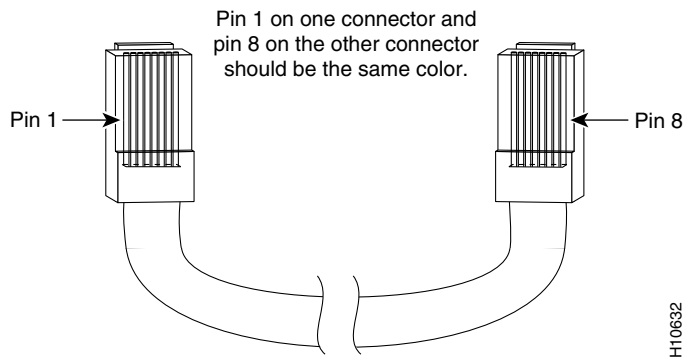

### Note

On switches running Cisco IOS Release 12.1(14)EA1 or later, you can use the **mdix auto** command in the CLI to enable the automatic crossover feature. When the automatic crossover feature is enabled, the switch detects the required cable type for copper Ethernet connections and configures the interfaces accordingly. Therefore, you can use either a crossover or a straight-through cable for connections to a copper 10/100 or 10/100/1000 port on the switch, regardless the type of device on the other end of the connection.

The automatic crossover feature is disabled by default. For configuration information for this feature, refer to the switch software configuration guide or the switch command reference.

## Adapter Pinouts

Table B-1 lists the pinouts for the console port, the RJ-45-to-DB-9 adapter cable, and the console device.

**Table B-1 Console Port Signaling Using a DB-9 Adapter**

Switch Console Port (DTE)	RJ-45-to-DB-9 Terminal Adapter	Console Device
Signal	DB-9 Pin	Signal
RTS	8	CTS
DTR	6	DSR
TxD	2	RxD
GND	5	GND
GND	5	GND
RxD	3	TxD
DSR	4	DTR
CTS	7	RTS

Table B-2 lists the pinouts for the console port, RJ-45-to-DB-25 female DTE adapter, and the console device.



**Note**

The RJ-45-to-DB-25 female DTE adapter is not supplied with the switch. You can order a kit (part number ACS-DSBUASYN=) containing this adapter from Cisco.

**Table B-2 Console Port Signaling Using a DB-25 Adapter**

Switch Console Port (DTE)	RJ-45-to-DB-25 Terminal Adapter	Console Device
Signal	DB-25 Pin	Signal
RTS	5	CTS
DTR	6	DSR

**Table B-2 Console Port Signaling Using a DB-25 Adapter (continued)**

<b>Switch Console Port (DTE)</b>	<b>RJ-45-to-DB-25 Terminal Adapter</b>	<b>Console Device</b>
<b>Signal</b>	<b>DB-25 Pin</b>	<b>Signal</b>
TxD	3	RxD
GND	7	GND
GND	7	GND
RxD	2	TxD
DSR	20	DTR
CTS	4	RTS







## Managing the Switch by Using the Cluster Management Suite

---

This appendix describes the requirements for using the web-based Cluster Management Suite (CMS) tools. See these sections for information about running CMS and the CMS requirements:

- [Connecting to an Ethernet Port, page C-2](#)
- [Launching the Switch Home Page, page C-3](#)
- [CMS Requirements, page C-5](#)

This appendix assumes that you have already assigned an IP address to your switch. If you have not, configure the switch as described in [Chapter 1, “Using Express Setup”](#) or in [Appendix D, “Quick Setup By Using the CLI-Based Setup Program.”](#)

After you have assigned an IP address to the switch and installed the Java plug-in, you can access the switch from your browser and use the CMS to configure the switch.



### Note

---

If you have downloaded a new version of CMS, you must clear your browser cache before launching the new version. When you clear the cache, all the `jar_cache*.tmp` CMS files are removed from the temporary directory.

---

# Connecting to an Ethernet Port

Follow these steps to connect to an 10/100 or 10/100/1000 Ethernet port:

- 
- Step 1** Connect a Category 5 straight-through cable (not supplied) to an 10/100 or 10/100/1000 port on the front panel of a switch. See [Figure C-1](#).
- Step 2** Connect the other end of the cable to the Ethernet (RJ-45) port of the workstation, PC, server, or router.
- 

For information on connecting to the SFP ports, see the “[Connecting to an SFP Module](#)” section on page 3-46.

**Figure C-1** Connecting a Front Panel Port

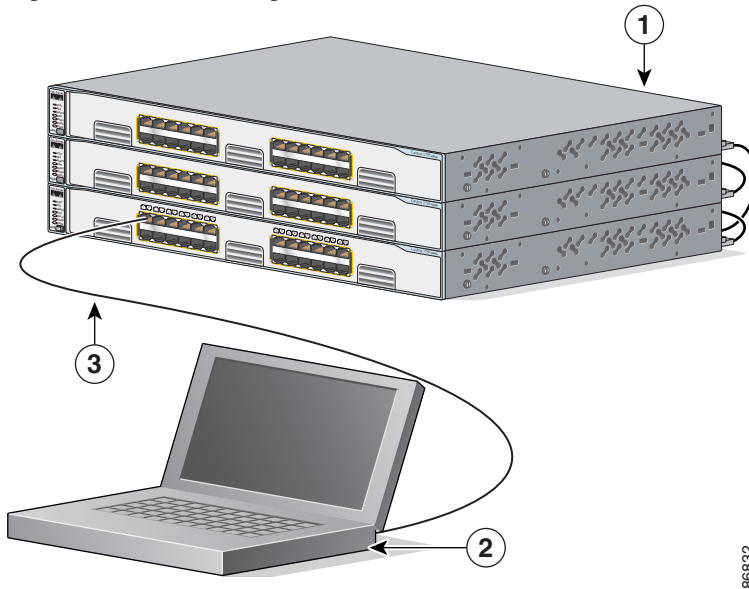

1	Catalyst 3750 switches	3	Category 5 straight-through cable
2	PC		

86892

# Launching the Switch Home Page

To display the switch access page, follow these steps:

- Step 1** Enter the switch IP address in the browser, and press **Return**.
- Step 2** Enter your username and password when prompted. If no username is configured on your switch (the default), enter only the enable password in the password field.

The switch home page appears, as shown in [Figure C-2](#).

**Figure C-2** Switch Home Page

Close Window Toolkit: Roll over tools: below

**CISCO SYSTEMS**

**Cisco WS-C3750-48P**

**HOME**

- EXPRESS SETUP
- CLUSTER MANAGEMENT SUITE
- TOOLS
- HELP RESOURCES

**Home: Master Summary Status**

Network Identity	
IP Address	10.89.153.42
MAC Address	00:03:FD:63:A4:80
System Details	
Host Name	Bilbo48_CMS
System Uptime	3 days, 4 hours, 46 minutes
Serial Number	
Software Version	12.1(0.0.713)EA1
System Contact	
System Location	

Refresh

Close Window Copyright (c) 2003 by Cisco Systems, Inc.

97178

- Step 3** Click **Cluster Management Suite** to launch the CMS interface. The CMS Setup Report runs and verifies that your PC or workstation can correctly run the CMS. If you are running an unsupported operating system, web browser, Java plug-in, or if the Java plug-in is not enabled, the CMS Setup Report page appears, as shown in [Figure C-3](#).

**Figure C-3** CMS Setup Report

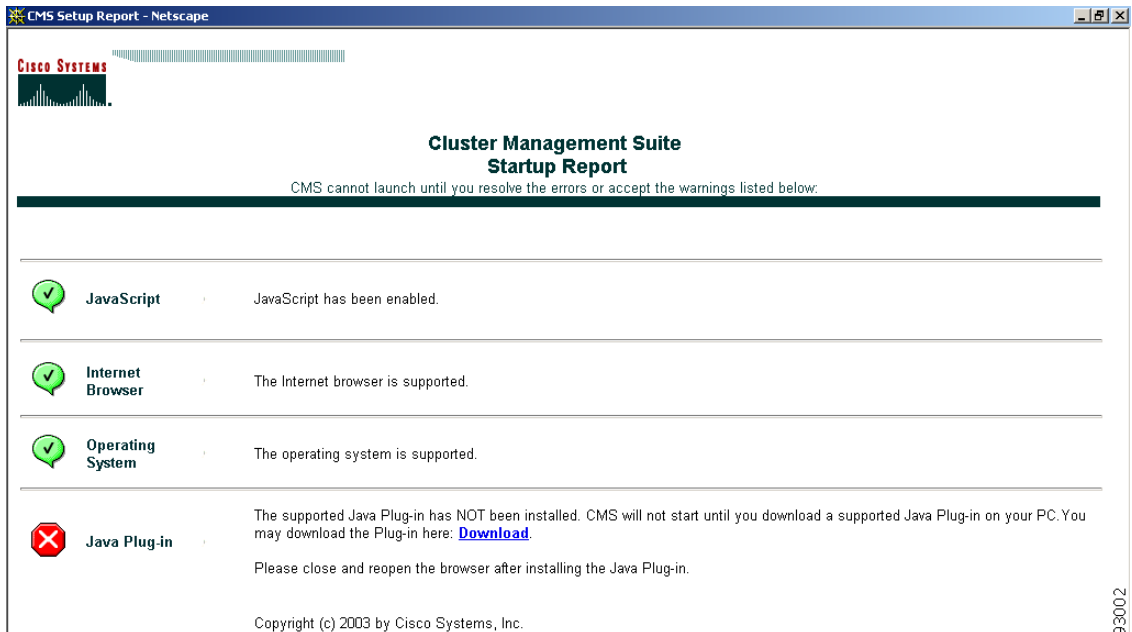

The CMS Setup Report has links that instruct you how to configure your PC or workstation to run CMS.

When your PC or workstation is correctly configured, CMS launches, as shown in [Figure C-4](#).



**Note**

If your PC or workstation is correctly configured for CMS, you do not see the CMS Setup Report.

Figure C-4 CMS Front Panel View

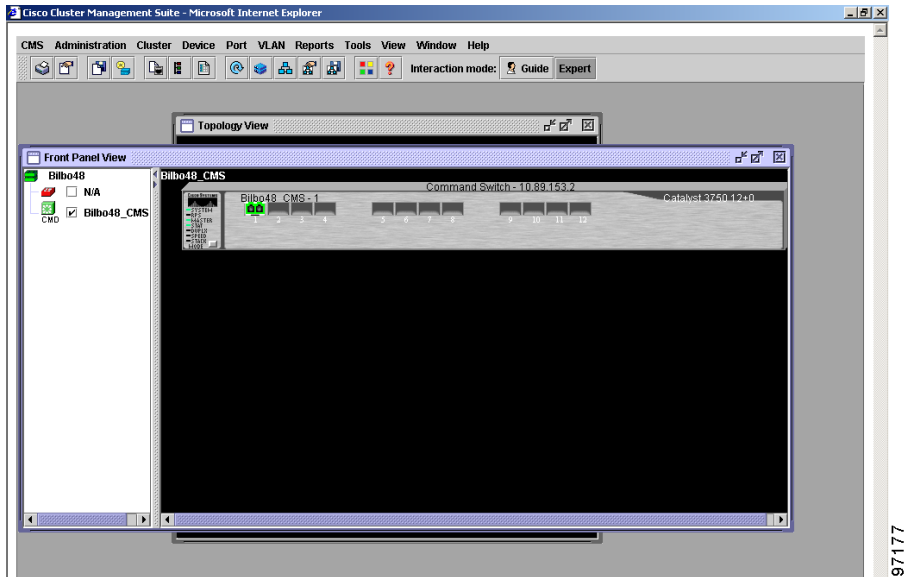

For more information about the CMS, refer to the software configuration guide or to the online help.

## CMS Requirements

These sections list the recommended platform configurations and supported operating systems, web browsers, and Java plug-ins for running CMS:

- [Operating System and Browser Support, page C-6](#)
- [Operating System and Browser Support, page C-6](#)
- [Supported Java Plug-Ins, page C-7](#)

## Recommended Configuration for Web-Based Management

Table C-1 lists the recommended platforms for web-based management.

**Table C-1 Recommended Platform Configuration for Web-Based Management**

OS	Processor Speed	DRAM	Number of Colors	Resolution	Font Size
Windows NT 4.0 <sup>1</sup>	Pentium 300 MHz	128 MB	65,536	1024 x 768	Small
Solaris 2.5.1 or higher	SPARC 333 MHz	128 MB	Most colors for applications	—	Small (3)

1. Service Pack 3 or higher is required.

The minimum PC requirement is a Pentium processor running at 233 MHz with 64 MB of DRAM. The minimum UNIX workstation requirement is a Sun Ultra 1 running at 143 MHz with 64 MB of DRAM.



### Note

These are only the recommended configurations for running the CMS. For information about all supported operating systems, see the next section.

## Operating System and Browser Support

You can access CMS by using the operating systems and browsers listed in Table C-2. CMS checks the browser version when starting a session to ensure that the browser is supported.

**Table C-2 Supported Operating Systems and Browsers**

Operating System	Minimum Service Pack or Patch	Netscape Communicator <sup>1</sup>	Microsoft Internet Explorer <sup>2</sup>
Windows 95	Service Pack 1	4.75 or 6.2	5.5 or 6.0
Windows 98	Second Edition	4.75 or 6.2	5.5 or 6.0
Windows NT 4.0	Service Pack 3 or later	4.75 or 6.2	5.5 or 6.0
Windows 2000	None	4.75 or 6.2	5.5 or 6.0
Windows XP	None	4.75 or 6.2	5.5 or 6.0
Solaris 2.5.1 or later	Sun-recommended patch cluster for the OS and Motif library patch 103461-24	4.75 or 6.2	Not supported

1. Netscape Communicator version 6.0 is not supported.
2. Service Pack 1 or higher is required for Internet Explorer 5.5.

## Supported Java Plug-Ins

One of these Java plug-ins is required for the browser to access and run the Java-based CMS:

- Java plug-in 1.4
- Java plug-in 1.3.1

These Java plug-ins are supported both in Windows environments and on Solaris platforms. You can download the plug-ins and installation instructions from this URL:

<http://www.cisco.com/pcgi-bin/tablebuild.pl/java>



### Note

Only one of these Java plug-ins is required for CMS. Do not install more than one.

On Solaris platforms, follow the instructions in the README\_FIRST.txt file to install the Java plug-in.

## Java Plug-In Notes

These notes apply to the Java plug-in configuration:

- To verify that a supported version of the Java plug-in is installed, select **Start > Settings > Control Panel**. The Java plug-in is listed with the version number in the Control Panel menu.
- If you have installed the Java plug-in but CMS still does not launch, make sure that the plug-in is enabled by selecting **Start > Settings > Control Panel > Java Plug-in**. Click the Basic tab, select Enable Java Plug-in, and click Apply.
- If the Java applet does not initialize after you have installed and enabled the plug-in, open the Java Plug-in Control Panel (**Start > Programs > Java Plug-in Control Panel**), and verify these settings:

In the Proxies tab, verify that **Use browser settings** is checked and that no proxies are enabled.

- If you are running an Internet virus checker on Windows 2000 and the plug-in takes a long time to load, you can speed up CMS operation by disabling the virus checker filter option, the download option, or both.

From the Start menu on McAfee VirusScan, disable the VirusScan Internet Filter option, the Download Scan option, or both by selecting **Start > Programs > Network Associates > Virus Scan Console > Configure**.

or

From the taskbar, right-click the Virus Shield icon and in the Quick Enable menu, disable the options by deselecting **Internet Filter** or **Download Scan**.

## Where to Go Next

For more information about the CMS, refer to the software configuration guide or to the online help.





## Quick Setup By Using the CLI-Based Setup Program

---

This chapter provides a quick step-by-step installation and setup procedure for a standalone switch or a switch stack.



### Note

---

For detailed installation procedures on rack-mounting your switch, stacking your switches, or connecting to the small form-factor pluggable (SFP) modules, see [Chapter 3, “Switch Installation.”](#) For product overview information, see [Chapter 2, “Product Overview.”](#)

---

These steps describe how to do a simple installation:

1. [Methods for Accessing the CLI, page D-2](#)
2. [Taking Out What You Need, page D-4](#)
3. [Stacking the Switches \(Optional\), page D-5](#)
4. [Connecting to the Console Port, page D-7](#)
5. [Starting the Terminal Emulation Software, page D-9](#)
6. [Connecting to a Power Source, page D-9](#)
7. [Entering the Initial Configuration Information, page D-10](#)

# Methods for Accessing the CLI

You can access the CLI by these methods:

- [Accessing the CLI Through Express Setup \(Unconfigured Switch Only\)](#), page D-2
- [Accessing the CLI Through the Console Port](#), page D-3

## Accessing the CLI Through Express Setup (Unconfigured Switch Only)



### Note

Express Setup is supported on switches running Cisco IOS Release 12.1(14)EA1 or later. If you are installing a new switch, refer to the Cisco IOS release label on the rear panel of the switch to determine the release.

For switches running releases earlier than Cisco IOS Release 12.1(14)EA1, go to the [“Taking Out What You Need”](#) section on page D-4.

You can access the CLI on an unconfigured switch by placing the switch in Express Setup mode and then connecting an Ethernet port of the switch to the Ethernet port of your PC or workstation. To put the switch into Express Setup mode, follow the steps described in these sections of [Chapter 1, “Using Express Setup”](#):

- [Taking Out What You Need](#), page 1-2
- [Powering On the Switch](#), page 1-3
- [Starting Express Setup](#), page 1-4

After the switch is in Express Setup mode, Telnet to the switch by using the IP address *10.0.0.1*, and enter the **setup** user EXEC command. See these sections in this chapter to then configure the switch by using the CLI:

- [Entering the Initial Configuration Information](#), page D-10
- [Completing the Setup Program](#), page D-11

After you have entered the configuration information for the switch, save it to Flash memory by using the **write memory** privileged EXEC command.

**Note**

---

While in Express Setup mode, the IP address 10.0.0.1 remains active on the switch until you enter the **write memory** command. You lose the Telnet connection after entering the **write memory** command.

---

For more information about using the CLI, refer to the command reference for this release.

## Accessing the CLI Through the Console Port

You can access the CLI by connecting the console port of the switch to the serial port on your PC or workstation and access the switch through a Telnet session. To access the switch through the console port, follow the steps in the rest of this chapter, beginning with the [“Taking Out What You Need”](#) section on page D-4.

# Taking Out What You Need

Remove the items shown in Figure D-1 from the shipping container:

**Figure D-1** The Catalyst 3750 Switch, Adapter Cable, AC Power Cord, and the StackWise Cable

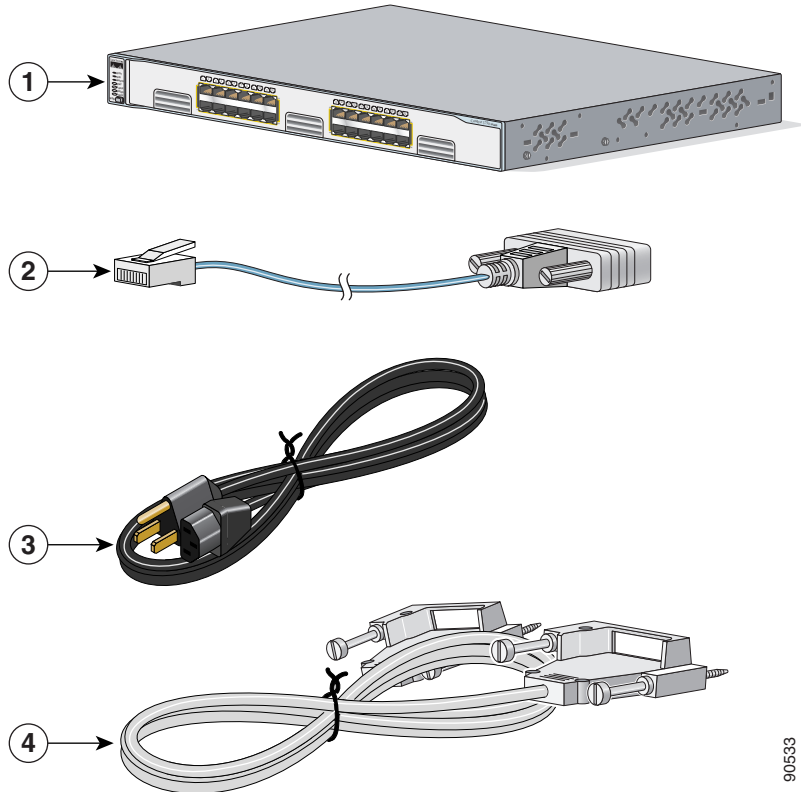

<b>1</b>	Catalyst 3750 switch	<b>3</b>	AC power cord
<b>2</b>	RJ-45-to-DB-9 adapter cable	<b>4</b>	StackWise cable (optional)

90533



**Note** You need to provide the Category 5 straight-through cables to connect the switch ports to other Ethernet devices.



**Note** On switches running Cisco IOS Release 12.1(14)EA1 or later, you can use the **mdix auto** command to enable the automatic crossover feature. When the automatic crossover feature is enabled, the switch detects the required cable type and configures the interfaces accordingly. Therefore, you can use either a crossover or a straight-through cable for all connections to an Ethernet port on the switch.

The automatic crossover feature is disabled by default. For configuration information for this feature, refer to the switch software configuration guide or the switch command reference.

## Stacking the Switches (Optional)

You can stack up to nine switches by using the StackWise cables and ports to connect the switches.

Read the “[Planning the Stack](#)” section on page 3-12 before you stack your switches.

**Figure D-2** Stacking the Switches

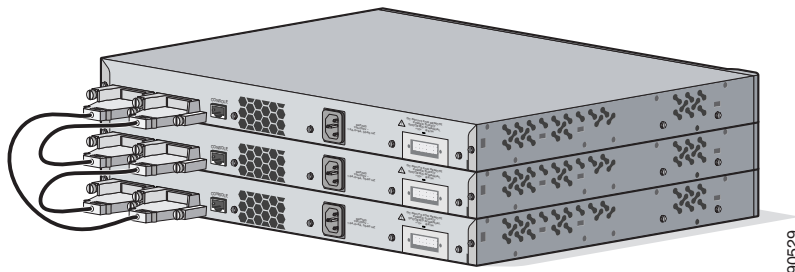

90529

## Stacking the Switches (Optional)

---

**Step 1** Insert one end of the StackWise cable into the StackWise port at the back of a switch. See Figure D-3.



**Note** Always use a Cisco-approved StackWise cable to connect the switches.

---

**Step 2** Use the window in the StackWise cable to align the connector correctly. Secure the screws tightly.

**Step 3** Insert the other end of the cable into the connector of the other switch, and secure the screws tightly.

---

See the [“Connecting StackWise Cable to StackWise Ports”](#) section on page 3-37 for detailed installation procedures on how to connect the switches in a stack.

**Figure D-3** Connecting the StackWise Cable to a StackWise Port

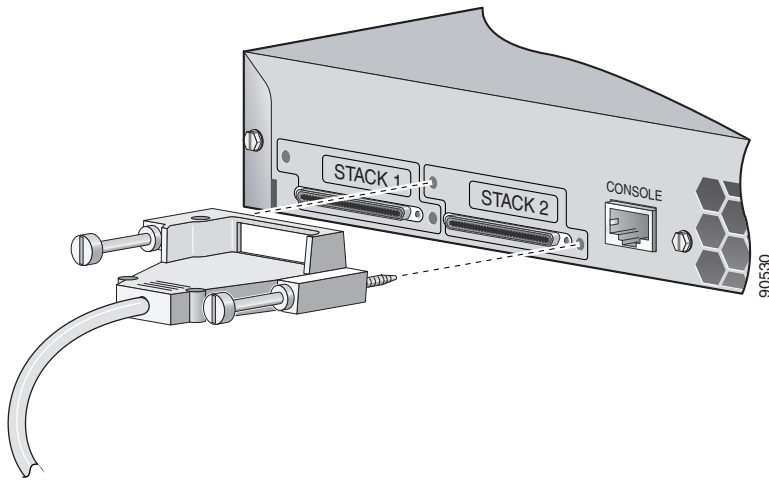

# Connecting to the Console Port

You can use the console port to perform the initial configuration. To connect the switch console port to a PC, use the supplied RJ-45-to-DB-9 adapter cable.

**Note**

---

If you have stacked your switches, connect to the console port of one of the switches in the stack. The initial configuration for the entire stack can be performed on any switch in the stack.

---

Follow these steps to connect the PC or terminal to the switch:

- 
- Step 1** Using the supplied RJ-45-to-DB-9 adapter cable, insert the RJ-45 connector into the console port on the rear of a switch, as shown in [Figure D-4](#).
- Step 2** Attach the DB-9 female DTE of the adapter cable to a PC's serial port, or attach an appropriate adapter to the terminal.
-

Figure D-4 Connecting a Switch to a PC

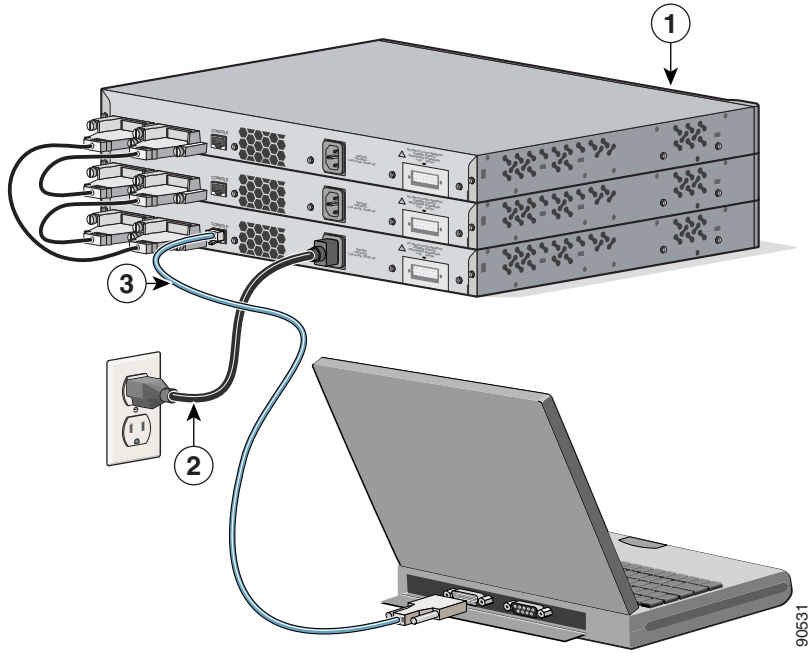

1	Catalyst 3750 switches	3	RJ-45-to-DB-9 adapter cable
2	Power cord		

90531



# Starting the Terminal Emulation Software

Before you power on the switch, start the terminal emulation session so that you can see the output display from the power-on self-test (POST).

The terminal-emulation software—frequently a PC application such as Hyperterminal or ProcommPlus—makes communication between the switch and your PC or terminal possible.

- 
- Step 1** Start the terminal-emulation program if you are using a PC or terminal.
- Step 2** Start a terminal-emulation session.
- Step 3** Configure the baud rate and character format of the PC or terminal to match these console port default characteristics:
- 9600 baud
  - 8 data bits
  - 1 stop bit
  - No parity
  - None (flow control)
- 

# Connecting to a Power Source

Follow these steps to connect to a power source:

- 
- Step 1** Connect one end of the supplied AC power cord to the power connector on a switch rear panel. See [Figure D-4](#).
- Step 2** Connect the other end of the power cable to a grounded AC outlet.
- Step 3** (Optional) If you have a stack, power on all the switches in the stack.



---

**Note** If you have stacked your switches, refer to the [“Powering Considerations” section on page 3-13](#) for more information.

---

**Note**

---

If you are connecting the switch to a Cisco redundant power system (RPS), refer to the documentation that shipped with your RPS.

---

As the switch powers on, it begins POST, a series of tests that run automatically to ensure that the switch functions properly. If POST fails, see [Chapter 4, “Troubleshooting,”](#) to determine a course of action.

---

After you have powered all the switches in the stack, a switch is elected as the stack master. The master LED is green on the stack master switch.

If you started the terminal emulation program before you powered on your switch, the PC or terminal displays the bootloader sequence. You need to press **Enter** to display the setup program prompt.

## Entering the Initial Configuration Information

To set up the switch, you need to complete the setup program, which runs automatically after the switch is powered up. You must assign an IP address and other configuration information necessary for the switch to communicate with the local routers and the Internet. This information is also required if you plan to use the Cluster Management Suite (CMS) to configure and manage the switch.

### IP Settings

You will need this information from your network administrator before you complete the setup program:

- Switch IP address
- Subnet mask (IP netmask)
- Default gateway (router)
- Enable secret password
- Enable password
- Telnet password

## Completing the Setup Program

**Note**

If your switches are stacked and there are multiple console connections to individual switches in the stack, the initial setup dialog appears in the first console where the user presses **Enter**.

Follow these steps to complete the setup program and to create an initial configuration for the switch:

**Step 1** Enter **Yes** at the following two prompts.

```
Would you like to enter the initial configuration dialog? [yes/no]:
```

```
yes
```

```
At any point you may enter a question mark '?' for help.
```

```
Use ctrl-c to abort configuration dialog at any prompt.
```

```
Default settings are in square brackets '[]'.
```

```
Basic management setup configures only enough connectivity  
for management of the system, extended setup will ask you  
to configure each interface on the system.
```

```
Would you like to enter basic management setup? [yes/no]: yes
```

**Step 2** Enter a host name for the switch, and press **Return**.

On a command switch, the host name is limited to 28 characters; on a member switch to 31 characters. Do not use *-n*, where *n* is a number, as the last character in a host name for any switch.

```
Enter host name [Switch]: host_name
```

**Step 3** Enter an enable secret password, and press **Return**.

The password can be from 1 to 25 alphanumeric characters, can start with a number, is case sensitive, allows spaces, but ignores leading spaces. The secret password is encrypted and the enable password is in plain text.

```
Enter enable secret: secret_password
```

**Step 4** Enter an enable password, and press **Return**.

```
Enter enable password: enable_password
```

- Step 5** Enter a virtual terminal (Telnet) password, and press **Return**.

The password can be from 1 to 25 alphanumeric characters, is case sensitive, allows spaces, but ignores leading spaces.

Enter virtual terminal password: *terminal-password*

- Step 6** (Optional) Configure Simple Network Management Protocol (SNMP) by responding to the prompts. You can also configure SNMP later through the CLI or CMS interface. To configure SNMP later type **no**.

Configure SNMP Network Management? [no]: **no**

- Step 7** Enter the interface name (physical interface or VLAN name) of the interface that connects to the management network, and press **Return**. For this release, always use **vlan1** as that interface.

Enter interface name used to connect to the management network from the above interface summary: **vlan1**

- Step 8** Configure the interface by entering the switch IP address and subnet mask and pressing **Return**. The IP address and subnet masks shown below are examples.

```
Configuring interface vlan1:
Configure IP on this interface? [yes]: yes
IP address for this interface: 10.4.120.106
Subnet mask for this interface [255.0.0.0]: 255.0.0.0
```

- Step 9** Enter **Y** to configure the switch as the cluster command switch. Enter **N** to configure it as a member switch or as a standalone switch.

If you enter **N**, the switch appears as a candidate switch in the CMS. You can configure the switch as a command switch later through the CLI or CMS interface. To configure it later type **no**.

Would you like to enable as a cluster command switch? [yes/no]: **no**

You have now completed the initial configuration of the switch and the switch displays its initial configuration. This is an example of output that appears:

```
The following configuration command script was created:
hostname switch1
enable secret 5 $1$U1q8$D1A/OiaEbl90WcBpd9cOn1
enable password enable_password
line vty 0 15
password terminal-password
no snmp-server
!
no ip routing
```

```
!  
interface Vlan1  
no shutdown  
ip address 10.4.120.106 255.0.0.0  
!  
interface FastEthernet1/0/1  
!  
interface FastEthernet1/0/2  
  
interface FastEthernet1/0/3  
!  
...<output abbreviated>  
!  
interface GigabitEthernet2/0/28  
!  
end
```

**Step 10** These choices are displayed:

- [0] Go to the IOS command prompt without saving this config.
- [1] Return back to the setup without saving this config.
- [2] Save this configuration to nvram and exit.

If you want to save the configuration and use it the next time the switch reboots, save it in nonvolatile RAM (NVRAM) by selecting option 2.

Enter your selection [2]:2

Make your selection, and press **Return**.

---

After you complete the setup program, the switch can run the default configuration that you created. If you want to change this configuration or want to perform other management tasks, use one of these tools:

- Command-line interface (CLI)
- CMS from your browser

To use the CLI, enter commands at the *Switch>* prompt through the console port by using a terminal program or through the network by using telnet. For configuration information, refer to the switch software configuration guide or the switch command reference.

To use the CMS, go to [Appendix C, “Managing the Switch by Using the Cluster Management Suite.”](#)



## Translated Safety Warnings

---

This appendix repeats in multiple languages the warnings in this guide. These translated warnings can be used with other documents related to this guide.

### Attaching the Cisco RPS (model PWR300-AC-RPS-N1)

	
<b>Warning</b>	<b>Attach only the Cisco RPS (model PWR300-AC-RPS-N1) to the RPS receptacle.</b>
<b>Waarschuwing</b>	<b>Slechts de Cisco RPS (model PWR300-AC-RPS-N1) aan de RPS contactdoos verbinden.</b>
<b>Varoitus</b>	<b>Kiinnitä RPS-vastakappaleeseen vain Cisco RPS (malli PWR300-AC-RPS-N1).</b>
<b>Avertissement</b>	<b>Raccordez le bloc d'alimentation Cisco RPS (modèle PWR300-AC-RPS-N1) uniquement au connecteur RPS.</b>
<b>Warnung</b>	<b>An die RPS-Steckhülse darf nur das Cisco RPS (Modell PWR300-AC-RPS-N1) angeschlossen werden.</b>
<b>Avvertenza</b>	<b>Collegare soltanto il Cisco RPS (modello PWR300-AC-RPS-N1) alla presa RPS.</b>

## ■ Attaching the Cisco RPS (model PWR675-AC-RPS-N1)

**Advarsel!** Koble bare Cisco RPS (modell PWR300-AC-RPS-N1) til RPS-stikkontakten.

**Aviso** Anexe o RPS Cisco (modelo PWR300-AC-RPS-N1) apenas ao receptáculo RPS.

**¡Advertencia!** Sólo conecte el Cisco RPS (modelo PWR300-AC-RPS-N1) al receptáculo RPS.

**Varning!** Koppla endast Ciscos RPS (modell PWR300-AC-RPS-N1) till RPS-uttaget.

**Figyelem** Az RPS csatlakozóhoz csak Cisco RPS (PWR300-AC-RPS-N1 modell) aljzatot csatlakoztasson.

**Предупреждение** К гнезду RPS можно подключать только системы питания Cisco RPS (модель PWR300-AC-RPS-N1).

**警告** 只能将 Cisco RPS (型号 PWR300-AC-RPS-N1) 连接到 RPS 插座。

**警告** RPS レセプタクルには、Cisco RPS (モデル番号 PWR300-AC-RPS-N1) だけを接続してください。

# Attaching the Cisco RPS (model PWR675-AC-RPS-N1)



**Warning**

**Attach only the Cisco RPS (model PWR675-AC-RPS-N1) to the RPS receptacle.**

**Waarschuwing**

**Slechts de Cisco RPS (model PWR675-AC-RPS-N1) aan de RPS contactdoos verbinden.**

**Varoitus**

**Kiinnitä RPS-vastakappaleeseen vain Cisco RPS (malli PWR675-AC-RPS-N1).**



<b>Avertissement</b>	<b>Raccordez le bloc d'alimentation Cisco RPS (modèle PWR675-AC-RPS-N1) uniquement au connecteur RPS.</b>
<b>Warnung</b>	<b>An die RPS-Steckhülse darf nur das Cisco RPS (Modell PWR675-AC-RPS-N1) angeschlossen werden.</b>
<b>Avvertenza</b>	<b>Collegare soltanto il Cisco RPS (modello PWR675-AC-RPS-N1) alla presa RPS.</b>
<b>Advarsel!</b>	<b>Koble bare Cisco RPS (modell PWR675-AC-RPS-N1) til RPS-stikkontaktene.</b>
<b>Aviso</b>	<b>Anexe o RPS Cisco (modelo PWR675-AC-RPS-N1) apenas ao receptáculo RPS.</b>
<b>¡Advertencia!</b>	<b>Sólo conecte el Cisco RPS (modelo PWR675-AC-RPS-N1) al receptáculo RPS.</b>
<b>Varning!</b>	<b>Koppla endast Ciscos RPS (modell PWR675-AC-RPS-N1) till RPS-uttaget.</b>
<b>Figyelem</b>	<b>Az RPS csatlakozóhoz csak Cisco RPS (PWR675-AC-RPS-N1 modell) aljzatot csatlakoztasson.</b>
<b>Предупреждение</b>	<b>К гнезду RPS можно подключать только системы питания Cisco RPS (модель PWR675-AC-RPS-N1=).</b>
<b>警告</b>	<b>只能将 Cisco RPS (型号 PWR675-AC-RPS-N1=) 连接到 RPS 插座。</b>
<b>警告</b>	<b>RPS レセプタクルには、Cisco RPS (モデル番号 PWR675-AC-RPS-N1=) だけを接続してください。</b>

---

# Installation Warning

**Warning**

Only trained and qualified personnel should be allowed to install, replace, or service this equipment.

**Waarschuwing**

Deze apparatuur mag alleen worden geïnstalleerd, vervangen of hersteld door bevoegd geschoold personeel.

**Varoitus**

Tämän laitteen saa asentaa, vaihtaa tai huoltaa ainoastaan koulutettu ja laitteen tunteva henkilökunta.

**Attention**

Il est vivement recommandé de confier l'installation, le remplacement et la maintenance de ces équipements à des personnels qualifiés et expérimentés.

**Warnung**

Das Installieren, Ersetzen oder Bedienen dieser Ausrüstung sollte nur geschultem, qualifiziertem Personal gestattet werden.

**Avvertenza**

Questo apparato può essere installato, sostituito o mantenuto unicamente da un personale competente.

**Advarsel**

Bare opplært og kvalifisert personell skal foreta installasjoner, utskiftninger eller service på dette utstyret.

**Aviso**

Apenas pessoal treinado e qualificado deve ser autorizado a instalar, substituir ou fazer a revisão deste equipamento.

**¡Advertencia!**

Solamente el personal calificado debe instalar, reemplazar o utilizar este equipo.

**Varning!**

Endast utbildad och kvalificerad personal bör få tillåtelse att installera, byta ut eller reparera denna utrustning.

# Installation Instructions

**Warning**

**Read the installation instructions before connecting the system to the power source.**

**Waarschuwing**

**Raadpleeg de installatie-instructies voordat u het systeem op de voedingsbron aansluit.**

**Varoitus**

**Lue asennusohjeet ennen järjestelmän yhdistämistä virtalähteeseen.**

**Attention**

**Avant de brancher le système sur la source d'alimentation, consulter les directives d'installation.**

**Warnung**

**Vor dem Anschließen des Systems an die Stromquelle die Installationsanweisungen lesen.**

**Avvertenza**

**Consultare le istruzioni di installazione prima di collegare il sistema all'alimentatore.**

**Advarsel**

**Les installasjonsinstruksjonene før systemet kobles til strømkilden.**

**Aviso**

**Leia as instruções de instalação antes de ligar o sistema à fonte de energia.**

**¡Advertencia!**

**Lea las instrucciones de instalación antes de conectar el sistema a la red de alimentación.**

**Varning!**

**Läs installationsanvisningarna innan du kopplar systemet till strömförsörjningsenheten.**

**Figyelem**

**Mielőtt áramforráshoz csatlakoztatná a rendszert, olvassa el az üzembe helyezési útmutatót!**

**Предупреждение**

**Перед подключением устройства к источнику электропитания ознакомьтесь с данной инструкцией по установке.**

## Jewelry Removal Warning

警告 在将系统与电源连接之前，请仔细阅读安装说明。

警告 必ず設置手順を読んでから、システムを電源に接続してください。

# Jewelry Removal Warning



## Warning

**Before working on equipment that is connected to power lines, remove jewelry (including rings, necklaces, and watches). Metal objects will heat up when connected to power and ground and can cause serious burns or weld the metal object to the terminals.**

## Waarschuwing

**Alvorens aan apparatuur te werken die met elektrische leidingen is verbonden, sieraden (inclusief ringen, kettingen en horloges) verwijderen. Metalen voorwerpen worden warm wanneer ze met stroom en aarde zijn verbonden, en kunnen ernstige brandwonden veroorzaken of het metalen voorwerp aan de aansluitklemmen lassen.**

## Varoitus

**Ennen kuin työskentelet voimavirtajohtoihin kytkettyjen laitteiden parissa, ota pois kaikki korut (sormukset, kaulakorut ja kellot mukaan lukien). Metalliesineet kuumenevat, kun ne ovat yhteydessä sähkövirran ja maan kanssa, ja ne voivat aiheuttaa vakavia palovammoja tai hitsata metalliesineet kiinni liitännänapoihin.**

## Attention

**Avant d'accéder à cet équipement connecté aux lignes électriques, ôter tout bijou (anneaux, colliers et montres compris). Lorsqu'ils sont branchés à l'alimentation et reliés à la terre, les objets métalliques chauffent, ce qui peut provoquer des blessures graves ou souder l'objet métallique aux bornes.**

<b>Warnung</b>	<b>Vor der Arbeit an Geräten, die an das Netz angeschlossen sind, jeglichen Schmuck (einschließlich Ringe, Ketten und Uhren) abnehmen. Metallgegenstände erhitzen sich, wenn sie an das Netz und die Erde angeschlossen werden, und können schwere Verbrennungen verursachen oder an die Anschlußklemmen angeschweißt werden.</b>
<b>Avvertenza</b>	<b>Prima di intervenire su apparecchiature collegate alle linee di alimentazione, togliersi qualsiasi monile (inclusi anelli, collane, braccialetti ed orologi). Gli oggetti metallici si riscaldano quando sono collegati tra punti di alimentazione e massa: possono causare ustioni gravi oppure il metallo può saldarsi ai terminali.</b>
<b>Advarsel</b>	<b>Fjern alle smykker (inkludert ringer, halskjeder og klokker) før du skal arbeide på utstyr som er koblet til kraftledninger. Metallgjenstander som er koblet til kraftledninger og jord blir svært varme og kan forårsake alvorlige brannskader eller smelte fast til polene.</b>
<b>Aviso</b>	<b>Antes de trabalhar em equipamento que esteja ligado a linhas de corrente, retire todas as jóias que estiver a usar (incluindo anéis, fios e relógios). Os objectos metálicos aquecerão em contacto com a corrente e em contacto com a ligação à terra, podendo causar queimaduras graves ou ficarem soldados aos terminais.</b>
<b>¡Advertencia!</b>	<b>Antes de operar sobre equipos conectados a líneas de alimentación, quitarse las joyas (incluidos anillos, collares y relojes). Los objetos de metal se calientan cuando se conectan a la alimentación y a tierra, lo que puede ocasionar quemaduras graves o que los objetos metálicos queden soldados a los bornes.</b>
<b>Varning!</b>	<b>Tag av alla smycken (inklusive ringar, halsband och armbandsur) innan du arbetar på utrustning som är kopplad till kraftledningar. Metallobjekt hettas upp när de kopplas ihop med ström och jord och kan förorsaka allvarliga brännskador; metallobjekt kan också sammansvetsas med kontaktarna.</b>
<b>Figyelem</b>	<b>Mielőtt hálózati feszültséghez csatlakozó készülékkel kezd el dolgozni, vegye le magáról az ékszereket (például gyűrűt, nyakláncot, órát). A fém tárgyak felmelegszenek, ha hálózati feszültséghez és földhöz érnek, és súlyos égési sérülést okozhatnak, illetve a fém tárgyak hozzáforrhhatnak a csatlakozókhoz.</b>

## Stacking the Chassis Warning

<b>Предупреждение</b>	Прежде чем использовать оборудование, подключенное к электросети, снимите все украшения (включая кольца, ожерелья и часы). Металлические части нагреваются при соединении с источником питания и землей, что может привести к серьезным ожогам или привариванию металлических объектов к клеммам.
<b>警告</b>	在操作与电源线连接的设备以前，请取下首饰（包括戒指、项链和手表）。连接电源和接地后，金属物品会升温，可能导致严重灼伤，也可能使金属物品熔接在线端。
<b>警告</b>	電源に接続されている装置を取り扱う際は、事前に、指輪、ネックレス、腕時計などの装身具をはずしてください。金属のオブジェクトが電源とアースと接触すると、金属が過熱して大やけどをしたり、また金属類が端子に焼き付くことがあります。

# Stacking the Chassis Warning



## Warning

**Do not stack the chassis on any other equipment. If the chassis falls, it can cause severe bodily injury and equipment damage.**

## Waarschuwing

**Het chassis mag niet op andere apparatuur gestapeld te worden. Als het chassis mocht vallen, kan dit ernstig lichamelijk letsel en beschadiging van de apparatuur veroorzaken.**

## Varoitus

**Älä aseta asennuspohjaa minkään muun laitteen päälle. Asennuspohja voi pudotessaan aiheuttaa vaikean ruumiinvamman tai laitevaurion.**

## Avertissement

**Ne placez pas ce châssis sur un autre appareil. En cas de chute, il pourrait provoquer de graves blessures corporelles et d'importants dommages.**

## Achtung

**Das Gehäuse nicht auf andere Geräte stellen. Wenn das Gehäuse herunterfällt, besteht Gefahr schwerer Personenverletzungen und Geräteschäden.**

<b>Avvertenza</b>	<b>Non collocare lo chassis su nessun altro apparecchio. Se lo chassis cade, può causare lesioni gravi e danni alle apparecchiature.</b>
<b>Advarsel</b>	<b>Stable ikke kabinettet oppå annet utstyr. Hvis kabinettet faller, kan det forårsake alvorlig skade på mennesker og utstyr.</b>
<b>Aviso</b>	<b>Não coloque o chassis em cima de qualquer outro equipamento. Se o chassis cair, poderá causar ferimentos graves e danos no equipamento.</b>
<b>¡Atención!</b>	<b>No apilar los chasis sobre ningún otro equipo. Si el chasis se cae al suelo puede causar graves lesiones físicas y daños al equipo.</b>
<b>Varning</b>	<b>Placera inte chassit ovanpå annan utrustning. Om chassit faller kan allvarlig kroppsskada såväl som skada på utrustningen uppstå.</b>
<b>Figyelem</b>	<b>A készüléket ne tegye rá másik készülékre. Ha a készülék leesik, súlyos testi sérülést okozhat, és maga a készülék is megkárosodhat.</b>
<b>Предупреждение</b>	Не устанавливайте данное устройство на любое другое оборудование. Если устройство упадет, то это может привести к тяжелым травмам и повреждению оборудования.
<b>警告</b>	不要将底盘堆放在其它任何设备上。如果底盘倒下，可能使身体受伤并损坏设备。
<b>警告</b>	別のいかなる装置の上にもシャーシを載せないでください。シャーシを落とすと、大けがをしたり装置を損傷させたりする場合があります。

---

# Main Disconnecting Device



## Warning

The plug-socket combination must be accessible at all times, because it serves as the main disconnecting device.

## Waarschuwing

De combinatie van de stekker en het elektrisch contactpunt moet te allen tijde toegankelijk zijn omdat deze het hoofdmecanisme vormt voor verbreking van de aansluiting.

## Varoitus

Pistoke/liitinkohta toimii pääkatkaisumekanismina. Pääsy siihen on pidettävä aina esteettömänä.

## Attention

La combinaison de prise de courant doit être accessible à tout moment parce qu'elle fait office de système principal de déconnexion.

## Warnung

Der Netzkabelanschluß am Gerät muß jederzeit zugänglich sein, weil er als primäre Ausschaltvorrichtung dient.

## Avvertenza

Il gruppo spina-presa deve essere sempre accessibile, poiché viene utilizzato come dispositivo di scollegamento principale.

## Advarsel

Kombinasjonen støpsel/uttak må alltid være tilgjengelig ettersom den fungerer som hovedfrakoplingsenhet.

## Aviso

A combinação ficha-tomada deverá ser sempre acessível, porque funciona como interruptor principal.

## ¡Advertencia!

El conjunto de clavija y toma ha de encontrarse siempre accesible ya que hace las veces de dispositivo de desconexión principal.

## Varning!

Man måste alltid kunna komma åt stickproppen i uttaget, eftersom denna koppling utgör den huvudsakliga frånkopplingsanordningen.

## Figyelem

A dugaszolóaljzat és a dugasz együttesének mindig hozzáférhetőnek kell lennie, mivel ez szolgál főmegszakítóként.



<b>Предупреждение</b>	Штепсельная розетка всегда должна быть доступна, поскольку она служит основным устройством отключения.
<b>警告</b>	插销和插座必须便于随时插拔，因为它是主要断电设备。
<b>警告</b>	主要な切断装置となるので、プラグとソケットは常に手が届く場所に置く必要があります。

---

## Grounded Equipment Warning



### Warning

**This equipment is intended to be grounded. Ensure that the host is connected to earth ground during normal use.**

### Waarschuwing

**Deze apparatuur hoort geaard te worden. Zorg dat de host-computer tijdens normaal gebruik met aarde is verbonden.**

### Varoitus

**Tämä laitteisto on tarkoitettu maadoitettavaksi. Varmista, että isäntälaitte on yhdistetty maahan normaalikäytön aikana.**

### Attention

**Cet équipement doit être relié à la terre. S'assurer que l'appareil hôte est relié à la terre lors de l'utilisation normale.**

### Warnung

**Dieses Gerät muß geerdet werden. Stellen Sie sicher, daß das Host-Gerät während des normalen Betriebs an Erde gelegt ist.**

### Avvertenza

**Questa apparecchiatura deve essere collegata a massa. Accertarsi che il dispositivo host sia collegato alla massa di terra durante il normale utilizzo.**

### Advarsel

**Dette utstyret skal jordes. Forviss deg om vertsterminalen er jordet ved normalt bruk.**

<b>Aviso</b>	<b>Este equipamento deverá estar ligado à terra. Certifique-se que o host se encontra ligado à terra durante a sua utilização normal.</b>
<b>¡Advertencia!</b>	<b>Este equipo debe conectarse a tierra. Asegurarse de que el equipo principal esté conectado a tierra durante el uso normal.</b>
<b>Varning!</b>	<b>Denna utrustning är avsedd att jordas. Se till att värdenheten är jordad vid normal användning.</b>
<b>Figyelem</b>	<b>A készüléket védőföldeléssel kell ellátni. Győződjön meg róla, hogy a készülék normál használat során csatlakozik a földhöz.</b>
<b>Предупреждение</b>	<b>Данное устройство должно быть заземлено. Убедитесь, что при обычной работе устройство заземлено.</b>
<b>警告</b>	<b>此设备应该接地。请确保主机在正常使用期间连接接地。</b>
<b>警告</b>	<b>この装置はアースに接続するものです。通常の使用では、ホストがアース端子に接続されていることを確認してください。</b>

## Installing or Replacing the Unit



### Warning

**When installing or replacing the unit, the ground connection must always be made first and disconnected last.**

### Waarschuwing

**Bij installatie of vervanging van het toestel moet de aardverbinding altijd het eerste worden gemaakt en het laatste worden losgemaakt.**

### Varoitus

**Laitetta asennettaessa tai korvattaessa on maahan yhdistäminen aina tehtävä ensiksi ja maadoituksen irti kytkeminen viimeiseksi.**

<b>Attention</b>	<b>Lors de l'installation ou du remplacement de l'appareil, la mise à la terre doit toujours être connectée en premier et déconnectée en dernier.</b>
<b>Warnung</b>	<b>Der Erdanschluß muß bei der Installation oder beim Austauschen der Einheit immer zuerst hergestellt und zuletzt abgetrennt werden.</b>
<b>Avvertenza</b>	<b>In fase di installazione o sostituzione dell'unità, eseguire sempre per primo il collegamento a massa e disconnetterlo per ultimo.</b>
<b>Advarsel</b>	<b>Når enheten installeres eller byttes, må jordledningen alltid tilkobles først og frakobles sist.</b>
<b>Aviso</b>	<b>Ao instalar ou substituir a unidade, a ligação à terra deverá ser sempre a primeira a ser ligada, e a última a ser desligada.</b>
<b>¡Advertencia!</b>	<b>Al instalar o sustituir el equipo, conecte siempre la toma de tierra al principio y desconéctela al final.</b>
<b>Varning!</b>	<b>Vid installation eller utbyte av enheten måste jordledningen alltid anslutas först och kopplas bort sist.</b>
<b>Figyelem</b>	<b>A készülék üzembe helyezése és cserélése közben mindig a földelés vezetéket kell elsőként csatlakoztatni és azt kell utolsóként leválasztani.</b>
<b>Предупреждение</b>	При установке или замене устройства контакт заземления должен подключаться первым, а отключаться последним.
<b>警告</b>	安装或更换该部件时，必须首先进行接地连接，而接地连接的断开应在最后进行。
<b>警告</b>	装置を設置または交換するときは、必ずアースを最初に接続し、最後に切断します。

# Overtemperature Warning



## Warning

To prevent the switch from overheating, do not operate it in an area that exceeds the maximum recommended ambient temperature of 113°F (45°C). To prevent airflow restriction, allow at least 3 inches (7.6 cm) of clearance around the ventilation openings.

## Waarschuwing

Om oververhitting van de schakelaar te voorkomen, mag u die niet bedienen in een ruimte die de maximale aanbevolen omgevingstemperatuur van 113°F (45°C) overschrijdt. Om beperking van de luchtstroom te voorkomen, dient u ten minste 3 inch (7,6 cm) speling te laten rondom de ventilatie-openingen.

## Varoitus

Estääksesi kytkimen ylikuumentumisen älä käytä sitä sellaisissa paikoissa, joiden lämpötila ylittää ympäristön enimmäislämpötilaksi suositellun 45°C. Jätä vähintään 7,6 cm:n vapaa tila tuuletusaukkojen ympärille, jotta ilma pääsee vapaasti virtaamaan.

## Attention

Pour éviter une surchauffe du commutateur, ne pas le faire fonctionner dans un local dont la température ambiante dépasse le maximum recommandé de 45°C (113°F). Pour faciliter la circulation d'air, aménager un dégagement d'au moins 7,6 cm (3 pouces) autour des bouches d'aération.

## Warnung

Um eine Überhitzung des Schalters zu vermeiden, ist das System nicht in einem Bereich zu betreiben, in dem die empfohlene Höchsttemperatur von 45°C überschritten wird. Damit der Luftfluß nicht behindert wird, ist ein Freiraum von mindestens 7,6 cm um die Belüftungsöffnungen herum einzuhalten.

## Avvertenza

Per evitare il surriscaldamento dell'interruttore, non usare l'apparecchiatura in un'area che supera la temperatura ambientale minima consigliata di 45°C. Per evitare una limitazione del flusso dell'aria, lasciare come minimo uno spazio libero di 7,6 cm intorno alle aperture di ventilazione.

<b>Advarsel</b>	<b>For å unngå at bryteren overopphetes skal utstyret ikke brukes på steder hvor anbefalt maks omgivelsestemperatur overstiger 113 grader Farenheit (45°C). La det være minst 3 tommer (7,6 cm) klaring rundt ventilasjonsåpningene for at luftsirkulasjonen skal være uhindret.</b>
<b>Aviso</b>	<b>Para evitar sobreaquecimento do interruptor, não utilize o equipamento numa área que exceda uma temperatura máxima de 45°C. Para evitar o bloqueamento da circulação de ar, deixe pelo menos um espaço de 7.6 cm em volta das aberturas de ventilação.</b>
<b>¡Advertencia!</b>	<b>Para evitar que el interruptor se recaliente, no se debe usar en áreas cuya temperatura ambiente exceda la máxima recomendada, esto es, 45°C (113°F). Para no entorpecer la corriente de aire, dejar por lo menos 7,6 cm (3 pulgadas) de espacio muerto alrededor de la rejilla de ventilación.</b>
<b>Varning!</b>	<b>I syfte att undvika överhettning av switchen skall den inte användas i utrymmen vars temperatur överskrider den maximalt rekommenderade omgivningstemperaturen som är 45°C. Kontrollera att det finns minst 7,6 cm fritt utrymme runt ventilationsöppningarna så att luftflödet inte begränsas.</b>
<b>Figyelem</b>	<b>A túlmelegedés megelőzése végett ne üzemeltesse a kapcsolót olyan területen, ahol a hőmérséklet meghaladja a 45°C maximális ajánlott környezeti hőmérsékletet. A megfelelő légáramlás biztosítása érdekében a szellőzőnyílások körül hagyjon szabadon legalább 7,6 cm helyet.</b>
<b>Предупреждение</b>	<b>Во избежание перегрева переключателя его не следует использовать в помещениях, в которых температура воздуха выше максимальной рекомендованной: 113°F (45°C). Во избежание ограничения воздушного потока около вентиляционных отверстий должно быть не менее 3 дюймов (7,6 см) свободного пространства.</b>

## Working During Lightning Activity

**警告** 为了防止开关过热，不要在超过所建议的最大环境温度华氏 113 度（摄氏 45 度）下运行该系统。为了防止空气流量受限，要在通风口周围至少留出 3 英寸（7.6 厘米）的空间。

**警告** スイッチの加熱を防ぐため、推奨されている最高周囲温度、摂氏 45 度（華氏 113 度）を超える場所で作業をしないでください。気流の停滞を防ぐため、換気孔から 7.6cm（3 インチ）以上の間隔をとってください。

# Working During Lightning Activity



## Warning

**Do not work on the system or connect or disconnect cables during periods of lightning activity.**

## Waarschuwing

**Tijdens onweer dat gepaard gaat met bliksem, dient u niet aan het systeem te werken of kabels aan te sluiten of te ontkoppelen.**

## Varoitus

**Älä työskentele järjestelmän parissa äläkä yhdistä tai irrota kaapeleita ukkosilmalla.**

## Attention

**Ne pas travailler sur le système ni brancher ou débrancher les câbles pendant un orage.**

## Warnung

**Arbeiten Sie nicht am System und schließen Sie keine Kabel an bzw. trennen Sie keine ab, wenn es gewittert.**

## Avvertenza

**Non lavorare sul sistema o collegare oppure scollegare i cavi durante un temporale con fulmini.**

## Advarsel

**Utfør aldri arbeid på systemet, eller koble kabler til eller fra systemet når det tordner eller lynr.**

<b>Aviso</b>	<b>Não trabalhe no sistema ou ligue e desligue cabos durante períodos de mau tempo (trovoada).</b>
<b>¡Advertencia!</b>	<b>No operar el sistema ni conectar o desconectar cables durante el transcurso de descargas eléctricas en la atmósfera.</b>
<b>Varning!</b>	<b>Vid åska skall du aldrig utföra arbete på systemet eller ansluta eller koppla loss kablar.</b>
<b>Figyelem</b>	<b>Villámlás közben ne dolgozzon a rendszeren, valamint ne csatlakoztasson és ne húzzon ki kábeleket!</b>
<b>Предупреждение</b>	Не следует работать с устройством, а также подключать или отключать кабели во время грозы.
<b>警告</b>	请勿在发生雷电时操作系统，也不要在此期间连接或断开电缆。
<b>警告</b>	雷が発生しているときは、システムに手を加えたり、ケーブルの接続や取り外しを行わないでください。

## Product Disposal Warning



### Warning

**Ultimate disposal of this product should be handled according to all national laws and regulations.**

### Waarschuwing

**Het uiteindelijke wegruimen van dit product dient te geschieden in overeenstemming met alle nationale wetten en reglementen.**

### Varoitus

**Tämä tuote on hävitettävä kansallisten lakien ja määräysten mukaisesti.**

■ Product Disposal Warning

<b>Attention</b>	<b>La mise au rebut ou le recyclage de ce produit sont généralement soumis à des lois et/ou directives de respect de l'environnement. Renseignez-vous auprès de l'organisme compétent.</b>
<b>Warnung</b>	<b>Die Entsorgung dieses Produkts sollte gemäß allen Bestimmungen und Gesetzen des Landes erfolgen.</b>
<b>Avvertenza</b>	<b>Lo smaltimento di questo prodotto deve essere eseguito secondo le leggi e regolazioni locali.</b>
<b>Advarsel</b>	<b>Endelig kassering av dette produktet skal være i henhold til alle relevante nasjonale lover og bestemmelser.</b>
<b>Aviso</b>	<b>Deitar fora este produto em conformidade com todas as leis e regulamentos nacionais.</b>
<b>¡Advertencia!</b>	<b>Al deshacerse por completo de este producto debe seguir todas las leyes y reglamentos nacionales.</b>
<b>Varning!</b>	<b>Vid deponering hanteras produkten enligt gällande lagar och bestämmelser.</b>
<b>Figyelem</b>	<b>A készülék végső elhelyezéséről az adott országban érvényes törvények és előírások szerint kell intézkedni.</b>
<b>Предупреждение</b>	Окончательная установка данного изделия должна выполняться в соответствии со всеми региональными и местными правилами и нормами.
<b>警告</b>	本产品的废弃处理应根据所有国家的法律和规章进行。
<b>警告</b>	この製品を廃棄するときは、各国の法律および規制に従って処理してください。

---



# Chassis Warning for Rack-Mounting and Servicing



## Warning

To prevent bodily injury when mounting or servicing this unit in a rack, you must take special precautions to ensure that the system remains stable. The following guidelines are provided to ensure your safety:

- This unit should be mounted at the bottom of the rack if it is the only unit in the rack.
- When mounting this unit in a partially filled rack, load the rack from the bottom to the top with the heaviest component at the bottom of the rack.
- If the rack is provided with stabilizing devices, install the stabilizers before mounting or servicing the unit in the rack.

## Waarschuwing

Om lichamelijk letsel te voorkomen wanneer u dit toestel in een rek monteert of het daar een servicebeurt geeft, moet u speciale voorzorgsmaatregelen nemen om ervoor te zorgen dat het toestel stabiel blijft. De onderstaande richtlijnen worden verstrekt om uw veiligheid te verzekeren:

- Dit toestel dient onderaan in het rek gemonteerd te worden als het toestel het enige in het rek is.
- Wanneer u dit toestel in een gedeeltelijk gevuld rek monteert, dient u het rek van onderen naar boven te laden met het zwaarste onderdeel onderaan in het rek.
- Als het rek voorzien is van stabiliseringshulpmiddelen, dient u de stabilisatoren te monteren voordat u het toestel in het rek monteert of het daar een servicebeurt geeft.

## Varoitus

Kun laite asetetaan telineeseen tai huolletaan sen ollessa telineessä, on noudatettava erityisiä varotoimia järjestelmän vakavuuden säilyttämiseksi, jotta vältetään loukkaantumiselta. Noudata seuraavia turvallisuusohjeita:

- Jos telineessä ei ole muita laitteita, aseta laite telineen alaosaan.
- Jos laite asetetaan osaksi täytettyyn telineeseen, aloita kuormittaminen sen alaosasta kaikkein raskaimmalla esineellä ja siirry sitten sen yläosaan.
- Jos telinettä varten on vakaimet, asenna ne ennen laitteen asettamista telineeseen tai sen huoltamista siinä.

**Attention** Pour éviter toute blessure corporelle pendant les opérations de montage ou de réparation de cette unité en casier, il convient de prendre des précautions spéciales afin de maintenir la stabilité du système. Les directives ci-dessous sont destinées à assurer la protection du personnel:

- Si cette unité constitue la seule unité montée en casier, elle doit être placée dans le bas.
- Si cette unité est montée dans un casier partiellement rempli, charger le casier de bas en haut en plaçant l'élément le plus lourd dans le bas.
- Si le casier est équipé de dispositifs stabilisateurs, installer les stabilisateurs avant de monter ou de réparer l'unité en casier.

**Warnung** Zur Vermeidung von Körperverletzung beim Anbringen oder Warten dieser Einheit in einem Gestell müssen Sie besondere Vorkehrungen treffen, um sicherzustellen, daß das System stabil bleibt. Die folgenden Richtlinien sollen zur Gewährleistung Ihrer Sicherheit dienen:

- Wenn diese Einheit die einzige im Gestell ist, sollte sie unten im Gestell angebracht werden.
- Bei Anbringung dieser Einheit in einem zum Teil gefüllten Gestell ist das Gestell von unten nach oben zu laden, wobei das schwerste Bauteil unten im Gestell anzubringen ist.
- Wird das Gestell mit Stabilisierungszubehör geliefert, sind zuerst die Stabilisatoren zu installieren, bevor Sie die Einheit im Gestell anbringen oder sie warten.

**Figyelem!** A készülék rackbe történő beszerelése és karbantartása során bekövetkező sérülések elkerülése végett speciális óvintézkedésekkel meg kell őrizni a rendszer stabilitását. A személyes biztonsága érdekében tartsa be a következő szabályokat:

- Ha a rackben csak ez az egy készülék található, a rack aljába kell beszerelni.
- Ha nincs teljesen tele az a rack, amelybe beszerelik a készüléket, alulról fölfelé haladva töltsse fel a racket úgy, hogy a legnehezebb készülék kerüljön a rack aljába.
- Ha stabilizáló eszközök is tartoznak a rackhez, szerelje fel a stabilizátorokat, mielőtt beszerelné az egységet a rackbe, vagy karbantartást végezne rajta.

- Avvertenza** Per evitare infortuni fisici durante il montaggio o la manutenzione di questa unità in un supporto, occorre osservare speciali precauzioni per garantire che il sistema rimanga stabile. Le seguenti direttive vengono fornite per garantire la sicurezza personale:
- Questa unità deve venire montata sul fondo del supporto, se si tratta dell'unica unità da montare nel supporto.
  - Quando questa unità viene montata in un supporto parzialmente pieno, caricare il supporto dal basso all'alto, con il componente più pesante sistemato sul fondo del supporto.
  - Se il supporto è dotato di dispositivi stabilizzanti, installare tali dispositivi prima di montare o di procedere alla manutenzione dell'unità nel supporto.
- Advarsel** Unngå fysiske skader under montering eller reparasjonsarbeid på denne enheten når den befinner seg i et kabinett. Vær nøye med at systemet er stabilt. Følgende retningslinjer er gitt for å verne om sikkerheten:
- Denne enheten bør monteres nederst i kabinettet hvis dette er den eneste enheten i kabinettet.
  - Ved montering av denne enheten i et kabinett som er delvis fylt, skal kabinettet lastes fra bunnen og opp med den tyngste komponenten nederst i kabinettet.
  - Hvis kabinettet er utstyrt med stabiliseringsutstyr, skal stabilisatorene installeres før montering eller utføring av reparasjonsarbeid på enheten i kabinettet.
- Aviso** Para se prevenir contra danos corporais ao montar ou reparar esta unidade numa estante, deverá tomar precauções especiais para se certificar de que o sistema possui um suporte estável. As seguintes directrizes ajudá-lo-ão a efectuar o seu trabalho com segurança:
- Esta unidade deverá ser montada na parte inferior da estante, caso seja esta a única unidade a ser montada.
  - Ao montar esta unidade numa estante parcialmente ocupada, coloque os itens mais pesados na parte inferior da estante, arrumando-os de baixo para cima.
  - Se a estante possuir um dispositivo de estabilização, instale-o antes de montar ou reparar a unidade.

- ¡Advertencia!** Para evitar lesiones durante el montaje de este equipo sobre un bastidor, o posteriormente durante su mantenimiento, se debe poner mucho cuidado en que el sistema quede bien estable. Para garantizar su seguridad, proceda según las siguientes instrucciones:
- Colocar el equipo en la parte inferior del bastidor, cuando sea la única unidad en el mismo.
  - Cuando este equipo se vaya a instalar en un bastidor parcialmente ocupado, comenzar la instalación desde la parte inferior hacia la superior colocando el equipo más pesado en la parte inferior.
  - Si el bastidor dispone de dispositivos estabilizadores, instalar éstos antes de montar o proceder al mantenimiento del equipo instalado en el bastidor.
- Varning!** För att undvika kroppsskada när du installerar eller utför underhållsarbete på denna enhet på en ställning måste du vidta särskilda försiktighetsåtgärder för att försäkra dig om att systemet står stadigt. Följande riktlinjer ges för att trygga din säkerhet:
- Om denna enhet är den enda enheten på ställningen skall den installeras längst ned på ställningen.
  - Om denna enhet installeras på en delvis fylld ställning skall ställningen fyllas nedifrån och upp, med de tyngsta enheterna längst ned på ställningen.
  - Om ställningen är försedd med stabiliseringsdon skall dessa monteras fast innan enheten installeras eller underhålls på ställningen.
- Figyelem** A készülék rackbe történő beszerelése és karbantartása során bekövetkező sérülések elkerülése végett speciális óvintézkedésekkel meg kell őrizni a rendszer stabilitását. A személyes biztonsága érdekében tartsa be a következő szabályokat:
- Ha a rackben csak ez az egy készülék található, a rack aljába kell beszerelni.
  - Ha nincs teljesen tele az a rack, amelybe beszerelik a készüléket, alulról felfelé haladva töltsse fel a racket úgy, hogy a legnehezebb készülék kerüljön a rack aljába.
  - Ha stabilizáló eszközök is tartoznak a rackhez, szerelje fel a stabilizátorokat, mielőtt beszerelné az egységet a rackbe, vagy karbantartást végezne rajta.

**Предупреждение**

Во избежание травм при монтаже и обслуживании устройства в стойке следует принять особые меры предосторожности, чтобы убедиться в устойчивости оборудования. Для обеспечения безопасности работ необходимо соблюдать следующие правила.

- Если в стойке находится одно устройство, оно должно быть установлено в нижней части.
- При монтаже устройств в частично заполненную стойку устанавливайте оборудование снизу вверх, размещая наиболее тяжелые устройства в нижней части.
- Если стойка снабжена приспособлениями для стабилизации, их необходимо установить до начала монтажа или обслуживания оборудования.

**警告**

为避免在机架中安装或维修该部件时使身体受伤，您必须采取特殊的预防措施确保系统固定。以下是确保安全的原则：

- 如果此部件是机架中唯一的部件，应将其安装在机架的底部。
- 如果在部分装满的机架中安装此部件，请按从下往上的顺序安装各个部件，并且最重的组件应安装在机架的底部。
- 如果机架配有固定装置，请先装好固定装置，然后再在机架中安装或维修部件。

**警告**

この装置をラックに設置したり保守作業を行ったりするときは、人身事故を防ぐため、システムが安定しているかどうかを十分に確認する必要があります。次の注意事項に従ってください。

- ラックにこの装置を単独で設置する場合は、ラックの一番下に設置します。
- ラックに別の装置がすでに設置されている場合は、最も重量のある装置を一番下にして、重い順に下から上へ設置します。
- ラックに安定器具が付属している場合は、その安定器具を取り付けてから、装置をラックに設置するか、またはラック内の装置の保守作業を行ってください。

# Redundant Power Supply Connection Warning



## Warning

If a redundant power system (RPS) is not connected to the switch, install an RPS connector cover on the back of the switch. Statement 265

## Waarschuwing

Als er geen redundant voedingsstelsel (RPS) aan de schakelaar is gekoppeld, dient u een RPS-connectordekking op de achterkant van de schakelaar te installeren.

## Varoitus

Jos korvautuvaa tehojärjestelmää (redundant power system, RPS) ei ole liitetty kytkimeen, kiinnitä RPS-liittimen suojustakapuoletta.

## Attention

Si un système d'alimentation électrique redondant (RPS) n'est pas connecté au commutateur, installez un cache de connecteur RPS à l'arrière du commutateur.

## Warnung

Wenn keine redundante Stromversorgung (RSV) an den Schalter angeschlossen ist, eine RSV-Steckerabdeckung an der Rückseite des Schalters anbringen.

## Avvertenza

Se un sistema RPS (Redundant Power System) di alimentazione ridondante non è collegato al dispositivo switch, installare un copri-connettore RPS sul retro del switch.

## Advarsel

Dersom et redundant strømsystem (Redundant Power System -RPS) ikke er koblet til bryteren, skal det installeres et RPS-koblingsdeksel på baksiden av bryteren.

## Aviso

Se um sistema de alimentação redundante (RPS) não estiver conectado a um switch, instale uma capa de conector RPS na parte de trás do switch.

## ¡Advertencia!

Si no se conecta un sistema de potencia redundante (RPS) al interruptor, instale una cubierta de conector RPS en la parte posterior del interruptor.

<b>Varning!</b>	<b>Om ett redundant strömförsörjningssystem (redundant power system, RPS) inte finns anslutet till switchen skall ett RPS-kontaktskydd installeras på switchens baksida.</b>
<b>Figyelem</b>	<b>Ha a kapcsolóhoz nem csatlakozik redundáns tápegység (RPS), az RPS csatlakozófedelét a kapcsoló hátuljára szerelje fel.</b>
<b>Предупреждение</b>	Если система питания с избыточными источниками и распределением нагрузки (RPS) не подсоединена к переключателю, установите крышку соединителя RPS на задней стенке переключателя.
<b>警告</b>	如果冗余电源系统 (RPS) 未连接切换开关，请在开关后面安装 RPS 接头盖。
<b>警告</b>	Redundant Power System (RPS) がスイッチに接続されていない場合、スイッチの後ろの部分に RPS コネクタ カバーを設置してください。

---

## Switch Installation Warning



### Warning

To comply with safety regulations, mount switches on a wall with the front panel facing up.

### Waarschuwing

Om te voldoen aan de veiligheidsvoorschriften dient u de schakelaars op een muur te monteren met het voorpaneel omhoog.

### Varoitus

Turvallisuusmääräykset edellyttävät, että kytkimet kiinnitetään seinään etupaneeli ylöspäin.

### Attention

Pour satisfaire aux dispositions de sécurité, installez les commutateurs muraux avec le panneau frontal vers le haut.

## Switch Installation Warning

<b>Warnung</b>	<b>Zur Einhaltung der Sicherheitsvorschriften die Schalter so an einer Wand montieren, dass die Frontplatte nach oben zeigt.</b>
<b>Avvertenza</b>	<b>In conformità ai regolamenti di sicurezza, installare i dispositivi switch a muro con il pannello frontale rivolto in su.</b>
<b>Advarsel</b>	<b>For å etterkomme sikkerhetsreglene skal brytere monteres på en vegg med frontpanelet vendt opp.</b>
<b>Aviso</b>	<b>Para cumprir com os regulamentos de segurança, faça a montagem de switches em uma parede com o painel frontal virado para cima.</b>
<b>¡Advertencia!</b>	<b>Para cumplir con las reglas de seguridad, instale los interruptores en una pared con el panel del frente hacia arriba.</b>
<b>Varning!</b>	<b>För att uppfylla säkerhetsföreskrifter skall switcharna monteras på en vägg med frampanelen riktad uppåt.</b>
<b>Figyelem</b>	<b>A biztonsági előírások betartása érdekében a kapcsolókat úgy szerelje a falra, hogy az előlapjuk felfelé nézzen.</b>
<b>Предупреждение</b>	<b>В соответствии с положениями безопасности установите переключатели на стене передней панелью наружу.</b>
<b>警告</b>	<b>为符合安全规章，请将切换开关安装在墙上，前面板朝上。</b>
<b>警告</b>	<b>安全既定に準拠するために、フロントパネルを上向きにしてスイッチを壁にマウントします。</b>



# Restricted Area

**Warning**

This unit is intended for installation in restricted access areas. A restricted access area can be accessed only through the use of a special tool, lock and key, or other means of security.

**Waarschuwing**

Deze eenheid is bestemd voor installatie in plaatsen met beperkte toegang. Toegang tot een dergelijke plaats kan alleen verkregen worden door middel van een speciaal instrument, een slot en sleutel of een ander veiligheidsmiddel.

**Varoitus**

Tämä laite on tarkoitettu asennettavaksi paikkaan, johon pääsy on rajoitettua. Tällaiseen paikkaan pääsee vain erikoistyökäluä, lukkoon sopivaa avainta tai jotakin muuta turvalaitetta käyttämällä.

**Attention**

Cet appareil est à installer dans des zones d'accès réservé. L'accès à une zone d'accès réservé n'est possible qu'en utilisant un outil spécial, un mécanisme de verrouillage et une clé, ou tout autre moyen de sécurité.

**Warnung**

Diese Einheit ist zur Installation in Bereichen mit beschränktem Zutritt vorgesehen. Der Zutritt zu derartigen Bereichen ist nur mit einem Spezialwerkzeug, Schloss und Schlüssel oder einer sonstigen Sicherheitsvorkehrung möglich.

**Avvertenza**

Questa unità è prevista per essere installata in un'area ad accesso limitato, vale a dire un'area accessibile solo mediante l'uso di un attrezzo speciale, come lucchetto e chiave, o altri dispositivi di sicurezza.

**Advarsel**

Denne enheten er beregnet på installasjon i områder med begrenset tilgang. Et begrenset tilgangsområde kan bare nås ved hjelp av et spesielt verktøy, lås og nøkkel, eller andre sikkerhetsanordninger.

**Aviso**

Esta unidade foi concebida para instalação em áreas de acesso restrito. Uma área de acesso restrito é uma área à qual apenas tem acesso o pessoal de serviço autorizado, que possua uma ferramenta, chave e fechadura especial, ou qualquer outra forma de segurança.

- ¡Advertencia!** Esta unidad ha sido diseñada para instalación en áreas de acceso restringido. Sólo puede obtenerse acceso a una de estas áreas mediante la utilización de una herramienta especial, cerradura con llave u otro medio de seguridad.
- Varning!** Denna enhet är avsedd för installation i områden med begränsat tillträde. Ett område med begränsat tillträde kan endast tillträdas med hjälp av specialverktyg, lås och nyckel eller annan säkerhetsanordning.
- Figyelem** A készülék korlátozottan hozzáférhető területre történő beszerelésre készült. A korlátozottan hozzáférhető területekhez csak speciális szerszám, zár és kulcs vagy más biztonsági berendezés segítségével lehet hozzáférni.
- Предупреждение** Данное устройство предназначено для установки в помещениях с ограниченным доступом. В такие помещения можно попасть, только имея специальное устройство доступа, карту или ключ или пройдя проверку другими средствами обеспечения безопасности.
- 警告** 此部件应安装在限制进出的场所。限制进出的场所指只能通过使用特殊工具、锁和钥匙或其它安全手段进出的场所。
- 警告** この装置は立ち入り制限区域内に設置することが前提になっています。立ち入り制限区域とは、鍵、錠、またはその他の保全手段を使用しないと立ち入ることができない区域です。

## Ethernet Cable Shielding in Offices



**Warning**

**Ethernet cables must be shielded when used in a central office environment.**

**Waarschuwing**

**Ethernetkabels dienen beveiligd te worden als ze in een centrale kantooromgeving worden gebruikt.**

<b>Varoitus</b>	<b>Ethernet-kaapelit täytyy suojata, kun niitä käytetään yleisessä toimistoympäristössä.</b>
<b>Attention</b>	<b>Pour une utilisation en site central, les câbles Ethernet doivent être impérativement blindés.</b>
<b>Warnung</b>	<b>Ethernet-Kabel müssen abgeschirmt werden, wenn sie in einer Zentrale eingesetzt werden.</b>
<b>Avvertenza</b>	<b>I cavi Ethernet devono essere schermati se utilizzati in un ambiente di ufficio centrale.</b>
<b>Advarsel</b>	<b>Ethernet-kabler skal være skjernet når de brukes i et sentralt kontormiljø.</b>
<b>Aviso</b>	<b>Os cabos "Ethernet" deverão estar armados quando usados em ambiente de escritório central.</b>
<b>¡Advertencia!</b>	<b>Los cables Ethernet deben estar protegidos cuando se usen dentro de una oficina central.</b>
<b>Varning!</b>	<b>Ethernetkablar måste vara avskärmade vid användning i central kontorsmiljö.</b>
<b>Figyelem</b>	<b>Az Ethernet kábeleket árnyékolással kell ellátni, ha azokat helyi központban használják.</b>
<b>Предупреждение</b>	<b>Необходимо экранировать кабели Ethernet, используемые в офисе.</b>
<b>警告</b>	<b>在中心局环境中使用以太网电缆时，必须加以屏蔽。</b>
<b>警告</b>	<b>中央オフィス環境で使用される場合、イーサネットケーブルは遮蔽される必要があります。</b>

---

# Laser Beam Exposure



**Warning** Avoid direct exposure to the laser beam.

**Waarschuwing** Voorkom rechtstreekse blootstelling aan de laserstraal.

**Varoitus** Vältä säteelle altistumista.

**Attention** Éviter toute exposition directe au faisceau.

**Warnung** Schützen Sie sich vor direkter Laserbestrahlung.

**Avvertenza** Evitare l'esposizione diretta al raggio laser.

**Advarsel** Unngå direkte eksponering til laserstrålen.

**Aviso** Evite exposição a raios laser.

**¡Advertencia!** Evite la exposición directa al haz del láser.

**Varning!** Utsätt dig inte för laserstrålning.

**Figyelem** Kerülje a lézersugárral való közvetlen érintkezést!

**Предупреждение** Избегайте прямого воздействия лазерного луча.

**警告** 注意避免遭受激光光束的直接辐射。

**警告** レーザー光線を直接浴びないように注意してください。

# Laser Radiation



## Warning

Invisible laser radiation may be emitted from disconnected fibers or connectors. Do not stare into beams or view directly with optical instruments.

## Waarschuwing

Losgekoppelde of losgeraakte glasvezels of aansluitingen kunnen onzichtbare laserstraling produceren. Kijk niet rechtstreeks in de straling en gebruik geen optische instrumenten rond deze glasvezels of aansluitingen.

## Varoitus

Irrotetuista kuiduista tai liittimistä voi tulla näkymätöntä lasersäteilyä. Älä tuijota säteitä tai katso niitä suoraan optisilla välineillä.

## Attention

Les fibres ou connecteurs débranchés risquent d'émettre des rayonnements laser invisibles à l'œil. Ne regardez jamais directement les faisceaux laser à l'œil nu, ni d'ailleurs avec des instruments optiques.

## Warnung

Unterbrochene Fasern oder Steckerverbindungen können unsichtbare Laserstrahlung abgeben. Blicken Sie weder mit bloßem Auge noch mit optischen Instrumenten direkt in Laserstrahlen.

## Avvertenza

Le fibre ottiche ed i relativi connettori possono emettere radiazioni laser. I fasci di luce non devono mai essere osservati direttamente o attraverso strumenti ottici.

## Advarsel

Det kan forekomme usynlig laserstråling fra fiber eller kontakter som er frakoblet. Stirr ikke direkte inn i strålene eller se på dem direkte gjennom et optisk instrument.

## Aviso

Radiação laser invisível pode ser emitida de conectores ou fibras desconectadas. Não olhe diretamente para os feixes ou com instrumentos ópticos.

## ¡Advertencia!

Es posible que las fibras desconectadas emitan radiación láser invisible. No fije la vista en los rayos ni examine éstos con instrumentos ópticos.

**Varning!** Osynlig laserstrålning kan avges från frånkopplade fibrer eller kontaktdon. Rikta inte blicken in i strålar och titta aldrig direkt på dem med hjälp av optiska instrument.

**Figyelem** A nem csatlakoztatott üvegszálak és csatlakozók láthatatlan lézersugárzást bocsáthatnak ki. Ne nézzen bele a sugárba, és ne nézze közvetlenül, optikai berendezések segítségével!

**Предупреждение** Отключенные световоды и разъемы могут испускать невидимое лазерное излучение. Не допускайте попадания лазерного луча в глаза и не смотрите на него через оптические приборы.

**警告** 断开的光纤或接头有可能发出不可见的激光辐射。请勿直视光束或直接用光学仪器观看光束。

**警告** 光ファイバ ケーブルまたはコネクタを取り外した状態では、目に見えないレーザー光が放射されていることがあります。光線をのぞきこんだり、光学機器を使用して光線を直接見たりしないでください。



---

## Numerics

### 10/100/1000 ports

cable lengths [3-6](#)

connecting to [3-44](#)

connectors and cables [B-1 to B-2](#)

described [2-6](#)

illustrated [2-3](#)

### 10/100 ports

cable lengths [3-6](#)

connecting to [3-44](#)

connectors and cables [B-3 to B-4](#)

described [2-6](#)

illustrated [2-4](#)

numbering [2-3](#)

### 19- and 24-inch racks [3-18](#)

---

## A

### AC power

connecting to [3-10](#)

connector [2-16](#)

specifications [A-1 to A-4](#)

adapter cable [3-9](#)

adapter pinouts, terminal

RJ-45-to-DB-25 [B-10](#)

RJ-45-to-DB-9 [B-10](#)

agency approvals [A-5](#)

altitude, operating and storage [A-1 to A-4](#)

automatic crossover [2-6](#)

autonegotiation [2-6](#)

---

## B

### brackets

See mounting brackets

---

## C

cable guide, attaching [3-30](#)

cable lengths [3-6](#)

### cables

crossover

connecting to [B-2 to B-4](#)

four twisted-pair pinout, 10/100 ports [B-7](#)

four twisted-pair pinout, 1000BASE-T  
ports [B-8](#)

identifying [B-9](#)

- two twisted-pair pinout, 10/100 ports [B-6](#)
- SFP module
  - 1000BASE-T module [3-49](#)
- straight-through
  - connecting to [B-2 to B-4](#)
  - four twisted-pair pinout, 10/100 ports [B-7](#)
  - four twisted-pair pinout, 1000BASE-T ports [B-8](#)
  - two twisted-pair pinout, 10/100 ports [B-6](#)
- See also connectors and cables
- cabling
  - 10/100/1000 ports [2-6, 3-44](#)
  - 10/100 ports [2-6, 3-44, B-4](#)
  - automatic crossover [2-6](#)
  - considerations [3-14](#)
  - pinouts [B-6](#)
  - See also connectors and cables
  - StackWise cables
    - cable numbers [2-15](#)
    - connecting to [3-37](#)
- cautions [xvi](#)
- chassis warning, rack-mounting and servicing [E-19](#)
- Cisco IP Phones, connecting to [3-45](#)
- Cisco RPS
  - See RPS
- CiscoView [2-18](#)
- CLI [2-18](#)
  - accessing by using Express Setup [D-2](#)
  - accessing through console port [D-3](#)
- Cluster Management Suite
  - See CMS
- CMS [2-18](#)
  - accessing your switch [C-1](#)
  - operating systems and supported browsers [C-6](#)
  - requirements [C-5 to C-7](#)
  - supported Java plug-ins [C-7](#)
- command-line interface
  - See CLI
- connecting
  - to 10/100/1000 ports [3-44](#)
  - to 10/100 ports [3-44](#)
  - to console port [3-8, B-6](#)
  - to SFP modules [3-46 to 3-49](#)
- connecting to the console port [D-7](#)
- connection procedures [3-44 to 3-48](#)
- connectivity problems, solving [4-3](#)
- connectors and cables
  - 10/100/1000 ports [B-1 to B-2](#)
  - 10/100 ports [B-3 to B-4](#)
  - console port [B-6 to B-11](#)
  - power (AC and RPS) [2-16](#)
  - SC connectors [B-5](#)
  - SFP module ports [B-5](#)
  - See also cables
- console port
  - connecting to [3-8, D-7](#)
  - connectors and cables [B-6 to B-11](#)
  - described [2-17](#)



conventions, document [xvi](#)

crossover cable [B-9 to B-10](#)

connecting to

1000BASE-T SFP module ports [3-49](#)

connectivity problems [4-5](#)

pinout

four twisted-pair, 1000BASE-T ports [B-8](#)

four twisted-pair 10/100 ports [B-7](#)

---

## D

DC power

RPS [2-2 to 2-3](#)

diagnosing problems [4-3](#)

dimensions [A-2 to A-5](#)

document conventions [xvi](#)

duplex LED [2-11](#)

---

## E

electrical noise, avoiding [3-7](#)

electromagnetic interference (EMI) [A-5](#)

EMC regulatory statements [3-4](#)

Ethernet cable shielding in offices  
warning [E-28](#)

Express Setup

accessing CLI by using [D-2](#)

procedure [1-4 to 1-10](#)

troubleshooting [1-7 to 1-8](#)

---

## F

features [2-1 to 2-2](#)

front panel

10/100/1000 ports [2-6](#)

10/100 ports [2-6](#)

clearance [3-6](#)

description [2-3 to 2-5](#)

LEDs [2-8 to 2-12](#)

SFP module ports [2-7](#)

---

## G

Grounded [E-11](#)

grounded equipment warning [E-11](#)

---

## H

HP OpenView [2-18](#)

humidity, relative [A-1 to A-4](#)

---

## I

installation

assigning the IP Address [D-10](#)

connecting to an Ethernet port [C-2](#)

connecting to a power source [D-9](#)

rack-mounting [3-18 to 3-36](#)

site requirements [3-6](#)

stacking the switches

See also stacking

starting the terminal emulation software [D-9](#)

table or shelf-mounting [3-36](#)

wall mounting [3-32](#)

warning [E-5](#)

See also procedures

installing or replacing the unit warning [E-12](#)

installing SFP modules [3-41 to 3-43](#)

IOS command-line interface [2-18](#)

IP address

configuring by using Express Setup [1-9](#)

verifying [1-10 to 1-11](#)

---

## J

jewelry removal warning [E-6](#)

---

## L

laser beam exposure warning [E-30](#)

laser radiation warning [E-31](#)

LEDs

color meanings [2-10](#)

duplex [2-11](#)

front panel [2-8](#)

interpreting [2-10](#)

master [2-10](#)

port [2-10 to 2-12](#)

port mode [2-10](#)

POST results [4-2](#)

RPS [2-9, 2-10](#)

speed [2-11](#)

stack [2-12](#)

STATUS [2-11](#)

system [2-9](#)

lightning activity warning [E-16](#)

---

## M

main disconnecting device warning [E-10](#)

methods for accessing the switch [D-2](#)

mode button [2-8](#)

mounting, table or shelf [3-36](#)

mounting, wall mounting [3-32](#)

mounting brackets

attaching [3-20 to 3-28](#)

rack-mount [3-28](#)

---

## N

noise, electrical [3-7](#)

---

## P

packing list [3-7](#)

PC, connecting to switch [3-9](#)

performance problems, solving [4-3](#)

## pinouts

- 10/100 ports [B-5](#)

- adapters [B-9 to B-11](#)

- console port [B-10, B-10 to B-11](#)

- crossover cable [B-9](#)

## crossover cables

- four twisted-pair, 1000BASE-T ports [B-8](#)

- four twisted-pair 10/100 ports [B-7](#)

- two twisted-pair 10/100 ports [B-6](#)

- RJ-45-to-DB-25 terminal adapter [B-10](#)

- RJ-45-to-DB-9 terminal adapter [B-10](#)

- SFP module ports [B-5](#)

## straight-through cables

- four twisted-pair 10/100 ports [B-7](#)

- four twisted-pair 1000BASE-T ports [B-8](#)

- two twisted-pair 10/100 ports [B-6](#)

- port LEDs [2-10 to 2-12](#)

## port modes

- changing [2-8](#)

- LEDs [2-10, 2-11](#)

- See also mode button

## ports

- 10/100 [2-6](#)

- 10/100/1000 [2-3](#)

- numbering of 10/100 [2-6](#)

- numbering of 10/100/1000 [2-6](#)

## POST

- LEDs [4-2](#)

- results [4-1](#)

- running at powerup [1-4](#)

## power

- connecting to [3-10](#)

- connectors [2-14, 2-16](#)

- specifications [A-1 to A-5](#)

- power on [3-10](#)

## power supply

- AC power outlet [2-16](#)

- RPS connector [2-16](#)

## procedures

- connection [3-44 to 3-48](#)

- installation [3-17 to 3-36](#)

- product disposal warning [E-17](#)

- publications, related [xxi](#)

---

**Q**

- qualified personnel warning [E-4](#)

---

**R**

- rack-mounting [3-18 to 3-36](#)

## rear panel

- clearance [3-6](#)

- description [2-14 to 2-17](#)

## redundant power supply

- See RPS

- regulatory statements, EMC [3-4](#)

- removing SFP modules [3-43 to 3-44](#)

restricted area warning [E-27](#)  
 RJ-45 connector, console port [B-6](#)  
 RJ-45 console port [2-14](#)  
 RPS  
   connecting to [3-10](#)  
   connector [2-16](#)  
   LED [2-9, 2-10](#)  
 RPS connection warning [E-24](#)

---

## S

safety [3-2, E-1](#)  
 SC connector [B-5](#)  
 SFP modules  
   1000BASE-LX [2-7](#)  
   1000BASE-SX [2-7](#)  
   1000BASE-T [2-7](#)  
     supported speeds [2-12](#)  
 bale-clasp latch  
   removal [3-43](#)  
 connecting to [3-46 to 3-49](#)  
 connectors [B-5](#)  
 described [2-7](#)  
 fiber-optic cabling guidelines [3-6](#)  
 installation [3-41 to 3-43](#)  
 shelf-mounting [3-36](#)  
 Simple Network Management Protocol  
   See SNMP  
 SNMP network management platforms [2-18](#)

software switch management [2-18](#)  
 specifications [A-1](#)  
 stacking  
   cabling considerations [3-14](#)  
   connecting to a StackWise port [3-12](#)  
   examples [3-12](#)  
   planning considerations [3-12](#)  
   powering considerations [3-13](#)  
 StackWise ports [2-15](#)  
 straight-through cable  
   pinout  
     four twisted-pair 10/100 ports [B-7](#)  
     four twisted-pair 1000BASE-T ports [B-8](#)  
     two twisted-pair 10/100 ports [B-6](#)  
 SunNet Manager [2-18](#)  
 switch installation warning [E-25](#)  
 switch powering on [3-10](#)  
 system LED [2-9](#)

---

## T

table-mounting [3-36](#)  
 technical specifications [A-1](#)  
 telco racks [3-18](#)  
 Telnet, and accessing the CLI [2-18](#)  
 temperature, operating [A-1](#)  
 terminal, connecting to switch [3-9](#)  
 terminal emulation software [3-8, D-9](#)  
 translated warnings [E-1 to E-31](#)

troubleshooting [4-1 to 4-5](#)

---

## W

wall mounting [3-32](#)

warnings

    defined [xvi](#)

    installation [3-2](#)

    translated [E-1 to E-31](#)

