

# Sun Enterprise™ 10000 SSP

## 3.1.1 User Guide

---



THE NETWORK IS THE COMPUTER™

**Sun Microsystems, Inc.**  
901 San Antonio Road  
Palo Alto, CA 94303-4900 USA  
650 960-1300  
Fax 650 969-9131

Part No.: 805-7519-10  
Revision A, August 1999

Send comments about this document to: [docfeedback@sun.com](mailto:docfeedback@sun.com)

Copyright 1999 Sun Microsystems, Inc., 901 San Antonio Road, Palo Alto, California 94303-4900 U.S.A. All rights reserved.

This product or document is protected by copyright and distributed under licenses restricting its use, copying, distribution, and decompilation. No part of this product or document may be reproduced in any form by any means without prior written authorization of Sun and its licensors, if any. Third-party software, including font technology, is copyrighted and licensed from Sun suppliers.

Parts of the product may be derived from Berkeley BSD systems, licensed from the University of California. UNIX is a registered trademark in the U.S. and other countries, exclusively licensed through X/Open Company, Ltd.

Sun, Sun Microsystems, the Sun logo, SunStore, AnswerBook2, docs.sun.com, Sun Enterprise, OpenWindows, OpenBoot, and Solaris are trademarks, registered trademarks, or service marks of Sun Microsystems, Inc. in the U.S. and other countries. All SPARC trademarks are used under license and are trademarks or registered trademarks of SPARC International, Inc. in the U.S. and other countries. Products bearing SPARC trademarks are based upon an architecture developed by Sun Microsystems, Inc.

The OPEN LOOK and Sun™ Graphical User Interface was developed by Sun Microsystems, Inc. for its users and licensees. Sun acknowledges the pioneering efforts of Xerox in researching and developing the concept of visual or graphical user interfaces for the computer industry. Sun holds a non-exclusive license from Xerox to the Xerox Graphical User Interface, which license also covers Sun's licensees who implement OPEN LOOK GUIs and otherwise comply with Sun's written license agreements.

**RESTRICTED RIGHTS:** Use, duplication, or disclosure by the U.S. Government is subject to restrictions of FAR 52.227-14(g)(2)(6/87) and FAR 52.227-19(6/87), or DFAR 252.227-7015(b)(6/95) and DFAR 227.7202-3(a).

DOCUMENTATION IS PROVIDED "AS IS" AND ALL EXPRESS OR IMPLIED CONDITIONS, REPRESENTATIONS AND WARRANTIES, INCLUDING ANY IMPLIED WARRANTY OF MERCHANTABILITY, FITNESS FOR A PARTICULAR PURPOSE OR NON-INFRINGEMENT, ARE DISCLAIMED, EXCEPT TO THE EXTENT THAT SUCH DISCLAIMERS ARE HELD TO BE LEGALLY INVALID.

---

Copyright 1999 Sun Microsystems, Inc., 901 San Antonio Road, Palo Alto, Californie 94303-4900 U.S.A. Tous droits réservés.

Ce produit ou document est protégé par un copyright et distribué avec des licences qui en restreignent l'utilisation, la copie, la distribution, et la décompilation. Aucune partie de ce produit ou document ne peut être reproduite sous aucune forme, par quelque moyen que ce soit, sans l'autorisation préalable et écrite de Sun et de ses bailleurs de licence, s'il y en a. Le logiciel détenu par des tiers, et qui comprend la technologie relative aux polices de caractères, est protégé par un copyright et licencié par des fournisseurs de Sun.

Des parties de ce produit pourront être dérivées des systèmes Berkeley BSD licenciés par l'Université de Californie. UNIX est une marque déposée aux Etats-Unis et dans d'autres pays et licenciée exclusivement par X/Open Company, Ltd.

Sun, Sun Microsystems, le logo Sun, SunStore, AnswerBook2, docs.sun.com, Sun Enterprise, OpenWindows, OpenBoot, et Solaris sont des marques de fabrique ou des marques déposées, ou marques de service, de Sun Microsystems, Inc. aux Etats-Unis et dans d'autres pays. Toutes les marques SPARC sont utilisées sous licence et sont des marques de fabrique ou des marques déposées de SPARC International, Inc. aux Etats-Unis et dans d'autres pays. Les produits portant les marques SPARC sont basés sur une architecture développée par Sun Microsystems, Inc.

L'interface d'utilisation graphique OPEN LOOK et Sun™ a été développée par Sun Microsystems, Inc. pour ses utilisateurs et licenciés. Sun reconnaît les efforts de pionniers de Xerox pour la recherche et le développement du concept des interfaces d'utilisation visuelle ou graphique pour l'industrie de l'informatique. Sun détient une licence non exclusive de Xerox sur l'interface d'utilisation graphique Xerox, cette licence couvrant également les licenciés de Sun qui mettent en place l'interface d'utilisation graphique OPEN LOOK et qui en outre se conforment aux licences écrites de Sun.

CETTE PUBLICATION EST FOURNIE "EN L'ETAT" ET AUCUNE GARANTIE, EXPRESSE OU IMPLICITE, N'EST ACCORDEE, Y COMPRIS DES GARANTIES CONCERNANT LA VALEUR MARCHANDE, L'APTITUDE DE LA PUBLICATION A REPENDRE A UNE UTILISATION PARTICULIERE, OU LE FAIT QU'ELLE NE SOIT PAS CONTREFAISANTE DE PRODUIT DE TIERS. CE DENI DE GARANTIE NE S'APPLIQUERAIT PAS, DANS LA MESURE OU IL SERAIT TENU JURIDIQUEMENT NUL ET NON AVENU.



Adobe PostScript

# Contents

---

- 1. Introduction to the SSP 13**
  - SSP Features 13
  - System Architecture 14
  - SSP User Environment 15
    - ▼ To Begin Using the SSP 16
      - SSP Window 16
    - ▼ To Display an SSP Window Locally in OpenWindows 17
    - ▼ To Display an SSP Window Locally in the Common Desktop Environment (CDE) 17
    - ▼ To Display an SSP Window Remotely 17
      - SSP Console Window 18
    - ▼ To Display an SSP Console Window With OpenWindows 18
    - ▼ To Display an SSP Console Window Locally With CDE 18
      - Network Console Window 18
      - Hostview 19
- 2. Overview of the SSP Tools 21**
  - Hostview 21
    - ▼ To Start Up Hostview From a Remote Login Session 22
    - ▼ To Start Up Hostview From the Workspace Menu Locally on the SSP 22

- ▼ To Start Up Hostview Under CDE From the Front Panel 22
  - Hostview Main Window 23
  - Selecting Items in the Main Window 25
  - Main Window Menu Bar 26
  - Help Window 28
  - Main Window Buttons 28
  - Main Window Processor Symbols 30
  - Hostview Performance Considerations 31
- netcon and netcontool Windows 32
  - Overview of netcon(1M) 32
  - Overview of netcontool(1M) 32
- ▼ To Display a netcon(1M) Window From a netcontool(1M) Window 33
- ▼ To Display a netcon(1M) Window From the Command Line 34
- ▼ To Display a netcon(1M) Window From the CDE Front Panel 34
- ▼ To Display a netcon(1M) Window From the CDE Workspace Menu 35
- ▼ To Exit from a netcon(1M) Window 35
- ▼ To Display a netcontool(1M) Window From the Command Line 35
- ▼ To Display a netcontool(1M) Window From the CDE Front Panel 36
- ▼ To Display a netcontool(1M) Window From the CDE Workspace Menu 36
- ▼ To Display the netcontool(1M) Window From Hostview 36
- ▼ To Configure the netcontool(1M) Window 37
- netcon(1M) Communications 39
- netcon(1M) Message Logging 40
  - ▼ To Enable netcon(1M) Logging 40
  - ▼ To Disable netcon(1M) Logging Sessions for Specific Hosts 40
  - ▼ To Re-Enable netcon(1M) Logging Sessions for Specific Hosts 41

### **3. System Administration Procedures 43**

#### **SSP Log Files 43**

- ▼ To View a messages File From Within Hostview 44

#### **Power 45**

- ▼ To Power Components On or Off From Within Hostview 45
- ▼ To Resynchronize Hostview With the Platform After a Power Failure on the Platform 47
- ▼ To Power System Boards On and Off From the Command Line 47
- ▼ To Monitor Power Levels in Hostview 48

#### **Thermal Conditions and Fans 50**

- ▼ To Monitor Thermal Conditions From Within Hostview 50
- ▼ To Monitor Fans From Within Hostview 52
- ▼ To Control Fans From Within Hostview 54

#### **Domains 56**

##### **Domain Configuration Requirements 56**

- ▼ To Create Domains From Within Hostview 56
- ▼ To Create Domains From the Command Line 58
- ▼ To Recreate the `eeeprom.image` File 59
- ▼ To Remove Domains From Within Hostview 60
- ▼ To Remove Domains From the Command Line 62
- ▼ To Rename Domains From Within Hostview 62
- ▼ To Rename Domains From the Command Line 63
- ▼ To Bring up a Domain From Within Hostview 64
- ▼ To Bring up a Domain From the Command Line 64
- ▼ To Obtain Domain Status From Within Hostview 65

#### **Blacklisting Components 67**

- ▼ To Blacklist Components From Within Hostview 68
- ▼ To Blacklist Processors From Within Hostview 69

▼	To Clear the Blacklist File From Within Hostview	71
	Using a Spare SSP	71
▼	To Switch Between the Main and Spare SSP	72
	Dual Control Board Handling	74
	Control Board Executive	74
	Primary Control Board	74
	Control Board Server	74
	Control Board Executive Image and Port Specification Files	75
▼	To Switch the Primary Control Board	76
<b>4.</b>	<b>SSP Internals</b>	<b>79</b>
	Startup Flow	79
	Sun Enterprise 10000 Client/Server Architecture	81
	POST	82
	Daemons	83
	Event Detector Daemon	84
	Control Board Server	86
	File Access Daemons	87
	Network Time Protocol Daemon	87
	OBP Daemon	88
	Environment Variables	89
	Executable Files Within a Domain	90
	*.elf File	90
	download_helper File	90
	obp File	91

# Figures

---

FIGURE 1-1	Sun Enterprise 10000 system and Control Boards	15
FIGURE 1-2	SSP Window	16
FIGURE 1-3	<code>netcon(1M)</code> Window	19
FIGURE 1-4	Hostview GUI Program	20
FIGURE 2-1	Hostview Main Window	23
FIGURE 2-2	Unselected System Board (domain independent)	24
FIGURE 2-3	Unselected System Board (domain dependent)	24
FIGURE 2-4	Selected System Board (domain dependent)	25
FIGURE 2-5	Hostview Help Window	28
FIGURE 2-6	Power Button	29
FIGURE 2-7	Temperature Button	29
FIGURE 2-8	Fan Button	29
FIGURE 2-9	Failure Button	30
FIGURE 2-10	<code>netcontool</code> GUI Program	33
FIGURE 2-11	<code>netcontool</code> Window in Hostview	37
FIGURE 2-12	<code>netcontool</code> Console Configuration Window	37
FIGURE 3-1	SSP Logs Window	44
FIGURE 3-2	Power Control and Status Window	46
FIGURE 3-3	Power Button	48

FIGURE 3-4	Power Status Display	49
FIGURE 3-5	System Board Power Detail Window	50
FIGURE 3-6	Temperature Button	51
FIGURE 3-7	Thermal Status Display	51
FIGURE 3-8	System Board Thermal Detail	52
FIGURE 3-9	Fan Button	53
FIGURE 3-10	Fan Status Display	53
FIGURE 3-11	Fan Tray Window	54
FIGURE 3-12	Fan Control and Status Window	55
FIGURE 3-13	Create Domain Window	57
FIGURE 3-14	Remove Domain Window	61
FIGURE 3-15	Rename Domain Window	63
FIGURE 3-16	Domain Status Window	66
FIGURE 3-17	Blacklist Edit Window—Board View	68
FIGURE 3-18	Blacklist Edit Window—Processor View	70
FIGURE 4-1	Sun Enterprise 10000 Client/Server Architecture	82
FIGURE 4-2	Uploading Event Detection Scripts	85
FIGURE 4-3	Event Recognition and Delivery	85
FIGURE 4-4	Response Action	86
FIGURE 4-5	CBS Communication Between SSP and Sun Enterprise 10000 system	87



# Preface

---

The *Sun™ Enterprise™ 10000 SSP 3.1.1 User's Guide* describes the System Service Processor (SSP), which enables you to monitor and control the Sun Enterprise 10000 system.

---

## Before You Read This Book

This manual is intended for the Sun Enterprise 10000 system administrator, who should have a working knowledge of UNIX® systems, particularly those based on the Solaris™ operating environment. If you do not have such knowledge, you should first read the Solaris User and System Administrator AnswerBook™ provided with this system, and consider UNIX system administration training.

---

### How This Book Is Organized

This document contains the following chapters:

Chapter 1 introduces the System Service Processor (SSP).

Chapter 2 introduces the Hostview Graphical User Interface (GUI) and the `netcontool(1M)` command.

Chapter 3 describes how to perform common system administration procedures.

Chapter 4 provides more detailed information for system administrators interested in how the SSP works. Included are descriptions of the SSP booting process and the `edd(1M)` daemon, which monitors the Sun Enterprise 10000 system.

---

# Using UNIX Commands

This document does not contain information on basic UNIX commands and procedures such as shutting down the system, booting the system, and configuring devices.

See one or more of the following for this information:

- AnswerBook online documentation for the Solaris software environment, particularly those dealing with Solaris system administration.
- Other software documentation that you received with your system

---

# Typographic Conventions

TABLE P-1 Typographic Conventions

Typeface or Symbol	Meaning	Examples
AaBbCc123	The names of commands, files, and directories; on-screen computer output.	Edit your <code>.login</code> file. Use <code>ls -a</code> to list all files. % You have mail.
<b>AaBbCc123</b>	What you type, when contrasted with on-screen computer output.	% <b>su</b> Password:
<i>AaBbCc123</i>	Book titles, new words or terms, words to be emphasized. Command-line variable; replace with a real name or value.	Read Chapter 6 in the <i>User's Guide</i> . These are called <i>class</i> options. You <i>must</i> be <code>root</code> to do this. To delete a file, type <code>rm filename</code> .

---

# Shell Prompts

TABLE P-2 Shell Prompts

Shell	Prompt
C shell	<i>machine_name</i> %
C shell superuser	<i>machine_name</i> #
Bourne shell and Korn shell	\$
Bourne shell and Korn shell superuser	#

---

## Related Documentation

**TABLE P-3** Related Documentation

<b>Application</b>	<b>Title</b>
Installation	<i>Sun Enterprise 10000 SSP 3.1.1 Installation and Release Notes</i>
Reference (man pages)	<i>Sun Enterprise 10000 SSP 3.1.1 Reference Manual</i>
Release Notes	<i>Sun Enterprise 10000 SSP 3.1.1 Installation and Release Notes</i>
Other	<i>Sun Enterprise 10000 Dynamic Reconfiguration User's Guide</i> <i>Sun Enterprise 10000 Dynamic Reconfiguration Reference Manual</i> <i>Sun Enterprise Server Alternate Pathing User's Guide</i> <i>Sun Enterprise Server Alternate Pathing Reference Manual</i>

---

## Accessing Sun Documentation Online

The `docs.sun.comSM` web site enables you to access Sun technical documentation on the Web. You can browse the `docs.sun.com` archive or search for a specific book title or subject at:

`http://docs.sun.com`

---

## Sun Welcomes Your Comments

We are interested in improving our documentation and welcome your comments and suggestions. You can email your comments to us at:

`docfeedback@sun.com`

Please include the part number (805-7519-10) of your document in the subject line of your email.

## Introduction to the SSP

---

The System Service Processor (SSP) is a SPARC™ workstation that enables you to control and monitor the Sun Enterprise 10000 system. The SSP software packages must be installed on the SSP workstation. In addition, the SSP workstation must be able to communicate with the Sun Enterprise 10000 system over an Ethernet connection. In this book, the SSP workstation is simply called the *SSP*.

Sun Enterprise 10000 system is often referred to as the *platform*. System boards within the platform may be logically grouped together into separately bootable systems called *Dynamic System Domains*, or simply *domains*. Up to eight domains may exist simultaneously on a single platform. (Domains are introduced in this chapter, and are described in more detail in “Domains” on page 56.) The SSP enables you to control and monitor domains, as well as the platform itself.

---

**Note** – You should not run any software on the SSP machine other than the SSP software. (If you are using clusters, you can run the Sun cluster console on the SSP. Clustering is beyond the scope of this manual.)

---

---

## SSP Features

SSP 3.1.1 software can be loaded only on Sun workstations running the Solaris 2.5.1, Solaris 2.6, or Solaris 7 operating environment with OpenWindows™ or the Common Desktop Environment (CDE). SSP 3.1.1 software is compatible with Sun Enterprise 10000 system domains running the Solaris 2.5.1, Solaris 2.6, or Solaris 7 operating environments. The commands and GUI programs that are provided with the SSP 3.1.1 software can be used remotely.

The SSP enables the system administrator to perform the following tasks:

- Boot domains.

- Perform an emergency shutdown in an orderly fashion. For example, the SSP software automatically shuts down a domain if the temperature of a processor within that domain rises above a pre-set level.
- Dynamically reconfigure a domain so that currently installed system boards can be *logically* attached to or detached from the operating system while the domain continues running in multiuser mode. This feature is known as *dynamic reconfiguration* and is described in the *Sun Enterprise 10000 Dynamic Reconfiguration User's Guide*. (A system board can easily be *physically* swapped in and out when it is not attached to a domain, even while the system continues running in multiuser mode.)
- Create domains by logically grouping system boards together. Domains are able to run their own operating system and handle their own workload. See "Domains" on page 56.
- Assign paths to different controllers for I/O devices, which enables the system to continue running in the event of certain types of failures. This feature is known as *alternate pathing (AP)* and is described in the *Sun Enterprise Server Alternate Pathing User's Guide*.
- Monitor and display the temperatures, currents, and voltage levels of one or more system boards or domains.
- Control fan operations.
- Monitor and control power to the components within a platform.
- Execute diagnostic programs such as power-on self-test (POST).

In addition, the SSP environment:

- Warns you of impending problems, such as high temperatures or malfunctioning power supplies.
- Notifies you when a software error or failure has occurred.
- Automatically reboots a domain after a system software failure (such as a panic).
- Keeps logs of interactions between the SSP environment and the domains.

---

## System Architecture

The Sun Enterprise 10000 system platform, the SSP, and other workstations communicate over Ethernet (FIGURE 1-1).

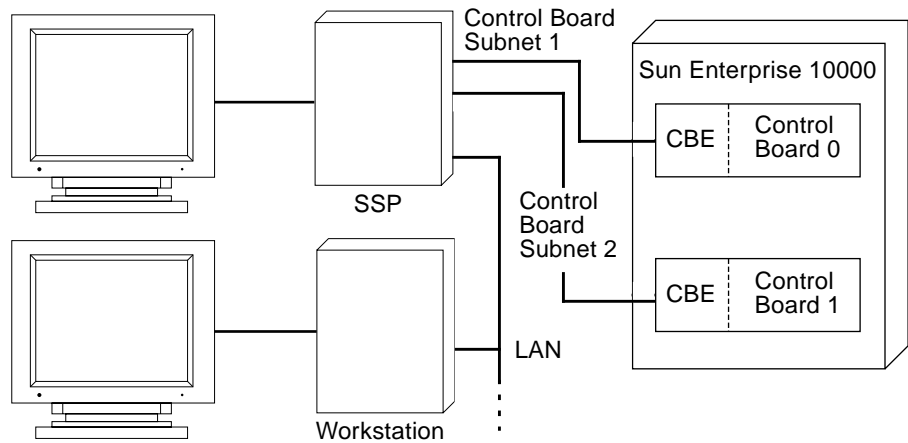

**FIGURE 1-1** Sun Enterprise 10000 system and Control Boards

Dual control boards are supported within the Sun Enterprise 10000 system platform. Each control board runs a control board executive (CBE) that communicates with the SSP over a private network. One control board is designated as the primary control board, and the other is designated as the alternate control board. Only one control board is active at a time. If the primary control board fails, you can manually switch to the alternate control board as described in “Dual Control Board Handling” on page 74.

SSP operations can be performed by entering commands on the SSP console or by remotely logging in to the SSP from another workstation on the local area network. Whether you log in to the SSP remotely or locally, you must log in as user `ssp` and provide the appropriate password if you want to perform SSP operations (such as monitoring and controlling the platform).

---

## SSP User Environment

You can interact with the SSP and the domains on the Sun Enterprise 10000 system by using SSP commands and the SSP GUI programs.

## ▼ To Begin Using the SSP

### 1. Boot the SSP.

### 2. Log in to the SSP as user `ssp`.

If you don't know the password for user `ssp`, ask your system administrator.

### 3. Type:

```
ssp% tail -f $SSPLOGGER/messages
```

### 4. Wait until you see the following message:

```
Startup of SSP programs complete
```

At this point you can begin using SSP programs such as Hostview and `netcontool(1M)`.

## SSP Window

An SSP window provides a command line interface to the Solaris operating environment and SSP environment (FIGURE 1-2).

SSP or Other Workstation Display

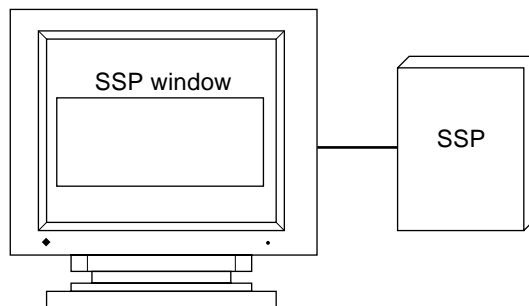

FIGURE 1-2 SSP Window



## ▼ To Display an SSP Window Locally in OpenWindows

1. Log on to the SSP as user `ssp`.
2. When prompted for the value of `SUNW_HOSTNAME`, type in the name of the platform or the name of domain that you want to work with, and then press Return.

The `SUNW_HOSTNAME` environment variable is set to that domain. OpenWindows is started, and a `cmdtool` window is displayed along with a `cmdtool` console window.

If you do not know the name of the domain or platform, ask your system administrator.

## ▼ To Display an SSP Window Locally in the Common Desktop Environment (CDE)

1. Log in to the SSP as user `ssp`.
2. Open an SSP window using one of the following methods:
  - From the CDE front panel under the Solaris 2.5.1 or 2.6 operating environment, select the Personal Applications subpanel (which looks like a notepad), and then select Terminal.
  - From the CDE front panel under the Solaris 7 operating environment, select the Hosts subpanel, and then select This Host.
  - From the Workspace Menu (right mouse click) choose Programs and then select Terminal.

This method works under the Solaris 2.5.1, 2.6, or 7 operating environment.

## ▼ To Display an SSP Window Remotely

1. Use the `rlogin(1)` command to remotely log in to the SSP machine as user `ssp`, and enter the `ssp` password.
2. When prompted, type in the name of the platform or domain you wish to work with, and then press Return.

The `SUNW_HOSTNAME` environment variable is set to the value you enter.

## SSP Console Window

The SSP console window is the console for the SSP workstation. The system uses it to log operating system messages.

### ▼ To Display an SSP Console Window With OpenWindows

---

**Note** – An SSP Console Window is created automatically when OpenWindows starts. Thus, you do not need to use this procedure unless you accidentally exit from the console window.

---

- On the SSP machine, type:

```
ssp% cmdtool -C
```

### ▼ To Display an SSP Console Window Locally With CDE

1. Log in to the SSP as user `ssp`.
2. Open an SSP window using one of the following methods:
  - From the Workspace Menu (right mouse click) choose Programs and then select Console.  
This method works under the Solaris 2.5.1, 2.6, or 7 operating environment.
  - From the CDE front panel under the Solaris 7 operating environment, select the Hosts sub-panel, and then select Console.  
This method works only under the Solaris 7 operating environment.

## Network Console Window

The network console window, or `netcon(1M)` window, receives system console messages (operating system messages) from a domain. (FIGURE 1-3).

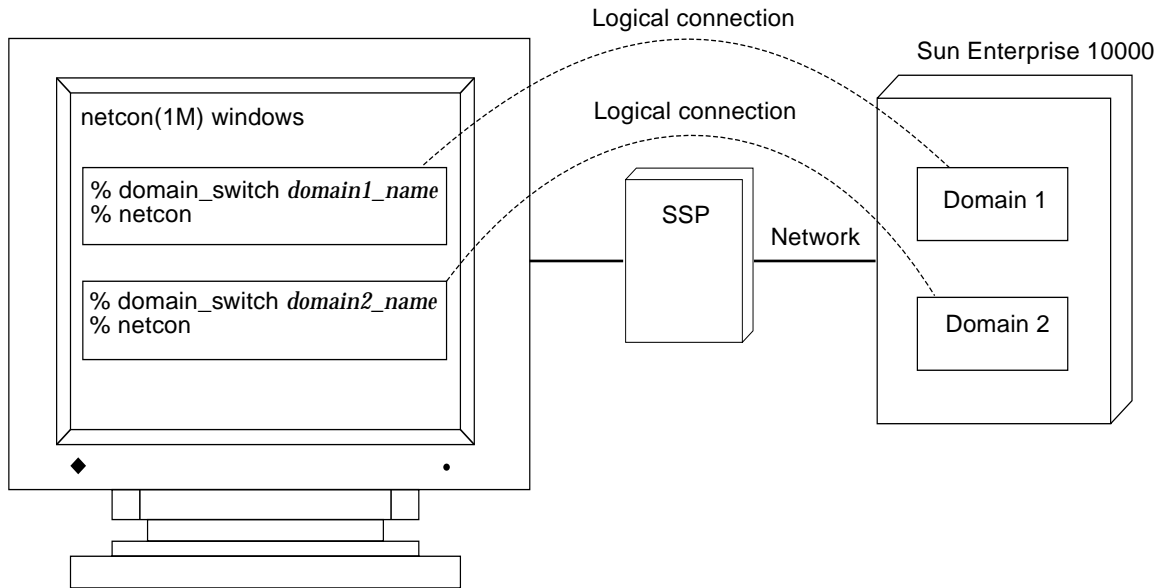
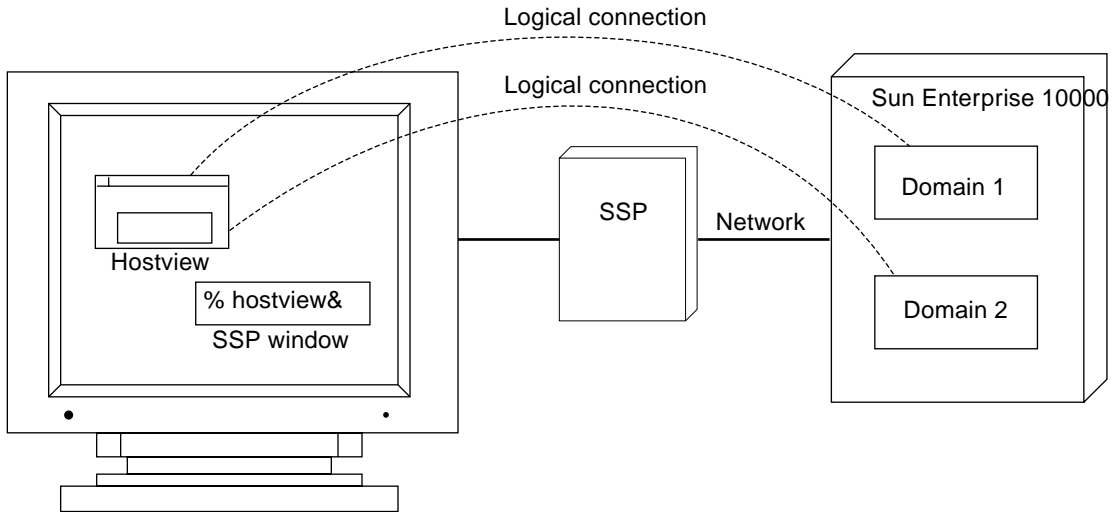

**FIGURE 1-3** netcon(1M) Window

A netcon(1M) window behaves as if a workstation was physically connected to a domain. A netcon(1M) window can be used to boot and halt the operating system. It also logs messages for operations such as dynamic reconfiguration of system boards. For more information, see “netcon and netcontool Windows” on page 32 and the netcon(1M) man page.

## Hostview

The Hostview program provides a graphical user interface (GUI) with the same functionality as many of the SSP commands (FIGURE 1-4).



**FIGURE 1-4** Hostview GUI Program

Hostview is introduced in Chapter 2 and is described in more detail in Chapter 3. It is also described in `hostview(1M)` in the *Sun Enterprise 10000 SSP Reference Manual* (man pages).

## Overview of the SSP Tools

---

This chapter introduces the Hostview GUI as the front-end to SSP commands and the `netcontool(1M)` GUI as the front-end to the `netcon(1M)` command. `netcontool(1M)` simplifies the process of configuring and bringing up `netcon(1M)` windows. You can also use the `netcon(1M)` command directly to display a `netcon(1M)` window. However, when using `netcon(1M)`, you must know escape sequences to perform operations that can be performed by clicking on buttons under `netcontool(1M)`.

The Hostview screen shots in this chapter were taken under OpenWindows. The `netcontool(1M)` screen shots were taken under the Common Desktop Environment (CDE). The window frames and buttons (such as the minimize button and maximize button) appear differently in these two window systems.

---

## Hostview

Hostview enables you to perform administration operations such as:

- Dynamically group system boards into domains. Each domain runs its own instance of the Solaris operating environment and has its own log messages file.
- Boot the Solaris operating environment for a domain.
- Access the SSP log messages file for each platform or domain.
- Remotely log in to each domain.
- Display a `netcon(1M)` window for each domain.
- Edit the `blacklist(4)` file to enable or disable hardware components in a domain.
- Dynamically reconfigure the boards within a platform, logically attaching or detaching them from the operating system. This feature is described in the *Sun Enterprise 10000 Dynamic Reconfiguration User's Guide*.
- Power system boards on and off.
- Monitor the temperature and voltage levels of hardware components.

If you want to run Hostview, you only need to run one instance for a given platform. However, it is possible to run more than one instance simultaneously (perhaps on different workstations) to work with the same platform.

If you have logged into the SSP environment from a remote login session, make sure your `DISPLAY` environment variable is set to your current display and that your `xhost` settings enable the SSP to display on your workstation (see `xhost(1)` in the *Solaris X Window System Reference Manual*).

## ▼ To Start Up Hostview From a Remote Login Session

1. Enable external hosts to display on your local workstation:

```
% xhost +
```

2. Log in to the SSP as user `ssp` and type the `hostview(1M)` command:

```
ssp% setenv DISPLAY machine_name:0.0  
ssp% hostview &
```

## ▼ To Start Up Hostview From the Workspace Menu Locally on the SSP

- From the Workspace Menu (right mouse button click), select **SSP**, and then select **Hostview**.

This is available only when you use the SSP workstation, not when you use a remote login (`rlogin`) session to the SSP.

## ▼ To Start Up Hostview Under CDE From the Front Panel

- Use one of the following methods:
  - Click the SSP icon on the front panel.

This icon shows a hand holding tools.

- Click the arrow above the SSP icon on the front panel, and select `Hostview`

Log in as user `ssp` and type:

```
ssp% hostview &
```

## Hostview Main Window

When you start Hostview, the main window is displayed (FIGURE 2-1).

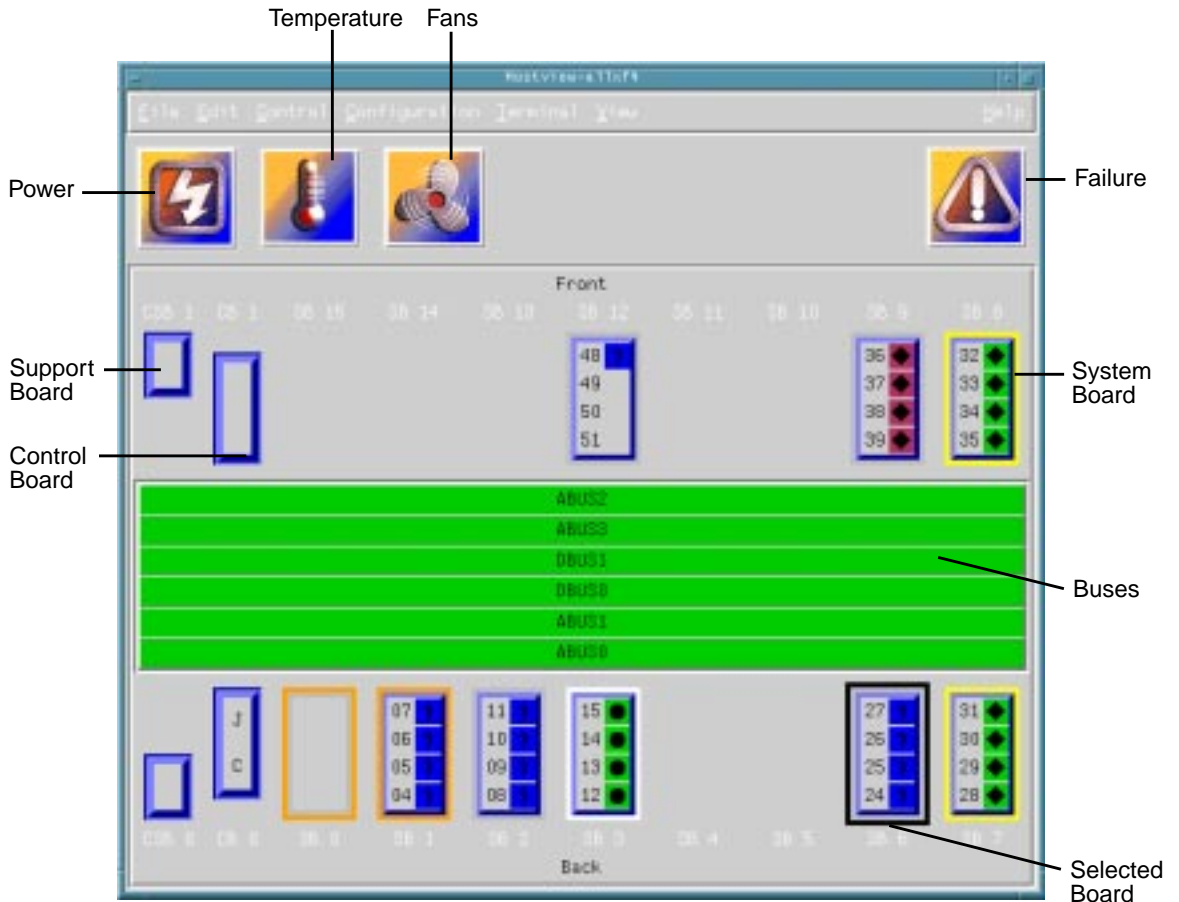

FIGURE 2-1 Hostview Main Window

The menu bar on the main window provides the commands that you use to control the platform. The commands are described in “Main Window Menu Bar” on page 26.

The buttons on the main window (Power, Temperature, and Fans) bring up status details. The buttons are described in “Main Window Buttons” on page 28.

The rest of the main window provides a graphical view of the platform boards and buses. The system boards are named SB0 through SB15, and their processor numbers are shown. The control boards are named CB0 and CB1. The support boards are named CSB0 and CSB1. The buses are named ABUS0 through ABUS3, DBUS0, and DBUS1.

The system boards along the top of the display are arranged in the order they appear on the front side of the physical platform. The system boards along the bottom of the display are arranged in the order they appear on the back side of the physical platform.

If a system board is shown with no outline (FIGURE 2-2), the board is not part of a domain and is not currently selected.

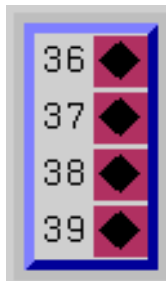

**FIGURE 2-2** Unselected System Board (domain independent)

If a system board is part of a domain (FIGURE 2-3), a colored outline surrounds it. The boards within a given domain all have an outline of the same color.

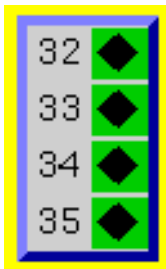

**FIGURE 2-3** Unselected System Board (domain dependent)



A black outline around the domain color outline indicates that a board is selected (FIGURE 2-4). (There are several reasons why you select a board in Hostview. For example, you could select one or more boards, and then create a domain that is based on those boards.)



FIGURE 2-4 Selected System Board (domain dependent)

The processors within the boards are numbered 0 through 63. The processor symbols (diamond, circle, and so forth) indicate the state of the processors and are described in “Main Window Processor Symbols” on page 30.

## Selecting Items in the Main Window

You can select one or more boards in the Hostview main window. You can also select one domain in the main window. You must select a set of boards prior to performing certain operations, such as creating a domain.

- To select a single board, click on it with the left mouse button. The selected board is indicated by a black outline, and all other boards are deselected.
- To select additional boards, click on them with the middle mouse button. You can also deselect a currently selected board by clicking on it with the middle mouse button. (The middle mouse button toggles the selection status of the board without affecting the selection status of any other board.)
- To select a domain, click on a board within that domain with the left mouse button. Note that you can select boards from different domains (using the middle mouse button), but the selected domain will correspond to the board that you selected with the left mouse button.

# Main Window Menu Bar

The items on the main Hostview menu are described in TABLE 2-1.

TABLE 2-1 Hostview Menu Items

Menu	Submenu Items	Description
File	SSP Logs	Displays a window that shows the SSP messages for a domain or for the platform. For more information, see “SSP Log Files” on page 43.
	Quit	Terminates Hostview.
Edit	Blacklist File	Enables you to specify boards and CPUs to be blacklisted.
Control	Power	Displays a window that enables you to use the <code>power(1M)</code> command. See “To Power Components On or Off From Within Hostview” on page 45.
	Bringup	Displays a window that enables you run <code>bringup(1M)</code> on a domain. See “To Bring up a Domain From Within Hostview” on page 64.
	Fan	Displays a window that enables you run the <code>fan(1M)</code> command to control the fans within the platform. See “To Control Fans From Within Hostview” on page 54.
Configuration	Board	Enables you to attach and detach system boards. This feature is described in the <i>Sun Enterprise 10000 Dynamic Reconfiguration User's Guide</i> .
	Domain	Provides a pull-right menu with several choices. The menu choices enable you to create domains, remove domains, rename domains, obtain the status of domains, and view the history of domains. A domain consists of one or more system boards running the same operating system kernel. Domains function independently of each other. Each domain can carry its own workload and has its own log messages file. For more information, see “To Create Domains From Within Hostview” on page 56 and “To Remove Domains From Within Hostview” on page 60.

**TABLE 2-1** Hostview Menu Items (*Continued*)

<b>Menu</b>	<b>Submenu Items</b>	<b>Description</b>
Terminal	netcontool	Displays a window that provides a graphical interface to the <code>netcon(1M)</code> command, enabling you to open a network console window for a domain. This menu item is equivalent to executing the <code>netcontool(1M)</code> command. See “ <code>netcon</code> and <code>netcontool</code> Windows” on page 32.
	SSP	Provides pull-right menu choices that enable you to display an SSP Window in <code>xterm</code> , <code>dterm</code> , <code>shelltool</code> , or <code>cmdtool</code> format with a platform or domain as its host. Choose a domain (by selecting any system board within that domain) before choosing this option.
	rlogin	Provides pull-right menu choices that enable you to remotely log in to the selected platform or domain in an <code>xterm</code> , <code>dterm</code> , <code>shelltool</code> , or <code>cmdtool</code> window. Choose a domain (by selecting any system board within that domain) before choosing this option.
View	All Domains	Displays the boards within all domains, as well as any boards that are not part of a domain. (A board can be present without being part of a domain, although a board cannot be used when it is not part of a domain.)
	Individual Domains	When you select an individual domain, only the boards within that domain are displayed. Note that the color of the outline used to designate a given domain is also used as the background color for that domain in the menu. The system board numbers for the boards that belong to each domain are shown in square brackets.
Help	<i>Topic</i>	Provides online help information on several topics.

# Help Window

When you choose a topic from the Help menu, the Hostview - Help window is displayed (FIGURE 2-5).

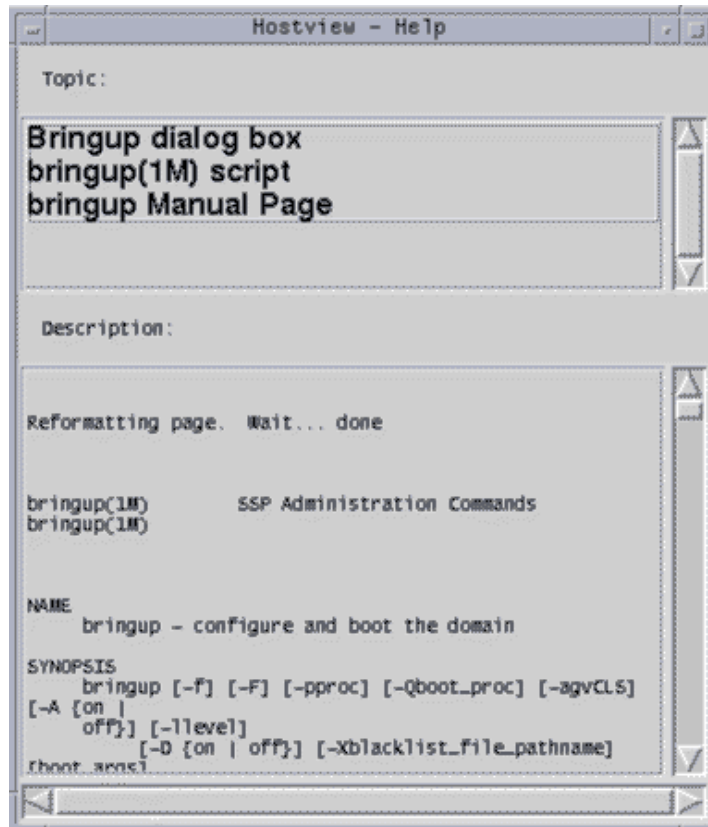

FIGURE 2-5 Hostview Help Window

You can select the desired topic in the upper pane. The corresponding help information is displayed in the lower pane.

## Main Window Buttons

The main Hostview window contains the buttons described below. If an out-of-boundary condition exists or an error has occurred, one or more of these buttons turn red.

The Power button (FIGURE 2-6) displays the Power Control and Status window, which enables you to view the power status for the platform. See “To Power Components On or Off From Within Hostview” on page 45.



**FIGURE 2-6** Power Button

The Temperature button (FIGURE 2-7) displays the Thermal Status window, which enables you to view the temperature status for the boards and components within the platform. See “To Monitor Thermal Conditions From Within Hostview” on page 50.

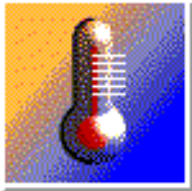

**FIGURE 2-7** Temperature Button

The Fan button (FIGURE 2-8) displays the Fan Status window, which enables you to view the status of the fans within the platform. See “To Monitor Fans From Within Hostview” on page 52.



**FIGURE 2-8** Fan Button

When certain error conditions occur, the Failure button (FIGURE 2-8) turns red. If you click a red Failure button, a window is displayed showing the error condition(s) that have occurred.



**FIGURE 2-9** Failure Button

TABLE 2-2 contains the types of error conditions trapped by this mechanism.

**TABLE 2-2** Error Conditions

Error Message	Description
Host panic recovery in progress	The operating system on a domain has failed and is recovering.
Heartbeat failure recovery in progress	The SSP was not receiving updated platform or domain information as expected.
Arbitration stop recovery in progress	A parity error or other fatal error has occurred, and the domain is recovering. See arbitration stop in the glossary.
Host reboot is in progress	The domain is being manually rebooted.
Power-on-bringup recovery in progress	The platform and domains failed due to a power outage. Power has been restored, and the system is bringing up the domains.

## Main Window Processor Symbols

In the main window, the shape and background color of a processor symbol indicate the status of that processor. For example, a diamond on a green background indicates the processor is running the operating system.

The shape indicates the mode in which the processor is running. The following list contains the possible modes of the processor.

- Operating system
- hpost(1M)
- download\_helpers
- OBP

- Unknown program

TABLE 2-3 lists the color scheme of a symbol which indicates the state of a processor.

**TABLE 2-3** Processor Color Scheme

Color	State
Green	Running
Maroon	Exiting
Yellow	Prerun (The OS is currently being loaded.)
Blue	Unknown
Black	Blacklisted (The processor is unavailable to run programs or diagnostics.)
Red	Redlisted (The processor is unavailable to run programs or diagnostics and its state may not be changed.)
White	Present but not configured (The processor is unavailable, but not blacklisted or redlisted. One example is a board that has been hot-swapped in, but has not yet been attached to the operating system.)

## Hostview Performance Considerations

Each instance of Hostview requires up to 10 Mbytes of the available swap space in the SSP. Before running multiple copies of Hostview, make sure the SSP has sufficient swap space available. For example, if you plan to run three instances of Hostview, make sure you have at least 30 Mbytes of swap space.

---

# netcon and netcontool Windows

## Overview of netcon(1M)

The `netcon(1M)` command is similar to `netcontool(1M)` except that no GUI interface is provided, making it more functional for dial-in or other low-speed network access. Typically, you log in to the SSP machine as user `ssp`, and enter the `netcon(1M)` command in an SSP window. For example:

```
ssp% domain_switch domain_name
ssp%
netcon
```

This action changes the window in which you run the `netcon(1M)` command into a `netcon(1M)` window for the domain specified by the `domain_switch(1M)` command. Multiple `netcon(1M)` windows can be open simultaneously, but only one at a time can have write privileges to a specific domain. When a `netcon(1M)` window is in read-only mode, you can view messages from the `netcon(1M)` window, but you cannot enter any commands.

You can specify the `netcon(1M)` option `-g` for Unlocked Write permission, `-l` for Locked Write permission, `-f` to force Exclusive Session mode, or `-r` for read only mode. See the `netcon(1M)` man page for an explanation of how `netcon(1M)` behaves if you do not specify any of these arguments.

If you have write permission, you can enter commands. In addition, you can enter special commands prefixed by atilde (~) to perform the functions offered by the `netcontool(1M)` window.

## Overview of netcontool(1M)

The `netcontool(1M)` GUI program provides the buttons shown in FIGURE 2-10.

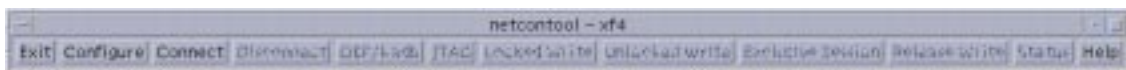

FIGURE 2-10 netcontool GUI Program



TABLE 2-4 explains the `netcontool(1M)` buttons.

TABLE 2-4 netcontool buttons

Button	Description
Configure	Displays the Console Configuration window. See “To Configure the <code>netcontool(1M)</code> Window” on page 37 for more information
Connect	Displays the <code>netcon(1M)</code> window and initiates the connection process.
Disconnect	Disconnects the console window from the domain and removes the console window. The <code>netcontool(1M)</code> window is still available so that you can reconfigure for another connect session.
OBP/kadb	Breaks to the OpenBoot™ PROM (OBP) or <code>kadb(1M)</code> programs.
JTAG	Toggles the SSP-to-platform connection between a network connection and a JTAG connection.
Locked Write, Unlocked Write, and Exclusive Write	Request the corresponding mode for the console window. For an explanation of the meaning of these modes, see “To Configure the <code>netcontool(1M)</code> Window” on page 37.
Release Write	Releases write access and places the console in read only mode.
Status	Displays information about all open consoles that are connected to the same domain as the current session, as well as the connection type currently used.
Help	Displays information about the <code>netcontool(1M)</code> window.
Exit	Exits the program and removes the <code>netcon(1M)</code> window if it is still open.

## ▼ To Display a `netcon(1M)` Window From a `netcontool(1M)` Window

1. Display a `netcontool(1M)` window, as described in one of the following procedures:
  - “To Display a `netcontool(1M)` Window From the Command Line” on page 35
  - “To Display a `netcontool(1M)` Window From the CDE Front Panel” on page 36
  - “To Display a `netcontool(1M)` Window From the CDE Workspace Menu” on page 36
  - “To Display the `netcontool(1M)` Window From Hostview” on page 36
2. Optionally, configure a `netcontool(1M)` window as described in “To Configure the `netcontool(1M)` Window” on page 37.

**3. Click the Connect button in the netcontool(1M) window.**

This displays the netcon(1M) window. netcon(1M) attempts to connect to your default domain, assuming you did not specify a domain in the Console Configuration window (described in “To Configure the netcontool(1M) Window” on page 37). If you *did* specify a domain in the Console Configuration window, netcon(1M) attempts to connect to that domain.

If no error occurs, the netcon(1M) window is displayed directly beneath the netcontool(1M) window. Note that these are two separate windows, although they can affect each other. You can view messages in the console window and, if you have write permission, enter commands.

## ▼ To Display a netcon(1M) Window From the Command Line

1. Log in to the SSP as user ssp.
2. Type:

```
ssp% domain_switch domain_name  
ssp% netcon
```

For more information about the netcon(1M) command options, refer to the netcon(1M) man page.

## ▼ To Display a netcon(1M) Window From the CDE Front Panel

1. From the CDE front panel, select the SSP subpanel and then select the netcon option.
2. Specify the domain name when prompted to do so.

## ▼ To Display a netcon(1M) Window From the CDE Workspace Menu

1. From the CDE Workspace menu (right click), select the SSP submenu and then select the netcon option.

2. Specify the domain name when prompted to do so.

## ▼ To Exit from a `netcon(1M)` Window

- Type the following escape sequence (tilde (~) followed by a period) in the `netcon(1M)` window:

```
# ~.
```

If you enter the tilde period sequence locally at the SSP workstation or remotely through a `telnet(1)` session, your `netcon(1M)` session is terminated and the window returns to its previous state. However, if you enter the tilde period sequence remotely through an `rlogin(1)` session, the `netcon(1M)` session is terminated *and* the `rlogin(1)` window is deleted as well. This is because the tilde period sequence is recognized by `rlogin(1)` as an exit command. If you want to avoid this behavior, you can use the sequence `~.`, that is tilde tilde period, to exit from a `netcon(1M)` window running inside of an `rlogin(1)` session. For more information about escape sequences, see the `netcon(1M)` manual page.

## ▼ To Display a `netcontool(1M)` Window From the Command Line

1. Log in to the SSP as user `ssp`.
2. Type:

```
ssp% domain_switch domain_name  
ssp% netcontool &
```

## ▼ To Display a `netcontool(1M)` Window From the CDE Front Panel

1. From the CDE front panel, select the `SSP` subpanel and then select the `netcontool` option.
2. Specify the domain name when prompted to do so.

## ▼ To Display a netcontool(1M) Window From the CDE Workspace Menu

1. From the CDE Workspace menu (right click), select the SSP submenu and then select the netcontool option.
2. Specify the domain name when prompted to do so.

## ▼ To Display the netcontool(1M) Window From Hostview

1. Select a board from the domain for which you want to display a netcontool(1M) window by clicking on that board with the left mouse button.
2. Select Terminal % netcontool.
3. In the netcontool(1M) window, click the Connect button.

The netcontool(1M) window (FIGURE 2-11) is displayed beneath the netcontool(1M) buttons.

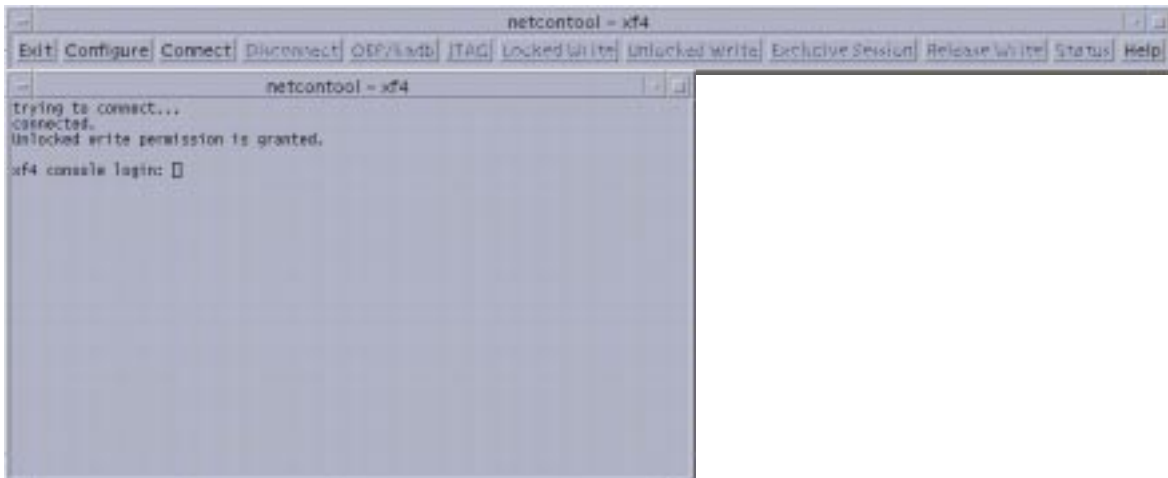
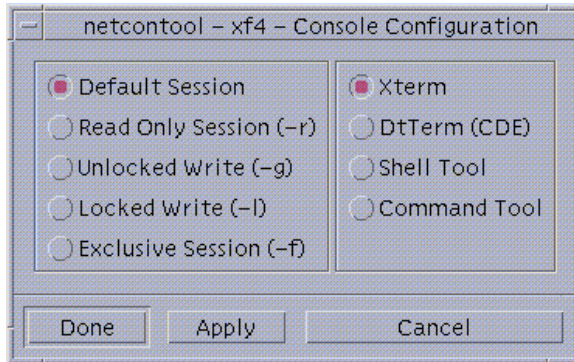

FIGURE 2-11 netcontool Window in Hostview

## ▼ To Configure the netcontool(1M) Window

1. Click the **Configure** button if you want to configure the netcontool(1M) window before you display a netcon(1M) window.

The Console Configuration window is displayed (FIGURE 2-12).



**FIGURE 2-12** netcontool Console Configuration Window

2. Select the session type in the left panel, and the terminal emulation type in the right panel.

3. When you are satisfied with the contents of the window, you click **Done** to accept the settings and dismiss the window, or click **Apply** to accept the settings without dismissing the window.

The following table contains the options in the Console Configuration. window.

**TABLE 2-5** Console Configuration

Console	Options
Default Session	This causes the default type of session to be started. If no other session is running, the default is unlocked write mode. If any other session is running, the default is read only mode.
Read Only Session	Displays a console window where you can view output from a domain, but you cannot enter commands.
Unlocked Write Session	Attempts to display a <code>netcon(1M)</code> window with unlocked write permission. If this attempt succeeds, you can enter commands into the console window, but your write permission is taken away whenever another user requests Unlocked Write, Locked Write, or Exclusive Session permission for the same domain. <ul style="list-style-type: none"> <li>• If another user currently has Unlocked Write permission, it is changed to read-only permission, and you are granted Unlocked Write permission.</li> <li>• If another user currently has Locked Write permission, you are granted read-only permission.</li> <li>• If another user currently has Exclusive Session permission, you are not allowed to display a <code>netcon(1M)</code> window.</li> <li>• If you are granted Unlocked Write permission and another user requests Unlocked Write or Locked Write permission, you are notified and your permission is changed to read only. You can attempt to reestablish Unlocked Write permission at any time, subject to the same constraints as your initial attempt to gain Unlocked Write permission.</li> </ul>

**TABLE 2-5** Console Configuration

Console	Options
Locked Write	<p>Attempts to display a console window with Locked Write permission.</p> <ul style="list-style-type: none"> <li>• If you are granted Locked Write permission, no other user can remove your write permission unless they request Exclusive Session permission.</li> <li>• If another user currently has Locked Write permission, you are granted read-only permission.</li> <li>• If another user currently has Locked Write permission, you are granted read-only permission.</li> <li>• If another user currently has Exclusive Session permission, you are not allowed to display a <code>netcon(1M)</code> window.</li> </ul>
Exclusive Session	<p>Displays a console window with Locked Write permission, terminates all other open console sessions for this domain, and prevents new console sessions for this domain from being started. You can change back to multiple session mode by clicking the Release Write button to release write access, or by clicking the Disconnect button to terminate your console session for the domain. You can also simply quit from the console window (using the Control menu of the window). You are not granted Exclusive Session permission if any other user currently has exclusive session permission.</p>
Terminal Emulation Type	<p>The <code>netcon(1M)</code> window is brought up in the specified type of window. The default is <code>xterm(1)</code>. <code>dtterm(1)</code> is only available if you are running the Common Desktop Environment (CDE), otherwise it is grayed out. You can also use <code>shelltool(1)</code> or <code>cmdtool(1)</code>.</p>

## netcon(1M) Communications

`netcon(1M)` uses two distinct paths for communicating console input/output between the SSP and a domain: the standard network interface and the CBE interface. Usually, when the domain is up and running, console traffic flows over the network. If the local network becomes inoperable, all interactive access to the domain is lost and, for example, `telnet`, `rlogin`, and `netcon(1M)` sessions hang. In this case, you can switch to the CBE interface and access the host's console window. To perform this switch, use the `~ =` command in the `netcon(1M)` window.

---

## netcon(1M) Message Logging

Certain messages sent from the kernel are not displayed in the syslog messages file, such as OpenBoot messages, panic messages, and some console messages. The reason for this is that `syslogd(1M)` must run on the host to log the messages, and this is not possible when a panic occurs, nor is it possible at certain times during the boot sequence. Moreover, panic dumps often fail, so these types of messages may not even appear in a dump file to help you determine the cause of the failure.

However, you can capture all output displayed on an active `netcon(1M)` console through the `LOCAL1` facility of `syslog(1M)` and the SSP `machine_server(1M)`. This functionality is enabled through the `/etc/syslog.conf` and `$$SSPLOGGER/.logger` files. When enabled, `netcon(1M)` session output is recorded in file `$$SSPLOGGER/domain_name/netcon`, where `$$SUNW_HOSTNAME` is set to the hostname for the domain. By default, this functionality is disabled.

### ▼ To Enable netcon(1M) Logging

1. In the file `/etc/syslog.conf`, **uncomment the `local1.debug` line.**
2. **Force `syslogd` to reread its configuration file:**

```
ssp# kill -HUP 'cat /etc/syslog.pid'
```

### ▼ To Disable netcon(1M) Logging Sessions for Specific Hosts

Once logging of `netcon` sessions are enabled as above, logging can be disabled for specific domains.

- **Start `netcon_server` with the `-S` flag for a specific domain.**

```
ssp% domain_switch domain_name
ssp% netcon_server -r -S &
```



The `-S` flag, to suspend `netcon` session output, can also be used with `bringup`, which passes the flag on to `netcon_server`, for example:

```
ssp% bringup -S
```

Either method disables output for `netcon` sessions when otherwise enabled with the `syslog.conf` and `.logger` files as above.

## ▼ To Re-Enable `netcon(1M)` Logging Sessions for Specific Hosts

If you have disabled `netcon(1M)` logging as described in “To Disable `netcon(1M)` Logging Sessions for Specific Hosts” on page 40, you can re-enable `netcon(1M)` logging.

- **Start** `netcon_server`:

```
ssp% domain_switch domain_name  
ssp% netcon_server -r &
```



## System Administration Procedures

---

This chapter describes the Sun Enterprise 10000 system administration procedures. Also see the man pages in the *Sun Enterprise 10000 SSP Reference* and *SunOS Reference Manual*. For information about standard system administration functions, see the *System Administrator AnswerBook* for your version of the Solaris operating environment.

You can run many Sun Enterprise 10000 system administration procedures on the SSP by using Hostview and `netcontool(1M)`.

---

### SSP Log Files

When you perform procedures on an SSP, error messages for a particular domain are logged in the file:

```
$SSPLOGGER/domain_name/messages
```

where *domain\_name* is the host name of the domain for which the error occurred.

Error messages for the platform (which are not specific to a domain) are logged in the file:

```
$SSPLOGGER/messages
```

The SSP environment variables, such as `SSPLOGGER`, are described in “Environment Variables” on page 89.

## ▼ To View a messages File From Within Hostview

### 1. Select the appropriate board.

- If you want to view the `messages` file for a particular domain, select that domain in the main Hostview window (by clicking on a board from that domain with the left mouse button).
- If you want to view the `messages` file for the platform, make sure that no domain is selected.

### 2. Choose SSP Logs from the File menu.

- The SSP Logs window is displayed (FIGURE 3-1).

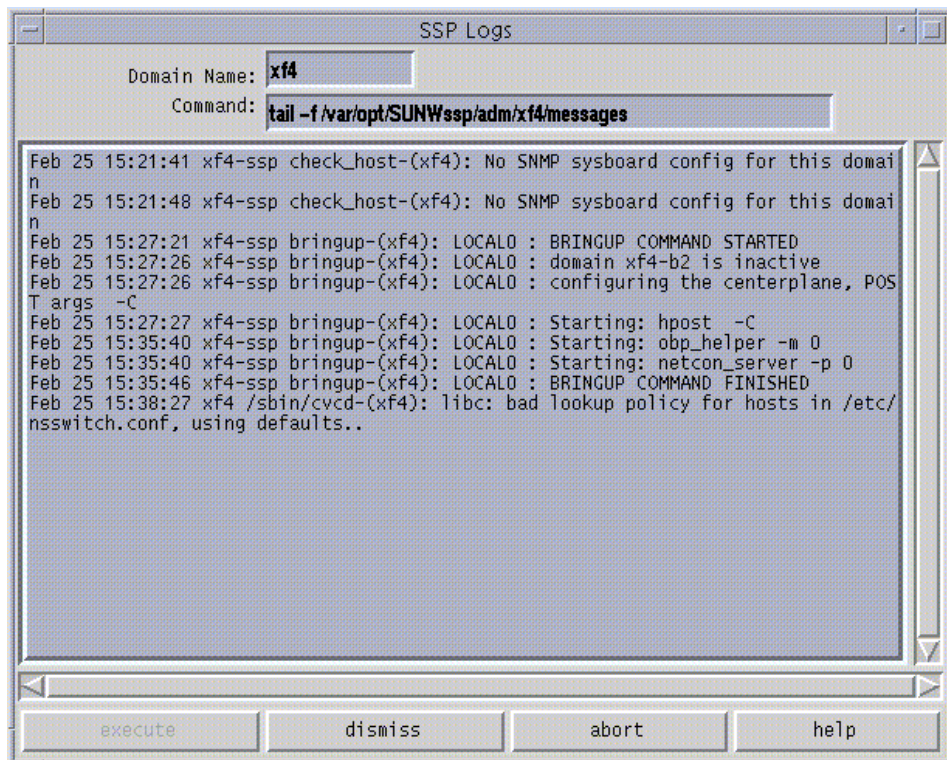

FIGURE 3-1 SSP Logs Window

The Domain Name field shows the name of the domain that you selected. The messages file is displayed in the main panel of the window.

---

# Power

This section describes how to control the system power resources from within Hostview or from the command line, to control the peripherals power resources from the command line, and to monitor the power levels in Hostview.

## ▼ To Power Components On or Off From Within Hostview

- 1. Click the left mouse button to select a board in the main Hostview window.**
- 2. Choose Power from the Control menu.**

The Power Control and Status window is displayed (FIGURE 3-2).

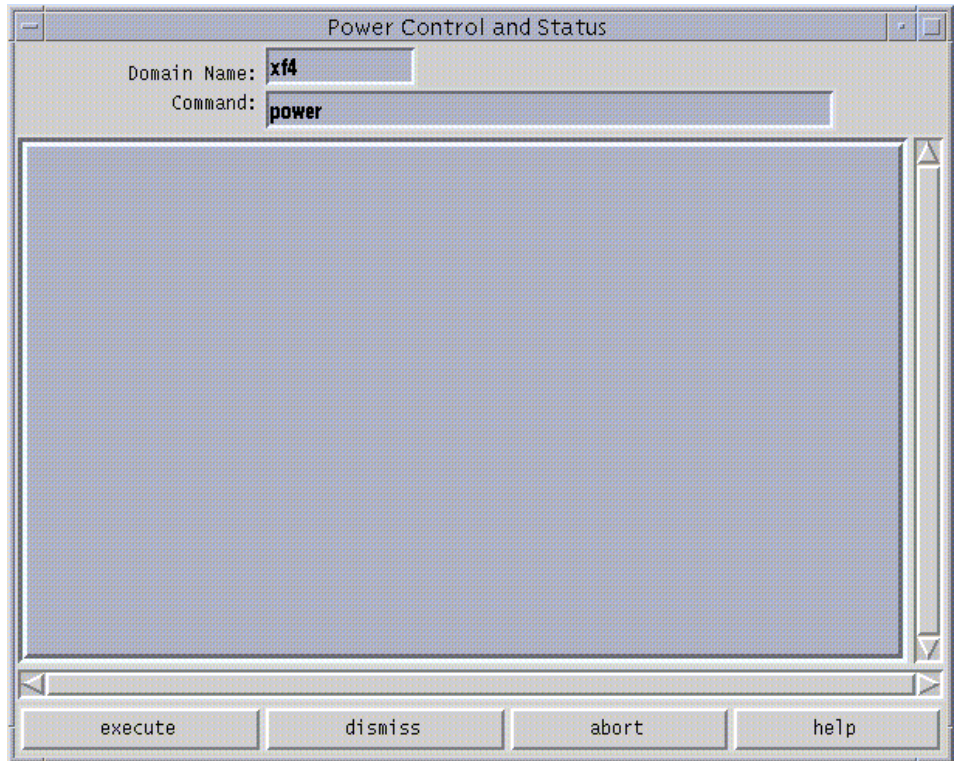

**FIGURE 3-2** Power Control and Status Window

The default `power(1M)` command is displayed in the Command field.

**3. Optionally, add options to the `power(1M)` command.**

**4. Click the Execute button (or press Return) to run the command.**

The results are shown in the main panel of the window.

**5. For information about the `power(1M)` command, click the Help button.**

A help window is displayed. See “Help Window” on page 28.

After powering on the necessary components, you can run the `bring up` command on the SSP for each domain you want to boot. See “To Bring up a Domain From Within Hostview” on page 64.

If you try to power off the system while any domain is actively running the operating system, the command fails and a message is displayed in the message panel of the window. In this case, you have two choices. You can reissue the command to power off by executing `power(1M)` command again with the `-f` (force) option. Or, you can issue a `shutdown(1M)` or similar command for the active

domain(s) to gracefully shut down the processors, and then reissue the `power off` command. Using `shutdown(1M)` ensures that all resources are de-allocated and users have time to log out before the power is turned off. To use `shutdown(1M)`, you must be logged in to the domain as superuser.

If the platform loses power due to a power outage, Hostview displays the last state of each domain before power was lost.

## ▼ To Resynchronize Hostview With the Platform After a Power Failure on the Platform

If power is lost on the platform but not the SSP, perform the following step to resynchronize Hostview with the platform.

- **Determine the `snmpd` process ID, and then kill that process:**

```
ssp% kill -9 snmpd_pid
```

## ▼ To Power System Boards On and Off From the Command Line

- **To power system boards on, type:**

```
ssp% power -on -sb board_list
```

where *board\_list* is a list of system boards separated by spaces, such as  
3 5 6.

- **To power system boards off, type:**

```
ssp% power -off -sb board_list
```

where *board\_list* is a list of system boards separated by spaces, such as  
3 5 6.

## ▼ To Monitor Power Levels in Hostview

1. Click the **Power button** (FIGURE 3-3).



**FIGURE 3-3** Power Button

The Power Status Display window is displayed (FIGURE 3-4).



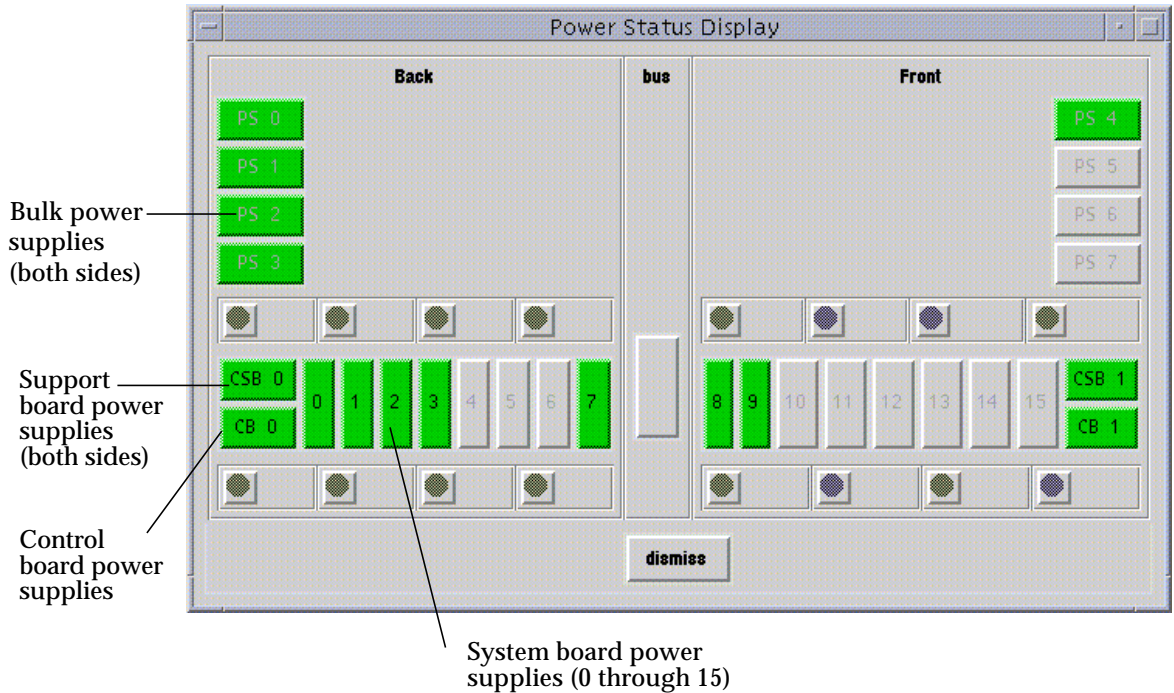

**FIGURE 3-4** Power Status Display

In this window, the bulk power supplies are named PS0 through PS7. The system board power supplies are numbered 0 through 15. The support board power supplies are named CSB0 and CSB1. The control board power supplies are named CB0 and CB1.

Power supplies can be colored green, red, or grey. A green power supply is functioning properly. A red power supply has failed. A grey power supply is not present.

**2. Click on a system board.**

The Power Detail window for that board is displayed (FIGURE 3-5).

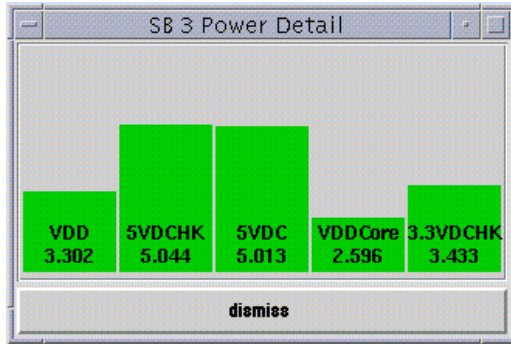

**FIGURE 3-5** System Board Power Detail Window

The Power Detail window shows the voltage for each of the five power supplies on the board. The power levels are indicated in volts. The bars give a visual representation of the relative voltage levels so that you can monitor them more easily. If a bar is green, the voltage level is within the acceptable range. If a bar is red, the voltage level is either too low or too high. (Thus, a red bar can be short or tall.) The bars never grow taller than the height of the window, so voltage levels that exceed the maximum threshold are displayed as red maximum-height bars. Similarly, bars never shrink below a minimum height, so voltage levels below the minimum threshold are displayed as red minimum-height bars.

The only difference between the detail for a system board and the detail for a control board or support board is the number of power supplies.

---

## Thermal Conditions and Fans

This section describes how to administer the thermal conditions and fans from within Hostview and how to monitor and to control the fans from within Hostview.

### ▼ To Monitor Thermal Conditions From Within Hostview

You can use Hostview to monitor thermal conditions for power supplies, processors, (ASICs), and other sensors located on system boards, support boards, controller boards, and the centerplane.

1. **Click the Temperature button** (FIGURE 3-6).

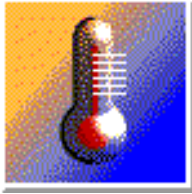

**FIGURE 3-6** Temperature Button

The Thermal Status Display window is displayed (FIGURE 3-7).

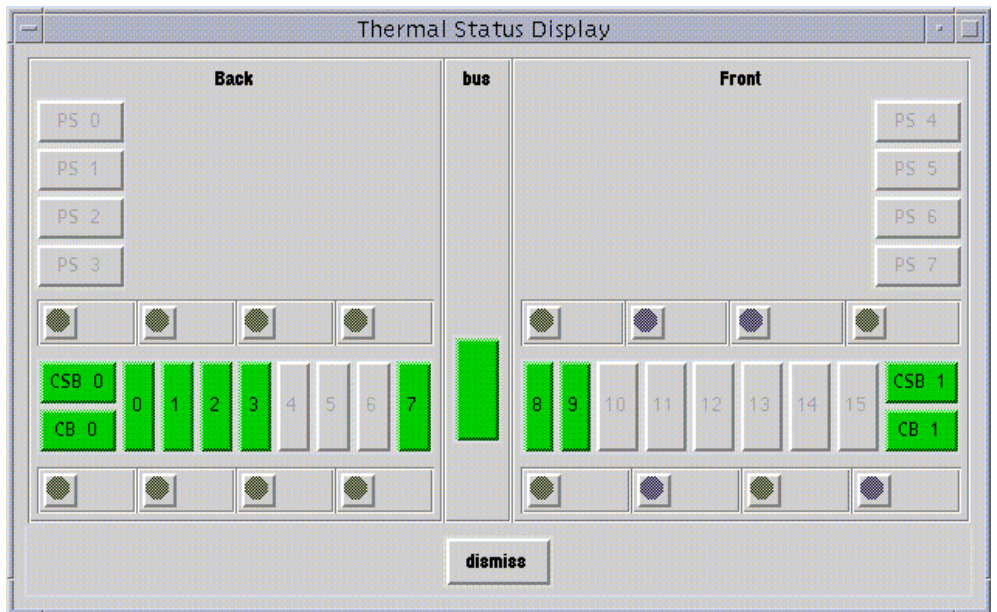
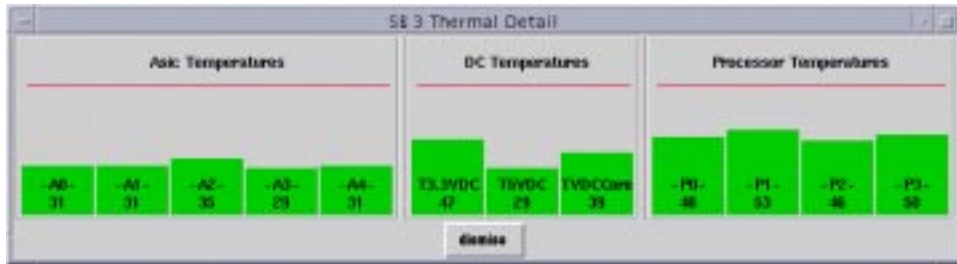

**FIGURE 3-7** Thermal Status Display

The centerplane, support boards, control boards, and system boards are shown in green if their temperatures are in the normal range, and in red otherwise.

- 2. Click on a component with the left mouse button to see the thermal details about that component.**

The Thermal Detail window for that component is displayed (FIGURE 3-8).



**FIGURE 3-8** System Board Thermal Detail

The left panel of the system board detail shows the temperatures for the five ASICs, named A0 through A4. The middle panel shows the temperatures for the three power supplies. The right panel shows the temperatures for the four processors, named P0 through P3.

The temperatures are displayed in degrees centigrade, and the values are shown numerically and as vertical bars. The vertical bars are colored green if the temperature is within the normal range, and red otherwise. The bars never grow taller than the height of the window, so temperature levels above the maximum threshold are displayed as red maximum-height bars. Similarly, bars never shrink below a minimum height, so temperature levels below the minimum threshold are displayed as red minimum-height bars.

The detail windows for control boards, support boards, and the center plane are similar.

## ▼ To Monitor Fans From Within Hostview

You can use Hostview to monitor fan speeds and fan failures for the 32 fans located throughout the Sun Enterprise 10000 system platform.

1. **Click on the Fan button** (FIGURE 3-9).

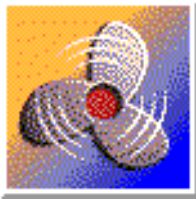

**FIGURE 3-9** Fan Button

The Fan Status Display window is displayed (FIGURE 3-10).

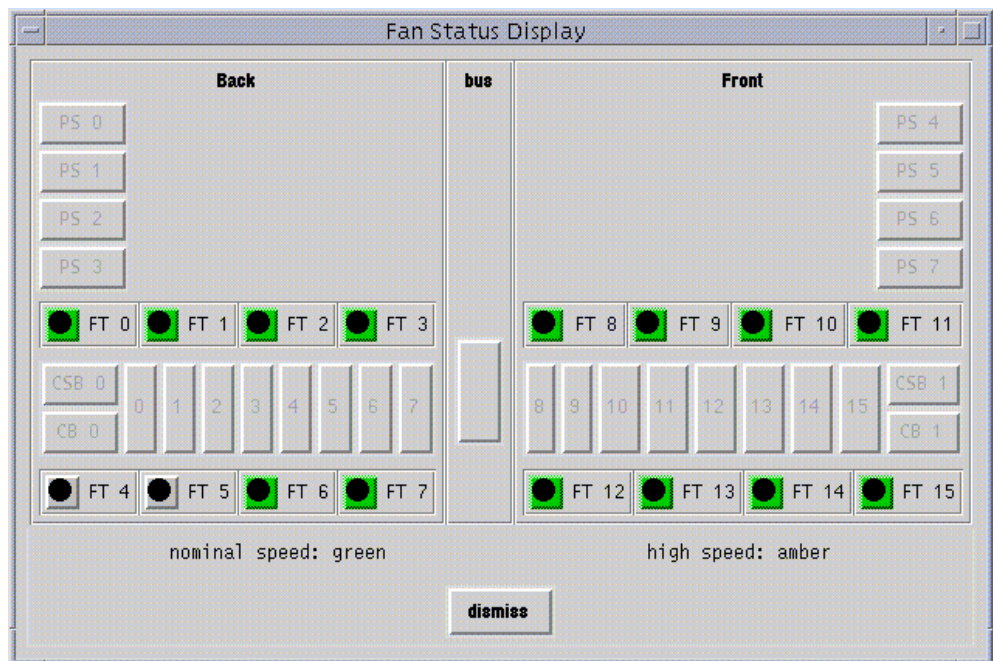
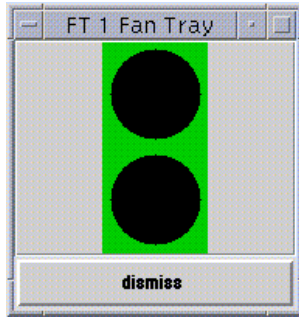

**FIGURE 3-10** Fan Status Display

The fan trays are named FT0 through FT7 on the back, and FT8 through FT15 on the front. Each fan tray contains two fans. The color of the fan tray symbol is green if both fans in the tray are functioning at normal speed, amber if both fans are functioning at high speed, and red if either fan within the fan tray has failed.

2. Click on a fan tray symbol with the left mouse button to see a detail window about that fan.

The Fan Tray window is displayed (FIGURE 3-11).



**FIGURE 3-11** Fan Tray Window

The top circle indicates the inner fan when you open the fan tray, and the lower circle indicates the outer fan. The color surrounding each circle in the fan detail indicates the status of that fan. The colors are green for normal operation at normal speed, amber for normal operation at high speed, and red for failure.

## ▼ To Control Fans From Within Hostview

You can control fan power and speed from within Hostview.

- 1. Choose Fan from the Control menu.**

The Fan Control and Status window is displayed (FIGURE 3-12).



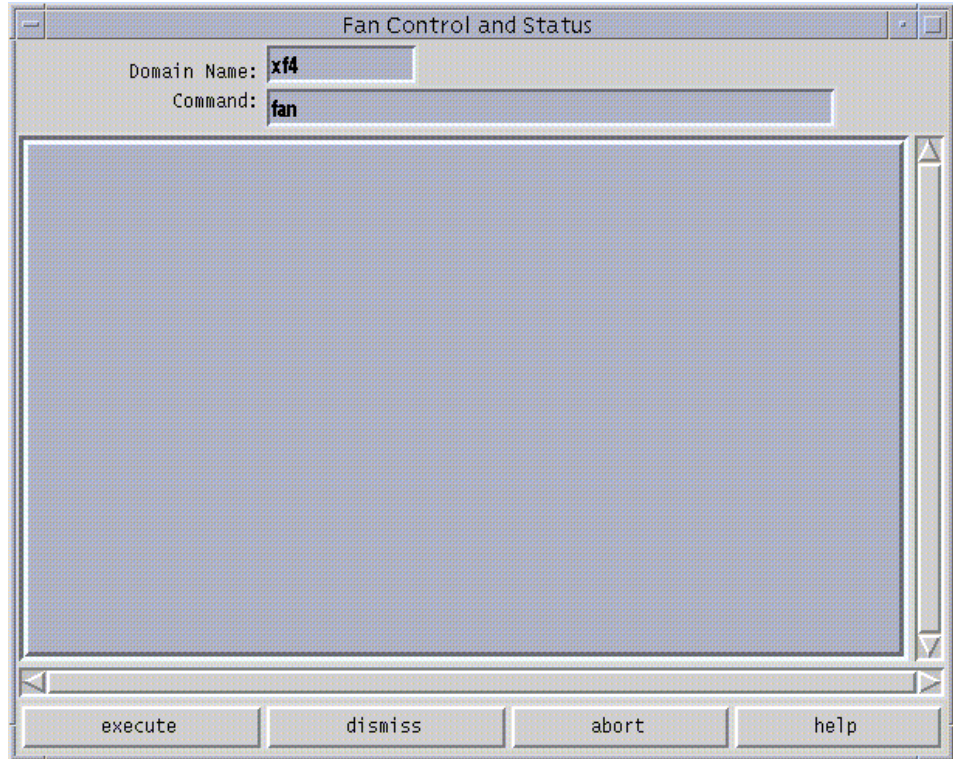

**FIGURE 3-12** Fan Control and Status Window

The Domain Name field shows the selected domain from the platform to which Hostview is connected. The `fan(1M)` command is shown in the Command field without any options.

- 2. Add the desired set of options to the `fan(1M)` command, and click the execute button (or press Return).**

For example, if you want to set the fans on the front fan shelves to high speed, type:

```
fan -s fast
```

For information on the `fan(1M)` command, click the Help button. A help window is displayed (see “Help Window” on page 28). Or, refer to the `fan(1M)` man page.

---

# Domains

The SSP supports commands that let you logically group system boards into Dynamic System Domains, or simply *domains*, which are able to run their own operating system and handle their own workload. Domains can be created and deleted without interrupting the operation of other domains. You can use domains for many purposes. For example, you can test a new operating system version or set up a development and testing environment in a domain. In this way, if problems occur, the rest of your system is not affected. You can also configure several domains to support different departments, with one domain per department. In this situation, you might reconfigure the system into one domain to run a large job over the weekend.

## Domain Configuration Requirements

You can create a domain out of any group of system boards, provided the following conditions are met:

- The boards are present and not in use in another domain.
- At least one board has a network interface.
- The boards have sufficient memory to support an autonomous domain.
- The name you give the new domain is unique (as specified in the `domain_create(1M)` command) and this name matches the host name of the domain to be booted (as specified by the `SUNW_HOSTNAME` environment variable).
- You have an `eeprom.image` file for the domain that was shipped to you by the factory. If your `eeprom.image` file has been accidentally deleted or corrupted and you do not have a backup, see “To Recreate the `eeprom.image` File” on page 59.

There must be at least one boot disk connected to one of the boards that will be grouped together into a domain. Alternatively, if a domain does not have its own disk, there must be at least one network interface so that you can boot the domain from the network.

### ▼ To Create Domains From Within Hostview

---

**Note** – Before proceeding, read the requirements in the previous section, “Domain Configuration Requirements” on page 56. If the system configuration must be changed to meet any of these requirements, call your service provider.

---



1. Click the left mouse button on the first board.
2. Click the middle mouse button on any additional boards.  
Ensure that the boards you select do not currently belong to any domain.
3. Choose **Domain then Create** from the Configuration menu.  
The Create Domain window is displayed (FIGURE 3-13).

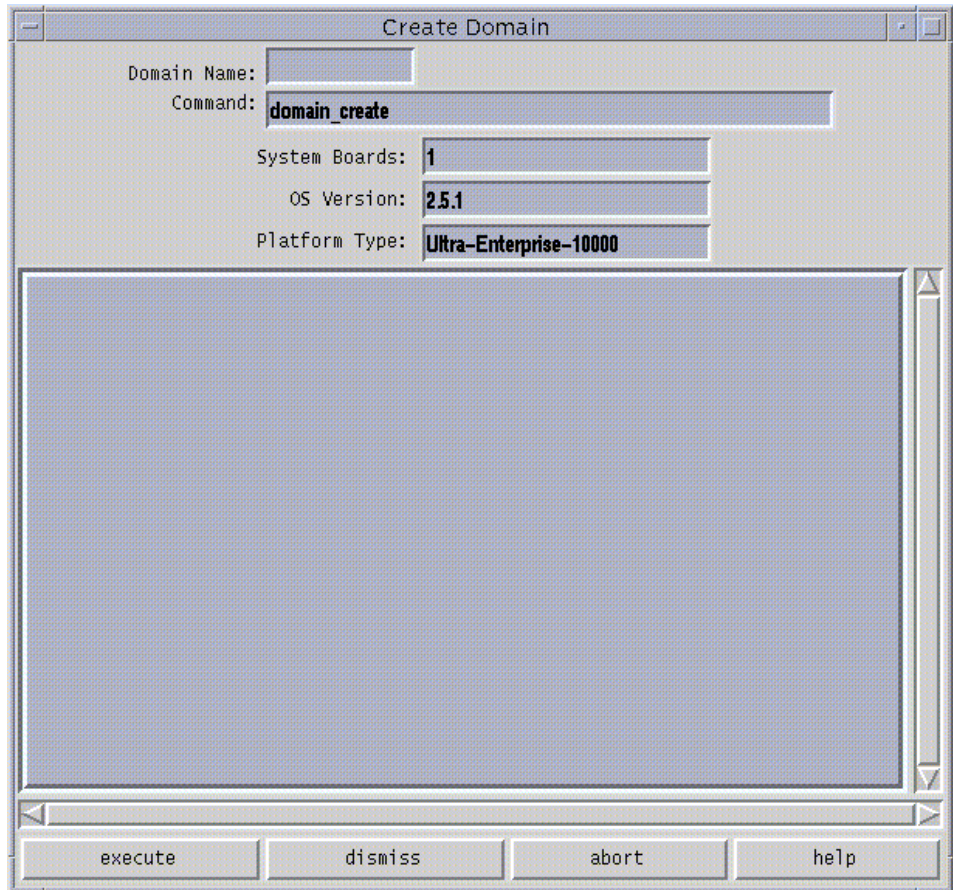

**FIGURE 3-13** Create Domain Window



---

**Caution** – You must be sure to specify the proper OS Version number for the domain you are creating. The default is 2.5.1. Edit this version number, if necessary, to reflect the version of the operating system for the domain you are creating.

---

#### 4. Type the domain name.

The name of the domain will be given to you by the factory. It cannot be an arbitrary name.

#### 5. If all other fields are acceptable, click execute.

Note that the System Boards field indicates the boards that you selected in the main Hostview window. The default OS version and the default platform type are shown. If Hostview successfully executes the command, it displays the message Command completed in the informational panel of the window.

---

**Note** – Hostview can run only one `create` or `remove` command at a time. If you attempt to execute a second `create` or `remove` command before the first has completed, your second attempt fails.

---

## ▼ To Create Domains From the Command Line

---

**Note** – Before proceeding, see “Domain Configuration Requirements” on page 56. If the system configuration must be changed to meet any of these requirements, call your service provider.

---

#### 1. Type `domain_create(1M)` in an SSP window.

```
ssp% domain_create -d domain_name -b system_board_list \  
-o os_version -p platform_name
```

where:

*domain\_name* is the name you want to give to the new domain. It should be unique among all Sun Enterprise 10000 systems controlled by the SSP.

*system\_board\_list* specifies the boards that are to be part of this domain. The specified system boards must be present and not in use. Each domain must have a network interface, SCSI interface, and sufficient memory to support an autonomous system. List the board numbers, separated by commas or spaces, for all boards you want to include.

*os\_version* is the version of the operating system to be loaded into the domain.

*platform\_name* is the name of the platform managed by the SSP.

2. **Optionally, create a new SSP window for the domain, as described in “SSP Window” on page 16.**

Use the `domain_switch(1M)` command to set the `SUNW_HOSTNAME` environment variable to the new domain name.

## ▼ To Recreate the `eeeprom.image` File

---

**Note** – You cannot create a domain if you do not have the corresponding `eeeprom.image` file. The `eeeprom.image` files for the domains you ordered are shipped to you by the factory. If you accidentally delete an `eeeprom.image` file or your boot disk is corrupted, and you do not have a backup copy of your `eeeprom.image` file, you can contact your Sun service representative to recreate it. Alternatively, you may be able to recreate the `eeeprom.image` file if you have the original serial number and the EEPROM key. In this case, follow the steps in this procedure.

---

1. **Log in to the SSP as user `ssp`.**
2. **Recreate the `eeeprom.image` file.**

---

**Note** – All `key` and `host_id` numbers are case sensitive and must be entered exactly as they are received.

---

- a. **For the first domain, type:**

```
ssp% domain_switch domain_name
ssp% sys_id -k key -s serial_number
```

where:

*domain\_name* is the hostname of the domain.

*key* is the `eeeprom` key number.

*serial\_number* is the number provided with the *key* in the form of `0XA65xxx`.

**b. For all subsequent domains, type:**

```
ssp% domain_switch domain_name
ssp% sys_id -k key -h hostid
```

where:

*domain\_name* is the hostname of the domain.

*key* is the eeprom key number.

*hostid* is the number provided with the *key* in the form of 0X80A66xxx.

**3. Check the result by typing:**

```
ssp% sys_id -d
```

In the following example, 49933C54C64C858CD4CF is the key and 0x80a66e05 is the hostid:

```
ssp% domain_switch domain_name
ssp% sys_id -k 49933C54C64C858CD4CF -h 0x80a66e05
ssp% sys_id -d

IDPROM in eeprom.image.domain_name

          Format = 0x01
          Machine Type = 0x80
          Ethernet Address = 0:0:be:a6:6e:5
          Manufacturing Date = Wed Dec 31 16:00:00 1998
          Serial number (machine ID) = 0xa66e05
          Checksum = 0x3f
```

**4. Back up the SSP eeprom.image files to tape or disk where they can be accessed in case of SSP boot disk failure.**

## ▼ To Remove Domains From Within Hostview

- 1. In the main Hostview window, click any board in the domain to be removed.**
- 2. Choose Domain then Remove from the Configuration menu.**

The Remove Domain window is displayed (FIGURE 3-14).

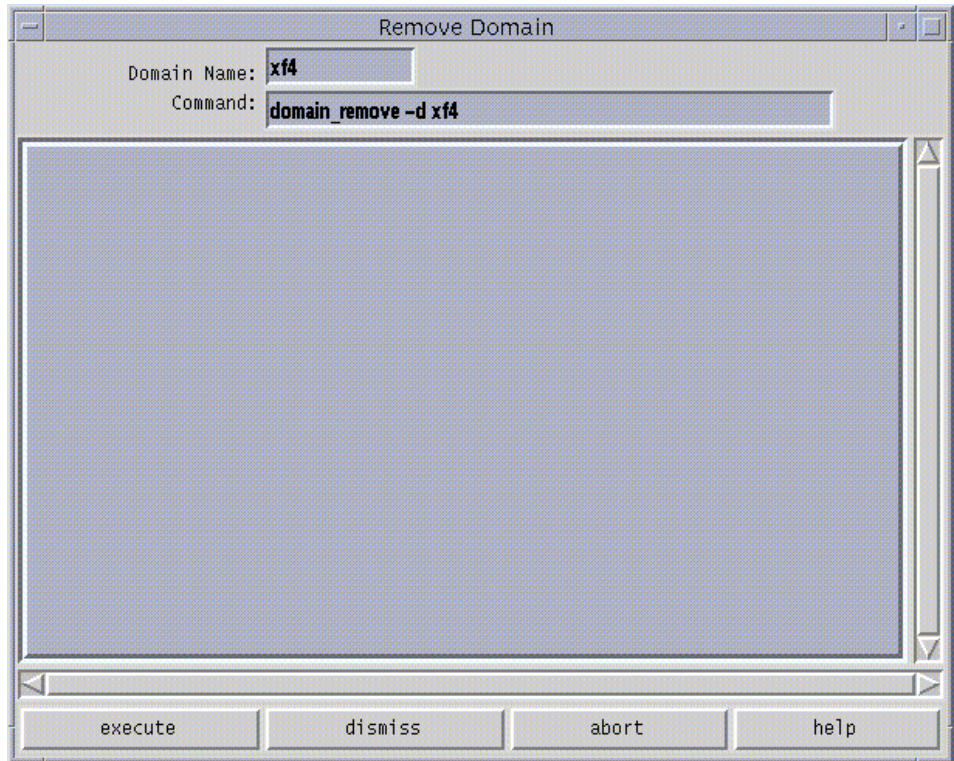

FIGURE 3-14 Remove Domain Window

3. If the default `domain_remove(1M)` command is satisfactory, click the **execute** button; otherwise, edit the command first.

For help on the `domain_remove(1M)` command, click the help button. A help window is displayed (see “Help Window” on page 28).

4. Specify whether or not domain subdirectories should be removed when you are prompted to do so.

The pathnames of the subdirectories are displayed. These subdirectories contain domain-specific information such as message files, configuration files, and `hpost(1M)` dump files. You can keep these directories if you still need the information. It is easier to recreate a domain later if you keep these directories.

---

**Note** – If the system cannot remove your domain, see `domain_remove(1M)` for a list of potential errors.

---

## ▼ To Remove Domains From the Command Line

1. **Type `domain_remove(1M)`.**

You must execute this command in an SSP window whose environment variable `SUNW_HOSTNAME` is set to the name of the domain you want to remove. The domain must not be running the operating system.

```
ssp% domain_remove -d domain_name
```

2. **Specify whether or not domain subdirectories should be removed when you are prompted to do so.**

The pathnames of the subdirectories are displayed. These subdirectories contain domain-specific information such as message files, configuration files, and `hpost(1M)` dump files. You can keep these directories if you still need the information. The domain can be recreated whether or not you keep this information.

3. **Type `domain_status(1M)` to verify that the domain was removed.**

---

**Note** – If the system cannot remove your domain, an error message is displayed. See `domain_remove(1M)` for a list of potential errors.

---

## ▼ To Rename Domains From Within Hostview

---

**Note** – After you rename a domain, you must also update `/etc/hosts` to reflect the domain's new name.

---

1. **Shut down the domain.**

2. **In the main Hostview window, select a board from the domain that you want to rename by clicking on it with the left mouse button.**

3. **Choose Domain then Rename from the Configuration menu.**

The Rename Domain window is displayed (FIGURE 3-15).

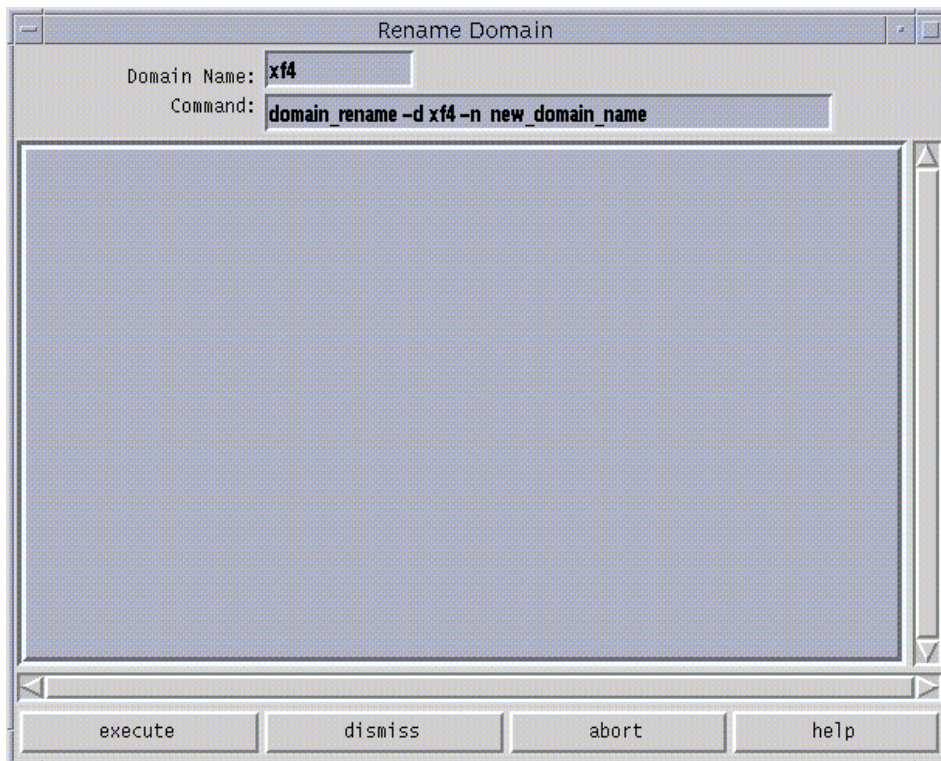

FIGURE 3-15 Rename Domain Window

4. If the default `domain_rename(1M)` command is satisfactory, click the execute button. Otherwise, edit the command first.

For help on the `domain_rename(1M)` command, click the help button. A help window is displayed (see “Help Window” on page 28).

## ▼ To Rename Domains From the Command Line

---

**Note** – After you rename a domain, you must also update the standard host configuration files to reflect the domain’s new name. See the *Solaris 2.x User Collection and Solaris 2.x System Administrator AnswerBook*.

---

- **Use the `domain_rename` (1M) command.**

```
% domain_rename -d old_domain_name -n new_domain_name
```

For more information, see the `domain_rename`(1M), `domain_remove`(1M), and `domain_create`(1M) commands.

## ▼ To Bring up a Domain From Within Hostview

1. **Select the domain you want to bring up.**

In the domain you want to bringup, click on any system board.

2. **Choose Bringup from the Control menu.**

A window is displayed that shows the name of the selected domain.

3. **Click `Execute` to perform the bringup.**

4. **After the bringup operation has completed, choose `netcontool` from the Terminal menu.**

5. **Click the `Connect` button to open a `netcon`(1M) window.**

6. **If the OBP prompt appears (that is, the `OK` prompt), boot the domain:**

```
OK boot boot_device
```

The domain should boot and then display the login prompt. Note that you can use the OBP command `devalias` to determine the alias for the disk you want to use as `boot_device`.

## ▼ To Bring up a Domain From the Command Line

Ensure that the `SUNW_HOSTNAME` is set to the proper domain before proceeding. If it is not, you will need to switch it.



### 1. Type:

```
ssp% domain_switch domain_name
```

where *domain\_name* is the name of the domain you want to bring up.

Before you can bring up a domain from the command line in an SSP window, the system boards for the domain must be powered on.

### 2. Power on the power supplies for all of the boards in the domain:

```
ssp% power -on -sb board_list
```

where *board\_list* is a list of system board numbers separated by spaces.

### 3. Bring up the domain by typing the following commands:

```
ssp%bringup -A [off/on] [disk]
ssp% netcon
ok boot
```

The `-A` option is the autoboot option. If the autoboot option is on, the domain will automatically boot. If it is off, you need to explicitly boot the domain.

## ▼ To Obtain Domain Status From Within Hostview

### ● Choose Domain then Status from the Configuration menu.

The Domain Status window is displayed (FIGURE 3-16).

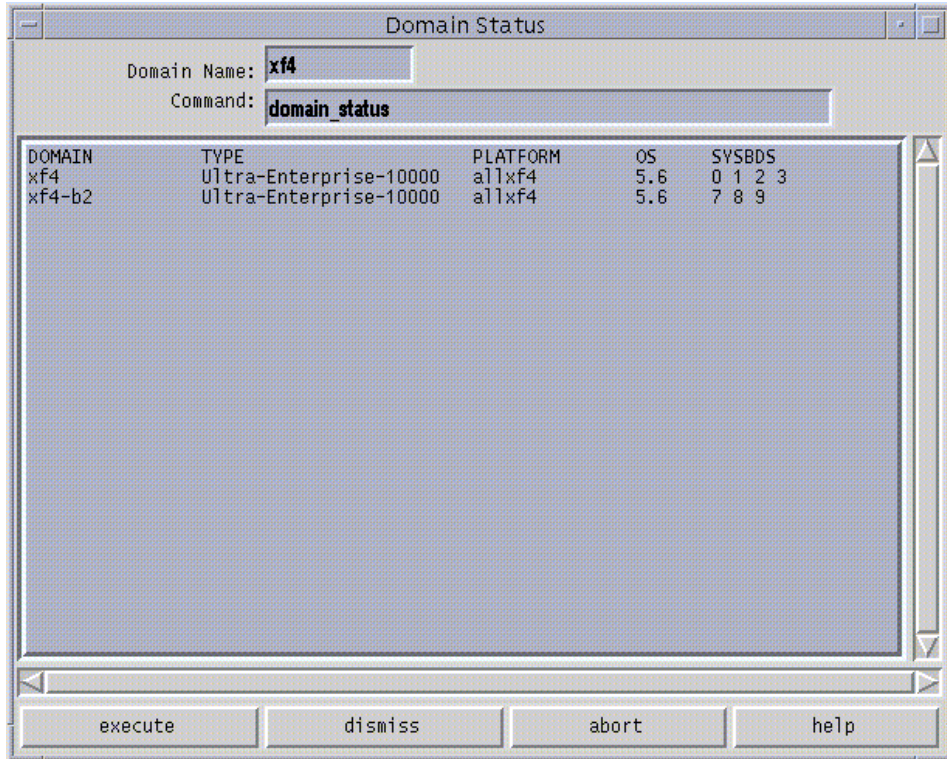

**FIGURE 3-16** Domain Status Window

The status listing is displayed in the main panel of the window. The following table explains the columns in the Domain Status window.

**TABLE 3-1** Domain Status Columns

Name	Description
DOMAIN	Lists the name of the domain.
TYPE	Lists the platform type. It can only have the value Ultra-Enterprise-10000 in the current release.
PLATFORM	Lists the name of the platform. The platform name is set at the time the SSP packages are installed.
OS	Lists the operating system version for the domain.
SYSBDS	Lists the system boards that make up the domain.

---

# Blacklisting Components

The blacklisting feature enables you to configure the following components out of the system:

- System boards
- Processors
- Address buses
- Data buses
- Data routers
- I/O controllers
- I/O adapter card
- System board memory
- Memory DIMM groups
- Sun Enterprise 10000 half-centerplane
- Port controller ASICs
- Data buffer ASICs
- Coherent interface controller ASICs
- 72-bit half of 144-bit, local, data router within system boards

Generally, you may want to blacklist a component if you believe that component is having intermittent problems, or if it is failing sometime after the system is booted.

If a component has a problem that shows up in the power-on self-test (POST) run by `hpost(1M)` (which is run by the `bringup(1M)` command), that component is automatically configured out of the system by `hpost(1M)`. However, that component is not blacklisted. `hpost(1M)` is run on the components in the system before a domain is booted, and on the components on a given board before that board is attached with Dynamic Reconfiguration (DR). See the *Dynamic Reconfiguration User's Guide*.

To blacklist a component, you can edit the `blacklist(4)` file with a text editor, or use Hostview. Hostview does not allow you to blacklist all possible components, so there may be times when you need to edit `blacklist(4)` directly. When a domain runs POST, `hpost(1M)` reads the `blacklist(4)` file and automatically excludes the components specified in that file. Thus, changes that you make to the `blacklist(4)` file do not take effect until the domain is rebooted.

The file is `$$SSPVAR/etc/platform_name/blacklist`, where *platform\_name* is the name of the platform. See the `blacklist(4)` man page for information about the contents of the `blacklist(4)` file.

## ▼ To Blacklist Components From Within Hostview

### 1. Choose Blacklist File from the Edit menu.

The Blacklist Edit window is displayed (FIGURE 3-17).

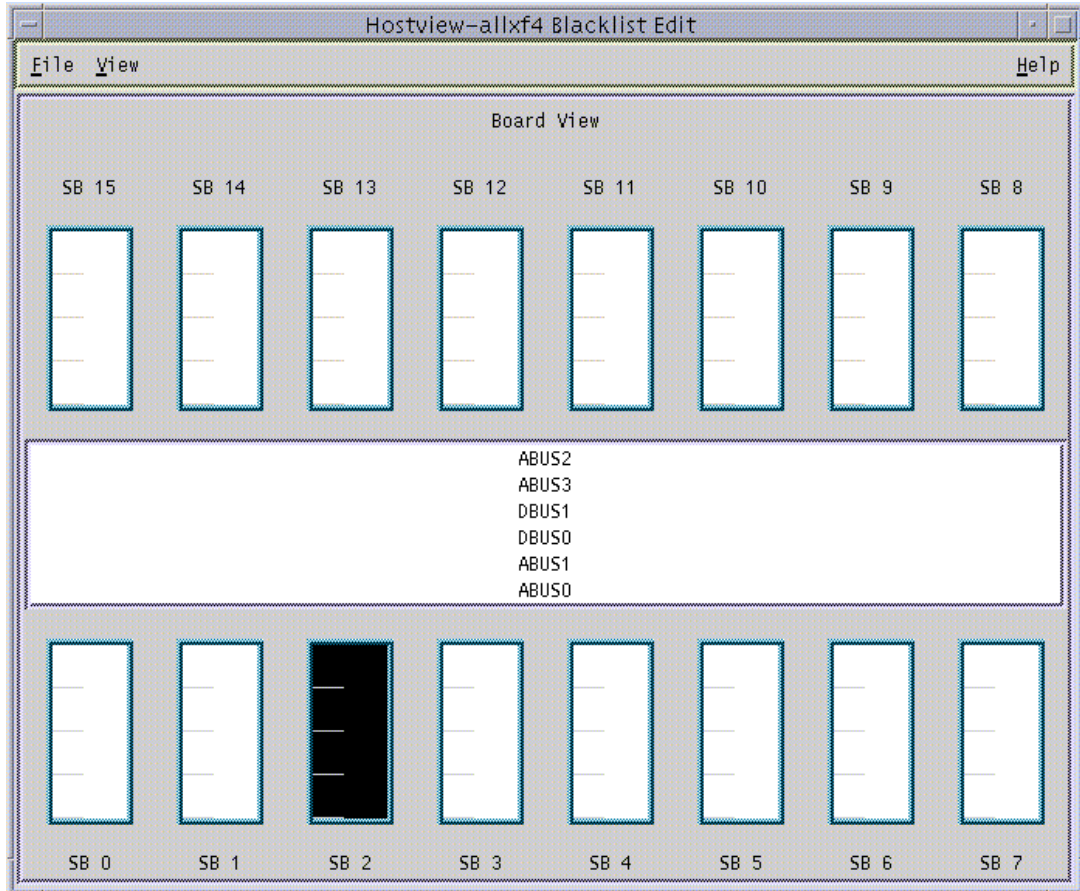

FIGURE 3-17 Blacklist Edit Window—Board View

### 2. Select the boards and/or buses that you want to place onto the blacklist.

To select a single component and deselect all other components of that type (for example, to select a single board and deselect all other boards), click on that component with the left mouse button. To toggle the selection status of a single component without affecting the selection status of any other component, click on that component with the middle mouse button. The selected components are displayed in black.

3. **To save the changes, choose Save from the File menu.**
4. **To exit the Blacklist Edit window, choose Close from the File menu.**

If you have unsaved changes and you close the Blacklist Edit window by choosing Close from the File menu, you are prompted to save the changes.

## ▼ To Blacklist Processors From Within Hostview

1. **Choose Blacklist File from the Edit menu.**  
The Blacklist Edit window is displayed.
2. **From the Blacklist Edit window, choose Processors from the View menu.**  
The Blacklist Edit window displays the Processor View window (FIGURE 3-18).

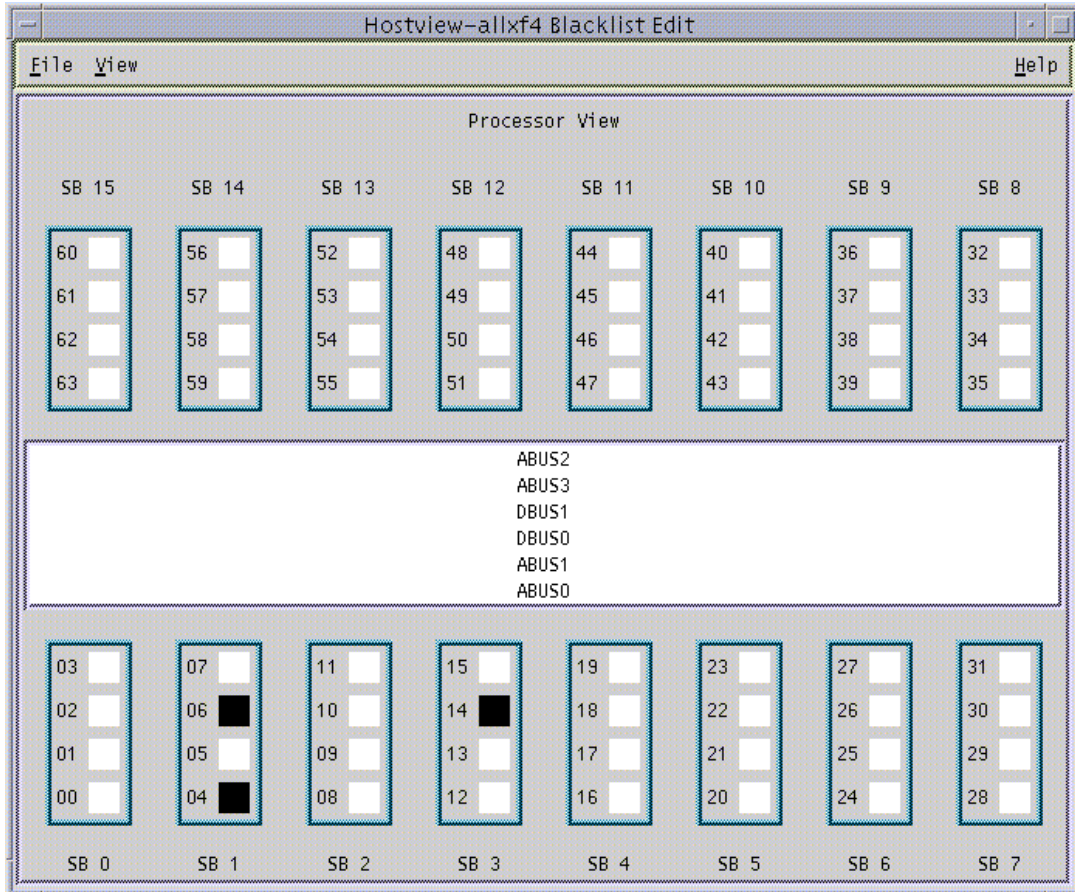

**FIGURE 3-18** Blacklist Edit Window—Processor View

**3. Select the processors that you want to add to the blacklist.**

To select a single processor on a board and deselect all other processors on that board, click on that processor with the left mouse button. To toggle the selection status of a processor on a board without affecting the selection status of any other processors on that board, click on that processor with the middle mouse button. The selected processors are displayed in black.

**4. To save the changes, choose Save from the File menu.**

**5. To exit the Blacklist Edit window, choose Close from the File menu.**

If you have unsaved changes and you close the Blacklist Edit window by choosing Close from the File menu, you are prompted to save the changes.

## ▼ To Clear the Blacklist File From Within Hostview

1. In Hostview, choose **Blacklist File** from the **Edit** menu.
2. From the **Blacklist Edit** window, choose **New** from the **File** menu.
3. From the **Blacklist Edit** window, choose **Close** from the **File** menu.

---

## Using a Spare SSP

The SSP unit is a Sun workstation with a defined hardware configuration. Any identical Sun workstation can also serve as an SSP. You can optionally designate such a Sun workstation as a spare SSP unit, to serve as a backup if your main SSP unit fails. You can also order your Sun Enterprise 10000 system server with a spare SSP unit.

Maintain a spare SSP in a ready state. This allows you to quickly switch to the spare SSP if the main SSP fails. Do not run any software on the spare SSP machine other than the SSP software. (If you are using clusters, you can run the Sun cluster console on the main SSP.)

To maintain a spare SSP, you must adhere to the following requirements:

- The spare SSP must be properly configured to function in the same way as the main SSP within the network.
- You must not install or use any non-SSP software on it (except for possibly the Sun cluster console).
- Any changes that you make to the main SSP must be made to the spare SSP as well. After any system configuration operation, you must *immediately* run the `ssp_backup` script on the main SSP. The `ssp_backup` script backs up the SSP configuration environment only. It does not back up the entire file system. If the main SSP crashes, you will have a backup file that you can restore to the spare SSP by running the `ssp_restore` script. The `ssp_restore` script restores the SSP configuration environment only. It does not restore the entire file system. For more information about the `ssp_backup` and `ssp_restore` scripts, see “To Switch Between the Main and Spare SSP” on page 72.

---

**Note** – You can run any combination of SSP versions 3.1 and 3.1.1 on the main and spare SSP machines. However, you cannot run SSP 3.0 on either the main or the spare if you are also using SSP 3.1.1.

---

## ▼ To Switch Between the Main and Spare SSP

### 1. Change the main SSP to a spare SSP:

a. Log in to the main SSP as `root`.

b. Type:

```
ssp# /opt/SUNWssp/bin/ssp_backup backup_dir
```

This command backs up the SSP configuration information to the file `backup_dir/ssp_backup.cpio`.

c. Type:

```
ssp# /opt/SUNWssp/bin/ssp_config
Beginning setup of this workstation to act as a MAIN or SPARE SSP.
Are you currently configuring the MAIN SSP? (y/n)n
SPARE SSP configuration completed.
ssp#
```

d. If this SSP is running the SSP 3.1 software, halt the SSP or kill the `rarpd` process.

### 2. Change the spare SSP to a main SSP:

a. Log in to the spare SSP as `root`.

b. Transfer the `ssp_backup.cpio` file that you created in Step 1 to a backup directory on the spare SSP.

c. Type:

```
ssp# /opt/SUNWssp/bin/ssp_restore backup_dir/ssp_backup.cpio
```

---

**Note** – The SSP environment should not be changed between the time you run `ssp_backup` and `ssp_restore`. For example, after you run `ssp_backup`, you should not shut down a domain, bring up a domain, or power boards on or off until you run `ssp_restore`.

---



**d. Type:**

```
ssp# /opt/SUNWssp/bin/ssp_config spare
Configuring the spare SSP to control the Host

Beginning set up of the SPARE SSP workstation to control the host.

Platform name = allxf4
Control board 0 = xf4-cb0 => 129.153.151.123
Control board 1 = xf4-cb1 => 129.153.152.123
Primary Control Board = 0

Is this correct? (y/n)y

This SPARE SSP is NOW configured to control the host.

This machine is the MAIN SSP now.
```

**e. If this SSP is running the SSP 3.1 software, reboot the SSP.**

**3. For each domain on the host, perform the following steps.**

If a domain is down when you perform this procedure, the console window may be unusable after the domain is brought up by the spare SSP. If the console window is unusable perform these steps using an `rlogin` or `telnet` session.

**a. From the new main SSP, or from another workstation on the network, remotely login to the domain as root.**

**b. Edit the `/etc/ssphostname` file to replace the hostname of the main SSP with the hostname of the spare SSP.**

For example, if your main SSP is called `xf4-ssp` and your spare SSP is called `xf4-ssp2`, then you would change the contents of `/etc/ssphostname` to `xf4-ssp2`.

**c. Switch console communication from the main SSP to the spare SSP by typing:**

```
# ps -ef | grep cvcd
# kill -9 cvcd_pid
# cvcd_path/cvcd
```

where `cvcd_path` is `/sbin` under the Solaris 2.5 and 2.6 operating environments, and `cvcd_path` is `/platform/SUNW,Ultra-Enterprise-10000/lib/cvcd` under the Solaris 7 operating environment.

**d. If needed, update the `/etc/syslog.conf` file to replace the hostname of the main SSP with the hostname of the spare SSP.**

---

# Dual Control Board Handling

A platform can be configured with dual control boards for redundancy purposes. Although you can manually switch between the control boards, only one control board at a time is used by the system.

One of the control boards is identified as the primary control board. The SSP attempts to communicate only with the primary control board. If the system administrator decides that it is necessary to switch the primary control board because of a connection failure or for other reasons, the system administrator must modify the control board configuration file and reboot the SSP to activate the new primary control board. Note that this operation cannot be performed without rebooting all running domains because the control board provides the system clocks for all boards.

## Control Board Executive

The control board executive (CBE) runs on the control board and facilitates communication between the SSP and the platform.

When power is applied, both control boards boot from the SSP that is serving as the boot server. After the CBE is booted, it waits indefinitely for the control board server running on the SSP to establish a connection.

## Primary Control Board

When the control board server running on the SSP connects to the CBE running on a control board, the CBE asserts the control board as the primary control board. The primary control board is responsible for providing the system clock and JTAG clock and for controlling fan trays and bulk power supplies.

## Control Board Server

After the SSP is booted, the control board server (CBS), is started automatically. The CBS is responsible for all communication between the SSP and the primary control board.

The CBS attempts to connect only to the primary control board identified in the control board configuration file. The format of the file is as follows:

```
platform_name:platform_type:cb0_hostname:status0:cb1_hostname:status1
```

where:

*platform\_name* is the name assigned by the system administrator.

*platform\_type* is defaulted to Ultra-Enterprise-10000.

*cb0\_hostname* is the host name for control board 0, if available.

*status0* indicates that control board 0 is the primary control board (P indicates primary, and anything else indicates nonprimary).

*cb1\_hostname* is the host name for control board 1, if available.

*status1* indicates that control board 1 is the primary control board.

For example:

```
xf2:Ultra-Enterprise-10000:xf2-cb0:P:xf2-cb1:
```

This example indicates that there are two control boards in the xf2 platform. They are xf2-cb0 and xf2-cb1. xf2-cb0 is specified as the primary. See the [cb\\_config\(4\)](#) man page for more information.

The communication port that is used for communication between the control board server and the control board executive is specified in `/tftpboot/xxxxxxxx.cb_port` where `xxxxxxxx` is the control board IP address represented in hexadecimal format.

## Control Board Executive Image and Port Specification Files

The SSP is the boot server for the control board. Two files are downloaded by the control board boot PROM during boot time: the image of CBE and the port number specification file. These files are located in `/tftpboot` on the SSP and the naming conventions are:

```
/tftpboot/xxxxxxxx for the cbe image  
/tftpboot/xxxxxxxx.cb_port for the port number
```

where `xxxxxxxx` is the control board IP address in hex format.

For example, the files for control board `xf2-cb0` are:

```
/tftpboot/81973213  
/tftpboot/81973213.cb_port
```

If you are using NIS, the IP address of `xf2-cb0` can be determined as follows:

```
% ypcat hosts | grep xf2-cb0
```

The returning address is 129.153.49.147. This can be converted to 81993193.

## ▼ To Switch the Primary Control Board

---

**Caution** – Do *not* edit the `/var/opt/SUNWssp/.ssp_private/cb_config` file manually. Instead, use the `ssp_config(1M)` command as described below. Otherwise, your domains may fail and arbitration stops (`arbstops`) may occur.

---

1. If any domains are running, shut down those domains using the standard `shutdown(1B)` command.
2. Log in to the main SSP as `ssp`.
3. Power off all of the system boards.

```
ssp% power -off -all
```

4. Power on all of the system boards.

```
ssp% power -on -all
```

5. Log in to the main SSP as `superuser`.
6. Obtain the host names and IP addresses for the two control boards.
7. Verify that control board IP addresses are set up properly in the `/etc/inet/hosts` file or in your local name service system.

**8. As superuser, type `ssp_config(1M)` as shown in the following sample session.**

In this sample session, the primary control board is switched from `snax-cb0` to `snax-cb1`.

```
ssp# /opt/SUNWssp/bin/ssp_config cb

Configuring control boards.

Platform name      = snax
Control Board 0   = snax-cb0 => 129.153.49.181
Control Board 1   = snax-cb1 => 129.153.49.182
Primary Control Board = 0

Is this correct? (y/n): n
Do you have a control board 0? (y/n): y
Please enter the host name of the control board 0 [snax-cb0]:
Do you have a control board 1? (y/n): y
Please enter the host name of the control board 1 [snax-cb0]:

Please identify the primary control board.
Is Control Board 0 [snax-cb0] the primary? (y/n) n
Is Control Board 1 [snax-cb1] the primary? (y/n) y

Platform name      = snax
Control Board 0   = snax-cb0 => 129.153.49.181
Control Board 1   = snax-cb1 => 129.153.49.182
Primary Control Board = 1

Is this correct? (y/n): y
```

---

**Note** – The platform name identifies the *entire host machine*, not a particular domain.

---

**9. Restart the main SSP processes.**

**a. As superuser, type:**

```
ssp# /etc/init.d/ssp stop
ssp# /etc/init.d/ssp start
```

**b. Log in to the SSP as user `ssp`.**

**c. Type:**

```
ssp% tail -f $SSPLOGGER/messages
```

**d. Wait until you see the following message:**

```
Startup of SSP programs complete
```

**10. Start Hostview:**

```
ssp% hostview &
```

Verify that the “J” and “C” symbols are shown on the symbol for Control Board 1 in the main Hostview screen. This indicates that the JTAG connection and clock distribution signals are coming from Control Board 1.

If Hostview fails to respond, verify that you can communicate with Control Board 1. If you are unable to use `ping(1M)` to communicate with Control Board 1, visually examine the LEDs to verify that the control board is operating correctly. For example, verify that the link integrity LED is on. This indicates that the Ethernet connection is good. If the LEDs are cycling through a pattern, the control board is booted. If the LEDs are all off or all on continuously (without cycling through a pattern), the control board is not booted. Try running `snoop(1M)` on the SSP to verify that the control boards are communicating correctly.

**11. If you have a spare SSP, repeat Step 6 through Step 8 above, on the spare SSP.**

**12. Issue the `bringup(1M)` command for all domains.**

## SSP Internals

---

SSP operations are generally performed by a set of daemons and commands. This chapter provides an overview of how the SSP works and describes the SSP daemons, processes, commands, and system files. For more information about daemons, commands, and system files, refer to the *Sun Enterprise 10000 SSP Reference*.



---

**Caution** – Changes made to files in `/opt/SUNWssp` can cause serious damage to the system. Only very experienced system administrators should risk changing the files described in this chapter.

---

---

## Startup Flow

The sequence of events that take place when the SSP boots and starts the Sun Enterprise 10000 system are given in the following list.

1. The user powers on the SSP.

The SSP boots automatically and powers on the monitor, CPU and disk(s), and the CD-ROM.

The `/etc/rc2.d/S99ssp` startup script is called when the system enters run level 2.

This script starts `ssp_startup`.

The `ssp_startup` script starts the SSP daemons.

`machine_server`, `fad`, `cbs`, `straps`, `snmpd`, and `edd`.

It also calls `cb_reset` to start control board initialization.

The `edd` daemon initiates event monitoring on the Sun Enterprise 10000 system control board, waits for an event to be generated by the event detection task running on the control board, and then responds to the event by running a response action script on the SSP.

2. The user applies power to platform or domain.

Set `SUNW_HOSTNAME` to the domain name by running the command `domain_switch domain_name`.

3. The user executes `domain_create`.

You need to do this only once for each domain.

4. The system executes `bringup`.

`bringup` verifies that the operating system is running, runs `POST`, then runs `obp_helper`, which runs `OBP`, and starts `netcon_server(1M)`.

The system optionally loads the operating system and the boot process is complete.

The SSP monitors the Sun Enterprise 10000 system using the event detector daemon, `edd(1M)`. Each time the SSP boots, it runs `/etc/rc2.d/S99ssp` which in turn loads `edd(1M)` through the startup script, `$$SSPVAR/ssp_startup.sh`. The startup script checks the environment for availability of certain files and the availability of the Sun Enterprise 10000 system, sets environment variables, and then starts `edd(1M)`. `edd(1M)` obtains many of its initial control parameters from the following configuration files:

- `$$SSPVAR/etc/platform_name/edd.erc` provides configuration information for the Sun Enterprise 10000 system platform.
- `$$SSPVAR/etc/platform_name/domain_name/edd.erc` provides configuration information for a particular domain. The event response configuration files (`edd.erc`) specify how the event detector will respond to events.
- `$$SSPVAR/etc/platform_name/edd.emc` lists the events that `edd(1M)` will monitor.

If a domain crashes, `edd(1M)` invokes the `bringup(1M)` script. The `bringup(1M)` script runs the `POST` program, which tests Sun Enterprise 10000 system components. It then uses the `obp_helper(1M)` daemon to download and begin execution of `OBP` in the domain specified by the `SUNW_HOSTNAME` environment variable. This only happens if a domain fails (for example, after a kernel panic) in which case it is rebooted automatically. After a halt or shutdown, you must manually run `bringup(1M)`, which then causes `OBP` to be downloaded and run.

`obp_helper(1M)` is responsible for loading `download_helper` in all the configured processors' bootbus SRAM. All the processors are started, with one processor designated the boot processor. With the assistance of



`download_helper`, `obp_helper(1M)` loads OBP into the memory of the Sun Enterprise 10000 system and starts OBP on the boot processor. See “OBP Daemon” on page 88 for more information about `obp_helper(1M)` and OBP.

The primary task of OBP is to boot and configure the operating system from either a mass storage device or from a network. OBP also provides extensive features for testing hardware and software interactively. As part of the boot procedure, OBP probes all the SBus slots on all the system boards and builds a device tree. This device tree is passed on to the operating system.

---

## Sun Enterprise 10000 Client/Server Architecture

The Sun Enterprise 10000 system control board interface is accessed over an Ethernet connection using the TCP/IP protocol. The control board executive, CBE, runs on the control board and the control board server, CBS (using the `cbs(1M)` command), runs on the SSP and makes service requests. The SSP control board server provides services to SSP clients.

FIGURE 4-1 illustrates the Sun Enterprise 10000 system client/server architecture:

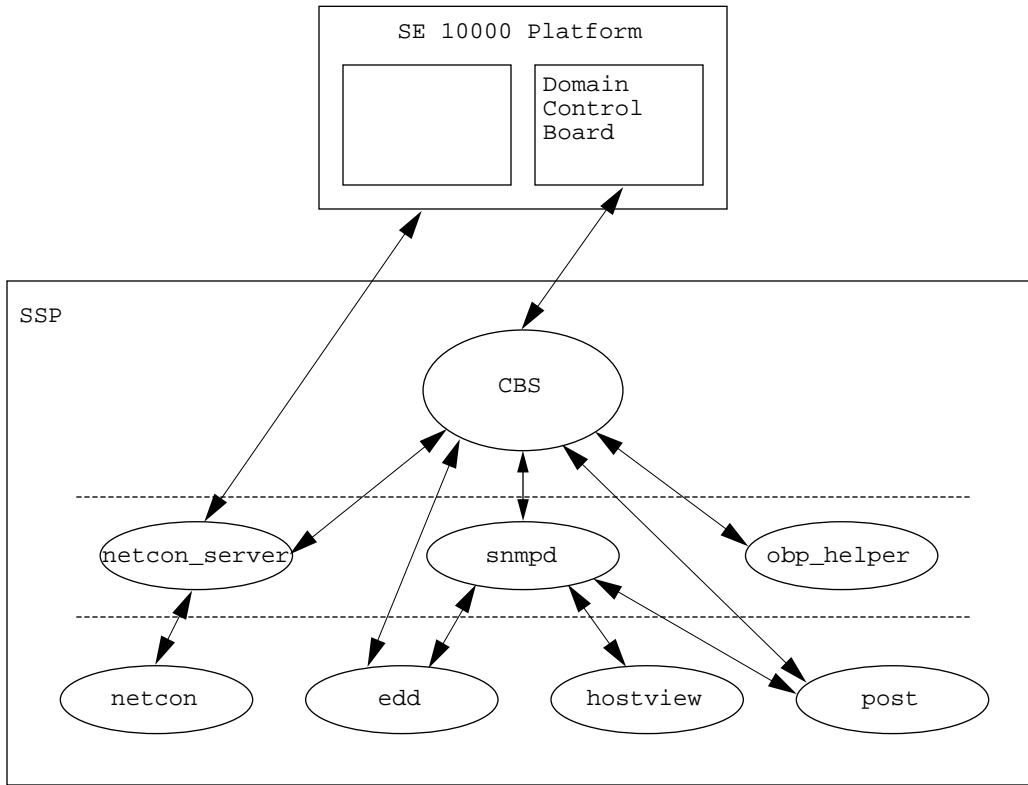

**FIGURE 4-1** Sun Enterprise 10000 Client/Server Architecture

---

**Note** – There is one instance of `edd(1M)` for the platform supported by the SSP. There is one instance of `obp_helper(1M)` and `netcon_server(1M)` for each domain on the platform.

---

## POST

POST probes and tests the components of uninitialized Sun Enterprise 10000 system hardware, configures what it deems worthwhile into a coherent initialized system, and hands it off to OpenBoot PROM (OBP). POST passes to OBP a list of only those components that have been successfully tested; those in the `blacklist(4)` file are excluded.

`hpost(1M)` is the SSP-resident executable program that controls and sequences the operations of POST. `hpost(1M)` reads directives in the optional file `.postrc` (see `postrc(4)`) before it begins operation with the host.



---

**Caution** – Running `hpost(1M)` outside of the `bringup(1M)` command can cause the system to fail. `hpost(1M)`, when run by itself, does not check the state of the platform, and causes fatal resets.

---

POST looks at `blacklist(4)`, which is on the SSP, before preparing the system for booting. `blacklist(4)` specifies the Sun Enterprise 10000 system components that POST must not configure.

POST stores the results of its tests in an internal data structure called a *board descriptor array*. The board descriptor array contains status information for most of the major components of the Sun Enterprise 10000 system, including information about the UltraSPARC™ modules.

POST attempts to connect and disconnect each system board, one at a time, to the system centerplane. POST then connects all the system boards that passed the tests to the system centerplane.

---

## Daemons

The SSP daemons play a central role on the SSP. Each daemon is fully described in its corresponding man page. The following table briefly describes the daemons:

TABLE 4-1 Daemons

Name	Description
<code>cbs</code>	The control board server provides central access to the Sun Enterprise 10000 system control board for client programs running on the SSP.
<code>edd</code>	The event detector daemon initiates event monitoring on the control boards. When a monitoring task detects an event, <code>edd(1M)</code> runs a response action script.
<code>fad</code>	The file access daemon provides distributed file access services to SSP clients that need to monitor, read, and write to the SSP configuration files.
<code>machine_server</code>	Provides machine services for <code>netcon(1M)</code> and routes host messages to proper messages file. See <code>machine_server(1M)</code> .

**TABLE 4-1** Daemons (*Continued*)

Name	Description
netcon_server	The connection point for all netcon(1M) clients. netcon_server(1M) communicates with OBP using a control board protocol. netcon_server(1M) communicates with the OS using the TCP protocol.
obp_helper	Runs OpenBoot. obp_helper(1M) terminates when OBP is terminated. During execution, obp_helper(1M) provides services to OBP, such as NVRAM simulation, IDPROM simulation, and time of day.
snmpd	The SNMP proxy agent listens to a UDP port for incoming requests and services the group of objects specified in Ultra-Enterprise-10000.mib.
straps	The SNMP trap sink server listens to the SNMP trap port for incoming trap messages and forwards received messages to all connected clients.
xntpd / ntpd	The network time protocol (NTP) daemon provides time synchronization services. (xntpd is the daemon for the Solaris 2.5.1 operating environment, and ntpd is the daemon for the Solaris 2.6 and Solaris 7 operating environments.) Clients can connect to this service and have their clocks automatically adjusted. This service is used to synchronize SSP and domain times. See xntpd(1M) and the Network Time Protocol User's Guide.

## Event Detector Daemon

The event detector daemon, `edd(1M)`, is a key component in providing the reliability, availability, and serviceability (RAS) features of Sun Enterprise 10000 system. `edd(1M)` initiates event monitoring on the Sun Enterprise 10000 system control board, waits for an event to be generated by the event detection monitoring task running on the control board, and then responds to the event by executing a response action script on the SSP. The conditions that generate events and the response taken to events are fully configurable.

The `edd(1M)` provides the mechanism for event management, but does not handle the event detection monitoring directly. Event detection is handled by an event monitoring task that runs on the control board. `edd(1M)` configures the event monitoring task by downloading a vector that specifies the event types to be monitored. Event handling is provided by response action scripts, which are invoked on the SSP by the `edd(1M)` when an event is received.

The RAS features are provided by several collaborative programs. The control board within the platform runs a control board executive (CBE) program that communicates by Ethernet with a control board server (cbs(1M)) program on the SSP. These two components provide the data link between the platform and the SSP.

The SSP provides a set of interfaces for accessing the control board through the control board server and the simple network management protocol (SNMP) agent. edd(1M) uses the control board server interface to configure the event detection monitoring task on the control board executive (FIGURE 4-2).

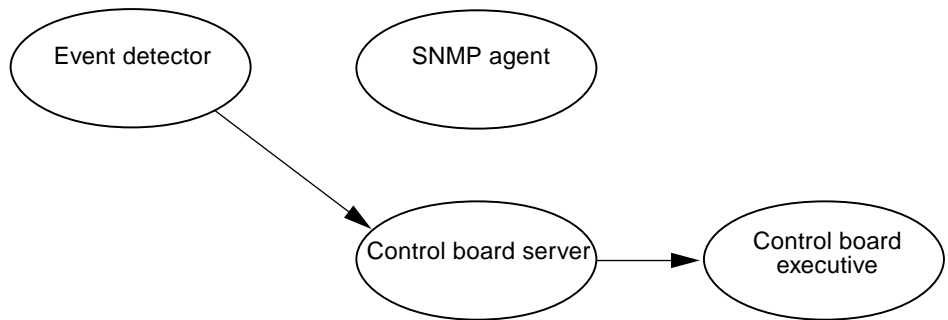

**FIGURE 4-2** Uploading Event Detection Scripts

After it is configured, the event detection monitoring task polls various conditions within the platform, including environmental conditions, signature blocks, power supply voltages, performance data, and so forth. If an event detection script detects a change of state that warrants an event, an event message containing the pertinent information is generated and delivered to the control board server (cbs(1M)) running on the SSP. Upon receipt of the event message, the control board server delivers the event to the SNMP Agent, which in turn generates an SNMP trap (FIGURE 4-3).

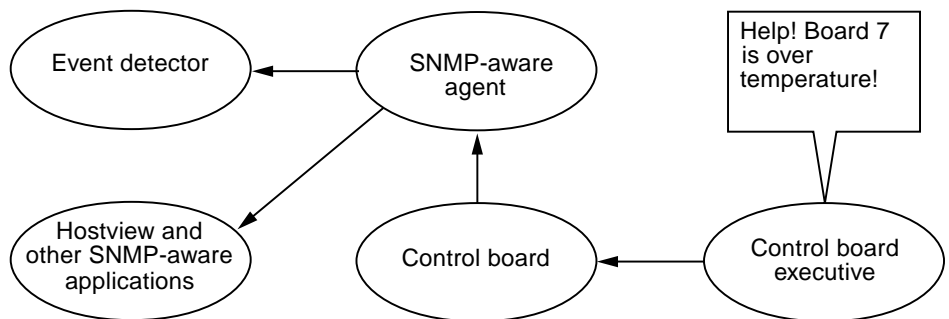

**FIGURE 4-3** Event Recognition and Delivery

Upon receipt of an SNMP trap, `edd(1M)` determines whether to initiate a response action. If a response action is required, the `edd(1M)` runs the appropriate response action script as a subprocess (FIGURE 4-4).

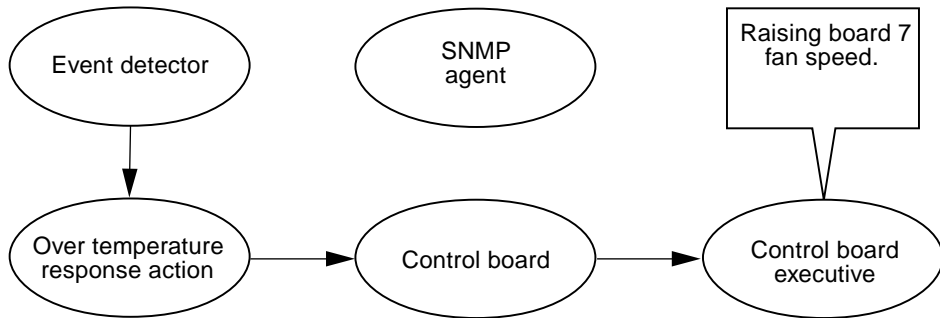
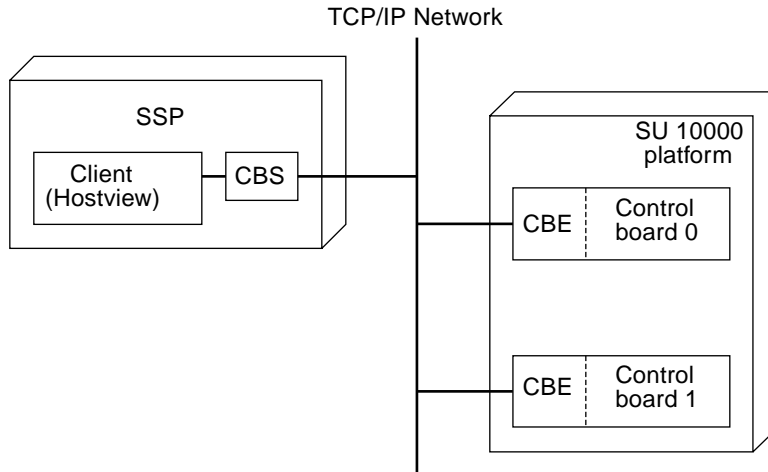

**FIGURE 4-4** Response Action

Event messages of the same type or related types can be generated while the response action script is running. Some of these secondary event messages may be meaningless or unnecessary if a responsive action script is already running for a similar event. For instance, `edd(1M)` is running a response action script for a high-temperature event. While the response action script is running, additional high temperature events can be generated by the event monitoring scripts. `edd(1M)` does not respond to those high temperature events (generated in response to the same high temperature condition) until the first response script has finish. It is the responsibility of applications (such as `edd(1M)`) to filter the events they will respond to as necessary. The cycle of event processing is completed at this point.

## Control Board Server

The control board server (CBS) is a server that runs on the SSP. Whenever a client program running on the SSP needs to access the Sun Enterprise 10000 system, the communication is funneled through `cbs(1M)`. `cbs(1M)`, in turn, communicates directly with CBE running on one of the control boards in the Sun Enterprise 10000 system. `cbs(1M)` converts client requests to the control board management protocol (CBMP) that is understood by CBE. The following diagram (FIGURE 4-5) shows how the CBS and CBEs are connected.



**FIGURE 4-5** CBS Communication Between SSP and Sun Enterprise 10000 system

`cbs(1M)` relies on the `cb_config(4)` file to determine the platform it is to manage, and the control board with which it is to interact. The `cb_config(4)` file specifies the platforms managed by the SSP. You should not modify this file.

## File Access Daemons

The file access daemon (`fad(1M)`) is used when `ssp_to_domain_hosts(4)` or any other configuration file is updated. `fad(1M)` provides distributed file access services, such as file locking, to all SSP clients that need to monitor, read, and write changes to SSP configuration files. Once a file is locked by a client, other clients are prevented from locking that file until the first client releases the lock.

## Network Time Protocol Daemon

The NTP daemon (which is `xntpd(1M)` for the Solaris 2.5.1 operating environment, and `ntpd(1M)` for Solaris 2.6 and Solaris 7 operating environments) provides a mechanism for keeping the time settings synchronized between the SSP and the domains. OBP obtains the time from the SSP when the domain is booted, and NTP keeps the time synchronized from that point on.

The configuration is based on information provided by the system administrator. If you are not currently running in an NTP subnet, and you do not have access to the Internet, and you are not going to use a radio clock, you can set up the Enterprise

10000 system to use its own internal time-of-day clock as the reference clock. Usually, however, the SSP uses its internal time-of-day clock for the Sun Enterprise 10000 system.

The NTP packages are compiled with support for a local reference clock. This means that your system can poll itself for the time instead of polling another system or network clock. The poll is done through the network loopback interface. The first three numbers in the IP address are 127.127.1. The last numbers in the IP address are the NTP stratum to use for the clock.

When setting up an Sun Enterprise 10000 system and its SSP, the SSP should usually be set to stratum 4. The Sun Enterprise 10000 system should be set up as a peer to the SSP and its local clock should be set two stratums higher.

An example of server/peer lines in the `/etc/opt/SUNWxntp/ntp.conf` file on the SSP is shown below.

```
server 127.127.1.4
```

Under the Solaris 2.5.1 operating environment, you can add the following example lines to the `/etc/opt/SUNWxntp/ntp.conf` file on the platform:

```
server ssp_name
server 127.127.1.13
```

Under the Solaris 2.6 and Solaris 7 operating environments, you can add the following example lines to the `/etc/inet/ntp.conf` file on the platform:

```
server ssp_name
server 127.127.1.13 stratum 13
```

For more information on the NTP daemon, refer to the *Network Time Protocol User's Guide* and the *NTP Reference*.

## OBP Daemon

On the SSP, OBP is not a hardware PROM; it is loaded from a file on the SSP. An SSP file also replaces the traditional OBP NVRAM and `idprom` (`hostid`).

The `obp` file is located under a directory path that is specific to the SunOS release. (Note that SunOS 5.5.1 corresponds to the Solaris 2.5.1 operating environment, SunOS 5.6 corresponds to the Solaris 2.6 operating environment, and SunOS 5.7



corresponds to the Solaris 7 operating environment. You can determine your SunOS version with `uname -r`.) For example, under SunOS 5.5.1, the OBP file is located in the following directory:

```
/opt/SUNWssp/release/Ultra-Enterprise-10000/5/5/1/hostobjs/obp
```

where the `/5/5/1` portion of the path corresponds to the SunOS version number. If your release contains a different version of the operating system, that portion of the path will be different.

`bringup(1M)` starts `obp_helper(1M)` in the background, which kills the previous `obp_helper(1M)`, if one exists. `obp_helper(1M)` runs `download_helper` and subsequently downloads and runs OBP.

`obp_helper(1M)` is essential in starting processors other than the boot processor. It communicates with OBP through bootbus SRAM(BBSRAM), responding to requests to supply the time-of-day, get or put the contents of the pseudo-EEPROM, and release slave processors when in multiprocessor mode. To release the slave processors, `obp_helper(1M)` must load `download_helper` into the BBSRAM of all the slave processors, place an indication in BBSRAM that it is a slave processor, then start the processor by releasing the bootbus controller reset.

For more information, see the `obp_helper(1M)`, and `bringup(1M)` man pages and “`download_helper` File” on page 90.

---

## Environment Variables

Most of the necessary environment variables are set when the `ssp` user logs in. TABLE 4-2 describes the environment variables.

**TABLE 4-2** Environment Variables

---

<code>SUNW_HOSTNAME</code>	The name of the domain controlled by the SSP.
<code>SSPETC</code>	The path to the directory containing miscellaneous SSP-related files.
<code>SSPLOGGER</code>	The location of the configuration file for message logging. You should never change the value of this environment variable.
<code>SSPOPT</code>	The path to the SSP package binaries, libraries, and object files.
<code>SSPVAR</code>	The path to the directory where modifiable files reside.

---

---

# Executable Files Within a Domain

These files reside in `/opt/SUNWssp/release/Ultra-Enterprise-10000/os_version` and are run within a domain. The man pages for these programs reside within the domain.

Some of the commands listed in this section must be used or modified only by your service provider; they are normally called internally by other programs rather than run on the command line.



---

**Caution** – Improper use of these commands can result in failure or damage to the system. If you are not sure of the function of any command, contact your service provider for assistance.

---

## \*.elf File

These are executable files that are downloaded by `hpost(1M)`.

## download\_helper File

`download_helper` enables programs to be downloaded to the memory used by a domain instead of BBSRAM. This provides an environment in which host programs can run without having to know how to relocate themselves to memory. These programs can be larger than BBSRAM.

`download_helper` works by running a protocol through a mailbox in BBSRAM. The protocol has commands for allocating and mapping physical to virtual memory, and for moving data between a buffer in BBSRAM and virtual memory, and viceversa. When complete, the thread of execution is passed to the new program at an entry point provided by the SSP. After this occurs, `download_helper` lives on in BBSRAM so it can provide reset handling services. Normally, a user would not be concerned with the download helper; it is used only by the `obp_helper(1M)` daemon. See the `obp_helper(1M)` man page for more information.

## obp File

The `obp` file is fundamental to the boot process of a domain. OBP knows how to probe the SBus to determine which devices are connected where, and provides this information to the operating system in the form of a device tree. The device tree is ultimately visible using the command `prtconf` (for more information, see the SunOS `prtconf(1M)` man page).

`obp` also interprets and runs FCode on SBus cards, which provides loadable, simple drivers for accomplishing boot. In addition, it provides a kernel debugger, which is always loaded.



# Glossary

---

**Alternate Pathing**

**(AP)** AP enables you to set up an alternate path to system components in case of failure, repair, or replacement.

**AP** See *Alternate Pathing (AP)*.

**application specific  
integrated circuit**

**(ASIC)** In the Sun Enterprise 10000 system, any of the large main chips in the design, including the UltraSPARC processor and data buffer chips.

**arbitration stop**

A condition that occurs when one of the Sun Enterprise 10000 system ASICs detects a parity error or equivalent fatal system error. Bus arbitration is frozen, so all bus activity stops. The system is down until the SSP detects the condition by polling the Control and Status Registers (*CSRs*) of the Address Arbiter ASICs through *JTAG*, and clears the error condition.

**ASIC** See *application-specific integrated circuit (ASIC)*.

**BBSRAM** See *bootbus SRAM (BBSRAM)*.

**blacklist**

A text file that `hpost(1M)` reads when it starts up. The blacklist file specifies the Sun Enterprise 10000 system components that are not to be used or configured into the system. The default path name for this file can be overridden in the `.postrc` file (see `postrc(4)`) and on the command line.

**board descriptor**

**array**

The description of the single configuration that `hpost(1M)` chooses. It is part of the structure handed off to `OBE`.

**bootbus**

A slow-speed, byte-wide bus controlled by the processor port controller ASICs, used for running diagnostics and boot code. UltraSPARC starts running code from bootbus when it exits reset. In the Sun Enterprise 10000 system, the only component on the bootbus is the BBSRAM.

**bootbus SRAM  
(BBSRAM)**

A 256-Kbyte static RAM attached to each processor PC ASIC. Through the PC, it can be accessed for reading and writing from JTAG or the processor. Bootbus SRAM is downloaded at various times with `hpost(1M)` and OBP startup code, and provides shared data between the downloaded code and the SSP.

**control and status  
register (CSR)**

A general term for any embedded register in any of the ASICS in the Enterprise 10000 system.

**CSR** See *control and status register (CSR)*.

**DIMM** See *dual in-line memory module (DIMM)*.

**domain** A set of one or more system boards that acts as a separate system capable of booting the OS and running independently of any other domains.

**DRAM** See *dynamic RAM (DRAM)*.

**dual in-line memory  
module (DIMM)**

A small printed circuit card containing memory chips and some support logic.

**dynamic RAM  
(DRAM)**

Hardware memory chips that require periodic rewriting to retain their contents. This process is called *refresh*. In Sun Enterprise 10000 system, DRAM is used only on main memory SIMMs and on the control boards.

**Ecache** See *external cache (Ecache)*.

**external cache  
(Ecache)**

A 0.5-Mbyte to 4-Mbyte synchronous static RAM second-level cache local to each processor module. Used for both code and data. This is a direct-mapped cache.

**JTAG** A serial scan interface specified by IEEE standard 1149.1. The name comes from Joint Test Action Group, which initially designed it. See *JTAG+*.

**JTAG+** An extension of *JTAG*, developed by Sun Microsystems Inc., which adds a control line to signal that board and ring addresses are being shifted on the serial data line. Often referred to simply as *JTAG*.

**OBP** See *Open Boot PROM (OBP)*.

**OpenBoot PROM  
(OBP)**

A layer of software that takes control of the configured Sun Enterprise 10000 system from `hpost(1M)`, builds some data structures in memory, and boots the operating system.

**power-on self-test  
(POST)**

A test performed by `hpost(1M)`. This is the program that takes uninitialized Sun Enterprise 10000 system hardware and probes and tests its components, configures what seems worthwhile into a coherent initialized system, and hands it off to OBP.

- .postrc** A text file that controls options in `hpost(1M)`. Some of the functions can also be controlled from the command line. Arguments on the command line take precedence over lines in the `.postrc` file, which takes precedence over built-in defaults. `hpost -? postrc` gives a terse reminder of the `.postrc` options and syntax. See `postrc(4)`.
- SBus** A Sun Microsystems Inc. designed I/O bus, now an open standard.
- SRAM** See *static RAM (SRAM)*.
- static RAM (SRAM)** Memory chips that retain their contents as long as power is maintained.
- SSP** See *System Service Processor (SSP)*.
- System Service Processor (SSP)** A workstation containing software for controlling power sequencing, diagnostics, and booting of a Sun Enterprise 10000 system.
- UltraSPARC** The UltraSPARC processor is the processor module used in the Sun Enterprise 10000 system.





# Index

---

## A

arbitration stop (definition), 93  
ASIC (definition), 93

## B

BBSRAM (definition), 94  
blacklist  
    blacklist components from Hostview, 68  
    blacklisting components, 67  
    blacklisting processors, 69  
    clear blacklist file, 71  
    components that can be blacklisted, 67  
blacklist (definition), 93  
board descriptor array (definition), 93  
board with black outline, Hostview, 25  
board with colored outline, Hostview, 24  
board with no outline, Hostview, 24  
board, selected (in Hostview), 25  
boards in same domain, Hostview, 24  
bootbus (definition), 93  
bringup  
    manual, 64  
bringup command, 89  
bringup domain from command line, 65  
bringup(M) example, 65  
buttons  
    temperature, 29

## C

CBE (control board executive), 74

CBE (control board executive), overview, 15  
CBS (control board server), 74, 86  
CBS and CBE, communications port, 75  
clear blacklist file, 71  
colors in Hostview, 31  
command line, creating domains, 58  
command line, power(1M), 47  
command line, removing domains, 62  
commands  
    bringup, 89  
    download\_helper, 90  
    obp, 91  
communications port between CBS and CBE, 75  
configuration menu, 26  
    board, 26  
    domain, 26  
configuration requirements, domain, 56  
configure netcontool(1M), 37  
configuring control boards, 76  
console menu, 27  
control and status register (CSR), 94  
control board configuration, 76  
control board executive (CBE), 74  
control board executive (CBE), overview, 15  
control board server (CBS), 74, 86  
control boards, overview, 15  
control menu, 26  
    bringup, 26  
    fan, 26  
    power, 26  
controlling fans, Hostview, 54  
creating domains, command line, 58  
creating domains, Hostview, 56

## D

- daemons
  - edd, 84
  - obp\_helper, 84
  - SSP, 83
  - xntpd, 84
- dedicated spare SSP, 71
- DIMM (definition), 94
- display netcon(1M) window, 34
- display netcontool(1M) window, 35
- domain\_create, 58
- domain\_create(1M) example, 58
- domain\_remove, 62
- domain\_remove(1M) example, 62
- domain\_rename(1M) example, 64
- domains, 13
  - configuration requirements, 56
  - creating domains, Hostview, 56
  - domain name must be preconfigured into system, 58
  - renaming domains, Hostview, 62
  - status of domains, Hostview, 65
- download\_helper command, 90
- DRAM (definition), 94
- dual control boards, overview, 15
- Dynamic System Domains, 13

## E

- edd daemon, 84
- edit menu, 26
- elf files, 90
- environment variables, 89
  - SSPETC, 89
  - SSPLOGGER, 89
  - SSPOPT, 89
  - SSPVAR, 89
  - SUNW\_HOSTNAME, 89
- error indicators, Hostview, 28
- error message files, 43
- event detector daemon (edd), 84
- exclusive session (netcon), 39
- exclusive session permission, netcon(1M), 32
- external cache (definition), 94

## F

- Failure button, Hostview, 30
- Fan button, Hostview, 29
- fan speed, 55
- Fan Status Display window, 53
- fan tray display, 54
- fans, controlling in Hostview, 54
- fans, monitoring in Hostview, 52
- features of SSP, 13
- file menu, 26
- files
  - error messages, 43

## G

- green bar, voltage level, 50

## H

- help menu, 27
- help window, Hostview, 28
- Hostview, 21
  - blacklisting components, 68
  - blacklisting processors, 69
  - boards in same domain, 24
  - bringup, manual, 64
  - clear blacklist file, 71
  - colors, meaning of, 31
  - controlling fans, 54
  - displaying netcontool(1M) window, 36
  - domains, creating, 56
  - domains, renaming, 62
  - domains, status, 65
  - Failure button, 30
  - Fan button, 29
  - Fan Status Display window, 53
  - help window, 28
  - icons, meaning of, 30
  - main window, 23
  - menu
    - configuration, 26
      - board, 26
      - domain, 26
    - console, 27
    - control, 26
    - bringup, 26

- fan, 26
- power, 26
- edit, 26
- file, 26
- help, 27
- terminal
  - netcontool, 27
  - rlogin, 27
  - SSP, 27
- view
  - all domains, 27
  - individual domains, 27
- menu bar, 26
- monitoring fans, 52
- monitoring power, 48
- monitoring temperature, 50
- out-of-boundary indicators, 28
- performance considerations, 31
- Power button, 29
- selecting items in main window, 25
- SSP Logs window, 44
- starting Hostview, 22
- symbols, meaning of, 30
- system board, black outline, 25
- system board, no outline, 24
- system board, with colored outline, 24
- Temperature button, 29
- Thermal Detail window, 51
- viewing messages file, 44

**I**  
icons, Hostview, 30

**J**  
JTAG (definition), 94

**L**  
locked write (netcon), 39  
locked write permission, netcon(1M), 32

**M**  
manual bringup, 64  
menu
 

- configuration, 26
  - board, 26
  - domain, 26
- console, 27
- control, 26
  - bringup, 26
  - fan, 26
  - power, 26
- edit, 26
- file, 26
- help, 27
- terminal
  - netcontool, 27
  - rlogin, 27
  - SSP, 27
- view
  - all domains, 27
  - individual domains, 27

- menu bar
- Hostview, 26
- messages file for domain, viewing, 44
- messages files, 43
- monitor power levels in Hostview, 48
- monitoring fans, Hostview, 52
- monitoring power, Hostview, 48
- monitoring temperature, Hostview, 50

**N**  
netcon(1M), 18, 32  
netcon(1M), communication paths for console I/O, 39  
netcon(1M), displaying window, 34  
netcon(1M), overview, 18  
netcontool(1M) buttons, overview, 33  
netcontool(1M), configuration window, 37  
netcontool(1M), displaying from Hostview, 36  
netcontool(1M), displaying window, 35  
Network Console Window, 18  
non-dedicated spare SSP, 71

**O**  
OBP (definition), 94

- obp command, 91
- OBP. See OpenBootProm
- obp\_helper daemon, 84
- Open Boot PROM (definition), 94
- OpenBootProm, 80, 88
- out-of-boundary indicators, Hostview, 28

## P

- platform (definition), 13
- POST, 82
- POST (definition), 94
- postrc(4), 95
- power
  - monitor power levels in Hostview, 48
  - monitoring power, Hostview, 48
  - Power button, Hostview, 29
  - power command, 47
  - Power Detail window, 49
  - power off fails when domain running, 46
  - Power Status Display window, 48
  - shutdown(1M) and power(1M), 46
- power-on self-test (POST), definition, 94
- primary control board, 74
- processors, blacklisting, 69

## R

- read only session (netcon), 38
- red bar, voltage level, 50
- removing domains, command line, 62
- renaming domains, Hostview, 62

## S

- SBus (definition), 95
- selected system board, Hostview, 25
- selecting items, Hostview, 25
- shutdown(1M) and power(1M), 46
- snmp agent, 85
- Solaris
  - version supported, 13
- spare SSP, 71
- spare SSP, requirements, 71
- speed of fans, controlling, 55
- SRAM (definition), 95

## SSP

- user environment, 15
- SSP Console Window, 18
- SSP daemons, 83
- SSP features, 13
- ssp log, 26
- SSP log file, 43
- SSP Logs window, 44
- SSP Window, 16
- SSP window, 16
- SSP, requirements, 13
- SSP, spare, 71
- SSPETC, 89
- SSPLOGGER, 89
- SSPOPT, 89
- SSPVAR, 89
- startup flow, 79
- status of domains, Hostview, 65
- SUNW\_HOSTNAME, 89
- swap space required by Hostview, 31
- swapping control boards, 76
- symbols in Hostview, 30
- system board with black outline, Hostview, 25
- system board with colored outline, Hostview, 24
- system board with no outline, Hostview, 24
- system board, selected (in Hostview), 25
- system boards in same domain, Hostview, 24
- System Service Processor, 13
- System Service Processor (SSP), requirements, 13

## T

- temperature
  - monitoring temperature, Hostview, 50
- temperature button, 29
- Temperature button, Hostview, 29
- terminal menu
  - netcontool, 27
  - rlogin, 27
  - SSP, 27
- Thermal Detail window, 51

## U

- unlocked write (netcon), 38
- unlocked write permission, netcon(1M), 32
- user environment, 15

## **V**

view menu

- all domains, 27

- individual domains, 27

voltage level, green bar, 50

voltage level, red bar, 50

## **W**

windows

- Fan Status Display window, 53

- Hostview main window, 23

- netcon(1M), 18

- netcon(1M), displaying window, 34

- netcontool(1M), configuration window, 37

- netcontool(1M), displaying window, 35

- Network Console Window, 18

- Power Detail window, 49

- Power Status Display, 48

- SSP Console Window, 18

- SSP Logs window, 44

- SSP Window, 16

- Thermal Detail window, 51

## **X**

xntpd daemon, 84



Sun Enterprise 10000 SSP Attributions:

This software is copyrighted by the Regents of the University of California, Sun Microsystems, Inc., and other parties. The following terms apply to all files associated with the software unless explicitly disclaimed in individual files.

The authors hereby grant permission to use, copy, modify, distribute, and license this software and its documentation for any purpose, provided that existing copyright notices are retained in all copies and that this notice is included verbatim in any distributions. No written agreement, license, or royalty fee is required for any of the authorized uses. Modifications to this software may be copyrighted by their authors and need not follow the licensing terms described here, provided that the new terms are clearly indicated on the first page of each file where they apply.

IN NO EVENT SHALL THE AUTHORS OR DISTRIBUTORS BE LIABLE TO ANY PARTY FOR DIRECT, INDIRECT, SPECIAL, INCIDENTAL, OR CONSEQUENTIAL DAMAGES ARISING OUT OF THE USE OF THIS SOFTWARE, ITS DOCUMENTATION, OR ANY DERIVATIVES THEREOF, EVEN IF THE AUTHORS HAVE BEEN ADVISED OF THE POSSIBILITY OF SUCH DAMAGE.

THE AUTHORS AND DISTRIBUTORS SPECIFICALLY DISCLAIM ANY WARRANTIES, INCLUDING, BUT NOT LIMITED TO, THE IMPLIED WARRANTIES OF MERCHANTABILITY, FITNESS FOR A PARTICULAR PURPOSE, AND NON-INFRINGEMENT. THIS SOFTWARE IS PROVIDED ON AN "AS IS" BASIS, AND THE AUTHORS AND DISTRIBUTORS HAVE NO OBLIGATION TO PROVIDE MAINTENANCE, SUPPORT, UPDATES, ENHANCEMENTS, OR MODIFICATIONS.

RESTRICTED RIGHTS: Use, duplication or disclosure by the government is subject to the restrictions as set forth in subparagraph (c) (1) (ii) of the Rights in Technical Data and Computer Software Clause as DFARS 252.227-7013 and FAR 52.227-19.

This is scotty, a simple tcl interpreter with some special commands to get information about TCP/IP networks. Copyright (c) 1993, 1994, 1995, J. Schoenwaelder, TU Braunschweig, Germany, Institute for Operating Systems and Computer Networks. Permission to use, copy, modify, and distribute this software and its documentation for any purpose and without fee is hereby granted, provided that this copyright notice appears in all copies. The University of Braunschweig makes no representations about the suitability of this software for any purpose. It is provided as is" without express or implied warranty.