

# Netra™ st D130 Product Notes

---



THE NETWORK IS THE COMPUTER™

**Sun Microsystems, Inc.**  
901 San Antonio Road  
Palo Alto, CA 94303-4900 USA  
650 960-1300 Fax 650 969-9131

Part No.: 806-1490-11  
December 1999, Revision A

Send comments about this document to: [docfeedback@sun.com](mailto:docfeedback@sun.com)

Copyright 1999 Sun Microsystems, Inc., 901 San Antonio Road, Palo Alto, California 94303-4900 U.S.A. All rights reserved.

This product or document is protected by copyright and distributed under licenses restricting its use, copying, distribution, and decompilation. No part of this product or document may be reproduced in any form by any means without prior written authorization of Sun and its licensors, if any. Third-party software, including font technology, is copyrighted and licensed from Sun suppliers.

Parts of the product may be derived from Berkeley BSD systems, licensed from the University of California. UNIX is a registered trademark in the U.S. and other countries, exclusively licensed through X/Open Company, Ltd. For Netscape Communicator™, the following notice applies: (c) Copyright 1995 Netscape Communications Corporation. All rights reserved.

Sun, Sun Microsystems, the Sun logo, SunStore, AnswerBook2, docs.sun.com, and Solaris are trademarks, registered trademarks, or service marks of Sun Microsystems, Inc. in the U.S. and other countries. All SPARC trademarks are used under license and are trademarks or registered trademarks of SPARC International, Inc. in the U.S. and other countries. Products bearing SPARC trademarks are based upon an architecture developed by Sun Microsystems, Inc.

The OPEN LOOK and Sun™ Graphical User Interface was developed by Sun Microsystems, Inc. for its users and licensees. Sun acknowledges the pioneering efforts of Xerox in researching and developing the concept of visual or graphical user interfaces for the computer industry. Sun holds a non-exclusive license from Xerox to the Xerox Graphical User Interface, which license also covers Sun's licensees who implement OPEN LOOK GUIs and otherwise comply with Sun's written license agreements.

**RESTRICTED RIGHTS:** Use, duplication, or disclosure by the U.S. Government is subject to restrictions of FAR 52.227-14(g)(2)(6/87) and FAR 52.227-19(6/87), or DFAR 252.227-7015(b)(6/95) and DFAR 227.7202-3(a).

DOCUMENTATION IS PROVIDED "AS IS" AND ALL EXPRESS OR IMPLIED CONDITIONS, REPRESENTATIONS AND WARRANTIES, INCLUDING ANY IMPLIED WARRANTY OF MERCHANTABILITY, FITNESS FOR A PARTICULAR PURPOSE OR NON-INFRINGEMENT, ARE DISCLAIMED, EXCEPT TO THE EXTENT THAT SUCH DISCLAIMERS ARE HELD TO BE LEGALLY INVALID.

---

Copyright 1999 Sun Microsystems, Inc., 901 San Antonio Road, Palo Alto, Californie 94303-4900 U.S.A. Tous droits réservés.

Ce produit ou document est protégé par un copyright et distribué avec des licences qui en restreignent l'utilisation, la copie, la distribution, et la décompilation. Aucune partie de ce produit ou document ne peut être reproduite sous aucune forme, par quelque moyen que ce soit, sans l'autorisation préalable et écrite de Sun et de ses bailleurs de licence, s'il y en a. Le logiciel détenu par des tiers, et qui comprend la technologie relative aux polices de caractères, est protégé par un copyright et licencié par des fournisseurs de Sun.

Des parties de ce produit pourront être dérivées des systèmes Berkeley BSD licenciés par l'Université de Californie. UNIX est une marque déposée aux Etats-Unis et dans d'autres pays et licenciée exclusivement par X/Open Company, Ltd. La notice suivante est applicable à Netscape Communicator™ : (c) Copyright 1995 Netscape Communications Corporation. All rights reserved.

Sun, Sun Microsystems, le logo Sun, SunStore, AnswerBook2, docs.sun.com, et Solaris sont des marques de fabrique ou des marques déposées, ou marques de service, de Sun Microsystems, Inc. aux Etats-Unis et dans d'autres pays. Toutes les marques SPARC sont utilisées sous licence et sont des marques de fabrique ou des marques déposées de SPARC International, Inc. aux Etats-Unis et dans d'autres pays. Les produits portant les marques SPARC sont basés sur une architecture développée par Sun Microsystems, Inc.

L'interface d'utilisation graphique OPEN LOOK et Sun™ a été développée par Sun Microsystems, Inc. pour ses utilisateurs et licenciés. Sun reconnaît les efforts de pionniers de Xerox pour la recherche et le développement du concept des interfaces d'utilisation visuelle ou graphique pour l'industrie de l'informatique. Sun détient une licence non exclusive de Xerox sur l'interface d'utilisation graphique Xerox, cette licence couvrant également les licenciés de Sun qui mettent en place l'interface d'utilisation graphique OPEN LOOK et qui en outre se conforment aux licences écrites de Sun.

CETTE PUBLICATION EST FOURNIE "EN L'ETAT" ET AUCUNE GARANTIE, EXPRESSE OU IMPLICITE, N'EST ACCORDEE, Y COMPRIS DES GARANTIES CONCERNANT LA VALEUR MARCHANDE, L'APTITUDE DE LA PUBLICATION A REPOUDRE A UNE UTILISATION PARTICULIERE, OU LE FAIT QU'ELLE NE SOIT PAS CONTREFAISANTE DE PRODUIT DE TIERS. CE DENI DE GARANTIE NE S'APPLIQUERAIT PAS, DANS LA MESURE OU IL SERAIT TENU JURIDIQUEMENT NUL ET NON AVENU.



Adobe PostScript

# Netra™ st D130 Product Notes

---

---

## Accessing the Translated Versions of the Documentation

The Netra™ st D130 documentation is available in English. Go to:

<http://www.sun.com/netra>

La documentation du Netra st D130 est disponible en français. Reportez-vous à :

<http://www.sun.com/netra>

Die Netra st D130-Dokumentation ist in deutscher Sprache erhältlich. Wechseln Sie zu:

<http://www.sun.com/netra>

La documentazione di Netra st D130 è disponibile in italiano. Andare a:

<http://www.sun.com/netra>

La documentación del Netra st D130 se encuentra disponible en español. Vaya a:

<http://www.sun.com/netra>

Dokumentationen till Netra st D130 finns på svenska. Gå till:

<http://www.sun.com/netra>

Netra st文章には日本語版があります。以下にお進みください。

<http://www.sun.com/netra>

한글 Netra st 설명서 이동:

<http://www.sun.com/netra>

Netra st 文档提供简体中文版，请转至:

<http://www.sun.com/netra>

Netra st 文件提供繁體中文版，請轉至：

<http://www.sun.com/netra>

---

## Mounting the Netra st D130 Storage Enclosure in a Rack

The Netra st D130 storage enclosure is shipped out of the factory with two 19-inch mounting brackets, installed in the forward position.

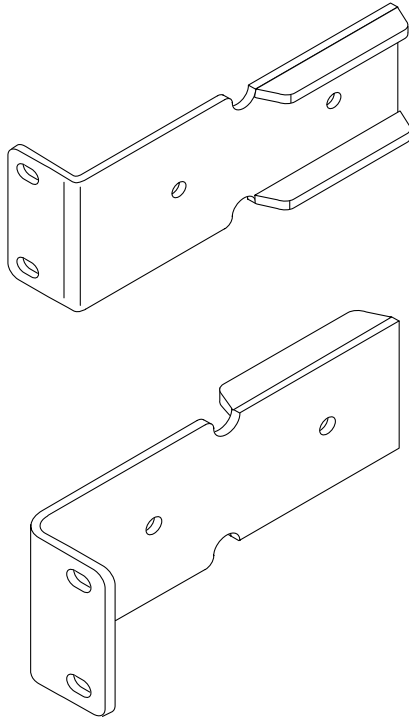

**FIGURE 0-1** Mounting Brackets

The chassis must be secured within the rack frame using screws suitable for the equipment frame. They must be a minimum size of M6 depending on the frame requirement. All screws must be fitted. There are positions provided for a total of four screws (two per side). The suggested tightening torque value for M6 recess head screws is 4.0Nm (3.0lbf-ft).

## ▼ To Mount the Storage Enclosure in a Rack



---

**Caution** – Install each Netra st D130 storage enclosure into a rack starting from the bottom up. Very tall racks can become top heavy and unstable. Be sure to mount the enclosure in a rack or cabinet in such a way that you do not create a hazardous condition due to uneven mechanical loading or weight distribution.

---

**1. Determine if you want to mount the Netra st D130 storage enclosure in the forward, center or rear position.**

The mounting brackets included with the Netra st D130 storage enclosure are set in the forward position by default.

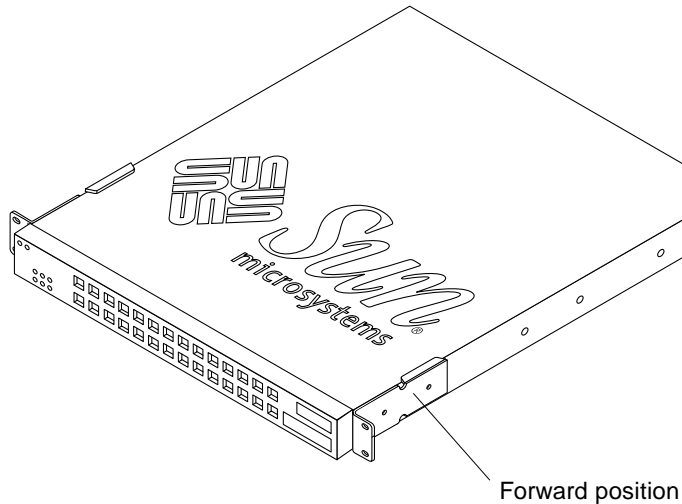
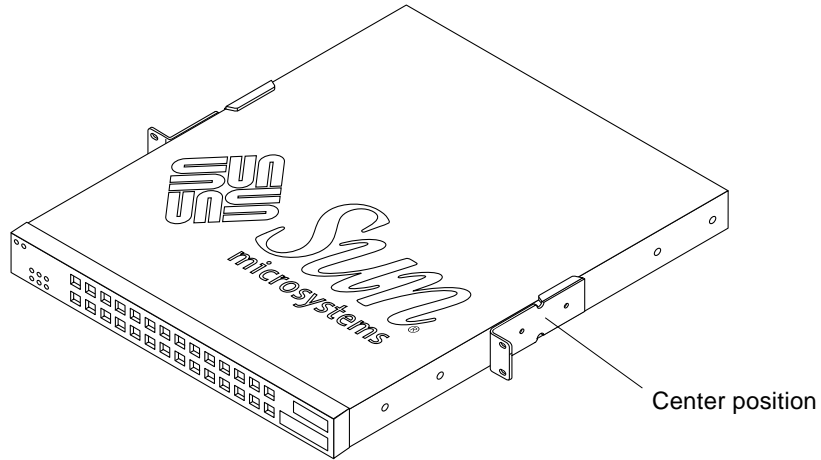

**FIGURE 0-2** Mounting Bracket in the Forward Position

To move the brackets to the center or rear positions:

- a. Unscrew the two screws that secure each mounting bracket to the side of the Netra st D130 storage enclosure.**
- b. Move each mounting bracket to the center or rear position.**

Note that if you are moving the mounting brackets to the rear position, you must rotate the bracket 180 degrees so that the bracket ears are facing the rear of the rack.



**FIGURE 0-3** Mounting Brackets in the Center Position

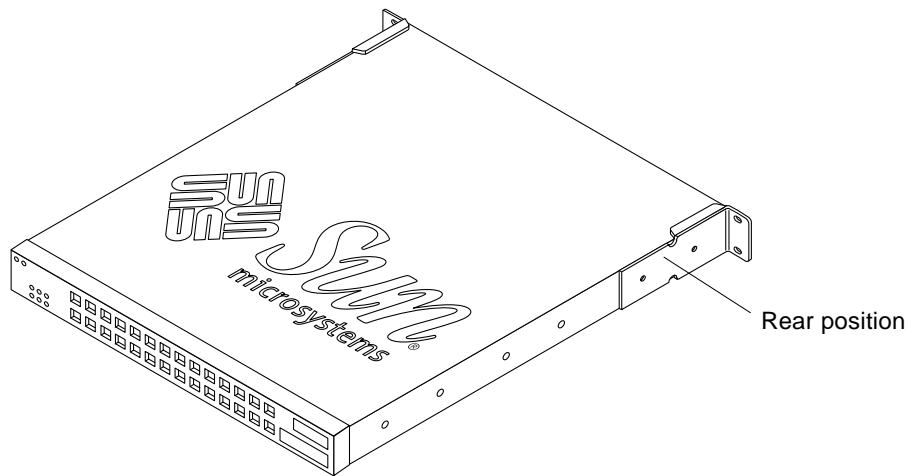

**FIGURE 0-4** Mounting Brackets in the Rear Position

- c. Secure each mounting bracket to the side of the Netra st D130 storage enclosure using the two screws.**
  - 2. Lift the storage enclosure into the rack.**
  - 3. Secure the storage enclosure to the rack using four screws (two for each side).**

---

# Isolating the Chassis Ground Connection

Every Netra st D130 storage enclosure is shipped out of the factory with the chassis ground connected to the common output return through two screws on the power supply at the rear of the enclosure. If you want to isolate this connection, follow these instructions:

1. **Go to the rear of the Netra st D130 storage enclosure and locate the two screws used to isolate the chassis ground connection.**

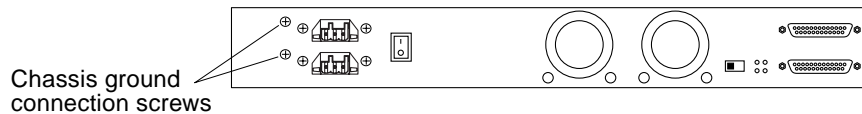

**FIGURE 0-5** Locating the Chassis Ground Connection Screws

2. **Unscrew the two chassis ground connection screws.**

---

**Note** – Do not remove the two screws that are immediately to the left of the DC connectors, flush against the chassis. Those screws hold the DC connectors in place. Remove the two screws to the left of the two screws that hold the DC connectors in place, the screws that are raised slightly from the chassis.

---

3. **Locate the two chassis ground isolation bushings.**

The chassis ground isolation bushings should be in a plastic bag in the ship kit.



4. Insert the two bushings and screws into the screw holes and tighten the screws.

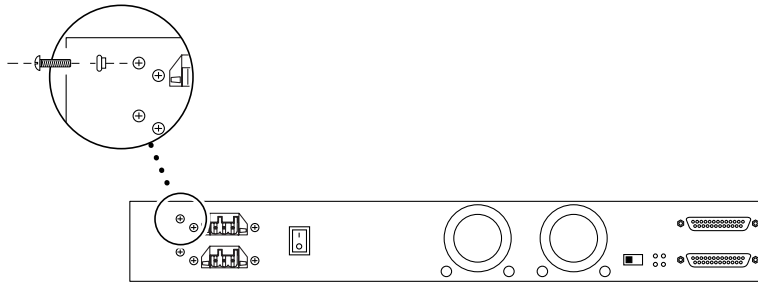

FIGURE 0-6 Locating the Chassis Ground Connections Screws

---

## Revised SCSI Cable Information

### SCSI Cable Length

The following text appears on page 28 of the *Netra st D130 Installation and Maintenance Manual*:

“2. Get the 2-meter SCSI cable from the ship kit and connect one end of the SCSI cable to your host system.”

The length of the cable in this step is incorrect – the length of the SCSI cable shipped out with the Netra st D130 storage enclosure is .8 meters long, not 2 meters.

### Ordering the SCSI Daisy-Chain Cable

The following text appears on page 29 of the *Netra st D130 Installation and Maintenance Manual*:

“5. Get the .36-meter SCSI cable from the ship kit.”

This information is incorrect – the .36-meter SCSI daisy-chain cable is not shipped out with the Netra st D130 storage enclosure. You can daisy-chain two Netra st D130 storage enclosures together using the .8-meter SCSI cable included in the ship kit. If you want a .36-meter SCSI daisy-chain cable, you can order one separately from Sun Microsystems (part number X6917A).

---

# Cleaning the Netra st D130 Screens

To ensure optimum performance from your Netra st D130 storage enclosure, you should clean the screens at the front and rear of the enclosure periodically.

## ▼ To Clean the Front Bezel Screen

1. **Remove the front panel by pressing the latches on both ends and pulling the panel away from the enclosure.**

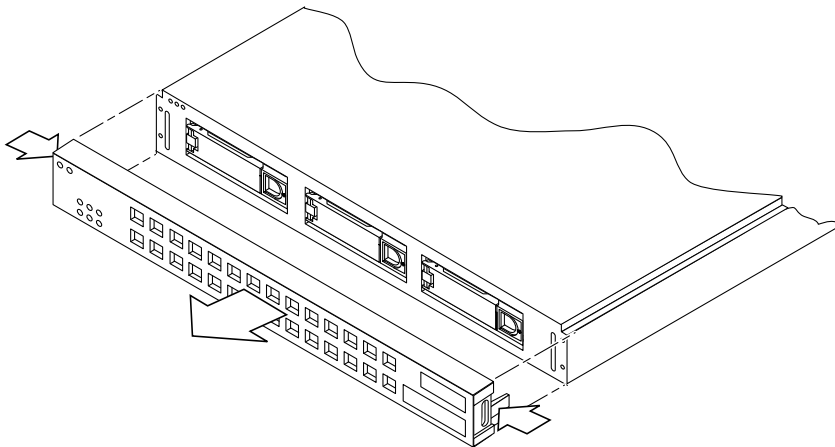
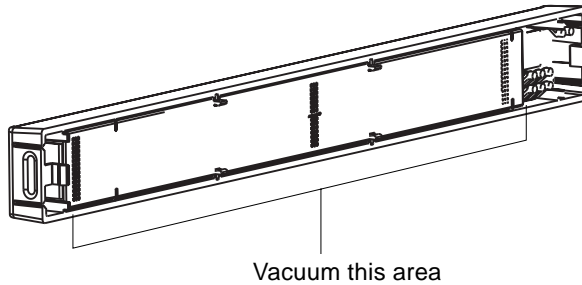

FIGURE 0-7 Removing the Front Panel

2. **Use a vacuum cleaner to clean all the dust and debris from the screen at the rear of the front panel.**



**FIGURE 0-8** Cleaning the Front Bezel Screen

## ▼ To Clean the Rear Fan Screens

- Go to the rear of the system and use a vacuum cleaner to clean all the dust and debris from the fan screens at the rear of the storage enclosure.

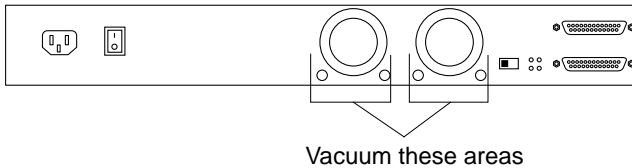

**FIGURE 0-9** Cleaning the Rear Fan Screens

---

## Updated DC Connector Information

In the DC connector section of the documentation, instructions are given on disconnecting the DC input power cable from the DC connector on the back of the system. Be very careful when disconnecting the DC input power cable from the DC connector; the DC connector is very sensitive and could be damaged if you disconnect the DC input power cable without fully squeezing the tabs at the sides of the DC input power cable.

---

# System Monitoring Software for the Netra st D130 Storage Enclosure

System monitoring software is available for the Netra st D130 storage enclosure. For availability dates and download instructions, go to:

<http://www.sun.com/netra>

---

## Late-Breaking News

For late-breaking news on the Netra st D130 storage enclosure, go to:

<http://www.sun.com/netra>