

# COBALT RaQ™ 4

---

*User Manual*



©1998-2001 Cobalt Networks, Inc. All rights reserved.

**Part Number:**        **070-00239-02**  
**Date:**                 **02-2001**

The Cobalt logo, Cobalt Networks, Cube, Cobalt Qube, Qube, Cobalt RaQ, RaQ, Cobalt CacheRaQ, Cobalt NASRaQ, Cobalt StaQware and BlueLinQ are trademarks or registered trademarks of Cobalt Networks, Inc.

Chili!Soft and Chili!Soft ASP are trademarks or registered trademarks of Chili!Soft, Inc.

Linux is a trademark of Linus Torvalds.

The RSA software and the RSA logo are trademarks of RSA Data Security Inc.

All other company, brand and product names may be registered trademarks or trademarks of their respective companies and are hereby recognized.

This publication and the information herein is furnished "AS IS", subject to change without notice, and should not be construed as a commitment by Cobalt Networks, Inc. Furthermore, Cobalt Networks, Inc., assumes no responsibility or liability for any errors or inaccuracies, makes no warranty of any kind (express, implied or statutory) with respect to this publication, and expressly disclaims any and all warranties of merchantability, fitness for particular purposes and non-infringement of third-party rights.

The majority of the software used within the Cobalt RaQ 4 can be freely distributed under the terms of the BSD copyright and the GNU Public License. However, some applications remain the property of their owners and require their permission to redistribute.

The Cobalt RaQ 4 includes software developed by the Apache Group for use in the Apache HTTP server project (<http://www.apache.org/>).

The Cobalt RaQ 4 also includes Majordomo, a package for managing Internet mailing lists. The latest version of Majordomo can be obtained from <ftp://ftp.greatcircle.com/pub/majordomo/>.

Sendmail is a trademark of Sendmail, Inc.

Cobalt Networks, Inc.  
555 Ellis Street  
Mountain View, CA 94043  
[www.cobalt.com](http://www.cobalt.com)

In the U.S.A.:

Phone               (888) 70-COBALT  
                      (650) 623-2500  
Fax                 (650) 623-2501

Outside the U.S.A.:

Phone               +1 (650) 623-2500  
Fax                 +1 (650) 623-2501

# Important Safeguards

---

For your protection, please read and understand all of the safety and operating instructions regarding your Cobalt RaQ 4 and retain for future reference.

## 1. Ventilation

The Cobalt RaQ 4's bottom vents (on the front) and fan opening(s) (on the back panel) protect the server from overheating. These openings must not be blocked or covered. This product should not be placed in a built-in installation unless proper ventilation is provided.

## 2. Lithium Battery

The lithium battery on the system board provides power for the real-time clock and CMOS RAM. The battery has an estimated useful life expectancy of 5 to 10 years. If your system no longer keeps accurate time and date settings, it may be time to change the battery. Contact Cobalt for service information.



---

**Warning:** There is a danger of explosion if the battery is incorrectly replaced or replaced with the wrong type of battery. Replace only with the same or equivalent type recommended by the equipment manufacturer. Dispose of used batteries according to manufacturer's instructions.

---



---

**Avertissement :** Il y a danger d'explosion s'il y a remplacement incorrect de la pile. Remplacer uniquement avec une pile du même type ou d'un type équivalent recommandé par le fabricant. Mettre au rebut les piles usagées conformément aux instructions du fabricant.

---



---

**Achtung:** Explosionsgefahr wenn die Batterie in umgekehrter Polarität eingesetzt wird. Nur mit einem gleichen oder ähnlichen, vom Hersteller empfohlenen Typ, ersetzen. Verbrauchte Batterien müssen gemäß den Anweisungen des Herstellers verwertet werden.

---

### 3. Power Cord



---

**Caution:** The power-supply cord is used as the main disconnect device. Ensure that the socket outlet is located or installed near the equipment and is easily accessible.

---



---

**Attention :** Le cordon d'alimentation sert d'interrupteur général. La prise de courant doit être située ou installée à proximité du matériel et offrir un accès facile.

---



---

**Achtung:** Zur sicheren Trennung des Gerätes vom Netz ist der Netzstecker zu ziehen. Vergewissern Sie sich, dass die Steckdose leicht zugänglich ist.

---

### 4. Electrical Shock

To reduce the risk of electrical shock, do not disassemble this product. Take the RaQ 4 to a qualified service person when service or repair work is required. Opening or removing covers may expose you to dangerous voltage or other risks. Incorrect reassembly can cause electric shock when this product is subsequently used.

### 5. Operating the unit in an equipment rack

If you plan to install the Cobalt RaQ 4 in an equipment rack, take the following precautions:

- a. Ensure the ambient temperature around the Cobalt RaQ 4 (which may be higher than the room temperature) is within the limits specified in Appendix B. See “Physical data” on page 159.
- b. Ensure there is sufficient air flow around the unit.
- c. Ensure electrical circuits are not overloaded; consider the nameplate ratings of all the connected equipment and ensure you have overcurrent protection.
- d. Ensure the equipment is properly grounded, particularly any equipment connected to a power strip.
- e. Do not place any objects on top of the Cobalt RaQ 4.

## 6. Browsers

Both Netscape Navigator® and Microsoft® Internet Explorer have bugs that can cause intermittent, unexplained failures. When using a Web browser to interact with your Cobalt RaQ 4, you may occasionally experience a browser failure. Released product versions of the browsers are usually more reliable than beta versions and later versions typically work the most reliably. A browser program failure, although annoying, does not adversely affect your Cobalt RaQ 4's data.

To use the RaQ 4, you need a personal computer (attached to the network) that uses a Web browser (for example, Netscape Navigator, version 4.7 or later, or Microsoft Internet Explorer, version 5.0 or later). To manage the RaQ 4 from the Server Desktop, you must enable cookies, cascading style sheets and Javascript on your browser (these features are normally enabled by default).

### Regulations and Information

This equipment has been tested and found to comply with the limits for a Class B digital device, pursuant to Part 15 of the FCC Rules. These limits are designed to provide reasonable protection against harmful interference in a residential installation. This equipment generates, uses and can radiate radio frequency energy and, if not installed and used in accordance with the instructions, may cause harmful interference to radio communications. However, there is no guarantee that interference will not occur in a particular installation. If this equipment does cause harmful interference to radio or television reception, which can be determined by turning the equipment off and on, the user is encouraged to try to correct the interference by one or more of the following measures:

- Re-orient or re-locate the receiving antenna.
- Increase the separation between the equipment and receiver.
- Connect the equipment into an outlet on a circuit different from that to which the receiver is connected.
- Consult the dealer or an experienced radio/TV technician for help.

In order to maintain compliance with FCC regulations, shielded cables must be used with this equipment. Operation with non-approved equipment or unshielded cables is likely to result in interference to radio and TV reception. The user is cautioned that changes and modifications made to the equipment without the approval of manufacturer can void the user's authority to operate this equipment.

This equipment is in compliance with Underwriters Laboratories (UL) and is UL-listed.

## *Important Safeguards*

# Contents

---

<b>Important Safeguards</b>	<b>iii</b>
<b>1 Introduction</b>	<b>1</b>
General	3
Front view of the RaQ 4	4
Rear view of the RaQ 4	5
RaQ 4 requirements	6
Target audience for the RaQ 4	6
Levels of user	7
Organization of the user manual	8
List of chapters and appendices	10
Icons used on the UI and in the manual	11
Customer Service and Technical Support	13
General Cobalt information	13
Cobalt Technical Support and Service	14
Email contact	14
Technical Support telephone numbers	14
Further resources and information	14
Solutions	14
Cobalt Developer Network	14
Discussion Groups	15
The Knowledge Base	15
Online technical papers	15
Education	15
Before contacting Cobalt Networks Technical Support	16
Support tools feature	17
Cobalt logo badge	17

<b>2 Setting up the RaQ 4</b>	<b>19</b>
Phase 1: Making the connection	19
Installing the RaQ 4	19
Connecting to the network	21
Connecting the power cord	21
Powering on the RaQ 4	21
Configuring the RaQ 4 for the network	22
Using the LCD console to configure the network	22
Setting the configuration	23
Phase 2: Setting up with the Web browser	24
Configuring the RaQ 4 with the Setup Wizard	25
Entering the network settings	26
Entering the administrator settings	27
Entering the service settings	28
Entering the time settings	29
Completing configuration with the Setup Wizard	29
Registering the RaQ 4 online	29
Registering online at a later time	31
Registering the RaQ 4	32
<b>3 RaQ 4 Server Management</b>	<b>33</b>
Approaches to RaQ 4 administration	34
Definition of a virtual site	35
Support for RAID-1 (RaQ 4r configuration only)	36
Site management	37
Search and sort functions	39
Searching a list of virtual sites	40
Sorting a list of virtual sites	40
Overview of virtual sites	41
FrontPage Server Extensions	44
Active Server Pages (ASP)	45
ASP Administrative Server	45
PHP embedded scripting	45
Setting defaults for a virtual site	46
Modifying the default site settings	47



Adding a virtual site	47
Adding a name-based virtual site	48
Removing a virtual site	49
RaQ 4 Administrator	50
Changing the RaQ 4 Administrator password	51
Resetting the RaQ 4 Administrator password	51
Control panel	52
Services	52
Web server	53
Email server	53
SMTP server	53
Email relaying	56
File transfer protocol (FTP) server	58
Telnet server	58
Simple Network Management Protocol (SNMP) agent	59
Legato file backup	60
Arkeia file backup	61
ASP Administrative Server	62
Domain Name System (DNS) server	63
Network	64
Bandwidth	65
Bandwidth Limits table	66
Applying a bandwidth limit	67
Modifying a bandwidth limit	68
Deleting a bandwidth limit	69
Time	69
Maintenance	71
Backup	71
Manual backup	72
Scheduled backup	74
Backup file locations	76
Restore	77
Install software	80
Third-party software	82
InterBase	82

Storage	82
Adding a storage device	84
Suspend a virtual site	85
Hard suspension	85
Reboot	85
Shutdown	86
Support tools	86
Site Usage	88
System Status	89
System components	91
Central processing unit (CPU)	91
Memory	91
Disk	91
Network	91
Services	92
Web server	92
Email	92
File transfer protocol (FTP)	92
Telnet	92
Simple Network Management Protocol (SNMP)	92
Domain Name System	92
Active Monitor	93

## **4 Site Management** **95**

User management	97
Setting defaults for a site user	97
Modifying the default user settings	98
Adding a site user	99
Search and sort functions	100
Searching a list of site users	101
Sorting a list of site users	101
Removing a site user	102
Entering user email settings and aliases	102
Mail Forwarding and Vacation Reply	102
Email aliases	103
Adding an email alias	103

Changing user settings	104
Modify settings for a site user	104
Modify email options for a site user	105
Catch-all email account	107
Remove a site user	107
Mailing list management	108
Adding a mailing list	109
Modifying a mailing list	111
Removing a mailing list	112
Site settings	112
Changing site settings	113
Suspend a virtual site	115
Soft suspension	115
Suspend a site user	116
FTP settings	116
SSL settings	118
Obtain an externally signed SSL certificate	119
Enable SSL on a virtual site	119
Generate a self-signed certificate	120
SSL certificate for the main site	123
Enable the administration server for SSL	123
Submit the information to an external certification authority	123
Receive the response from the external certification authority	124
Enter the information from the external certification authority	124
Delete an SSL certificate	126
Site Usage	126
Backup	128
Manual backup	128
Scheduled backup	130
Backup file locations	132
Restore	133
Server management	135
Publishing Web pages	135

<b>5 Using Services on a Site</b>	<b>137</b>
Managing Your Personal Profile	137
Modify site user	138
Email	138
Forward email to	139
Vacation reply	139
Usage data	140
Backup	141
Restore	143
Using email on the RaQ 4	144
Developing Web pages	145
CGI scripts	145
Server-side scripting languages	145
Publishing Web pages using FTP	146
Publishing Web pages with FrontPage for User Webs only	147
Using telnet	148
<b>A Using the LCD Console</b>	<b>149</b>
Access to the functions	149
Changing network configuration	150
Configuring an uninterruptible power supply (UPS)	151
Verifying the UPS configuration	153
Rebooting	154
Powering down	155
<b>B Product Information</b>	<b>157</b>
Technical data for the RaQ 4	157
Hardware	157
Software	158
Features	158
System management	159
Partner solutions	159
Physical data	159
Regulatory approvals	160

Upgrading your RaQ 4	161
Opening the RaQ 4	161
Adding a memory module or PCI card	162
Printed circuit board	163
Adding or replacing a hard disk drive in a RaQ 4	164
Specifications for a hard disk drive	164
Requirements	165
Overview	165
Opening the RaQ 4	166
Removing a hard disk drive	169
Installing a hard disk drive	169
Connecting the hard disk drive	170
Replacing the top cover and rebooting the RaQ 4	170
<b>C Advanced Information</b>	<b>171</b>
Serial console port	171
Initializing the RaQ 4 through the serial console port	171
Development tools	173
Configuration files	174
Directory structure	175
RaQ 4 home page	175
Virtual site home page	175
Site user home page	176
Common gateway interface (CGI) usage for users	176
Scripting languages available per site	177
Active Server Pages (ASP)	177
PHP	177
<b>D Domain Name System</b>	<b>179</b>
Basic DNS	179
Enabling the DNS server feature	180
Configuring a primary DNS server	180
Specifying a reverse lookup (PTR) record	181
Specifying a mail server (MX) record	181
Specifying an alias (CNAME) record	182

Configuring a secondary DNS server	182
Adding a secondary domain	183
Adding a secondary network	183
Advanced DNS	184
Network Mask Notation Conversion	184
Delegating a subdomain	185
Delegating a subnet	186
Configuring server settings	186
Start of Authority (SOA) configuration	187
Name server (NS)	188
Domain administrator email address	188
Refresh interval	188
Retry interval	188
Expire interval	188
Time-to-live period (TTL)	188
Sample setup of DNS service	189
Create an Address (A) Record	191
Create a second Address (A) Record	192
Create a Mail Server (MX) Record	193
Brief history of the Domain Name System (DNS)	194
What is a DNS record?	195
Who manages your DNS records?	195
How does DNS work?	195
<b>E Licenses</b>	<b>197</b>
The BSD Copyright	197
GNU General Public License	198
SSL License	204
<b>F Glossary</b>	<b>205</b>
<b>Index</b>	<b>223</b>

# Introduction

---

The Cobalt RaQ™ 4 is a server appliance that provides a dedicated Web-hosting platform and offers new capabilities for high-traffic, complex Web sites and e-commerce applications.

The RaQ 4 server appliance offers a full suite of Internet services with remote administration capabilities, pre-packaged in a single rack-unit (1RU) industry-standard enclosure. The RaQ 4 is pre-configured with Apache Web server, Sendmail, File Transfer Protocol (FTP) server, Domain Name System (DNS), the Linux operating system, FrontPage Server extensions, and support for Active Server Pages (ASP), PHP and common gateway interface (CGI) scripts.

The RaQ 4 further enhances the suite of services by offering dual hard disk drives (RaQ 4r configuration) or room for an extra hard disk drive (RaQ 4i configuration); support for RAID-1 disk mirroring (RaQ 4r configuration only), a faster central processing unit (CPU), an improved Bandwidth Management interface, pre-packaged Secure Sockets Layer (SSL), enhanced backup support and comprehensive site usage reporting. The RaQ 4 also provides tight integration with partner products.

The RaQ 4 is pre-loaded with InterBase 6.0, an open-source, cross-platform SQL database from Inprise Corporation. For more information on InterBase, visit the URL <http://www.interbase.com>. Also, see “InterBase” on page 82.

Table 1 lists the differences among the RaQ 4 configurations.

The only difference between the RaQ 4i and RaQ 4r configurations is that the RaQ 4r has two hard disk drives and offers RAID-1 disk mirroring. There is room in the RaQ 4i to add an extra hard disk drive but it does not support RAID-1. You cannot add an extra hard disk drive to the base RaQ 4 configuration.

**Table 1.** RaQ 4 configurations

<b>Specification</b>	<b>RaQ 4</b>	<b>RaQ 4i</b>	<b>RaQ 4r</b>
Dual hard disk drives	No	No (room to add an additional hard disk drive)	Yes
RAID-1 support	No	No	Yes
10/100 BaseT network connectors	One	Two	Two
PCI expansion slot	No	Yes	Yes
SCSI connector	No	Yes	Yes
Support for FrontPage Server Extensions	Yes	Yes	Yes
Support for Active Server Pages (ASP)	Yes	Yes	Yes
Support for PHP	Yes	Yes	Yes
Support for SSL	Yes	Yes	Yes
Bandwidth management	Yes	Yes	Yes
InterBase 6.0 relational database	Yes	Yes	Yes



The RaQ 4 provides a complete solution for virtual site hosting, Web publishing, file transfer, email and third-party applications:

- Access to a broad range of Web and file transfer protocol (FTP) publishing capabilities. The RaQ 4 supports the common gateway interface (CGI) using Perl scripting, Active Server Pages (ASP) and PHP embedded scripting for creating interactive applications on the Web.
- Support for multiple Internet or intranet sites. You can host one or several distinct sites for separate clients or projects. The RaQ 4 provides comprehensive support for the three most popular Internet services—Web, FTP and email.
- RAID-1 disk mirroring (RaQ 4r configuration only)
- Internal and external communication through email to individuals and groups. In addition to standard individual email, the RaQ 4 email services include automatic response to messages when a user is on vacation and automatic forwarding to another email address.
- Flexible platform for the development of solutions, including the development of third-party applications.

All of these services can be used within an extranet or an intranet environment, or across the Internet.

## General

Figure 1 and Figure 2 show the RaQ 4 controls, indicators and connectors.



**Note:** The base RaQ 4 server configuration does not offer all of the hardware components shown in Figure 2.

## Front view of the RaQ 4

Figure 1. RaQ 4 front view

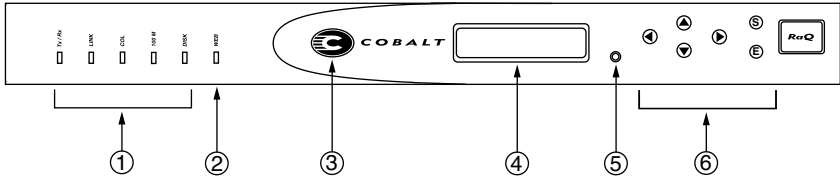

1. The **Status Indicators** signal Ethernet and hard-disk-drive activity:
  - Tx/Rx** (Transmit/Receive) blinks when there is network traffic on the primary interface.
  - Link** indicates an active network connection on the primary interface.
  - Col** blinks when a collision is detected on the primary interface.
  - 100 M** indicates that 100 BaseT ethernet is being used on the primary interface.
  - Disk** indicates activity on the hard disk drive.
2. The **Web** indicator blinks to indicate Web activity.
3. The **Logo Badge** glows when the RaQ 4 is powered on.
4. The **LCD screen** displays messages and values entered. Use the arrow buttons to toggle between choices or to enter values. (See “Using the LCD console to configure the network” on page 22.)
5. You can use the recessed **Reset Password** button if you forget the RaQ 4 Administrator password. (See “Resetting the RaQ 4 Administrator password” on page 51.)
6. The **LCD arrow buttons** allow you to enter network configuration information, configure a UPS unit, reboot the RaQ 4 and power down the RaQ 4.

## Rear view of the RaQ 4

Figure 2. RaQ 4 rear view

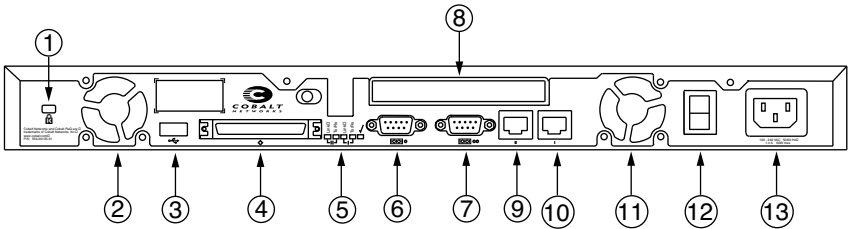

1. The **Security lock hole** is used to lock the unit to a secure location.
2. The **Cooling fans** maintain proper operating temperature. Ensure that the ventilation holes are not blocked.
3. The **USB port** provides a Universal Serial Bus connection.
4. The **SCSI connector** enables a Small Computer System Interface (SCSI) connection for connecting such devices as hard disk drives. (*optional*)
5. The **Network status indicators/OK to Power Off** signal network activity and information. The **OK to Power Off light** flashes when it is safe to turn the power off.
6. The **Serial console port** allows you to connect serial devices.
7. The **Serial connector** allows you to connect a UPS to the serial port for Smart UPS support.
8. The **PCI expansion slot** provides space for adding a PCI card. (*optional*)

The **Network connectors** enable ethernet network connections and accept the 10/100 BaseT network cables.

9. **Network connection 2.** (*optional*)
10. **Network connection 1.**
11. **Cooling fan.**
12. The **Power switch** toggles the power on or off.
13. The **Power socket** receives the AC cord that is provided.

## RaQ 4 requirements

To use the RaQ 4, you need:

- A 10BaseT, 10/100BaseTX or 100BaseTX Transmission Control Protocol/Internet Protocol (TCP/IP) -based local area network (LAN).
- A personal computer (attached to the network) that uses a Web browser (for example, Netscape Navigator, version 4.7 or later, or Microsoft Internet Explorer, version 5.0 or later).

To manage the RaQ 4 from the user interface (UI), you must enable cookies, cascading style sheets and Javascript on your browser (these features are normally enabled by default).

- Network parameters, which you can obtain from your network administrator; these include the IP address assigned to the RaQ 4, the subnet mask of your network and a gateway or router address (if communicating with other networks).

## Target audience for the RaQ 4

The user manual is for RaQ 4 Administrators who use the RaQ 4 to develop and host Web sites. RaQ 4 Administrators should be familiar with Microsoft® Windows™, Macintosh® or other operating systems, and Netscape Navigator®, Microsoft® Internet Explorer or other Web browsers.

# Levels of user

A RaQ 4 can host multiple Internet or intranet sites, which can provide Web content, email and FTP services. It can be used by three different kinds of users:

- The **RaQ 4 Administrator** is the person who controls and runs the RaQ 4. This person sets up and maintains the RaQ 4, sets up virtual sites, and sets access privileges and provides services for the Site Administrators and site users. The RaQ 4 Administrator can also act as the Site Administrator for any virtual site.



**Note:** Whereas industry uses the term “virtual host”, Cobalt Networks uses the term “virtual site”. In Cobalt’s definition, a virtual site consists of a Domain Name System (DNS) domain with Web, FTP and email services. Each virtual site contains its own list of site user accounts. Each site user account has its own Web, email spool and any number of email aliases. The fully qualified domain name of a virtual site is unique to that site, while its IP address can be shared by many sites. For more information, see “Definition of a virtual site” on page 35.

- The **Site Administrator** manages a virtual site, located on the RaQ 4, that can provide Web publishing, email and FTP services for the users of the site. The Site Administrator sets up user accounts and access privileges, maintains mailing lists, controls the settings for the virtual site and its FTP service, has access to users’ email settings, can generate reports about the virtual site’s disk and Web usage, and can back up and restore files residing on the site.
- **Site users** can send and receive email through the site, upload and download files using the FTP service provided by the site, publish their own personal Web page on the site, and back up and restore their home directories.

# Organization of the user manual

The user manual is organized according to the user interface (UI). Chapter 3, “RaQ 4 Server Management, is based on the **Server Management** screen with the brown border on the left side. See Figure 3.

Chapter 4, “Site Management, is based on the **Site Management** screen with the green border on the left side. See Figure 4.

Chapter 5, “Using Services on a Site, is based on the **Personal Profile** screen with the blue border on the left side. See Figure 5.

**Figure 3.** Server Management screen



Figure 4. Site Management screen

Site Management - test130.cobalt.com

Search User List

User Name contains search

Set User Defaults Add User

User List (1 - 12 of 12)

Full Name	User Name	Email Aliases		
Alexandra Somers	asomers	alexandra.somers	SA	⊞ ⊞ ⊞
Dr. Adrian Sun	asun	adrian.sun	SA	⊞ ⊞ ⊞
Alan Williams	awilliams	alan.williams	SA	⊞ ⊞ ⊞
Ben Eirif	beirif	ben.eirif	SA	⊞ ⊞ ⊞
Bill Lumbergh	blumbergh	bill.lumbergh, O-face	X	⊞ ⊞ ⊞
Holly Hodges	hhodges	holly.hodges	SA	⊞ ⊞ ⊞
Hailey Somers	hsomers	hailey.somers	SA	⊞ ⊞ ⊞
Jason Paetz	jpaetz	jason.paetz	SA	⊞ ⊞ ⊞
Keston Esch	kesch	keston.esch	SA	⊞ ⊞ ⊞
Kenny Levine way	klevine way	kenny.levine way	SA	⊞ ⊞ ⊞
Megan Holliday	mholliday	megan.holliday	SA	⊞ ⊞ ⊞
Tara Sevareid	tsevareid	tara.sevareid	SA	⊞ ⊞ ⊞

indicates the user is a site administrator. 
 indicates user shell access. 
 indicates a user FrontPage web. 
 indicates a user with Secure FOP? (AFOP). 
 indicates a suspended user.

Figure 5. Personal Profile screen

Personal Profile

Modify User

Full Name	Dr. Adrian Sun
User Name	asun
Password	
Password (again)	

Confirm Modify

## **List of chapters and appendices**

The manual has the following chapters and appendices.

Chapter 1, “Introduction”, summarizes the RaQ 4 functions.

Chapter 2, “Setting up the RaQ 4”, explains RaQ 4 hardware setup and the network integration information.

Chapter 3, “RaQ 4 Server Management”, discusses RaQ 4 Management functions.

Chapter 4, “Site Management”, explains Site Management functions for virtual sites.

Chapter 5, “Using Services on a Site”, shows how to use the RaQ 4 services (email, Web publishing and FTP) and how to manage your personal directory.

Appendix A, “Using the LCD Console”, explains LCD console functions.

Appendix B, “Product Information”, provides information about the RaQ 4 hardware and software, regulatory approvals, physical data and upgrading the server.

Appendix C, “Advanced Information”, provides information on development tools, configuration files, and the directory structure of the RaQ 4 disk.

Appendix D, “Domain Name System”, gives an in-depth explanation of the DNS service.

Appendix E, “Licenses”, lists licensing information.









Appendix F, “Glossary”, provides a glossary of terms used in the RaQ 4 manual.











## Icons used on the UI and in the manual

Table 2 describes the icons used on the browser-based User Interface (UI) and in this manual. If you pass the mouse pointer over an icon, a short help message appears.



**Table 2.** Icons used in the manual and UI

Icon	Description
	<p><b>Web Server</b></p> <p>Only in the Service Settings table of Control Panel on the <b>Management Screen</b>. Web Server is always on.</p>
	<p><b>Simple Network Management Protocol (SNMP)</b></p> <p>Only in the Service Settings table of Control Panel on the <b>Management Screen</b>.</p>
	<p><b>Legato/Arkeia file backup</b></p> <p>Only in the Service Settings table of Control Panel on the <b>Management Screen</b>.</p>
	<p><b>Domain Name System (DNS)</b></p> <p>Only in the Service Settings table of Control Panel on the <b>Management Screen</b>.</p>
	<p><b>FrontPage Server extensions</b></p> <p>In the Virtual Sites List on the <b>Server Management</b> screen; indicates that FrontPage server extensions are enabled on the virtual site.</p>
	<p><b>Active Server Page (ASP)</b></p> <p>In the Virtual Sites List on the <b>Server Management</b> screen; indicates that Active Server Pages are enabled on the virtual site.</p>
	<p><b>PHP Embedded Scripting</b></p> <p>In the Virtual Sites List on the <b>Server Management</b> screen; indicates that PHP embedded scripting is enabled on the virtual site.</p>
	<p><b>Telnet</b></p> <p>In the Virtual Sites List on the <b>Server Management</b> screen; indicates that telnet is enabled on the virtual site.</p>

**Table 2.** Icons used in the manual and UI

Icon	Description
	<p><b>Bandwidth limit</b></p> <p>In the Virtual Sites List on the <b>Server Management</b> screen; indicates that a bandwidth limit is enabled on the virtual site.</p>
	<p><b>Secure POP3 (APOP)</b></p> <p>In the Virtual Sites List on the <b>Server Management</b> screen; indicates that Secure POP3 is enabled on the virtual site.</p>
	<p><b>Secure Sockets Layer (SSL)</b></p> <p>In the Virtual Sites List on the <b>Server Management</b> screen; indicates that SSL is enabled on the virtual site.</p>
	<p><b>Anonymous file transfer protocol (FTP)</b></p> <p>In the Virtual Sites List on the <b>Server Management</b> screen; indicates that Anonymous FTP is enabled on the virtual site.</p>
	<p><b>Modify</b></p> <p>In the Virtual Sites List on the <b>Server Management</b> screen; used to modify the settings for a virtual site.</p>
	<p><b>Modify</b></p> <p>In the Bandwidth Limits table on the <b>Server Management</b> screen; used to modify a bandwidth limit for an IP address.</p> <p>In the Users List on the <b>Site Management</b> screen; used to modify the settings for a site user.</p>
	<p><b>Delete</b></p> <p>In the Virtual Sites List on the <b>Server Management</b> screen; used to delete a virtual site from a RaQ 4.</p> <p>In the Bandwidth Limits table on the <b>Server Management</b> screen; used to delete a bandwidth limit for an IP address.</p> <p>In the Users List on the <b>Site Management</b> screen; used to delete a site user from a virtual site.</p>
	<p><b>Email</b></p> <p>In the Users List on the <b>Site Management</b> screen; used to modify the email settings for a site user.</p>

**Table 2.** Icons used in the manual and UI

Icon	Description
	<p><b>Site Administrator</b></p> <p>In the Users List on the <b>Site Management</b> screen; indicates that the user is the Site Administrator for the virtual site.</p>
	<p><b>Suspension</b></p> <p>In the Virtual Sites List on the <b>Server Management</b> screen; indicates that a virtual site has been suspended by the RaQ 4 Administrator.</p> <p>In the Users List on the <b>Site Management</b> screen; indicates that a user has been suspended by the Site Administrator.</p>

## Customer Service and Technical Support

For Cobalt product information, visit the support section of the Cobalt Web site at <http://www.cobalt.com/support/>. The site includes a Knowledge Base that customers can query; a list of Frequently Asked Questions (FAQs) that provide additional information is also available through the Knowledge Base.

### General Cobalt information

In the U.S.A., call (888) 70-COBALT or (888) 702-6225, or send email to [info@cobalt.com](mailto:info@cobalt.com).

Outside the U.S.A., call +1 650 623-2500, or send email to [info@cobalt.com](mailto:info@cobalt.com).

In Europe, the Middle East and Africa, call +31 71 565 7000 (The Netherlands), or send email to [info-emea@cobalt.com](mailto:info-emea@cobalt.com).

In Japan, send email to [info-japan@cobalt.com](mailto:info-japan@cobalt.com).

## **Cobalt Technical Support and Service**

### **Email contact**

You can contact Cobalt Networks Technical Support by email using the Online Email Support Form. This form provides us all the information we need to service your request in a timely fashion.

Go to the URL <http://www.cobalt.com/support/> and click on the **Contact Support** link.

### **Technical Support telephone numbers**

In the United States, call (800) 266-4378.

In Europe, Middle East and Africa, call +31 (71) 565-7070 (The Netherlands).

Customers in Japan can send email to [support-japan@cobalt.com](mailto:support-japan@cobalt.com).

## **Further resources and information**

Cobalt also offers the following additional resources and information.

### **Solutions**

For business-case information concerning Cobalt products or for solutions that extend the functionality of our products, visit the Online Solutions Directory on Cobalt's Web site at <http://www.cobalt.com/solutions/>.

### **Cobalt Developer Network**

Cobalt provides a wide range of resources, such as technical notes and white papers, for developers of Linux applications for Cobalt platforms. Premium resources are also available.

To register with the Cobalt Developer Network at no cost, visit the Web site at <http://developer.cobalt.com/>.

## **Discussion Groups**

Cobalt has made available a number of discussion groups through which users can share information.

You can view the current list of Cobalt discussion groups at <http://www.cobalt.com/support/resources/usergroups.html>. The names of the discussion groups show up as hypertext links.

To subscribe to or unsubscribe from a discussion group, or to view previous postings to a group, click on the group name. A new browser window opens, displaying information about the discussion group.

New discussion groups are added periodically. The current groups include:

- an announcement list concerning Cobalt products
- an information list for developers working on Cobalt products
- a user list for sharing information between users of Cobalt products
- a security list for users to address network security issues on Cobalt products

## **The Knowledge Base**

Cobalt offers access to its online database of common installation and configuration problems and solutions. You can access the site at <http://www.cobalt.com/support/kb/>.

## **Online technical papers**

For in-depth technical information, there are a number of technical papers available on Cobalt Networks' Web site at <http://www.cobalt.com/support/>.

## **Education**

For those who desire a premium level of technical expertise with Cobalt Networks products, we offer a number of training courses. The intended audience includes end users, Cobalt resellers, system and network administrators, systems engineers, product developers, support technicians, consultants and trainers. You can access the site at <http://www.cobalt.com/support/education/index.html/>.

# Before contacting Cobalt Networks Technical Support



**Note:** To receive Technical Support, you must first register your Cobalt product.

First, make an effort to resolve the problem on your own. Take note of all actions you perform and any error messages so that, if necessary, you can describe them to a member of the Technical Support team.

Refer to the user manual and to the Web-based resources such as Cobalt's Knowledge Base, the online technical papers and the Solutions page, as described above.

## To speed up your support call

When contacting Cobalt Networks Technical Support, the more information you can provide, the better. Before you call or email, have the following information ready.

- the serial number, located on the back panel, or the MAC address of the primary network interface, accessible through the user interface, of your RaQ 4 server.
- any additional software installed on your system
- any peripherals connected to your system
- any error messages you have received and the time when they occurred
- the process you were running or the changes you had made when the error occurred
- the steps you have taken to resolve the problem

## Support tools feature

The Support Tools feature is a Web page that assists Technical Support in diagnosing problems on a RaQ 4 unit.

On the **Server Diagnostics** screen, the RaQ 4 Administrator can create and download a data dump of the configuration files on the RaQ 4. This data dump can then be emailed to **diagnostics@cobalt.com**. A member of the Technical Support team can evaluate the condition of your RaQ 4 before providing you with corrective action, either by telephone or email.

If the RaQ 4 Administrator is familiar with Linux, he or she can look through this file in an effort to determine the problem with the RaQ 4. The file is a standard gzip file.

For more information on the Support Tools feature, see “Support tools” on page 86.

## Cobalt logo badge



For more information on the RaQ 4 server, click on the Cobalt Networks logo badge in the top left corner.

- the amount of RAM
- the size of the hard disk
- the version of the Cobalt OS
- Cobalt Networks trademark information

The table also contains four hypertext links:

- **About The Product** displays the services available on the RaQ 4 server, links to Cobalt Networks Technical Support and a link to the Solutions guide.
- **Cobalt Networks, Inc. Web site** takes you to the URL <http://www.cobalt.com>.
- **Credits and Acknowledgements** acknowledges the software used on the RaQ 4.
- **Diagnostic Information** contains a form used generate and download a diagnostics file which can assist Cobalt Technical Support in diagnosing problems with a RaQ 3 server.





# Setting up the RaQ 4

---

This chapter guides you through the process of connecting and configuring the RaQ 4 for your network. A typical setup process takes less than 15 minutes, after which you can begin setting up Web sites and using other RaQ 4 services.

If the RaQ 4 has been previously configured for a different network, refer to “Changing network configuration” on page 150.

The setup process consists of two phases.

- “Phase 1: Making the connection” covers the physical setup and connection of the RaQ 4 to a power source and the network.
- “Phase 2: Setting up with the Web browser” covers the network integration process and allows the administrator to select services and create users and groups, using any browser-enabled computer.

## Phase 1: Making the connection

### Installing the RaQ 4

The RaQ 4 can either be placed on a flat surface—for example, a desk, shelf or table top—or it can be connected to a standard 19-inch equipment rack.



**Caution:** If you operate the RaQ 4 in an equipment rack, see the precautions described in “5. Operating the unit in an equipment rack” on page iv.

If you plan to use the RaQ 4 on a flat surface, attach the rubber feet to the five indentations in the bottom of the case; see Figure 6.

**Figure 6.** Rubber feet for the RaQ 4

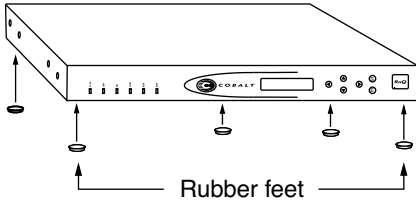

If you plan to operate the RaQ 4 in an equipment rack, first connect the mounting ears to the sides of the RaQ 4 (see Figure 7), near either the front or the rear of the case. Attach the ears to the equipment rack.

**Figure 7.** Mounting ears for the RaQ 4

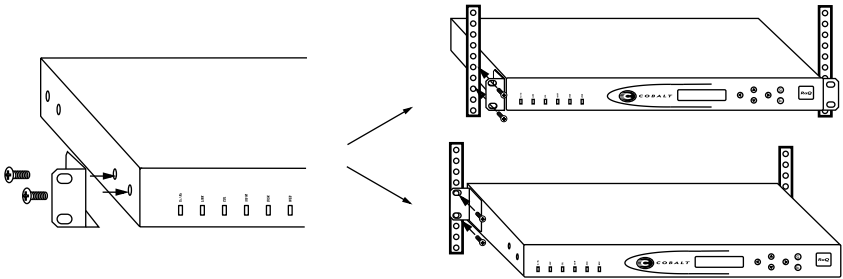

## Connecting to the network

Connect one end of a Category 5 Ethernet cable to the 10/100 Base-T Network 1 connector on the RaQ 4; see Figure 8. Connect the other end of the cable to an existing network socket.

**Figure 8.** Network connectors

Raq 4i / RaQ 4r configurations

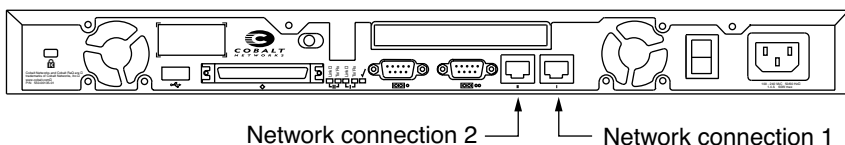

Raq 4 configuration

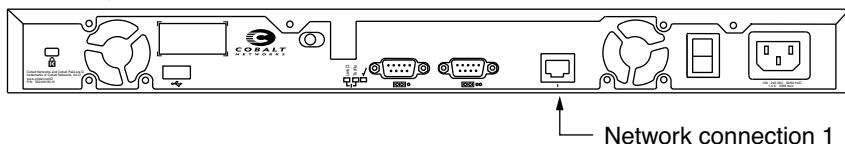

## Connecting the power cord

Connect the power supply cord to the RaQ 4 and to an electrical outlet (100-240 volts AC, 50/60 Hz, as listed in “Physical data” on page 159).

## Powering on the RaQ 4

Turn on the power by pressing the **On/Off** switch on the back of the RaQ 4.

The hard disk drive spins up, the fan turns on, and the LCD screen lights up. The Cobalt logo and the Cobalt Networks name scroll across the screen.

A number of status messages are displayed on the LCD screen as the RaQ 4 completes its boot process.



**Caution:** It is important to follow the proper power-down procedure before turning off the RaQ 4. Refer to “Powering down” on page 155.

## Configuring the RaQ 4 for the network

Now that you have made the network and power connections, you can configure the network settings.

The RaQ 4 requires specific network information to function properly. You must enter the necessary information using the LCD console on the front panel.

Before you proceed, make sure you have the following information:

- the IP address assigned to the RaQ 4
- the subnet mask of your network
- the gateway/router address (necessary only if communicating with other networks)

### Using the LCD console to configure the network

You can initialize a RaQ 4 through the serial console port rather than through the LCD console. For more information, see “Initializing the RaQ 4 through the serial console port” on page 171.

Figure 9 shows the LCD console for the RaQ 4.

The LCD screen on the front of the RaQ 4 displays two lines of text. The top line of the LCD presents instructions on data to enter; the bottom line displays the data already entered. Use the arrow buttons to the right of the LCD screen to enter the required network information manually.

Appendix A, “Using the LCD Console”, provides more information about the LCD console.

**Figure 9.** LCD console

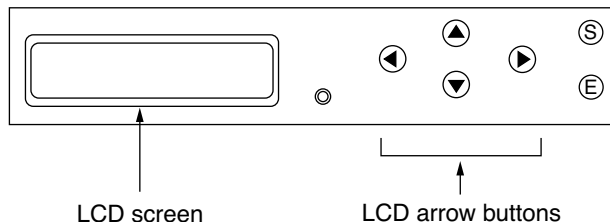

The arrow buttons function as follows:

- ◀ The **Left** arrow button moves the cursor to the left.
- ▶ The **Right** arrow button moves the cursor to the right.
- ▲ The **Up** arrow button increases the digit located at the cursor position.
- ▼ The **Down** arrow button decreases the digit located at the cursor position.
- Ⓢ The **S** button (“select”) displays the next option.
- Ⓔ The **E** button (“enter”) accepts the information entered or the option displayed.

## Setting the configuration

During setup, the LCD console is used to enter network configuration information on the RaQ 4.

Follow these steps to configure the network manually:

1. When you see the prompt

```
ENTER IP ADDR:  
000.000.000.000
```

enter the IP address assigned to the RaQ 4 using the arrow buttons on the LCD console.

2. Press **Ⓔ**.

If the IP address is valid, the next prompt appears:

```
ENTER NETMASK:  
255.000.000.000
```

3. Enter the netmask of your network.
4. Press **Ⓔ**.

If the netmask is valid, the following prompt appears:

```
ENTER GATEWAY:  
000.000.000.000
```

5. Enter the IP address of the gateway for your network.

If your network does not have a gateway, do not enter a number—leave the default value, “000.000.000.000.”

6. Press **(E)**.

The LCD displays:

[S]AVE [C]ANCEL

7. To save the configuration information, use the left and right arrow buttons to select [S]ave, and then press **(E)**. You will see:

VERIFYING AND SAVING



**Note:** Selecting [C]ancel cancels the configuration and the LCD screen displays ENTER IP ADDR: again. You must go through the entry process again.

After verifying and saving, the RaQ 4 completes the boot process. The LCD screen shows several messages before displaying the IP address assigned to the RaQ 4.

Configuration is complete when the LCD screen displays the IP address assigned to the RaQ 4, for example:

IP ADDRESS:  
192.168.25.77

## Phase 2: Setting up with the Web browser

The remainder of the setup process is performed through a Web browser on any computer on your network. Use one of the standard browsers available (for example, Netscape Navigator or Microsoft Internet Explorer, versions 4.0 or later) to do this. Once the setup process is complete, the RaQ 4 can be managed from any computer on the network that has a browser.

To use a browser to set up the RaQ 4, follow these steps:

1. Launch a standard Web browser on any computer connected to the network.
2. Enter the IP address of the RaQ 4 (shown on the LCD screen on the front panel) into the URL field of your browser—for example:

Location:

3. Press **Return** (or **Enter**) on your keyboard.

If the RaQ 4's network settings were configured successfully, then the Cobalt welcome screen appears; see Figure 10.

Click the **Start** button to begin using the Setup Wizard.

**Figure 10.** RaQ 4 Welcome screen

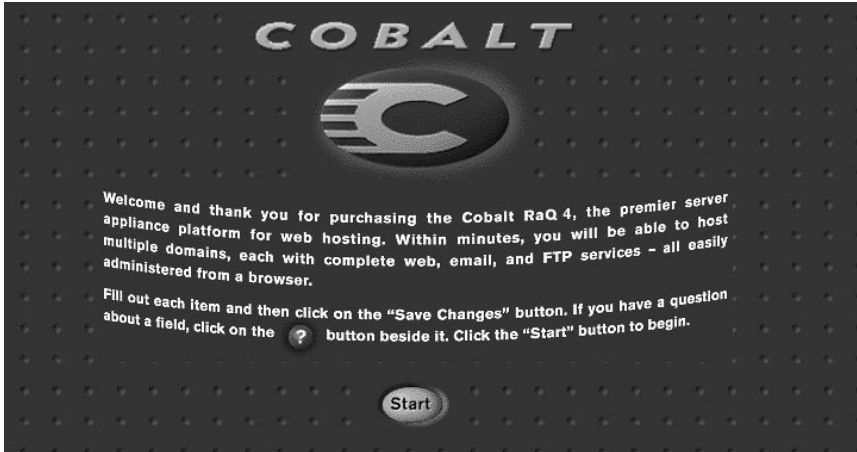

## Configuring the RaQ 4 with the Setup Wizard

To configure the RaQ 4, enter information into the fields on the **Setup Wizard** screen (see Figure 11). These fields are described in the sections that follow.



**Note:** For help with a particular field in the Setup Wizard, move the pointer over the Active Assist  icon adjacent to the field and help text is displayed at the bottom of the screen.

Figure 11. Setup Wizard (part 1 of 2)

The screenshot shows the 'Setup Wizard' window with two sections: 'Network Settings' and 'Administrator Settings'. Each row in the tables has a question mark icon in the first column, a label in the second, and a value or input field in the third.

Network Settings		
?	Host Name	<input type="text"/>
?	Domain Name	<input type="text"/>
?	Primary DNS Server Address	<input type="text"/>
?	Secondary DNS Server Address (optional)	<input type="text"/>
?	IP Address	10.9.19.65
?	Subnet Mask	255.255.0.0
?	Default Gateway	10.9.25.254
?	MAC Address	00:10:E0:00:06:8A

Administrator Settings		
?	Administrator User Name	admin
?	Administrator Password	<input type="password"/>
?	Administrator Password (again)	<input type="password"/>

## Entering the network settings

**Host name (Cobalt server name).** Assign a host name (for example, raq4) to the RaQ 4.

**Domain name.** Enter your domain name. The domain name is either the official domain name that is registered with an ICANN-accredited registrar (for example, “mydomain.com”) or an intranet domain name specific to your network. This allows you to access your RaQ 4 by host name and domain name, rather than by IP address only.

Coordinate the host name and domain name with your Internet service provider (ISP) or the person in charge of your DNS infrastructure to ensure the integrity of your network. If your RaQ 4 is integrated into a larger network, consult with your network administrator for this information.

As the RaQ 4 Administrator, you can change the domain name on the RaQ 4 server later on through the browser-based UI; see “Network” on page 64.

**Primary DNS Server Address.** Enter the IP address of your primary domain name system (DNS) server. A primary DNS server maintains a list of computer names and their IP addresses. The RaQ 4 needs access to this list on the primary DNS server in order to convert between IP addresses and names. This conversion is essential for sending and receiving email external to the RaQ 4.

**Secondary DNS Server Address.** This is the IP address of your secondary DNS server. A secondary DNS server can provide redundant DNS service to your computers. If the primary DNS server is turned off, then your RaQ 4 can use the secondary DNS server.



For informational purposes, this table also displays the IP address of the RaQ 4, the subnet mask of your network, your configured gateway and the Media Access Control (MAC) address that uniquely identifies this RaQ 4. These settings, with the exception of the MAC address, can be changed later from the Control Panel section of the **Server Management** screen.

## Entering the administrator settings

In the Administrator Settings table, enter the information about the RaQ 4 Administrator. The RaQ 4 Administrator has several responsibilities:

1. Setting up and maintaining the RaQ 4, virtual sites, virtual Site Administrators, site users and services
2. Responding to RaQ 4 email alerts to prevent potential problems

To set up the RaQ 4 Administrator, you must enter a password in the Administrator Password field and then enter the same value again in the second Administrator Password field.

### Password guidelines

The RaQ 4 supports long passwords through the user interface (UI). Passwords were previously limited to 8 characters.

Use the following guidelines when choosing a password:

1. The valid characters include: a-z A-Z 0-9 % ! @ \$ ^ & \* - \_ = + \ | . , / ? ; :
2. Use both upper- and lower-case letters.



**Note:** A password is case-sensitive.

3. Do not use a proper name.
4. Do not use a word found in a dictionary.
5. Do not use a date.
6. Do not use a command word.
7. Do not use a string of consecutive keys on a keyboard (for example, “qwerty”).

Be sure to remember this password to access the RaQ 4’s management administration features in the future. If you forget or want to reset the password, see “Resetting the RaQ 4 Administrator password” on page 51.

## Entering the service settings

You turn the RaQ 4 services on or off through the Service Settings table. See Figure 12. The default settings for these services are suitable for most users. These services include:

- Email server (default is On)
- File transfer protocol (FTP) server (default is On)
- Telnet server (default is On)
- Simple Network Management Protocol (SNMP) agent (default is Off)
- Domain Name System (DNS) server (default is Off)

Figure 12. Setup Wizard (Part 2 of 2)

The screenshot shows the 'Setup Wizard' interface. At the top, there is a 'Service Settings' section with a table of services. Below that is a 'Time Settings' section with various configuration options.

Service Settings	
<input type="checkbox"/>	Web Server(Always on)
<input checked="" type="checkbox"/>	Email Server
<input checked="" type="checkbox"/>	File Transfer Protocol (FTP) Server
<input checked="" type="checkbox"/>	Telnet Server
<input type="checkbox"/>	Simple Network Management Protocol (SNMP) Agent
<input type="checkbox"/>	Domain Name System (DNS) Server

Time Settings	
Time	Jun 26 2000 1pm 47
Time Zone	Region: Europe, Indian Ocean, North America
	Country: Turks and Caicos Islands, Trinidad and Tobago, United States
	Locale/Zone: Hawaii, Alaskan Time, Pacific Time

Save Changes

After setup has been completed, the Services page in the Control Panel has a “Parameters” column which enables further configuration. Refer to “Control panel” on page 52 for additional information.

## Entering the time settings

In the Time Settings table, select the time and date with the pull-down menus. See Figure 12.

Select the correct time zone by clicking in the Region, Country and Locale/Zone fields.

## Completing configuration with the Setup Wizard

When you have entered the information in the Setup Wizard, click **Save Changes**.

The RaQ 4 performs automatic checks on the information entered and alerts you if an illegal value or a problem is encountered. If the information is correct, the RaQ 4 enters the information in its configuration files.

## Registering the RaQ 4 online

The RaQ 4 displays an online product registration page; see Figure 13.



**Important:** If you leave blank either the DNS or the Gateway fields in the Setup Wizard, you cannot register the RaQ 4 online because you will not be able to send email. In this case, if you attempt to register the RaQ 4 online, you receive an error message, stating that you cannot register online because you did not fill in the DNS and Gateway fields.



**Note:** If you are not connected to the Internet, you cannot register online.

Figure 13. Online registration page

If you wish to register this product, please complete the form below and click on the "Register Through Email" button to email the information to us. Cobalt will maintain the privacy of this information, and only use it to notify you about system updates, new product information, and product promotions.

\*Fields with an asterisk are required. Either a fax number or an email address is required.

Registration	
Full Name*	<input type="text"/>
Title	<input type="text"/>
Company Name	<input type="text"/>
Full Address	<div style="border: 1px solid black; height: 40px; width: 100%;"></div>
Country	<input type="text"/>
Phone	<input type="text"/>
Fax*	<input type="text"/>
Email*	<input type="text"/>

To register the RaQ 4 online:

1. Enter your **Full Name**. This field must be filled in.
2. As an option, you can enter your title, the company name, the company address, the country and the phone number.
3. Enter either a **Fax** number or **Email** address. One of these two fields must be filled in. If you choose email, enter your complete email address in the form myname@myhost.mydomain.
4. Click **Register through Email** to submit the information.

If you do not want to register online, click **Register Later** to proceed to the RaQ 4 default home page.

Once you have registered the RaQ 4 online, you cannot register again. You receive an error window stating that the RaQ 4 has already been registered.

## Registering online at a later time

If you want to register online at a later time:

1. Click the Cobalt logo in the top left corner of the screen. The Server Configuration Information table appears.
2. Click the **About The Product** link. The default home page for the RaQ 4 appears.
3. In the bottom right corner, click the link under **Product Registration**. The **Product Registration** screen appears.
4. Follow the steps in the previous procedure to register online.

The default home page for the RaQ 4 appears; see Figure 14.

**Figure 14.** Default RaQ 4 home page

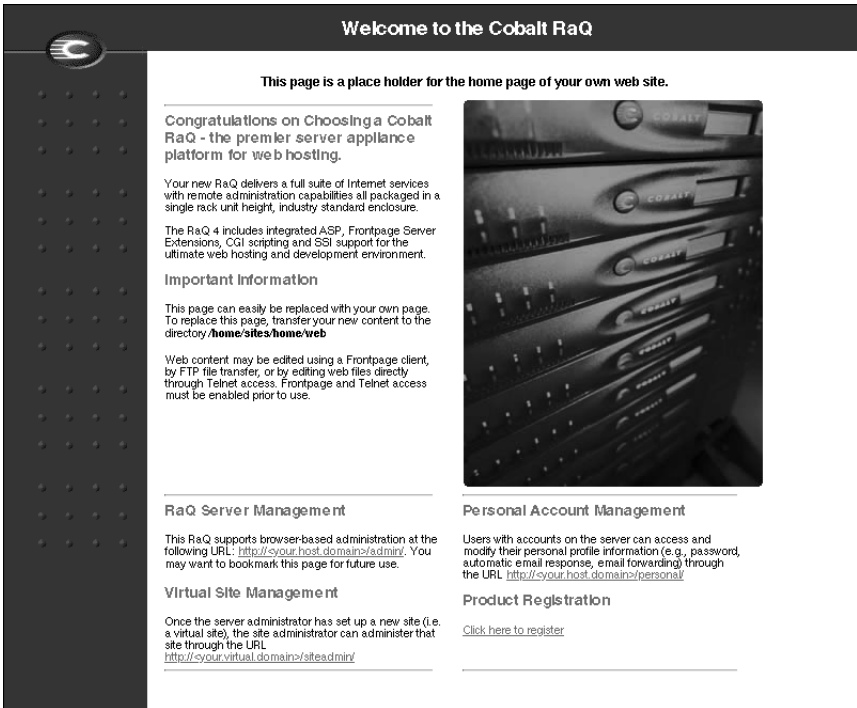

The default RaQ 4 home page is stored internally under `index.html` in the Linux directory `/home/sites/home/web`. This page appears when a user goes to the URL `http://<IP address>/`.

When the RaQ 4 Administrator changes the `index.html` file to create a new home page, the default RaQ 4 home page is replaced.

## **Registering the RaQ 4**

If you did not register the RaQ 4 online, fill out the registration card included in the packaging materials and return it to Cobalt Networks, Inc. By doing so, you will receive notifications of system and security upgrades and new product information.

If you did not register online through the Setup Wizard and would like to do so, see “Registering online at a later time” on page 31.

# RaQ 4 Server Management

---

This chapter describes the functions that the RaQ 4 Administrator normally performs. As the RaQ 4 Administrator, you access these functions on the **Server Management** screen on the RaQ 4. The **Server Management** screen has a brown strip on the left side.

You can also perform site-related tasks and user tasks described in Chapter 4, “Site Management” and Chapter 5, “Using Services on a Site”.

Table 3 briefly summarizes the three types of RaQ 4 users:

**Table 3.** Levels of user

User	Description
RaQ 4 Administrator	The RaQ 4 owner with the username <i>admin</i> has full control of the RaQ 4 and is a member of the main site (which uses the IP address shown on the LCD screen of the RaQ 4). The RaQ 4 can have several Site Administrators, but only one RaQ 4 Administrator
Site Administrator	The Site Administrator is designated by the RaQ 4 Administrator. The Site Administrator is a user who runs a virtual site located on the RaQ 4; the virtual site can provide Web publishing, email and FTP services for the users of the site. The Site Administrator has control only over this virtual site
Site User	Site Users are added to a virtual site by the RaQ 4 Administrator or a Site Administrator. Site Users can send and receive email through the virtual site, upload and download files using the FTP service provided by the site, publish their own personal Web page on the site, and back up and restore their home directories. The Site User has control only over the files located in his or her home directory on the RaQ 4.

## Approaches to RaQ 4 administration

As the RaQ 4 Administrator, you can decide how many of the server functions you want to manage directly and how much to delegate.

- **Full control.** If you want to control all the functions on the RaQ 4, you can create virtual sites without assigning any virtual Site Administrators. You are responsible for managing the main site and all the virtual sites. (See “Definition of a virtual site” on page 35.)
- **Hybrid control.** If you want to control some of the RaQ 4 functions and delegate others, you can assign some of the virtual sites to virtual Site Administrators (for the sites that have a user capable of acting as a Site Administrator), and retain control of other virtual sites. You are responsible for managing only the sites that do not have a Site Administrator.
- **Distributed control.** If you want to delegate responsibility for all the virtual sites, you can create Site Administrators for all the virtual sites. In this case, you are responsible for managing only server settings and virtual site services. The Site Administrators are responsible for managing the virtual sites.

You can manage the RaQ 4 through a Web browser. Access the **Server Management** screen by typing either `http://<IP address> /admin/` or `http://<hostname.domainname> /admin/` into your browser. These Web pages are password-protected—you must enter the RaQ 4 Administrator password.

When you access the RaQ 4 Administrator site for the RaQ 4, the **Server Management** screen appears (see Figure 15). This screen is used for the RaQ 4 management tasks that are performed only by the RaQ 4 Administrator:

1. Setting up and maintaining the RaQ 4.
2. Creating virtual sites.
3. Creating access privileges and providing services for the Site Administrators and site users.

The RaQ 4 Administrator functions available on the **Server Management** screen are described in the sections that follow.



## Definition of a virtual site

Whereas industry uses the term *virtual host*, Cobalt Networks uses the term *virtual site*.

In Cobalt's definition, a virtual site consists of a Domain Name System (DNS) domain with Web, FTP and email services. Each virtual site contains its own list of site-user accounts. Each site-user account has its own Web page, FTP directory, email spool and any number of email aliases. The fully qualified domain name of a virtual site is unique to that site, while its IP address can be shared by many sites.

With the advent of name-based virtual hosting, it is no longer necessary to dedicate an IP address to a virtual site. The Web server can now differentiate among target virtual sites according to the name requested. Many virtual sites on the RaQ 4 can share one IP address. Not all services are compatible with name-based virtual hosting: SSL encryption for Web data, bandwidth management and an anonymous FTP account can only be enabled on one name-based virtual site per IP address hosted by the RaQ 4.

The IP address of the RaQ 4 can be shared by many virtual sites or it can be unique to one virtual site.

The RaQ 4 has one main site (which cannot be deleted) and virtual sites. The main site uses the IP address assigned to the RaQ 4 using the LCD console.

On the **Server Management** screen, the main site is listed in the Virtual Sites List table; the trashcan icon in the fourth column for the main site is grayed-out (disabled), as this site cannot be deleted from the list of virtual sites. The options and features available on a virtual site can also be configured for the main site.

## Support for RAID-1 (RaQ 4r configuration only)

A redundant array of independent disks (RAID) is a way of storing the same data in different places (thus, redundantly) on multiple hard disk drives. A RAID appears to the operating system to be a single virtual hard disk drive.

Redundancy means that there is protection against the failure of any single hard disk drive. Redundant data is used by a RAID system in the event of a failure; this redundant data can either be a mirror copy or parity data used to reconstruct the actual data.

There are a variety of different types and implementations of RAID, each with its own advantages and disadvantages. The RaQ 4r implements RAID Level 1 (RAID-1), also known as disk mirroring, which consists of a primary hard disk drive and a secondary hard disk drive; the secondary hard disk drive is an exact copy or “mirror image” of the primary hard disk drive.

Although RAID can protect your data in case of a hard-disk-drive failure, it does not protect against operator and administrator (human) error, or against loss due to programming bugs.

The RaQ 4 server implements RAID services through software. Each hard disk drive has its own independent master channel to allow high performance without extra RAID hardware.

You do not need to enable RAID-1 on the RaQ 4r; it is enabled by default. You cannot disable RAID-1 on the RaQ 4r.

There are two possible causes for RAID failure on the RaQ 4r:

- **Hardware failure.** If a hard disk drive fails, the RaQ 4r can function with one hard disk drive, but the server can no longer provide disk mirroring. To restore RAID service, you must shut down the RaQ 4 and replace the failed hard disk drive.
- **Software failure.** The RAID software should not fail. If it does, the likely cause is a failure of the whole kernel, in which case the RaQ 4r just reboots.

In case of a failed hard disk drive, you will have to replace the hard disk drive. For more information on replacing a hard disk drive, see “Upgrading your RaQ 4” on page 161.

For a failed drive, Active Monitor indicates that the Left or Right hard disk drive has failed (“Right” and “Left” are in relation to looking at server with the front blue panel facing you.)

If RAID fails on the RaQ 4r, the system indicates the non-RAID status in three ways:

- An email is sent to the RaQ 4 Administrator.
- Active Monitor blinks red on the **Server Management** screen.
- On the **Server Management** screen, under **System Status**, the Disk Integrity (RAID) circle changes to red.

Once you replace a failed drive on a RaQ 4r and reboot the server, the system detects the new hard disk drive. It then automatically begins to synchronize the new hard disk drive to the existing hard disk drive so that the server will be able to provide disk mirroring.



*Note:* During the synchronization process, the RaQ 4r cannot provide disk mirroring but it can still serve requests.

## Site management

The RaQ 4 is designed to host multiple virtual sites. A virtual site is an individual location on the Internet, such as [www.abc.com](http://www.abc.com) or [www.xyz.com](http://www.xyz.com). Each virtual site can have a unique set of users who can send and receive email, publish Web pages, or upload and download files through FTP. A virtual site can also provide anonymous FTP access.



*Note:* A virtual site can be name-based or IP-based. If there are several name-based virtual sites on an IP address, only one name-based virtual site can use anonymous FTP.

The RaQ 4 server can host a large number of IP-based virtual sites. The number of sites depends on the amount of hard-disk-drive space available on the server, the amount of hard-disk-drive space allocated for each site, the amount of traffic generated on each site and the amount and complexity of the dynamic Web content on each site (for example, ASP, CGI, PHP and others). Dynamic Web content on an individual site induces a much heavier load on the server than does static content.

In the Site Management section of the **Server Management** screen, the RaQ 4 Administrator can create and manage virtual sites hosted by the RaQ 4. A table displays the virtual sites (if there are any) on the RaQ 4. See Figure 15.

Figure 15. List of virtual sites in the Site Management section

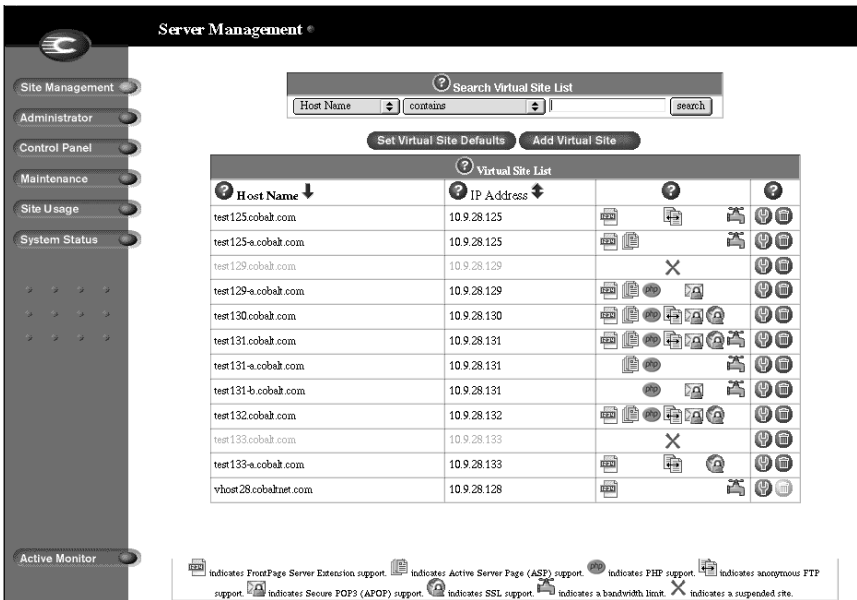

In the Site Management section, the Virtual Site List displays the virtual sites by host name in ascending order.

The Virtual Site List has four columns which display information about the site, and allow the RaQ 4 Administrator to manage or remove a site.

- The first column displays the host name of the virtual site.
- The second column displays the IP address of the virtual site.
- The third column displays icons to indicate which services (FrontPage Server extensions, Anonymous FTP, Secure POP3 [APOP], SSL or Bandwidth Limit) are enabled on a site, or to indicate that a site is suspended.
- The fourth column displays icons to manage a site or to remove a site.



**Note:** The trashcan icon for the main site on the RaQ 4 is grayed-out (disabled), as this site cannot be deleted from the list of virtual sites.

For an explanation of the icons, see “Icons used on the UI and in the manual” on page 11.

## Search and sort functions

The Virtual Site List table offers a search function and a sort function; see Figure 15. These functions are useful if you have a large number of virtual sites on your RaQ 4 and you want to restrict the display to certain virtual sites.

You can search the list of virtual sites according to the following criteria:

- by host name or IP address
- whether the host name or IP address is equal to the search string, is contained in the search string or is not contained in the search string

The screen regenerates and the results of the search are displayed in a table with the same four columns. The heading of the table now states “Search Results (<x> Virtual Sites found). To return to the full list of virtual sites, click **Site Management** on the left.



*Note:* Suspended sites are listed in the search results.

You can sort the list of virtual sites according to the following criteria:

- by host name, in ascending or descending order
- by IP address, in ascending or descending order

Ascending order means from lowest value to the highest value (a–z or 1–9). Descending order means from highest value to the lowest value (z–a or 9–1). By default, the Virtual Site List table is sorted by host name in ascending order.

The screen regenerates and the results are displayed in a table with the same four columns. In the heading of the column which has been sorted, a blue arrow icon points up (ascending order) or down (descending order). In the heading of the column which has not been sorted, a double-ended arrow indicates that the order for the column is random.

You can use the search and sort functions together to produce the display that you need. For example, you can search the list for all virtual sites with “test” in the host name, and sort the results of that search by IP address in ascending order.

## Searching a list of virtual sites

To search the list of virtual sites:

1. In the first field of the Search Virtual Site List window, select “Host Name” or “IP Address” from the pull-down menu.
2. In the second field, select “is”, “contains” or “does not contain” from the pull-down menu.
3. In the third field, enter the string of characters for which you want to search.
4. Click **Search**. The screen regenerates and displays the results in a table with the same four columns.

## Sorting a list of virtual sites

To sort the list of virtual sites:

1. To sort according to Host Name, click on the blue arrow icon in the heading of the Host Name column. To sort according to IP Address, click on the blue arrow icon in the heading of the IP Address column.
2. To sort in ascending (up arrow icon) or descending order (down arrow icon), click on the blue arrow icon so that it points in the correct direction.
3. The screen regenerates and displays the results in a table with the same four columns.

## Overview of virtual sites

The RaQ 4 supports both name-based and IP-based virtual hosting.

The RaQ 4 Administrator sets up the virtual sites, as described in “Adding a virtual site” on page 47. The following list of information is helpful when creating a site.

- **IP Address** To use the RaQ 4, you require an IP address or range of IP addresses.



**Note:** The RaQ 4 supports name-based virtual sites allowing many sites to share a single IP address. The RaQ 4 Administrator can create many virtual sites using the same IP address (for example, 192.168.25.77) with a different host name for each site (for example, both www.abc.com and www.xyz.com can use 192.168.25.77 as their IP address).

- **Host name** Each virtual site requires a host name (for example, www or ftp). If the site is connected to the Internet, you must know which IP address the host name uses.
- **Domain name** Each virtual site also requires a domain name (for example, abc.com or xyz.com).

You must also register the domain name. Visit the Internet Corporation for Assigned Names and Numbers (ICANN) at <http://www.icann.org>, for a list of accredited domain-name registrars.



**Note:** The RaQ 4 can serve as the DNS server and provide the host name.

- **Web server aliases** You can add aliases for Web servers; you are not restricted to receiving Web requests only on the domain entered in the site settings.

For the virtual site, enter additional host names or domain names for which to accept Web requests. For example, enter the aliases domain.com and www.domain.com.

Separate multiple entries with a comma.



**Note:** You must configure the Domain Name System (DNS) records to resolve the alias addresses in addition to the virtual site name.

- **Email server aliases** You can add aliases for email servers; you are not restricted to receiving email messages only on the domain entered in the site settings.

For the virtual site, enter additional host names or domain names for which to accept email connections (on SMTP port 25). For example, enter the aliases domain.com and mail.domain.com.

Separate multiple entries with a comma.

- **Maximum allowed disk space (MB)** You can set the amount of disk space a site can use, and can change this value at any time. The value is in megabytes and must be a whole number greater than zero.

You can choose where to store a new virtual site. In the Add New Virtual Site table, in the Maximum allowed disk space (MB) parameter, a pull-down menu lists in alphabetical order the available disk storage devices. The storage device with the most available space is chosen by default. For more information, see “Storage” on page 82.

Once you have created a virtual site, you cannot change its location.

- **Maximum Number of Users** You can limit the number of users that a Site Administrator can create; you can change this value at any time.
- **Enable FrontPage Server Extensions** You can enable Microsoft FrontPage™ Server Extensions for Web page development on each virtual site. Site Administrators can create and delete user FrontPage webs individually.

When FrontPage Server Extensions are enabled on a virtual site, you must enter a password for the FrontPage client *webmaster* account. For more information, see “FrontPage Server Extensions” on page 44.

- **Enable Anonymous FTP** Users without passwords can download and upload files through FTP up to the specified disk-space limit. You can enable the anonymous FTP server for any virtual site. You can also limit the amount of data that can be uploaded anonymously and the total number of anonymous users who can access the virtual site simultaneously.



**Note:** A virtual site can be name-based or IP-based. If there are several name-based virtual sites on an IP address, only one name-based virtual site can use anonymous FTP.



- **Enable SSL** The RaQ 4 provides an optional secure sockets layer (SSL) for Web access. See “SSL settings” on page 118.
- **Enable Active Server Pages (ASP)** The RaQ 4 supports ASP scripting language. For more information, see “Active Server Pages (ASP)” on page 45.
- **Enable PHP Embedded Scripting** The RaQ 4 supports PHP embedded scripting. For more information, see “PHP embedded scripting” on page 45.
- **Enable Shell Accounts** The users of the virtual site being created can telnet to the RaQ 4 and run commands from a Linux shell. If this feature is enabled, Site Administrators can grant shell access on a user-by-user basis.



*Note:* Granting shell access can greatly compromise the security of your RaQ 4.

- **Enable Secure POP3 (APOP)** You can enable the Authentication Post Office Protocol (APOP) for a virtual site. APOP is a challenge-response authentication scheme built on top of the standard POP protocol. APOP is designed in a way that protects your password when being sent across the network.



*Note:* If you enable APOP for a user, that user can check his or her email only through an APOP client; a regular POP3 client will not work unless APOP is disabled for that user.

- **Enable common gateway interface (CGI) scripts** You can enable this virtual site and all the site users to have CGI-based dynamic Web content on the RaQ 4. CGI allows a user to have a Web site run programs that dynamically generate hypertext markup language (HTML) pages in response to specific user inputs. CGI scripts can be created on a user’s desktop computer and then transferred to the RaQ 4 with a file transfer protocol (FTP) application. See “Publishing Web pages using FTP” on page 146.
- **Enable Server Side Includes** The RaQ 4 can correctly display server-parsed Web pages (.shtml).

## FrontPage Server Extensions

When you enable FrontPage Server Extensions on a virtual site, a FrontPage client *webmaster* account is created and you must provide a password for the *webmaster* account.



**Note:** The FrontPage user *webmaster* is a part of the FrontPage Server Extension software and is not a true Linux site-user account. As such, it does NOT have Web, email or FTP service. It is simply an account to use in the FrontPage client.

If FrontPage Server Extensions are enabled on a virtual site, the Site Settings table on the **Site Management** screen shows a check box indicating that the feature is enabled. If you disable FrontPage Server Extensions on a virtual site and save the changes, the Site Settings table refreshes to show the feature as disabled and a *webmaster* password field is now displayed in the table. If you re-enable FrontPage Server Extensions on that virtual site, you must provide a password again for the *webmaster* account.

If you do not enter a password after you enable FrontPage Server Extensions and then try to save changes, the UI will not accept the changes. An error message appears at the bottom of the screen informing you that you must enter a password for the *webmaster* account.

Each virtual site has a separate *webmaster* account and a unique *webmaster* password.

Once the *webmaster* has authenticated through the FrontPage client, he or she can:

- modify Web content
- manage FrontPage site Root Web subwebs
- add, modify or remove additional FrontPage user accounts
- change the *webmaster* password



**Note:** User webs cannot manage subwebs or FrontPage user accounts.

For more information on the FrontPage features, refer to the user documentation for the FrontPage client software.

## Active Server Pages (ASP)

The RaQ 4 uses Chili!Soft™ Active Server Pages (ASP) software.

ASP is an HTML-embedded scripting language that includes one or more small embedded programs, or *scripts*, that are processed on a Web server before the Web page is sent to the user. An ASP is somewhat similar to a server-side include or a common gateway interface (CGI) application in that all three involve programs that run on the server, usually tailoring a page for the user.

For example, an ASP script can use the input from the user's request for the page to access data from a database. The script then builds or customizes the page on the fly and returns it to the requestor. The Web server does all of the processing, and a standard HTML page is generated and sent to the browser.

It is not necessary to enable the ASP Administrative Server on the **Server Management** screen in order to enable ASP on an individual virtual site.

### ASP Administrative Server

The ASP Administrative Server allows you to configure your ASP service through a separate browser-based UI. It does not need to be turned on to allow site users to serve ASP pages; this interface runs on port 5100.

You can access the ASP Administrative Server screen from the **Server Management** screen. The ASP Administrative Server user interface includes a link to the ASP HTML documentation files.

For more information, see “ASP Administrative Server” on page 62.

## PHP embedded scripting

The RaQ 4 supports PHP Version 4.0 embedded scripting.

As with ASP, PHP is an HTML-embedded scripting language that includes one or more small embedded programs, or *scripts*, that are processed on a Web server before the Web page is sent to the user.

Much of the PHP syntax is borrowed from C, Java and Perl with a few unique PHP-specific features thrown in. The goal of the language is to allow Web developers to write dynamically generated pages quickly.

For more information on PHP, visit the URL <http://www.php.net>.

## Setting defaults for a virtual site

There are many advantages for setting defaults for the virtual sites. For example, since multiple sites can now share an IP address, a default IP address can be set for all new virtual sites added. Also, since it is common for many sites to share a common domain name, it can be desirable to set a default domain name for your virtual sites.

The same is true of all the options for a virtual site; it is best for you to decide the needs of your typical virtual site before assigning these values.

Site defaults and site settings can only be configured by the RaQ 4 Administrator. If you (as the RaQ 4 Administrator) enable either the FrontPage Server Extensions service or the Shell Accounts service, the Site Administrators can enable or disable FrontPage user webs, and enable or disable individual (per-user) shell access.

Figure 16 shows the screen for configuring the default settings of a virtual site.

**Figure 16.** Default settings for a virtual site

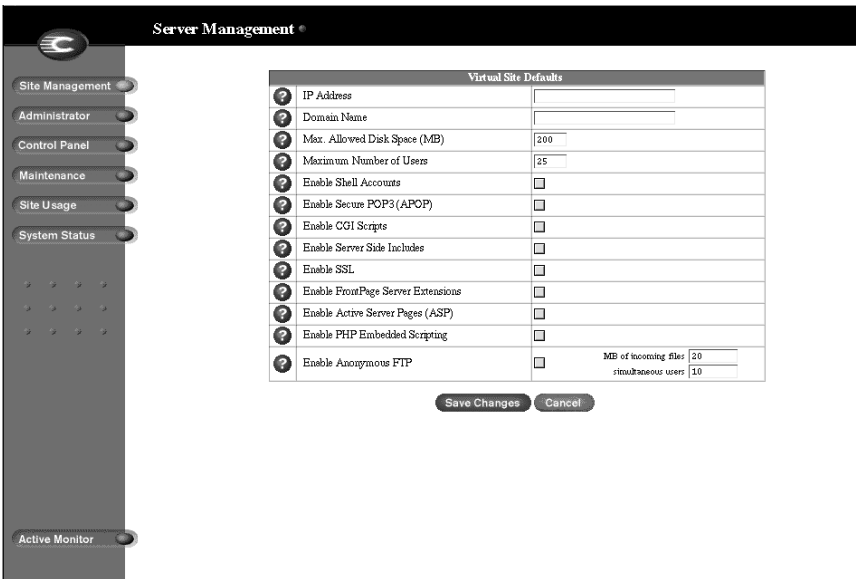

## Modifying the default site settings

To modify the default settings for a virtual site:

1. On the **Server Management** screen, click **Site Management**. The Virtual Site List table appears.
2. Click **Set Virtual Site Defaults**. The Virtual Site Defaults table appears.
3. Enter the information for the site.
4. See the descriptions in “Overview of virtual sites” on page 41.
5. Click **Save Changes**.

Once you have configured the default settings, you can modify the settings for each virtual site that you add.

## Adding a virtual site

To add a virtual site:

1. On the **Server Management** screen, click **Site Management**. The Virtual Site List table appears.
2. Click **Add Virtual Site**. The Add New Virtual Site table appears. See Figure 17.
3. Enter the information for the site (information from the virtual site default settings is displayed here).
4. Make changes to the information or complete the necessary information.
5. Verify the settings and click **Confirm New Site**.

Figure 17 shows the screen for adding a virtual site.

Figure 17. Adding a virtual site

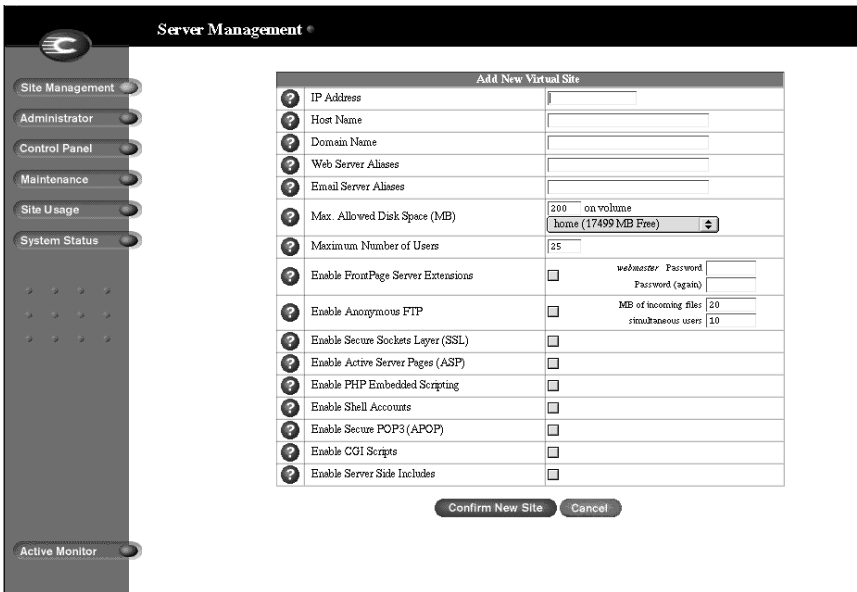

## Adding a name-based virtual site

If you are adding a name-based virtual site, you must have DNS records for that site before you can access the site. For more information, see “Definition of a virtual site” on page 35.



**Note:** To preview a name-based virtual site, you must first configure its DNS records and make those DNS records available to your workstation and the RaQ 4 server.

Requests to the IP address are directed to the first name-based site created on that IP address.

If you administer your DNS records on the RaQ 4, refer to Appendix D, “Domain Name System”, for more information about creating DNS records. If your Internet service provider (ISP) administers your DNS records, ask your ISP to create the DNS records for the new name-based virtual site.

Once the virtual site has been created, you can manage it by clicking the green pencil icon for the site. See “Changing site settings” on page 113.

To assign a Site Administrator to the new virtual site, see “Adding a site user” on page 99.

## Removing a virtual site

To remove a virtual site:

1. On the **Server Management** screen, click **Site Management**. The Virtual Site List table appears.
2. In the Virtual Site List table, click the trashcan icon for the virtual site you want to remove.
3. In the confirmation dialog box that appears, click **OK** to delete all the virtual site accounts, site users and contents.
4. The screen refreshes and the virtual site is no longer listed.

Both the Site Administrator and the RaQ 4 Administrator can configure the site user default settings. See “Setting defaults for a site user” on page 97.

After creating a virtual site, you can add or remove users for that site, and assign a Site Administrator. See “Adding a site user” on page 99.

For information on changing the settings for a particular virtual site, see “Changing site settings” on page 113.

For information on removing a site user from a particular virtual site, see “Removing a site user” on page 102.

# RaQ 4 Administrator



**Important:** Be sure to remember the password you enter here—otherwise, you will need to reset it (See “Resetting the RaQ 4 Administrator password” on page 51).

In the Administrator section of the Server Management screen, you enter information about the RaQ 4 Administrator—including user name, password and, optionally, an email address where system alerts for failed services are sent.

To enter the information for the RaQ 4 Administrator:

1. On the **Server Management** screen, click **Administrator** on the left. The Administrator Settings table appears. See Figure 18.
2. Enter the first name and last name of the administrator.
3. Enter the password twice to ensure that you have entered it as intended. For guidelines on choosing a password, see “Password guidelines” on page 27.
4. As an option, enter an email address that will receive system alerts for failed services.
5. Click **Save Changes**.

**Figure 18.** Administrator Settings table

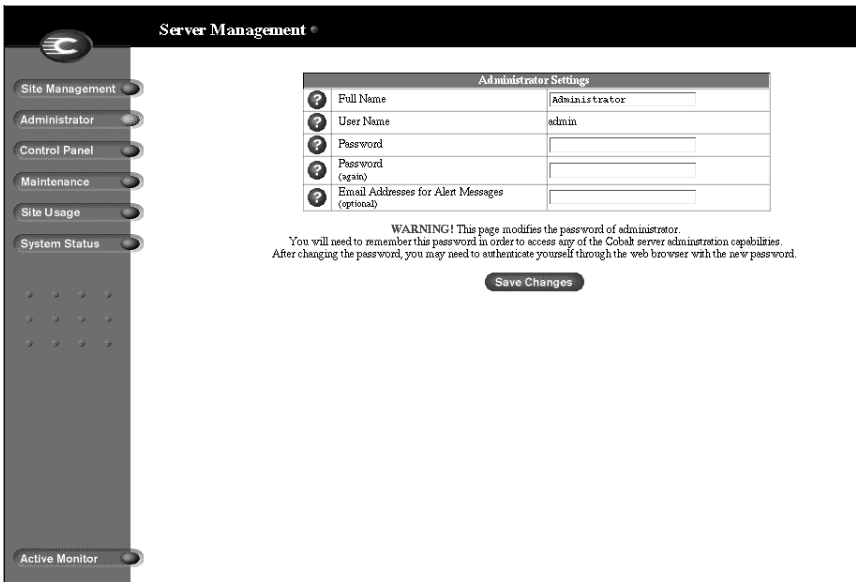



## Changing the RaQ 4 Administrator password

To change the password for the RaQ 4 Administrator:

1. On the **Server Management** screen, click **Administrator** on the left. The Administrator Settings table appears.
2. Enter the password twice to ensure that you have entered it as intended. The RaQ 4 supports long passwords through the UI.

For guidelines on choosing a password, see “Password guidelines” on page 27.

3. Click **Save Changes**.

## Resetting the RaQ 4 Administrator password

When the RaQ 4 Administrator password is cleared, the root account is not accessible until a new administrator password has been assigned.



**Caution:** After you clear the password, enter a new one as soon as possible to protect the security of the RaQ 4. At this point, anyone on the network can assign the RaQ 4 Administrator password until you assign a new one.

If you forget the RaQ 4 Administrator password, you can clear it by following these steps.

1. Push and hold the end of a paper clip in the recessed Reset Password button (located between the LCD screen and the LCD arrow buttons, on the front of the RaQ 4). Hold the button in for approximately 2 seconds.

The LCD screen displays

```
Resetting admin
password...
```

2. Release the button.
3. In your Web browser, enter the URL `http://<IP address>/admin/` or `http://<host name>/admin/` to access the **Server Management** screen.
4. If a prompt appears asking for a username or password, enter *admin* as the username. DO NOT enter a password. Click **OK**.

- Click **Administrator** on the left. The Administrator Settings table appears.
- Enter the password twice to ensure that you have entered it as intended. The RaQ 4 supports long passwords through the UI.

For guidelines on choosing a password, see “Password guidelines” on page 27.

- Click **Save Changes**.

## Control panel

You can configure the services, network and time settings through the Control Panel section of the **Server Management** screen.



**Note:** For help with a particular field, move the mouse pointer over the Active Assist  icon adjacent to the field. Help text appears in a window at the bottom of the screen.







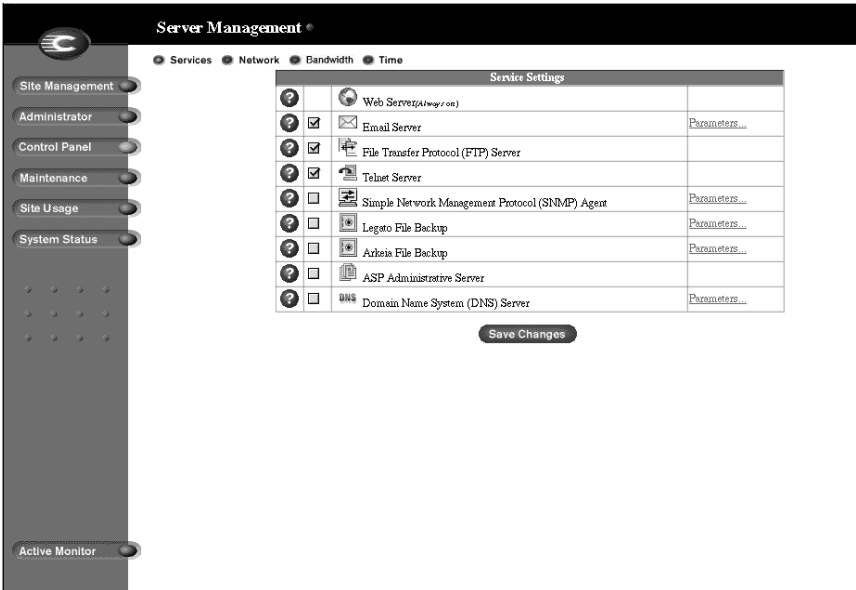









## Services

Figure 19 shows the Service Settings table of the Services section.

**Figure 19.** Service Settings table



The screenshot shows the 'Server Management' interface with the 'Services' tab selected. The 'Service Settings' table is displayed with the following rows:

		Web Server (http://os)	
	<input checked="" type="checkbox"/>		Email Server <a href="#">Parameters...</a>
	<input checked="" type="checkbox"/>		File Transfer Protocol (FTP) Server
	<input checked="" type="checkbox"/>		Telnet Server
	<input type="checkbox"/>		Simple Network Management Protocol (SNMP) Agent <a href="#">Parameters...</a>
	<input type="checkbox"/>		Legato File Backup <a href="#">Parameters...</a>
	<input type="checkbox"/>		Arkeia File Backup <a href="#">Parameters...</a>
	<input type="checkbox"/>		ASP Administrative Server
	<input type="checkbox"/>		Domain Name System (DNS) Server <a href="#">Parameters...</a>

Below the table is a **Save Changes** button.

To manage the settings for the RaQ 4 services:

1. On the **Server Management** screen, click **Control Panel** on the left. The Service Settings table appears.
2. To turn on any of the services listed in the Service Settings table (except Web server, which is always on), click the check box next to that service. The services are described in the sections that follow.
3. Click **Save Changes**.



**Note:** Chapter 5 provides instructions for site users on how to use the RaQ 4 services.

## Web server

This service is always on. It allows site users to access Web content, as described in Chapter 5.

## Email server

The RaQ 4 supports email for each virtual site on the host. It also supports email for entire domains (for example, *www.mydomain.com*). By default, each registered user has an email account created on the RaQ 4.

The RaQ 4 supports multiple client and server email protocols but does not implement virtual email users. This means that for the entire RaQ 4, each user must have a unique username, even if the users are on different virtual sites. For more information, see “Email relaying” on page 56.

## SMTP server

The RaQ 4 can act as a Simple Mail Transfer Protocol (SMTP) server for sending and receiving Internet email. As the RaQ 4 Administrator, you can configure several parameters that can affect the performance of the SMTP server.

Users created on any virtual site can retrieve their email using the Post Office Protocol 3 (POP3) or the Authentication Post Office Protocol (APOP), in addition to the Internet Message Access Protocol 4 (IMAP4). Users can send mail using the Simple Mail Transfer Protocol (SMTP).

For the RaQ 4 to receive email, you or your network administrator must enter a mail server host name in your organization’s DNS server to designate the RaQ 4 as the mail server for a domain. Email service depends on DNS. so the IP address of a DNS server must be entered in the network settings for the RaQ 4; if not, the SMTP protocol will not work. If you did not enter this IP address in the Setup Wizard, see “Network” on page 64.

For more information on DNS, see Appendix D, “Domain Name System”.

Figure 20 shows the Email Parameters table.

**Figure 20.** Email Parameters table

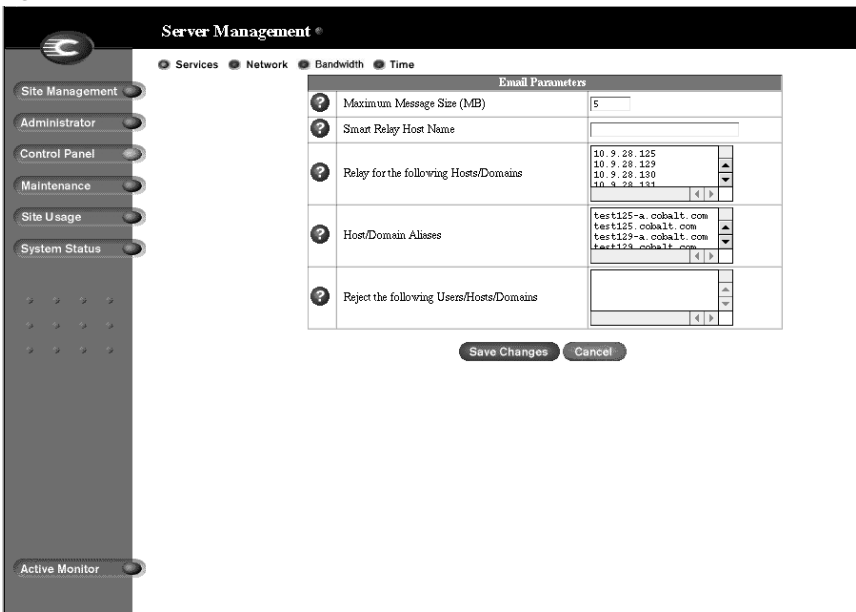

## Configuring the email parameters

To configure the email parameters:

1. In the Service Settings table, click the **Parameters** link next to Email Server. The Email Parameters table appears.
2. Fill in the fields in the Email Parameters table. The following paragraphs explain these fields.
3. Click **Save Changes** in the Email Parameters table.
4. Click **Save Changes** in the Service Settings table

You can modify the following parameters:

- **Maximum message size (MB)** It is important to enter a value here to limit the size of incoming email messages. If this field is blank, the server will not limit the size of incoming messages, which may allow a single message to fill up your available space on the hard disk drive. A message that exceeds the specified quota of space on the hard disk drive is returned to the sender as “undeliverable”. The default value is 5 MB; the value must be a whole number greater than zero.
- **Smart Relay Host Name** You can enter an optional host name in this field. With this feature, you can configure the RaQ 4 to send Internet email to a specific email server. Enter the host name of the email server through which you want to relay your email.

This feature is useful if the RaQ 4 does not have direct Internet access (for example, the RaQ 4 is subject to a restrictive firewall), but can communicate with an email server that has direct Internet access.

- **Relay for the following hosts/domains** You can specify a list of hosts for which the SMTP server will relay email messages. For more information, see “Email relaying” on page 56.
- **Hosts/domains aliases** In this field, enter all the IP addresses or domain names of sites on which you receive email. You can only receive email that is addressed to you on the domains specified here. For example, if you want to receive email addressed to you at username@mydomain.com, type domain.com in this field.

You can also add email server aliases when creating a virtual site. For more information, see “Overview of virtual sites” on page 41.

- **Reject the following users/hosts/domains** In this field, enter email addresses or domains from which you want to block any email. Anyone trying to send you messages from one of these addresses or domains will receive an error message in return.

## Email relaying

Simple Mail Transfer Protocol (SMTP) service is different from Post Office Protocol (POP), telnet and file transfer protocol (FTP) services in that SMTP does not try to authenticate a user when an SMTP connection is made.

Every email server on the Internet has to be able to deliver email to you, so the email servers must be able to connect freely to send the email. The RaQ 4 accepts email for processing if the recipient has a user account or an alias email account, or if the sending host (your client PC) is trusted to relay outgoing email messages to another domain. These trusts are defined by host or domain names, as well as by IP addresses and networks.



**Caution:** Some users advise you to open relay to all com, edu, net and other top-level domain addresses. However, doing so allows hosts belonging to com, edu, net and others to relay email through your server; this relayed mail is known as *spam mail*.

Spam mail can appear as though it originated from your server and as a result, others may blacklist your server as a known spam site. If your server is blacklisted, many mail servers will not relay your email and your customers will not receive a large amount of their email messages.

If you have users who access your server through the Internet, ask your Internet service provider (ISP) which networks are used by their remote access (dial-up) equipment.

For example, if the ISP says the network 192.168.10.5 through 192.168.10.24, then enter “192.168.10” in the “Relay email from these hosts/domains” field of the Email Parameters table. If your ISP gives you a list of 30 networks used by 30 points-of-presence (POPs) (which are regional ISP offices) across the country and your clients can dial in from any of them, then you must trust all 30 networks or these users cannot send email through your RaQ 4.

## Enabling email relaying

To enable email relaying, add the IP addresses (or domain names, or both) of the machines which use your RaQ 4 as the SMTP server.

1. On the **Server Management** screen, click **Control Panel**. The Service Settings table appears.
2. Click the **Parameters** link next to Email Server. The Email Parameters table appears.

One field is labeled “Relay for the following hosts/domains”. The following paragraphs explain how to fill in this field.

?	Relay for the following Hosts/Domains	<table border="1" style="width: 100%; border-collapse: collapse;"> <tr><td style="padding: 2px;">10.9.28.125</td></tr> <tr><td style="padding: 2px;">10.9.28.129</td></tr> <tr><td style="padding: 2px;">10.9.28.130</td></tr> <tr><td style="padding: 2px;">10.9.28.131</td></tr> </table>	10.9.28.125	10.9.28.129	10.9.28.130	10.9.28.131
10.9.28.125						
10.9.28.129						
10.9.28.130						
10.9.28.131						

3. Click **Save Changes** in the Email Parameters table.
4. Click **Save Changes** in the Service Settings table.

The entries you add to this field serve as part of a pattern match against the email that the client is sending. As a result, some handy shortcuts are possible. If you have a number of hosts in the same network block, you can, as a shortcut, simply enter the number of the network block.

For example, specifying a network such as 192.168.1 in the “Relay email from these hosts/domains” field trusts all IP addresses from 192.168.1.1 through 192.168.1.254.



**Note:** There is no trailing period on the number of the network block and there are only three octets entered in the field. It is important that you do not include a trailing dot after the part of the IP address that you want to match.

If you want to allow connections from a host that ends, for example, in *mydomain.com*, add the string “mydomain.com” in the text area.



**Note:** If you entering a domain name or part of a domain name in the text box, you must have reverse DNS working on your clients.

## File transfer protocol (FTP) server

Using the file transfer protocol, site users can upload and download files on the RaQ 4. Users can transfer files with FTP client software such as Fetch or WS-FTP.

You can enable or disable the FTP server.

1. On the **Server Management** screen, click **Control Panel**. The Service Settings table appears.
2. Click the check box next to File Transfer Protocol (FTP) Server to on or off.
3. Click **Save Changes**.

## Telnet server



**Caution:** You can adversely affect the operation of your RaQ 4 if you modify system configuration files. Check your warranty card for details.

Granting shell access can greatly compromise the security of your RaQ 4.



**Note:** Disabling the telnet server in the Service Settings table denies telnet access to all users, even if they have been granted shell access.

Telnet access is available but only advanced users should use telnet. An advanced user is someone who is proficient in the workings of a Unix operating system.

You can enable or disable the telnet server:

1. On the **Server Management** screen, click **Control Panel**. The Service Settings table appears.
2. Click the check box next to Telnet Server to on or off.
3. Click **Save Changes**.



## Simple Network Management Protocol (SNMP) agent

If the SNMP agent is enabled, you can use SNMP software to remotely monitor server information such as CPU utilization and network traffic.

You can enable or disable the Simple Network Management Protocol (SNMP) agent:

1. On the **Server Management** screen, click **Control Panel**. The Service Settings table appears.
2. Click the check box next to Simple Network Management Protocol (SNMP) agent to on or off.
3. If you are disabling the SNMP agent, click **Save Changes**.  
If you are enabling the SNMP agent, click on the **Parameters** link next to the option in the Service Settings table. The SNMP Parameters table appears.
4. Enter the SNMP communities that can have read-only and read-and-write access to this SNMP agent. The default read-access community is “public”.
5. Click **Save Changes** in the SNMP Parameters table.
6. Click **Save Changes** in the Service Settings table.

Figure 21 shows the SNMP Parameters table.

**Figure 21.** SNMP Parameters table

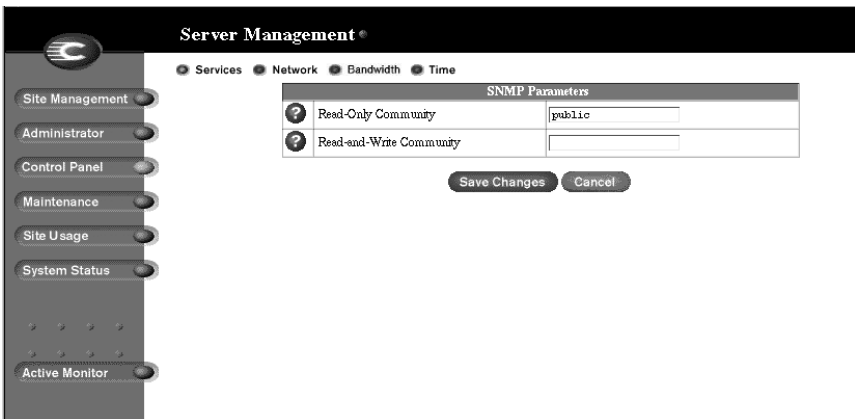

## Legato file backup

You can use the Legato NetWorker® client software to support backup and restore needs on the RaQ 4. To use this feature, you must install the Legato Networker Server software. The software is available at [www.legato.com](http://www.legato.com).

To enable or disable the Legato file backup option:

1. On the **Server Management** screen, click **Control Panel**. The Service Settings table appears.
2. Click the check box next to Legato File Backup to on or off.
3. If you are disabling the Legato File Backup option, click **Save Changes**.

If you are enabling the Legato File Backup option, click on the **Parameters** link next to the option in the Service Settings table. The Legato Networker Parameters table appears.

4. In the Legato Networker Parameters table, enter the host name and the IP address of the Legato Server in the fields.
5. Click **Save Changes** in the Legato Networker Parameters table.
6. Click **Save Changes** in the Service Settings table.

Figure 22 shows the Legato Networker Parameters table.

**Figure 22.** Legato Networker Parameters table



## Arkeia file backup

You can use the Arkeia backup software from Knox Software to support backup and restore needs on the RaQ 4.

There is a client component and a server component to the Arkeia backup software. The client-side software is pre-installed on the RaQ 4. The server-side software can be obtained from the Arkeia Web site at <http://www.arkeia.com>.

To enable or disable the Arkeia client-side backup software:

1. On the **Server Management** screen, click **Control Panel**. The Service Settings table appears.
2. Click the check box next to Arkeia File Backup to on or off.
3. If you are disabling the Arkeia File Backup option, click **Save Changes**.

If you are enabling the Arkeia File Backup option, click on the **Parameters** link next to the option in the Service Settings table. The Arkeia Parameters table appears.

4. In the Arkeia Parameters table, enter the host name of the server that will back up the RaQ 4.
5. Click **Save Changes** in the Arkeia Parameters table.
6. Click **Save Changes** in the Service Settings table.

Figure 23 shows the Arkeia Parameters table.

**Figure 23.** Arkeia Parameters table

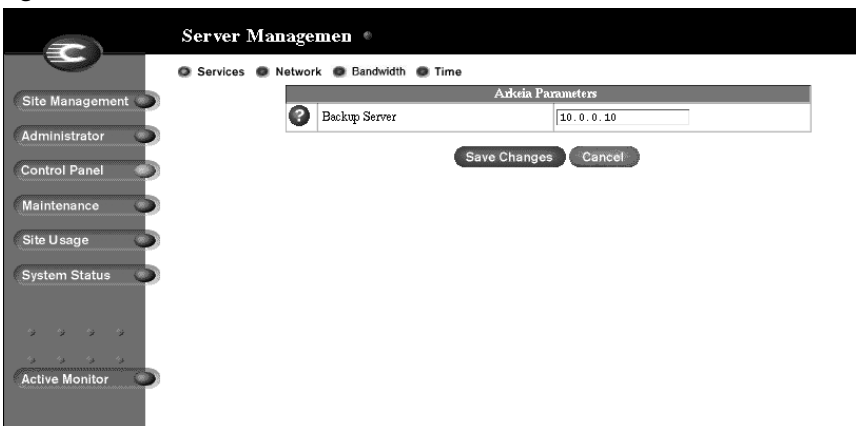

### **RaQ 4i or RaQ 4r server**

If you have a RaQ 4i or RaQ 4r server, you can attach an external tape device to the SCSI connector on the back panel and load the Arkeia server-side software on to the tape device.

This allows you to back up your RaQ 4i or RaQ 4r server directly to the external tape device and also to function as a backup server for other devices on the network.

### **Base RaQ 4 server**

If you have a base RaQ 4 server, you can back up the server over the local network connection to another device that has the Arkeia server-side software installed on a local tape drive.

### **Managing the server-side software**

The server-side software is managed through a separate utility; this utility has a Java interface on Windows 95/98 and NT, and an X11 interface on Unix. You can download this utility from Arkeia's Web site at <http://www.arkeia.com>.

## **ASP Administrative Server**

To access the ASP Administrative Server UI:

1. In the **Server Management** screen, click **Control Panel** on the left. The Service Settings table appears.
2. Click the check box next to ASP Administrative Server.
3. Click **Save Changes**. The screen refreshes and there is now a link to Parameters in the right column next to ASP Administrative Server.
4. Click **Parameters** in the row for ASP Administrative Server. A confirmation dialog appears, asking for the user name and password for the ASP Management server at <hostname.domainname:5100>.
5. Enter the user name and password of the RaQ 4 Administrator.
6. Click **OK**. A separate browser window opens with the UI for the ASP Server Administration screen. The link for Documentation on the left guides you through the functionality of Chili!Soft ASP.

Figure 24 shows the UI for the ASP Administrative Server.

**Figure 24.** ASP Administrative Server UI

**server - default Properties**

Controls	Description
<a href="#">Start server</a>	Starts the server.
<a href="#">Restart Server</a>	Stops and starts the engine.

Properties	Description
<a href="#">Databases</a>	Configure database settings.
<a href="#">ASP Applications</a>	Add/remove/configure asp applications.
<a href="#">Settings</a>	Configure general settings for server.
<a href="#">View Log</a>	Show log files for server.

**Server Information:**

**status:** Stopped  
**uptime:**  
**location:** /home/chillasp/asp-apache-3000  
**web server:** <http://vhost28.cobaltnet.com:80>  
**port:** 3000

## Domain Name System (DNS) server

Domain Name System (DNS) is a vital and integral part of the Internet. Setting up DNS correctly on your RaQ 4 is very important. For this reason, we have created an appendix solely for explaining DNS. See Appendix D, “Domain Name System”.

The appendix covers the following items:

- basic DNS issues
- advanced DNS issues
- a sample setup of DNS records for a RaQ 4 server
- a brief history of the DNS service

## Network

The network settings make the RaQ 4 visible to other computers. If you change the IP address, the RaQ 4 reboots.



**Important:** Coordinate the network configuration information with your network administrator to ensure the integrity of your network. Incorrect network settings can result in a loss of connectivity.

To enter or change the network configuration for the RaQ 4:

1. On the **Server Management** screen, click **Control Panel** on the left. The Service Settings table appears.
2. Click **Network** at the top. The settings tables for the network configuration appear.
3. Enter configuration information for the General Settings, the Interface Settings for Network 1 or the Interface Settings for Network 2.



**Note:** For help with a particular field, move the mouse pointer over the Active Assist  icon adjacent to the field. Help text appears in a window at the bottom of the screen.

4. Click **Save Changes**.

Figure 25 shows the Settings tables of the Network section.

Figure 25. Settings tables in the Network section

Server Management

Services Network Bandwidth Time

General Settings

Cobalt Server Name	vhost28
Domain Name	cohabitnet.com
Primary DNS Server Address	10.9.25.1
Secondary DNS Server Address (optional)	
Default Gateway	10.9.25.254

Interface Settings - Network 1

IP Address	10.9.28.128
Subnet Mask	255.255.0.0
MAC Address	00:10:E0:01:A6:F2

Interface Settings - Network 2

IP Address	
Subnet Mask	
MAC Address	00:10:E0:01:A6:F1

Please coordinate this information with your system administrator to ensure the integrity of your network.

Save Changes

## Bandwidth

The RaQ 4 allows you to set an output bandwidth limit for each IP address that you assign on a RaQ 4. The bandwidth limit applies to all of the name-based virtual sites associated with an IP address.

The limit is specified in kilobits per second (Kb/s), and the RaQ 4 enforces a minimum bandwidth limit of 10 Kb/s.

The bandwidth limit applies to all outgoing Transmission Control Protocol (TCP) traffic on a particular IP address. This includes Web, FTP, POP and telnet traffic, as well any other TCP-based application.

If multiple users are accessing a bandwidth-limited IP address, the system divides the bandwidth evenly among the users.

If multiple named-based virtual sites belong to one IP address, the bandwidth assigned to the IP address is divided evenly among the total number of users on those name-based virtual sites.

This feature does not regulate input traffic.

You can apply a bandwidth limit to an IP address that did not previously have one, modify an existing bandwidth limit or delete a bandwidth limit.

## Bandwidth Limits table

When you select the bandwidth-limit option, the Bandwidth Limits table appears; see Figure 26. If you have not applied a bandwidth limit to any IP addresses, the table is blank. If you have applied a bandwidth limit to an IP address, the table displays four columns:

- the IP address to which the limit is applied
- the bandwidth limit (in Kb/s)
- the fully qualified domain names of the sites associated with the IP address
- the icons to modify the bandwidth limit (green pencil) or delete the bandwidth limit (brown trashcan)

Figure 26 shows the Bandwidth Limits table.

**Figure 26.** Bandwidth Limits table

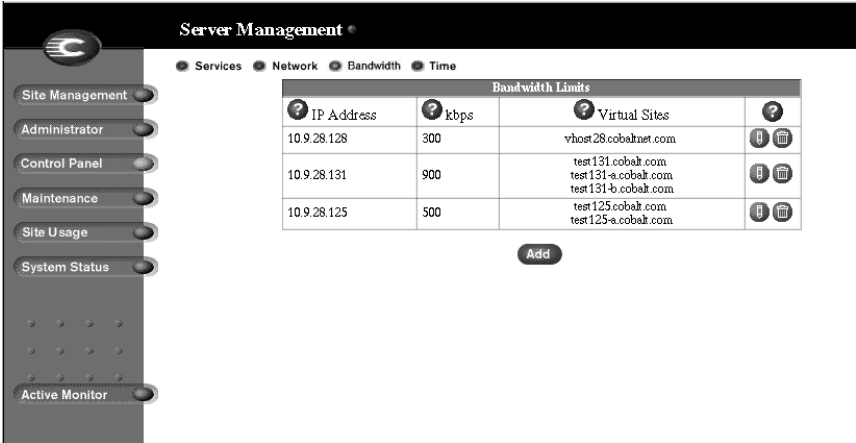



## Applying a bandwidth limit

To apply a bandwidth limit to an IP address:

1. On the **Server Management** screen, click **Control Panel** on the left. The Service Settings table appears.
2. Click **Bandwidth** at the top. The Bandwidth Limits table appears.
3. Click **Add**. The Add Bandwidth Limit table appears. See Figure 27.



**Note:** If each of the IP addresses on the RaQ 4 already has a bandwidth limit assigned to it, an error message at the bottom of the screen alerts you to this fact.

To modify a bandwidth limit, see “Modifying a bandwidth limit” on page 68. To delete a bandwidth limit, see “Deleting a bandwidth limit” on page 69.

4. In the first row of the table, select from the pull-down menu the IP address to which you want to apply the bandwidth limit. The pull-down menu lists all the IP addresses that do not currently have a bandwidth limit.
5. In the second row, enter the value of the bandwidth limit in Kb/s. The minimum value is 10 Kb/s.
6. Click **Save Changes**. The screen refreshes and the Bandwidth Limits table is displayed with the IP address and the bandwidth limit.

Figure 27 shows the Add Bandwidth Limit table.

**Figure 27.** Add Bandwidth Limit table

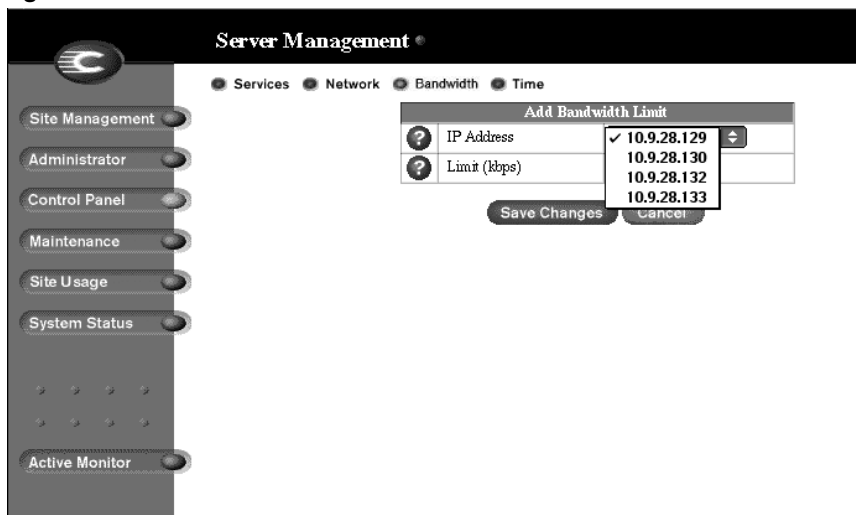

## Modifying a bandwidth limit

To modify a bandwidth limit to an IP address:

1. On the **Server Management** screen, click **Control Panel** on the left. The Service Settings table appears.
2. Click **Bandwidth** at the top. The Bandwidth Limits table appears.
3. In the table, locate the IP address for which you want to modify the bandwidth limit.
4. Click the green pencil icon next to that IP address. The Modify Bandwidth Limit table appears. The first row of the table displays the IP address.
5. In the second row, enter the new value of the bandwidth limit in Kb/s. The minimum value is 10 Kb/s.
6. Click **Save Changes**. The screen refreshes and the Bandwidth Limits table is displayed with the new bandwidth limit for that IP address.

## Deleting a bandwidth limit

To delete a bandwidth limit to an IP address:

1. On the **Server Management** screen, click **Control Panel** on the left. The Service Settings table appears.
2. Click **Bandwidth** at the top. The Bandwidth Limits table appears.
3. In the table, locate the IP address for which you want to delete the bandwidth limit.
4. Click the brown trashcan icon next to that IP address. A confirmation dialog appears.
5. Click **OK**. The screen refreshes and the Bandwidth Limits table is displayed; bandwidth limit for that IP address is removed.

## Time

The RaQ 4 Administrator can configure the correct time and date and the time zone for the RaQ 4.

1. On the **Server Management** screen, click **Control Panel** on the left. The Service Settings table appears.
2. Click **Time** at the top. The Time Settings table appears. See Figure 28.
3. Select the time and date with the pull-down menus.
4. Select the correct time zone by clicking in the Region, Country and Locale/Zone fields.
5. As an option, you can also specify the name of a Network Time Protocol (NTP) server with which the RaQ 4 will synchronize its internal clock every night. Enter the host name or IP address of the NTP server.

You can find a list of publicly available NTP servers at:  
<http://www.eecis.udel.edu/~mills/ntp/servers.html>.

6. Click **Save Changes**.

Figure 28 shows the Time Settings table.

Figure 28. Time Settings table

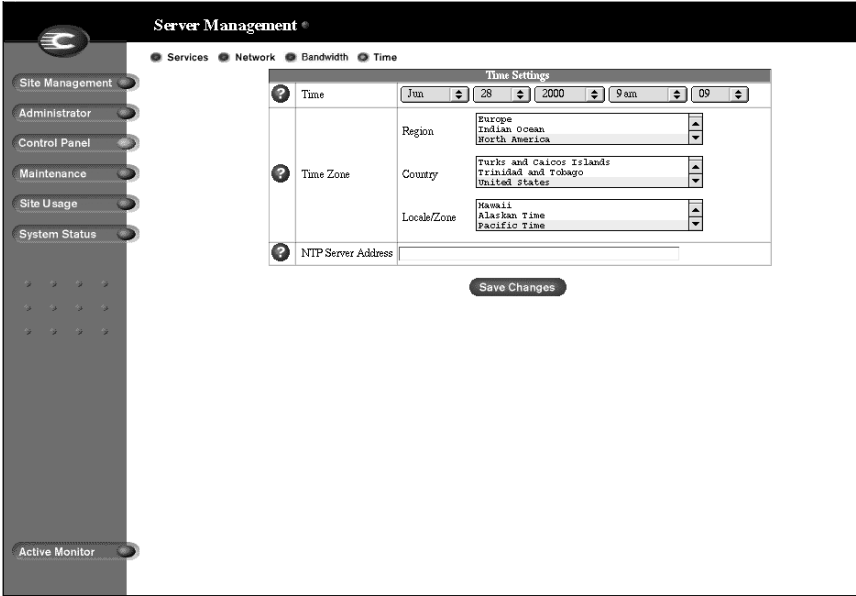

# Maintenance

The Maintenance section of the **Server Management** screen provides several Web-based utilities that facilitate day-to-day operations on the RaQ 4.

To access these utilities:

1. On the **Server Management** screen, click **Maintenance** on the left. The File Backup table appears.
2. Choose a utility at the top. The utilities are described in the following sections.

## Backup



**Caution:** A backup captures data only (for example, email messages stored on the server or Web files). It does NOT back up the settings for virtual sites or users.

This feature should not be used for disaster recovery.

As the RaQ 4 Administrator, you can perform different types of backups in the user interface. This is a separate function from the Legato and Arkeia backup support features.



**Caution:** You can use Microsoft Internet Explorer 3.0 to back up a Cobalt server but not to restore a backup file. Upgrade to a later version of Internet Explorer or use a different browser software to restore the backup file.

## Manual backup

This feature allows administrators to manually back up data stored on the RaQ 4. Figure 29 shows the File Backup table.

Figure 29. File Backup table

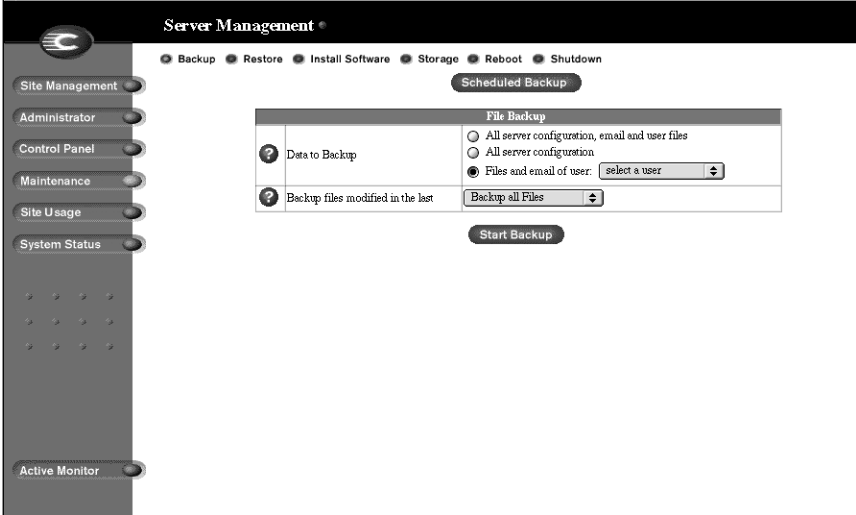

To manually back up data stored on the RaQ 4:

1. On the **Maintenance** screen, click **Backup** at the top.
2. In “Data to Backup,” select the type of backup:
  - **All server configuration, email and user files.** This option backs up all the server configuration files for the users and the system setup, all users’ files, all group files and all email in-boxes.
  - **All server configuration.** This option backs up all the server configuration files for the users and the administrator, as well as all the system setup information.
  - **Files and email of user.** This option backs up the files and email in-box for a specific user.
3. To back up all files or to back up files changed within a certain time frame, choose from the pull-down menu adjacent to “Backup files modified in the last.”

You can choose “Backup all Files,” 31 days, 14 days, 7 days, 2 days or 1 day.
4. Click **Start Backup**.
5. Assign a path and a file name on your computer for storing the backup data. Click **Save**.

The file transfer takes several seconds to several minutes. Do not interrupt or cancel the file transfer. If the file transfer fails, delete the partial back up file from your computer. If you try to restore a partial back up file, you can corrupt the data on your RaQ 4.

## Scheduled backup

This feature allows administrators to schedule regular automatic backups. Figure 30 shows the Scheduled File Backup table.

Figure 30. Scheduled File Backup table

The screenshot shows the 'Server Management' interface with a sidebar on the left containing menu items: Site Management, Administrator, Control Panel, Maintenance, Site Usage, System Status, and Active Monitor. The main content area has a navigation bar with buttons for Backup, Restore, Install Software, Storage, Reboot, and Shutdown. The 'Scheduled File Backup' configuration table is displayed with the following fields:

Scheduled File Backup	
Frequency	Never
Data to Backup	<input type="radio"/> All server configuration, email and user files <input type="radio"/> All server configuration <input type="radio"/> Files and email of user: <input type="text" value="select a user"/>
Backup files modified in the last	Backup all Files
Method	NFS
Location	<input type="text"/>
Password	<input type="password"/>
Password (again)	<input type="password"/>

Below the table are two buttons: 'Save Changes' and 'Cancel'.



To schedule regular, automatic backups:

1. On the **Maintenance** screen, click **Backup** at the top. The File Backup table appears.
2. Click **Scheduled Backup**. The Scheduled File Backup table appears. See Figure 30.
3. Choose the frequency of the automatic backup.
  - **Daily** means each day at 1 a.m.
  - **Weekly** means every Sunday morning at 1 a.m. (Saturday night going into Sunday morning)
  - **Monthly** means on the first of every month at 1 a.m.
4. In “Data to Backup,” select the type of Backup, as described in step 2 in “Manual backup” on page 72.
5. To back up all files or to back up files changed within a certain time frame, choose from the pull-down menu adjacent to “Backup files modified in the last.”
6. Choose a backup method.
  - **FTP Server** writes the backup file to an FTP server.
  - **NFS** places the backup file on a mountable NFS resource.
  - **SMB Server** (Windows File Sharing) places the backup file onto a directory shared from a Windows machine.
7. Enter a location for storing the backup data.

The location you specify depends in part on the backup method you select in step 6. See “Backup File Locations” below for an explanation of locations you can enter here.
8. If the backup destination associated with your method of backup requires a password for access, enter the password in this field. This field is ignored for the NFS and anonymous FTP methods. See “Backup file locations” on page 76.
9. Click **Save Changes**.

## Backup file locations

For a backup by **FTP Server**:

- A location of `<username>@ftp.server.com` puts the backup file in the initial login directory.
- A location of `<username>@ftp.server.com/path/to/backups/` puts the backup file in the specified path on the server, using `<username>` to login.

For a backup by **Anonymous FTP**:

- For an anonymous FTP connection, the file must be put in a directory where anonymous FTP users have write access. This is generally the `/incoming/` directory.
- A location of `ftp.server.com/incoming` places the backup file on `ftp.server.com` under the `/incoming/` directory.
- The “Password” field should contain the password for the specified user or be left blank for anonymous logins.

For a backup by **NFS Server**:

- The location should be `<server>:/<share>`, where `<server>` is the NFS server and `<share>` is the NFS volume to mount and write to. You must have write privileges to this directory.
- The “Password” is ignored for NFS server backups.

For a backup by **SMB Server** (Windows File Sharing):

- The location should be `<user>@\\windowspc\<share>`. This mounts the volume share on the Windows server, using `<user>` as the login. The “Password” field must contain the password for `<user>`.
- For volumes that do not require a user, the location should be `\\windowspc\share`.

For **All Scheduled** backups:

- Ensure the target location is available and has enough disk space to hold the backup archive. Failure to do this may result in zero-length or truncated archives.

## Restore

You must restore data from the same machine on which the data was backed up. Users can restore their own personal directory.



**Caution:** The system restores data only (for example, email messages stored on the server or Web files). It does NOT restore virtual sites or site users to a RaQ 4.



**Caution:** You can use Microsoft Internet Explorer 3.0 to back up a Cobalt server but not to restore a backup file. Upgrade to a later version of Internet Explorer or use a different browser software to restore the backup file.



**Caution:** The system does not merge the current and backed-up data. When data is restored, any changes made to files on the RaQ 4 since the last backup are lost.

Figure 31 shows the File Restore table.

**Figure 31.** File Restore table

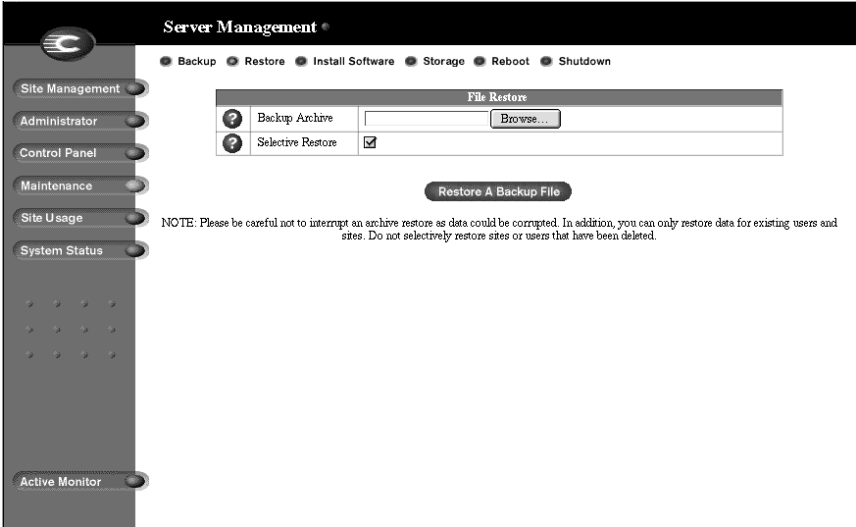

To restore a backup file:

1. On the **Maintenance** screen, click **Restore** at the top. The File Restore table appears. See Figure 31.
2. The RaQ 4 saves backed-up data in .raq files. Enter the path and filename of the backup file, or click **Browse** to select the .raq file archived on your computer which you wish to restore to the server.

Restore times can vary widely. Be careful not to interrupt an archive restore as data could be corrupted.



**Note:** If the file does not appear in the list and you are using Netscape 4.x or Internet Explorer 4.x, you may need to change “File Type” in the desktop to “All Files.”

3. If you want to restore only some of the files, click **Selective Restore** and select those files.
4. Click **Restore A Backup File** below the File Restore table.



**Note:** Restoring large backup archives can cause your Web browser to time out. If you upload the .raq archive through an FTP-based application to the home directory of RaQ 4 Administrator, you can select the archive from a menu on the **Restore** screen.

Do not interrupt an archive restore because this can corrupt data. If the restore process is interrupted, the user can try to restore again.

To restore a user home directory or a virtual site directory, make sure the user or virtual site already exists before restoring the files.

When data is restored, the RaQ 4 and its corresponding parts (virtual site, user, email) are returned to the exact state they were in prior to backup.

## Install software

You can add new software to the RaQ 4 from the browser. You can install new software obtained either from the Cobalt Networks Web site or from a CD supplied by Cobalt Networks.

Figure 32 shows the Install Software table.

Figure 32. Install Software table

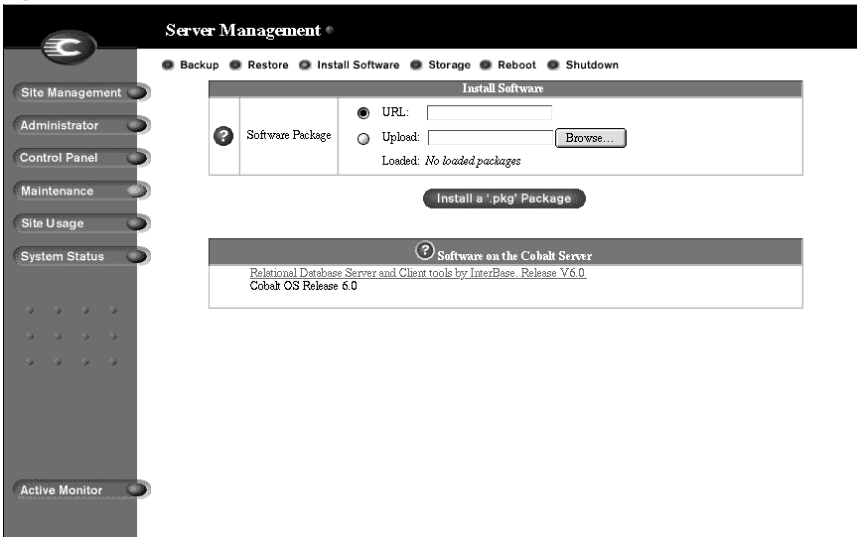

To install or upgrade software from Cobalt's Web site:

1. Through your Web browser, go to <http://www.cobalt.com/support/>.
2. Download the new software to your desktop computer.
3. On the **Server Management** screen, click **Maintenance** on the left. The File Backup table appears.
4. Click **Install Software** at the top. The Install Software table appears. See Figure 32.
5. Click **Browse** to locate the package that you downloaded to your computer. Click **Open** to select the package.
6. Click **Install a .pkg package** to automatically install or upgrade the new software on the RaQ 4.

To install software remotely:

1. On the **Server Management** screen, click **Maintenance** on the left. The File Backup table appears.
2. Click **Install Software** at the top. The Install Software table appears. See Figure 32.
3. In the URL field, enter the URL for the package file. This URL directs the browser to the package file on the Cobalt Networks Web site.
4. Click **Install a .pkg package** to automatically install or upgrade the new software on the RaQ 4.

To install software from a CD:

1. Insert the CD into a computer on the same network as the RaQ 4.
2. On the computer that has the CD, go to the **Server Management** screen. Click **Maintenance** on the left. The File Backup table appears.
3. Click **Install Software** at the top. The Install Software table appears. See Figure 32.
4. Click **Browse** to locate the package file on the CD. Click **Open** to select the package file.
5. Click **Install a .pkg package** to automatically install or upgrade the new software on the RaQ 4.

## Third-party software

Figure 32 shows the various software packages that have been installed on the RaQ 4, including the version of the Cobalt OS and any third-party software. To see more information about the software, click the name (shown as a hypertext link).

### InterBase

The RaQ 4 is pre-loaded with InterBase 6.0, an open-source, cross-platform SQL database from Inprise Corporation. InterBase is not enabled by default.

For more information on InterBase, go to <http://www.interbase.com>.

InterBase offers free development and distribution rights. Interbase offers developers a sophisticated database with a small footprint, low maintenance cost and high reliability.

InterBase offers a number of database features—triggers, stored procedures, blobs, event alerters, user-defined functions, multi-dimensional arrays, two-phase commit, referential integrity, constraints and a flexible set of transaction options.

## Storage

The browser-based UI allows external disk storage devices on the SCSI bus to be used as additional storage for virtual sites. The external disk storage device must remain connected to the RaQ 4 for proper operation of the virtual sites stored on the disk.

You can also add a second internal hard disk drive on a RaQ 4i server. See “Adding or replacing a hard disk drive in a RaQ 4” on page 164 for installing an internal hard disk drive. Once you have added a second drive, you have to add (through the RaQ 4 UI) the drive to the list of available storage devices.



**Note:** You cannot add extra internal or external storage to the base RaQ 4 server configuration.



A virtual site cannot span multiple disks and the RaQ 4 does not automatically recognize virtual sites on an external disk storage device transferred from another RaQ 4.



**Note:** If you have replaced a failed hard disk drive in a RaQ 4r server, you do not need to add the new hard disk drive through the Add Storage feature. When rebooting, the system automatically detects the new hard disk drive.

The RaQ 4r automatically synchronizes the new hard disk drive to the existing hard disk drive so that the server is in RAID mode. During the synchronization process, the RaQ 4r cannot provide disk mirroring but it can still serve requests.

In the Maintenance section of the **Server Management** screen, the administrator can add and format an internal hard disk drive (RaQ 4i) or a non-removable disk storage device to the RaQ 4.



**Note:** You must power down the RaQ 4 before adding or removing an external disk storage device.

Figure 33 shows the Storage in Use table.

**Figure 33.** Storage in Use table

The screenshot shows the 'Server Management' interface. At the top, there are navigation tabs: Backup, Restore, Install Software, Storage, Reboot, and Shutdown. The 'Storage' tab is selected, and an 'Add Storage' button is visible. Below this is a table titled 'Storage in Use'.

Name	Interface	Size	Enabled	
home	RAID	17.268 GB	✓	

The interface also features a left-hand navigation menu with options: Site Management, Administrator, Control Panel, Maintenance, Site Usage, System Status, and Active Monitor.

## Adding a storage device

To add a second hard disk drive or external disk storage device through the UI:

1. On the **Server Management** screen, click Maintenance on the left. The File Backup table appears.
2. Click **Storage** at the top. The Storage in Use table appears. See Figure 33.
3. Click **Add Storage**.

A list of available disk storage devices appears; see Figure 33. By default, if more than one device is available, all of the devices are selected to be added. To de-select a disk storage device, click the box beside that device.

4. To add a disk, give the device a unique name. You can use only alphanumeric characters for the name. You cannot use the name “home” as that is the name of the primary hard disk of the RaQ 4.



**Note:** If you try to assign the name *home* to the second hard disk drive, you receive an error message stating “the name home is in use”.



**Note:** You can choose to check the integrity of the disk when adding the second hard disk drive. However, this option significantly increases the time it takes to format a drive. To enable this option, click the box in the Check column beside the hard disk drive.

5. Click **Confirm New Storage** to add the storage to the RaQ 4.

When adding a new virtual site to the RaQ 4, the RaQ 4 Administrator can choose where to store the new site. In the Add New Virtual Site table, next to the Maximum allowed disk space (MB) parameter, a pull-down menu lists in alphabetical order the available storage devices. The storage device with the most available space is chosen by default.

For more information, see “Adding a virtual site” on page 47.

## Suspend a virtual site

There are two ways to suspend a virtual site on the RaQ 4: a hard suspension and a soft suspension.

For more information on soft suspensions, see “Suspend a virtual site” on page 115.

### Hard suspension

A hard suspension occurs when a storage device is disabled through the UI or is disconnected from the RaQ 4. In this case, all virtual sites on that storage device are inaccessible. You cannot administer these sites, and users cannot receive email.

To disable an attached storage device:

1. On the **Server Management** screen, click **Maintenance** on the left. The File Backup table appears.
2. Click **Storage** at the top. The Storage in Use table appears.
3. Click the green pencil icon next to the disk you want to disable.
4. Click the Enable disk check box so that it is de-selected.
5. Click **Confirm Modify**. The browser returns to the previous screen.

## Reboot

Rebooting the RaQ 4 sometimes cures problems with certain services. The Active Monitor software recommends when a reboot is necessary.

To reboot the RaQ 4 through your browser:

1. On the **Server Management** screen, click **Maintenance** on the left. The File Backup table appears.
2. Click **Reboot** at the top. The Reboot Cobalt Server table appears.
3. A warning appears that rebooting the Cobalt server will make it unavailable to the network for a while.

Click **Reboot**.

You can also reboot the RaQ 4 through its LCD console; refer to “Rebooting” on page 154.

The reboot process can take a few minutes.

## Shutdown



**Caution:** Turning off the power switch before the RaQ 4 tells you to do so can result in lost or corrupted data.

The RaQ 4 can only be shut down from the LCD console located on the front of the unit. Refer to “Powering down” on page 155. Shutting down may take as long as a few minutes.

## Support tools

The Support Tools feature is a Web page that assists Technical Support in diagnosing problems on a RaQ 4 unit.

On the **Server Diagnostics** screen, the RaQ 4 Administrator can create and download a data dump of the configuration files on the RaQ 4. This data dump can then be emailed to **diagnostics@cobalt.com**. A member of the Technical Support team can then evaluate the condition of your RaQ 4 before providing you with corrective action, either by telephone or email.

If the RaQ 4 Administrator is familiar with Linux, he or she can look through this file in an effort to determine the problem with the RaQ 4. The file is a standard gzip file.

To access the **Server Diagnostics** screen:

1. From any screen, click the **Cobalt logo** in the top left corner.

A table listing Server Configuration Information appears. The table lists the amount of random access memory (RAM) and the size of the hard disk drive.

The table also lists trademark information for Cobalt Networks and for all other products and companies referred to in the UI.

2. In the list of links, click **Server Diagnostics**. The Diagnostic Header Data table appears.

3. The information entered in the following fields is incorporated into the header information of the diagnostic dump.
  - your full name
  - the name of your company or organization (optional)
  - if you are emailing the diagnostics dump to Cobalt Networks, then indicate whether you want to be contacted by email or telephone
  - your complete telephone number, if you want to be contacted by telephone
  - your email address, if you want to be contacted by email
  - a description of the problem you are having



**Note:** If the problem is with a particular user or site, **please be specific.**

4. Click **Save Changes**.

This creates the diagnostic dump of your configuration files. A file window appears and prompts you to enter a location on your computer where you want to store the file created.

5. If you are familiar with Linux, you can open this file and look through it to determine the problem. Or you can email the file as an attachment to **diagnostics@cobalt.com**.
6. When Cobalt Networks receives the diagnostic file by email, a problem ticket is created for your case.

# Site Usage

The Site Usage feature allows the RaQ 4 Administrator to monitor the amount of bandwidth consumed by Web, email and FTP traffic generated by the virtual sites on a RaQ 4.

For the Site Usage feature on the **Site Management** screen, see “Site Usage” on page 126.

The RaQ 4 can generate traffic-based bar graphs for a particular virtual site. The bars for Total Usage traffic can be viewed separately side-by-side or stacked on top of each other in a single bar to indicate the total amount of data (MB).

The reports are generated each night at 1:00 a.m. and statistics are updated once daily for all services.

Figure 34 shows the a sample of a Total Usage summary report.

**Figure 34.** Sample of a Total Usage summary report

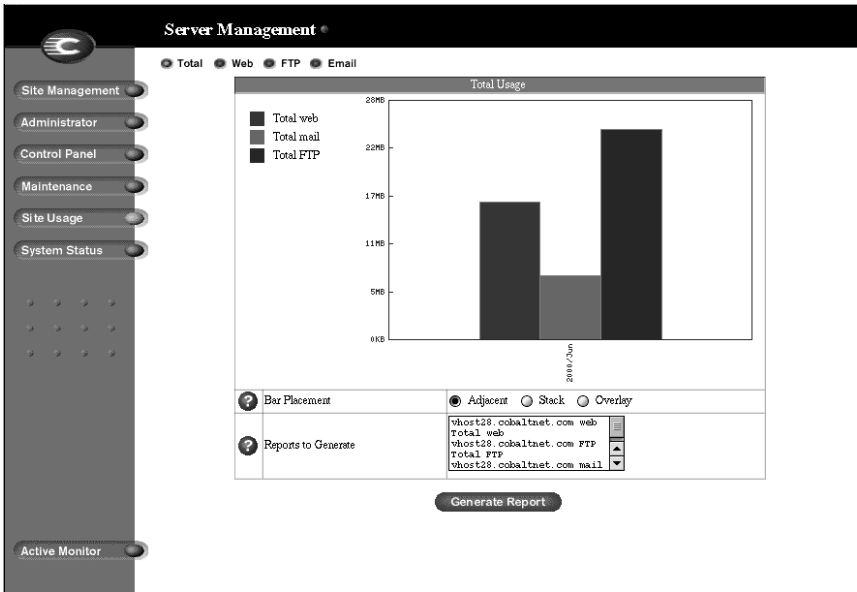

To use the Site Usage function:

1. On the **Server Management** screen, click **Site Usage** on the left. The Total Usage bar graph appears.
2. Below the Total Usage bar graph is an option for changing the bar placement on the graph.

Click the radio button for the selected type of placement and click **Generate Report**. The browser regenerates the Total Usage graph and displays the bars as you selected.

3. In the Reports to Generate window, you can select the virtual sites for which you want to generate the Total Usage bar graph.

Click **Generate**. The browser regenerates the Site Usage screen according to the report criteria chosen.

4. To view Web, FTP or Email usage statistics, click that option at the top.
  - **Web** displays the Web Usage table for the virtual site.
  - **FTP** displays the FTP Usage table for the virtual site.
  - **Email** displays the Email Usage table for the virtual site.

Each option also displays a second table for Other Usage Statistics. Click on any of the links in the Other Usage Statistics table for more detailed information.

## System Status

The System Status section allows the RaQ 4 Administrator to monitor the CPU, memory, disk and network status, as well as the services running on RaQ 4. In all cases, the RaQ 4 monitors the status of each of the subsystems and displays a green, amber, red or grey circle beside each item. See Figure 35.

The status of the system components and services is monitored by a Cobalt Networks utility called Active Monitor. For more information, see “Active Monitor” on page 93.

Figure 35 shows the System Status tables.

Figure 35. System Status tables

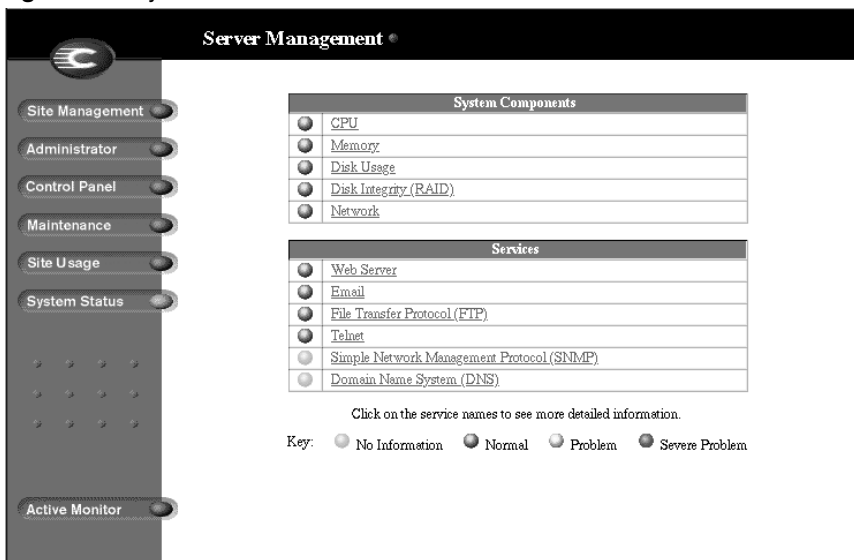

To view the status of the various system components and services:

1. On the **Server Management** screen, click **System Status** on the left or **Active Monitor** at the bottom left. A table displays the status of the system components and the services.
  - **Green** indicates correct functioning.
  - **Amber** indicates a potential problem.
  - **Red** indicates that a problem exists.
  - **Grey** indicates that a component or service is inactive or that no information is available yet.
2. Click on the name (shown as a hypertext link) of the system component or service to display more detailed information.
3. Click **Back** to return to the previous screen.



## **System components**

### **Central processing unit (CPU)**

The CPU Usage table provide real-time statistics on the CPU load over the previous 15 minutes. The table also displays:

- the CPU load average over the previous 15 minutes
- the temperature of the processor
- the amount of time that the system has been running

### **Memory**

The Memory table displays the load on the memory over the previous 15 minutes. The table also displays:

- the total memory on the system
- the amount of free available memory
- the amount of memory in use and the percentage of the total memory that this represents

If you see a red light in this chart, you may want to add more memory to the RaQ 4.

### **Disk**

A Disk Usage Summary describes the total disk space occupied by system files, by virtual sites and site users, the amount of free disk space left and the total size of the disk.

### **Network**

The Network Usage table displays, for the Network 1 and Network 2 ethernet connections, the statistics for the number of network packets successfully sent and received, the number of bytes of data successfully sent and received, the total number of errors when sending or receiving network packets, and the number of attempts to send several network packets at the same time (the number of collisions).

## Services

The Service Status section allows you to monitor Web, email, FTP, telnet, DNS and SNMP services. It follows the same LED conventions as the System Status section.

### Web server

The Web server table displays the status of the Web server (green, amber, red or grey) and a text message.

### Email

The Email services table displays the status of the POP3 server, the IMAP4 server and the SMTP service. This chart indicates whether these servers are operating normally.

### File transfer protocol (FTP)

The file transfer protocol (FTP) status chart displays the status of the FTP server's operation (normal or otherwise) and a text message.

### Telnet

The telnet table displays the status of the telnet server's operation (normal or otherwise) and a text message.

### Simple Network Management Protocol (SNMP)

The Simple Network Management Protocol (SNMP) table displays the status of the SNMP server's operation (normal or otherwise) and a text message.

### Domain Name System

The DNS table denotes whether DNS is active and whether it is operating properly. For more information on DNS, see Appendix D, "Domain Name System".

# Active Monitor

The RaQ 4 uses Active Monitor software. Active Monitor is a Cobalt Networks utility that runs on a RaQ 4 and updates key system information every 15 minutes.

Active Monitor status is displayed on the **Server Management** screen only.

Active Monitor checks:

- the status of the RaQ 4 (functioning, warning of failure, failed or inactive)
- the status of the services on the RaQ 4

Table 4 explains the colors of the circles in Active Monitor.

To access Active Monitor, click **Active Monitor** or **System Status** on the **Server Management** screen. To view the details for a system component or service, click the name (shown as a hypertext link).

**Table 4.** Colors and status indicators

Color	Description
Green	Correct functioning
Yellow	Advance warning of potential problems that should be investigated by the RaQ 4 Administrator (for example, low amount of space on the hard disk drive)
Red	Failure
Grey	Inactive or information is not yet available



# Site Management

---

There are three types of users on the RaQ 4: the RaQ 4 Administrator, Site Administrators and site users.

This chapter describes the functions that the Site Administrator normally performs. As the Site Administrator, you access these functions from the **Site Management** screen on the RaQ 4. The **Site Management** screen has a green strip on the left side.

You can add or remove a site user, create a mailing list, manage disk space, back up and restore files and perform other virtual-site-related administrative tasks. (These functions can also be performed by the RaQ 4 Administrator.)

You can manage a virtual site using any standard Web browser. To access the **Site Management** screen for your site, type the URL `http://<sitename>/siteadmin/` into your browser. The RaQ 4 user interface (UI) prompts you for your site administrator user name and password.



*Note:* The **Site Management** screen can only be accessed using the fully qualified site name in the Web browser. The **Site Management** screen is not accessible if an incomplete or aliased site host name is specified.

To access the **Site Management** screen, click **Site Management** on the **Server Management** screen. The **Site Management** screen appears. From this screen, you can access the Site Administrator functions; see Figure 36.

The User Management section appears when you first access the **Site Management** screen. The User List displays the site users by user name in ascending order.

The User List has five columns which display information about the each site user, and allow the RaQ 4 Administrator or Site Administrator to manage or remove a site.

- The first column displays the full name of the site user.
- The second column displays the user name of the site user.
- The third column displays the email alias(es) of the site user.
- The fourth column displays icons to indicate which services are enabled (telnet/shell access, FrontPage Server Extensions or Secure POP3 [APOP]), to indicate that a site user is the Site Administrator, or to indicate that a site user is suspended.
- The fifth column displays icons to manage a site user or the email settings for the site user, or to remove a site user.

For an explanation of the icons, see “Icons used on the UI and in the manual” on page 11.

To access a section of the **Site Management** screen, click the section button along the left side of the screen. These functions are described in the following sections.

**Figure 36.** Site management

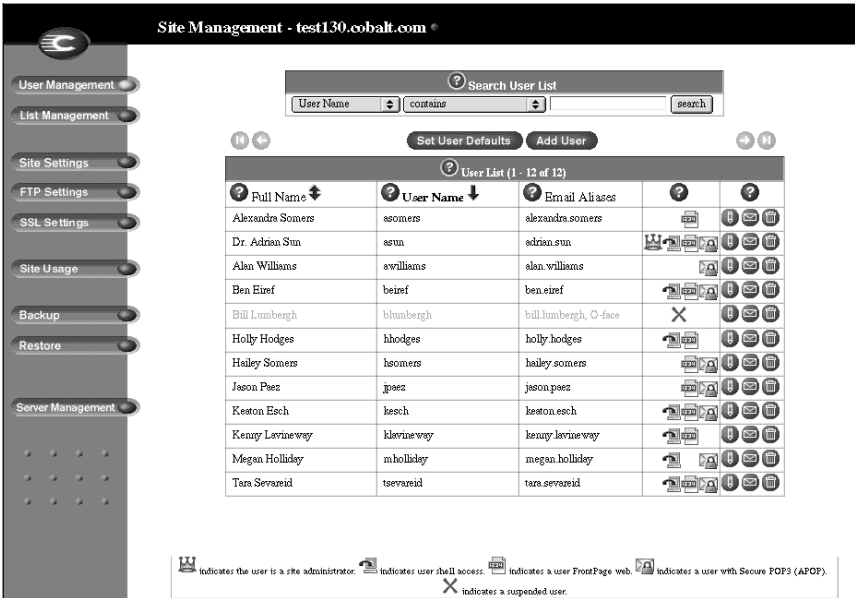

# User management

The User Management section on the **Site Management** screen allows you to perform administrative functions related to site users: setting the site user defaults, adding or removing users; entering and modifying user names and passwords; managing users' disk space allocations, telnet access and email aliases.

## Setting defaults for a site user

Before assigning the default values for a site user, you must decide on the needs of your users.

Both the Site Administrator and the RaQ 4 Administrator can configure the site user default settings.

Figure 37 shows the screen for configuring the default settings of a site user.

**Figure 37.** Default settings for a site user

Site Management - test130.cobalt.com

User Defaults	
Max. Allowed Disk Space (MB)	20
Telnet/Shell Access	<input type="checkbox"/>
Enable FrontPage User Web	<input type="checkbox"/>
Secure POP3 (APOP)	<input type="checkbox"/>
Number of Users to Display per Page	15
User Name Generation	<input checked="" type="radio"/> first initial plus last name. (e.g. jsmith) <input type="radio"/> last name. (e.g. smith) <input type="radio"/> first name. (e.g. jessica)

Save Changes Cancel

## Modifying the default user settings

To modify the default settings for a site user:

1. On the **Site Management** screen, click **Set User Defaults**. The User Defaults table appears.
2. Enter the information for the site. You can set the default value for
  - the maximum allowed disk space (MB) available to a newly created user for their file storage and Web pages
  - the number of sites users to display at one time in the user list on the screen



**Note:** If there are more site users on a virtual site than the value you enter here, navigation buttons for scrolling through the User List table become active at the top of the table.

- the format for generating user login names
  - initial plus last name
  - last name
  - first name

You can also enable or disable services for telnet/shell access, FrontPage User Web and Secure POP3 (APOP), if the RaQ 4 Administrator has enabled them for the virtual site.

3. Click **Save Changes**.

Once you have configured the default settings, you can adjust the settings for each site user that you add.



## Adding a site user

You can add or remove users for a virtual site, and assign a Site Administrator for the site.



**Caution:** On the **Site Management** screen for the main site (for the main site, the trashcan icon is grayed-out, meaning that you cannot delete it), the user settings for the RaQ 4 Administrator can be modified, including name and password.

Make sure you remember the RaQ 4 Administrator password. If you forget the password, see “Resetting the RaQ 4 Administrator password” on page 51 for instructions on resetting the password.

Figure 38 shows the screen for adding a site user or Site Administrator.

**Figure 38.** Adding a site user

The screenshot shows the 'Site Management - test130.cobalt.com' interface. On the left is a navigation menu with options: User Management, List Management, Site Settings, FTP Settings, SSL Settings, Site Usage, Backup, Restore, and Server Management. The main area displays the 'Add New User' dialog box with the following fields:

Add New User	
Full Name	<input type="text"/>
User Name	<input type="text"/>
Password	<input type="password"/>
Password (again)	<input type="password"/>
Max. Allowed Disk Space (MB)	<input type="text" value="20"/>
Telnet/Shell Access	<input type="checkbox"/>
Site Administrator	<input type="checkbox"/>
Enable FrontPage User Web	<input type="checkbox"/>
Secure POP3 (APOP)	<input type="checkbox"/>
Email Aliases	<input type="text"/>

At the bottom of the dialog are two buttons: 'Confirm New User' and 'Cancel'.

To add a site user or Site Administrator:

1. On the **Site Management** screen, click **Add User**. The Add New User table appears.
2. Enter the information for the site user.

Enter the site user's name and password, set the allocation of total disk space for the user, enable telnet/shell access (if appropriate), make them a Site Administrator (if appropriate), enable FrontPage user Web (if appropriate) and enable Secure POP3 (APOP) (if appropriate).



**Note:** The RaQ 4 supports long passwords through the UI. For guidelines on choosing a password, see “Password guidelines” on page 27.

You can also enter email aliases for this user. (For more information, see “Entering user email settings and aliases” on page 102.)

3. Click **Confirm New User**.

## Search and sort functions

The User List table offers a search function and a sort function; refer to Figure 36 on page 96. These functions are useful if you have a large number of site users on your RaQ 4 and you want to restrict the display to certain site users.

You can search the list of site users according to the following criteria:

- by user name, full name or email alias
- whether the user name, full name or email alias is equal to the search string, is contained in the search string or is not contained in the search string

The screen regenerates and the results of the search are displayed in a table with the same five columns. The heading of the table now states “Search Results (<x> Users found). To return to the full list of site users, click **User Management** on the left.



**Note:** Suspended users are listed in the search results.

You can sort the list of site users according to the following criteria:

- by full name, in ascending or descending order
- by user name, in ascending or descending order

Ascending order means from lowest value to the highest value (a–z or 1–9).

Descending order means from highest value to the lowest value (z–a or 9–1). By default, the User List table is sorted by user name in ascending order.

The screen regenerates and the results are displayed in a table with the same five columns. In the heading of the column which has been sorted, a blue arrow icon points up (ascending order) or down (descending order). In the heading of the column which has not been sorted, a double-ended arrow indicates that the order for the column is random.

You can use the search and sort functions together to produce the display that you need. For example, you can search the list for all site users with “joe” in the full name, and sort the results of that search by email alias in ascending order.

## **Searching a list of site users**

To search the list of site users:

1. In the first field of the Search User List window, select “User Name”, “Full Name” or “Email Alias” from the pull-down menu.
2. In the second field, select “is”, “contains” or “does not contain” from the pull-down menu.
3. In the third field, enter the string of characters for which you want to search.
4. Click **Search**. The screen regenerates and displays the results in a table with the same five columns.

## **Sorting a list of site users**

To sort the list of site users:

1. To sort according to Full Name, click on the blue arrow icon in the heading of the Full Name column. To sort according to User Name, click on the blue arrow icon in the heading of the User Name column.
2. To sort in ascending (up arrow icon) or descending order (down arrow icon), click on the blue arrow icon so that it points in the correct direction.
3. The screen regenerates and displays the results in a table with the same five columns.

## Removing a site user

To remove a site user:

1. In the User List table on the **Site Management** screen, locate the site user that you want to remove.
2. Click the brown trashcan icon next to the site user. A confirmation dialog box appears.
3. Click **OK** to delete the site user's account and files.

## Entering user email settings and aliases

### Mail Forwarding and Vacation Reply

Individual site users can choose to have their RaQ 4 email forwarded to another email account. Site users can also choose to enable a vacation-reply message that is automatically sent to each person who sends the user an email. This feature is useful when users know they will not be reading or responding to incoming email messages for a period of time.

As the Site Administrator, you can enter these email settings for site users (at their request) as described in “Changing user settings” on page 104.



**Note:** A vacation-reply email is sent only once per week to each sender.

## **Email aliases**

The Email Alias feature allows you to create an arbitrary e-mail addresses without creating a user account on the RaQ 4. An email message addressed to the alias is forwarded to an existing email address. For example, an email alias lets you setup a temporary or permanent alias email address such as sales@mycompany.com and automatically route messages to a specific email user.

Each registered user on the RaQ 4 must have a user name that is unique across all virtual sites on the RaQ 4. You cannot create two users with the same name on different virtual sites because all users share the same password database file in the underlying operating system. For example, if there is a user with the user name <mary> on virtual site abc.com, no other registered user on the RaQ 4 can have the user name <mary>. However, user names can be similar: mary, maryb, mary1, mary2.

An email alias is a way to create an account so that more than one user can have the same email name on different virtual sites (<mary> on abc.com and <mary> on xyz.com). However, the underlying user name for each person must be unique.

For example, the Site Administrator of abc.com can give Mary Brown the user name <mary>; her email address is mary@abc.com. The Site Administrator of xyz.com (on the same RaQ 4 server) can give Mary Smith the user name <marys>; the Site Administrator for xyz.com can then set up an email alias mary@xyz.com for Mary Smith. The alias points her incoming messages to the unique user name of <marys> at xyz.com.

A site user can have several email aliases that point to a unique user name. For example, John Smith (user name <john1>) can have john@abc.com, JS@abc.com, john.smith@abc.com, johnny@abc.com and corvette@abc.com which all point to his user name of <john1> at abc.com.

A Site Administrator can also set up useful aliases such as webmaster@abc.com, info@abc.com, sales@abc.com, comments@abc.com or support@abc.com that point to a specific user name.

## **Adding an email alias**

To add an email alias for a site user, see “Modify email options for a site user” on page 105.

To create a catch-all account on a virtual site, see “Catch-all email account” on page 107.

## Changing user settings

### Modify settings for a site user



To modify the settings for a site user (to change the name, password, disk space allocation or telnet access for an existing user, to enable FrontPage Web use or Secure POP3 [APOP], to make an existing user the Site Administrator or to suspend a site user), click the green pencil icon.

1. On the **Site Management** screen, click **User Management** on the left. The User List table appears.
2. Click the green pencil icon for the site user. The Modify User table appears. See Figure 39.
3. Enter the changes in the Modify User table.



**Note:** The RaQ 4 supports long passwords through the UI. For guidelines on choosing a password, see “Password guidelines” on page 27.

4. Click **Confirm Modify**.

Figure 39 shows the screen for modifying a site user.

**Figure 39.** Modifying a site user

The screenshot shows the 'Site Management - test130.cobalt.com' interface. On the left is a navigation menu with options: User Management, List Management, Site Settings, FTP Settings, SSL Settings, Site Usage, Backup, Restore, and Server Management. The main area displays the 'Modify User' form with the following fields:

Modify User	
Full Name	Emmy Lavineway
User Name	klavineway
Password	
Password (agate)	
Max. Allowed Disk Space (MB)	120
Telnet/Shell Access	<input checked="" type="checkbox"/>
Site Administrator	<input type="checkbox"/>
Enable FrontPage User Web	<input checked="" type="checkbox"/>
Secure POP3 (APOP)	<input type="checkbox"/>
Suspend User	<input type="checkbox"/>

At the bottom of the form are two buttons: 'Confirm Modify' and 'Cancel'.

## Modify email options for a site user



To set up or modify the email options for a site user (to enter a forwarding email address, email aliases and an automatic vacation reply), click the blue envelope icon. These options are described in “Entering user email settings and aliases” on page 102.

1. On the **Site Management** screen, click **User Management** on the left. The User List table appears.
2. Click the blue envelope icon for the site user. The Email Settings table appears. See Figure 40.
3. To add a forwarding email address, enter the email address in the Forward Email To field.
4. To add an email alias, enter the additional names that the user will receive email as in the Email Aliases window. For example, for user <john1>, enter “john.smith”, “johnny” and “corvette”.

To add several aliases, enter each alias on a separate line.



**Note:** DO NOT add the domain name to the additional names. Since the site user is part of the virtual site, he or she automatically inherits the domain name of the virtual site. If you do add the domain name in the Email Aliases field (for example, johnny@abc.com), the software gets confused.

5. To enable an automatic vacation reply, click the check box in the Vacation Message field and enter your message in the window.
6. Click **Save Changes**.

Figure 40 shows the screen for modifying a site user's email options.

**Figure 40.** Modifying a site user's email options

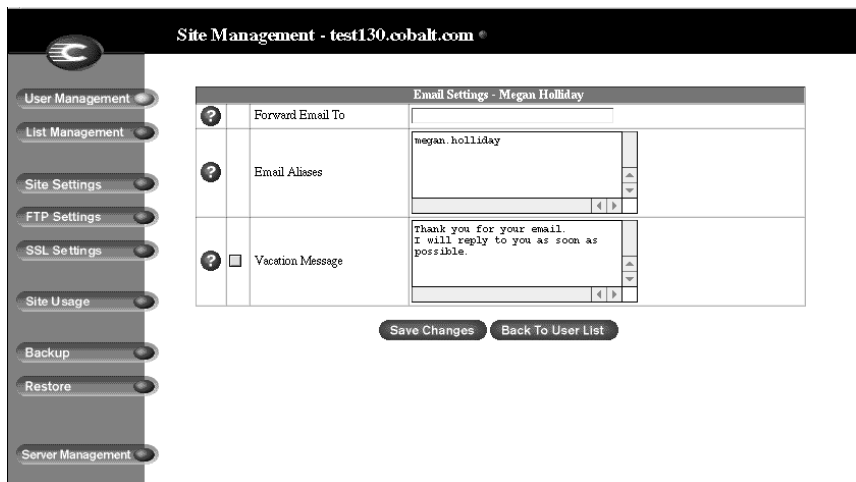



## Catch-all email account

A catch-all email account receives emails addressed to former users or non-existent users on a virtual site. For example, if an email is addressed to mary@xyz.com but the user name “mary” does not exist on that domain, the email is routed to the catch-all account.

A RaQ 4 Administrator or a Site Administrator can create a catch-all email account. This involves simply creating a certain alias for a designated user on the virtual site; this user does not have to be the Site Administrator.

For the user on a virtual site who will receive the messages routed to the catch-all account, the RaQ 4 Admin creates an email alias of “@<hostname.domainname>”. The <hostname.domainname> is the fully qualified domain name of the virtual site.

1. On the **Site Management** screen, click **User Management** on the left. The User List table appears.
2. Click the blue envelope icon for the site user who will receive the email for the catch-all account. The Email Settings table appears. See Figure 40.
3. Enter “@<hostname.domainname>” in the Email Aliases window.

If there is already an alias in the window, add this new alias on a separate line.

4. Click **Save Changes**.

## Remove a site user



To remove a site user, click the brown trashcan icon. See “Removing a site user” on page 102.

# Mailing list management

In the List Management section of the Site Management screen, you can create and manage mailing lists for the virtual site.

A mailing list allows a discussion by email between a group of people; the email addresses of the people in the group make up the list. The mailing list is given a name, for example AlphaProject. The mailing list can include users on the RaQ 4 as well as external users.

A message addressed to the name of the mailing list is delivered to each person on the list.

When replying to a mailing-list message, you can reply either to the original sender only or to the entire mailing list. This function depends on the email client that you are using.

Figure 41 shows the Mailing Lists table in the List Management section.

**Figure 41.** Mailing Lists table

The screenshot shows the 'Site Management - test130.cobalt.com' interface. On the left is a sidebar with navigation buttons: User Management, List Management (selected), Site Settings, FTP Settings, SSL Settings, Site Usage, Backup, Restore, and Server Management. The main area has a header 'Add Mailing List' and a table titled 'Mailing Lists'.

Name	Recipients	
all	asomers, asun, avilliams, beiref, blumbergh, hhodges, hsomers, ipaez, kesch, klavinevwy, mholliday, tsevareid	[?] [X]
documentation	avilliams, blumbergh, kesch, klavinevwy	[?] [X]
hr	asomers, klavinevwy, mholliday, tsevareid	[?] [X]
marketing	beiref, hsomers, ipaez	[?] [X]
sales	asomers, hhodges, mholliday	[?] [X]

## Adding a mailing list

To add a mailing list on the RaQ 4:

1. On the **Site Management** screen, click **List Management**. The Mailing List table appears.
2. Click **Add Mailing List**. The Add Mailing List table appears. See Figure 42.
3. Enter a name for the mailing list.
4. Enter a password for the mailing list. You need the password for managing the mailing list.



**Note:** The RaQ 4 supports long passwords through the UI. For guidelines on choosing a password, see “Password guidelines” on page 27.

5. The Allow user subscriptions to list option allows the individual users to subscribe to or unsubscribe from the mailing list. The user sends an email to **majordomo@<hostname.domainname>** with the words “subscribe listname” or “unsubscribe listname” in the body of the message. Replace the word listname with the name of the mailing list.

To enable this option, click the check box next to Allow user subscriptions to list.

6. To accept email addressed to the mailing list from an email address that is not a member of the list, click the check box next to Allow unsubscribed posting to list.
7. Add recipients to the mailing list.
  - To add external recipients to the mailing list, enter the email addresses in the External Recipients field.
  - To include existing registered site users on the RaQ 4 in the list, click the user name in the scrolling window.

To select all the registered site users, click Select All.

To select individual recipients in the scrolling window, hold the down the Control key (Windows) or the Apple key (Macintosh) and click on the user names.

8. Click **Confirm New Mailing List**.

Figure 42 shows the Add Mailing List table in the List Management section.

**Figure 42.** Add Mailing List table

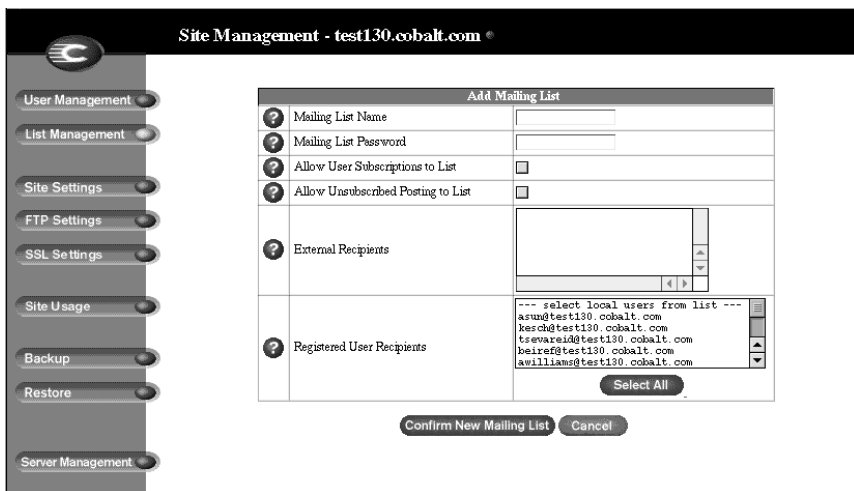

## Modifying a mailing list

To modify a mailing list:

1. On the **Site Management** screen, click **List Management**. The Mailing List table appears.
2. Click the green pencil icon next to the mailing list you want to modify. The Modify Mailing List table appears. See Figure 43.
3. Modify the information as necessary (see the procedure for adding a new mailing list for the options).
4. Click **Confirm Modify**.

Figure 43 shows the Modify Mailing List table in the List Management section.

**Figure 43.** Modify Mailing List table

The screenshot shows the 'Modify Mailing List' interface for the mailing list 'sales' at test130.cobalt.com. The interface includes a sidebar with navigation options and a main form area. The form contains the following fields and options:

Modify Mailing List - sales@test130.cobalt.com	
Mailing List Name	sales
Mailing List Password	abc
Allow User Subscriptions to List	<input type="checkbox"/>
Allow Unsubscribed Posting to List	<input type="checkbox"/>
External Recipients	<input type="text"/>
Registered User Recipients	jpaenz@test130.cobalt.com klavineway@test130.cobalt.com mholliday@test130.cobalt.com asomers@test130.cobalt.com hhodgner@test130.cobalt.com hlumbergh@test130.cobalt.com

Buttons: Confirm Modify, Cancel, Select All

## Removing a mailing list

To remove a mailing list:

1. On the **Site Management** screen, click **List Management**. The Mailing List table appears.
2. Click the brown trashcan icon next to the mailing list you want to delete. A confirmation dialog box appears.
3. Click **OK** to delete the mailing list.

## Site settings

Only the RaQ 4 Administrator can modify virtual site settings. For Site Administrators who are not the RaQ 4 Administrator, the Site Settings section is a read-only status page.

For an explanation of the fields on the Site Settings table, see “Overview of virtual sites” on page 41.

For a view of the Site Settings table, see Figure 44.

In the Site Settings section of the **Site Management** screen, you can:

- view the IP address, host name and domain name of the virtual site
- enable or disable Web server aliases
- enable or disable email server aliases
- change the maximum allowed disk space for the virtual site
- limit the number of site users on a virtual site
- enable or disable access to telnet/shell accounts, CGI scripts, SSL, server side includes, FrontPage server extensions, Active Server Pages (ASP), PHP and Secure POP3 (APOP)
- suspend the virtual site

## Changing site settings



To change the settings for a particular virtual site, click the green wrench icon. For an explanation of the fields on the Site Settings table, see “Overview of virtual sites” on page 41.



**Note:** Only the RaQ 4 Administrator can modify the settings for a virtual site. For Site Administrators who are not the RaQ 4 Administrator, the Site Settings section is a read-only status page.

Figure 44 shows the screen for changing the site settings of a virtual site.

**Figure 44.** Changing the site settings of a virtual site

The screenshot shows the Site Management interface for test130.cobalt.com. The left sidebar contains navigation options: User Management, List Management, Site Settings (selected), FTP Settings, SSL Settings, Site Usage, Backup, Restore, and Server Management. The main content area displays the Site Settings table.

Site Settings	
IP Address	10.9.28.130
Host Name	test130
Domain Name	cobalt.com
Web Server Aliases	
Email Server Aliases	
Max. Allowed Disk Space (MB)	200 on the volume "home"
Maximum Number of Users	25
Enable FrontPage Server Extensions	<input checked="" type="checkbox"/>
Enable Secure Sockets Layer (SSL)	<input checked="" type="checkbox"/>
Enable Active Server Pages (ASP)	<input checked="" type="checkbox"/>
Enable PHP Embedded Scripting	<input checked="" type="checkbox"/>
Enable Shell Accounts	<input checked="" type="checkbox"/>
Enable Secure POP3 (APOP)	<input checked="" type="checkbox"/>
Enable CGI Scripts	<input checked="" type="checkbox"/>
Enable Server Side Includes	<input checked="" type="checkbox"/>
Suspend Site	<input type="checkbox"/>

At the bottom of the table is a "Save Changes" button.

To change settings for a particular site:

1. On the **Site Management** screen, click **Site Settings** on the left side. The Site Settings table appears.
2. In the Site Settings table, you can set the values of the fields or enable the services:
  - a. IP Address
  - b. Host name
  - c. Domain name
  - d. Web server aliases
  - e. Email server aliases
  - f. Maximum allowed disk space (MB)
  - g. Maximum number of users
  - h. Enable FrontPage Server Extensions
  - i. Enable Secure Sockets Layer (SSL)
  - j. Enable Active Server Pages (ASP)
  - k. Enable PHP Embedded Scripting
  - l. Enable shell accounts
  - m. Enable Secure POP3 (APOP)
  - n. Enable CGI scripts
  - o. Enable Server Side Includes
  - p. Suspend Site



**Note:** A Site Administrator does not see the Suspend Site option.

3. Click **Save Changes**.



Common gateway interface (CGI) allows users to have Web sites run programs that dynamically generate HTML pages in response to specific user inputs. CGI scripts can be created on a user's desktop computer and then transferred to the RaQ 4 with a file transfer protocol (FTP) application (as explained in Chapter 5). CGI scripts must have a .pl or .cgi filename extension.

If the "Accept email for domain" function is selected, site users can retrieve email using the address <username>@domain.com. For example, if the host name of the site is raq1 and the domain name is abc.com, users can receive mail addressed to both <username>@raq1.abc.com and <username>@abc.com.

## Suspend a virtual site

There are two ways to suspend a virtual site on the RaQ 4: a hard suspension and a soft suspension.

For more information on hard suspensions, see "Suspend a virtual site" on page 85.

### Soft suspension

The RaQ 4 Administrator can suspend an individual virtual site. All of the site users are denied access to telnet, FTP and POP3/IMAP/APOP services, as well as Web access to their files. The site user accounts do not receive email; messages bounce back to the original sender.

To suspend an individual virtual site:

1. On the **Site Management** screen, click **Site Settings** on the left.
2. At the bottom of the table, click the Suspend Site check box so that it is checked off.
3. Click **Save Changes**. The RaQ 4 saves the new configuration.
4. If you want to see that the site is suspended, click Server Management on the left.

In the Virtual Site List table, the entry for the suspended site shows a red X in the third column; the name and the IP address of the site are grayed-out.

## Suspend a site user

The Site Administrator or RaQ 4 Administrator can suspend a site user on a virtual site. The site user is denied access to telnet, FTP, POP3/IMAP/APOP services, as well as Web access to their files. The site user account however still receives email.

To suspend a site user:

1. On the **Site Management** screen, click the green pencil icon next to the site user you want to suspend. The Modify User table appears.
2. At the bottom of the Modify User table, click the Suspend User check box.
3. Click **Confirm Modify**.

The User List table appears. The entry for the suspended user shows a red X in the fourth column; the full name, the user name and the email alias of the user are grayed-out.

## FTP settings



**Important:** The RaQ 4 Administrator can enable anonymous FTP access on only one name-based virtual site per IP address. The UI does not allow the administrator to enable anonymous FTP on a second name-based virtual site that shares the same IP address.



**Note:** Only the RaQ 4 Administrator can modify the virtual site settings. For Site Administrators who are not the RaQ 4 Administrator, the FTP Settings section is a read-only status page.

The RaQ 4 Administrator can enable the anonymous FTP server for the site, set limits on the size of files that can be uploaded and set the number of simultaneous anonymous users. This feature allows users without passwords to download and upload files with an FTP-based application, up to the specified disk-space limit.

To change the FTP settings for your virtual site:

1. On the **Site Management** screen, click **FTP Settings** on the left. The FTP Settings table appears; see Figure 45.
2. Enter the settings you want. You can specify the number of megabytes of incoming files to accept and the number of simultaneous users.
3. Click **Save Changes**.

Figure 45 shows the FTP Settings table.

**Figure 45.** FTP Settings table

FTP Settings			
<input type="checkbox"/>	On, allow		
<input checked="" type="checkbox"/>		20	MB of incoming files
		10	simultaneous users

Save Changes

To download files by anonymous FTP, log on to the site with the user name *guest* or *anonymous*—you do not need to enter a password. When you log on with one of these user names, you enter the directory `/home/sites/<sitename>/ftp/`. The Site Administrator can post files here for downloading through FTP client software or a Web browser.

Site Administrators can access the anonymous FTP directory as “/ftp” during an FTP session.

To upload files, you must use FTP client software (for example, Fetch or WS-FTP) and access the directory `/home/sites/<sitename>/ftp/incoming/`. Once you have uploaded a file, you (as a guest) cannot see it or access it on the FTP site. All registered site users with telnet/shell privileges can access the file, but only the Site Administrator can access the file through FTP.

The size limit specified for FTP uploads is the total amount of disk space allocated for FTP uploads. If this number is set to 0, a guest cannot upload to the FTP site.

## SSL settings



The RaQ 4 Administrator can administer the RaQ 4 through secure sockets layer (SSL). SSL is provided in 128-bit encryption code and offers a secure Web connection to the end user. The implementation of SSL on the RaQ 4 is based on `mod_ssl` and BSAFE cryptographic software from RSA Security.

A secure connection means two things: encryption and authentication. Encryption ensures that no one can snoop the connection between the browser and the RaQ 4; authentication ensures the client, through a certificate, that the server is who they say they are. The security is assured on two levels.

At the network level, the first time the browser connects to a server, the browser stores the server's certificate. This is the encryption part of the secure connection. Each time the browser "thinks" that it is communicating with this same server, it verifies that this same certificate is used to assure the secure connection.

At a higher level, a server's certificate is "signed" by a trusted external authority that the browser knows about, such as VeriSign. This is the authentication part of the secure connection. The server information (country, state, city, organization) is encoded into the certificate and certificate request. The external authority signs your request and guarantees that your server information is legitimate.

For example, if a Web site sends a signed certificate saying that it comes from Cobalt Networks in Mountain View, California, United States, the end user can trust (due to the signed certificate from the external authority) that this Web site is indeed run by this company located in this city.

A self-signed certificate is a certificate that has not been signed by an external authority. A self-signed certificate simply ensures that an encrypted Web connection is in place; it does NOT provide authentication to a user that the server is who they say they are.

For more information on *authentication*, *encryption* and *SSL*, refer to Appendix F, "Glossary".

## Obtain an externally signed SSL certificate

Most users want to create an externally signed SSL certificate. For e-commerce, an externally signed SSL certificate is required.

To do this, the RaQ 4 Administrator must perform the following steps. These steps are explained in the following pages.

1. enable the SSL feature on a virtual site (see page 119)
2. generate a self-signed certificate (see page 120)
3. submit the information from the self-signed certificate to an external certification authority (see page 123)
4. receive the response and information from the external certification authority (see page 124)
5. in the SSL settings screen on the RaQ 4, replace the self-signed certificate with the information received from the externally signed certificate (see page 124)
6. save the changes on the RaQ 4

## Enable SSL on a virtual site



**Important:** The RaQ 4 Administrator can enable SSL on only one name-based virtual site per IP address. The UI does not allow the administrator to enable SSL on a second name-based virtual site that shares the same IP address.



**Note:** Only the RaQ 4 Administrator can modify the virtual site settings. For Site Administrators who are not the RaQ 4 Administrator, the SSL Settings section is a read-only status page.

To enable SSL on a virtual site:

1. Go to the **Server Management** screen.
2. Click the green wrench icon next to the virtual site on which you want to enable SSL. The **Site Management** screen appears.
3. Click **Site Settings** on the left side.
4. Click the check box next to Enable SSL.



**Note:** This feature only enables the public Web server; it does not enable the SSL administrative server. See “SSL certificate for the main site” on page 123.

5. Click **Save Changes**.

The RaQ 4 saves the configuration of the virtual site.

## Generate a self-signed certificate

Once you (as the RaQ 4 Administrator) have enabled SSL, the user must now create a self-signed certificate. The self-signed certificate can be signed later by an external authority.

1. On the **Site Management** screen, click **SSL Settings** on the left side. The Certificate Subject Information table appears. See Figure 46.
2. Enter the following information:
  - **Country** Enter the two-letter country code (for example, AU for Australia or US for United States).
  - **State** Enter the name of the state (for example, New South Wales or California).
  - **Locality** Enter the city or locality (for example, Sydney or Toronto).
  - **Organization** Enter the name of the organization (for example, The Widgets Corporation).
  - **Organizational Unit** As an option, enter the name of a department (for example, Hardware Engineering).
3. Select **Generate self-signed certificate** from the pull-down menu at the bottom.
4. Click **Save Changes**. The RaQ 4 processes the information and regenerates the screen with the new self-signed certificate in the Certificate Request and Certificate windows. See Figure 47.

Figure 46 shows the certificate subject information table for an SSL certificate.

**Figure 46.** Certificate subject information table for an SSL certificate

The screenshot displays the 'Site Management - test130.cobalt.com' interface. On the left is a navigation menu with options: User Management, List Management, Site Settings, FTP Settings, SSL Settings, Site Usage, Backup, Restore, and Server Management. The main content area is titled 'Certificate Subject Information' and contains a table with the following fields:

Certificate Subject Information	
Country	<input type="text"/>
State	<input type="text"/>
Locality	<input type="text"/>
Organization	<input type="text"/>
Organizational Unit	<input type="text"/>

Below the table is a 'Certificate Request' section, followed by a 'Certificate' section containing a large empty text area. At the bottom of the certificate area is an 'RSA SECURED' logo with a checkmark. Below the certificate area is a dropdown menu set to 'Use manually entered certificate' and a 'Save Changes' button.

Figure 47 shows the processed information of a self-signed SSL certificate.

Figure 47. Processed information of a self-signed SSL certificate

The screenshot shows the 'Site Management - test130.cobalt.com' interface. On the left is a sidebar with navigation options: User Management, List Management, Site Settings, FTP Settings, SSL Settings, Site Usage, Backup, Restore, and Server Management. The main content area is titled 'Certificate Subject Information' and contains a table with the following data:

Country	us
State	New Jersey
Locality	Cranbury
Organization	Cardolite
Organizational Unit	Sales

Below the table is the 'Certificate Request' section, which displays the following text:

```

-----BEGIN CERTIFICATE REQUEST-----
MIIBoQCgAgAQAwgZ8Z2aBgnvRATtAlVTMhWegYDVoQLEWg0EYc9mYc0V5
MREWwYDQoQMEwhcMwUwVYFEzMRKALUCBAHQzP93AKLlM4wADVoQL
EwVTVxLcZkEhBkGAlUEAzmSdovzAdEznc5JbzLhMqWV29TMSowQYTKozLlvcn
AgkFhhz02lghk02Xh0MThWlNAVtWf sdc5Jbz0wg28wQYVKozLlvcnAQEBBQAD
gY0MTCGAAoEAMK2whs1Eg9EUBS2V8+6IatSchh0+Elf0sEm7zMB3zsq0tP
MvYwZsE9ZLLf4VwD7T0GcXUaw0T0L6Hnmf3L0PAsznpQKz8q5zZKZmQY
OLCg0/0HPvkl3Bm0MEFcmz37XkEaj6A+cm1dA0RCYtqgdhShhMgMEAGG
ADANBgkqhkiG9w0BAQoFAoBQw9Izoc2IMlZBsgUAOeghndtHAzLc0F81LH
US0P15TGCz/9b8SMYk3Cw4dLlAcwV55AtMlLl8ozuzYtE1psePFd47m469
OL5zAVUdLlBAKZ2aMrcv85MwWkzAdSe0FtEQSLXJ3s407hFShFjYBzm8M
chW7sq==
-----END CERTIFICATE REQUEST-----
    
```

The 'Certificate' section shows a large text area with the following content:

```

VUJLEWpLzA0z9mYc0V5MREWwYDVoQLEWg0EYc9mYc0V5Z8Z2aBgnvRATtAlVTMhWegYDVoQLEWg0EYc9mYc0V5
z09saxk1Mq4wADVoQLEWg0EYc9mYc0V5Z8Z2aBgnvRATtAlVTMhWegYDVoQLEWg0EYc9mYc0V5Jbz0wg28wQYVKozLlvcn
I29TMSowQYTKozLlvcnAQEBBQADgY0MTCGAAoEAMK2whs1Eg9EUBS2V8+6IatSchh0+Elf0sEm7zMB3zsq0tP
MvYwZsE9ZLLf4VwD7T0GcXUaw0T0L6Hnmf3L0PAsznpQKz8q5zZKZmQYOLCg0/0HPvkl3Bm0MEFcmz37XkEaj6A+cm1dA0RCYtqgdhShhMgMEAGG
ADANBgkqhkiG9w0BAQoFAoBQw9Izoc2IMlZBsgUAOeghndtHAzLc0F81LHUS0P15TGCz/9b8SMYk3Cw4dLlAcwV55AtMlLl8ozuzYtE1psePFd47m469
OL5zAVUdLlBAKZ2aMrcv85MwWkzAdSe0FtEQSLXJ3s407hFShFjYBzm8MchW7sq==
-----END CERTIFICATE-----
    
```

Below the text area is a 'RSA SECURED' logo and a dropdown menu with the text 'Use manually entered certificate'. At the bottom is a 'Save Changes' button.



## SSL certificate for the main site

If the browser prompts you for your user name and password, you have enabled SSL on the main site of the RaQ 4. The browser prompts you since this secure connection is in fact a new connection to the RaQ 4.

Generating a certificate for the main site is a special case and causes three things to happen:

1. SSL is enabled for all RaQ 4 management screens (both server management and site management).
2. The SSL administration server is enabled for the RaQ 4.
3. The main site certificate request is propagated to all virtual sites that have SSL enabled but do not have their own certificate request.

Now that you have enabled SSL, you can access your virtual site over a secure connection at <https://<sitename>>.

For more information on obtaining an externally signed certificate, see “Submit the information to an external certification authority” on page 123.

Conversely, deleting the certificate from the main site removes the certificate from the virtual sites to which the certificate has been propagated.

## Enable the administration server for SSL

The RaQ 4 supports secure administration. The certificate generated for the main site is also used for secure administration. Therefore, to enable secure administration on a virtual site, generate a certificate for the main site on the RaQ 4 (if this has not already been done.)

## Submit the information to an external certification authority

To submit the information from the self-signed certificate to an external certification authority:

1. On the **SSL settings** screen, highlight and copy the information from the “Certificate Request” window of your self-signed certificate.
2. Open a new browser window and go to the Web site for one of the certification authorities (for example, VeriSign).
3. Paste the information from Step 1 in the window on the Web site of the certification authority. Follow the instructions on the Web site.

## Receive the response from the external certification authority

The certification authority either sends you a certificate by email or returns the information on the browser screen.

## Enter the information from the external certification authority

1. On the **Site Management** screen, click **SSL Settings** on the left side. The “Certificate Subject Information” table appears.
2. Highlight and remove the information currently in the “Certificate” window.



**Caution:** DO NOT choose **Delete certificate** from the pull-down menu at the bottom. This action deletes your SSL certificate and your private key, and you will then have to purchase a new SSL certificate from the external certification authority.

3. On the Web site or in the email from the external certification authority, highlight and copy the information received. (See “Receive the response from the external certification authority” on page 124.)
4. Return to the RaQ 4 browser window and paste the new certificate information that you copied in Step 3 into the “Certificate” window.
5. Select **Use manually entered certificate** from the pull-down menu at the bottom.
6. Click **Save Changes**.

The browser screen refreshes and the externally signed certificate appears. Figure 48 shows a sample of an externally signed certificate.

Figure 48. Sample of an externally signed certificate

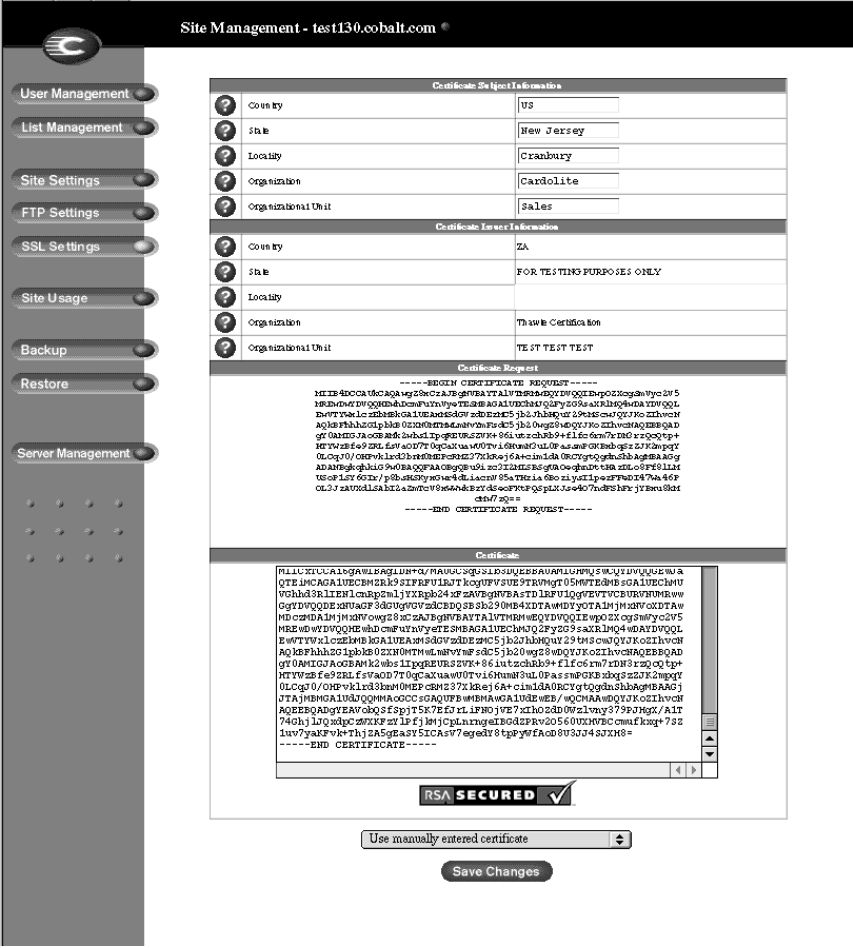

## Delete an SSL certificate



**Caution:** If you delete the SSL certificate, you delete the private key as well. If you delete the private key, you will need to purchase a new SSL certificate from the external certification authority.



**Note:** Deleting the certificate from the main site removes the certificate from the virtual sites to which the certificate has been propagated. In addition, it removes the secure connection to the administration server (it reverts from https: to http:).

If for any reason you want to delete an SSL certificate for a virtual site, perform the following steps.

1. Go to the **Server Management** screen.
2. Click the green wrench icon next to the virtual site on which you want to delete the certificate. The **Site Management** screen appears.
3. Click **SSL Settings** on the left side.
4. Select **Delete certificate** from the pull-down menu at the bottom.
5. Click **Save Changes**.

The RaQ 4 processes the information and regenerates the screen; the Certificate Request and Certificate windows are now blank.

## Site Usage

The Site Usage feature allows the Site Administrator to monitor the amount of bandwidth consumed by Web, email and FTP traffic generated by a virtual site as well as disk usage for the virtual site.

For the Site Usage feature on the **Server Management** screen, see “Site Usage” on page 88.

The reports are generated each night at 1:00 a.m and the statistics are updated once daily for all services; the results are presented in tables.

Figure 49 shows a sample summary of disk usage on a virtual site.

To use the Site Usage function:

1. On the **Site Management** screen, click **Site Usage** on the left. The Web Usage table appears.
  - **Web** displays the Web Usage table for the virtual site.
  - **FTP** displays the FTP Usage table for the virtual site.
  - **Email** displays the Email Usage table for the virtual site.
  - **Disk** displays information concerning the disk usage for the virtual site as a whole, as well as the disk usage for each site user.
2. The Web, FTP and Email options also display a table for Other Usage Statistics. Click on any of the links in the Other Usage Statistics table for more detailed information.

**Figure 49.** Sample summary of disk usage

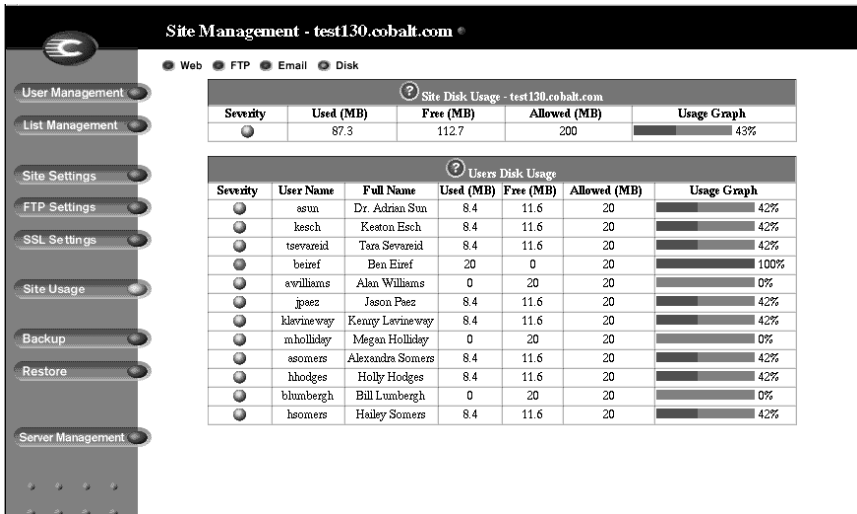

# Backup

As Site Administrator, you can perform different types of backups.



**Caution:** A backup captures data only (for example, email messages stored on the server or Web files). It does NOT back up the settings for virtual sites or users.



**Caution:** You can use Microsoft Internet Explorer 3.0 to back up a Cobalt server but not to restore a backup file. Upgrade to a later version of Internet Explorer or use a different browser software to restore the backup file.

## Manual backup

A Site Administrator can manually back up data stored on the RaQ 4.

1. On the **Site Management** screen, click **Backup**. The File Backup table appears. See Figure 50.
2. In “Data to Backup,” select the type of backup:
  - **All email, Web and user files on this site** This option backs up the files for all the site users (including the administrator) and email, as well as the site Web and FTP data.
  - **Files and email of user** This option backs up the files and email in-box for a specific user on this site.
3. To back up all files or to back up files changed within a certain time frame, choose from the pull-down menu adjacent to “Backup files modified in the last.”

You can choose “Backup all Files,” 31 days, 14 days, 7 days, 2 days or 1 day.

4. Click **Start Backup**.
5. Assign a path and a file name on your computer for storing the backup data. Click **Save**.

The file transfer takes several seconds to several minutes.



**Caution:** Do not interrupt or cancel the backup process. If you do, or if the file transfer fails for any other reason, delete the partial backup file stored on your personal computer and try again. If you attempt to use a partial file to restore data, you risk corrupting the data already stored on the server.

Figure 50 shows the File Backup table for a virtual site.

**Figure 50.** File Backup table for a virtual site

Site Management - test130.cobalt.com

Scheduled Backup

File Backup	
<p>⊛ Data to Backup</p>	<p><input checked="" type="radio"/> All email, web, and user files on this site</p> <p><input type="radio"/> Files and email of user: <input type="text" value="select a user"/></p>
<p>⊛ Backup files modified in the last</p>	<p><input type="text" value="Backup all Files"/></p>

Start Backup

## Scheduled backup

As Site Administrator, you can schedule regular automatic backups.

To schedule regular, automatic backups:

1. On the **Site Management** screen, click **Backup**. The File Backup table appears.
2. Click **Scheduled Backup**. The Scheduled File Backup table appears. See Figure 51.
3. Choose the frequency of the automatic backup:
  - **Daily** means nightly at 1 a.m.
  - **Weekly** means every Sunday morning at 1 a.m. (Saturday night going into Sunday morning)
  - **Monthly** means on the first of every month at 1 a.m.
4. In “Data to Backup,” select the type of Backup, as described in step 2 in “Manual backup” on page 128.
5. To back up all files or to back up files changed within a certain time frame, choose from the pull-down menu adjacent to “Backup files modified in the last.”
6. Choose a backup method.
  - **FTP Server** writes the backup file to an FTP server.
  - **NFS** places the backup file on a mountable NFS resource.
  - **SMB Server** (Windows File Sharing) places the backup file onto a directory shared from a Windows machine.
7. Enter a location for storing the backup data.

The location you specify depends in part on the backup method you select in step 6. See “Backup File Locations” below for an explanation of locations you can enter here.
8. If the backup destination associated with your method of backup requires a password for access, enter the password in this field. This field is ignored for the NFS and anonymous FTP methods. See “Backup file locations” on page 132.
9. Click **Save Changes**.



Figure 51 shows the Scheduled File Backup table for a virtual site.

**Figure 51.** Scheduled File Backup table for a virtual site

Site Management - test130.cobalt.com

User Management  
 List Management  
 Site Settings  
 FTP Settings  
 SSL Settings  
 Site Usage  
 Backup  
 Restore  
 Server Management

Scheduled File Backup	
? Frequency	Never
? Data to Backup	<input type="radio"/> All email, web, and user files on this site <input type="radio"/> Files and email of user: <input type="text" value="select a user"/>
? Backup files modified in the last	Backup all Files
? Method	NFS
? Location	<input type="text"/>
? Password	<input type="text"/>
? Please enter the password again for verification	<input type="text"/>

## Backup file locations

For a backup by an **FTP Server**:

- A location of `<username>@ftp.server.com` puts the backup file in the initial login directory.
- A location of `<username>@ftp.server.com/path/to/backups/` puts the backup file in the specified path on the server, using `<username>` to login.

For a backup by **Anonymous FTP**:

- For an anonymous FTP connection, the file must be put in a directory where anonymous FTP users have write access. This is generally the `/incoming/` directory.
- A location of `ftp.server.com/incoming` places the backup file on `ftp.server.com` under the `/incoming/` directory.
- The “Password” field should contain the password for the specified user or be left blank for anonymous logins.

For a backup by **NFS Server**:

- The location should be `<server>:/<share>`, where `<server>` is the NFS server and `<share>` is the NFS volume to mount and write to. You must have write privileges to this directory.
- The “Password” is ignored for NFS server backups.

For a backup by **SMB Server** (Windows File Sharing):

- The location should be `<user>@\\windowspc\<share>`. This mounts the volume share on the Windows server, using `<user>` as the login. The “Password” field must contain the password for `<user>`.
- For volumes that do not require a user, the location should be `\\windowspc\share`.

For **All Scheduled** backups:

- Ensure the target location is available and has enough disk space to hold the backup archive. Failure to do this may result in zero-length or truncated archives.

# Restore

You must restore data from the same machine on which the data was backed up. Site Administrators can restore files only to their own site.



**Caution:** The system restores data only (for example, email messages stored on the server or Web files). It does NOT restore virtual sites or site users to a RaQ 4.



**Caution:** You can use Microsoft Internet Explorer 3.0 to back up a Cobalt server but not to restore a backup file. Upgrade to a later version of Internet Explorer or use a different browser software to restore the backup file.



**Caution:** The system does not merge the current and backed up data. When data is restored, any changes made to files on the RaQ 4 since the last backup are lost.

Figure 52 shows the File Restore table for a virtual site.

**Figure 52.** File Restore table

The screenshot shows the 'Site Management - test130.cobalt.com' interface. On the left is a navigation menu with options: User Management, List Management, Site Settings, FTP Settings, SSL Settings, Site Usage, Backup, Restore, and Server Management. The main content area is titled 'File Restore' and contains a table with two rows:

File Restore	
Backup Archive	<input type="text"/> <input type="button" value="Browse..."/>
Selective Restore	<input checked="" type="checkbox"/>

Below the table is a button labeled 'Restore A Backup File'. A note below the button reads: 'NOTE: Please be careful not to interrupt an archive restore as data could be corrupted. In addition, you can only restore data for existing users and sites. Do not selectively restore sites or users that have been deleted.'

To restore a backup file:

1. On the **Site Management** screen, click **Restore** on the left. The File Restore table appears. See Figure 52.
2. Enter the path and filename of the backup file, or click **Browse** and select the file to restore.



**Note:** If the file does not appear in the list and you are using Netscape 4.x or Internet Explorer 4.x, you might need to change “File Type” in the desktop to “All Files.”

3. If you want to restore only some of the files, click **Selective Restore** and select those files.
4. Click **Restore A Backup File** below the File Restore table.



**Note:** Restoring large backup archives can cause your Web browser to time out. If you upload the .raq archive through an FTP-based application to the home directory of the Site Administrator, you can select the archive from a menu on the **Restore** screen.

Archive restores are not possible with Microsoft Internet Explorer version 3. If you experience problems uploading an archive, use a later version of Internet Explorer or use a different browser software to restore the archive.

Do not interrupt an archive restore because this can corrupt data. If the restore process is interrupted, the user can try to restore again.

To restore a user home directory or a site, make sure the user or site already exists.

When data is restored, the RaQ 4 and its corresponding parts (site, user and email) are returned to the exact state they were in prior to backup.

## **Server management**

If you are the RaQ 4 Administrator, you can return to the RaQ 4 **Server Management** screen. On the **Site Management** screen, click **Server Management** on the left.

For more information on managing the RaQ 4 server, see Chapter 3, “RaQ 4 Server Management”.

## **Publishing Web pages**

For information on publishing Web pages on the RaQ 4, see “Developing Web pages” on page 145, “Publishing Web pages using FTP” on page 146 and “Publishing Web pages with FrontPage for User Webs only” on page 147.



# Using Services on a Site

This chapter describes the functions that site users can perform on the RaQ 4. As a site user, you can change your user name and password, set email options, monitor the use of disk space in your directory, back up and restore your files, send and receive email, and create and upload Web pages and other files.

## Managing Your Personal Profile

You manage your directory using any standard browser. Access your directory by typing the URL `http://<sitename>/personal/` into your browser. You must enter your user name and password.

When you access your directory, the **Personal Profile** screen appears with the **Modify User** table; see Figure 53. The management functions available on the **Personal Profile** screen are described in the sections that follow.

**Figure 53.** Modify User table

The screenshot shows a web interface titled "Personal Profile". On the left is a vertical navigation menu with buttons for "Modify User", "Email", "Usage Data", "Backup", and "Restore". The "Modify User" button is highlighted. The main content area displays a "Modify User" table with the following fields:

Modify User	
Full Name	Dr. Adrian Sun
User Name	asun
Password	<input type="password"/>
Password (again)	<input type="password"/>

Below the table is a "Confirm Modify" button.

## Modify site user

You can change your full name and password. To modify your settings:

1. On the **Personal Profile** screen, click **Modify User**. The Modify User table appears. See Figure 53.
2. Change the settings.



**Note:** The RaQ 4 supports long passwords through the UI. For guidelines on choosing a password, see “Password guidelines” on page 27.

3. Click **Confirm Modify**.

## Email

The email section allows you to select email options.

Figure 54 shows the Email Settings table for a site user.

**Figure 54.** Email Settings table

The screenshot shows the 'Personal Profile' page with a sidebar on the left containing navigation options: 'Modify User', 'Email', 'Usage Data', 'Backup', and 'Restore'. The main content area is titled 'Email Settings' and contains a table with two rows. The first row is for 'Forward Email To' with an empty text input field. The second row is for 'Vacation Message' with a checkbox and a text area containing the text: 'Thank you for your email. I will reply to you as soon as possible.' Below the table is a 'Save Changes' button.

Email Settings	
?	Forward Email To <input type="text"/>
?	<input type="checkbox"/> Vacation Message <div style="border: 1px solid gray; padding: 2px;">Thank you for your email. I will reply to you as soon as possible.</div>

**Save Changes**



To set your email options:

1. On the **Personal Profile** screen, click **Email** on the left. The Email Settings table appears. See Figure 54.
2. In the Email Settings table, select the options that are described in the next two sections.
3. Click **Save Changes**.

## **Forward email to**

You can forward your RaQ 4 email to another email account.

In the Email Settings table, enter the destination email address in the Forward Email To field. Click **Save Changes**.

## **Vacation reply**

You can create a vacation-reply message that is automatically sent to each person who sends you email. This feature is useful when you know that you will not be reading or responding to incoming email messages for a period of time.

A vacation-reply email is sent only once a week to each sender.

To set up a vacation reply:

1. Click the Vacation Reply check box to enable the function.
2. In the scrolling field, type the text of the message you want to send to users while you are away.
3. Click **Save Changes**.

## Usage data

The Usage Data section displays a Disk Usage table showing information on your disk usage.

To view the Disk Usage table:

1. On the **Personal Profile** screen, click **Usage Data** on the left. The Disk Usage table appears. See Figure 55.
2. The Disk Usage table displays the following information:
  - the amount of disk space used (MB)
  - the amount of disk space free (MB)
  - the amount of disk space allowed (MB)
  - a usage bar showing how much space has been used (percentage)

Figure 55 shows the Disk Usage table for a site user.

**Figure 55.** Disk Usage table

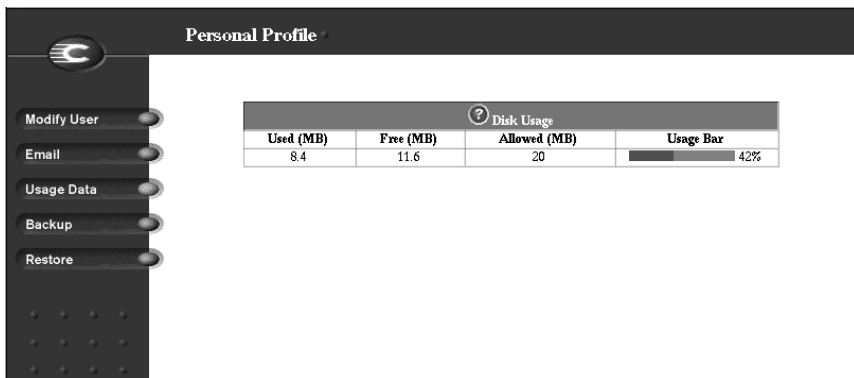

## Backup

As a site user, you can back up your files. When you click “Backup My Files”, your Web browser provides a default filename and path. This file contains all of your backup data, including your home directory files, your email inbox and your vacation autoresponder message. It does NOT back up the settings for your virtual site.

You can change the path or the filename, but the file MUST have the extension .raq in order for the Restore function to work properly.



**Caution:** A backup captures data only (for example, email messages stored on the server or Web files). It does NOT back up the settings for virtual sites or users.



**Caution:** Do not interrupt or cancel the backup process. If you do, or if the file transfer fails for any other reason, delete the partial backup file stored on your personal computer and try again. If you attempt to use a partial file to restore data, you risk corrupting the data already stored on the server.

To back up your files:

1. On the **Personal Profile** screen, click **Backup** on the left. The File Backup table appears. See Figure 56.
2. Follow the on-screen instructions. You can change the path or the filename, but the file **MUST** have the extension **.raq** in order for the Restore function to work properly.
3. When you are ready to perform the backup, click **Backup My Files**.

Figure 56 shows the File Backup table for a site user.

**Figure 56.** File Backup table

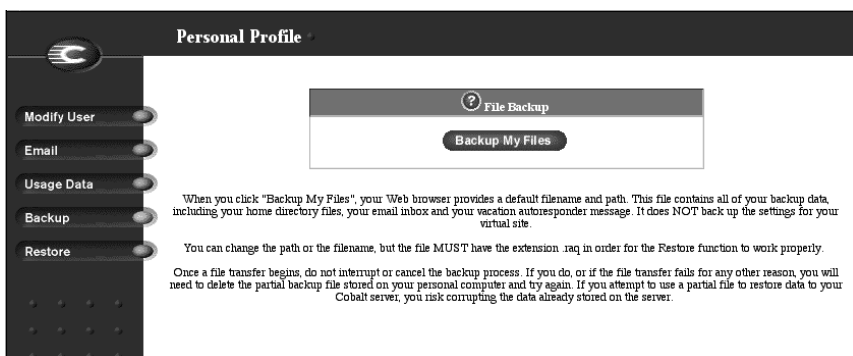

## Restore

Restore allows you to restore all files and subdirectories in your home directory from a .raq backup file.



**Caution:** The system restores data only (for example, email messages stored on the server or Web files). It does NOT restore virtual sites or site users to a RaQ 4.

To restore the backed-up files (from your local disk to your RaQ 4 home directory):

1. On the **Personal Profile** screen, click **Restore** on the left. The File Restore table appears. See Figure 57.
2. Click **Browse** and select the .raq backup file to restore onto the RaQ 4.
3. If you want to restore only some of the files, check **Selective Restore** and select those files.
4. Click **Restore a Backup File**.

Archive restores are not possible with Microsoft Internet Explorer version 3. If you experience problems uploading an archive, use a newer version of browser.

Do not interrupt an archive restore because this can corrupt data. If the restore process is interrupted, the user can try to restore again.

Figure 57 shows the File Restore table for a site user.

**Figure 57.** File Restore table

**Personal Profile**

**File Restore**

Backup Archive	<input type="text"/> <input type="button" value="Browse..."/>
Selective Restore	<input checked="" type="checkbox"/>

NOTE: Please be careful not to interrupt an archive restore as data could be corrupted. In addition, you can only restore data for existing users and sites. Do not selectively restore sites or users that have been deleted.

## Using email on the RaQ 4

To use all of the email capabilities on the RaQ 4, the RaQ 4 Administrator must correctly set the parameters for the email server; see “Email server” on page 53.

The user must also configure the email client to send email to and retrieve email from the RaQ 4. Ensure the following information is entered into the email client:

1. **Email address** The format is:

<username>@hostname.domainname

(for example, myname@raq4.cobalt.com) where:

- <username> is the user ID assigned to you (for example, myname)
- <hostname> is the name assigned to the RaQ 4 (for example, raq4)
- <domainname> is either the official domain name (for example, cobalt.com) that is registered with a name registrar accredited by the Internet Corporation for Assigned Names and Numbers (ICANN) or an intranet domain name specific to your network. Obtain this information from your network administrator.

For more information on ICANN, visit the ICANN Web site at <http://www.icann.org>.

2. **SMTP server** The format is hostname.domainname (for example, raq4.cobalt.com).
3. **POP3 server** The format is hostname.domainname (for example, raq4.cobalt.com).
4. **IMAP server** The format is hostname.domainname (for example, raq4.cobalt.com).
5. **APOP server** The format is hostname.domainname (for example, raq4.cobalt.com).



**Note:** Occasionally, an email application asks for an *incoming* mail server. The incoming mail server is the POP3 server.

# Developing Web pages

You can create complex Web pages using any of the standard HTML editors and the HTML publishing capabilities of many popular desktop productivity applications.

You can create and link the Web pages on your desktop computer, and then move them to the appropriate subdirectory in the RaQ 4 through an FTP-based application; see “Publishing Web pages using FTP” on page 146.

## CGI scripts

The RaQ 4 supports common gateway interface (CGI) scripts, such as those written in Perl, C or other languages. If CGI is enabled for your site (see the Site Settings section of the **Site Management** screen), you can add CGI scripts to work with your Web content.

You can develop CGI scripts on your desktop machine and then transfer them to the RaQ 4 by means of any FTP-based application that allows permission bits to be set to *executable*.

Use FTP to upload .cgi and .pl files; use ASCII mode to upload CGI files. Once the file is on the RaQ 4, use your FTP program to make the script executable. You can also use the telnet command:

```
chmod 775 <filename>.cgi.
```

In order for users (other than the RaQ 4 Administrator) to add CGI files, CGI must be enabled for the user’s virtual site (see the Site Settings section of the **Site Management** screen). CGI scripts must use .pl or .cgi filename extensions in order to be executed by the Web server.

## Server-side scripting languages

The RaQ 4 supports both the Active Server Pages (ASP) and PHP scripting languages. These features are enabled on a per-site basis (see the Site Settings section of the **Site Management** screen).

Like CGI scripts, you can develop ASP and PHP scripts on your desktop machine and then transfer them to the RaQ 4 by means of an FTP-based application. Unlike CGI scripts, ASP and PHP do not require execute permissions to work correctly. However, ensure that the Web server process can read the scripts; you can use the telnet command:

```
chmod 664 <filename>.asp or <filename>.php
```

For the Web server to run the scripts correctly, ASP scripts must use the .asp filename extension and PHP scripts must use the .php filename extension.

## Publishing Web pages using FTP



**Note:** For more information about the directory structure on the RaQ 4, see “Directory structure” on page 175.

After creating your Web pages, you can publish them on the RaQ 4 using an FTP-based application.

Make sure you have the following information:

- the host name or the IP address of your RaQ 4
- your user name and password
- a filename of your choice to save as your main page (the default is index.html)

Launch your FTP software and establish an FTP link to the RaQ 4. Upload your HTML files. If you need help, consult the instructions for your FTP application.

By default, the files you upload using an FTP-based application are stored in your personal directory; the directory path is:

```
/home/sites/<sitename>/users/<username>
```

where <sitename> is the fully qualified domain name of your site and <username> is your user name.



**Note to Site Administrators:** To post Web pages for your site, you must upload to the directory /home/sites/<sitename>/web.

Only Site Administrators or the RaQ 4 Administrator can upload to this directory. If you do not specify this directory, your Web pages are stored in your personal directory which is not accessible from the Web.



The Site Administrator can access and edit the site root content in the directory `/web` during an FTP session. The site web root is accessible on the Web at `http://<sitename>/`.

Site Administrators can edit their personal Web pages in the directory `/users/<username>/web` during an FTP session. Personal Web sites are accessible on the Web at

- `http://<sitename>/users/<username>/`
- `http://<sitename>/~<username>/`

Users who are not Site Administrators can edit their personal Web sites in the directory `/web` during an FTP session.

## **Publishing Web pages with FrontPage for User Webs only**

If FrontPage Server Extensions are enabled on a site, a Site Administrator can enable FrontPage User Webs.

To publish a Web page using FrontPage:

1. Using FrontPage Explorer on a personal computer, select **Open Web**.
2. In the Folder Name field, enter the following:

`http://<exactvirtualsitename>/~<username>/`

For example, the user Jason Paez would enter

`http://test130.cobalt.com/~jpaez/`

3. Click **OK**. An authentication dialog appears.
4. Enter your user name and password assigned to you on the RaQ 4.
5. Click **OK**.

For FrontPage and FrontPage Web information and technical support, see <http://www.microsoft.com/frontpage/> and <http://www.rtr.com/>.

## Using telnet



**Caution to the RaQ Administrator:** You can seriously affect your RaQ 4 if you modify the system configuration files. Only advanced users of Linux should perform this operation.

See your RaQ 4 warranty card for more details.



**Caution:** Direct root logins are not allowed on the RaQ 4. To obtain a root shell, telnet to the server and log in as the user *admin*. From the command prompt, type **su -** and press **Enter**. Enter the administrator's password at the password prompt. Only the RaQ 4 Administrator can **su -** to root.

Telnet access is available to run shell scripts or use shell commands but only advanced users should use telnet. An advanced user is someone who is proficient in the internal workings of the Unix operating system.

The RaQ 4 Administrator can enable the telnet feature for a virtual site. If the telnet feature has been enabled, the Site Administrator can then enable telnet access for individual site users; see “User management” on page 97.

# Using the LCD Console

---

During startup, the liquid-crystal-display (LCD) screen on the front panel of the RaQ 4 displays status information about the boot process.

When setting up the RaQ 4, you use the LCD console to enter network configuration information for the RaQ 4.

Once the RaQ 4 is running, the LCD console serves several purposes. Through the LCD console, you can:

- change the network configuration information, which is useful if the location of the RaQ 4 is changed
- configure the uninterruptible power supply (UPS)
- reboot, which restarts the entire RaQ 4
- power down in a way that allows the RaQ 4 to close all open files, and minimizes startup time the next time the RaQ 4 is powered on
- exit from the LCD commands without making any changes



**Important:** Before turning off the RaQ 4, follow the proper power-down procedure, as described in “Powering down” on page 155.

## Access to the functions

You access each of these functions by holding down the **(S)** (select) button on the LCD console for approximately two seconds. This action causes the LCD screen to enter its function mode. Press the **(S)** button until the function you want appears on the LCD screen. To cancel the LCD function mode, select the **EXIT** function when it appears on the screen. Press the **(E)** (enter) button and select **YES**.

## Changing network configuration

To reset the IP address or change the network configuration of the Network 1 interface:

1. On the LCD console, hold down the **(S)** button for approximately 2 seconds.

The LCD screen displays:

```
SELECT:  
SETUP NETWORK
```

2. Press the **(E)** button.
3. Enter the IP address using the arrow buttons. The left and right arrow buttons move the cursor position to the left or right. The up and down arrow buttons increase or decrease the digit at the cursor position.
4. Press the **(E)** button.
5. Enter the Netmask using the arrow buttons.
6. Press the **(E)** button.
7. Enter the Gateway using the arrow buttons.
8. Press the **(E)** button.
9. Use the arrow buttons to toggle the cursor between [S]ave and [C]ancel.
10. Press the **(E)** button.

If you select the Save option, the RaQ 4 reboots using the new network configuration. If you select Cancel, you return to step 1 of this procedure.



**Note:** You can also change the network configuration of the RaQ 4 through the Web browser. See “Network” on page 64.

If you change the network IP address of the RaQ 4 through the Web browser, the RaQ 4 reboots automatically when you click **Save Changes**.

# Configuring an uninterruptible power supply (UPS)

There are two options for configuring the RaQ 4 for a UPS: as the *master* or as a *slave*.

The *master* communicates directly to the UPS through the serial port. The *slave* (or *slaves*) communicates with a master (not a RaQ 4 server) over the network to verify the status of the power supply.



**Note:** The RaQ 4 server cannot act as a *master* for other machines. Allowing *slave* access by arbitrary machines would pose a security risk.

The distinction between *master* and *slave* is whether the RaQ 4 is connected directly to the UPS (a *master*) or pointed to another machine that is connected to the UPS (a *slave*).

If you configure the RaQ 4 as a *slave*, you must have, on the network, a machine acting as a UPS master that is configured to allow *slave* access for the IP address of your RaQ 4.

If you configure a RaQ 4 as a *master*, the RaQ 4 configures itself automatically. Before choosing this option, you must first connect the UPS to the RaQ 4 through the serial port; see Figure 58 for the correct serial port.

If you configure a RaQ 4 as a *slave*, the LCD screen prompts you for the IP address of the device that is configured as the master.

**Figure 58.** Serial port for UPS connection

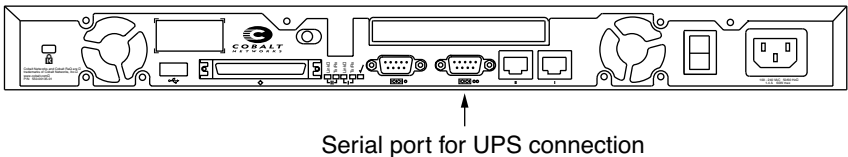

To configure the RaQ 4 for the UPS, first connect the UPS unit and the RaQ 4, and then configure the RaQ 4 through the LCD panel. (Refer to the UPS manual for more information on connecting the devices.)

1. Plug the UPS into the wall socket.
2. Turn on the UPS.
3. Plug the RaQ 4 servers into the UPS power sockets.
4. Connect the UPS serial cable to the UPS unit and the serial port on the RaQ 4 that will serve as the master. See Figure 58.



**Important:** You must use the serial cable shipped with the UPS unit.

5. On the LCD console, hold down the **(S)** button for approximately 2 seconds.

The LCD screen displays:

```
SELECT:  
SETUP NETWORK
```

6. Press the **(S)** button until **Configure UPS** appears in the LCD screen:

```
SELECT:  
CONFIGURE UPS
```

7. Press the **(E)** button.
8. Use the arrow buttons to toggle the cursor between [ ] On and [ ] Off. Select [ ] On.
9. Press the **(E)** button.
10. Use the arrow buttons to toggle the cursor between [M]aster and [S]lave.
11. Press the **(E)** button. If you choose [M]aster, the RaQ 4 configures itself automatically for the UPS.

12. If you choose [S]lave, the LCD screen prompts you for the IP address of the device configured as the master.

Enter the IP address using the arrow buttons. The left and right arrow buttons move the cursor position to the left or right. The up and down arrow buttons increase or decrease the digit at the cursor position.

13. Press the **E** button.

The LCD screen returns to the host name and IP address. The LCD screen does NOT prompt you to save the changes.

## **Verifying the UPS configuration**

To verify that you have configured the UPS correctly:

1. Unplug the UPS unit from the wall socket to simulate a power outage to the UPS.
2. The UPS takes over the power supply to the RaQ 4 servers. Each of the RaQ 4 servers monitoring the UPS displays on the LCD screen:

UPS:  
ON BATTERY

3. Plug the UPS into the wall socket again. Each of the RaQ 4 servers monitoring the UPS displays on the LCD screen:

UPS:  
POWER RESTORED

After a few seconds, the LCD screen returns to the normal LCD display of host name and IP address.

# Rebooting

To reboot the RaQ 4 through the LCD console:

1. On the LCD console, hold down the **(S)** button for approximately 2 seconds.

The LCD screen displays:

```
SELECT:  
SETUP NETWORK
```

2. Press the **(S)** button until **Reboot** appears in the LCD screen:

```
SELECT:  
REBOOT
```

3. Press the **(E)** button.
4. Use the arrow buttons to toggle the cursor between [Y] and [N]. Select [Y] to reboot the system.
5. Press the **(E)** button.



**Note:** You can also reboot the RaQ 4 through the Web browser. See “Reboot” on page 85.



# Powering down



**Caution:** To prevent the potential loss of data, it is important to follow the proper power-down procedure before turning off the RaQ 4.

To power down the RaQ 4:

1. On the LCD console, hold down the **(S)** button for approximately 2 seconds.

The LCD screen displays:

SELECT:  
SETUP NETWORK

2. Press the **(S)** button until **Power down** appears in the LCD screen:

SELECT:  
POWER DOWN

3. Press the **(E)** button.
4. Use the arrow buttons to toggle the cursor between [Y] and [N]. Select [Y] to power down the system.

The **OK to Power Off** light on the back panel blinks. The LCD screen displays:

PLEASE SWITCH  
POWER OFF NOW

5. Toggle the **On/Off** switch on the back panel to the **Off** position.



# Product Information

---

## Technical data for the RaQ 4

### Hardware

Depending on the configuration, your RaQ 4 server has the following hardware components. See Table 1 on page 2 for more information.

- x86-compatible superscalar processor
- 512 KB of L2 cache
- 64-MB to 512-MB PC-100 SDRAM DIMMs (2 slots)  
(3.3 v, 168-pin, non-parity, unbuffered)
- One or two internal Ultra ATA/33 hard disk drives
- One or two 10/100 BaseT ethernet network interfaces
- Two serial port interfaces
- External ultra-wide SCSI interface (mini-micro 68-pin) 40 Mb/s
- LCD console for easy set-up and administration
- PCI slot for expansion
- Support for uninterruptible power supply (UPS)

## **Software**

The RaQ 4 has the following software features.

### **Features**

- Linux 2.2 multitasking operating system
- Apache 1.3.12 Web server, HTTP/1.1 compliant
- Virtual hosting services: name-based and IP-based
- Common gateway interface (CGI) support
- Active Server Pages (ASP) support by Chili!Soft
- PHP 4.0 support
- Server side includes (SSI) support
- Perl scripting
- Email protocol support: Simple Mail Transfer Protocol (SMTP), Internet Message Access Protocol (IMAP4), Post Office Protocol (POP3), Authentication Post Office Protocol (APOP)
- File transfer protocol (FTP), anonymous FTP access
- Telnet access
- Domain Name System (DNS) server
- 128-bit Secure Sockets Layer (SSL)
- FrontPage 2000 server extensions
- NTP client support
- Cobalt Bandwidth Management software
- Java support for Java Run-time Environment version 1.2 from Sun Microsystems (ported to the x86 architecture by the Java-Linux Porting Team at [www.blackdown.org](http://www.blackdown.org))
- Code development environment
- Legato Networker client, Arkeia Backup support
- Security: PAM/shadowed passwords

## System management

- SSL support for secure administration
- Simple Network Management Protocol (SNMP) management support
- Browser-based Setup Wizard
- Browser-based RaQ 4 server management and individual virtual site management interfaces
- Online ActiveAssist real-time help
- ActiveMonitor maintenance agents
- Advanced management using telnet
- Web-based performance and usage reporting
- Browser-based backup and restore utility
- Browser-based software upgrade

## Partner solutions

- E-commerce
- Database
- Backup
- Analysis and usage statistics

## Physical data

The RaQ 4 has the following physical characteristics.

- Dimensions: 17.00 in. x 12.50 in. x 1.75 in. (43.2 cm x 31.8 cm x 4.5 cm); fits in a standard single-unit, 19-in. equipment rack
- Weight with one hard disk drive: 9 lbs. 3 oz. (4.2 kg)
- Weight with two hard disk drives: 11 lbs. 3 oz. (5.0 kg)
- Power requirements: Input rating 100-240 V, 50/60 Hz
- Power consumption: 45 watts
- Power requirement for the PCI slot:
  - 5V @ 1A
  - +12V @ 0.5A
  - -12V @ 0.1A

## *Appendix B: Product Information*

- Operating environment:  
32°F to 95°F (0°C to 35°C)  
10% to 90% humidity (non-condensing)
- Non-operating environment:  
14°F to 122°F (-10°C to 50°C)  
5% to 93% humidity (non-condensing)
- Light-emitting diodes (LEDs): Power, Transmit/Receive, Link, Collision, 100 Mb/s Operation, Disk Activity, Web Activity

## **Regulatory approvals**

- CISPR 22B
- VCCI-B
- UL
- C-UL
- TUV
- CE
- Austel
- BSMI/BCIQ
- RRL

# Upgrading your RaQ 4

The RaQ 4 unit is a single rack-unit (1RU) enclosure. Before you purchase a component to add to the RaQ 4, ensure that the component fits into the allocated space:

- The DIMM modules must be less than 1.5 inches (38.1 mm) tall and less than 0.158 inches (4.0 mm) thick.
- The PCI expansion slot has been designed to accommodate the PCI standard short card form factor, with some additional space for longer cards. The PCI card must be less than 10.5 inches (267 mm) long.

There are three ways to upgrade your RaQ 4:

- add a memory module
- add a PCI expansion card (not available on the base RaQ 4 configuration)
- add or replace a hard disk drive (see “Adding or replacing a hard disk drive in a RaQ 4” on page 164)

## Opening the RaQ 4



**Warning:** You must power down the RaQ 4 before opening the unit.

1. Power down the RaQ 4. See “Powering down” on page 155.
2. Unplug the RaQ 4 from the power supply.
3. Remove the power cord from the rear of the RaQ 4. The cable is located beside the power switch. See Figure 2 on page 5.



**Note:** If the RaQ 4 is mounted on an equipment rack, remove the RaQ 4 from the rack and take it to a service area. Do not attempt this upgrade while the RaQ 4 is still in the equipment rack.

4. Unscrew the top cover of the RaQ 4. Ten screws hold the top cover in place. The screws are labeled 1 through 10 in Figure 59.

## Adding a memory module or PCI card

Be careful not to damage components during the upgrade.

1. Adding a memory module:
  - You can install a DIMM module in either Memory Slot 1 or Slot 2. See Figure 60.
2. Adding a PCI expansion card:
  - Remove the PCI slot cover, and its retainer and screw. See Figure 59.
  - Remove the protective cover from the PCI connector.
  - Plug the PCI card into the PCI connector. See Figure 60.
  - Replace the PCI retainer and screw to hold the PCI card in place.
  - Save the PCI slot cover in case you want to remove the PCI card later.
3. Replace the top cover of the RaQ 4.
4. Secure the top cover properly and replace the ten screws that hold the top cover in place. See Figure 59.

Figure 59 shows how to remove the top cover of the RaQ 4.

**Figure 59.** Top cover on the RaQ 4

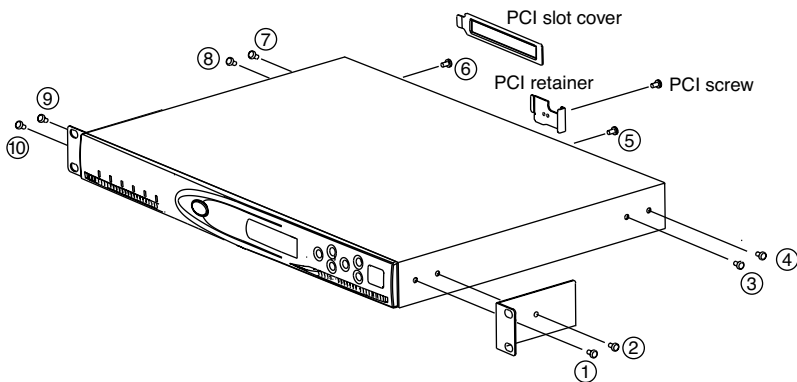



## Printed circuit board

Figure 60 shows the layout of the printed circuit board (PCB) in the RaQ 4.



**Note:** The base RaQ 4 server configuration does not offer all of the hardware components shown in Figure 60.

**Figure 60.** Layout of the printed circuit board

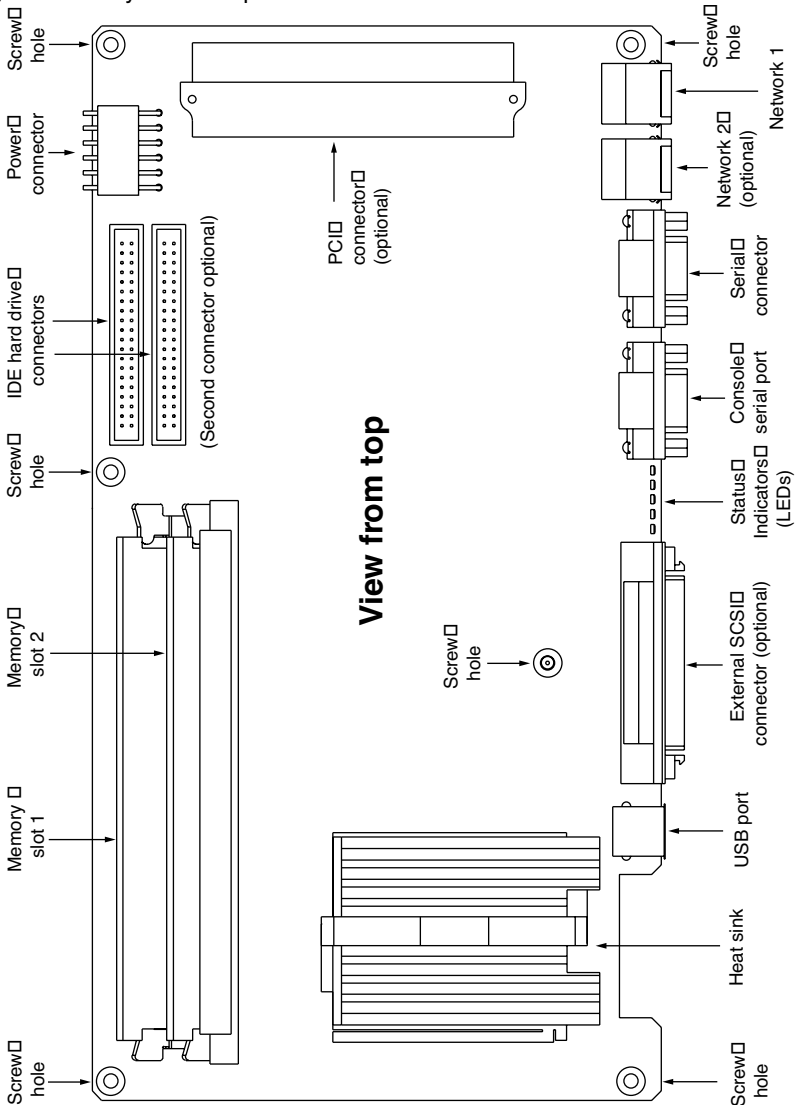

## Adding or replacing a hard disk drive in a RaQ 4

If you have the base RaQ 4 server configuration, you can replace a failed hard disk drive but you cannot add a second hard disk drive.

If you have a RaQ 4i server, you can replace a failed hard disk drive or add a second hard disk drive.

If you have a RaQ 4r server, you can replace a failed hard disk drive.

### Specifications for a hard disk drive

Cobalt Networks recommends that the hard disk drive you select meet the specifications listed in Table 5. A hard disk drive that does not meet these specifications can cause reliability problems in your server.

**Table 5.** Specifications for the hard disk drive

Specification	Value
Peak current draw	Must not exceed: 1.8 amperes max (at 12 volts) 0.7 amperes max (at 5 volts)
Rotational speed	5400 rpm
Interface	Ultra ATA/33
Operating temperature	Must be able to operate in environments up to 55° C
Operating humidity	10% to 90% (non-condensing)

## Requirements

Before adding the second hard disk drive, make sure that you have the following:

- a hard disk drive that meets the specifications in Table 5.
- a Phillips screwdriver



**Caution:** If you are replacing a failed hard disk drive in a RaQ 4r server, ensure that you are installing a hard disk drive of the same capacity as the one you are replacing.

If the RaQ 4 is mounted on an equipment rack, remove the RaQ 4 from the rack and take it to a service area. Do not attempt this upgrade while the RaQ 4 is still in the equipment rack.

## Overview



**Note:** If you have to replace an original hard disk drive (meaning a hard disk drive that Cobalt Networks installed in the server), please notify Cobalt Networks Technical Support and arrange to return the hard disk drive.

See “Customer Service and Technical Support” on page 13.

To add a second hard disk drive or to replace a failed hard disk drive, there are a number of steps involved. These steps are explained in the following sections.

1. Power down the RaQ 4. See “Powering down” on page 155.
2. Open the case of the RaQ 4.
3. If applicable, remove the failed hard disk drive.
4. Install a new hard disk drive.
5. Close the case of the RaQ 4.

6. Reboot the RaQ 4.
7. If you have added a second hard disk drive to a RaQ 4i server, add the new storage unit through the browser-based UI. See “Storage” on page 82.

If you have replaced a failed hard disk drive in a RaQ 4r server, you do not need to add the new hard disk drive through the UI. When rebooting, the system automatically detects the new hard disk drive.

The RaQ 4r automatically synchronizes the new hard disk drive to the existing hard disk drive so that the server will be able to provide disk mirroring (RAID-1).



**Note:** During the synchronization process, the RaQ 4r cannot provide disk mirroring but it can still serve requests.

## Opening the RaQ 4



**Warning:** You must power down the RaQ 4 before opening the unit.

1. Power down the RaQ 4. See “Powering down” on page 155.
2. Unplug the RaQ 4 from the power supply.
3. Remove the power cord from the rear of the RaQ 4. The cable is located beside the power switch. See Figure 2 on page 5.



**Note:** If the RaQ 4 is mounted on an equipment rack, remove the RaQ 4 from the rack and take it to a service area. Do not attempt this upgrade while the RaQ 4 is still in the equipment rack.

4. Unscrew the top cover. Ten screws hold the top cover in place. The screws are labeled 1 through 10 in Figure 59 on page 162.

Figure 61 shows the layout of the IDE cables in the RaQ 4.

**Figure 61.** Layout of the IDE cables

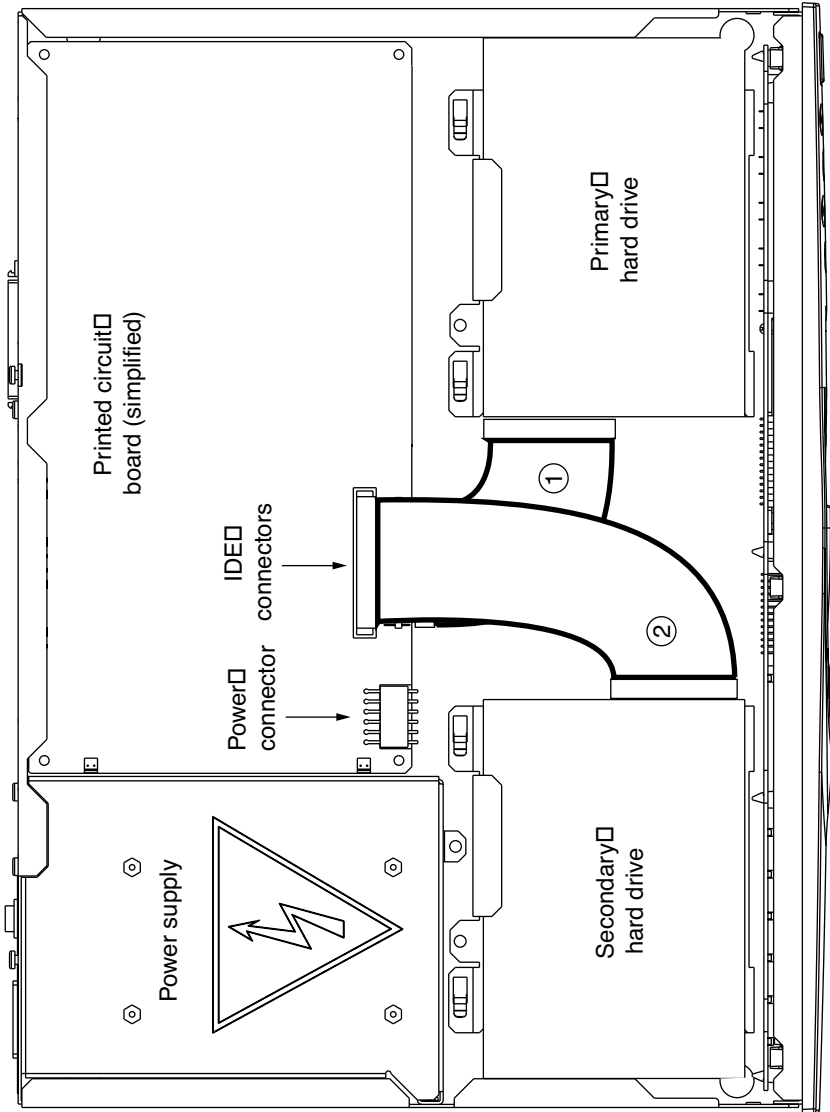
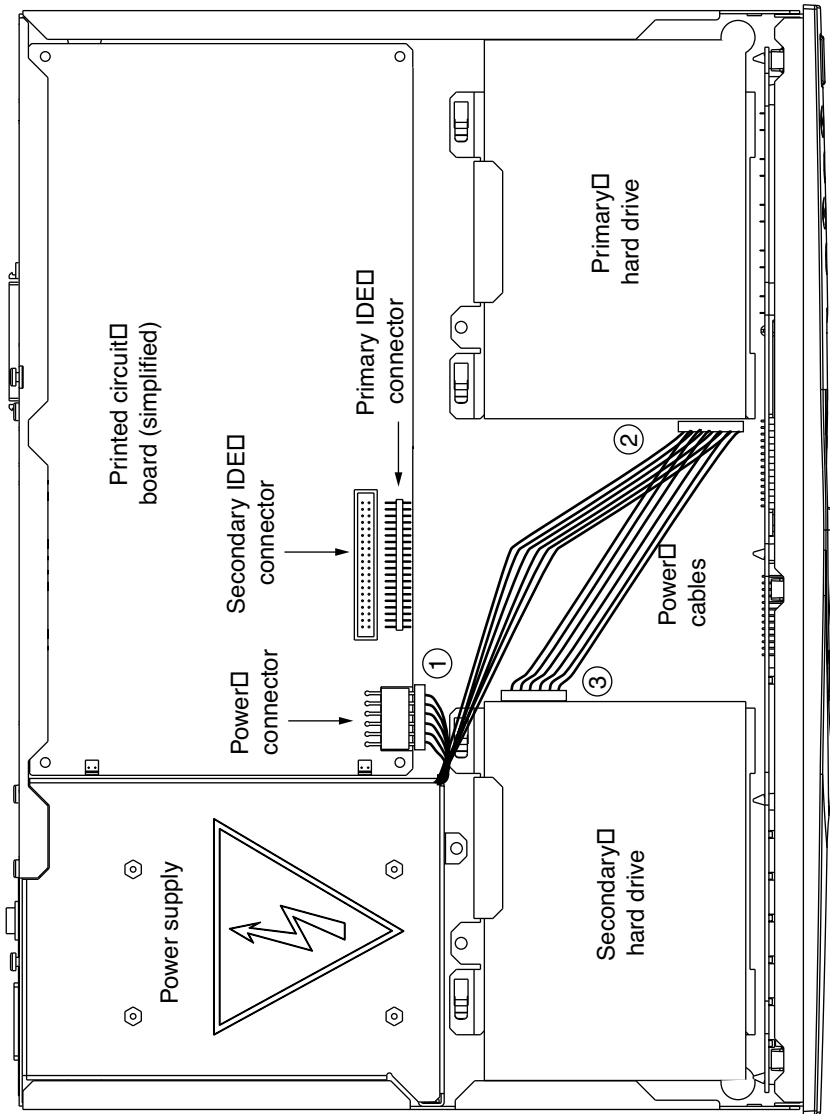

Figure 62 shows the layout of the power cables in the RaQ 4.

**Figure 62.** Layout of the power cables



## Removing a hard disk drive

To remove a hard disk drive:

1. Unplug the IDE cable from the hard disk drive (see Figure 61).
2. Unplug the power cable from the hard disk drive (see Figure 62).
3. Remove the screw that attaches the hard-disk-drive bracket to the chassis.
4. Slide the bracket off the metal tabs on the chassis and lift the bracket and hard disk drive off.
5. On the underside of the bracket, remove the four screws that attach the hard disk drive to the bracket.
6. Remove the hard disk drive from the bracket.

## Installing a hard disk drive

Be careful not to damage components during the upgrade.

In the RaQ 4i configuration, there is an extra IDE cable already attached to the printed circuit board (PCB); see #2 on Figure 61.

The installed hard disk drive has a Y-connector on the power cable; the cable connector for the second hard disk drive is capped. See #3 in Figure 62.

The empty bracket for the second hard disk drive is attached to the chassis. Take note of how the bracket is positioned so that you can replace it in the same orientation.

To install a hard disk drive:

1. If you have not already done so, remove the hard-disk-drive bracket from the chassis.
  - Remove the screw that attaches the hard-drive bracket to the chassis.
  - Slide the bracket off the metal tabs on the chassis and lift the bracket off.
2. On the bracket, four screws are in place for attaching the hard disk drive. Remove these four screws from the bracket.
3. Place the hard disk drive in the bracket.
4. On the underside, attach the hard disk drive to the bracket with the four screws.



**Caution:** Be careful not to pinch the cables under the bracket when you replace the bracket on the chassis.

5. Set the bracket with the attached hard disk drive on the chassis and slide it onto the metal tabs. The connectors on the hard disk drive must face in to the center of the chassis, with the foam pad located next to the power supply.
6. Re-attach the bracket to the chassis with the correct screw.

## Connecting the hard disk drive

To connect the hard disk drive:

1. Remove the cap from the Y-connector power cable.
2. Plug the Y-connector power cable into the hard disk drive, see Figure 62. The connector is keyed to fit into the hard disk drive one way only.
3. Plug the IDE cable into the hard disk drive; see Figure 61. The connector is keyed to fit into the hard disk drive one way only.

## Replacing the top cover and rebooting the RaQ 4

To replace the top cover and reboot the RaQ 4:

1. Secure the top cover properly and replace the ten screws that hold the top cover in place. See Figure 59 on page 162.
2. Reconnect the power cord to the rear of the RaQ 4.
3. Power up the RaQ 4. The RaQ 4 boots up in the normal manner.

If you have added a second hard disk drive to a RaQ 4i server, you now have to add (through the RaQ 4 UI) the second drive to the list of available storage devices; see “Storage” on page 82.



**Note:** If you have replaced a failed hard disk drive in a RaQ 4r server, you do not need to add the new hard disk drive through the Add Storage feature. When rebooting, the system automatically detects the new hard disk drive.

The RaQ 4r automatically synchronizes the new hard disk drive to the existing hard disk drive so that the server will be able to provide disk mirroring. During the synchronization process, the RaQ 4r cannot provide disk mirroring but it can still serve requests.



# Advanced Information

---

## Serial console port

You can connect a console terminal to the DB-9 connector on the back panel of the RaQ 4. The terminal can be either an ASCII terminal or a PC running terminal software. The console terminal should have the following communications parameters—115 200 baud, 8 data bits, no parity and one stop bit.

## Initializing the RaQ 4 through the serial console port

Instead of assigning the initial network settings for the RaQ 4 server through the LCD console, you can connect the server to a terminal and assign the network settings through the serial console port.

This feature allows the assignment of network parameters only (IP address, netmask, gateway).



**Note:** You can use the initialize the RaQ 4 through the serial console port only once, much like proceeding through the browser-based Setup Wizard.

To initialize the RaQ 4 through the serial console port:

1. Connect a null modem serial cable to the serial console port on the back panel of the RaQ 4.

The following figure shows back panel of the RaQ 4i/RaQ 4r server configuration; the serial console port on the base RaQ 4 server configuration is in the same location.

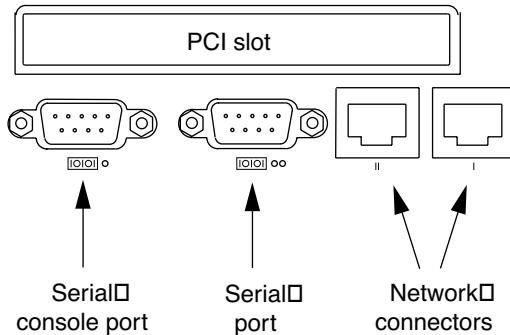

2. Configure your terminal software to the following parameters:
  - 115 200 Baud
  - 8 data bits
  - no parity
  - 1 stop bit
3. Power on the RaQ 4 with the power switch on the back panel. A number of boot messages are displayed on your terminal screen.
4. The first prompt asks for an IP address. Enter the Primary IP address for the RaQ 4 (for example, 10.9.19.55).
5. The second prompt asks for the netmask address. Enter the Primary Netmask for the RaQ 4 (for example, 255.0.0.0).
6. The third prompt asks for the gateway address. Enter the gateway for the RaQ 4 (for example, 10.9.25.254).
7. Confirm the settings that you have entered:
  - Primary IP Address: 10.9.19.55
  - Primary Netmask: 255.0.0.0
  - Gateway: 10.9.25.254

8. Another prompt is displayed: [S]AVE / [C]ANCEL. Enter “S” to save the configuration. The message `Verifying and saving...` appears.
9. Once the configuration is saved, the terminal screen displays the normal boot status messages. Continue administration of the RaQ 4 through your Web browser.

## Development tools

The RaQ 4 provides a collection of utilities to support applications development and server administration. These tools include:

- GNU C/C++ compiler (`gcc`) and libraries
- Java Run-time Environment
- GNU Bourne Again Shell (`bash`)
- Text editors (`emacs`, `vi`, `pico`)
- File system utilities (`ls`, `mv`, `cp`, `ln`, `rm`, `chmod`, `chown`, `chgrp`, `du`, `df`)
- File parsing utilities (`sed`, `awk`, `diff`)
- File display utilities (`cat`, `more`, `less`)
- Search utilities (`find`, `grep`, `which`)
- Archive utilities (`gzip`, `tar`, `cpio`, `rpm`)
- Network utilities (`FTP`, `telnet`, `netstat`, `ping`, `finger`, `mail`, `pine`)
- Programming languages (`perl`, `python`, `tcl/tk`)

These utilities can be found in one of the following directories:

```
/sbin
/bin
/usr/sbin
/usr/bin
```

For an expanded set of development tools, visit the Solutions directory on Cobalt Networks' Web site (<http://www.cobalt.com/solutions/>)

Additionally, the Linux distribution on the RaQ 4 is based on the Red Hat Linux 6.0 distribution for x86-compatible processor systems.

You can run most pre-compiled x86-based commercial software packages on the RaQ 4, as long as the software does not require a mouse, keyboard or monitor. Ensure that the software is compatible with the Linux 2.2 kernel and the glibc library.

# Configuration files

If necessary, you can change some of the configuration files for the RaQ 4 services for development purposes, but this may void your warranty. Please read your warranty card before making any changes.



**Caution:** Changing any of the following configuration files can dramatically affect the operation of the services configured by means of the RaQ 4's Web-based administration service or the administration service itself.

The services and some of their associated configuration files and directories are the following:

- Email
  - `/etc/inetd.conf`
  - `/etc/sendmail.*`
  - `/etc/mail/`
- Domain Name Service (DNS)
  - `/etc/named/`
- File transfer protocol (FTP)
  - `/etc/proftpd.conf`
- Web
  - `/etc/httpd/conf/*.conf`
- Mailing lists
  - `/usr/local/majordomo/`

# Directory structure

The hard disk drive on the RaQ 4 is partitioned into four segments. Most of the available space on the hard disk drive is on the partition mounted from /home. It is recommended to do most of your work under this partition. By default, quotas are turned on in this partition and are used extensively by the system software.

## RaQ 4 home page

The document root for the Web server is the RaQ 4's main site:

```
/home/sites/home/web
```

Web content in this directory is associated with the URL `http://<IP address>/`.

For example, a file saved as:

```
/home/sites/home/web/testdir/test.html
```

is accessed through the URL `http://<IP address>/testdir/test.html`.



**Note:** <IP address> refers to the IP address or the fully qualified domain name of the RaQ 4.

## Virtual site home page

The document root for the virtual sites' Web page content is:

```
/home/sites/<sitename>/web
```

For example, `www.cobalt.com` would have a document root of

```
/home/sites/www.cobalt.com/web
```

Only the RaQ 4 Administrator or the Site Administrator can upload to this directory.

Web content in this directory is associated with the URL `http://<sitename>/`.

For example, a file saved as:

```
/home/sites/<sitename>/web/testdir/test.html
```

is accessed through the URL `http://</sitename>/testdir/test.html`.



**Note:** <Sitename> refers to the <hostname.domainname> of the corresponding virtual site.

## Site user home page

When a user on the main site is created through the browser-based UI, the home directory for that site user is created in:

```
/home/sites/home/users/username/web
```

The content of their Web pages can be viewed at `http://<IP address>/users/<username>/` or `http://<IP address>/~<username>/`.

When users on a virtual site are created using the browser-based UI, the user's home directory is:

```
/home/sites/<sitename>/users/<username>
```

The users default Web page is:

```
/home/sites/<sitename>/users/<username>/web
```

The content of their Web pages can be viewed at `http://<sitename>/~<username>/`.

## Common gateway interface (CGI) usage for users

You can save CGI files in any directory on your site, provided that CGI is enabled, the CGI file is executable and the file ends with a `.pl` or `.cgi` extension.

The Web server is configured to execute CGI scripts using a wrapper program (`cgiwrap`), which preserves the permissions set for the executing script. For more information regarding this security precaution, refer to `http://www.umn.edu/~cgiwrap/`

## **Scripting languages available per site**

### **Active Server Pages (ASP)**

You can save Active Server Pages (ASP) files in any directory on your site, provided that support for ASP is enabled, the ASP file is executable and the file ends with an .asp extension.

The RaQ 4 is pre-configured with Chili!Soft ASP software.

### **PHP**

You can save PHP files in any directory on your site, provided that support for PHP embedded scripting is enabled, the PHP file is executable and the file ends with a .php extension.

The RaQ 4 is pre-configured with support for embedded PHP scripts.





# Domain Name System

---

## Basic DNS

The Internet uses a distributed naming system called the Domain Naming System (DNS). DNS allows us to refer to computers by host names as well as by Internet Protocol (IP) addresses.

IP addresses are hard to remember and are inconvenient to use. DNS allows us to use host names and domain names which can resolved to IP addresses. DNS servers translate host names and domain names (for example, `www.cobalt.com`) to an associated IP address (for example, `192.168.1.10`.)

For example, Cobalt Networks has registered the domain name “cobalt.com” for use by our servers “mail.cobalt.com”, “www.cobalt.com” and others. The host names “mail” and “www” represent different servers registered in the same domain.

A domain name is a computer name suffix shared by a group of computers in the same organization. A domain name should be associated with an IP address through a Forward Lookup record. Domain names are organized in a hierarchy; this hierarchy includes your company or server name, and a country code (for example, `.uk` or `.ca`) or a top-level domain (for example, `.com` or `.edu`).

A Web site on the server is created with one IP address, one host name and one domain name that together establish the identity of that Web site on the Internet.

Each domain name requires a primary domain authority on one DNS server. A secondary DNS server acts as a backup to the primary. DNS information is configurable only on the primary server, and not on the backup server.

## Enabling the DNS server feature



**Important:** Always click **Save Changes to DNS Server** after modifying DNS records. If you do not, the changes will not take effect.

To enable the DNS server on the RaQ 4:

1. On the **Server Management** screen, click **Control Panel**. The Service Settings table appears.
2. Click the check box to enable the Domain Name System (DNS) Server (if it is not already turned on).
3. Click **Save Changes**.

To set the optional DNS services, click **Parameters** next to the DNS service in the Service Settings table.

## Configuring a primary DNS server

A primary DNS server maintains a list of name records and their associated IP addresses. This list is made available to other DNS servers if your domain is registered with your country-specific domain-naming organization. Your Internet service provider (ISP) can help you register your Internet server.

To configure a primary DNS server for your RaQ 4:

1. On the **Server Management** screen, click **Control Panel**. The Service Settings table appears.
2. Click the check box to enable the Domain Name System (DNS) Server (if it is not already turned on).
3. Click **Save Changes**.
4. Click **Parameters** next to the DNS service in the Service Settings table.
5. Select Address (A) from the **Add...** pull-down menu.
6. Enter the host name and domain name you want to serve (for example, www and mydomain.com) and enter its IP address (for example, 192.168.1.1).
7. You can enable Automatic Reverse Lookup Generation for this IP address and host name pair so that IP address/host name pairs can be resolved in both directions. Reverse lookup (PTR) records that are generated automatically assume the network mask of 255.255.255.0 (24 bits.)

8. Click **Update List**.
9. Click **Save Changes to DNS Server**.

## Specifying a reverse lookup (PTR) record

A DNS server can also resolve a computer host name to an IP address, which is known as reverse lookup. The network mask, or subnet size, is specified by an integer from 8 to 32.

See Table 6.

To specify a reverse lookup (PTR) record:

1. On the **Server Management** screen, click **Control Panel**. The Service Settings table appears.
2. Click **Parameters** next to the DNS service in the Service Settings table.
3. Select Reverse Lookup (PTR) from the **Add...** pull-down menu.
4. Enter the host name and domain name you want to serve (for example, www and mydomain.com) and enter its IP address (for example, 192.168.1.1) and network mask (for example, 24).
5. Click **Update List**.
6. Click **Save Changes to DNS Server**.

## Specifying a mail server (MX) record

To specify a mail server (MX) record:

1. On the **Server Management** screen, click **Control Panel**. The Service Settings table appears.
2. Click **Parameters** next to the DNS service in the Service Settings table.
3. Select Mail Server (MX) from the **Add...** pull-down menu.
4. Enter the host name and domain name you want to serve (for example, www and mydomain.com) and enter its IP address (for example, 192.168.1.1) and network mask (for example, 24).
5. In the Delivery Preference field, you can choose from the pull-down menu Very Low, Low, High or Very High.
6. Click **Update List**.
7. Click **Save Changes to DNS Server**.

## Specifying an alias (CNAME) record

This feature allows you to alias one host name to another. The target host name does not need to be a member of the local domain. For example, you can create an alias record from “news.domain.com” to “uucp.isp.net”.



**Caution:** Do not use an Alias (CNAME) Record to cause a domain name to resolve to a host name.

For example, do not create an Alias (CNAME) Record for mydomain.com that resolves to www.mydomain.com. Instead, add a new Address (A) Record for mydomain.com to the IP address used by www.mydomain.com. See “Configuring a primary DNS server” on page 180.

To specify an alias (CNAME) record:

1. On the **Server Management** screen, click **Control Panel**. The Service Settings table appears.
2. Click **Parameters** next to the DNS service in the Service Settings table.
3. Select Alias (CNAME) from the **Add...** pull-down menu.
4. Enter the host name and domain name for which you want to create an alias (for example, www and mydomain.com) and enter the host name and domain name for the target. The target host name is optional.
5. Click **Update List**.
6. Click **Save Changes to DNS Server**.

## Configuring a secondary DNS server

As the RaQ 4 Administrator, you can configure a secondary DNS server to provide redundant DNS service to your computers. If the primary DNS server is turned off, a computer can use the secondary DNS server with no loss of performance.

## **Adding a secondary domain**

To add a secondary name-server authority for a domain:

1. On the **Server Management** screen, click **Control Panel**. The Service Settings table appears.
2. Click **Parameters** next to the DNS service in the Service Settings table.
3. Select Secondary Name Service for Domain from the **Add...** pull-down menu.
4. Enter the domain name to be serviced and the IP address of the primary DNS server.
5. Click **Update List**.
6. Click **Save Changes to DNS Server**.

## **Adding a secondary network**

To add a secondary name-server authority for a network:

1. On the **Server Management** screen, click **Control Panel**. The Service Settings table appears.
2. Click **Parameters** next to the DNS service in the Service Settings table.
3. Select Secondary Name Service for Network from the **Add...** pull-down menu.
4. Enter the network to be serviced and the IP address of the primary DNS server.
5. Click **Update List**.
6. Click **Save Changes to DNS Server**.

# Advanced DNS

## Network Mask Notation Conversion

Use Table 6 to convert between dot-quad and network mask bit-count notations.

**Table 6.** Network Mask Notation Conversion

<b>Dot-Quad</b>	<b>Bit count</b>
255.0.0.0	8
255.128.0.0	9
255.192.0.0	10
255.224.0.0	11
255.240.0.0	12
255.248.0.0	13
255.252.0.0	14
255.254.0.0	15
255.255.0.0	16
255.255.128.0	17
255.255.192.0	18
255.255.224.0	19
255.255.240.0	20
255.255.248.0	21
255.255.252.0	22
255.255.254.0	23
255.255.255.0	24
255.255.255.128	25
255.255.255.192	26
255.255.255.224	27

**Table 6.** Network Mask Notation Conversion

Dot-Quad	Bit count
255.255.255.240	28
255.255.255.248	29

## Delegating a subdomain



**Important:** Always click **Save Changes to DNS Server** after modifying DNS records. If you do not, the changes will not take effect.

DNS servers are organized hierarchically. You can delegate the name server authority for subdomains of any domain served by the RaQ 4 to other name servers.

For example, domain.com can be served authoritatively by a RaQ 4 by defining an Address (A) Record using that domain. A subdomain, such as remote.domain.com, can use its own set of DNS servers so that domain authority can be shared between multiple physical sites. This makes it easier to use multiple DNS servers in remote locations sharing a common domain.

To delegate the subdomain naming authority to another name server:

1. On the **Server Management** screen, click **Control Panel**. The Service Settings table appears.
2. Click **Parameters** next to the DNS service in the Service Settings table.
3. Select the parent domain from the **Select Domain or Network...** pull-down menu.
4. Select Delegate Subdomain from the **Add...** pull-down menu.
5. Specify the subdomain name and the fully qualified domain name(s) of the DNS server(s) that will be authoritative for that subdomain.
6. Click **Save Changes**.
7. Click **Save Changes to DNS Server**.

## Delegating a subnet

You can delegate the name-server authority for a network to a remote DNS server.

To delegate the subnet naming authority to a remote DNS server:

1. On the **Server Management** screen, click **Control Panel**. The Service Settings table appears.
2. Click **Parameters** next to the DNS service in the Service Settings table.
3. Select the parent network from the **Select Domain or Network...** pull-down menu.
4. Select Delegate Subnetwork from the **Add...** pull-down menu.
5. Specify an IP address and the size of the network to be delegated. The IP address must be a member of the subnet to be delegated.
6. Specify the fully qualified domain name of the DNS server that will be authoritative for that subnet.
7. Click **Save Changes**.
8. Click **Save Changes to DNS Server**.

## Configuring server settings

You can configure forwarding servers and zone transfer access control for the RaQ 4 DNS server.

To configure the DNS server settings:

1. On the **Server Management** screen, click **Control Panel**. The Service Settings table appears.
2. Click **Parameters** next to the DNS service in the Service Settings table.
3. Select Server Settings from the **Add...** pull-down menu.
4. If the RaQ 4 is being used on a private network or in conjunction with a restrictive firewall, you can specify forwarding servers.

Enter the IP address of the Forwarding Server and, if you want, the Backup Forwarding Server.



5. A zone transfer allows another DNS server to download the complete list of hosts maintained by your DNS server. By default, zone transfers are unrestricted. However, you can restrict zone transfers if you want.

Enter IP addresses or network addresses in the Zone Transfer Access field; this automatically causes zone transfers to become restricted. Now, only the IP addresses or network addresses listed in this field are able to perform zone transfers.

6. Click **Save Changes**.
7. Click **Save Changes to DNS Server**.

## Start of Authority (SOA) configuration

For the best reliability, you can fine tune all primary domain and network authority settings independently of each other.

To fine tune the primary domain and network authorities:

1. On the **Server Management** screen, click **Control Panel**. The Service Settings table appears.
2. Click **Parameters** next to the DNS service in the Service Settings table.
3. Select an authoritative domain or network from the **Select a Domain or Network...** pull-down menu.

The first record in the record list is called the Start of Authority (SOA) record.

4. Click the green pencil icon to modify the SOA record.

The SOA record defaults to acceptable values in the majority of RaQ 4 configurations. You can fine tune the values for the following parameters:

- Primary name server host name
- Secondary name server host name (optional)
- Domain administrator email address
- Refresh interval
- Retry interval
- Expire interval
- Time-to-live (TTL) interval

5. Click **Save Changes**.
6. Click **Save Changes to DNS Server**.

## Name server (NS)

The primary name server defaults to the host name of the RaQ 4. You can specify the qualified host name of the secondary DNS server for that domain in the Secondary Name Server (NS) host name field. Some top-level domain registration organizations require that the secondary name server record be defined.

## Domain administrator email address

The email address defaults to the user name *admin* of the RaQ 4. This email address is publicly available and is the administrative contact for the domain or network served.

## Refresh interval

You can configure the refresh interval between updates from a secondary DNS server.

- If DNS record changes occur infrequently, increase the default value.
- If DNS record changes occur often, decrease the default value.

Tune the refresh interval to avoid wasting bandwidth and to ensure the content on the secondary server is accurate at all times.

## Retry interval

Due to a connection or service failure, a secondary DNS server may be unable to refresh data from the primary server. The secondary DNS server attempts to refresh data after the interval specified for trying again.

## Expire interval

A secondary DNS server may be unable to refresh data from the primary server for a prolonged period of time. After the interval specified for expiry, the secondary server stops serving name requests.

## Time-to-live period (TTL)

A caching DNS server other than the primary and secondary DNS servers for this domain or network can cache record lookups for the TTL period. During the TTL period, a caching DNS server does not poll the primary or secondary DNS servers for repeated lookups of the same record.

# Sample setup of DNS service

This sample setup assumes that you have already done two things:

1. You have registered your domain name. For more information on registering a domain name, visit the Internet Corporation for Assigned Names and Numbers (ICANN) at <http://www.icann.org>.
2. You have created the Web site on the RaQ 4. For instructions on how to do this, see “Developing Web pages” on page 145 and “Directory structure” on page 175.

In the following examples, we will configure a sample Web site called “www.mydomain.com” for Web service and email service using a sample IP address 192.168.10.10.



**Important:** Substitute your domain name and IP address where the sample domain name or sample IP address appears.

The recommended minimum configuration for Web and email service requires these records:

- An Address (A) Record for mydomain.com which resolves to 192.168.10.10
- An Address (A) Record for www.mydomain.com which resolves to 192.168.10.10
- A Mail Server (MX) Record for mydomain.com which resolves to www.mydomain.com
- A Reverse Address (PTR) record for 192.168.10.10 which points to mydomain.com

These records allow anyone on the Internet to type either “mydomain.com” or “www.mydomain.com” in order to access your Web site. To set up these records, go to the Parameters section of the DNS server in the Cobalt user interface (UI).

1. On the **Server Management** screen, click **Control Panel**. The Service Settings table appears.
2. Click the check box to enable Domain Name System (DNS) service (if it is not already enabled).
3. Click **Save Changes**. The browser screen refreshes.
4. Click **Parameters** next to the DNS service in the Service Settings table. The DNS Settings table appears, as in Figure 63.

Figure 63. DNS Settings table

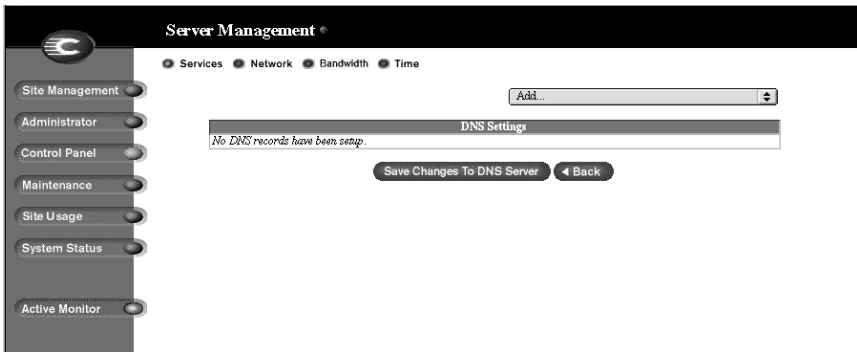

## Create an Address (A) Record

Create an Address (A) Record for “mydomain.com”:

1. Select Address (A) Record from the **Add...** pull-down menu
  - Leave the **Host Name** field blank.
  - In the **Domain Name** field, enter mydomain.com.
  - In the **IP Address** field, enter 192.168.10.10.
  - Ensure the check box for Automatic Reverse Address Record Generation is checked. This automatically creates the Reverse Address (PTR) Record.
2. Click **Update List**. The DNS Settings table is regenerated showing mydomain.com, as in Figure 64.

**Figure 64.** DNS Settings table (mydomain.com)

The screenshot shows the 'Server Management' interface with the 'DNS Settings for mydomain.com' table. The table is titled 'State of Authority (SOA) Configuration' and contains the following data:

Domain Name	IP Address	Host Name
mydomain.com	192.168.10.10	
192.168.10.10/24		mydomain.com

Below the table, there are buttons for 'Delete Domain', 'Save Changes To DNS Server', and 'Back'.

## Create a second Address (A) Record

Create a second Address (A) Record for “www.mydomain.com”.



**Note:** Do not make this a CNAME record. Some email server software cannot process CNAME records. If you would like to create multiple names for one IP address, create multiple A records. See “Specifying an alias (CNAME) record” on page 182 for the appropriate use of CNAME records.

1. Select Address (A) Record again from the **Add...** pull-down menu.
  - In the **Host Name** field, enter `www`.
  - In the **Domain Name** field, enter `mydomain.com`.
  - In the **IP Address** field, enter `192.168.10.10`.
  - Remove the check from the check box for Automatic Reverse Address Record Generation.
2. Click **Update List**. The DNS Settings table is regenerated showing `mydomain.com` and `www.mydomain.com`, as in Figure 65.

**Figure 65.** DNS Settings table (`mydomain.com` and `www.mydomain.com`)

The screenshot shows the 'Server Management' interface with a sidebar on the left containing menu items like 'Site Management', 'Administrator', 'Control Panel', 'Maintenance', 'Site Usage', 'System Status', and 'Active Monitor'. The main content area has tabs for 'Services', 'Network', 'Bandwidth', and 'Time'. Below these is a 'Select Domain or Network...' dropdown and an 'Add...' button. The central table is titled 'DNS Settings for mydomain.com' and contains the following data:

Start of Authority (SOA) Configuration			
mydomain.com	→	192.168.10.10	[edit] [delete]
www.mydomain.com	→	192.168.10.10	[edit] [delete]
192.168.10.10/24	→	mydomain.com	[edit] [delete]

Below the table are buttons for 'Delete Domain', 'Save Changes To DNS Server', and 'Back'.

## Create a Mail Server (MX) Record

To receive mail for “mydomain.com”, create a Mail Server (MX) Record. An MX record is similar to a A record but points to a name rather than an IP address. It is critical that the MX record point to a name which has a corresponding A record with the proper IP address.

1. Select Mail Server (MX) Record from the **Add...** pull-down menu.
  - Leave the **Host Name** field blank.
  - In the **Domain Name** field, enter mydomain.com.
  - In the **Mail Server** field, enter www.mydomain.com.
  - In the **Delivery Preference** field, you can choose from the pull-down menu Very Low, Low, High or Very High.

For our example, the Delivery Preference can be set to High.

2. Click **Update List**. The DNS Settings table is regenerated. See Figure 66.

You are now finished with creating your DNS records.



**Important:** Click **Save Changes to DNS Server**. This activates the changes you have made. If you exit this screen without saving your changes, they will not become active.

The completed DNS Settings table is regenerated as in Figure 66.

**Figure 66.** Completed DNS Settings table

The screenshot shows the 'Server Management' interface with the 'Services' tab selected. The 'DNS Settings for mydomain.com' table is displayed, showing the following records:

DNS Settings for mydomain.com			
Start of Authority (SOA) Configuration			
mydomain.com	→	192.168.10.10	[Edit] [Delete]
www.mydomain.com	→	192.168.10.10	[Edit] [Delete]
192.168.10.10/24	→	mydomain.com	[Edit] [Delete]
mydomain.com	mail is sent to the High priority mail server	www.mydomain.com	[Edit] [Delete]

Below the table are buttons for 'Delete Domain', 'Save Changes To DNS Server', and 'Back'.

To edit another domain, select another domain from the **Select Domain or Network...** pull-down menu. You can select any domain that you have configured for the DNS server.

To add a new domain, use the **Add...** pull-down menu again. In the **Domain Name** field, replace the default domain name with the new domain name that you want to create.

### **Further information**

For further information, refer to the following:

- In the Cobalt Knowledge Base, search on “DNS”.
- <http://www.dnswiz.com/dnsworks.htm>
- <http://www-europe.cisco.com/warp/public/787/indexDNS.html>

## **Brief history of the Domain Name System (DNS)**

In the 1960s, the U.S. Department of Defense Advanced Research Projects Agency (ARPA, and later DARPA) began funding an experimental wide area computer network called the ARPAnet. The ARPAnet used a centrally administered file called HOSTS.TXT which held all name-to-address mapping for each host computer connected to the ARPAnet. Since there were only a handful of host computers at the start, HOSTS.TXT worked well.

When the ARPAnet moved to the Transmission Control Protocol/Internet Protocol (TCP/IP) suite of protocols and become known as the Internet, the population of the network exploded. HOSTS.TXT became plagued with problems, namely

- traffic and load
- name collisions
- consistency

A replacement for the HOSTS.TXT file was needed. The goal was to create a system that solved the problems inherent in a unified host table system. The new system should allow local administration of data and also make that data globally available.

In 1984, the architecture of a new system called Domain Name System (DNS) was designed and is the basis of the DNS service used today on the Internet.



DNS is a distributed database that allows local administration of the segments on the overall database. Data in each segment of the database are available across the entire network through a client-server scheme consisting of name servers and resolvers.

## **What is a DNS record?**

People are much more comfortable dealing with names rather than strings of numbers. A domain name such as “cobalt.com” is much easier to remember than the IP address which consists of four octets of numbers such as 207.91.131.30. Domain names must be registered with Root Domain Registration Service; visit the Internet Corporation for Assigned Names and Numbers (ICANN) at <http://www.icann.org>. for a list accredited domain-name registrars.

Computers, on the other hand, prefer numbers to names. Since computers have the final say when a user is looking for a company Web site, a mechanism is needed to convert the human-friendly domain name to the computer-friendly IP address.

DNS records on a DNS server perform this function. The records translate a domain name to an IP address; a record equates a domain name such as “cobalt.com” to an IP address such as 207.91.131.30. Once the domain name has been converted or “resolved” to an IP address, then (and only then) can the user connect to your Web site.

Without DNS and domain names, the user would be required to remember the IP address of every site they wanted to visit. With DNS servers and DNS records, customers and their software can easily remember how to get to your site.

## **Who manages your DNS records?**

Your DNS records can reside on any Cobalt server that has the DNS service enabled. You or your network administrator can easily configure a Cobalt server to act as a DNS server. To provide DNS service, ICANN requires a site to maintain both a primary and a secondary server. Your Cobalt server can act as the primary server and a DNS server from your Internet service provider (ISP) can act as the secondary server.

## **How does DNS work?**

The basic method that allows a domain name to direct customers to your Web site is shown in Figure 67. This diagram describes a request made by a Web browser as the customer attempts to log on to your Web site.

To determine which primary name server contains your domain name:

1. The local name server (the DNS resolver/browser machine) contacts the root-level name server maintained by several Internet root server authorities.
2. The root-level name server returns the IP address of the primary name server responsible for the requested domain name.
3. The local name server contacts the primary name server.
4. The primary name server holds the IP address information for the domain name in a database and satisfies the request from the local name server.
5. If the primary name server is unavailable, the local name server contacts the secondary name server that satisfies the request from the local name server. The local name server returns to the Web browser with the IP address for the requested domain name.
6. Using the IP address, the Web browser contacts the company Web server.
7. The company Web server sends the Web page to the local name server.

**Figure 67.** Basic method of DNS

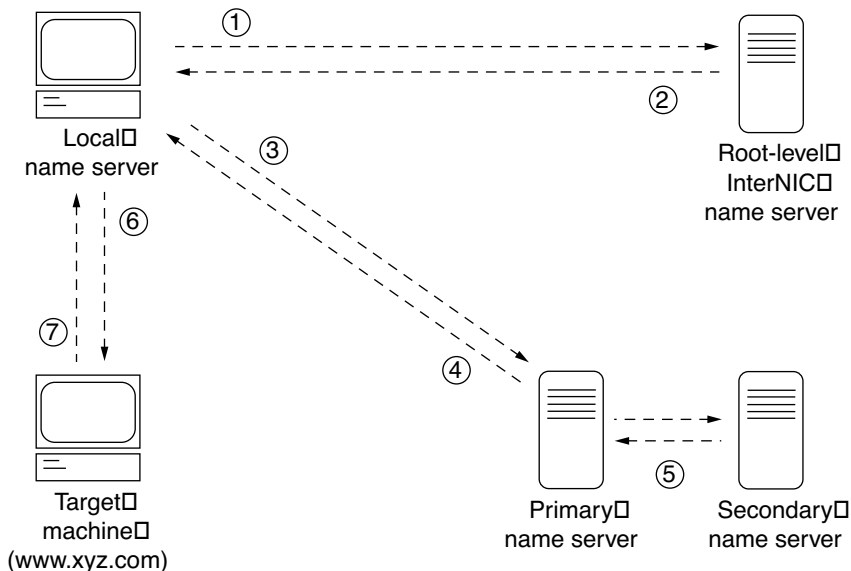

# Licenses

---

## The BSD Copyright

Copyright ©1991, 1992, 1993, 1994 The Regents of the University of California. All rights reserved.

Redistribution and use in source and binary forms, with or without modification, are permitted provided that the following conditions are met:

1. Redistributions of source code must retain the above copyright notice, this list of conditions and the following disclaimer.
2. Redistributions in binary form must reproduce the above copyright notice, this list of conditions and the following disclaimer in the documentation and/or other materials provided with the distribution.
3. All advertising materials mentioning features or use of this software must display the following acknowledgment: This product includes software developed by the University of California, Berkeley and its contributors.
4. Neither the name of the University nor the names of its contributors may be used to endorse or promote products derived from this software without specific prior written permission.

THIS SOFTWARE IS PROVIDED BY THE REGENTS AND CONTRIBUTORS "AS IS" AND ANY EXPRESS OR IMPLIED WARRANTIES, INCLUDING BUT NOT LIMITED TO, THE IMPLIED WARRANTIES OF MERCHANTABILITY AND FITNESS FOR A PARTICULAR PURPOSE ARE DISCLAIMED. IN NO EVENT SHALL THE REGENTS OR CONTRIBUTORS BE LIABLE FOR ANY DIRECT, INDIRECT, INCIDENTAL, SPECIAL, EXEMPLARY OR CONSEQUENTIAL DAMAGES (INCLUDING, BUT NOT LIMITED TO, PROCUREMENT OF SUBSTITUTE GOODS OR SERVICES; LOSS OF USE, DATA, OR PROFITS; OR BUSINESS INTERRUPTION) HOWEVER CAUSED AND ON ANY THEORY OF LIABILITY, WHETHER IN CONTRACT, STRICT LIABILITY, OR TORT (INCLUDING NEGLIGENCE OR OTHERWISE) ARISING IN ANY WAY OUT OF THE USE OF THIS SOFTWARE, EVEN IF ADVISED OF THE POSSIBILITY OF SUCH DAMAGE.

# GNU General Public License

Version 2, June 1991

Copyright (C) 1989, 1991 Free Software Foundation, Inc.  
59 Temple Place - Suite 330, Boston, MA 02111-1307, USA

## TERMS AND CONDITIONS FOR COPYING, DISTRIBUTION AND MODIFICATION

**0.** This License applies to any program or other work which contains a notice placed by the copyright holder saying it may be distributed under the terms of this General Public License. The “Program,” below, refers to any such program or work, and a “work based on the Program” means either the Program or any derivative work under copyright law: that is to say, a work containing the Program or a portion of it, either verbatim or with modifications and/or translated into another language. (Hereinafter, translation is included without limitation in the term “modification.”) Each licensee is addressed as “you.”

Activities other than copying, distribution and modification are not covered by this License; they are outside its scope. The act of running the Program is not restricted, and the output from the Program is covered only if its contents constitute a work based on the Program (independent of having been made by running the Program). Whether that is true depends on what the Program does.

**1.** You may copy and distribute verbatim copies of the Program’s source code as you receive it, in any medium, provided that you conspicuously and appropriately publish on each copy an appropriate copyright notice and disclaimer of warranty; keep intact all the notices that refer to this License and to the absence of any warranty; and give any other recipients of the Program a copy of this License along with the Program.

You may charge a fee for the physical act of transferring a copy, and you may at your option offer warranty protection in exchange for a fee.

**2.** You may modify your copy or copies of the Program or any portion of it, thus forming a work based on the Program, and copy and distribute such modifications or work under the terms of Section 1 above, provided that you also meet all of these conditions:

- a. You must cause the modified files to carry prominent notices stating that you changed the files and the date of any change.
- b. You must cause any work that you distribute or publish, that in whole or in part contains or is derived from the Program or any part thereof, to be licensed as a whole at no charge to all third parties under the terms of this License.
- c. If the modified program normally reads commands interactively when run, you must cause it, when started running for such interactive use in the most ordinary way, to print or display an announcement including an appropriate copyright notice and a notice that there is no warranty (or else, saying that you provide a warranty) and that users may redistribute the program under these conditions, and telling the user how to view a copy of this License. (Exception: if the Program itself is interactive but does not normally print such an announcement, your work based on the Program is not required to print an announcement.)

These requirements apply to the modified work as a whole. If identifiable sections of that work are not derived from the Program, and can be reasonably considered independent and separate works in themselves, then this License, and its terms, do not apply to those sections when you distribute them as separate works. But when you distribute the same sections as part of a whole which is a work based on the Program, the distribution of the whole must be on the terms of this License, whose permissions for other licensees extend to the entire whole, and thus to each and every part regardless of who wrote it.

Thus, it is not the intent of this section to claim rights or contest your rights to work written entirely by you; rather, the intent is to exercise the right to control the distribution of derivative or collective works based on the Program.

In addition, mere aggregation of another work not based on the Program with the Program (or with a work based on the Program) on a volume of a storage or distribution medium does not bring the other work under the scope of this License.

**3.** You may copy and distribute the Program (or a work based on it, under Section 2) in object code or executable form under the terms of Sections 1 and 2 above, provided that you also do one of the following:

- a. Accompany it with the complete corresponding machine-readable source code, which must be distributed under the terms of Sections 1 and 2 above on a medium customarily used for software interchange; or,
- b. Accompany it with a written offer, valid for at least three years, to give any third party, for a charge no more than your cost of physically performing source distribution, a complete machine-readable copy of the corresponding source code, to be distributed under the terms of Sections 1 and 2 above on a medium customarily used for software interchange; or,
- c. Accompany it with the information you received as to the offer to distribute corresponding source code. (This alternative is allowed only for noncommercial distribution and only if you received the program in object code or executable form with such an offer, in accord with Subsection b above.)

The source code for a work means the preferred form of the work for making modifications to it. For an executable work, complete source code means all the source code for all modules it contains, plus any associated interface definition files, plus the scripts used to control compilation and installation of the executable. However, as a special exception, the source code distributed need not include anything that is normally distributed (in either source or binary form) with the major components (compiler, kernel, and so on) of the operating system on which the executable runs, unless that component itself accompanies the executable.

If distribution of executable or object code is made by offering access to copy from a designated place, then offering equivalent access to copy the source code from the same place counts as distribution of the source code, even though third parties are not compelled to copy the source along with the object code.

**4.** You may not copy, modify, sublicense or distribute the Program except as expressly provided under this License. Any attempt otherwise to copy, modify, sublicense or distribute the Program is void, and will automatically terminate your rights under this License. However, parties who have received copies, or rights, from you under this License will not have their licenses terminated, so long as such parties remain in full compliance.

**5.** You are not required to accept this License, since you have not signed it. However, nothing else grants you permission to modify or distribute the Program or its derivative works. These actions are prohibited by law if you do not accept this License. Therefore, by modifying or distributing the Program (or any work based on the Program), you indicate your acceptance of this License to do so, and all its terms and conditions for copying, distributing or modifying the Program or works based on it.

**6.** Each time you redistribute the Program (or any work based on the Program), the recipient automatically receives a license from the original licensor to copy, distribute or modify the Program subject to these terms and conditions. You may not impose any further restrictions on the recipients' exercise of the rights granted herein. You are not responsible for enforcing compliance by third parties to this License.

**7.** If, as a consequence of a court judgment or allegation of patent infringement or for any other reason (not limited to patent issues), conditions are imposed on you (whether by court order, agreement or otherwise) that contradict the conditions of this License, they do not excuse you from the conditions of this License. If you cannot distribute so as to satisfy simultaneously your obligations under this License and any other pertinent obligations, then as a consequence you may not distribute the Program at all. For example, if a patent license would not permit royalty-free redistribution of the Program by all those who receive copies directly or indirectly through you, then the only way you could satisfy both it and this License would be to refrain entirely from distribution of the Program.

If any portion of this section is held invalid or unenforceable under any particular circumstance, the balance of the section is intended to apply and the section as a whole is intended to apply in other circumstances.

It is not the purpose of this section to induce you to infringe any patents or other property right claims or to contest validity of any such claims; this section has the sole purpose of protecting the integrity of the free software distribution system, which is implemented by public license practices. Many people have made generous contributions to the wide range of software distributed through that system in reliance on consistent application of that system; it is up to the author/donor to decide if he or she is willing to distribute software through any other system and a licensee cannot impose that choice.

This section is intended to make thoroughly clear what is believed to be a consequence of the rest of this License.

**8.** If the distribution and/or use of the Program is restricted in certain countries either by patents or by copyrighted interfaces, the original copyright holder who places the Program under this License may add an explicit geographical distribution limitation excluding those countries, so that distribution is permitted only in or among countries not thus excluded. In such case, this License incorporates the limitation as if written in the body of this License.

**9.** The Free Software Foundation may publish revised and/or new versions of the General Public License from time to time. Such new versions will be similar in spirit to the present version, but may differ in detail to address new problems or concerns.

Each version is given a distinguishing version number. If the Program specifies a version number of this License which applies to it and “any later version”, you have the option of following the terms and conditions either of that version or of any later version published by the Free Software Foundation. If the Program does not specify a version number of this License, you may choose any version ever published by the Free Software Foundation.

**10.** If you wish to incorporate parts of the Program into other free programs whose distribution conditions are different, write to the author to ask for permission. For software which is copyrighted by the Free Software Foundation, write to the Free Software Foundation; we sometimes make exceptions for this. Our decision will be guided by the two goals of preserving the free status of all derivatives of our free software and of promoting the sharing and reuse of software generally.



## **NO WARRANTY**

**11.** BECAUSE THE PROGRAM IS LICENSED FREE OF CHARGE, THERE IS NO WARRANTY FOR THE PROGRAM, TO THE EXTENT PERMITTED BY APPLICABLE LAW. EXCEPT WHEN OTHERWISE STATED IN WRITING, THE COPYRIGHT HOLDERS AND/OR OTHER PARTIES PROVIDE THE PROGRAM “AS IS” WITHOUT WARRANTY OF ANY KIND, EITHER EXPRESSED OR IMPLIED, INCLUDING, BUT NOT LIMITED TO, THE IMPLIED WARRANTIES OF MERCHANTABILITY AND FITNESS FOR A PARTICULAR PURPOSE. THE ENTIRE RISK AS TO THE QUALITY AND PERFORMANCE OF THE PROGRAM IS WITH YOU. SHOULD THE PROGRAM PROVE DEFECTIVE, YOU ASSUME THE COST OF ALL NECESSARY SERVICING, REPAIR OR CORRECTION.

**12.** IN NO EVENT, UNLESS REQUIRED BY APPLICABLE LAW OR AGREED TO IN WRITING, WILL ANY COPYRIGHT HOLDER, OR ANY OTHER PARTY WHO MAY MODIFY AND/OR REDISTRIBUTE THE PROGRAM AS PERMITTED ABOVE, BE LIABLE TO YOU FOR DAMAGES, INCLUDING ANY GENERAL, SPECIAL, INCIDENTAL OR CONSEQUENTIAL DAMAGES ARISING OUT OF THE USE OR INABILITY TO USE THE PROGRAM (INCLUDING BUT NOT LIMITED TO LOSS OF DATA OR DATA BEING RENDERED INACCURATE OR LOSSES SUSTAINED BY YOU OR THIRD PARTIES OR A FAILURE OF THE PROGRAM TO OPERATE WITH ANY OTHER PROGRAMS), EVEN IF SUCH HOLDER OR OTHER PARTY HAS BEEN ADVISED OF THE POSSIBILITY OF SUCH DAMAGES.

# SSL License

Copyright (c) 1998-1999 Ralf S. Engelschall. All rights reserved.

Redistribution and use in source and binary forms, with or without modification, are permitted provided that the following conditions are met:

1. Redistributions of source code must retain the above copyright notice, this list of conditions and the following disclaimer.
2. Redistributions in binary form must reproduce the above copyright notice, this list of conditions and the following disclaimer in the documentation and/or other materials provided with the distribution.
3. All advertising materials mentioning features or use of this software must display the following acknowledgment:

“This product includes software developed by Ralf S. Engelschall <rse@engelschall.com> for use in the mod\_ssl project ([http://www.engelschall.com/sw/mod\\_ssl/](http://www.engelschall.com/sw/mod_ssl/)).”

4. The name “mod\_ssl” must not be used to endorse or promote products derived from this software without prior written permission. For written permission, please contact rse@engelschall.com.
5. Products derived from this software may not be called “mod\_ssl” nor may “mod\_ssl” appear in their names without prior written permission of Ralf S. Engelschall.
6. Redistributions of any form whatsoever must retain the following acknowledgment:

“This product includes software developed by Ralf S. Engelschall <rse@engelschall.com> for use in the mod\_ssl project ([http://www.engelschall.com/sw/mod\\_ssl/](http://www.engelschall.com/sw/mod_ssl/)).”

THIS SOFTWARE IS PROVIDED BY RALF S. ENGELSCHALL “AS IS” AND ANY EXPRESSED OR IMPLIED WARRANTIES, INCLUDING, BUT NOT LIMITED TO, THE IMPLIED WARRANTIES OF MERCHANTABILITY AND FITNESS FOR A PARTICULAR PURPOSE ARE DISCLAIMED. IN NO EVENT SHALL RALF S. ENGELSCHALL OR HIS CONTRIBUTORS BE LIABLE FOR ANY DIRECT, INDIRECT, INCIDENTAL, SPECIAL, EXEMPLARY, OR CONSEQUENTIAL DAMAGES (INCLUDING, BUT NOT LIMITED TO, PROCUREMENT OF SUBSTITUTE GOODS OR SERVICES; LOSS OF USE, DATA, OR PROFITS; OR BUSINESS INTERRUPTION) HOWEVER CAUSED AND ON ANY THEORY OF LIABILITY, WHETHER IN CONTRACT, STRICT LIABILITY, OR TORT (INCLUDING NEGLIGENCE OR OTHERWISE) ARISING IN ANY WAY OUT OF THE USE OF THIS SOFTWARE, EVEN IF ADVISED OF THE POSSIBILITY OF SUCH DAMAGE.

# Glossary

---

The entries in this glossary are for your information. Not all of the concepts, technologies and protocols apply to the RaQ 4 server.

## **10/100 BaseTX**

An Ethernet connection over twisted-pair cables with a throughput of 10 Mb/s or 100 Mb/s.

## **10BaseT**

A 10-Mb/s baseband Ethernet specification using two pairs of twisted-pair cabling (Category 3, 4, or 5): one pair for transmitting data and the other for receiving data. 10BaseT (part of the IEEE 802.3 specification) has a distance limit of approximately 328 feet (100 meters) per segment.

## **100BaseTX**

A 100-Mb/s baseband Fast Ethernet specification using two pairs of either unshielded twisted pair (UTP) or shielded twisted pair (STP) wiring. The first pair of wires is used to receive data; the second pair is used to transmit. To guarantee proper signal timing, a 100BaseTX segment cannot exceed 328 feet (100 meters) in length. 100BaseTX is based on the IEEE 802.3 standard.

## **Active Server Pages (ASP)**

ASP is an HTML-embedded scripting language that includes one or more small embedded programs, or *scripts*, that are processed on a Web server before the Web page is sent to the user. An ASP is somewhat similar to a server-side include or a common gateway interface (CGI) application in that all three involve programs that run on the server, usually tailoring a page for the user.

For example, an ASP script can use the input from the user's request for the page to access data from a database. The script then builds or customizes the page on the fly and returns it to the requestor. The Web server does all of the processing, and a standard HTML page is generated and sent to the browser.

## **APOP**

See *Authentication Post Office Protocol (APOP)*.

## **AppleShare**

A file-sharing protocol in Apple system software that allows sharing of files and network services through a file server in the Apple Macintosh environment.

## **ASP**

See *Active Server Page (ASP)*.

## **Authentication**

The process whereby a user or information source proves they are who they claim to be; in other words, the process of verifying the identity of a user, device or other entity in a computer system, often as a prerequisite to allowing access to resources in a system. Authentication is any technique enabling the receiver to automatically identify and reject messages that have been altered either deliberately or by channel errors.

See also *Encryption* and *Secure Sockets Layer (SSL)*.

## **Authentication Post Office Protocol (APOP)**

Authentication POP is a challenge-response authentication scheme built on top of the standard POP protocol. APOP is designed in a way that protects your password from being sent across the network. To keep your password safe, the server stores your password in a file on local disk drive. When your mail client connects to the APOP server, a magic string is sent back. That string contains a unique identifier for the current session based upon the process id (PID) and current time.

## **Carrier sense**

In a local area network (LAN), an ongoing activity of a data station to detect whether another station is transmitting.

## **Carrier sense multiple access with collision detection (CSMA/CD)**

A protocol that requires carrier sense and in which a transmitting data station that detects another signal while transmitting stops sending, sends a jam signal and then waits for a variable period of time before sending again. Used in ethernet LAN technology.

## **CGI**

See *Common gateway interface (CGI)*.

## **Common gateway interface (CGI)**

A set of rules that describe how a Web server communicates with another application running on the same computer and how the application (called a CGI program) communicates with the Web server. Any application can be a CGI program if it handles input and output according to the CGI standard.

## **Collision**

In an ethernet network, a collision is the result of two devices attempting to transmit data at exactly the same time. The network detects the “collision” of the two transmitted packets and discards them both. Collisions are a natural occurrence on an ethernet network.

Ethernet technology uses carrier sense multiple access/collision detect (CSMA/CD) to allow devices to take turns using the signal carrier line. When a device wants to transmit, it checks the signal level of the line to determine whether another device is already using it. If the line is already in use, the device waits and tries again, perhaps in a few seconds. If the line is not in use, the device transmits.

However, two devices can transmit at the same time in which case a collision occurs and both devices detect it. Each device then waits a random amount of time and retries until successful in getting the transmission sent.

## **CSMA/CD**

See *Carrier sense multiple access with collision detection (CSMA/CD)*.

## **DHCP**

See *Dynamic Host Configuration Protocol (DHCP)*.

## **Digital Subscriber Line (DSL)**

A technology for bringing high-bandwidth information to homes and small businesses over ordinary copper telephone lines. The term xDSL refers to different variations of DSL, such as asymmetric DSL (ADSL), high-bit-rate DSL (HDSL) and rate-adaptive DSL (RADSL). If your home or small business is close enough to a telephone company central office that offers DSL service, you may be able to receive data at rates of up to 6.1 Mb/s. More typically, individual connections provide from 512 kb/s to 1.544 Mb/s downstream and about 128 kb/s upstream. A DSL line can carry both data and voice signals and the data part of the line is continuously connected.

## **DNS**

See *Domain Name System (DNS)*.

## **Domain name**

The location of an organization or other entity on the Internet. For example, the address `www.cobalt.com` locates an Internet address for the domain name “cobalt.com” at a particular IP address and a particular host server named “www.”

## **Domain Name System (DNS)**

The Internet service responsible for translating a human-readable host name such as `cobalt.com` into a numeric IP address (for example, `192.168.10.10`) for TCP/IP communications.

## **DSL**

See *Digital Subscriber Line (DSL)*.

## **Dynamic Host Configuration Protocol (DHCP)**

A protocol that provides a mechanism for allocating IP addresses dynamically so that an address can be reused when a host no longer needs it.

## **Encryption**

The transformation of data into a form unreadable by anyone without a secret decryption key. Its purpose is to ensure privacy by keeping the information hidden from anyone for whom it is not intended. In the area of security, encryption is the ciphering of data by applying an algorithm to plain text to convert it into cipher text.

See also *Authentication* and *Secure Sockets Layer (SSL)*.

## **ESMTP**

See *Extended Simple Mail Transfer Protocol (ESMTP)*.

## **Ethernet**

The most widely used technology for local area networks (LANs). Standard ethernet runs at 10 Mb/s, 100 Mb/s or 1000 Mb/s. It balances speed, price, ease of installation and availability.

## **ETRN**

ETRN (Extended Turn) is an extension to the Simple Mail Transfer Protocol (SMTP) that allows an SMTP server to send a request to another SMTP server to send any email messages it has. Typically, SMTP is used with two other protocols, Post Office Protocol 3 (POP3) or Internet Message Access Protocol (IMAP), to request messages from a server; SMTP by itself cannot request mail to be sent by another server.

ETRN is designed for use by anyone who is traveling and wants to access their email. ETRN can only be used with Internet service providers (ISPs) that support ETRN.

## **Extended Simple Mail Transfer Protocol (ESMTP)**

The Extended Simple Mail Transfer Protocol specifies extensions to the original SMTP protocol for sending email that supports graphics, audio and video files, and text in various national languages. ESMTP provides the capability for a client email program to inquire of a server email program about which capabilities it supports and then communicate accordingly.

## **File sharing**

The public or private sharing of computer data or space in a network with various levels of access privileges.

## **File Transfer Protocol (FTP)**

A standard Internet protocol and a way to exchange files between computers connected to the Internet. FTP is an application protocol that uses TCP/IP protocols. FTP is commonly used to transfer Web page files from the computer that was used to create the files to the computer that acts as the server for these files. It is also used to download programs and other files to your computer from other servers.

Using FTP, you can update—delete, rename, move and copy—files at a server. You need to log on to an FTP server. However, publicly available files are easily accessed using anonymous FTP.

## **FTP**

See *File Transfer Protocol (FTP)*.

## **Gateway**

A network device that acts as an entrance to another network. A gateway can also be any device that passes packets from one network to another network across the Internet.

## **HTML**

See *HyperText Markup Language (HTML)*.

## **HTTP**

See *HyperText Transfer Protocol (HTTP)*.

## **HyperText Markup Language (HTML)**

A set of “markup” symbols or tags inserted in a text file intended for display on a World Wide Web browser. The markup tags tell the Web browser how to display a Web page’s content, words, and images. HTML is a subset of Standardized Generalized Markup Language (SGML).

## **HyperText Transfer Protocol (HTTP)**

A set of rules for exchanging files (text, graphic images, sound, video and other multimedia files) on the World Wide Web.

## **ICANN**

See *Internet Corporation for Assigned Names and Numbers (ICANN)*.

## **IEEE 802.3**

IEEE local area network (LAN) protocol that specifies an implementation of the physical layer and the media access control (MAC) sublayer of the data link layer. IEEE 802.3 uses CSMA/CD access at a variety of speeds over a variety of physical media. Extensions to the IEEE 802.3 standard specify implementations for Fast Ethernet. Physical variations of the original IEEE 802.3 specification include 10Base2, 10Base5, 10BaseF, 10BaseT and 10Broad36. Physical variations for Fast Ethernet include 100BaseT, 100BaseT4 and 100BaseX.

## **IMAP**

See *Internet Message Access Protocol (IMAP)*.



## **Integrated Services Digital Network (ISDN)**

A system of digital telephone connections. This system allows data to be transmitted simultaneously across the world using end-to-end digital connectivity.

With ISDN, voice and data are carried by bearer channels (B channels) occupying a bandwidth of 64 kb/s (some switches limit B channels to a capacity of 56 kb/s). A data channel (D channel) handles signaling at 16 kb/s or 64 kb/s, depending on the type of service.

There are two basic types of ISDN service: Basic Rate Interface (BRI) and Primary Rate Interface (PRI). BRI consists of two 64-kb/s B channels and one 16-kb/s D channel for a total of 144 kb/s. This basic service is intended to meet the needs of most individual users.

PRI is intended for users with greater capacity requirements. Typically, the channel structure is 23 B channels plus one 64-kb/s D channel for a total of 1536 kb/s. In Europe, PRI consists of 30 B channels plus one 64-kb/s D channel for a total of 1984 kb/s.

## **InterBase**

An open-source, cross-platform SQL database from Inprise Corporation. InterBase offers a number of database features—triggers, stored procedures, blobs, event alerters, user-defined functions, multi-dimensional arrays, two-phase commit, referential integrity, constraints and a flexible set of transaction options.

## **Internet Corporation for Assigned Names and Numbers (ICANN)**

The private (non-government) non-profit corporation that has been formed to assume responsibility for the IP address space allocation, protocol parameter assignment, domain name system (DNS) management and root server system management functions.

## **Internet domain**

An Internet domain is a host-naming convention used to ensure that no two individual hosts on the global Internet have the same host name. An Internet domain should not be confused with an NT Domain.

## Internet Message Access Protocol (IMAP)

Internet Message Access Protocol is a standard protocol for accessing email from your local server. IMAP is a client/server protocol in which email is received and held for you by your Internet server. You (or your email client) can view just the heading and the sender of the letter and then decide whether to download the mail from the server. You can also create and manipulate folders or mailboxes on the server, delete messages or search for certain parts or an entire note. IMAP requires continuous access to the server during the time that you are working with your mail.

IMAP can be thought of as a remote file server. Another protocol, Post Office Protocol (POP), can be thought of as a store-and-forward service. In other words, your email messages are held at the server until you open your email client and download the messages to your local machine.

POP and IMAP deal with receiving email from your local server; Simple Mail Transfer Protocol (SMTP) is a protocol for transferring email between points on the Internet. You send email with SMTP and a mail handler receives it on your recipient's behalf. Then the mail is read using POP or IMAP.

See also *Post Office Protocol 3 (POP3)* and *Simple Mail Transfer Protocol (SMTP)*.

## Internet Protocol (IP)

A network-layer protocol in the TCP/IP stack offering a connectionless internetwork service. IP provides features for addressing, type-of-service specification, fragmentation and reassembly, and security. IP is defined in RFC 791.

### IP address

A 32-bit address assigned to hosts using Transmission Control Protocol/Internet Protocol (TCP/IP) and written as four octets separated by periods (for example, 192.168.10.10), also called the dotted decimal format. Each address consists of a network number, an optional subnetwork number and a host number. The network and subnetwork numbers together are used for routing, while the host number is used to address an individual host within the network or subnetwork. A subnet mask is used to extract network and subnetwork information from the IP address. Also called an Internet address.

### IP Masquerading

See *Network Address Translation (NAT)*.

### ISDN

See *Integrated Services Digital Network (ISDN)*.

## **Kernel**

The essential center of a computer operating system, the core that provides basic services for all other parts of the operating system. A kernel can be contrasted with a shell, the outermost part of an operating system that interacts with user commands. *Kernel* and *shell* are terms used more frequently in UNIX.

See also *Shell*.

## **LAN**

See *local area network (LAN)*.

## **Leased IP address**

An IP address assigned by the Dynamic Host Configuration Protocol (DHCP) to an unrecognized computing device. This method involves setting up a leased pool of IP addresses that are allocated dynamically when new devices are booted and recognized on the network.

## **Local area network (LAN)**

A high-speed, low-error data network covering a relatively small geographic area (up to a few thousand meters). A LAN connects workstations, peripherals, terminals and other devices in a single building or other geographically limited area. LAN standards specify cabling and signaling at the physical and data link layers of the Open Systems Interconnection (OSI) model. Widely used LAN technologies include Ethernet, fiber distributed data interface (FDDI) and token ring.

See also *wide area network (WAN)*.

## **Logical memory**

See *Virtual memory*.

## **Media access control (MAC) sublayer**

The lower of the two sublayers of the data link layer defined by the IEEE. The MAC sublayer handles access to shared media, such as whether token passing or contention is used.

### **Media access control (MAC) address**

A standardized data-link-layer address that is required for every port or device that connects to a LAN. Other devices in the network use these addresses to locate specific ports in the network, and to create and update routing tables and data structures. MAC addresses are six bytes long and are controlled by the IEEE. Also known as a hardware address, a MAC-layer address and a physical address.

When your computer is connected to the Internet, a correspondence table relates your IP address to your computer's physical (MAC) address on the network.

### **Name server**

A program that constitutes the server half of the DNS client-server mechanism. A name server contains information about a segment of the DNS database and makes it available to a client called a resolver. A resolver is often just a library routine that creates queries and sends them across a network to a name server.

### **NAT**

See *Network Address Translation (NAT)*.

### **Netmask**

See *subnet mask*.

### **Network Address Translation (NAT)**

A mechanism for reducing the need for globally unique IP addresses. NAT allows an organization with addresses that are not globally unique to connect to the Internet by translating those addresses into globally routable address space. Also known as *Network Address Translator* and *IP Masquerading*.

### **Network Time Protocol (NTP)**

A protocol that synchronizes the time of a local computer client or server to radio clocks and atomic clocks located on the Internet. This protocol is capable of synchronizing distributed clocks within milliseconds over long time periods. Some configurations include cryptographic authentication to prevent accidental or malicious protocol attacks.

### **NTP**

See *Network Time Protocol (NTP)*.

## Packet

The unit of data that is routed between an origin and a destination on the Internet or any other packet-switched network. The packet includes a header containing control information and (usually) user data. Packets are most often used to refer to network layer units of data.

## PCI

See *Peripheral Component Interface (PCI)*.

## Peripheral Component Interconnect (PCI)

Peripheral Component Interconnect (PCI) is an interconnection system between a microprocessor and attached devices in which expansion slots are spaced closely for high-speed operation.

PCI transmits 32 bits at a time in a 124-pin connection (the extra pins are for power supply and grounding) and 64 bits in a 188-pin connection in an expanded implementation. PCI uses all active paths to transmit both address and data signals, sending the address on one clock cycle and data on the next. Burst data can be sent starting with an address on the first cycle and a sequence of data transmissions on a certain number of successive cycles.

## PHP embedded scripting

PHP is an HTML-embedded scripting language that includes one or more small embedded programs, or *scripts*, that are processed on a Web server before the Web page is sent to the user.

Much of the PHP syntax is borrowed from C, Java and Perl with a few unique PHP-specific features thrown in. The goal of the language is to allow Web developers to write dynamically generated pages quickly.

## Point-to-Point Protocol (PPP)

A protocol for communication between two computers using a serial interface, typically a personal computer connected by telephone line to a server. For example, your Internet server provider may provide you with a PPP connection so that the provider's server can respond to your requests, pass them on to the Internet and forward your requested Internet responses back to you. PPP uses the Internet protocol (and is designed to handle others).

PPP is a full-duplex protocol that can be used on various physical media, including twisted pair, fiber optic lines or satellite transmission. It uses a variation of High Speed Data Link Control for packet encapsulation. PPP can handle synchronous as well as asynchronous communication.

### **Point-to-Point Protocol over Ethernet (PPPoE)**

A specification for connecting multiple computer users on an ethernet to a remote site through common customer-premises equipment such as a modem and similar devices. PPPoE can be used to allow an office or building full of users share a common digital subscriber line (DSL), cable modem or wireless connection to the Internet. PPPoE combines the Point-to-Point Protocol (PPP), commonly used in dial-up connections, with the ethernet protocol, which supports multiple users in a local area network (LAN). PPP information is encapsulated within an Ethernet frame.

### **POP3**

See *Post Office Protocol (POP3)*.

### **Post Office Protocol 3 (POP3)**

Post Office Protocol (POP) is a standard protocol for receiving email. POP is a client/server protocol in which email is received and held for you by your Internet server. When you read your mail, all of it is immediately downloaded to your computer and no longer maintained on the server, unless specified otherwise in the email client. POP3 is built into the Netscape Navigator and Microsoft Internet Explorer browsers.

POP can be thought of as a store-and-forward service; in other words, your email messages are held at the server until you open your email client and download the messages to your local machine. Another protocol, Internet Message Access Protocol (IMAP), can be thought of as a remote file server.

POP and IMAP deal with receiving email from your local server; Simple Mail Transfer Protocol (SMTP) is a protocol for transferring email between points on the Internet. You send email with SMTP and a mail handler receives it on your recipient's behalf. The mail is then read using POP or IMAP.

See also *Internet Message Access Protocol (IMAP)* and *Simple Mail Transfer Protocol (SMTP)*.

### **PPP**

See *Point-to-Point Protocol*.

### **PPPoE**

See *Point-to-Point Protocol over Ethernet*.

### **RAID**

See *Redundant Array of Independent Disks (RAID)*.

## Redundant Array of Independent Disks (RAID)

A redundant array of independent disks is a way of storing the same data in different places (thus, redundantly) on multiple hard disk drives. A RAID appears to the operating system to be a single virtual disk drive.

Redundancy means that there is protection against the failure of any single hard disk drive. Redundant data is used by a RAID system in the event of a failure; this redundant data can either be a mirror copy or parity data used to reconstruct the actual data.

There are a variety of different types and implementations of RAID, each with its own advantages and disadvantages.

- **RAID-0** combines the separate hard disk drives into one virtual disk drive and offers the best performance of the three options. However, the data on the disk drives is not redundant and the system is thus not fault-tolerant. This option is available on server configurations with two or more hard disk drives.
- **RAID-1**, also known as disk mirroring, consists of a primary hard disk drive and a secondary hard disk drive; the secondary disk drive is an exact copy or “mirror image” of the primary disk drive. This option is only available on a configuration with two hard disk drives.
- **RAID-5** includes a rotating parity-bit array. All read and write operations can be overlapped. RAID-5 does not store redundant data but it does store the parity information which can be used to reconstruct data in the event of a single hard-disk-drive failure. RAID-5 requires at least three hard disk drives for the array.

Although RAID-1 and RAID-5 (but not RAID-0) can protect your data in case of a hard-disk-drive failure, they do not protect against operator and administrator (human) error, or against loss due to programming bugs.

RAID can be implemented in hardware or in software. Hardware RAID is always a “disk controller”, that is, a device to which one can cable up the hard disk drives. Software RAID is a set of kernel modules, together with management utilities that implement RAID purely in software, and require no extra hardware.

## Root name server

On the Internet, the root name server system is the manner in which an authoritative master list of all top-level domain names (such as .com, .net, .org and individual country codes) is maintained and made available.

## SCSI

See *Small Computer System Interface (SCSI)*.

## Secure Sockets Layer (SSL)

Secure Sockets Layer is a program layer created by Netscape Communications for managing the security of message transmissions in a network. Netscape's idea was that the programming for keeping your messages confidential ought to be contained in a program layer between higher-level protocols (such as HTTP or IMAP) and the TCP/IP layers of the Internet. The "sockets" part of the term refers to the sockets method of passing data between a client and a server program in a network or between program layers in the same computer.

SSL allows an SSL-enabled server to authenticate itself to an SSL-enabled client, allows the client to authenticate itself to the server, and allows both machines to establish an encrypted connection.

These capabilities address fundamental concerns about communication over the Internet and other TCP/IP networks:

- SSL server authentication allows a user to confirm the identity of a server. SSL-enabled client software can use standard techniques of public-key cryptography to check that a server's certificate and public ID are valid and have been issued by a certificate authority (CA) listed in the client's list of trusted CAs. This confirmation can be important if, for example, the user is sending a credit card number over the network and wants to check the receiving server's identity.
- SSL client authentication allows a server to confirm a user's identity. Using the same techniques as those used for server authentication, SSL-enabled server software can check that a client's certificate and public ID are valid and have been issued by a certificate authority (CA) listed in the server's list of trusted CAs. This confirmation can be important if, for example, the server is a bank sending confidential financial information to a customer and wants to check the recipient's identity.
- an encrypted SSL connection requires all information sent between a client and a server to be encrypted by the sending software and decrypted by the receiving software, thus providing a high degree of confidentiality. Confidentiality is important for both parties to any private transaction. In addition, all data sent over an encrypted SSL connection is protected with a mechanism for detecting tampering—that is, for automatically determining whether the data has been altered in transit.

See also *Authentication* and *Encryption*.



## Server

A system program that awaits requests from client programs in the same computer or across a network, and services those requests. A server can be dedicated, in which case this is its sole function, or non-dedicated, where the system can be used in other ways, such as a workstation.

## Server Message Block (SMB)

A protocol that enables client applications in a computer to read and write files on a computer network and to request services from server programs in a computer network for systems running Microsoft Windows.

## Shell

A UNIX term for the interactive user interface (UI) within an operating system. The shell is the layer of programming that understands and executes the commands entered by a user. In some systems, the shell is called a *command interpreter*. A shell usually implies an interface with a command syntax.

The root shell has “root” permissions and is the highest level of shell.

As the outer layer of an operating system, a shell can be contrasted with the kernel, the operating system’s inmost layer or core of services.

See also *Kernel*.

## Simple Mail Transfer Protocol (SMTP)

The TCP/IP standard protocol for transferring electronic mail messages between points on the Internet. SMTP specifies how two mail systems interact and the format of control messages they exchange to transfer mail.

SMTP is a protocol for transferring email between points on the Internet; Post Office Protocol (POP) and Internet Message Access Protocol (IMAP) deal with receiving email from your local server. You send email with SMTP and a mail handler receives it on your recipient’s behalf. The mail is then read using POP or IMAP.

See also *Internet Message Access Protocol (IMAP)* and *Post Office Protocol 3 (POP3)*.

## Simple Network Management Protocol (SNMP)

A network management protocol used almost exclusively in TCP/IP networks. SNMP provides a means to monitor and control network devices, and to manage configurations, statistics collection, performance and security on a network.

## **Small Computer System Interface (SCSI)**

A parallel interface standard used by PCs, some Apple Macintosh computers and many Unix systems for attaching peripheral devices to computers. SCSI interfaces provide for faster data transmission rates (up to 160 Mb/s) than standard serial and parallel ports. In addition, you can attach many devices to a single SCSI port, so that SCSI is really an input/output bus rather than simply an interface.

## **SMB**

See *Server Message Block (SMB)*.

## **SMTP**

See *Simple Mail Transfer Protocol (SMTP)*.

## **SNMP**

See *Simple Network Management Protocol (SNMP)*.

## **SSL**

See *Secure Sockets Layer (SSL)*.

## **Subnet mask**

A number that, in conjunction with an IP address, defines the set of IP addresses that are considered “local.” For example, if your IP address is 192.168.25.77 and your subnet mask is 255.255.255.0, then addresses between 192.168.25.1 and 192.168.25.255 are considered local. Also known as *netmask*.

## **Swap file**

A space on a hard disk drive used as the virtual memory extension of a computer’s random access memory (RAM). Having a swap file allows the computer’s operating system to pretend that it has more RAM than it actually does. The least-recently-used files in RAM are “swapped out” to your hard disk drive until they are needed later; in their place, new program segments or data can be “swapped in” to RAM.

## **Transmission Control Protocol (TCP)**

A connection-oriented transport-layer protocol that provides reliable full-duplex data transmission. TCP is part of the TCP/IP protocol stack.

## **Transmission Control Protocol/Internet Protocol (TCP/IP)**

A common name for the suite of protocols developed in the 1970s to support the construction of worldwide internetworks. TCP and IP are the two best-known protocols in the suite. The TCP/IP protocols enable computers and networks to connect to an intranet or Internet.

## Virtual host

See *Virtual site*.

## Virtual memory

A concept that, when implemented by a computer and its operating system, allows programmers to use a very large range of memory or storage addresses for stored data.

## Virtual site

Whereas industry uses the term *virtual host*, Cobalt Networks uses the term *virtual site*.

In Cobalt's definition, a virtual site consists of a Domain Name System (DNS) domain with Web, FTP and email services. Each virtual site contains its own list of site-user accounts. Each site-user account has its own Web page, FTP directory, email spool and any number of email aliases. The fully qualified domain name of a virtual site is unique to that site, while its IP address can be shared by many sites.

With the advent of name-based virtual hosting, it is no longer necessary to dedicate an IP address to a virtual site. The Web server can now differentiate among target virtual sites according to the name requested. Many virtual sites on the RaQ 4 can share one IP address. However, not all services are compatible with name-based virtual hosting: SSL encryption for Web data, bandwidth management and an anonymous FTP account can only be enabled on one virtual site per IP address hosted by the RaQ 4.

The IP address of the RaQ 4 can be shared by many virtual sites or it can be unique to one virtual site.

The RaQ 4 has one main site (which by default cannot be deleted) and virtual sites. The main site uses the IP address assigned to the RaQ 4 using the LCD console.

## Wide area network (WAN)

A data communications network that serves users across a broad geographic area and often uses transmission devices provided by common carriers. Asynchronous transfer mode (ATM), frame relay, Switched Multimegabit Data Service (SMDS) and X.25 are examples of WANs.

See also *local area network (LAN)*.



# Index

---

## Numerics

- 10/100BaseTX 6
- 100BaseTX 6
- 10BaseT 6

## A

- Active Monitor 93
  - status colors 93
- Active Server Pages 45
  - Administrative Server 45
  - enable 43
  - server-side scripting
    - language 145, 177
- Adding
  - email alias 105
  - hard disk drive 164
  - mailing list 109
  - PCI card 161
  - site user 99
  - virtual site 47
- Add-on storage 82
- Address (A) record 189
- Administration of RaQ 4
  - distributed control 34
  - full control 34
  - hybrid control 34
- Administration server for SSL 123
- Advanced DNS 184
  - configuring server settings 186
  - delegating a subdomain 185
  - delegating a subnet 186
  - domain administrator email
    - address 188
  - expire interval 188
  - name server 188

- Network Mask Notation
  - Conversion 184
- refresh interval 188
- retry interval 188
- Start of Authority (SOA)
  - configuration 187
  - time-to-live period 188

## Alias

- email 103
- hosts/domains 55
- Alias (CNAME) record 182
- Anonymous FTP 42
- APOP. See Authentication POP.
- Arkeia file backup 61
- Arrow buttons 4, 23
- ASP Administrative Server 62
- ASP. See Active Server Pages.
- Authentication POP 43

## B

### Backup

- RaQ 4 71
    - backup file locations 76
    - manual 72
    - scheduled 74
  - site user 141
  - virtual site 128
    - backup file location 132
    - manual 128
    - scheduled 130
- Bandwidth management, virtual site 65

- Basic DNS 179
  - configuring
    - primary DNS server 180
    - secondary DNS server 182
  - description 179
  - enabling DNS server 180
  - record
    - address (A) 189
    - alias (CNAME) 182
    - mail server (MX) 181
    - reverse lookup (PTR) 181
- Battery iii
- Block email. See Reject email from users/hosts/domains.
- Browser
  - requirements v
  - setting up the RaQ 4 24
  - Setup Wizard 25
- BSD Copyright 197
- C**
- Catch-all email account for the RaQ 4 107
- Certificate, SSL
  - delete certificate 126
  - enter info from external certification authority 124
  - externally signed certificate 119
  - main site certificate 123
  - self-signed certificate 120
  - submit to external certification authority 123
- CGI
  - scripts 43, 145
  - usage 115, 176
- Changing network configuration 150
- Chili!Soft ASP. See Active Server Pages.
- Configuring
  - DNS server settings 186
  - RaQ 4 for the network 22
  - RaQ 4 with LCD console 23
  - UPS 151
- Connecting
  - power cord 21
  - RaQ 4 to the network 21
- Connector
  - network 5, 21
  - SCSI 5
  - serial 5
  - serial console port 171
- Console port, serial 171
  - initializing the RaQ 4 171
- Control panel 52
  - network 64
  - services 52
    - Arkeia file backup 61
    - ASP Administrative Server 62
    - DNS 63
    - email server 53
    - FTP server 58
    - Legato file backup 60
    - SNMP agent 59
    - telnet server 58
    - Web server 53
  - time 69
- Cooling fan 5
- CPU status 91
- Customer service 13
  - general information 13
- D**
- Default settings
  - site user 97
  - virtual site 46
- Delegating a subdomain 185
- Delegating a subnet 186
- Developer Network 14
- Developing Web pages 145
  - CGI scripts 145
  - server-side scripting languages 145
- Development tools 173

- Directory structure 175
    - CGI usage 176
    - RaQ 4 home page 175
    - server-side scripting
      - languages 177
    - site user home page 176
    - virtual site home page 175
  - Discussion Groups 15
  - Disk status 91
  - DNS
    - configuring
      - primary DNS server 180
      - secondary DNS server 182
      - server settings 186
    - delegating
      - subdomain 185
      - subnet 186
    - description 179
    - domain administrator email
      - address 188
    - enabling DNS server 180
    - expire interval 188
    - history of DNS 194
    - how does DNS work 195
    - name server 188
    - Network Mask Notation
      - Conversion 184
    - record
      - address (A) 189
      - alias (CNAME) 182
      - mail server (MX) 181
      - reverse lookup (PTR) 181
    - refresh interval 188
    - retry interval 188
    - sample setup of DNS records 189
    - service status 92
    - Start of Authority (SOA)
      - configuration 187
    - time-to-live period 188
  - DNS server 63
    - configuring
      - primary server 180
      - secondary server 182
      - settings 186
    - delegating
      - subdomain 185
      - subnet 186
    - domain administrator email
      - address 188
    - enabling 180
    - expire interval 188
    - name server 188
    - Network Mask Notation
      - Conversion 184
    - refresh interval 188
    - retry interval 188
    - sample setup of DNS records 189
    - Start of Authority (SOA)
      - configuration 187
    - time-to-live period 188
  - Domain administrator email
    - address 188
  - Domain name 26, 41
  - Domain Name System. See DNS.
- ## E
- Education 15
  - Electric shock iv
  - Email
    - alias 103
      - adding 105
    - catch-all account 107
    - domain administrator email
      - address 188
    - email forwarding 102
    - email server
      - alias 42
      - control panel 53
      - SMTP 53
    - forwarding email 102, 139
    - options, site user 138
    - parameters
      - hosts/domains aliases 55
      - maximum message size 55
      - reject email from users/hosts/
        - domains 55
      - relay for hosts/domains 55
      - smart relay host name 55

- relaying 56
  - enable 57
  - hosts/domains 55
- service status 92
- settings 102
- using 144
- vacation reply 102, 139

- Email server alias 42
- Embedded scripting, PHP 43, 45
- Equipment rack iv
- Expire interval 188

## F

- Forwarding email 102, 139
- Front view 4
  - LCD arrow buttons 4
  - LCD screen 4
  - logo badge 4
  - reset password 4
  - status indicators 4
- FrontPage
  - publishing Web pages 147
  - server extensions 42, 44
  - virtual site 42, 44
  - webmaster account 42, 44

## FTP

- anonymous FTP 42
- control panel 58
- publishing Web pages 146
- service status 92
- settings 116

## G

- Glossary 205
- GNU General Public License 198

## H

- Hard disk drive
  - adding 164
  - directory structure 175

- Hardware, RaQ 4 157
  - adding a hard disk drive 164
  - adding PCI card 161
  - printed circuit board 163
  - upgrading memory 161

## History of DNS 194

## Home page location

- RaQ 4 175
- site user 176
- virtual site 175

## Host name 26, 41

## How does DNS work 195

## I

- Icons 11
- Initializing the RaQ 4 through the serial console port 171
- Install software on RaQ 4 80
  - from CD-ROM 81
  - from Cobalt Web site 81
  - remotely 81
- Installing the RaQ 4 19
  - configuring for network 22
  - connecting power cord 21
  - connecting to network 21
  - mounting ears 20
  - powering on 21
  - rubber feet 20
- InterBase relational database 82
- IP address 41

## K

- Knowledge Base 15

## L

- LCD arrow buttons 4, 23
- LCD console 149
  - arrow buttons 23
  - changing network
    - configuration 150
  - configuring a UPS 151
  - configuring for network 23



- LCD screen 4
    - powering down the RaQ 4 155
    - rebooting the RaQ 4 154
  - LCD screen 4
  - Legato file backup 60
  - Levels of user
    - RaQ 4 administrator 7
    - site administrator 7
    - site user 7
  - Licenses
    - BSD copyright 197
    - GNU General Public License 198
    - SSL License 204
  - Limit to virtual sites 37
  - List management. See Mailing lists.
  - Lithium battery iii
  - Logo badge 4
- ## M
- Mail forwarding 102
  - Mail server (MX) record 181
  - Mailing lists 108
    - adding 109
    - modifying 111
    - removing 112
  - Maintenance 71
    - add-on storage 82
    - backup 71
      - RaQ 4, file locations 76
      - RaQ 4, manual 72
      - RaQ 4, scheduled 74
      - virtual site, file location 132
      - virtual site, manual 128
      - virtual site, scheduled 130
    - install software 80
      - from CD-ROM 81
      - from Cobalt Web site 81
      - remotely 81
    - rebooting 85
    - restore
      - RaQ 4 server 77
      - site user 143
      - virtual site 133
    - shutdown 86
      - support tools 86
      - suspend site user 116
      - suspend virtual site, hard 85
      - suspend virtual site, soft 115
  - Maximum allowed disk space, virtual site 42
  - Maximum message size, email 55
  - Maximum number of users, virtual site 42
  - Memory
    - status 91
    - upgrading 161
  - Mounting ears 20
- ## N
- Name server 188
  - Network
    - configuration 64
    - connecting RaQ 4 21
    - connectors 5
    - status indicators 5
  - Network Mask Notation
    - Conversion 184
  - Network settings 26
    - control panel 64
    - domain name 26
    - host name 26
    - primary DNS server address 26
    - secondary DNS server address 26
  - Network status 91
  - Numerics
    - 10/100BaseTX 6
    - 100BaseTX 6
    - 10BaseT 6
- ## O
- OK to power off 5
  - Online registration of the RaQ 4 29
  - Online Technical Papers 15
  - Organization of user manual 8
  - Output bandwidth management. See Bandwidth management.
  - Overview of virtual sites 41

## P

- Part number, user manual ii
- Partner solutions 159
- Password
  - RaQ 4 administrator
    - changing password 51
    - resetting password 51
  - resetting, RaQ 4 4
- PCI
  - adding card 161
  - expansion slot 5
- Personal profile 137
- PHP
  - embedded scripting 45
    - enable 43
  - server-side scripting
    - language 145, 177
- Physical data, RaQ 4 159
- Power cord iv, 21
- Power socket 5
- Power switch 5
- Powering down the RaQ 4 155
- Powering on the RaQ 4 21
- Primary DNS server
  - configuration 180
- Primary DNS server address 26
- Printed circuit board 163
- Product specifications 157
  - hardware 157
  - physical data 159
  - printed circuit board 163
  - regulatory approvals 160
  - software
    - features 158
    - partner solutions 159
    - system management 159
- Publishing Web pages
  - FrontPage 147
  - FTP 146

## R

- RAID-1 support 36
- RaQ 4
  - Active Monitor 93
    - status colors 93
  - administration
    - distributed control 34
    - full control 34
    - hybrid control 34
  - administrator
    - changing password 51
    - resetting password 51
  - control panel 52
    - network 64
    - services 52
    - time 69
  - development tools 173
  - domain name 41
  - front view 4
  - host name 41
  - initializing through the serial
    - console port 171
  - IP address 41
  - maintenance 71
  - powering down 155
  - product specifications 157
    - hardware 157
    - physical data 159
    - printed circuit board 163
    - regulatory approvals 160
    - software features 158
    - software, partner solutions 159
    - software, system management 159
  - RAID-1 support 36
  - rear view 5
  - rebooting 85, 154
  - requirements 6
  - server management 33

- setting up 19
    - configuring for network 22
    - connecting power cord 21
    - connecting to network 21
    - installation 19
    - making the connection 19
    - mounting ears 20
    - powering on 21
    - rubber feet 20
  - setting up with browser 24
    - network settings 26
    - registration, mail-in card 32
    - registration, online 29
    - service settings 28
    - Setup Wizard 25
    - time settings 29
  - site management 37, 95
  - site usage 88
  - site user 97
  - support tools 86
  - system status 89
    - services 92
    - system components 91
  - target audience 6
  - virtual site, definition 35
  - Rear view 5
    - cooling fan 5
    - network connector 5
    - network status indicators 5
    - OK to power off 5
    - PCI expansion slot 5
    - power socket 5
    - power switch 5
    - SCSI connector 5
    - security lock hole 5
    - serial connector 5
    - serial console port 5, 171
  - Rebooting the RaQ 4 85, 154
  - Record, DNS
    - address (A) 189
    - alias (CNAME) 182
    - mail server (MX) 181
    - reverse lookup (PTR) 181
  - Refresh interval 188
  - Registration of RaQ 4
    - mail-in card 32
    - online 29
  - Regulations, Class B v
  - Regulatory approvals 160
  - Reject email from users/hosts/
    - domains 55
  - Relay email 56
    - enable 57
    - hosts/domains 55
  - Removing
    - mailing list 112
    - site user 102
    - SSL certificate 126
    - virtual site 49
  - Reports, usage
    - RaQ 4 server 88
    - virtual site 126
  - Requirements
    - browsers v, 6
    - equipment rack iv
    - for the RaQ 4 6
  - Resources
    - Developer Network 14
    - Discussion Groups 15
    - Education 15
    - Knowledge Base 15
    - Online Technical Papers 15
    - Solutions 14
  - Restore
    - RaQ 4 server 77
    - site user 143
    - virtual site 133
  - Retry interval 188
  - Reverse lookup (PTR) record 181
  - Rubber feet 20
- ## S
- Safety
    - battery, lithium iii
    - electric shock iv
    - equipment rack iv
    - ventilation iii
  - Sample setup of DNS records 189

## Index

- SCSI connector 5
- Search
  - site user 100
  - virtual site 39
- Secondary DNS server
  - configuration 182
- Secondary DNS server address 26
- Secure POP3
  - virtual site 43
- Secure sockets layer. See SSL.
- Security lock hole 5
- Serial connector 5
- Serial console port 5, 171
  - initializing the RaQ 4 171
- Server management 33
- Server side includes 43
- Server-side scripting language
  - Active Server Pages 177
  - PHP 177
- Services
  - Arkeia file backup 61
  - ASP Administrative Server 62
  - DNS server 63
  - email server 53
  - FTP server 58
  - Legato file backup 60
  - SNMP agent 59
  - telnet server 58
  - Web server 53
- Setting up the RaQ 4 19
- Setup Wizard 25
  - network settings 26
  - registration, online 29
  - service settings 28
  - time settings 29
- Shell accounts, virtual site 43
- Shutdown. See Powering down the RaQ 4.
- Site management 37, 95
  - changing site settings 113
  - changing site user email options 105
  - changing site user settings 104
  - FTP settings 116
  - mailing list 108
    - adding 109
    - modifying 111
    - removing 112
  - search feature 39
  - site settings 112
  - site usage 126
    - reports generated 126
  - sort feature 39
- SSL
  - administration server 123
  - delete certificate 126
  - description 118
  - enable on virtual site 119
  - enter info from external certification authority 124
  - externally signed certificate 119
  - generate self-signed certificate 120
  - license 204
  - main site certificate 123
  - settings 118
  - submit to external certification authority 123
  - suspend site user 116
  - suspend virtual site, soft 115
  - user management 97
- Site services 137
  - email options 138
  - modifying site user 138
  - telnet 148
- Site usage 88, 126
  - reports generated 88, 126
- Site user
  - adding 99
  - backup 141
  - changing email options 105
  - changing user settings 104
  - default settings 97

- directory structure
    - home page 176
  - email options 138
  - modifying 138
  - personal profile 137
  - removing 102
  - restore 143
  - search feature 100
  - services on a site 137
  - sort feature 100
  - telnet service 148
  - usage data 140
  - Smart relay host name, email 55
  - SMTP server 53
  - SNMP
    - agent 59
    - service status 92
  - Software
    - features 158
    - install software 80
    - partner solutions 159
    - system management 159
  - Solutions 14, 159
  - Sort
    - site user 100
    - virtual site 39
  - SSL
    - administration server 123
    - delete certificate 126
    - description 118
    - enable on virtual site 119
    - enter info from external
      - certification authority 124
    - externally signed certificate 119
    - generate self-signed
      - certificate 120
    - license 204
    - main site certificate 123
    - settings 118
    - submit to external certification
      - authority 123
    - virtual site 43
  - SSL License 204
  - Start of Authority (SOA)
    - configuration 187
  - Status indicator
    - 100 M 4
    - Col 4
    - Disk 4
    - Link 4
    - Transmit/Receive 4
    - Web 4
  - Storage, add-on 82
  - Support calls 16
    - to speed up your call 16
  - Support tools 17, 86
  - Suspend site user 116
  - Suspend virtual site
    - hard 85
    - soft 115
  - System status 89
    - services 92
      - DNS 92
      - email 92
      - FTP 92
      - SNMP 92
      - telnet 92
      - Web server 92
    - system components 91
      - CPU 91
      - disk 91
      - memory 91
      - network 91
- ## T
- Target audience, RaQ 4 6
  - Technical data. See Product specifications.
  - Technical Support 13
    - contact information 13
    - Developer Network 14
    - Discussion Groups 15
    - Education 15
    - Knowledge Base 15

- Online Technical Papers 15
- Solutions 14
- support calls 16
- support tools feature 17
- Telnet
  - service status 92
  - site services 148
  - telnet server
    - control panel 58
- Time settings 29
  - control panel 69
- Time-to-live period 188
- U
- Upgrading memory module 161
- Usage data for site user 140
- User management 97
- Users
  - RaQ 4 administrator 7
  - site administrator 7
  - site user 7
- V
- Vacation reply 102, 139
- Ventilation iii
- Virtual site
  - adding 47
  - adding site user 99
  - anonymous FTP 42
  - authentication POP (APOP) 43
  - backup 128
    - file location 132
    - manual 128
    - scheduled 130
  - bandwidth management 65
  - changing site settings 113
  - default settings 46
  - definition 35
  - directory structure
    - home page 175
  - domain name 41
  - email server alias 42

- enable
  - Active Server Pages 43
  - CGI scripts 43
  - FrontPage server
    - extensions 42
  - PHP embedded scripting 43
  - Secure POP3 (APOP) 43
  - server side includes 43
  - shell accounts 43
  - SSL 43, 119
- FTP settings 116
- host name 41
- IP address 41
- IP-based site 35
- limit on number 37
- maximum allowed disk space 42
- maximum number of users 42
- name-based site 35
- overview 41
- removing 49
- removing site user 102
- restore 133
- search feature 39
- site settings 112
- site usage 126
  - reports 126
- site user
  - default settings 97
- sort feature 39
- SSL
  - administration server 123
  - delete certificate 126
  - description 118
  - enable on virtual site 119
  - enter info from external
    - certification
      - authority 124
  - externally signed
    - certificate 119
  - generate self-signed
    - certificate 120
  - license 204
  - main site certificate 123

- settings 118
- submit to external certification authority 123
- suspend site user 116
- suspend site, hard 85
- suspend site, soft 115
- user management 97
- Web server alias 41

## W

### Web

- developing pages 145
  - CGI scripts 145
  - server-side scripting languages 145
- publishing pages
  - FrontPage 147
  - FTP 146

### Web browser

- requirements v, 6
- setting up the RaQ 4 24
- Setup Wizard 25

### Web server

- control panel 53
- status 92

### Web server alias 41

- Webmaster account for FrontPage 42, 44

