

Oracle® Tuxedo

Product Overview

11g Release 1 (11.1.1.2.0)

August 2010

ORACLE®

Copyright © 1996, 2010, Oracle and/or its affiliates. All rights reserved.

This software and related documentation are provided under a license agreement containing restrictions on use and disclosure and are protected by intellectual property laws. Except as expressly permitted in your license agreement or allowed by law, you may not use, copy, reproduce, translate, broadcast, modify, license, transmit, distribute, exhibit, perform, publish, or display any part, in any form, or by any means. Reverse engineering, disassembly, or decompilation of this software, unless required by law for interoperability, is prohibited.

The information contained herein is subject to change without notice and is not warranted to be error-free. If you find any errors, please report them to us in writing.

If this software or related documentation is delivered to the U.S. Government or anyone licensing it on behalf of the U.S. Government, the following notice is applicable:

U.S. GOVERNMENT RIGHTS Programs, software, databases, and related documentation and technical data delivered to U.S. Government customers are "commercial computer software" or "commercial technical data" pursuant to the applicable Federal Acquisition Regulation and agency-specific supplemental regulations. As such, the use, duplication, disclosure, modification, and adaptation shall be subject to the restrictions and license terms set forth in the applicable Government contract, and, to the extent applicable by the terms of the Government contract, the additional rights set forth in FAR 52.227-19, Commercial Computer Software License (December 2007). Oracle USA, Inc., 500 Oracle Parkway, Redwood City, CA 94065.

This software is developed for general use in a variety of information management applications. It is not developed or intended for use in any inherently dangerous applications, including applications which may create a risk of personal injury. If you use this software in dangerous applications, then you shall be responsible to take all appropriate fail-safe, backup, redundancy, and other measures to ensure the safe use of this software. Oracle Corporation and its affiliates disclaim any liability for any damages caused by use of this software in dangerous applications.

Oracle is a registered trademark of Oracle Corporation and/or its affiliates. Other names may be trademarks of their respective owners.

This software and documentation may provide access to or information on content, products and services from third parties. Oracle Corporation and its affiliates are not responsible for and expressly disclaim all warranties of any kind with respect to third-party content, products, and services. Oracle Corporation and its affiliates will not be responsible for any loss, costs, or damages incurred due to your access to or use of third-party content, products, or services.

Contents

1. Introducing Oracle Tuxedo

What is Oracle Tuxedo?	1-2
A Brief History of the Tuxedo System	1-4
Releases 1.0 Through 7.1	1-4
Release 8.0	1-5
Release 8.1	1-5
Release 9.0	1-6
Release 9.1	1-7
Release 10.0	1-8
Release 10g Release 3 (10.3)	1-9
Release 11g Release 1 (11.1.1.1.0)	1-10
Release 11g Release 1 (11.1.1.2.0)	1-11
Support for Industry Standards	1-11
Support for Popular Platforms	1-12
Support for Multiple Programming Models and Languages	1-13
Mission-Critical Software	1-13
Distributed Transaction Management	1-13
X/Open XA and TX Compliance	1-14
Transactions Documentation	1-14
Scalability and Performance	1-14
High Availability and Fault Management	1-15
Security	1-15

Management Tools	1-16
Oracle Tuxedo Administration Console	1-17
Command-Line Interface	1-18
MIB Interface	1-18
Client and Server Components.	1-19
Oracle Tuxedo Client Components.	1-21
Oracle Tuxedo Server Components	1-22
Invocation Capabilities.	1-22
Client-to-Server Invocation Capabilities.	1-23
Server-to-Server Invocation Capabilities	1-23
Domains	1-24
Oracle Tuxedo Product Family	1-25
About Oracle ART	1-26
Oracle Art Runtime	1-26
Oracle ART Workbench.	1-26
Oracle ART Documentation	1-26
About Oracle JCA.	1-27
Oracle JCA Documentation.	1-27
About Oracle Jolt	1-27
Oracle Jolt Documentation	1-27
About Oracle SALT	1-27
Oracle SALT Documentation.	1-28
About Oracle SNMP Agent	1-28
Oracle SNMP Agent Documentation.	1-28
About Oracle TSAM.	1-28
Oracle TSAM Documentation	1-29

2. Oracle Tuxedo ATMI Core Components

Important Oracle Tuxedo Terms and Concepts	2-1
Oracle Tuxedo ATMI Overview.	2-3
Oracle Tuxedo ATMI Architecture	2-4
Oracle Tuxedo Transaction Processor and Infrastructure.	2-5
System Management Interface	2-6
ATMI Programming Interface	2-7
Request/Response Communications	2-7
Conversational Communications	2-7
ATMI Interface Documentation	2-8
FML Programming Interface.	2-8
Typed Buffers	2-9
Oracle Tuxedo Workstation	2-9
Workstation Communication.	2-10
Workstation Documentation	2-11
Oracle Tuxedo /Q	2-11
Storing and Retrieving Messages	2-12
/Q Documentation	2-12
Oracle Tuxedo EventBroker	2-13
Mediating Between Producers and Consumers of Events.	2-13
EventBroker Documentation.	2-13
Oracle Tuxedo Domains.	2-14
Transparency Between Domains	2-15
Domains Documentation.	2-15

3. Oracle Tuxedo CORBA Components

Oracle Tuxedo CORBA Overview	3-2
Oracle Tuxedo CORBA TP Framework.	3-3

Oracle Tuxedo CORBA Architecture	3-3
Oracle Tuxedo OTM and Infrastructure.	3-4
System Management Interface	3-4
Application Programming Interface	3-5
Application Programming Environment.	3-5
Oracle Tuxedo ORB Software	3-6
Oracle Tuxedo IIOP Listener/Handler.	3-7
IIOP Listener/Handler Communication	3-8
IIOP Listener/Handler Documentation	3-8
Oracle Tuxedo CORBA Environmental Objects	3-9
Oracle Tuxedo CORBA Object Services	3-9
Oracle Tuxedo TP Framework.	3-11

4. Oracle Tuxedo Product Support and Resources

About the Oracle Tuxedo Documentation	4-1
Oracle Tuxedo Online Documentation	4-1
Oracle Tuxedo Context-Sensitive Help.	4-2
Using the Oracle Tuxedo Online Documentation	4-2
Accessing the Documentation in a Browser	4-2
Site Map	4-3
PDF Document Files.	4-3
Using the Online Search Feature.	4-4
Learning Paths.	4-4

5. Oracle Tuxedo Web-Accessible Services

What Does Web Accessible Mean?	5-1
Exposing Tuxedo Services as Web Services	5-3
Web Services Standards at a Glance	5-3

Exposing Tuxedo Services as Web Services Through Oracle SALT	5-4
SALT Gateway Server — GWWS	5-5
SALT Documentation	5-5
Exposing Tuxedo Services as Web Services Through Other Oracle Products	5-6
Through Oracle WebLogic Server	5-6
Through Oracle AquaLogic Service Bus	5-6
Ceasing Tuxedo Services Using a Web Application Server	5-7
Making Tuxedo Services Web Accessible Through Oracle Jolt	5-7
Jolt Class Library	5-8
Jolt Client Personalities	5-8
Jolt Servers	5-9
Jolt Documentation	5-9
Making Tuxedo Services Web Accessible Through Oracle WebLogic Server . . .	5-10

Introducing Oracle Tuxedo

The following sections describe the architecture and major features of the Oracle Tuxedo product:

- [What is Oracle Tuxedo?](#)
- [A Brief History of the Tuxedo System](#)
- [Support for Industry Standards](#)
- [Support for Popular Platforms](#)
- [Support for Multiple Programming Models and Languages](#)
- [Mission-Critical Software](#)
- [Distributed Transaction Management](#)
- [Scalability and Performance](#)
- [High Availability and Fault Management](#)
- [Security](#)
- [Management Tools](#)
- [Client and Server Components](#)
- [Invocation Capabilities](#)
- [Domains](#)
- [Oracle Tuxedo Product Family](#)

What is Oracle Tuxedo?

Oracle Tuxedo provides the framework, or middleware, for building scalable multi-tier client/server applications in heterogeneous (dissimilar), distributed environments that extend from the Web to the Enterprise. Using Oracle Tuxedo, users can develop, manage, and deploy distributed applications independently of the underlying hardware, operating system, network, and database environment.

As indicated in the following figure, middleware consists of software services that exist *between* a client or server application *and* the operating system and network services on a system node in the network.

Figure 1-1 Use of Middleware

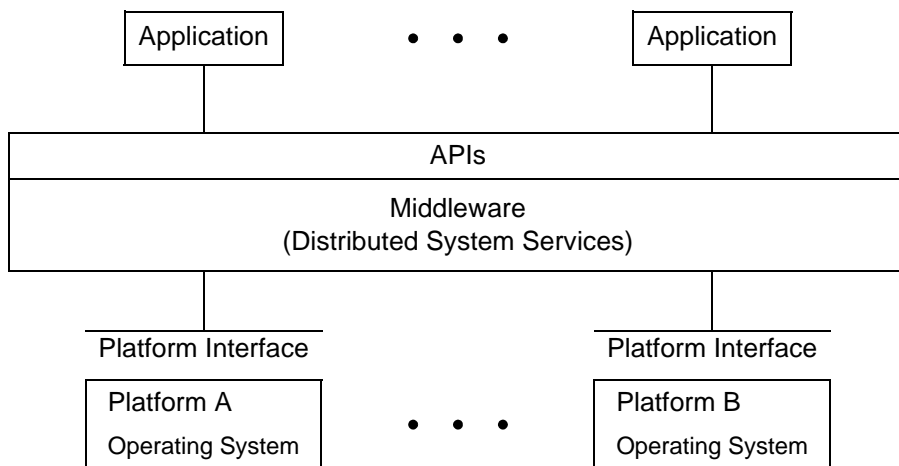

Middleware services provide a more functional set of application programming interfaces (API) than the operating system and network services. A main purpose of middleware services is to help solve application connectivity and interoperability problems.

Oracle Tuxedo offers the following middleware services:

- An ATMI programming interface

ATMI, for Application-to-Transaction Monitor Interface, is the main API for the Tuxedo system. It includes transaction management functions (routines, verbs); request/response, conversational, queuing, and publish-and-subscribe message-handling functions; service

interface functions; and buffer management functions for distributed application communication.

- A CORBA programming interface

CORBA, for Common Object Request Broker Architecture, is a language-independent, distributed-object model specified by the Object Management Group (OMG). The CORBA programming interface consists of C++ and Java ORBs. An ORB, or Object Request Broker, is a library that enables CORBA objects to locate and communicate with one another.

Note: The Oracle Tuxedo CORBA Java client and Oracle Tuxedo CORBA Java client ORB were deprecated in Tuxedo 8.1 and are no longer supported. All Oracle Tuxedo CORBA Java client and Oracle Tuxedo CORBA Java client ORB text references, associated code samples, should only be used to help implement/run third party Java ORB libraries, and for programmer reference only.

Technical support for third party CORBA Java ORBs should be provided by their respective vendors. Oracle Tuxedo does not provide any technical support or documentation for third party CORBA Java ORBs.

- A high-performance transaction processing application server

The transaction processing application server oversees all aspects of a distributed ATMI transaction, regardless of the systems or resource managers used. It provides the run-time engines for running ATMI transactions on top of ordinary computer hardware and operating systems.

- A high-performance object application server

The object application server, based on the CORBA Object Transaction Service (OTS), combines the Tuxedo ATMI transaction processing technology with the Oracle CORBA C++ ORB to provide high performance for distributed-object applications using transactions.

Oracle Tuxedo includes the ATMI services and CORBA C++ objects needed for transaction management, security, message transport, administration and manageability, and XA-compliant database support for two-phase commit processing. It also includes a high-speed, highly reliable server-side message switch especially tuned for handling distributed transactions across many server machines.

A Brief History of the Tuxedo System

Oracle Tuxedo is a proven, mature system spanning over 20 years of continuous development and enhancement:

- In 1983, the Tuxedo system began as an applied, forward-looking work project within the Bell Laboratories division of AT&T. The target applications for the Tuxedo system were UNIX-based operations support systems within AT&T.
- In 1989, the Tuxedo system was transferred to the UNIX System Laboratories (USL) division of AT&T, and its client/server framework was offered as a commercial product.
- In 1993, the Tuxedo system was transferred to Novell, Inc., when Novell acquired USL in 1993.
- In 1996, BEA Systems, Inc., entered into an exclusive agreement with Novell to distribute and continue development of the Tuxedo system on a variety of computer platforms, including Windows and most UNIX systems.
- In 2008, Tuxedo became Oracle product along with all other BEA Systems products.

Releases 1.0 Through 7.1

From release 1.0 in 1983 through release 7.1 in 2000, the Tuxedo system was extended and enhanced in a number of significant ways, always with the intent of making communication between client and server processes easier and more flexible. The Tuxedo system evolved into the de facto standard for open (open standard) online transaction processing (OLTP) solutions.

Release 4.0 introduced the *ATMI API* and *transaction processing*. Release 5.0 introduced the *Domains component*, which provided for the federation of Tuxedo applications and inter-application transaction processing. Release 7.1 introduced a *security plug-in architecture*, which allowed for the installation of third-party security systems.

Release 7.1 also introduced *multithreading and multicontexting*—ATMI functions that enabled programmers to write multithreaded and/or multicontexted application clients and servers—and *XML buffer support*—the ability to use extensible markup language (XML) typed buffers to exchange XML data within and between ATMI applications. In release 7.1, the Oracle Jolt product was bundled with Oracle Tuxedo for the first time.

For an overview of Oracle Tuxedo ATMI, see [Chapter 2, “Oracle Tuxedo ATMI Core Components.”](#)

Release 8.0

Release 8.0 introduced the Oracle *CORBA API* and *CORBA Object Transaction Monitor (OTM)* capability. The CORBA OTM combined the advantages of a CORBA-compliant programming model with the proven power and reliability of the Oracle Tuxedo core technology infrastructure.

For an overview of Oracle Tuxedo CORBA, see [Chapter 3, “Oracle Tuxedo CORBA Components.”](#)

Release 8.1

Release 8.1 introduced the following features and enhancements:

- Localization enhancements
 - Enables customers to install and interface with the Tuxedo system in English or Japanese.
- Multibyte character encoding
 - Provides a new ATMI application typed buffer to handle multibyte character encoding.
- XML parser integration
 - Incorporates the Apache Xerces C++ Version 1.7 parser into Tuxedo for use by customer applications to read and write XML data.
- Single point security administration
 - Enables customers to use the Oracle WebLogic Server Administration Console to administer security for both Oracle Tuxedo and Oracle WebLogic Server.
- Domain gateway performance improvement
 - Improves the performance of the Tuxedo domain gateway process without any changes in the user interface.
- Remote domain connection policy
 - Changes the behavior of the `ON_STARTUP` type connection policy of the Tuxedo domain gateway process to allow customers to selectively establish connections on a per remote domain basis.
- Domains keepalive
 - Keeps interdomain connections open through firewalls during extended periods of no application activity and enables the Tuxedo domain gateway process to quickly detect interdomain connection failures.

- Multithreaded bridge

Allows users to configure the Tuxedo Bridge process for multithreaded execution (as opposed to single-threaded execution) to improve Bridge performance.

- Parameter length expansion

Increases the maximum allowable length of certain Tuxedo configuration parameters from 64 or 78 characters to 256 characters.

- Global maximum transaction timeout

Adds a global maximum transaction timeout parameter to cap ATMI transaction timeout values that are excessively long.

- Enhanced CORBA C++ client ORB

Enables CORBA C++ clients to participate in global transactions with WebLogic Server application servers in the same way that WebLogic Server T3 clients do.

In addition, both the Oracle Jolt product and the Oracle SNMP Agent product are bundled with Oracle Tuxedo 8.1. For details about the new features and enhancements offered by Oracle Tuxedo 8.1, see the *Oracle Tuxedo Release Notes*.

Release 9.0

Release 9.0 introduced the following features and enhancements:

- Enhanced Web Services

Provides XML schema and transformation (XML to and from FML) support. Also provides a Tuxedo service metadata repository that provides access to Tuxedo service definitions. It is designed to process interactive queries by developers and administrators during application development or modification, and is not designed for the processing of high volumes of automated queries during the application production phase.

- Domain Gateway performance improvements

- Infrastructure improvements in the following areas:

- Timeout controls
- Domain connection policies
- CORBA IIOP client failover.

- Security

- Cert-C PKI Plug-in security for data protection and non-repudiation
- Kerberos authentication support
- Tuxedo .NET Workstation Client support

The Tuxedo .NET workstation client provides customers with access to the Tuxedo system using the .NET Framework environment. It is implemented as a set of APIs and development utilities for developers.

In addition, both the Oracle Jolt product and the Oracle SNMP Agent product are bundled with Oracle Tuxedo 9.0. For details about the new features and enhancements offered by Oracle Tuxedo 9.0, see the *Oracle Tuxedo Release Notes* and the What's New link on the Oracle Tuxedo Documentation page.

Release 9.1

Release 9.1 introduced the following features and enhancements:

- Oracle RAC Support
 - Supports clustering of machines that utilize replicated Oracle database services accessing the same Oracle database. For more information, see [Using Tuxedo with Oracle Real Application Clusters \(RAC\)](#) in *Setting Up an Oracle Tuxedo Application*.
- Tuxedo .NET Workstation Client
 - A facilitating tool that helps to efficiently develop Tuxedo .NET Workstation Client applications leveraging the benefit of Microsoft's .NET Framework. For more information, see [Creating Tuxedo .NET Workstation Client Applications](#) in *Using the Tuxedo .NET Workstation Client*.
- Remote Desktop Enhancement
 - Allows Tuxedo to start up, be accessed and shut down using MS Windows Remote Desktop.
- Performance Enhancements
 - TDomain transaction performance enhancement
 - Memory usage enhancement
 - CORBA/Java interoperability hardening
- Customer Enhancements

- TPESYSTEM enhancement
- TPEXIT enhancement
- Increased RDOMS enhancement

Release 10.0

Release 10.0 introduced the following new features and enhancements:

- Oracle Tuxedo System and Application Monitor (TSAM) Agent

Oracle TSAM provides comprehensive monitoring and reporting for Oracle Tuxedo system and applications. It includes two components: [Oracle TSAM Agent](#) and [Oracle TSAM Manager](#).

The Oracle TSAM Agent enables collection of various performance metrics for applications, including XA and non-XA transactions, services, system servers. The Oracle TSAM Agent provides an open plug-in framework which can be used to customize performance metrics collection and send this information to management tools other than the Oracle TSAM Manager.

The Oracle TSAM Agent can be used in conjunction with the Oracle TSAM Manager. The Oracle TSAM Manager provides a graphical user interface to correlate and aggregate performance metrics collected from one or more Tuxedo domains. It displays the information in *real time*.

- SSL Support for ATMI applications

This feature provides support for SSL encryption over all network links in Tuxedo where LLE encryption is available. For more information, see [Introducing ATMI Security](#), in “*Using Security in ATMI Applications*.”

- MQ Adapter

The MQ Adapter provides bi-directional, transactional connectivity to and from WebSphere MQSeries. For more information, see [Running the Tuxedo MQ Adapter](#).

- Generic AUTHSVR

Generic AUTHSVR is a new Tuxedo system server (GAUTHSVR) that enables Tuxedo users to be authenticated with LDAP based directory servers without need to write custom code. For more information, see [Implementing Single Point Security Administration](#), in “*Using Security in ATMI Applications*.”

- DoS

Provides Tuxedo TDomain domain gateway features used to defend against DoS attacks, and Tuxedo Domain improved password pair configuration flexibility. For more information, see [Introducing ATMI Security](#) in “*Using Security in ATMI Applications.*”

- Integrating ACUCOBOL in buildclient/buildserver.

In Tuxedo 10.0, buildclient/buildserver can accept COBOL source files and generate C stub code automatically using ACUCOBOL compiler version 6.2.0 or above.

- OpenLDAP for X.509 Certificate Lookup.

Tuxedo 10.0 PKI plug-in added support for OpenLDAP for X.509 certificate lookup. For more information, see Administering Security,Cert-C PKI Encryption Plug-In Configuration, [Configure Certificate Lookup](#) in “*Using Security in ATMI Applications.*”

Release 10g Release 3 (10.3)

Release 10gR3 introduced the following new features and enhancements:

- IPv6 Support

IPv6 is the next generation protocol designed by the IETF to replace the current version Internet Protocol, IP Version 4 (IPv4). The most obvious improvement in IPv6 over the IPv4 is that IP addresses are lengthened from 32 bits to 128 bits. It also adds many improvements to IPv4 in areas such as routing and network autoconfiguration.

For more information on using IPv6 with Oracle Tuxedo 10gR3, see [Enabling IPv6](#) in the *Oracle Tuxedo Programming Guide*.

- Application-Created Context in ATMI Server

Two new APIs, `tpappthrinit(3c)` and `tpappthrterm(3c)` are provided for application-created thread in ATMI server to create and terminate separate Tuxedo context. In context created using `tpappthrinit(3c)`, the application-created server thread can initiate service requests and define transactions.

For more information, see [Programming a Multithreaded and Multicontexted ATMI Application](#) in the *Oracle Tuxedo Administration Guide*.

- Oracle Tuxedo Access Log

Assists Tuxedo client administrators to monitor application validity at runtime. You can record application high water client count, current client count, and named users.

- Enhancements

- CLOPT length

Increased from 256 to 1024.

- FML field length

Increased from 30 to 254.

- `tlisten` password encryption

`tlisten.pw` file is system-encrypted. To change password, you must use `tlistpwd(1)`.

- Dynamic DMIB Update

Allows re-configuring the listening address of the remote domain gateway without shutting down the local domain.

- Domain Gateway Persistent Disconnect

Local domain with a `PERSISTENT_DISCONNECT` connection policy will neither connect to nor accept connect request from any remote domain.

Release 11g Release 1 (11.1.1.1.0)

Release 11gR1 introduced the following features and enhancements:

- Client/Server Affinity

The Oracle Tuxedo Client/Server Affinity feature provides the flexibility to set up a simple session-aware application model. It creates a "virtual" request routing scope using the Oracle Tuxedo ATMI RPC infrastructure. When a session is established, all subsequent calls are impacted by the routing scope until the session is terminated (explicitly or implicitly). With Client/Server Affinity, you can retain session context resources inside the client/server affinity scope.

- Extended ATMI Service Name Length

The maximum Oracle Tuxedo ATMI service name length is increased to 127 characters.

- Enhancements

- Domain retries connection establishment after incorrect password failure

When configured, `ON_STARTUP` domain gateway continuously re-tries to establish connection to remote domain when domain password pair validation fails.

- Flexibility to run Oracle Tuxedo as user other than administrator on Microsoft Windows

If configured in Microsoft Windows, processes booted in an Oracle Tuxedo domain are owned by the user who executed the `tmboot` command, instead of the user who starts the `TUXIPC` system service.

Release 11g Release 1 (11.1.1.2.0)

Release 11gR1 (11.1.1.2.0), the current Oracle Tuxedo product, introduces the following new features and enhancements:

- Oracle Tuxedo Group Multiple Resource Managers

Oracle Tuxedo now supports multiple Resource Managers (RMs) in one group, so every group application server has the ability to communicate with multiple RMs in one global transaction. For more information, see the [Oracle Tuxedo ATMI COBOL Function Reference](#), [Oracle Tuxedo ATMI C Function Reference](#), [Oracle Tuxedo File Formats, and Data Descriptions, MIBs, and System Processes Reference](#).

- Nested Views

Previous Oracle Tuxedo releases have supported views. In Release 11.1.1.2.0 view functionality has been extended to support nested views. For more information, see [Managing Typed Buffers in Programming an Oracle Tuxedo ATMI Application Using C](#).

Support for Industry Standards

The Oracle Tuxedo system complies with the Open Group's X/Open standards, including support of the XA standard for two-phase commit processing, the X/Open ATMI API, and the X/Open Portability Guide (XPG) standards for language internationalization. Oracle Tuxedo also supports the CORBA specification for distributed application development, as well as any relational database management system, object-oriented database management system, file manager, or queue manager.

The Oracle Tuxedo system and ATMI together implement the X/Open distributed transaction processing (DTP) model of online transaction processing (OLTP). The DTP model ensures that work being done throughout a client/server application is *atomically* completed, meaning that all involved databases are updated properly if the work is successful, or all involved databases are "rolled-back" to their original state if the work fails.

Other standards supported by the Oracle Tuxedo system include:

- Lightweight Directory Access Protocol (LDAP)—A set of protocols for accessing information directories. These directories can be physically distributed across multiple systems for access by many applications within an enterprise. LDAP is based on the

standards contained within the X.500 standard, but is significantly simpler. And unlike X.500, LDAP supports TCP/IP, which is necessary for any type of Internet access. LDAP is an ideal way to publish certificates because it is closely coupled with the X.509 standard for certificates.

- X.509 Digital Certificates—A digital statement that associates a particular public key with a name or other attributes. The statement is digitally signed by a certificate authority. By trusting that authority to sign only true statements, you can trust that the public key belongs to the person named in the certificate. Oracle Tuxedo public key security recognizes certificates that comply with X.509 version 3.0.
- Public-Key Cryptography Standard 7 (PKCS-7)—One of a set of Public-Key Cryptography Standards developed by RSA Laboratories in cooperation with an informal consortium, originally including Apple, Microsoft, DEC, Lotus, Sun and MIT. PKCS-7 defines a general syntax for messages that include cryptographic enhancements such as digital signatures and encryption. Oracle Tuxedo public key security complies with the PKCS-7 standard.
- Secure Sockets Layer (SSL)—The standard protocol for establishing secure communications over the Internet (TCP/IP).
- Internet Protocol Version 6 (IPv6)—The next generation protocol designed by the [IETF](#) to replace the current version Internet Protocol, IP Version 4 (IPv4)

Support for Popular Platforms

A client/server application separates the calling (client) software and the called (server) software into separate programs. The advantage of a client/server application is that multiple client processes can interface with a single server process, where the processes do *not* need to run on the same host machine. Thus, clients and servers can run on hardware and software platforms suited to their particular functions. For example, clients can run on inexpensive platforms such as workstations or personal computers, and database management servers can run on platforms specially designed and configured to perform queries.

The Oracle Tuxedo system has been ported to most popular *client* platforms, including Microsoft Windows Server and XP, and a variety of UNIX workstations. The Oracle Tuxedo system has been ported to most popular *server* platforms, including Microsoft Windows Server, HP-UX, IBM AIX, and Sun Solaris.

For a complete list of supported platforms for Oracle Tuxedo 11g Release 1 (11.1.1.1.2.0), see [Oracle Tuxedo 11g Release 1 \(11.1.1.1.2.0\) Platform Data Sheets](#) on page A-1 in *Installing the Oracle Tuxedo System*.

Support for Multiple Programming Models and Languages

Oracle Tuxedo supports two programming models and five languages. The supported programming models are ATMI and CORBA. The supported programming languages are:

- C and COBOL—supported for ATMI application clients and servers
- C++—supported for ATMI application clients and CORBA C++ application clients and servers
- Java—supported for CORBA Java application clients and Jolt application clients

Note: The Oracle Tuxedo CORBA Java client and Oracle Tuxedo CORBA Java client ORB were deprecated in Tuxedo 8.1 and are no longer supported. All Oracle Tuxedo CORBA Java client and Oracle Tuxedo CORBA Java client ORB text references, associated code samples, should only be used to help implement/run third party Java ORB libraries, and for programmer reference only.

Technical support for third party CORBA Java ORBs should be provided by their respective vendors. Oracle Tuxedo does not provide any technical support or documentation for third party CORBA Java ORBs.

Mission-Critical Software

ATMI and CORBA applications developed with Oracle Tuxedo are *mission-critical*, meaning that they are reliable, scalable, secure, and manageable. Applications can grow as the company grows, and they continue running when various parts of the network fail. Applications can expand and contract as the demand requires.

Distributed Transaction Management

Oracle Tuxedo specializes in managing transactions, on behalf of ATMI and CORBA applications, from their point of origin—typically on the client—across one or more server machines, and then back to the originating client. When a transaction ends, Tuxedo ensures that all the systems involved in the transaction are left in a consistent state. Tuxedo knows how to run transactions, route them across systems, load-balance their execution, and restart them after failures.

Oracle Tuxedo ensures the integrity of data accessed across several sites or managed by different database products. It tracks transaction participants and supervises a two-phase commit protocol, ensuring that transaction commit and rollback are properly handled at each site.

X/Open XA and TX Compliance

The Oracle Tuxedo system also coordinates the recovery of transactions in the event of site failure, network failure, or global resource deadlocks. The Oracle Tuxedo system uses the X/Open XA interface for communicating with the various resource managers. This interface, proposed by Tuxedo developers and accepted by X/Open, is the standard interface for distributed transaction control between the transaction manager and resource managers.

The Oracle Tuxedo system incorporates the X/Open TX interface for transaction demarcation, in addition to its own ATMI transaction management functions (routines, verbs). This interface allows an application writer to bracket a group of operations—define transaction boundaries—within an application such that all the operations will be done or none of them get done. That is, the transaction is either committed or rolled back as a single atomic unit of work, which keeps all involved databases synchronized, even if machine failures occur.

Transactions Documentation

For more information about transactions, see [Introducing Oracle Tuxedo ATMI](#) and [Using CORBA Transactions](#).

Scalability and Performance

In an enterprise environment, applications may need to support hundreds of execution contexts (where the context can be a thread or a process), tens of thousands of client applications, and millions of objects at satisfactory performance levels. Subjecting an application to exponentially increasing demands quickly reveals any resource shortcomings and performance bottlenecks in the application. Scalability is therefore an essential characteristic of Oracle Tuxedo applications.

Oracle Tuxedo enables distributed applications to scale in response to changing transaction loads by dynamically spawning and terminating servers (ATMI) or by dynamically activating and deactivating objects (CORBA) to meet the workload demands. Oracle Tuxedo balances the workload among all the available services or objects to ensure that they are all evenly used.

Applications built on Oracle Tuxedo can support a single client on a single server, or they can support tens of thousands of clients and thousands of servers without changing application code.

As an application scales, the Oracle Tuxedo system continues to provide end users with consistently high performance and good responsiveness.

For more information about scaling, see “Tuning an Oracle Tuxedo ATMI Application” in *Administering an Oracle Tuxedo Application at Run Time* and *Scaling, Distributing, and Tuning CORBA Applications*.

High Availability and Fault Management

In a distributed client/server environment, thousands of independent processors and processes must cooperate to run the application. Many malfunctions can happen. In spite of failures, Oracle Tuxedo keeps the application running in the following ways:

- Ensures no single point of failure by providing replicated server groups that can continue when something breaks.
- Restores the running application to good condition after failures occur.

Ensuring constant access to e-business applications is a key feature of Oracle Tuxedo. System components are constantly monitored for application, transaction, network, and hardware failures. When a failure occurs, Oracle Tuxedo logically removes that component from the system, manages any necessary recovery procedures, and re-routes messages and transactions to surviving systems—all transparently to the end user and without disruption in service.

Security

Oracle Tuxedo security includes authentication, authorization, and encryption to ensure data privacy when deploying Oracle Tuxedo applications across networks. Two levels of encryption are supported: (1) network-level encryption using Oracle Tuxedo’s proprietary Link-Level Encryption (LLE) or Secure Sockets Layer (SSL); and (2) application-level encryption using the SSL protocol and public key encryption.

In order to integrate Oracle Tuxedo security with other security systems, Oracle Tuxedo provides the following security plug-in interface. The plug-in interface allows Tuxedo customers to independently define and dynamically add their own security plug-ins.

Figure 1-2 Oracle Tuxedo Plug-in Security Architecture

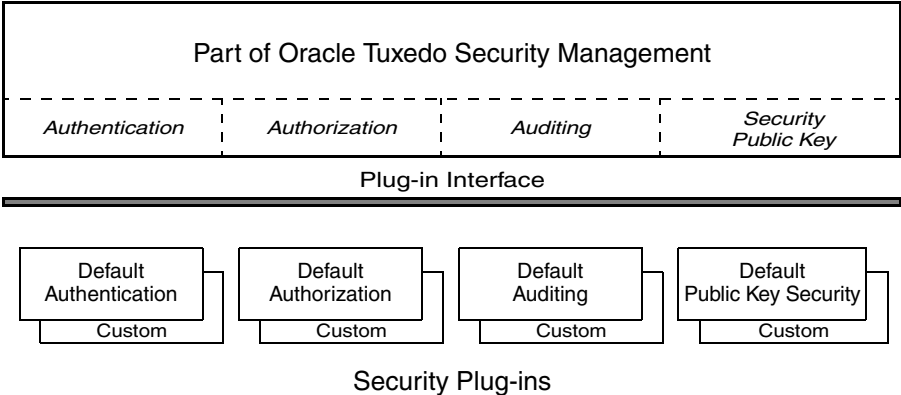

For more information on security in ATMI and CORBA applications, see [Using Security in ATMI Applications](#) and [Using Security in CORBA Applications](#).

For information about security when interoperating with earlier releases of Oracle Tuxedo software or Oracle WebLogic Enterprise, or when interoperating with Oracle WebLogic Server, see [Oracle Tuxedo Interoperability](#).

Management Tools

The Oracle Tuxedo system gives administrators a choice of several methods for performing the same set of administrative tasks for either Oracle Tuxedo ATMI or CORBA environments. The following figure illustrates the Oracle Tuxedo tools available to write an application’s configuration file and dynamically administer an Oracle Tuxedo application during run time.

Figure 1-3 Simplified View of Administration Tools

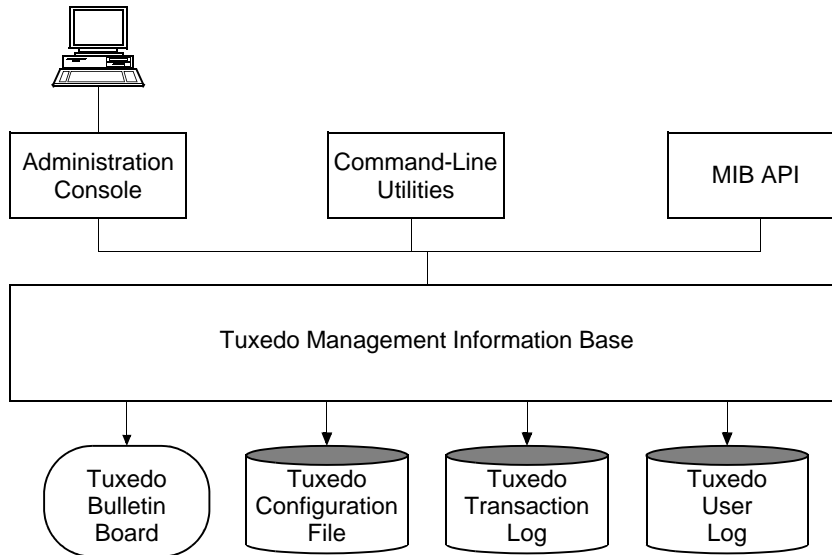

In addition to using these tools to administrator Oracle Tuxedo applications, administrators use these tools to perform fault-isolation and recovery tasks when application failures occur. Oracle Tuxedo automatically recovers from many types of failures. However, some failures—often the most serious ones—require operator intervention to determine what has actually failed.

Oracle Tuxedo Administration Console

The Oracle Tuxedo Administration Console is a graphical user interface that enables administrators to perform most administration and configuration tasks for Oracle Tuxedo applications. An administrator can display and change configuration information, determine the state of each component in the system, and obtain statistical information about items such as executed requests and queued requests.

The Oracle Tuxedo Administration Console is implemented as a set of Java applets, which can run on most platforms that support a Java-capable Web browser. The server-side components of the Oracle Tuxedo Administration Console reside on one of the server machines in an Oracle Tuxedo application. To use the Console, an administrator must enter the URL of the server and download the Java applets.

For the Oracle Tuxedo Administration Console startup procedure, see “[Starting the Oracle Tuxedo Administration Console](#)” in *Installing the Oracle Tuxedo System*. For information about how to use the Oracle Tuxedo Administration Console, either access Help directly from the console or see [Oracle Tuxedo Administration Console Online Help](#) . Also see “[Oracle Tuxedo Management Tools](#)” in *Introducing Oracle Tuxedo ATMI*.

Note: Limitation: The Oracle Tuxedo Administration Console has not been updated to support any new features introduced after Oracle Tuxedo release 7.1.

Command-Line Interface

Most of the functionality needed for dynamic modification of an Oracle Tuxedo application is provided by the `tmadmin` and `tmconfig` commands. Most of the functionality needed for dynamic modification of an Oracle Tuxedo Domains configuration is provided by the `dmadmin` command. Each of these commands is an interactive meta-command having many subcommands for performing various administrative tasks, including the modification of configuration entries while the system is running.

For details about these commands, see reference pages [tmadmin\(1\)](#), [tmconfig](#), [wtmconfig\(1\)](#), and [dmadmin\(1\)](#) in *Oracle Tuxedo Command Reference*. Also, see “[Oracle Tuxedo Management Tools](#)” in *Introducing Oracle Tuxedo ATMI*.

MIB Interface

The MIB interface is an application programming interface for directly accessing and manipulating system settings in the Oracle Tuxedo management information bases. The interface allows administrators to have total control over Tuxedo applications. The MIB interface is powerful because it is implemented with the same APIs that Tuxedo developers use to write business-critical client/server applications.

There are MIB interfaces to administer the access control list, disk-based queues, Domains, events, core Tuxedo, and the workstation extension. The following are the corresponding MIB component names: `ACL_MIB`, `APPQ_MIB`, `DM_MIB`, `EVENT_MIB`, `TM_MIB`, and `WS_MIB`. Through the MIB interface, administrators control the application by programmatically querying the Tuxedo bulletin board for the current state of MIB objects, and then effecting administrative changes by either setting and resetting specific MIB values or creating new MIB objects.

The level of control available through the MIB interface really comes in handy in failover and fallback situations. The MIB programming interface is the only way to handle all the possible complications that can occur in a failover situation. During a failover, scripts can be used to

execute client MIB programs that perform specific tasks such as shutting down and migrating server groups, and verifying the state of the application.

For details about the Oracle Tuxedo MIBs, see reference pages [ACL_MIB\(5\)](#), [APPQ_MIB\(5\)](#), [DM_MIB\(5\)](#), [EVENT_MIB\(5\)](#), [MIB\(5\)](#), [TM_MIB\(5\)](#), and [WS_MIB\(5\)](#) in *Oracle Tuxedo File Formats, Data Descriptions, MIBs, and System Processes Reference*; start with the [MIB\(5\)](#) reference page. Also, see “Oracle Tuxedo Management Tools” in *Introducing Oracle Tuxedo ATMI*.

Client and Server Components

The following figure identifies the Oracle Tuxedo client and server components and shows the connectivity between the clients and servers. Only remote Tuxedo clients are shown in the figure.

Figure 1-4 Oracle Tuxedo Client and Server Components

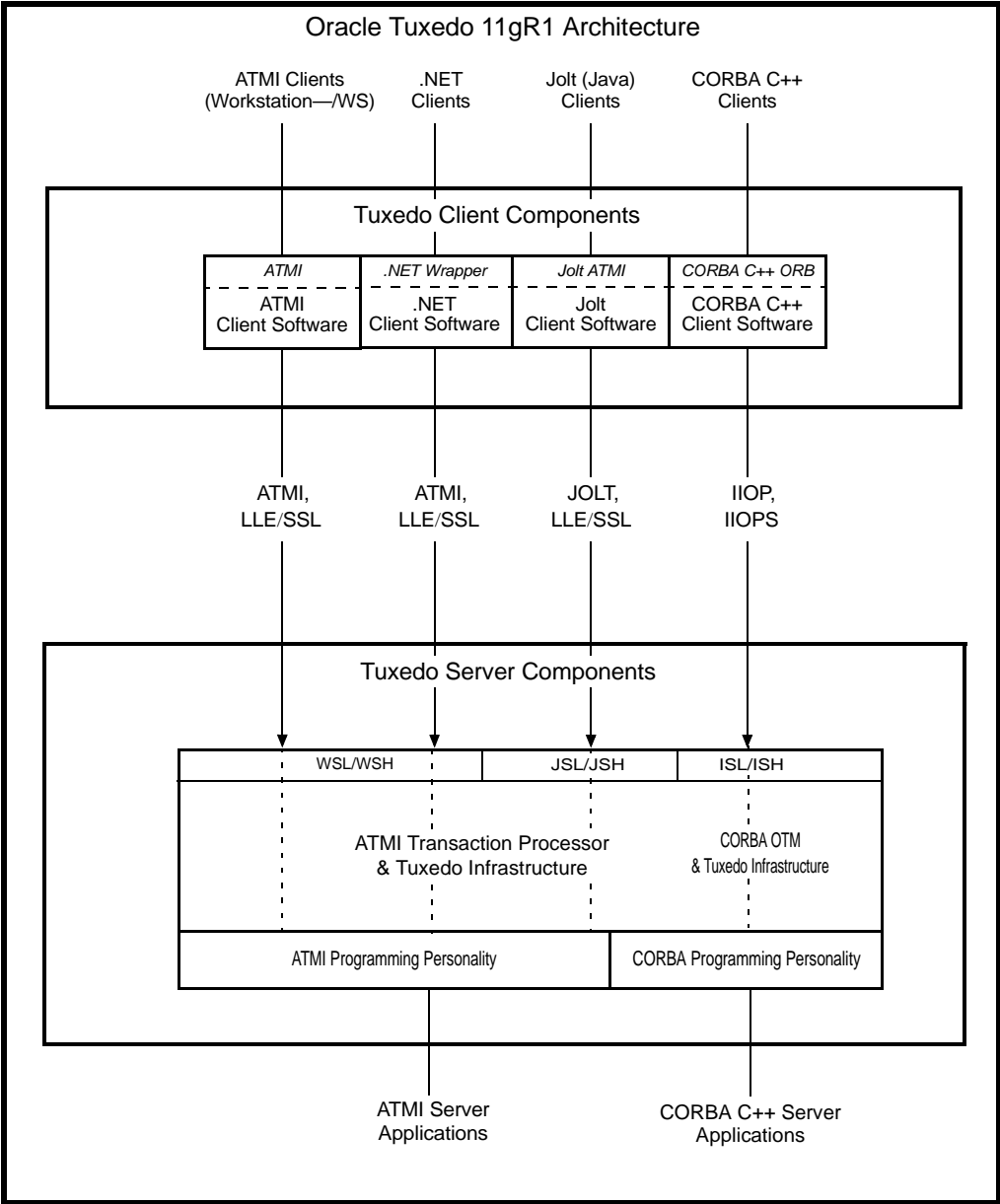

A *remote* Tuxedo client—ATMI (/WS), Jolt, or CORBA C++—interfaces with a Tuxedo server via a network connection and a pair of Tuxedo gateway processes: Workstation Listener/Handler (WSL/WSH), Jolt Server Listener/Handler (JSL/JSH), or IIOP Listener/Handler (ISL/ISH). A remote Tuxedo client may run on a machine that is *not* part of the Tuxedo server application (typically a workstation or personal computer), or the remote client may run on a machine that *is* part of the Tuxedo server application. For the latter case, the local operating system intercepts the messages destined for the network and redirects them to the destination process—the Tuxedo remote client or handler process—running locally.

A *native* Tuxedo client—a native ATMI client or a native CORBA C++ client—is co-located on a machine that is part of the Tuxedo server application and interfaces with a Tuxedo server via the Tuxedo infrastructure using interprocess communication. Native Jolt clients are *not* supported. These clients can only access a Tuxedo server via a pair of JSL/JSH gateway processes.

The following brief descriptions of other terms shown in the previous figure should prove helpful in understanding the connectivity between Oracle Tuxedo clients and servers:

IIOP

Internet Inter-ORB Protocol. A protocol used for communication between CORBA ORBs over the Internet (TCP/IP).

IIOPS

IIOP layered over the SSL protocol.

LLE

Link-Level Encryption. An Oracle Tuxedo protocol for establishing data privacy over network links between Oracle Tuxedo server machines.

SSL

Secure Sockets Layer. The standard protocol for establishing secure communications over the Internet (TCP/IP).

Oracle Tuxedo Client Components

The following client component software is included in the Oracle Tuxedo 11g Release 1 (11.1.1.1.2.0) distribution:

- Oracle ATMI Workstation (/WS) client software
- Oracle Jolt client software
- Oracle C++ client ORB including environmental objects

Oracle Tuxedo Server Components

The following server component software is included in the Oracle Tuxedo 11g Release 1 (11.1.1.1.2.0) distribution:

- Oracle ATMI server software (includes native ATMI client software)
- Oracle CORBA C++ server software (includes native CORBA C++ client software)
- Oracle Jolt server software
- Oracle TSAM Agent software
- Oracle SALT software
- Oracle SNMP Agent software
- Oracle Tuxedo Administration Console software

Invocation Capabilities

The following table lists the invocation capabilities for an application built on the Oracle system. An Oracle Tuxedo application may span multiple Oracle Tuxedo server machines and may provide ATMI services, CORBA objects, or both.

This component . . .	Can call a . . .	Through . . .
ATMI client *	ATMI service	WSL/WSH
Jolt client	ATMI service	JSL/JSH
CORBA C++ client *	CORBA C++ object	ISL/ISH
ATMI server	ATMI service	Tuxedo infrastructure
CORBA C++ object	CORBA C++ object	Tuxedo infrastructure
CORBA C++ object	ATMI service	Tuxedo infrastructure

* A native Tuxedo ATMI or CORBA C++ client does not use listener or handler gateway processes.

For information on how Oracle Tuxedo 11g Release 1 (11.1.1.1.2.0) interoperates with older releases of Oracle Tuxedo software, Oracle WebLogic Enterprise, and third-party products, or

how Oracle Tuxedo 11g Release 1 (11.1.1.1.2.0) interoperates with Oracle WebLogic Server, see [Oracle Tuxedo Interoperability](#).

Note: An Oracle Tuxedo client cannot invoke another Oracle Tuxedo client.

Client-to-Server Invocation Capabilities

The following client-to-server invocations are supported by an Oracle Tuxedo application:

- An Oracle ATMI client invoking an Oracle Tuxedo service

For more information about remote ATMI clients, see [Using the Oracle Tuxedo ATMI Workstation Component](#).

- An Oracle Jolt client invoking an Oracle Tuxedo service

For more information about Jolt, see [Using Oracle Jolt](#) and the [Oracle Jolt API Javadoc](#) reference information.

- An Oracle CORBA C++ client invoking an Oracle Tuxedo CORBA C++ object

For details, see [Creating CORBA Client Applications](#).

Server-to-Server Invocation Capabilities

The following figure shows the invocation capabilities between Oracle Tuxedo ATMI and CORBA C++ application servers.

Figure 1-5 Oracle Tuxedo ATMI and CORBA C++ Server Invocations

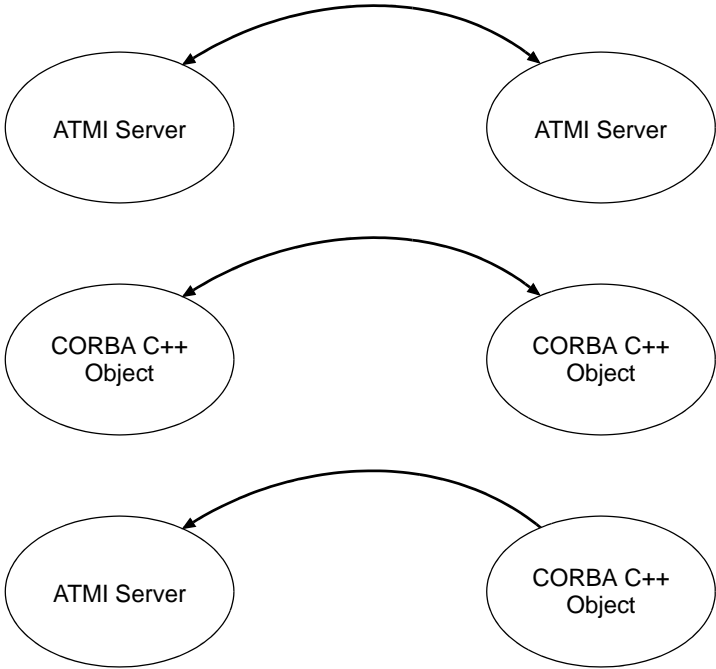

As shown in the figure, a CORBA C++ object can include ATMI calls to Oracle Tuxedo services. For an example, see the Wrapper University sample application, available in the [Guide to the CORBA University Sample Applications](#).

Domains

An Oracle Tuxedo domain, or application, is defined and controlled by a single configuration file. A Tuxedo domain consists of many Tuxedo system processes, one or more application client processes, one or more application server processes, and one or more computer machines connected over a network. It is administered as a single unit.

An Oracle Tuxedo domain may provide ATMI services, CORBA objects, or both. The Tuxedo domain in the following example contains a mixture of ATMI services and CORBA objects.

Figure 1-6 Simplified View of an Oracle Tuxedo Domain

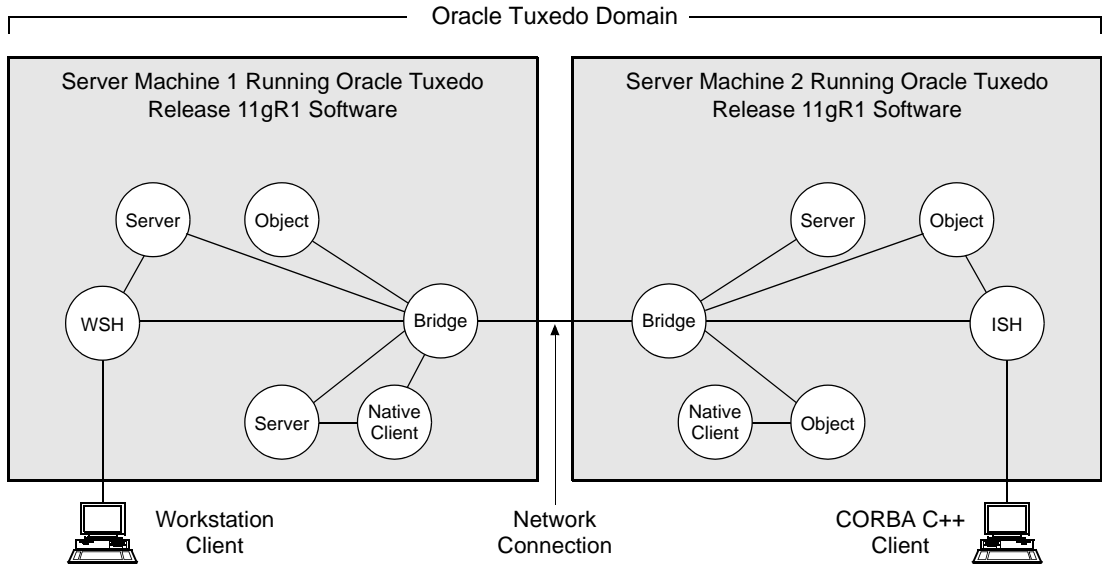

In Oracle Tuxedo terminology, a *domain* is the same as an *application*—a business application; both terms are used as synonyms throughout the Oracle Tuxedo user documentation. Examples of business applications currently running on Tuxedo are airline and hotel reservation systems, credit authorization systems, stock-brokerage systems, banking systems, and automatic teller machines.

For more information about Tuxedo domains, see [“Important Oracle Tuxedo Terms and Concepts”](#) on page 2-1. For information about interconnecting Tuxedo domains, see [“Oracle Tuxedo Domains”](#) on page 2-14.

Oracle Tuxedo Product Family

The Oracle Tuxedo Family is comprised of the following: Oracle Tuxedo, Oracle ART, Oracle JCA, Oracle Jolt, Oracle SALT, Oracle SNMP Agent, and Oracle TSAM.

Excluding Oracle Tuxedo, this section provides a general introduction to the other Oracle Tuxedo family products.

- [About Oracle ART](#)

- [About Oracle JCA](#)
- [About Oracle Jolt](#)
- [About Oracle SALT](#)
- [About Oracle SNMP Agent](#)
- [About Oracle TSAM](#)

About Oracle ART

Oracle Art Runtime

In a z/OS environment, CICS is used to establish transactional communications between end-users and compiled programs via screens.

CICS is middleware that implements the control and integrity of shared resources, providing developers with APIs (EXEC CICS ... END-EXEC statements) to dialog with CICS inside programs mainly developed on z/OS in COBOL, PL1 and Assembler languages.

Once all the components of z/OS CICS applications (COBOL programs and data) are migrated to a UNIX/linux platform using Oracle Tuxedo Application Runtime Workbench, CICS Runtime enables them to be run unchanged using an API emulation on top of the native Oracle Tuxedo features.

Oracle ART Workbench

Oracle Tuxedo Application Rehosting Workbench is part of a packaged and comprehensive solution that enables its users:

To perform a replatforming project with minimum risk and cost;

To run the replatformed applications in a standardized UNIX/Linux, Tuxedo, Oracle environment.

Oracle ART Documentation

For more Oracle runtime and Workbench information, see the following documentation:

<http://www.oracle.com/technology/documentation/index.html>.

About Oracle JCA

The Oracle Tuxedo JCA Adapter is a JCA-based resource adapter that provides bi-directional service invocation between a JCA 1.5 compliant application servers and the Oracle Tuxedo system. Oracle Tuxedo JCA Adapter supports global and local transactions conforming to JCA transaction standards. It supports connection management, transaction infestation, identity propagation, and link-level security. Link-level security uses industry standard SSL/TLS or a proprietary high performance algorithm.

Oracle JCA Documentation

For more Oracle JCA information, see the following documentation:

<http://www.oracle.com/technology/documentation/index.html>.

About Oracle Jolt

Oracle Jolt is a Java class library and API that enables remote Java clients to access existing Oracle Tuxedo ATMI services. It enables users to build client applets and applications that can remotely invoke Tuxedo ATMI services—such as application messaging, component management, and distributed transaction processing—using an ordinary Web browser.

Oracle Jolt extends the functionality of existing Tuxedo ATMI applications to include intranet- and Internet-wide availability. Oracle Jolt also enables Oracle WebLogic Server to invoke Tuxedo ATMI services. For clarification, see “[Making Tuxedo Services Web Accessible Through Oracle Jolt](#)” on page 5-7.

Oracle Jolt Documentation

For more information about Oracle Jolt, see the following documentation:

- [Using Oracle Jolt](#)
- [Using Oracle Jolt with Oracle WebLogic Server](#)

About Oracle SALT

Oracle Service Architecture Leveraging Tuxedo (SALT) is an add-on product option for Tuxedo, enabling Tuxedo applications to participate in SOA environments. Oracle SALT has two major components: native Web services stack and SCA container.

Oracle SALT allows external Web services applications to invoke Tuxedo services as Web services, and Tuxedo applications to invoke external Web services. Oracle SALT does not require any coding to achieve this. In addition, Oracle SALT includes SCA container, which allows you to develop new SOA applications focusing on business logic, while still taking advantage of Tuxedo infrastructure. SCA container also helps with effective reuse of existing application assets.

Oracle SALT Documentation

For more Oracle SALT information, see the following documentation:

<http://www.oracle.com/technology/documentation/index.html>.

About Oracle SNMP Agent

Oracle SNMP Agent for Oracle Tuxedo enables SNMP-compliant network management frameworks to manage Oracle Tuxedo systems and Oracle Tuxedo applications. Oracle SNMP Agent complies with the Simple Network Management Protocol version 1 (SNMPv1) specification.

Oracle SNMP Agent provides the SNMP links from Tuxedo applications to SNMP-based system-management consoles. It also allows multiple SNMP agents and subagents—from any vendor—to operate on the same machine.

Oracle SNMP Agent Documentation

For more information about Oracle SNMP Agent, see the following documentation:

- [Oracle Tuxedo SNMP Agent Administration Guide](#)
- [Oracle Tuxedo SNMP Agent MIB Reference](#)

About Oracle TSAM

Oracle Tuxedo System and Application Monitor (TSAM) provides comprehensive monitoring and reporting for Oracle Tuxedo system and applications. It includes two components: Oracle TSAM Agent and Oracle TSAM Manager. The Oracle TSAM Agent enables collection of various performance metrics for applications, including XA and non-XA transactions, services, system servers.

Oracle TSAM Manager provides graphical user interface to correlate and aggregate performance metrics collected from one or more Tuxedo domains and display it in real time.

The major features included in Oracle TSAM are:

- Call path monitoring and analysis
- Service monitoring and statistics
- System server monitoring and statistics
- Transaction monitoring
- SLA Events

Oracle TSAM Documentation

For more Oracle TSAM information, see the following documentation:

<http://www.oracle.com/technology/documentation/index.html>.

Oracle Tuxedo ATMI Core Components

The following sections describe the Oracle Tuxedo ATMI components and the Oracle Tuxedo infrastructure:

- [Important Oracle Tuxedo Terms and Concepts](#)
- [Oracle Tuxedo ATMI Overview](#)
- [Oracle Tuxedo ATMI Architecture](#)
- [Oracle Tuxedo Transaction Processor and Infrastructure](#)
- [Oracle Tuxedo Workstation](#)
- [Oracle Tuxedo /Q](#)
- [Oracle Tuxedo EventBroker](#)
- [Oracle Tuxedo Domains](#)

Important Oracle Tuxedo Terms and Concepts

The following terms and concepts are fundamental to understanding the Oracle Tuxedo system and applications built on the Oracle Tuxedo system:

- Tuxedo domain

An Oracle Tuxedo domain, also known as an Oracle Tuxedo application, is a set of Tuxedo system, client, and server processes administered as a single unit from a single Tuxedo configuration file. A Tuxedo domain consists of many system processes, one or more

application client processes, one or more application server processes, and one or more computer machines connected over a network. An Oracle Tuxedo domain may provide ATMI services, CORBA objects, or both.

Note: A Tuxedo *domain* has the same meaning as a Tuxedo *application*.

- Tuxedo configuration file

Each Oracle Tuxedo domain is controlled by a configuration file in which installation-dependent parameters are defined. The text version of the configuration file is referred to as `UBBCONFIG`, although the configuration file may have any name, as long as the content of the file conforms to the format described on reference page [UBBCONFIG \(5\)](#) in *Oracle Tuxedo File Formats, Data Descriptions, MIBs, and System Processes Reference*.

The binary version of the `UBBCONFIG` file is referred to as `TUXCONFIG`. As with `UBBCONFIG`, the `TUXCONFIG` file may be given any name; the actual name is the device or system filename specified in the `TUXCONFIG` environment variable.

- Tuxedo master machine

The master machine, or master node, for an Oracle Tuxedo domain is a server machine containing the domain's `UBBCONFIG` file, and is designated as the master machine in the `RESOURCES` section of the `UBBCONFIG` file. Starting, stopping, and administering the one or more server machines in a Tuxedo domain is done through the master machine.

The master machine for a Tuxedo domain also contains the master copy of the `TUXCONFIG` file. Copies of the `TUXCONFIG` file are propagated to every other server machine—referred to as *non-master machines*—in a Tuxedo domain whenever the Tuxedo system is booted on the master machine.

- Tuxedo bulletin board

The Oracle Tuxedo system uses the `TUXCONFIG` file to set up a *bulletin board* on each server machine in a Tuxedo domain. When a Tuxedo server process becomes active, it advertises the names of its services in the bulletin board. Some information in the bulletin board is global and is replicated on every server machine in the Tuxedo domain (for example, the names and locations of all servers offering a particular service). Other information is local and is visible only on the local bulletin board (for example, the actual number and type of client requests currently waiting on a local server request queue).

The bulletin board provides location and namespace transparency within a Tuxedo domain. Location transparency means that Tuxedo client and server processes do not have to be aware of the location of a resource (ATMI service, CORBA C++ object) within the Tuxedo domain. Namespace transparency means that Tuxedo client and server processes can use

the same naming conventions (and namespace) to locate any resource in the Tuxedo domain.

Oracle Tuxedo ATMI Overview

Oracle Tuxedo ATMI is a set of core technologies that enables application designers to create ATMI applications that mix and match hardware platforms, databases, and operating systems. It provides all the features and benefits of a high-end online transaction processing (OLTP) system, including scalability, high-performance, mission-critical reliability, and open standards support.

At the foundation of Oracle Tuxedo ATMI is a proven, reliable transaction processor, also known as a transaction processing (TP) monitor. As shown in the following figure, a transaction processor is an example of a 3-tier client/server architecture, where the transaction processor supports the application logic between the GUI front-end and the back-end resource managers. Examples of resource managers are SQL databases, message queues, legacy applications, and other back-end services.

Figure 2-1 3-Tier Client/Server Architecture Using a Transaction Processor

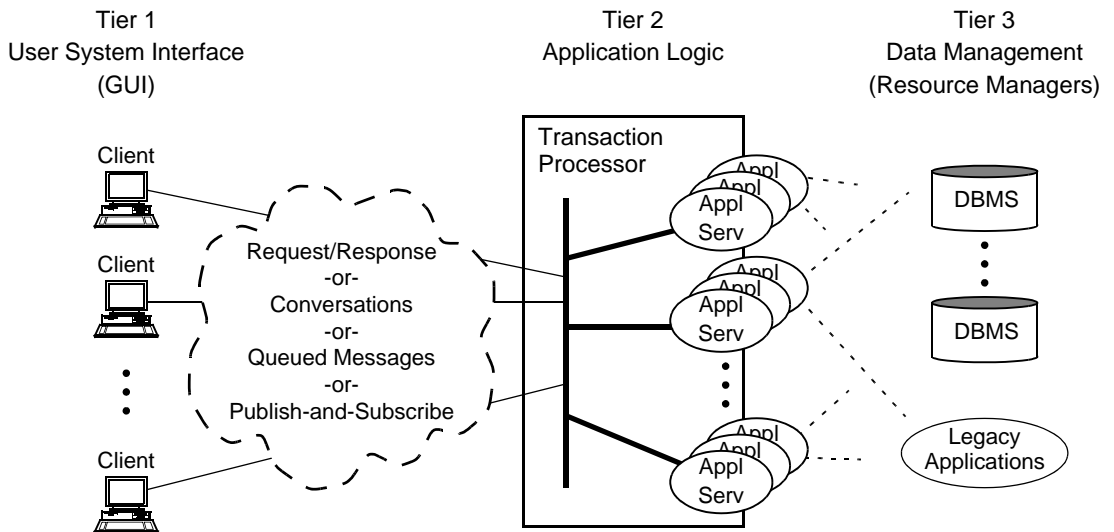

By breaking the direct connection between the user interface front-end and the resource managers, a transaction processor controls all the traffic that links hundreds or thousands or even tens of thousands of clients with application programs and the back-end resources. A transaction

processor ensures that global (distributed) transactions are completed accurately, provides load balancing, and improves the overall system performance. More importantly, a transaction processor makes an application's server processes independent of the user interface front-end and any resource manager.

Oracle Tuxedo ATMI is a transaction application server that runs server-side applications and components. Besides managing an application's server processes and managing transactions, Oracle Tuxedo ATMI also manages client/server communications, that is, allows clients (and servers) to invoke an application service in a variety of ways, including:

- Request/response

Request/response transactions usually involve people and thus require immediate attention; they run in high-priority mode. Oracle Tuxedo ATMI provides an ATMI request/response transactional communication interface.

- Conversations

Conversational transactions also usually involve people and thus require immediate attention; they run in high-priority mode. Oracle Tuxedo ATMI provides an ATMI conversational transactional communication interface.

- Queuing

Queued transactions can run as high-priority or low priority messages. Oracle Tuxedo ATMI includes its own bundled version of recoverable queues called */Q*.

- Publish-and-subscribe

Publish-and-subscribe transactions usually run as high-priority messages. Oracle Tuxedo ATMI has a transactional publish-and-subscribe system called *EventBroker*.

Transactional communications use highly augmented versions of remote procedure calls, conversational peer-to-peer, queues, and publish-and-subscribe. However, most of the value-added elements are transparent to the programmer: The transactional client/server exchanges look like ordinary exchanges bracketed by start and end transaction calls. The distinguishing factor is that all resource managers and processes invoked through these calls become part of the transaction. A transaction processor, such as Oracle Tuxedo ATMI, orchestrates the actions of all the participants and makes them act as part of a transaction.

Oracle Tuxedo ATMI Architecture

Oracle Tuxedo ATMI consists of the following main components:

- Oracle Tuxedo transaction processor and infrastructure
Provides the core services needed to run and administer a distributed ATMI application.
- Oracle Tuxedo Workstation
Allows ATMI clients to reside on intelligent workstations and communicate over a network connection with an ATMI server application
- Oracle Tuxedo /Q
Provides a messaging and queuing capability to allow ATMI clients and servers to communicate across networks without being linked by a private, dedicated, logical connection.
- Oracle Tuxedo EventBroker
Provides a publish-and-subscribe capability that brokers the distribution of application and system events between ATMI clients and servers.
- Oracle Tuxedo Domains
Offers the ability to connect ATMI applications that are logically and physically separate so that the combination appears to the user as a single application.

Oracle Tuxedo Transaction Processor and Infrastructure

The Oracle Tuxedo infrastructure provides the bedrock client/server architecture for both Oracle Tuxedo ATMI and Oracle Tuxedo CORBA. The transaction processor and infrastructure discussed here and illustrated in the following figure constitute the Oracle Tuxedo ATMI environment, which provides request/response and conversational communication interfaces, transaction support, and application-processing and administrative services for a distributed ATMI application.

Figure 2-2 Oracle Tuxedo ATMI Environment

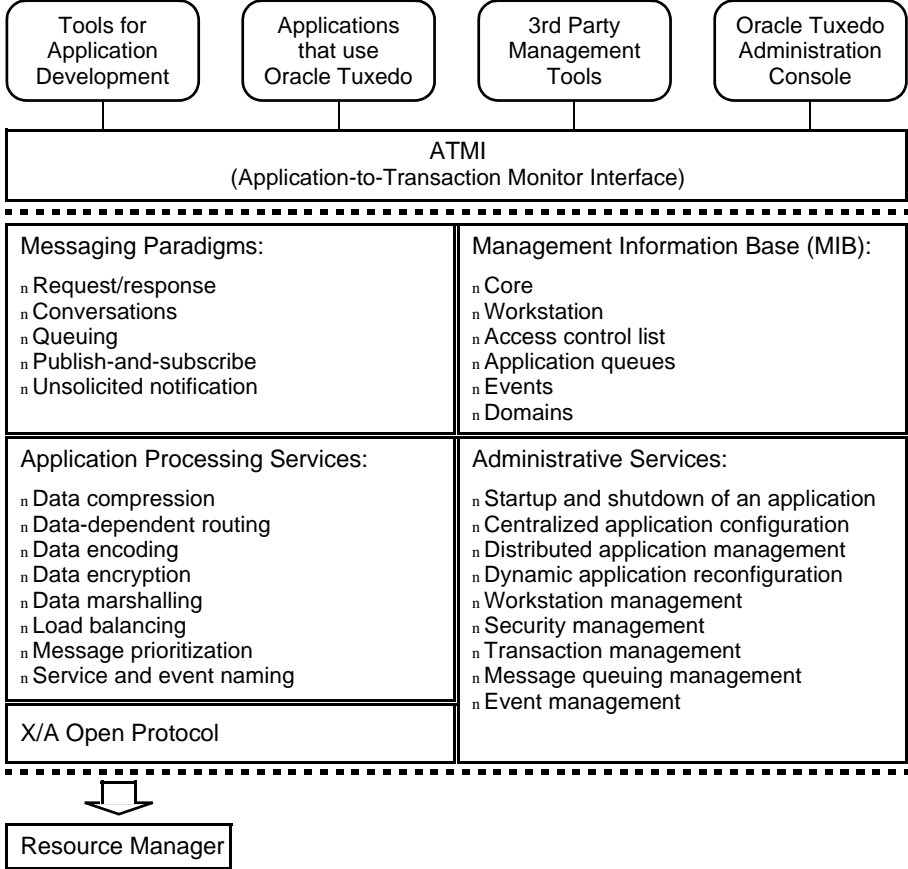

System Management Interface

The Oracle Tuxedo system management interface, common to both Oracle Tuxedo ATMI and Oracle Tuxedo CORBA, can accommodate tools for administration, such as those described in [“Management Tools” on page 1-16](#), and tools for application development, such as Simple Network Management Protocol (SNMP) agents. Oracle Tuxedo provides an open tool environment that is supported by many third-party tools.

The Oracle Tuxedo Administration Console and SNMP agents can interact with standard management consoles, which enables administrators to manage an Oracle Tuxedo ATMI or

CORBA environment *and* a network configuration from one console. In addition, application architects and developers can build their own administrative tools or application-specific or market-specific tools on top of the Tuxedo management information base (TMIB) accessible through the MIB interface.

ATMI Programming Interface

Oracle Tuxedo ATMI supports an ATMI programming interface that offers procedural library-based programming using a set of C or COBOL procedures. ATMI provides an interface for communications, transactions, and data-buffer management that works in all ATMI environments supported by the Oracle Tuxedo system. The ATMI interface and the Oracle Tuxedo system implement the X/Open distributed transaction processing (DTP) model for transaction processing.

The Oracle Tuxedo ATMI interface provides a foundation for request/response and conversational communications.

Request/Response Communications

Programmers use the ATMI request/response functions to send a single request from a requesting process, and to receive a single response from the called request/response server process. Request/response is a simple type of dialogue. The rules for communication during request/response are fixed: the client asks for a service and the server responds. The client never sends more than one message as part of its request, and the server never sends more than one response in its reply.

For the requesting process, the execution of a request/response service can be synchronous or asynchronous.

Conversational Communications

Programmers use the ATMI conversational functions to establish and maintain state-preserving connections—context kept from message to message—between a requesting process and the called conversational server process. Specifically, programmers use the ATMI conversational functions to:

- Open a connection to a conversational server
- Begin and end a transaction during the conversation
- Have a conversation span multiple machines and resource managers

- Detect and provide notification of connection failures
- Terminate the connection when satisfied that the task has been completed

A conversational server is dedicated to the originating requester for the duration of the connection. The Oracle Tuxedo system automatically spawns a new copy of a server if one is not available when a conversational connection is requested.

Thus, using the ATMI conversational programming interface, programmers can define transaction boundaries within their application so that the work performed can be treated as an *atomic unit*. What this statement means is that within a single Oracle Tuxedo transaction, the work performed is either committed or rolled back *as a single unit of work*, which keeps all the databases synchronized, even if there are machine failures.

ATMI Interface Documentation

For more information on the Oracle Tuxedo ATMI interface, see [Introducing Oracle Tuxedo ATMI](#).

FML Programming Interface

In addition to the ATMI interface, Oracle Tuxedo ATMI supports a Field Manipulation Language (FML) programming interface, which is a set of C language functions for defining and manipulating storage structures called *fielded buffers*. Fielded buffers contain attribute-value pairs in fields, where the attribute is the field's identifier, and the associated value represents the field's data content.

If the FML and its fielded buffer concept are specified by the application designers, application programmers have a rich array of functions for the definition and management of FML fields and buffers. (See “[Typed Buffers](#)” on [page 2-9](#) for a brief description of data buffers.) The selection includes functions to move data back and forth between a fielded buffer and a C structure or COBOL record (referred to as a VIEW), the members of which parallel the buffer's fields.

The FML function set has a companion function set, FML32, designed for use with larger records with more fields.

For more information on Oracle Tuxedo FML, see [Programming an Oracle Tuxedo Application Using FML](#).

Typed Buffers

Oracle Tuxedo ATMI applications send and receive their data in typed buffers. Instead of allocating memory directly from the operating system, applications allocate typed buffers from the Oracle Tuxedo system in which to place their data.

Typed buffers are data structures defined by application programmers and made known to the Oracle Tuxedo system. Because the Oracle Tuxedo system knows about the application data buffers, it can optimally manipulate them during communication.

Typed buffers contain information about themselves (metadata), which allows application programmers to transfer data without needing to know which data representation scheme is used by the machines on which the application's clients and servers are running. Typed buffers allow applications to maintain machine independence.

Each buffer type supported by an Oracle Tuxedo release has its own set of routines that can be called automatically to initialize; send and receive messages; and encode and decode data without programmer intervention. The set of routines is called a *typed buffer switch*.

Oracle Tuxedo provides different kinds of typed buffers, including FML and FML32, and allows application designers to define their own typed buffers. For more information about typed buffers, see [“What Are Typed Buffers?”](#) in *Introducing Oracle Tuxedo ATMI*.

Oracle Tuxedo Workstation

The Oracle Tuxedo Workstation component allows ATMI clients to reside on a remote machine that does not have a full Oracle Tuxedo server-side installation, that is, a machine that does not support Oracle Tuxedo administration servers or a bulletin board. All communication between a remote ATMI client and the Oracle Tuxedo server application takes place over the network.

Advantages of the Oracle Tuxedo Workstation component include:

- Less administrative overhead
- Greater security—keeps clients off the Oracle Tuxedo server machines
- Off loads CPU cycles and decreases process context switches on Oracle Tuxedo server machines
- Smaller footprint

Workstation Communication

The Workstation component involves the following software processes:

- Workstation client

An ATMI client process that runs on a machine on which the Oracle Tuxedo Workstation client software is installed.

- Workstation Listener (WSL)

An Oracle Tuxedo listening process, running on an Oracle Tuxedo server machine, that accepts connection requests from Workstation clients and assigns connections to a Workstation Handler also running on the server machine. It also manages the pool of Workstation Handler processes, starting them in response to load demands.

- Workstation Handler (WSH)

An Oracle Tuxedo gateway process, running on the Oracle Tuxedo server machine, that handles communications between Workstation clients and the Oracle Tuxedo server application. A WSH process resides within the administrative domain of the application and is registered in the local Oracle Tuxedo bulletin board as a client.

Each WSH process can manage multiple Workstation clients. A WSH multiplexes all requests and replies with a particular Workstation client over a single connection.

The following figure shows how these processes are used to connect remote ATMI clients to the Oracle Tuxedo server application.

Figure 2-3 Connecting Remote ATMI Clients

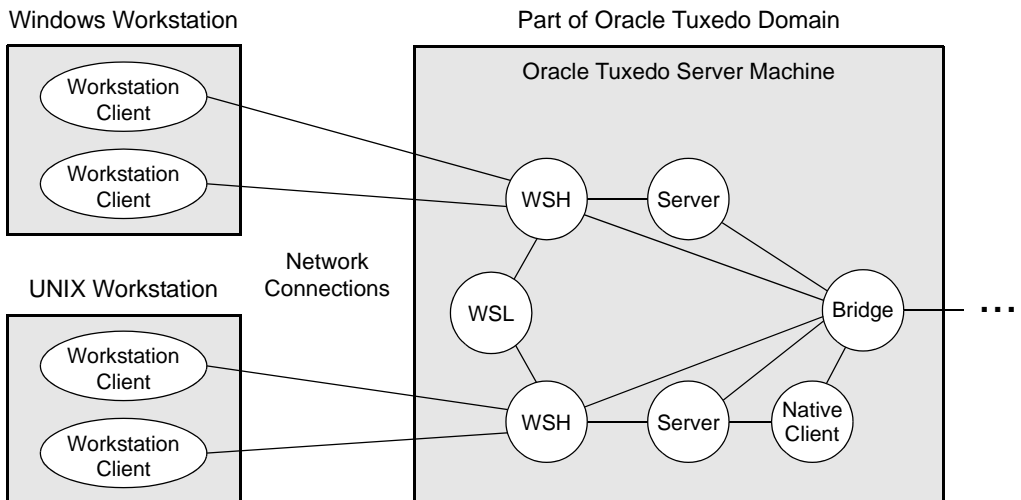

Workstation Documentation

For more information about the Oracle Tuxedo Workstation component, see the following documents:

- [“Oracle Tuxedo System Administration and Server Processes”](#) in *Introducing Oracle Tuxedo ATMI*
- [Using the Oracle Tuxedo ATMI Workstation Component](#)
- [“Administering Security”](#) in *Using Security in ATMI Applications*
- [UBBCONFIG\(5\)](#), [WS_MIB\(5\)](#), and [WSL\(5\)](#) in *Oracle Tuxedo File Formats, Data Descriptions, MIBs, and System Processes Reference*

Oracle Tuxedo /Q

Oracle Tuxedo /Q is a transactionally enabled, XA compliant, application queuing system incorporating typed buffers. /Q provides for time-independent communication among clients and servers in an Oracle Tuxedo ATMI application.

/Q makes it possible for an ATMI application, within a global transaction, to store client and server generated messages to stable storage for processing later. A Q-enabled client or server

process decides when it wants to retrieve a message off its queue. However, because the operation is within the scope of a transaction, the Oracle Tuxedo system ensures that either the message will eventually be processed or the entire transaction will be rolled back.

`/Q` can be combined with Oracle Tuxedo Workstation to store and retrieve messages from Workstation clients. The interface for this combination is available in both the C and COBOL programming languages.

Storing and Retrieving Messages

Time-independent client and server programs communicate by storing (queuing) messages for each other in application queues. Messages can be retrieved (dequeued) in any of several ordering schemes, including *last in, first out* (LIFO), *first in, first out* (FIFO), priority order, and time-based order. More than one client and server can access the same queue. The following figure shows at a high level how message queuing communication works using `/Q`.

Figure 2-4 Queue-Based Messaging

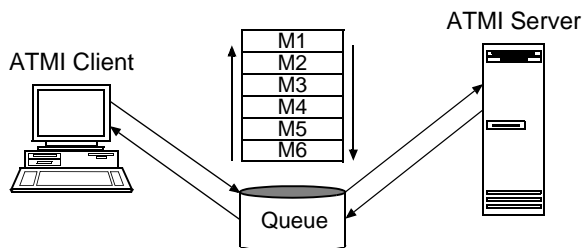

`/Q` Documentation

For more information about the Oracle Tuxedo `/Q` component, see the following documents:

- [“Oracle Tuxedo System Administration and Server Processes”](#) in *Introducing Oracle Tuxedo ATMI*
- [Using the ATMI `/Q` Component](#)
- [`tpenqueue\(3c\)`](#) and [`tpdequeue\(3c\)`](#) in *Oracle Tuxedo ATMI C Function Reference*
- [`APPQ_MIB\(5\)`](#), [`TMQUEUE\(5\)`](#), [`TMQFORWARD\(5\)`](#), and [`UBBCONFIG\(5\)`](#) in *Oracle Tuxedo File Formats, Data Descriptions, MIBs, and System Processes Reference*

Oracle Tuxedo EventBroker

Oracle Tuxedo EventBroker is a transactionally enabled, XA compliant, application publish-and-subscribe system that provides asynchronous routing of application events among the processes running in an Oracle Tuxedo ATMI application. It also distributes system events to whichever application processes want to receive them.

An event is a state change or other occurrence in an application program or the Oracle Tuxedo system that may be of interest to an administrator, an operator, or the software. Examples of events are “a stock traded at or above a specified price” or “a network failure occurred.”

Mediating Between Producers and Consumers of Events

There are producers of events, called *publishers* or *suppliers*, and consumers of events, called *subscribers*. EventBroker mediates between the producers and consumers about the distribution of events. The following figure shows how publish-and-subscribe communication works using EventBroker.

Figure 2-5 Event Subscription, Posting, and Notification

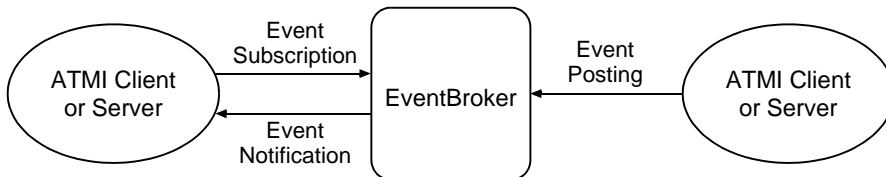

Posting an event in a global transaction means that all of the work, including work not related to the posting, is ensured to be complete if the transaction is successful. If any work performed within the transaction fails, all the work done within the transaction will be rolled back.

EventBroker Documentation

For more information about the Oracle Tuxedo EventBroker component, see the following documents:

- [“Oracle Tuxedo System Administration and Server Processes”](#) in *Introducing Oracle Tuxedo ATMI*
- [“About the EventBroker”](#) in *Administering an Oracle Tuxedo Application at Run Time*

- [tppost\(3c\)](#), [tpsubscribe\(3c\)](#), and [tpunsubscribe\(3c\)](#) in *Oracle Tuxedo ATMI C Function Reference*
- [EVENTS\(5\)](#), [EVENT_MIB\(5\)](#), [TMSYSEVT\(5\)](#), [TMUSREVT\(5\)](#), and [UBBCONFIG\(5\)](#) in *Oracle Tuxedo File Formats, Data Descriptions, MIBs, and System Processes Reference*

Oracle Tuxedo Domains

The Oracle Tuxedo Domains component extends the Oracle Tuxedo system client/server model to provide transaction interoperability across TP domains—business applications. This extension preserves the model and the ATMI interface by making access to services on the remote domain (or accepting service requests from a remote domain) transparent to both the application programmer and the end-user. The Domains component makes this possible via a highly asynchronous multitasking *domain gateway* that handles outgoing and incoming service requests to or from remote domains.

The Oracle Tuxedo system offers the following types of domain gateways to allow an Oracle Tuxedo application to communicate with other Oracle Tuxedo applications or with applications running on other TP systems.

Figure 2-6 Domain Gateway Types

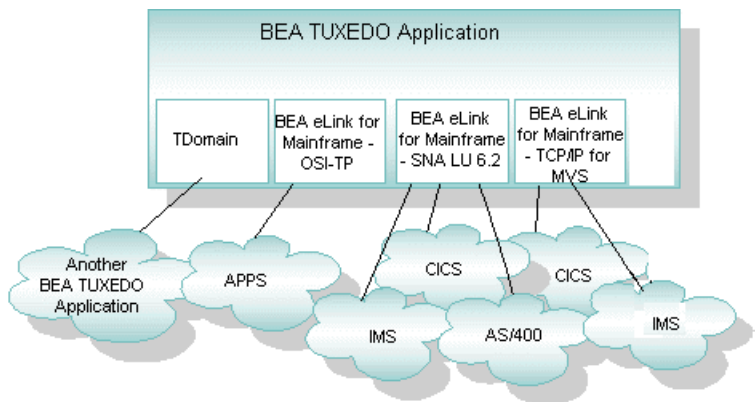

Note: Oracle Tuxedo CORBA applications also use the Domains component to interoperate with one another and share resources. Only the *TDomain* gateway type—implemented by the `GWTDOMAIN` process—is applicable to Oracle Tuxedo CORBA applications.

Transparency Between Domains

In an Oracle Tuxedo Domains configuration, an administrator can configure which services of a domain are available to other domains in the configuration. The clients and the participating applications themselves do not need to know anything about the Domains configuration. All they need to know is what services or factory objects are available and how to access those services or objects. If applications were to include information about domains, changing configurations would require that the applications be rewritten as well.

Domains Documentation

For more information about the Oracle Tuxedo Domains component, see the following documents:

- [“Oracle Tuxedo System Administration and Server Processes”](#) in *Introducing Oracle Tuxedo ATMI*
- [Using the Oracle Tuxedo Domains Component](#)
- [DMADM\(5\)](#), [DMCONFIG\(5\)](#), [GWADM\(5\)](#), [GWTDOMAIN\(5\)](#), and [UBBCONFIG\(5\)](#) in *Oracle Tuxedo File Formats, Data Descriptions, MIBs, and System Processes Reference*

Oracle Tuxedo CORBA Components

The following sections describe the Oracle Tuxedo CORBA components built on the Oracle Tuxedo infrastructure:

- [Oracle Tuxedo CORBA Overview](#)
- [Oracle Tuxedo CORBA TP Framework](#)
- [Oracle Tuxedo CORBA Architecture](#)
- [Oracle Tuxedo OTM and Infrastructure](#)
- [Oracle Tuxedo ORB Software](#)
- [Oracle Tuxedo IIOP Listener/Handler](#)
- [Oracle Tuxedo CORBA Environmental Objects](#)
- [Oracle Tuxedo CORBA Object Services](#)
- [Oracle Tuxedo TP Framework](#)

Note: The Oracle Tuxedo CORBA Java client and Oracle Tuxedo CORBA Java client ORB were deprecated in Tuxedo 8.1 and are no longer supported. All Oracle Tuxedo CORBA Java client and Oracle Tuxedo CORBA Java client ORB text references, associated code samples, should only be used to help implement/run third party Java ORB libraries, and for programmer reference only.

Technical support for third party CORBA Java ORBs should be provided by their respective vendors. Oracle Tuxedo does not provide any technical support or documentation for third party CORBA Java ORBs.

Oracle Tuxedo CORBA Overview

Oracle Tuxedo CORBA provides businesses and organizations that depend on mission-critical applications with the advantages of the CORBA-compliant programming model, combined with the power, robustness, and proven reliability of the Tuxedo transaction processing technology. Oracle Tuxedo CORBA also taps into the existing Tuxedo infrastructure for transaction management, security, message transport, administration and manageability, and XA-compliant database support.

Oracle Tuxedo CORBA combines the ORB model with online transaction processing (OLTP) functions to create a top-of-the-line Object Transaction Monitor (OTM). As shown in the following figure, an OTM is an example of a 3-tier client/server architecture, where the OTM supports the application logic between the GUI front-end and the back-end resource managers. Examples of resource managers are object-oriented databases, relational databases, message queues, legacy applications, and other back-end services.

Figure 3-1 3-Tier Client/Server Architecture Using an OTM

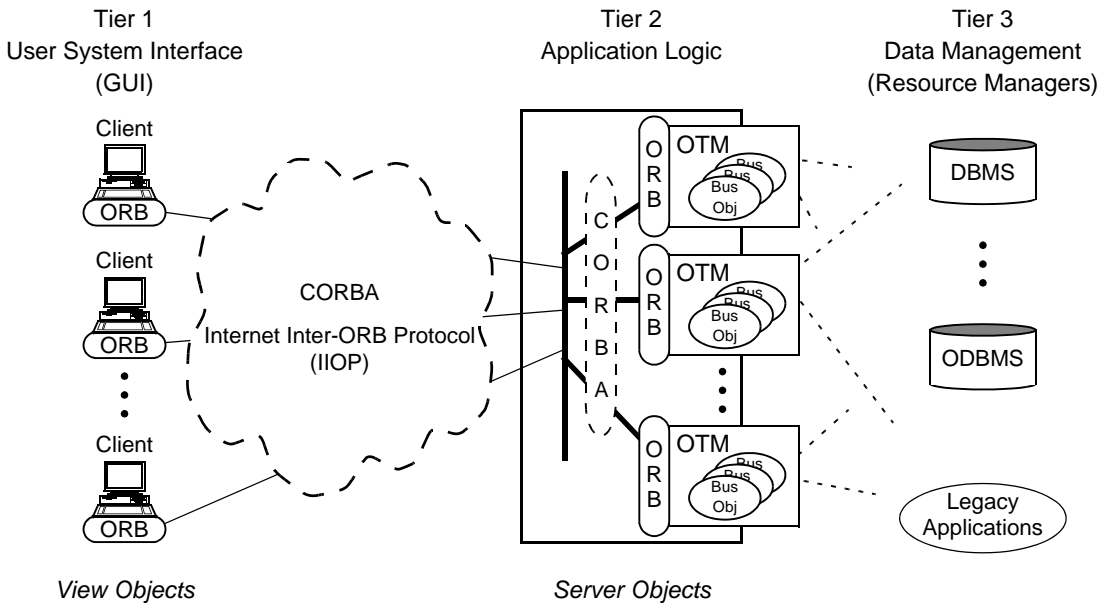

By breaking the direct connection between the user interface front-end and the resource managers, an OTM controls all the traffic that links hundreds or thousands or even tens of

thousands of clients with run-time objects and the back-end resources. An OTM ensures that global (distributed) transactions are completed accurately, provides load balancing, and improves the overall system performance. An OTM also prestarts pools of objects and provides fault-tolerance. More importantly, an OTM makes an application's server processes independent of the user interface front-end and any resource manager.

Oracle Tuxedo CORBA is an object application server that runs server-side distributed objects. Besides managing an application's server objects and managing transactions, Oracle Tuxedo CORBA also manages client/server communications.

Object-oriented transactional communications use a highly augmented version of ORB invocations. However, most of the value-added elements are transparent to the programmer: The transactional client/server exchanges look like ordinary exchanges bracketed by start and end transaction calls. The distinguishing factor is that all resource managers and processes invoked through these calls become part of the transaction. An OTM, such as Oracle Tuxedo CORBA, orchestrates the actions of all the participants and makes them act as part of a transaction.

Oracle Tuxedo CORBA TP Framework

The Oracle Tuxedo CORBA OTM provides a TP framework, or organized environment, for running server-side distributed objects. A TP framework not only calls the objects and the Tuxedo CORBA services at the appropriate time and in the correct sequence, but it also simplifies the server-side programming model.

Oracle Tuxedo CORBA Architecture

Oracle Tuxedo CORBA consists of the following main components:

- Oracle Tuxedo OTM and infrastructure
 - Provides the services needed to run and administer a distributed CORBA application.
- Oracle Tuxedo ORBs
 - Allows Tuxedo CORBA client and server objects to locate and communicate with one another.
- Oracle Tuxedo IIOP Listener/Handler
 - Allows Tuxedo CORBA clients to reside on intelligent workstations and communicate over a network connection with a CORBA server application.
- Oracle Tuxedo environmental objects

Provides a set of objects for helping Tuxedo CORBA clients and servers work with the Tuxedo CORBA environment.

- Oracle Tuxedo CORBA object services

Provides object services to Tuxedo CORBA clients.

- Oracle Tuxedo TP Framework

Provides a programming model for the rapid construction of Tuxedo CORBA server applications.

Oracle Tuxedo OTM and Infrastructure

The Oracle Tuxedo infrastructure provides the bedrock client/server architecture for both Oracle Tuxedo CORBA and Oracle Tuxedo ATMI. The OTM and infrastructure discussed here and illustrated in the following figure constitute the Oracle Tuxedo CORBA environment, which provides the communication interfaces, transaction support, and application-processing and administrative services for a distributed CORBA application.

Figure 3-2 Oracle Tuxedo CORBA Environment

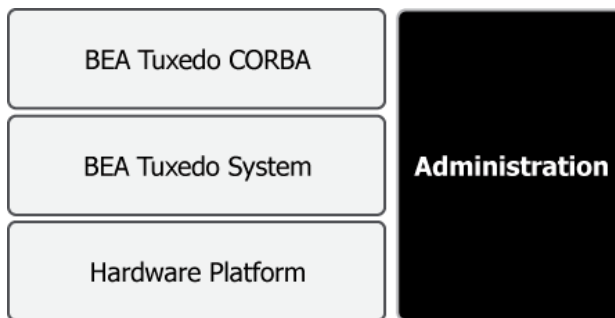

System Management Interface

The Oracle Tuxedo system management interface, common to both Oracle Tuxedo CORBA and Oracle Tuxedo ATMI, can accommodate tools for both application development and administration. For information about the Oracle Tuxedo system management interface, see [“System Management Interface” on page 2-6](#).

Application Programming Interface

The Oracle Tuxedo CORBA programming interface consists of a C++ server ORB and a C++ client ORB. On the server side, instead of using the CORBA API directly, application programmers use an API that automates many of the functions required in a standard CORBA application.

The Oracle Tuxedo CORBA server-side *TP Framework* component and client-side *environmental objects* enable programmers to use the deployment environment with a minimal amount of programming. For information about the TP Framework component, see [“Oracle Tuxedo TP Framework” on page 3-11](#). For information about client-side environmental objects, see [“Oracle Tuxedo CORBA Environmental Objects” on page 3-9](#).

Application Programming Environment

Application programmers develop a Tuxedo CORBA application as a set of CORBA objects, using the OMG Interface Definition Language (IDL) and, optionally, using standard, off-the-shelf programming tools. These objects communicate with other objects using the CORBA Internet Inter-ORB Protocol (IIOP). The following figure identifies the architectural components of the Oracle Tuxedo CORBA programming environment.

Figure 3-3 Components in an Oracle Tuxedo CORBA Application

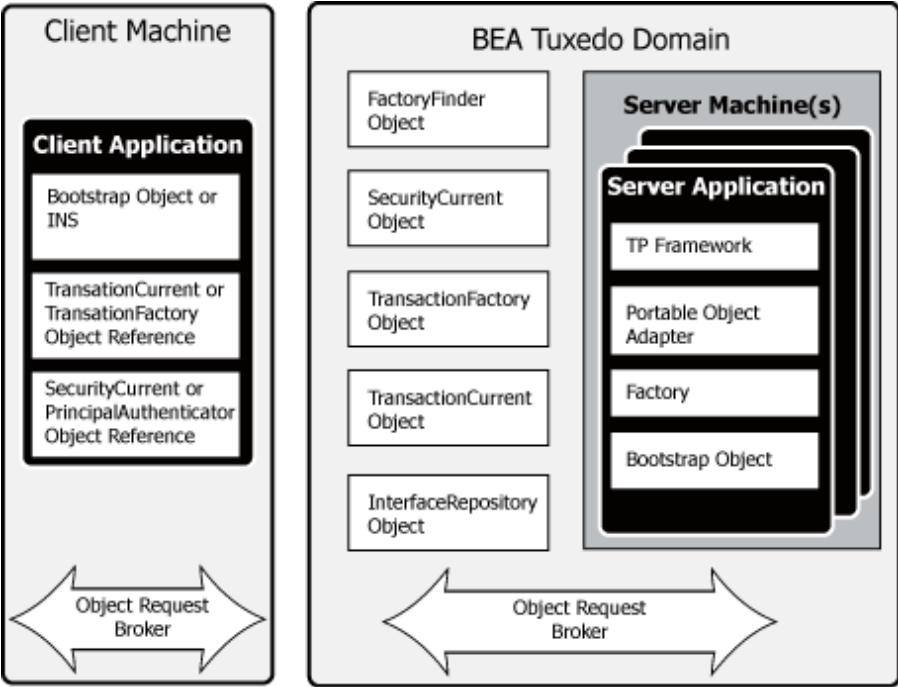

Oracle Tuxedo CORBA runs the objects in the server processes that it manages. Oracle Tuxedo CORBA can also manage server processes that run Tuxedo ATMI services, thereby allowing programmers to combine object-based and service-based components in the same Tuxedo application.

Note: A Tuxedo *application* has the same meaning as a Tuxedo *domain*. For a definition of a Tuxedo domain, see [“Important Oracle Tuxedo Terms and Concepts” on page 2-1](#).

Oracle Tuxedo ORB Software

The ORB, or Object Request Broker, is a library that enables clients to locate and communicate with servers independently of server location and network connections. The ORB is sometimes referred to as the *object bus*.

Programmers define their object’s interface via OMG IDL, and the ORB takes care of the rest. The ORB serves as an intermediary for requests that CORBA clients send to CORBA server

applications, so that the client and server do not need to contain information about each other. The following figure shows the relationship between an ORB, a CORBA application client, and a CORBA server application.

Figure 3-4 The ORB in a CORBA Client/Server Environment

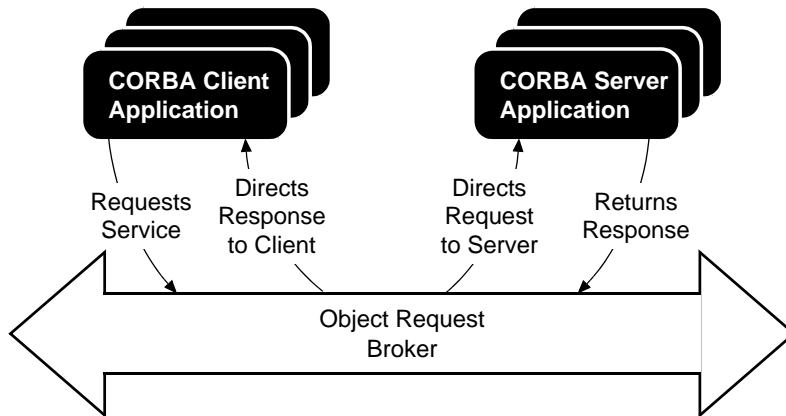

Oracle Tuxedo CORBA includes C++ server ORB and C++ client ORB. The ORBs have built-in transaction support, meaning that the CORBA Object Transaction Service (OTS), on which a CORBA OTM is based, is patterned after the XA standard for two-phase commit processing.

The C++ server ORB is linked directly into the Tuxedo CORBA server processes. Other client ORBs can communicate with Oracle Tuxedo CORBA via CORBA's IIOP protocol.

Oracle Tuxedo IIOP Listener/Handler

The Oracle Tuxedo IIOP Listener/Handler allows a CORBA client residing on a remote machine that does not have a full Oracle Tuxedo server-side installation (that is, a machine that does not support Oracle Tuxedo administration servers or a bulletin board) to be able to communicate with an Oracle Tuxedo CORBA server application. All communication between a remote CORBA client and the CORBA server application takes place over a network connection using the IIOP protocol.

Advantages of remote CORBA clients include:

- Less administrative overhead

- Greater security—keeps clients off the Oracle Tuxedo server machines
- Off loads CPU cycles and decreases process context switches on Oracle Tuxedo server machines
- Smaller footprint

IIOP Listener/Handler Communication

The IIOP Listener/Handler communication architecture involves the following software processes:

- CORBA client

A client process that runs on a machine on which the Oracle Tuxedo CORBA C++ client ORB software is installed.

- IIOP Listener (ISL)

An Oracle Tuxedo listening process, running on an Oracle Tuxedo server machine, that accepts connection requests from CORBA clients and assigns connections to an IIOP Handler also running on the server machine. It balances client connections across handlers. In addition, an IIOP Listener manages the pool of IIOP Handler processes, starting them in response to load demands.

- IIOP Handler (ISH)

An Oracle Tuxedo gateway process, running on the Oracle Tuxedo server machine, that handles IIOP communications between CORBA clients and the Oracle Tuxedo server application. An ISH process resides within the administrative domain of the application and is registered in the local Oracle Tuxedo bulletin board as a client.

Each ISH process can manage multiple CORBA clients. An ISH multiplexes all requests and replies with a particular CORBA client over a single connection.

IIOP Listener/Handler Documentation

For more information about the IIOP Listener/Handler, see the following documents:

- [Setting Up an Oracle Tuxedo Application](#)
- [ISL\(1\)](#) in *Oracle Tuxedo Command Reference*

Oracle Tuxedo CORBA Environmental Objects

Oracle Tuxedo CORBA provides a set of objects for helping the client work with the Tuxedo CORBA environment; the objects enable client applications to easily log on to a Tuxedo CORBA environment, invoke CORBA objects, and start and end transactions. Like the server-side TP Framework component, these objects interact with the Tuxedo CORBA services.

Here is what these objects do for application clients:

- Bootstrap object

The Bootstrap object provides references to the Tuxedo CORBA objects in a Tuxedo CORBA application. An application client can connect to multiple Oracle Tuxedo CORBA applications using different Bootstrap objects.

One of the first things that an application client does after startup is to create a Bootstrap object by supplying the host and port number of the IIOP Listener. After the application client contacts an IIOP Listener, the Listener assigns an IIOP Handler to the application client, and the Bootstrap object establishes a communication link with the assigned IIOP Handler.

The Bootstrap object also provides references to well-known objects that application clients use, such as TransactionCurrent, SecurityCurrent, InterfaceRepository, and FactoryFinder.

- CORBA OTS TransactionCurrent object

The CORBA OTS TransactionCurrent object coordinates transaction demarcations with the transaction coordinator.

- SecurityCurrent object

The SecurityCurrent object gets the application client's security credentials from the Security Service. The SecurityCurrent object registers the certificate with the IIOP Handler, which uses the certificate to permit or deny invocations.

Oracle Tuxedo CORBA Object Services

Oracle Tuxedo CORBA provides environmental objects for the C++ programming environment and for the Java programming environment. As of release 8.0, Oracle Tuxedo CORBA also supports the use of the OMG CORBA Interoperable Naming Service (INS) by third-party client ORBs, to obtain initial object references.

Each environmental object provides object services to application clients. Application clients access the environmental objects through a bootstrapping process that accesses the services in a particular Oracle Tuxedo server application. Oracle client ORBs use the Oracle Bootstrap object mechanism, and third-party client ORBs use the CORBA INS mechanism. For more information about bootstrapping an Oracle Tuxedo application, see [Oracle Tuxedo CORBA Programming Reference](#).

The Oracle Tuxedo CORBA environmental objects provide the following services:

- Object Life Cycle service

The Object Life Cycle service is provided through the FactoryFinder environmental object. The FactoryFinder object is a CORBA object that can be used to locate a factory, which in turn can create object references for CORBA objects. Factories and FactoryFinder objects are implementations of the CORBA Services Life Cycle Service. Oracle Tuxedo CORBA applications use the Object Life Cycle service to find object references.

- Security service

The Security service is accessed through either the SecurityCurrent environmental object or the PrincipalAuthenticator object. The SecurityCurrent and PrincipalAuthenticator objects are used to authenticate an application client attempting to access an Oracle Tuxedo server application. The Oracle Tuxedo software provides an implementation of the CORBA Services Security Service.

- Transaction service

The Transaction service is accessed through either the TransactionCurrent environmental object or the TransactionFactory object. The TransactionCurrent and TransactionFactory objects allow an application client to demarcate a transaction—that is, begin, suspend, resume, and commit a transaction. The Oracle Tuxedo software provides an implementation of the CORBA Services Object Transaction Service (OTS).

- Interface Repository service

The Interface Repository service is accessed through the InterfaceRepository object. The InterfaceRepository object is a CORBA object that contains interface definitions for all the available CORBA interfaces and the factories used to create object references to the CORBA interfaces. The InterfaceRepository object is used with application clients that use Dynamic Invocation Interface (DII).

Oracle Tuxedo TP Framework

The TP Framework component, shown in the following figure, provides a programming model that achieves high levels of performance while shielding the application programmer from the complexities of the CORBA interfaces.

Figure 3-5 The TP Framework

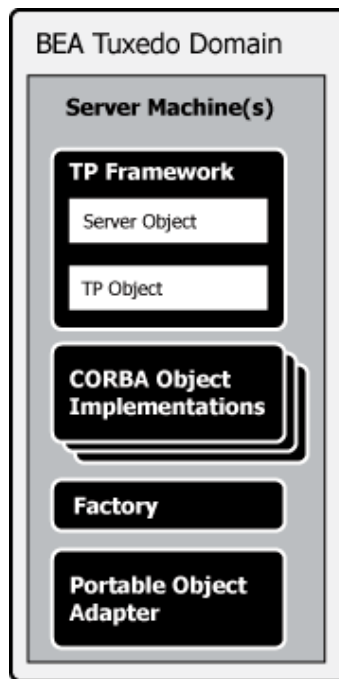

The TP Framework API provides routines that perform many of the functions required in a standard CORBA application. Application programmers are responsible only for writing the business logic of the CORBA application and overriding default actions provided by the TP Framework.

The TP Framework and environmental objects help make development easy. The following figure illustrates the Oracle Tuxedo CORBA development environment.

Figure 3-6 Oracle Tuxedo CORBA Deployment Environment

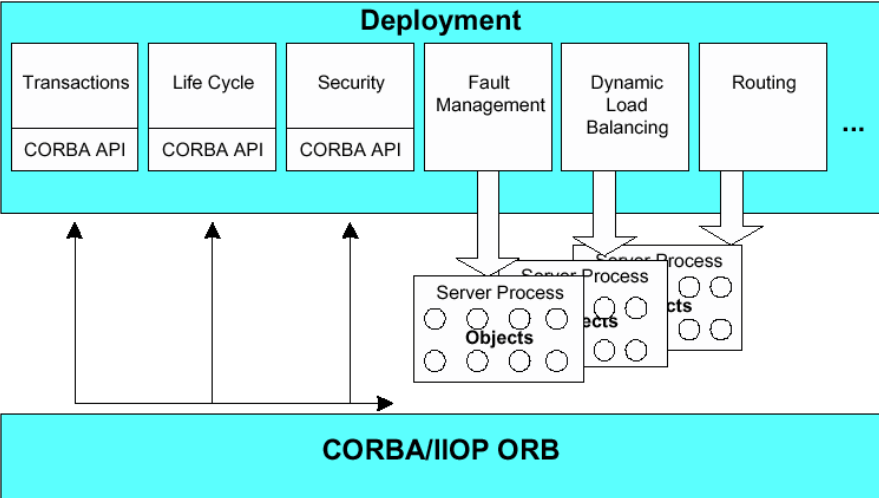

Oracle Tuxedo Product Support and Resources

The following sections describe the documentation and customer-support resources available to Oracle Tuxedo customers:

- [About the Oracle Tuxedo Documentation](#)
- [Using the Oracle Tuxedo Online Documentation](#)

About the Oracle Tuxedo Documentation

The Oracle Tuxedo documentation is designed to provide you, the customer, with information at various levels about the Oracle Tuxedo system. You may want to read all of the documentation or choose only those topics that will provide information for your immediate requirements.

The Oracle Tuxedo documentation consists of the following components:

- Online documentation
- Context-sensitive online help for Oracle Tuxedo GUI-based applications

Oracle Tuxedo Online Documentation

You can find the online documentation at:

<http://www.oracle.com/technology/documentation/index.html>.

Oracle Tuxedo Context-Sensitive Help

The Oracle Tuxedo software includes a set of GUI-based tools designed to help you build and administer your Oracle Tuxedo client and server applications. The following table lists the context-sensitive help components provided with each Oracle Tuxedo software GUI.

Table 4-1 Oracle Tuxedo Context-Sensitive Online Help

Help Component	Description
<i>Oracle Tuxedo Administration Console</i>	Provides help topics that describe how to use the Oracle Tuxedo Administration Console to remotely administer the Oracle Tuxedo system from a Web browser.
<i>Online Help</i>	

Using the Oracle Tuxedo Online Documentation

The Oracle Tuxedo online documentation contains a comprehensive set of documents about the Oracle Tuxedo system. This information is designed to help you:

- Understand the key functionality of the Oracle Tuxedo system
- Design, develop, and deploy mission-critical client/server applications
- Manage your Oracle Tuxedo application resources using the software administration tools provided with the Oracle Tuxedo system

The online documentation provides easy-to-access information in HTML format for viewing in your favorite Web browser.

Note: Microsoft Internet Explorer 6.0 or later is recommended.

To view the online documentation, you need a Web browser that supports HTML 3.0 features, including tables and frames.

Accessing the Documentation in a Browser

To begin viewing the Online Documentation Home page, access Oracle Tuxedo on the e-docs Product Documentation page. From this page you can:

- Browse through each online document
- See what's new in this release

- View a site map of all of the documents and click a graphic to display a document
- Search the entire set of HTML-based documentation using a word or a phrase
- Get a printed copy of each of the major documents by opening and printing an Adobe Acrobat PDF file

Each major topic area is displayed with its own table of contents so that you can see at-a-glance what each document contains.

Once you access the online documentation, you can quickly browse through all of the available information.

Select a topic in the table of contents or click “Oracle Tuxedo Documentation” to return to the Home page.

The online documentation offers many options to access the documentation for the Oracle Tuxedo system. The best way to use the documentation is to bring up the Home page in your browser and start exploring.

If you want a list of other resources and manuals that might be useful in understanding and working with the Oracle Tuxedo system, click Site Map on the Home page, and then click Bibliography on the Site Map page.

Site Map

The site map page lists all the documents in the online information set. The documents are grouped by categories such as Installation, Getting Started, Administration, and Programming.

To open a document, click the document name.

PDF Document Files

The PDF Files page lists all the documents that are available in Adobe Acrobat PDF format. The documents are group by categories such as Installation, Getting Started, Administration, and Programming.

To open a PDF file, click the document name. Once the PDF is displayed you also have the option of printing it.

Using the Online Search Feature

The Oracle Tuxedo online documentation includes a Java search applet, a platform-independent search tool, to assist in locating topics in the Oracle Tuxedo online documentation. The search applet enables you to search for one or more keywords and returns a list of target HTML pages.

When using the search applet, keep these rules in mind:

- Searches are not case sensitive.
- Do not use “quotes” in your query.
- When doing wildcard searches, use the asterisk (*) as a suffix wildcard character in keywords. For example, enter (without quotes) “program*” to find pages with keywords such as program, programmer, or programming.

To perform a search, follow these steps:

1. Click Search in the top navbar. The Search window appears.
2. In the Search field, select the desired search category. If you accept the default, “All Topics,” as the search category, all documents in the online documentation will be searched. Other search categories limit the search to a specific set of documents, such as ATMI or CORBA documents. To see the search category choices, click the Search field drop-down button.
3. Enter the keyword in the Query field and click Find or press Enter on your keypad. The search results appear.
4. If no matches are found, reword your query and try again. If matches are listed, double-click a matched entry; or, highlight the entry and click Show.
5. When the destination page appears, you can enter Ctrl+F to use the browser Find function to locate the keyword on the page.

Learning Paths

To help you find the information you need, the following table lists user tasks and the documentation appropriate to each.

Table 4-2 Learning Paths

If You Want to . . .	You Need . . .	On the Oracle Tuxedo Home Page, Click . . .
Evaluate the product	A high-level overview of the Oracle Tuxedo system.	<ul style="list-style-type: none"> • Product Overview • Interoperability • ATMI Introduction • Getting Started with CORBA Applications
Install the software	Step-by-step procedures for installing and configuring each of the Oracle Tuxedo system components.	<ul style="list-style-type: none"> • Installation • Upgrade Information • Migration Information
Design or architect a system	To know (1) Oracle Tuxedo system capabilities, (2) the benefits these capabilities give you, (3) how to incorporate the benefits of the Oracle Tuxedo system into your design, and (4) how to integrate applications in an Oracle Tuxedo environment.	<ul style="list-style-type: none"> • Interoperability • ATMI Introduction • ATMI and CORBA Programming • System Administration • Reference • ATMI Tutorials • Messages
Write client or server applications	To know how to write, build, configure, and run applications.	The same topics as for design or architect.
Administer the system	To know how to configure, monitor, tune, migrate, and manage the Oracle Tuxedo system.	<ul style="list-style-type: none"> • System Administration • Migration Information • Interoperability

Table 4-2 Learning Paths (Continued)

If You Want to . . .	You Need . . .	On the Oracle Tuxedo Home Page, Click . . .
Learn about using Oracle Jolt with the Oracle Tuxedo system and Oracle WebLogic Server	To know (1) how to configure and integrate Oracle Jolt with Oracle Tuxedo applications so that Tuxedo services are available to customers on the Internet and (2) how to use, configure, and integrate Oracle Jolt to work with the Oracle Tuxedo system and Oracle WebLogic Server.	<ul style="list-style-type: none">• Jolt Documentation
Learn about using Oracle SNMP Agent with the Oracle Tuxedo system	To know how to configure Oracle SNMP Agent to manage Oracle Tuxedo applications.	<ul style="list-style-type: none">• Site Map to Oracle SNMP Agent

Oracle Tuxedo Web-Accessible Services

The following sections present the many ways of making Oracle Tuxedo services available to Web-based applications:

- [What Does Web Accessible Mean?](#)
- [Exposing Tuxedo Services as Web Services](#)
- [Ceasing Tuxedo Services Using a Web Application Server](#)

What Does Web Accessible Mean?

“Web accessible” means making Oracle Tuxedo application services available to Web-based applications. [Figure 5-1](#) illustrates Web client access to Oracle Tuxedo application services.

Figure 5-1 Web Client Access to Oracle Tuxedo Application Services

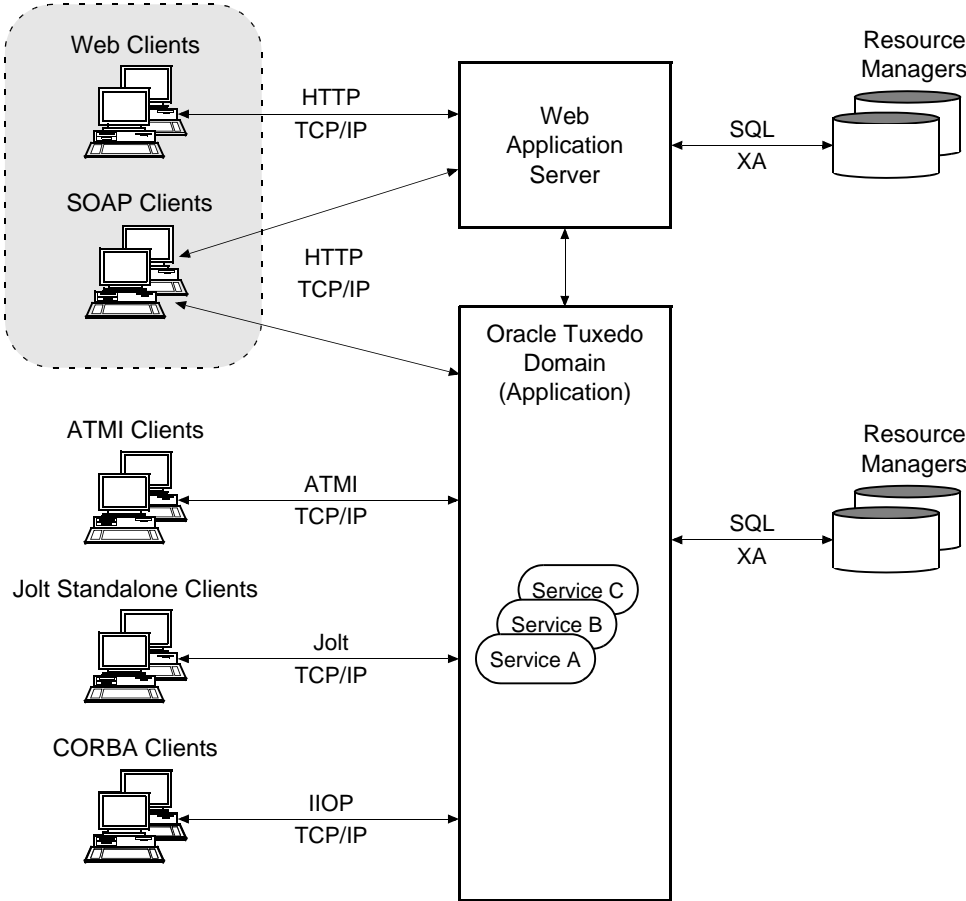

A Web-based client application may be a simple Web client; for example, a Web browser displaying Hypertext Markup Language (HTML) pages to the end users or a Web client with SOAP engine that can initiating Web Service standard requests.

A Web application server may be a Web server or a cross between a Web server and an application server. The standard definition of a *Web server* is “a server software system that serves static content to a Web browser by loading a file from a disk and serving it across the network to a user’s Web browser. This entire exchange is mediated by the browser and server

talking to each other using Hypertext Transfer Protocol (HTTP).” The standard definition of an *application server* is “a server software system that occupies a large chunk of computing territory between database servers and the end user, and often connects the two. An application server is sometimes referred to as a type of middleware.” The Oracle Tuxedo system, itself, is essentially two high-performance application servers, a transaction processing application server and an object application server.

A Web application server serves Web clients one of two types of pages (documents): Hypertext Markup Language (HTML) pages or Extensible Markup Language (XML) pages.

Exposing Tuxedo Services as Web Services

Exposing Tuxedo services as Web services opens the application to the outside world *without any application code changes*. The application can be broken down into smaller modular components, or shared services, that can be shared by and used as components of distributed Web-based applications.

Oracle provides both Tuxedo native solution and Tuxedo-Other Oracle products integrated solution for exposure of Tuxedo Services as Web Services.

Web Services Standards at a Glance

The Web services technologies and programmatic interfaces are being developed by the World Wide Web Consortium (W3C). Web services are based on HTTP and XML as well as the following relatively new XML-based Internet technologies:

- Web Services Description Language (WSDL)

The XML-based language for describing (1) the methods provided by a Web service, (2) the input and output parameters of the Web service, and (3) the instructions for connecting to the Web service. WSDL is the standardized way to describe a Web service to clients so that they can invoke it.

- Simple Object Access Protocol (SOAP)

An XML/HTTP-based protocol for accessing services, objects, and servers in a platform-independent manner. SOAP is the standardized way to transmit data and Web service invocation calls between users and providers of a Web service.

- Universal Description, Discovery, and Integration (UDDI)

A repository that stores descriptions, in a common XML format, about companies and the services they offer. UDDI is the standardized way for client applications to find a registered Web service and to register a Web service on an Internet server.

Web services communicate with clients, both end-user applications and other Web services, through XML messages transmitted by HTTP. Web services can reside on different computers and can be implemented by vastly different technologies, but they are packaged and transported using standard Internet protocols, thus making them easily accessible by any user on the Internet.

For information about the Web services technologies, see *W3C - Web Services Activity* at <http://www.w3.org/2002/ws>.

Exposing Tuxedo Services as Web Services Through Oracle SALT

Oracle Service Architecture Leveraging Tuxedo (SALT) is an add-on product option for Tuxedo, enabling Tuxedo applications to participate in SOA environments. Oracle SALT has two major components: native Web services stack and SCA container.

Oracle SALT allows external Web services applications to invoke Tuxedo services as Web services, and Tuxedo applications to invoke external Web services. Oracle SALT does not require any coding to achieve this. Oracle SALT is a native Tuxedo Web service integration solution.

Oracle SALT complies with most primary Web Services standards: SOAP 1.1, SOAP 1.2, and WSDL 1.1. With Oracle SALT, Tuxedo applications can be easily exposed as Web Services.

[Figure 5-2](#) shows the principal software components comprising Oracle Tuxedo native Web Services solution to expose Tuxedo application services as Web services.

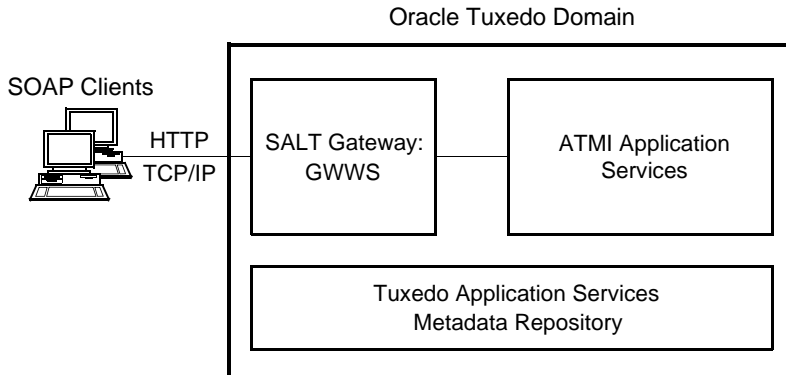
Figure 5-2 Exposing Tuxedo Application Services as Web Services Through Oracle SALT

Oracle SALT is the preferred product for exposing Tuxedo ATMI services as Web services. It reduces Tuxedo/Web Service integration costs and decreases conversion processes that may exist with other solutions for accessing Tuxedo services. It enables seamless connectivity between Tuxedo applications and external Web service applications.

SALT Gateway Server — GWWS

Oracle SALT provided Tuxedo system server (GWWS), connects with other Web service applications via SOAP over HTTP/S protocol. The GWWS server acts as a Tuxedo gateway process and is managed in the same manner as general Tuxedo system servers. Each GWWS server has bi-directional (inbound/outbound) capability. The GWWS server:

- accepts SOAP requests from Web service applications and issue Tuxedo native calls to Tuxedo services.
- accepts Tuxedo ATMI requests and issues SOAP calls to Web Service applications.

SALT Documentation

For more Oracle SALT information, see

<http://www.oracle.com/technology/documentation/index.html>.

Exposing Tuxedo Services as Web Services Through Other Oracle Products

Through Oracle WebLogic Server

The following figure shows the principal software components comprising an Oracle Tuxedo-WebLogic integrated solution to expose Tuxedo application services as Web services.

Figure 5-3 Exposing Tuxedo Application Services as Web Services Through Oracle WebLogic Server

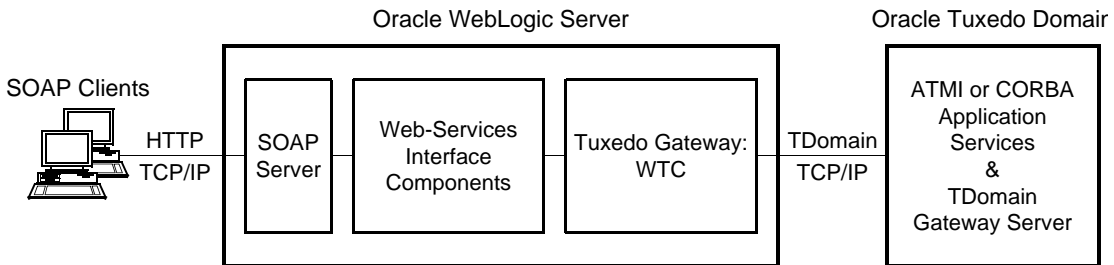

Both Java and non-Java client applications (such as Microsoft .Net Framework clients) can invoke Tuxedo services exposed as Web services through WebLogic Server. The client application assembles a SOAP message describing the Web service it wants to invoke and includes all the necessary data, either in the SOAP body or in a SOAP attachment. The client then sends the SOAP message over HTTP to WebLogic Server, which executes the Web service by performing the following tasks.

1. Calls the associated Tuxedo service via the WTC gateway.
2. Packages the Tuxedo response in a SOAP message.
3. Sends the SOAP message back to the client over HTTP.

Through Oracle AquaLogic Service Bus

The following figure shows the principal software components comprising an Oracle Tuxedo-AquaLogic Service Bus integrated solution to expose Tuxedo application services as Web services.

Figure 5-4 Exposing Tuxedo Application Services as Web Services Through Oracle AquaLogic Service Bus

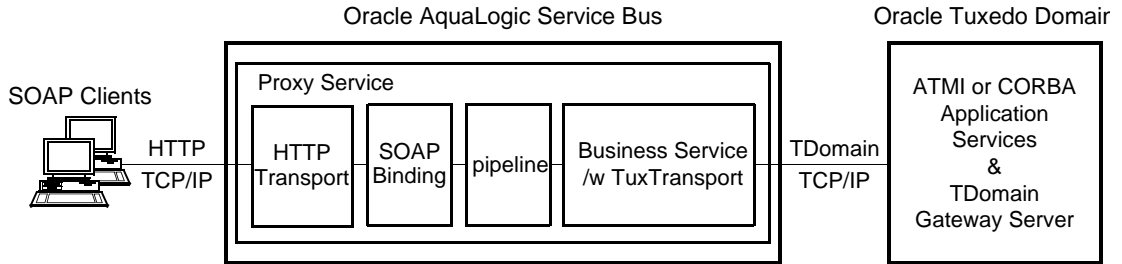

AquaLogic Service Bus is an Enterprise-class service bus that connects, manages, and mediates interactions between heterogeneous services. To connect between SOAP client applications and Tuxedo ATMI services, you should deploy both SOAP connectivity components and Tuxedo domain connectivity components based on AquaLogic architecture.

Ceasing Tuxedo Services Using a Web Application Server

Besides being made available as Web Services, Oracle Tuxedo application services are also made available to Web client programs through a Web application server. Applications embedded in the Web Application Servers can access Tuxedo ATMI services through one of the following approaches:

- [Making Tuxedo Services Web Accessible Through Oracle Jolt](#)
- [Making Tuxedo Services Web Accessible Through Oracle WebLogic Server](#)

Making Tuxedo Services Web Accessible Through Oracle Jolt

Oracle Jolt provides Internet access to Tuxedo ATMI services for both Web-browser and standalone Java clients. Using Jolt, Java programmers can build client applets and applications that remotely invoke existing and new Tuxedo applications, allowing secure, scalable, intranet/Internet transactions between client and server.

Using Jolt, Java programmers can also use HTTP servlets to perform server-side Java tasks in response to HTTP requests. This type of Jolt connectivity enables simple Web clients to access Tuxedo application services through any Web application server that supports generic servlets.

Jolt Class Library

The Jolt class library provides programmers with a set of object-oriented Java language classes for accessing Oracle Tuxedo ATMI services. The class library contains the class files that implement the Jolt API.

Jolt Client Personalities

In addition to Jolt applets and Jolt standalone applications, Oracle Jolt supports the following three types of Jolt client personalities for simple Web clients:

- JSE Connectivity for Oracle Tuxedo
- WebLogic Connectivity for Oracle Tuxedo

JSE Connectivity for Oracle Tuxedo

This Jolt client personality is a Jolt HTTP servlet, running in a Java Web application server environment (for example, Oracle WebLogic Server), through which simple Web-browser clients can invoke Tuxedo ATMI services. Accessing Tuxedo ATMI services in this manner requires the installation of Jolt class packages `jolt.jar` and `joltjse.jar` on the machine running the Web application server.

Figure 5-5 Web Access to Tuxedo Using Jolt JSE Connectivity

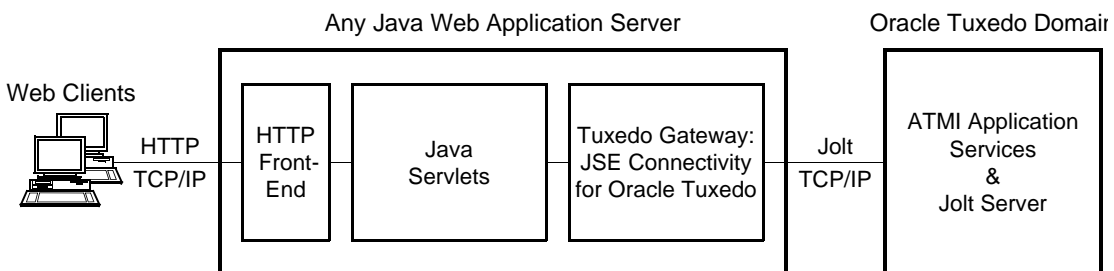

A Jolt HTTP servlet uses Jolt session pool classes to invoke Tuxedo services on behalf of simple browser clients. Thus, the servlet handles all Jolt transactions on the Web server, which enables simple browser clients to invoke Oracle Tuxedo services without directly connecting to the Jolt server and Oracle Tuxedo.

WebLogic Connectivity for Oracle Tuxedo

This Jolt client personality is a customized version of Jolt JSE Connectivity for the Oracle WebLogic Server. Accessing Tuxedo ATMI services in this manner requires the installation of Jolt class packages `jolt.jar`, `joltjse.jar`, and `joltwls.jar` on the machine running Oracle WebLogic Server.

Figure 5-6 Web Access to Tuxedo Using Jolt WebLogic Connectivity

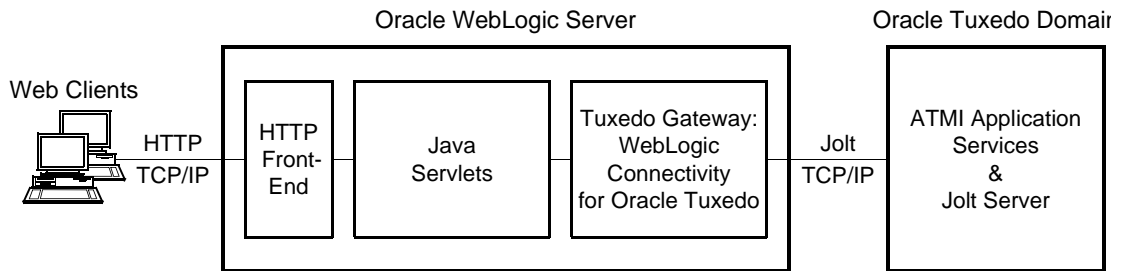

Note: The Jolt client personality “WebLogic Connectivity for Oracle Tuxedo” is also known as “Oracle Jolt for Oracle WebLogic Server.”

Jolt Servers

The Jolt server implementation acts as a proxy for the Jolt client, invoking the Oracle Tuxedo service on behalf of the client. The Jolt server accepts requests from Jolt clients and maps those requests into Oracle Tuxedo service requests.

Jolt Documentation

For information on configuring the Jolt server and the Oracle Tuxedo server to work with Jolt, see [“Oracle Jolt 10g Release 3 \(10.3\) Overview and Installation Information”](#) in *Installing the Oracle Tuxedo System*.

For common client and Web server deployment considerations, see [Using Oracle Jolt](#) and [Using Oracle Jolt with Oracle WebLogic Server](#).

Making Tuxedo Services Web Accessible Through Oracle WebLogic Server

Oracle Tuxedo services have been Web accessible through Oracle WebLogic Server ever since Oracle WebLogic Server release 5.1. The following Oracle Jolt software and Oracle WebLogic Server gateways are central to this accessibility:

- Oracle Jolt for Oracle WebLogic Server—also known as Jolt client personality “WebLogic Connectivity for Oracle Tuxedo”

Enables WebLogic Server 5.1 or later EJBs, JavaServer Pages (JSPs), servlets, and other WebLogic Server application servers to call Tuxedo ATMI services on behalf of WebLogic Server Web-browser clients.

- WebLogic Tuxedo Connector (WTC) gateway

Enables WebLogic Server 6.1 or later applications, such as servlets and other WebLogic Server applications, to call Tuxedo ATMI services or Tuxedo CORBA C++ objects on behalf of WebLogic Server Web-browser clients.

Figure 5-7 Web Access to Tuxedo Using Jolt or WTC

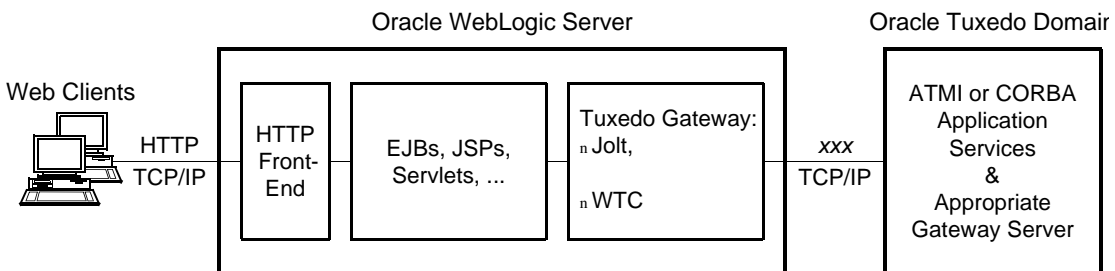

In addition to WTC, there is support for IIOP connections from WebLogic Server (WLS) via the WLS ORB and the Tuxedo ISL.

For details about using Jolt or WTC to achieve interoperability between Oracle Tuxedo and Oracle WebLogic Server, see “[Interoperability with Oracle WebLogic Server](#)” in *Oracle Tuxedo Interoperability*.