

Oracle® Application Integration Architecture

Oracle Lead to Order Integration Pack for Oracle CRM On Demand and Oracle E-Business Suite Implementation Guide

Release 3.1.1

E22284-03

May 2012

Oracle Application Integration Architecture Oracle Lead to Order Integration Pack for Oracle CRM On Demand and Oracle E-Business Suite Implementation Guide, Release 3.1.1

E22284-03

Copyright © 2001, 2012, Oracle and/or its affiliates. All rights reserved.

Primary Author: Oracle Corporation

This software and related documentation are provided under a license agreement containing restrictions on use and disclosure and are protected by intellectual property laws. Except as expressly permitted in your license agreement or allowed by law, you may not use, copy, reproduce, translate, broadcast, modify, license, transmit, distribute, exhibit, perform, publish, or display any part, in any form, or by any means. Reverse engineering, disassembly, or decompilation of this software, unless required by law for interoperability, is prohibited.

The information contained herein is subject to change without notice and is not warranted to be error-free. If you find any errors, please report them to us in writing.

If this is software or related documentation that is delivered to the U.S. Government or anyone licensing it on behalf of the U.S. Government, the following notice is applicable:

U.S. GOVERNMENT RIGHTS Programs, software, databases, and related documentation and technical data delivered to U.S. Government customers are "commercial computer software" or "commercial technical data" pursuant to the applicable Federal Acquisition Regulation and agency-specific supplemental regulations. As such, the use, duplication, disclosure, modification, and adaptation shall be subject to the restrictions and license terms set forth in the applicable Government contract, and, to the extent applicable by the terms of the Government contract, the additional rights set forth in FAR 52.227-19, Commercial Computer Software License (December 2007). Oracle America, Inc., 500 Oracle Parkway, Redwood City, CA 94065.

This software or hardware is developed for general use in a variety of information management applications. It is not developed or intended for use in any inherently dangerous applications, including applications that may create a risk of personal injury. If you use this software or hardware in dangerous applications, then you shall be responsible to take all appropriate fail-safe, backup, redundancy, and other measures to ensure its safe use. Oracle Corporation and its affiliates disclaim any liability for any damages caused by use of this software or hardware in dangerous applications.

Oracle and Java are registered trademarks of Oracle and/or its affiliates. Other names may be trademarks of their respective owners.

Intel and Intel Xeon are trademarks or registered trademarks of Intel Corporation. All SPARC trademarks are used under license and are trademarks or registered trademarks of SPARC International, Inc. AMD, Opteron, the AMD logo, and the AMD Opteron logo are trademarks or registered trademarks of Advanced Micro Devices. UNIX is a registered trademark of The Open Group.

This software or hardware and documentation may provide access to or information on content, products, and services from third parties. Oracle Corporation and its affiliates are not responsible for and expressly disclaim all warranties of any kind with respect to third-party content, products, and services. Oracle Corporation and its affiliates will not be responsible for any loss, costs, or damages incurred due to your access to or use of third-party content, products, or services.

Contents

Preface	xv
Common Oracle AIA Pre-Built Integration Guides	xv
Documentation Accessibility	xv
Additional Resources	xvi
Part I Understanding the Delivered Integrations	
1 Oracle Lead to Order Integration Pack for Oracle CRM On Demand and Oracle E-Business Suite	
Overview	1-1
Business Process Flows	1-2
Solution Assumptions and Constraints	1-5
2 Initial Loading and Synchronization of Data	
Overview	2-1
Batch Loading of Data PL/SQL Script	2-2
GENERATE_EVENTS Procedure	2-2
PURGE_EVENTLOG Procedure	2-3
REGENERATE_EVENT Procedure	2-3
Batch Loading Customer Data	2-3
Understanding the Customer Account Batch Flow Process	2-4
Solution Assumptions and Constraints	2-5
Running the Account Batch Load Process	2-5
Batch Loading Product Data	2-6
Understanding the Product Batch Flow Process	2-7
Solution Assumptions and Constraints	2-8
Running the Product Batch Load Process	2-8
3 Process Integration for Customer Management	
Overview	3-1
Solution Assumptions and Constraints	3-2
Customer Data Synchronization	3-5
Enabling Account Synchronization in CRM On Demand	3-5
Synchronizing Accounts from CRM On Demand to Oracle E-Business Suite	3-7

Synchronizing New Accounts from CRM On Demand to Oracle E-Business Suite	3-7
Synchronizing New Account Integration Flow	3-7
Updating and Synchronizing Accounts from CRM On Demand to Oracle E-Business Suite	3-8
Updating and Synchronizing Account Integration Flow	3-8
Deleting Accounts in CRM On Demand	3-8
Synchronizing New Account-Contacts from CRM On Demand to Oracle E-Business Suite.	3-8
Synchronizing New Account-Contact Integration Flow	3-9
Updating and Synchronizing Account-Contacts from CRM On Demand to Oracle E-Business Suite	3-9
Update and Synchronize Account-Contact Integration Flow	3-9
Deleting Account-Contacts in CRM On Demand	3-9
Synchronizing Accounts from Oracle E-Business Suite to CRM On Demand	3-10
Batch Loading Accounts from Oracle E-Business Suite to CRM On Demand.....	3-10
Synchronizing New Accounts from Oracle E-Business Suite to CRM On Demand	3-10
Synchronize Customer Account Integration Flow	3-11
Merging Accounts from Oracle E-Business Suite to CRM On Demand	3-13
Merge Account Integration Flow	3-14
Merging Parties from Oracle E-Business Suite to CRM On Demand.....	3-16
Merge Party Integration Flow	3-18
Oracle CRM On Demand Interfaces	3-19
Oracle E-Business Suite Interfaces	3-19
Core AIA Components	3-20
Integration Services	3-21
CustomerPartyEBSV2.....	3-22
CustomerPartyResponseEBSV2	3-22
InterfaceCustomerToFulfillmentEBF	3-23
SyncCustomerCRMODProvABCImpl.....	3-23
SyncCustomerPartyListEbizReqABCImpl	3-24
SyncCustomerPartyListEbizProvABCImpl	3-24
MergeAccountEbizReqABCImpl.....	3-24
MergePartyEbizReqABCImpl	3-24
SyncCustomerPartyListEbizEventConsumer	3-24
MergeAccountEbizEventConsumer	3-24
MergePartyEbizEventConsumer	3-25
SyncCustomerPartyListEbizAdapter	3-25
CreateCustomerCRMODReqABCImpl	3-25
UpdateCustomerCRMODReqABCImpl.....	3-25
DeleteCustomerCRMODReqABCImpl.....	3-26
CreateCustomerAddressCRMODReqABCImpl	3-26
UpdateCustomerAddressCRMODReqABCImpl.....	3-26
DeleteCustomerAddressCRMODReqABCImpl.....	3-27
QueryCustomerPartyListCRMODProvABCImpl.....	3-27
ProcessContactCRMODReqABCImpl	3-27
CreateCustomerPartyEbizProvABCImpl.....	3-28
UpdateCustomerPartyEbizProvABCImpl	3-28
TransformAppContextEbizService.....	3-28
QueryResponsibilityEbizAdapter.....	3-28
AIACompositeScheduler	3-28

CRMONDemandIntegrationEventProcessor.....	3-29
---	------

4 Process Integration for Product Management

Overview	4-1
Solution Assumptions and Constraints	4-2
Product Synchronization	4-2
Create Items Flow	4-3
Update Items Integration Flow	4-4
Batchload Items Integration Flow.....	4-6
Oracle CRM On Demand Interfaces	4-6
Oracle E-Business Suite Interfaces	4-6
Core AIA Components	4-6
Integration Services	4-7
ItemEBSV2.....	4-7
CreateProductEbizReqABCImpl	4-8
UpdateProductEbizReqABCImpl.....	4-8
BatchLoadProductEbizReqABCImpl.....	4-8
CreateItemEbizEventConsumer	4-9
UpdateItemEbizEventConsumer.....	4-9
BatchloadItemEbizEventConsumer	4-9

5 Process Integration for Opportunity to Quote and Order Management

Overview	5-1
Solution Assumptions and Constraints	5-3
Create Sales Quote Integration Flow	5-4
Create Sales Order Integration Flow	5-7
Oracle CRM On Demand Interfaces	5-9
Oracle E-Business Suite Interfaces	5-9
Core AIA Components	5-10
Integration Services	5-10
SalesQuoteEBS.....	5-11
SalesQuoteResponseEBS	5-11
SalesQuoteOrchestrationEBS.....	5-12
SalesQuoteOrchestrationResponseEBS.....	5-12
InterfaceSalesQuoteToFulfillmentEBF.....	5-12
InterfaceSalesQuoteToCustomerEBF	5-13
CreateSalesQuoteEbizProvABCImpl	5-13
ProcessSalesQuoteCRMODReqABCImpl	5-13
CRMONDemandPriorityIntegrationEventProcessor	5-13
SalesOrderEBSV2	5-14
SalesOrderResponseEBSV2	5-14
SalesOrderOrchestrationEBSV2.....	5-14
CustomerPartyOrchestrationEBSV2.....	5-15
InterfaceSalesOrderToFulfillmentEBF	5-15
InterfaceSalesOrderToCustomerEBF	5-15
InterfaceCustomerToFulfillmentEBF	5-16

SyncCustomerPartyListEbizProvABCImpl	5-16
QueryCustomerPartyListCRMODProvABCImpl.....	5-16
CreateSalesOrderEbizProvABCImpl	5-16
ProcessSalesOrderCRMODReqABCImpl.....	5-17

Part II Implementing the Delivered Integrations

6 Configuring Oracle Lead to Order Integration Pack for Oracle CRM On Demand and Oracle E-Business Suite

Prerequisites	6-1
Customer Management Prerequisites.....	6-1
Product Management Prerequisites	6-2
Opportunity to Quote and Order Prerequisites	6-2
Data Requirements	6-2
Data Requirements for Customer Management.....	6-2
Data Requirements for Product Management	6-3
Data Requirements for Opportunity to Quote and Order	6-3
Setting Up Oracle E-Business Suite	6-3
Changing the Email Address.....	6-3
Granting Access to the 360 Degree View in Oracle E-Business Suite.....	6-4
Changing the Default Status of New Orders in Oracle E-Business Suite	6-4
Assigning Sales Rep.....	6-5
Creating Oracle E-Business Suite System Profiles	6-5
Setting Up Oracle CRM On Demand	6-6
Implementing the Opportunity to Quote or Order Business Process.....	6-6
Enabling the Order Management Quoting Module	6-6
Enabling the Order or Quote Object in CRM On Demand.....	6-7
Create the Web Link to View Orders or Quotes in Oracle E-Business Suite	6-7
Granting Access to the Quote or Order Applet to User Roles and Users.....	6-9
Displaying Quote or Order Details on a Page	6-10
Setting Up the CRM On Demand Integration User	6-10
Defining an Integration User in CRM On Demand.....	6-10
Updating Integration User Information in CRM On Demand.....	6-11
Creating the Custom Fields Required to Support the Integration.....	6-11
Creating the Integration Status Fields	6-12
Adding Integration Fields to a Page Layout.....	6-13
Configuring the Account-Contact Field	6-14
Mapping Integration Fields for the Lead Conversion.....	6-14
Creating the Web Link for the 360 Degree View	6-15
About Using the Web Link for the 360 Degree View	6-15
Configuring the Web Link for the 360 Degree View	6-16
Configuring AIACompositeScheduler Service.....	6-17
Configuring the Integration Event Queues	6-17
Configuring Integration and Workflow Events in CRM On Demand.....	6-18
Understanding Integration and Workflow Event Configuration.....	6-18
Defining Workflow Rule Conditions	6-22
Creating and Configuring Integration Events	6-23

Setting Up Synchronization Failure Lists	6-23
Setting Up Synchronization Failure Alerts	6-24
Session Management	6-25
Working with Domain Value Maps	6-25
Working with Cross-References	6-26
Handling Errors	6-30
About the Error Handler Service	6-30
CRM On Demand to Oracle E-Business Suite Error Processing Flow	6-30
Setting Up CRM On Demand Error Handler	6-31
About Retryable and Non-Retryable Errors	6-32
Setup Error Notification Roles and Users.....	6-33
Resubmitting Failed Messages in Oracle E-Business Suite.....	6-33
Throttling Oracle E-Business Suite Messages in the 11G Fusion Middleware	6-35
Viewing EIMs.....	6-35
Configuring the Oracle Lead to Order Integration Pack for Oracle CRM On Demand and Oracle E-Business Suite PIP	6-35

7 Configuring and Mapping Custom Fields in Oracle CRM On Demand

Overview.....	7-1
Creating a Custom Field in CRM On Demand	7-1
Adding Custom Fields in CRM On Demand	7-2
Updating the CRM On Demand Schema and WSDL	7-2
Adding the Custom Fields to the Common Utility Query XSL Files.....	7-3
Mapping Custom Fields in the BPEL Process Custom XSL Files	7-4
Mapping the Custom Field in a Provider BPEL Process.....	7-4
Mapping the Custom Field in a Requester BPEL Process.....	7-6
Deploying the BPEL Process After Amending the Custom XSL File	7-7

A Order and Quote Object Definitions

Quote Object	A-1
Methods Called	A-1
Fields	A-1
Order Object.....	A-2
Methods Called	A-2
Fields	A-2

B Attribute Mapping Information

Customer Data Mappings.....	B-1
Product Data Mappings	B-3
Quote Data Mappings	B-4
Order Data Mappings.....	B-5

C Settings for Multi-Org Implementation

Multi-Org Usage at Account Level in CRM On Demand	C-1
When Multi-Org is not Implemented in CRM On Demand at Account Level	C-1

Use Cases for Multi-Org not Implemented in CRM On Demand at Account Level.....	C-1
When Multi-Org is Implemented in CRM On Demand at Account Level.....	C-3
Use Cases for Multi-Org Implemented in CRM On Demand at Account level.....	C-3
Customization for Multi-Org Implementation in CRM On Demand at Account Level	C-5
Populating Initial Data for Cross-References.....	C-5
Setting Up Domain Value Maps.....	C-5
Adding Custom Fields in CRM On Demand	C-7
Assigning Sales Rep	C-9

D Additional Business Event Subscription Setup for Product Sync Events

Setting Up Subscription.....	D-1
------------------------------	-----

List of Examples

2-1	Query for Account Batch Load	2-6
2-2	Script for Account Batch Load Process	2-6
2-3	PL/SQL Filter Clause	2-9
2-4	Script to Load Batches of Product Data	2-9
6-1	Query for JFT Resource profile	6-4
7-1	Tag for Object.wsdl File	7-2
7-2	Account Object Entry	7-3
7-3	XSL File.....	7-3
7-4	Contents for the CustomerEBM_to_AccountABM_Custom.xml File.....	7-4
7-5	CustomerEBM_to_AccountABM_Customer.xml	7-5
7-6	CreateCustomerCRMODABM_To_CreateCustomerPartyEBM_Custom.xml File	7-6
7-7	CreateCustomerCRMODABM_To_CreateCustomerPartyEBM_Custom.xml File	7-7

List of Figures

1-1	High-level Process Integrations	1-2
1-2	Business Process Flow for the Oracle Lead to Order Integration Pack for Oracle CRM On Demand and Oracle E-Business Suite PIP 1-3	
2-1	Batchload Customer Account Flow Sequence Diagram	2-4
2-2	Batch Load Item Flow Sequence Diagram	2-7
3-1	Customer Account Process Integration Flow	3-4
3-2	Synchronize Customer Account Integration Flow.....	3-11
3-3	Synchronize Account Flow Sequence Diagram.....	3-12
3-4	Merge Account Integration Flow.....	3-14
3-5	Merge Account Flow Sequence Diagram	3-15
3-6	Merge Party Integration Flow	3-17
3-7	Merge Party Flow Sequence Diagram	3-18
4-1	Product Management Integration Flow	4-1
4-2	Create Item Flow Sequence Diagram.....	4-3
4-3	Update Items Flow Sequence Diagram	4-5
5-1	Create Sales Quote Integration Flow	5-5
5-2	Create Sales Order Integration Flow.....	5-8
B-1	Customer Account Data Mappings.....	B-3
C-1	CRM On Demand Workflow Configuration	C-8
C-2	Operating Unit Check Box in Admin Tab	C-9

List of Tables

2-1	GENERATE_EVENTS Procedure Parameters.....	2-2
2-2	Structure of the Log Table	2-3
3-1	Communication Type and Purpose for CRM On Demand Telephone Mapping	3-3
3-2	Expected Behavior for Integration Status Changes	3-6
3-3	Synchronization Outcome for Account Merge Process.....	3-14
3-4	Synchronization Outline for Party Merge Process.....	3-17
6-1	Object Field Edit Fields	6-12
6-2	Picklist Values for the Integration Status Field	6-13
6-3	Object Field Edit Fields	6-13
6-4	Object Fields Values	6-13
6-5	Mapping for Integration Status Field.....	6-14
6-6	Account Fields Values.....	6-16
6-7	Workflow Events and Rule Conditions Configuration Fields	6-18
6-8	Workflows and Integration Events Configuration Fields.....	6-19
6-9	DVMs for Oracle Lead to Order Integration Pack for Oracle CRM On Demand and Oracle E-Business Suite	6-25
6-10	Cross-References for Oracle Lead to Order Integration Pack for Oracle CRM On Demand and Oracle E-Business Suite	6-26
6-11	Errors Caused by Oracle Lead to Order Integration Pack for Oracle CRM On Demand and Oracle E-Business Suite	6-30
6-12	Services and Attributes for CRM On Demand	6-32
6-13	Properties for ResubmitBuild.properties field.....	6-34
6-14	System Properties.....	6-36
6-15	Properties for the TransformAppContexEbizService Service	6-36
6-16	Properties for the BatchLoadCustomerPartyListEbizReqABCServiceImpl Service.....	6-37
6-17	Properties for the BatchLoadProductEbizReqABCServiceImpl Service	6-38
6-18	Properties for the CreateProductEbizReqABCServiceImpl Service.....	6-39
6-19	Properties for the UpdateProductEbizReqABCServiceImpl Service	6-40
6-20	Properties for the CreateSalesOrderEbizProvABCServiceImpl Service.....	6-41
6-21	Properties for the InterfaceSalesOrderToFulfillmentEBF Service	6-42
6-22	Properties for the InterfaceSalesOrderToCustomerEBFV2 Service.....	6-44
6-23	Properties for the InterfaceCustomerToFulfillmentEBF Service.....	6-44
6-24	Properties for the SyncCustomerPartyListEbizReqABCServiceImpl Service	6-45
6-25	Properties for the MergeAccountEbizReqABCServiceImpl Service	6-46
6-26	Properties for the MergePartyEbizReqABCServiceImpl Service	6-48
6-27	Properties for the SyncCustomerPartyListEbizProvABCServiceImpl Service.....	6-49
6-28	Properties for the InterfaceSalesQuoteToFulfillmentEBF Service	6-50
6-29	Properties for the CreateCustomerPartyEbizProvABCServiceImpl Service	6-51
6-30	Properties for the UpdateCustomerPartyEbizProvABCServiceImpl Service.....	6-52
6-31	Properties for the InterfaceSalesQuoteToCustomerEBF Service	6-53
6-32	Properties for the CreateSalesQuoteEbizProvABCServiceImpl Service	6-54
7-1	BPEL Processes and XSL Files for Objects.....	7-4
A-1	Methods called by the Quote Service.....	A-1
A-2	Required and Read-only Fields for the Quote Object.....	A-1
A-3	Pick Map Fields for the Quote Object	A-2
A-4	User Key Field for the Quote Object	A-2
A-5	Methods Called by the Order Service	A-2
A-6	Required and Read-only Fields for the Order Object.....	A-2
A-7	Pick Map Fields for the Order Object	A-3
A-8	User Key Field for the Order Object.....	A-3
B-1	Mapped attributes of Customer Records	B-1
B-2	Mapped Attributes of Product Records.....	B-3
B-3	Mapped Attributes of Quote Records.....	B-4

B-4	Mapped Attributes of Order Records	B-6
C-1	Oracle E-Business Suite Data Synched from CRM On Demand.....	C-2
C-2	Data Created in Oracle E-Business Suite	C-2
C-3	CRM On Demand Data Synched from Oracle E-Business Suite.....	C-2
C-4	Account Sites in Oracle E-Business Suite	C-2
C-5	Sample Data Created in CRM On Demand	C-3
C-6	Final Data Synched to Oracle E-Business Suite from CRM On Demand	C-3
C-7	Final Data Synched to Oracle E-Business Suite during Update Process	C-4
C-8	Data Created in Oracle E-Business Suite	C-4
C-9	Final Data Synched to CRM On Demand from Oracle E-Business Suite	C-4

Preface

Welcome to *Oracle Application Integration Architecture Oracle Lead to Order Integration Pack Implementation Guide for Oracle CRM On Demand and Oracle E-Business Suite 3.1.1 Implementation Guide*.

Common Oracle AIA Pre-Built Integration Guides

Oracle Application Integration Architecture Pre-Built Integrations 11.1 includes the following guides shared by all products delivered with this release:

- Oracle Application Integration Architecture Installation and Upgrade Guide for Pre-Built Integrations Release 11.1

This guide provides an overview of the installation process, including how to install, configure, and deploy your pre-built integrations. The steps required to upgrade your pre-built integrations to the latest release are also provided.

- Oracle Application Integration Architecture Pre-Built Integrations 11.1: Utilities Guide

This guide describes:

- How to work with and configure Session Pool Manager (SPM), which is a service in the Oracle SOA Suite web server whose primary function is to manage a pool of web server session tokens that can be reused by BPEL flows.
- How to deploy and configure the AIACompositeScheduler. This is a utility component that is used by pre-built integrations to schedule a service-oriented architecture (SOA) composite to be invoked at the specified time interval.

- Oracle Application Integration Architecture Pre-Built Integrations 11.1: Product-to-Guide Index

The Product-to-Guide index lists the guides that provide information for each product delivered in this release.

Documentation Accessibility

For information about Oracle's commitment to accessibility, visit the Oracle Accessibility Program website at <http://www.oracle.com/pls/topic/lookup?ctx=acc&id=docacc>.

Access to Oracle Support

Oracle customers have access to electronic support through My Oracle Support. For information, visit

<http://www.oracle.com/pls/topic/lookup?ctx=acc&id=info> or visit <http://www.oracle.com/pls/topic/lookup?ctx=acc&id=trs> if you are hearing impaired.

Additional Resources

The following resources are also available:

- **Oracle Application Integration Architecture Foundation Pack:**

Oracle AIA Pre-Built integrations require Foundation Pack 11.1.1.5.0 to be installed. Refer to the Foundation Pack documentation library on OTN to download the Foundation Pack guides at http://download.oracle.com/docs/cd/E21764_01/aia.htm.

- **Oracle Application Integration Architecture: Product-to-Guide Index:**

Oracle Technology Network:
<http://www.oracle.com/technetwork/index.html>

- **Known Issues and Workarounds:**

My Oracle Support: <https://support.oracle.com/>

- **Release Notes:**

Oracle Technology Network:
<http://www.oracle.com/technetwork/index.html>

- **Documentation updates:**

Oracle Technology Network:
<http://www.oracle.com/technetwork/index.html>

Part I

Understanding the Delivered Integrations

This part contains the following chapters:

- [Chapter 1, "Oracle Lead to Order Integration Pack for Oracle CRM On Demand and Oracle E-Business Suite"](#)
- [Chapter 2, "Initial Loading and Synchronization of Data"](#)
- [Chapter 3, "Process Integration for Customer Management"](#)
- [Chapter 4, "Process Integration for Product Management"](#)
- [Chapter 5, "Process Integration for Opportunity to Quote and Order Management"](#)

Oracle Lead to Order Integration Pack for Oracle CRM On Demand and Oracle E-Business Suite

This chapter provides an overview of the Oracle Lead to Order Integration Pack for Oracle CRM On Demand and Oracle E-Business Suite Process Integration Pack (PIP) and includes the following sections:

- [Section 1.1, "Overview"](#)
- [Section 1.2, "Business Process Flows"](#)
- [Section 1.3, "Solution Assumptions and Constraints"](#)

1.1 Overview

The Oracle Lead to Order Integration Pack for Oracle CRM On Demand and Oracle E-Business Suite integrates the Oracle CRM On Demand and Oracle E-Business Suite applications. CRM On Demand provides sales campaign management, mobile sales, and sales analytical features. Oracle E-Business Suite provides inventory, pricing, quoting, and order processing functionality. Integrating these applications provides support for a comprehensive lead-to-order business process across the front and back office.

Users can enter or update account, account-contact, and product information in Oracle E-Business Suite and synchronize that information to CRM On Demand. Users can use this data within CRM On Demand to manage sales leads and opportunities. When the sales cycle progresses to the point at which quotes or sales orders are required, users can initiate either quote or sales order creation from CRM On Demand. These quotes or sales orders are then created and maintained within Oracle E-Business Suite. From CRM On Demand, users can view all of the quote and sales orders that are associated with an account or opportunity that have been created through the integration.

[Figure 1–1](#) illustrates the application that is responsible for each element in the Oracle Lead to Order Integration Pack for Oracle CRM On Demand and Oracle E-Business Suite PIP and illustrates the integration points between the systems:

Figure 1–1 High-level Process Integrations

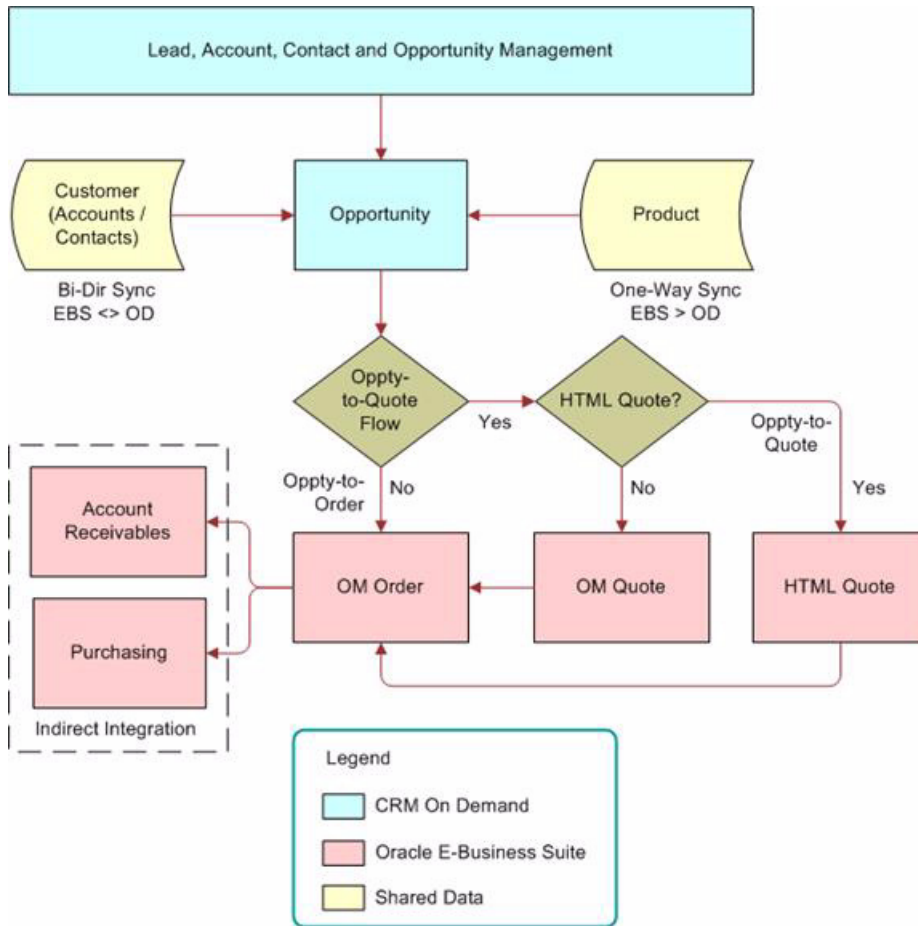

1.2 Business Process Flows

The Oracle Lead to Order Integration Pack for Oracle CRM On Demand and Oracle E-Business Suite PIP comprises the following integration flows:

- Batch data loading integration flows for account, account-contact, and product data
- Customer data management
- Product data management
- Opportunity (quote and order) processing

Figure 1–2 illustrates key business process flows that are delivered as part of the integration:

Figure 1–2 Business Process Flow for the Oracle Lead to Order Integration Pack for Oracle CRM On Demand and Oracle E-Business Suite PIP

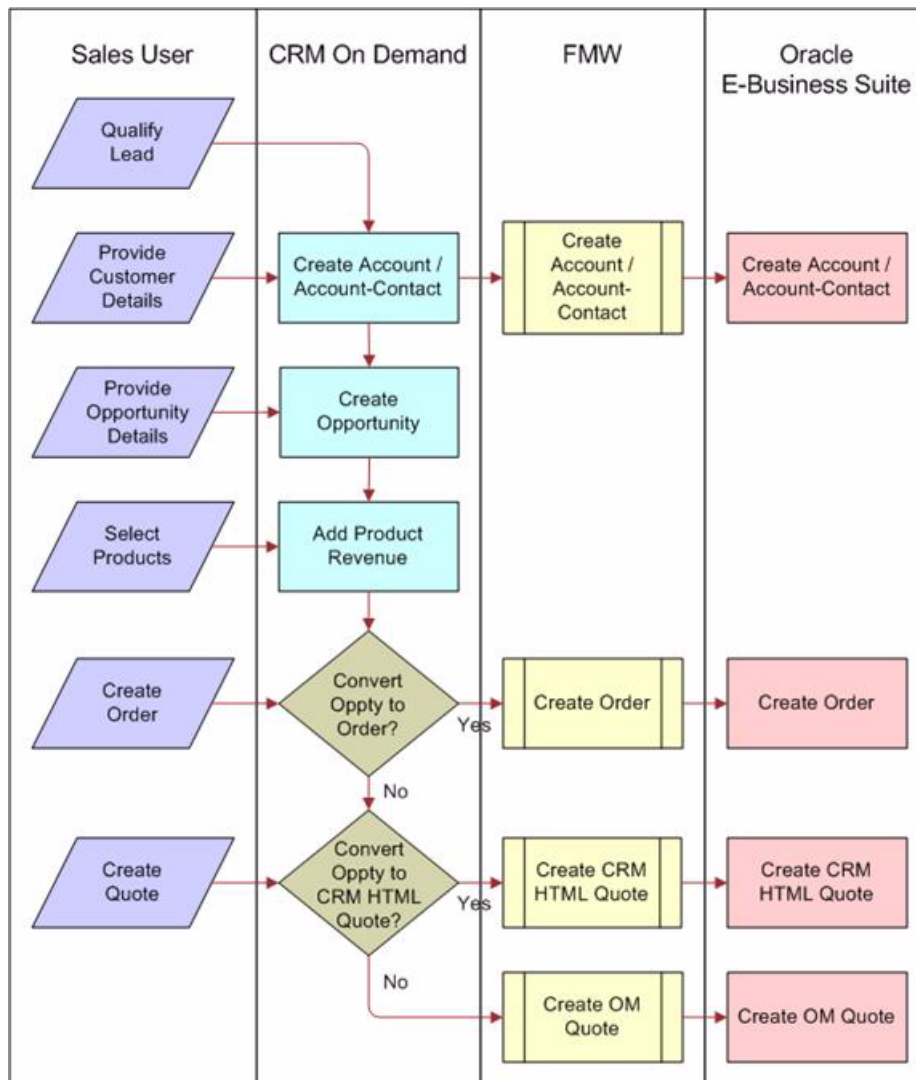

Using the process integrations in this PIP, you can:

- Batch load account information from Oracle E-Business Suite to CRM On Demand.
This master data flow enables users to batch load customer data (accounts, account addresses, and account-contacts) from Oracle E-Business Suite into the CRM On Demand database. This is a unidirectional process flow from Oracle E-Business Suite to CRM On Demand, typically run upon initial deployment.
- Create, update, and synchronize account information from Oracle E-Business Suite to CRM On Demand.
This is transactional flow that enables users to create and update account information in either Oracle E-Business Suite or CRM On Demand and to synchronize those changes so that account data is synchronized in both systems. This is a bidirectional flow between the two systems, run in near real time.
- Batch load product information from Oracle E-Business Suite to CRM On Demand.

This is a master data flow that enables users to batch load product data from the Oracle E-Business Suite database into the CRM On Demand database. This is a unidirectional process flow from Oracle E-Business Suite to CRM On Demand, typically run upon initial deployment.

- Create, update, and synchronize product information in Oracle E-Business Suite and synchronize the data with CRM On Demand.

This transactional flow enables users to create and update product information in Oracle E-Business Suite and synchronize those changes to CRM On Demand. This is a unidirectional process flow from Oracle E-Business Suite to CRM On Demand. Changes to product information in CRM On Demand are not synchronized with Oracle E-Business Suite.

- Generate sales quotes or sales orders in Oracle E-Business Suite that are based on sales opportunities in CRM On Demand.

This transactional flow enables users to create either a sales quote, based on the Oracle CRM HTML Quoting Module or the Order Management Sales Quote module, or an Order Management sales order based on the details within a CRM on Demand opportunity.

These are the typical business scenarios that are related to the integration flows provided in the Oracle Lead to Order Integration Pack for Oracle CRM On Demand and Oracle E-Business Suite PIP:

Note: Actual business processes vary for each implementation according to your specific business requirements.

1. The user enters a lead into CRM On Demand.

Users can enter leads manually, or the leads are created as the result of a campaign in CRM On Demand.

2. The lead is qualified and converted to an opportunity in CRM On Demand and an account and account-contact is created.

When a user converts a lead to an opportunity, an account record must exist in CRM On Demand. If the account record does not exist, CRM On Demand creates the record. If the account is created at this point and the record is enabled for synchronization, the details associated with that account are created in both CRM On Demand and in Oracle E-Business Suite. Changes made to the account records in either system are synchronized bidirectionally to ensure that the two systems are accurate from this point forward.

Note: Only CRM On Demand contacts that are associated with an account that has been synchronized previously are eligible for synchronization to Oracle E-Business Suite.

3. As the sales cycle continues, users can associate products with a sales opportunity.

Users can select from a list of orderable products that have been loaded or synchronized from Oracle E-Business Suite into CRM On Demand to be added as product revenue lines on the opportunity. Product information is maintained in Oracle E-Business Suite and synchronized to CRM On Demand.

4. Users can generate either a quote or a sales order in the Oracle E-Business Suite directly from the CRM On Demand sales opportunity. (The quote in Oracle E-Business Suite can later be converted into a sales order.)

Note: You can deploy either the Opportunity-to-Quote or the Opportunity-to-Order business flow in a single deployment, but not both.

Users create the quote or order using the account and product information that is stored in the CRM On Demand opportunity record. The relevant quote or order details are stored and maintained in Oracle E-Business Suite. Product details for the quote or order, such as product pricing and availability, are determined by the respective Oracle E-Business Suite modules.

5. Users can view quotes and orders associated with an account or opportunity and their details from within CRM On Demand. The quote and order details are made available to the users through a web link that takes them to the related Oracle E-Business Suite page.
6. Users can access a 360-degree view of an account from within CRM On Demand using a web link that the administrator defines on the Account detail page. The web link launches the Oracle E-Business Suite Customers Online Transaction View page, which displays several Oracle E-Business Suite back-office transactions for an account, for example, invoices, orders, quotes, service requests, and so on.

For more information about creating web links in CRM On Demand, see the *CRM On Demand Online Help*. For information about configuring the web link for the 360 Degree view, see "Creating the Web Link for the 360 Degree View."

1.3 Solution Assumptions and Constraints

These are the solution assumptions and constraints:

1. Oracle E-Business Suite and the interfacing modules within it, that is, Oracle Order Management, Oracle CRM HTML Quoting, Oracle Inventory, and Customer modules, are operational and configured before you deploy the Oracle Lead to Order Integration Pack for Oracle CRM On Demand and Oracle E-Business Suite PIP.

Note: References in this guide to the Oracle CRM HTML Quoting module refer to the Oracle CRM Quoting module. The Oracle CRM Quoting module supports a form and an HTML user interface. In the Oracle Lead to Order Integration Pack for Oracle CRM On Demand and Oracle E-Business Suite PIP, only the HTML user interface is supported.

2. Customer and product data that is to be loaded into Oracle CRM On Demand must be rationalized with existing data. Ensure duplicate data is consolidated; this might require a manual review of the data before the initial loading of data.

Initial Loading and Synchronization of Data

This chapter provides an overview of batch data loads and synchronization and includes the following sections:

- [Section 2.1, "Overview"](#)
- [Section 2.2, "Batch Loading of Data PL/SQL Script"](#)
- [Section 2.3, "Batch Loading Customer Data"](#)
- [Section 2.4, "Batch Loading Product Data"](#)

2.1 Overview

The Oracle CRM On Demand Integration Pack for Oracle E-Business Suite Process Integration Pack (PIP) integrates customer data (account, account-address, and account-contact) and product information between Oracle CRM On Demand and Oracle E-Business Suite. This requires that you initially load data from Oracle E-Business Suite into CRM On-Demand, and that the data in the two systems is continuously synchronized. The Oracle Lead to Order Integration Pack for Oracle CRM On Demand and Oracle E-Business Suite PIP enables you to:

- Load the Oracle E-Business Suite customer and product data to be synchronized between Oracle E-Business Suite and CRM On Demand.
- Establish a cross-reference between the synchronized entities.
- Synchronize changes to the data that exists in both databases after the initial load is complete.

Batch loading of business data is a one-way process that loads data from Oracle E-Business Suite into CRM On Demand. To make use of customer and product data that exists in your Oracle E-Business Suite, Oracle recommends that you plan an initial data load strategy.

To load large amounts of data, Oracle recommends that you identify and load the data that is to be used by the integration in priority sequence. Extract and load the data into CRM On Demand in several batches, based on the time allotted for initial data loads.

To batch load data from Oracle E-Business Suite to CRM On Demand, you must run a batch load PL/SQL script supplied with the PIP to generate batch load events. These events are then processed by the integration flows for batch loading account data and batch loading product data.

2.2 Batch Loading of Data PL/SQL Script

This topic describes the PL/SQL script that you use to perform the initial batch load of data from Oracle E-Business Suite to CRM On Demand. You must run a separate script for the batch load of customer and product data.

The PL/SQL script includes these procedures:

- GENERATE_EVENTS
- PURGE_EVENTLOG
- REGENERATE_EVENT

2.2.1 GENERATE_EVENTS Procedure

Two GENERATE_EVENTS procedures are provided with the Oracle Lead to Order Integration Pack for Oracle CRM On Demand and Oracle E-Business Suite PIP:

- HZ_EBI_CUST_LOAD.GENERATE_EVENTS
Use to perform the batch load and synchronization of account and account-contact data from Oracle E-Business Suite to CRM On Demand.
- EGO_EBI_ITEM_LOAD.GENERATE_EVENTS
Use to perform the batch load and synchronization of product data from Oracle E-Business Suite to CRM On Demand.

You must run the GENERATE_EVENTS procedure to generate events for the customer or product data to be loaded during the initial batch load. The script uses filter criteria (which can be customized) to identify the records to be loaded, then generates a business event for each set of records as determined by the batch size. When each event is generated, the event ID and the primary keys of the processed records are logged to a log table. The subscriber, created during the installation of the Oracle Lead to Order Integration Pack for Oracle CRM On Demand and Oracle E-Business Suite PIP, retrieves the records using the provided Application Program Interface (API) or view using the event ID. The log table is also used to filter out records that are processed in case the script must be restarted.

The GENERATE_EVENTS procedure accepts the parameters listed in [Section 2-1, "GENERATE_EVENTS Procedure Parameters"](#):

Table 2-1 GENERATE_EVENTS Procedure Parameters

Parameter	Value	Description
BatchSize	Number	Specify the number of records to include in each batch event. Because CRM On Demand can process a maximum of 20 records in a batch, do not specify a batch size greater than 20. The default batch size is also 20.
MaxEvents number	Number	Specify the maximum number of batch events to generate. If a value is not specified, events are raised until all records returned by the query are processed.

When you run the GENERATE_EVENTS procedure for the first time, all the eligible item IDs are entered into a log file (EGO_EBI_ITEM_LOAD_LOG for products or HZ_EBI_CUST_LOAD_LOG for accounts) and the number of events specified in the Max_Events parameter are generated. Each event contains the number of items specified by the Batch_Size parameter. If you limit the number of events generated by specifying a value for the Max_Events parameter, the X_ERR_MSG indicates the number of events raised and whether any items are pending in the log file. If records are pending in the event table, run the appropriate GENERATE_EVENTS procedure again after allowing sufficient time for the raised events to be consumed successfully.

2.2.2 PURGE_EVENTLOG Procedure

A separate log table is created the first time the initial load script is run for the accounts or products batch load. The table can be deleted after the initial load is complete. However, to use the batch load process for any future bulk load of account or product data, do not delete the log table; instead, run the PURGE_EVENTLOG procedure after the initial batch load is completed. You can also run this procedure to restart the batch load from the beginning.

Table 2–2 lists the structure of the log table:

Table 2–2 Structure of the Log Table

Name	Description
Key column(s)	It stores the primary key of the top-level entity. The column names match the name of the entity. A unique index is created for these columns.
Event-Id	It is ID of the event that was raised for this entity. Because multiple entities are included in each event, this is not unique.

Each row in the log table represents one entity record. The keys for all the records included in an initial load are inserted at the front of the log table. As each event is raised, the event ID column is populated for the processed records.

2.2.3 REGENERATE_EVENT Procedure

The REGENERATE_EVENT procedure is provided for error handling. Each event contains a batch of product or account records. CRM On Demand synchronizes all the records in each batch or none. If a batch fails to synchronize to CRM On Demand, either because of a record-level error or because of a system error, use the REGENERATE_EVENT procedure to resubmit the event and synchronize all the records again. To modify the batch, for example, by removing a product or account record that is causing an error, inactivate the record before running the REGENERATE_EVENT procedure. A new event is created that does not include the inactivated record.

2.3 Batch Loading Customer Data

This section provides an overview of customer data load and synchronization and discusses how to batch load and synchronize customer data.

The Oracle Lead to Order Integration Pack for Oracle CRM On Demand and Oracle E-Business Suite PIP provides a single, consistent, and accurate view of a customer account across the CRM On Demand and Oracle E-Business Suite applications.

Because customer data is entered, managed, and maintained in both CRM On Demand and Oracle E-Business Suite, you must initially load and synchronize existing customer data from Oracle E-Business Suite to CRM On Demand; subsequent updates to mapped attributes are then synchronized in near real time, bidirectionally.

The integration supports the initial load of customer data from Oracle E-Business Suite to CRM On Demand, but not the other way around. When you begin to deploy the integration, you must evaluate whether to load your existing customer data from within your Oracle E-Business Suite deployment to your CRM On Demand deployment. You might require only that a subset of your customer data that exists in Oracle E-Business Suite is represented in CRM On Demand, or you might choose to have all of your customer data represented in both systems.

The Oracle Lead to Order Integration Pack for Oracle CRM On Demand and Oracle E-Business Suite PIP enables you to define and extract a specific set of customer data, which includes accounts, account-contacts, and account-addresses, from Oracle E-Business Suite and to load that subset of data into CRM On Demand. You can review the number of records to be loaded before performing the load into CRM On Demand. Organize and load data based on the priority in which the data is used by end users and the time available for data load.

2.3.1 Understanding the Customer Account Batch Flow Process

The Batchload Customer Account Integration flow uses these interfaces:

- BatchLoadCustomerPartyListEbizEventConsumer
- BatchLoadCustomerPartyListEbizAdapter
- BatchLoadCustomerPartyListEbizReqABCImpl
- CustomerPartyOracleEBSV2
- SyncCustomerCRMODProvABCImpl

Figure 2–1 illustrates the flow for synchronizing accounts between Oracle E-Business Suite and CRM On Demand:

Figure 2–1 Batchload Customer Account Flow Sequence Diagram

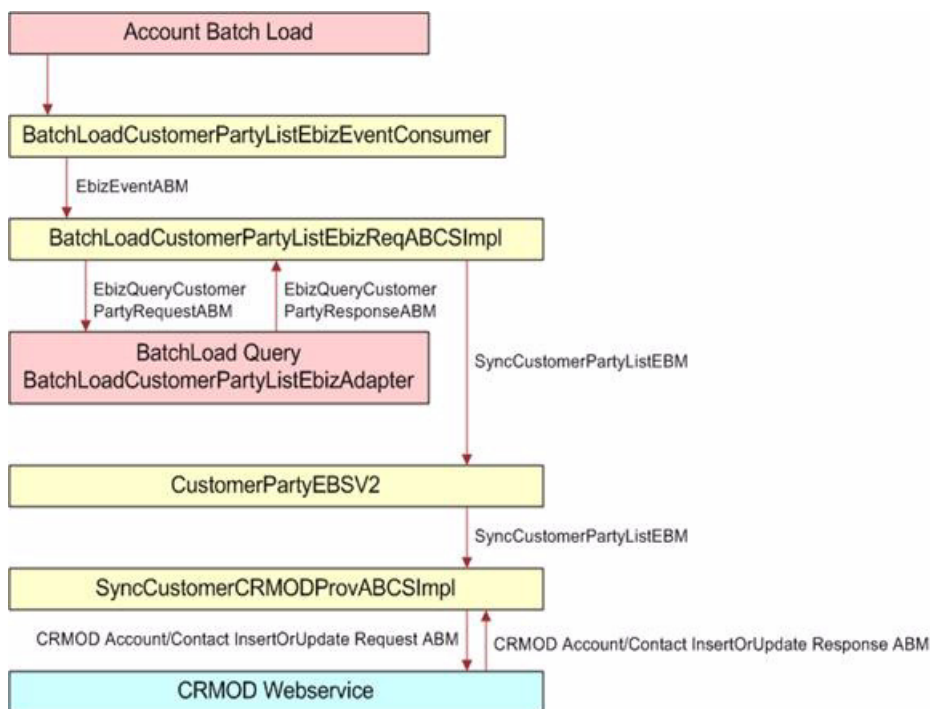

The Batchload Customer Account process comprises these events:

1. You initiate the Batchload Account process by launching the SQL script to run the procedure `HZ_EBI_CUST_LOAD.GENERATE_EVENTS`, which generates the batch load event.
2. The `BatchLoadCustomerPartyListEbizEventConsumer` retrieves the event payload from the queue and routes the request to the `BatchLoadCustomerPartyListEbizReqABCImpl` service.

3. The event payload received by the BatchLoadCustomerPartyListEbizReqABCImpl contains only the event identifier, not the entire account detail.

Therefore, account details must be fetched from Oracle E-Business Suite based on the event ID using the Query Apps adapters, BatchLoadCustomerPartyListEbizAdapter.

4. The Query adapters BatchLoadCustomerPartyListEbizAdapter query the Oracle E-Business Suite database with the EbizQueryCustomerPartyRequestABM and fetch the account payload corresponding to the event ID, which is the EbizQueryCustomerPartyResponseABM.
5. In the BatchLoadCustomerPartyListEbizReqABCImpl, the QueryResponseABM is transformed into the SyncCustomerPartyListEBM, and the SyncCustomerPartyList operation of the CustomerPartyEBSV2 is invoked with this Enterprise Business Message (EBM).
6. The CustomerPartyEBSV2 routes the SyncCustomerPartyListEBM to the SyncCustomerCRMODProvABCImpl.

In this service, the SyncCustomerPartyListEBM is transformed into the SiebelAccountUpsertRequestABM, and the Siebel web service for account creation or update is invoked.

7. The CRM On Demand Account/Contact InsertOrUpdate web service does the actual creation or update of the account, address, and account-contact in CRM On Demand and returns the appropriate response, CRMODAccount/ContactInsertOrUpdateResponseABM.

This response is received by the SyncCustomerCRMODProvABCImpl service.

8. In the SyncCustomerCRMODProvABCImpl service, the CRMODAccount/ContactInsertOrUpdateResponseABM is transformed into the SyncCustomerPartyListResponseEBM, during which the cross-reference data is updated with the CRM On Demand identifiers, and then the flow ends without sending a response back to Oracle E-Business Suite.

2.3.2 Solution Assumptions and Constraints

1. A customer in Oracle E-Business Suite is defined as an organization party with an associated account.
2. Before running the batch data loads, you must run the HZ_EBI_CUST_LOAD.GENERATE_EVENTS procedure to generate the batch load events.

The procedure selects all active accounts. To select only a subset of the accounts for batch data load, you must modify the PL/SQL filter clause in the HZ_EBI_CUST_LOAD.GENERATE_EVENTS PL SQL procedure.

3. The batch size specified for the HZ_EBI_CUST_LOAD.GENERATE_EVENTS procedure must not be greater than 20, a limitation imposed by the batch size supported within CRM On Demand.

2.3.3 Running the Account Batch Load Process

To run the account batch load:

1. Run the HZ_EBI_CUST_LOAD.GENERATE_EVENTS procedure, specifying values for the Batch_Size and Max_Events parameters.

All active accounts are selected by default.

To select a subset of accounts for the account batch load, modify the query in [Example 2-1](#) within the procedure, then recompile the procedure before running it:

Example 2-1 Query for Account Batch Load

```
Select distinct party.PARTY_ID, NULL
from HZ_PARTIES party, HZ_CUST_ACCOUNTS acct
where acct.status='A' and party.PARTY_ID = acct.party_id;
```

When you run the HZ_EBI_CUST_LOAD.GENERATE_EVENTS procedure for the first time, all the active party_id (customer_id) records are loaded into the HZ_EBI_CUST_LOAD_LOG file and the number of events specified by the Max_Events parameter is generated. Each event contains the number of account records specified by the Batch_Size parameter.

2. After all the events are raised and consumed successfully, you can run the HZ_EBI_CUST_LOAD.PURGE_EVENTLOG to purge all the records from the HZ_EBI_CUST_LOAD_LOG safely.

[Example 2-2](#) illustrates the script provided with the Oracle Lead to Order Integration Pack for Oracle CRM On Demand and Oracle E-Business Suite PIP for the account batch load process:

Example 2-2 Script for Account Batch Load Process

```
DECLARE
l_BATCH_SIZE NUMBER;
l_MAX_EVENTS NUMBER;
X_ERR_MSG VARCHAR2 (200);
BEGIN
l_BATCH_SIZE := 20;
l_MAX_EVENTS := 50;
X_ERR_MSG := NULL;
HZ_EBI_CUST_LOAD.GENERATE_EVENTS (
p_batch_size => l_BATCH_SIZE,
p_max_events => l_MAX_EVENTS,
X_ERR_MSG => X_ERR_MSG
);
END;
```

2.4 Batch Loading Product Data

This topic provides an overview of product data load and synchronization and discusses how to perform the initial batch load of product data.

The Oracle Lead to Order Integration Pack for Oracle CRM On Demand and Oracle E-Business Suite PIP provides product data integration between Oracle E-Business Suite and Oracle CRM On Demand to facilitate the Opportunity to Quote and Opportunity to Order business processes and to enable users to view available products from within CRM On Demand. After the product data is loaded into CRM On Demand, subsequent updates to mapped product attributes made within Oracle E-Business Suite propagate to CRM On Demand, but not the other way around from CRM On Demand to Oracle E-Business Suite.

If you plan to enable the Opportunity-to-Quote or Opportunity-to-Order integration business flows, having the product data from Oracle E-Business Suite represented within CRM On Demand is a required step. You might require that only a subset of the

product data that exists in Oracle E-Business Suite be represented in CRM On Demand, or you might want to represent all your product data in both systems.

This PIP enables you to define and extract a specific set of product data from Oracle E-Business Suite and provide a means to have that data loaded into CRM On Demand. If you have large data volumes to be extracted and loaded from Oracle E-Business Suite to CRM On Demand, you can analyze the data to be loaded and can segment the data to be loaded in batches, depending on the time you have allocated to complete the load. Data should be organized and loaded based on the priority in which the data is used by end users.

2.4.1 Understanding the Product Batch Flow Process

Figure 2–2 illustrates the flow for synchronizing product data between Oracle E-Business Suite and CRM On Demand:

Figure 2–2 Batch Load Item Flow Sequence Diagram

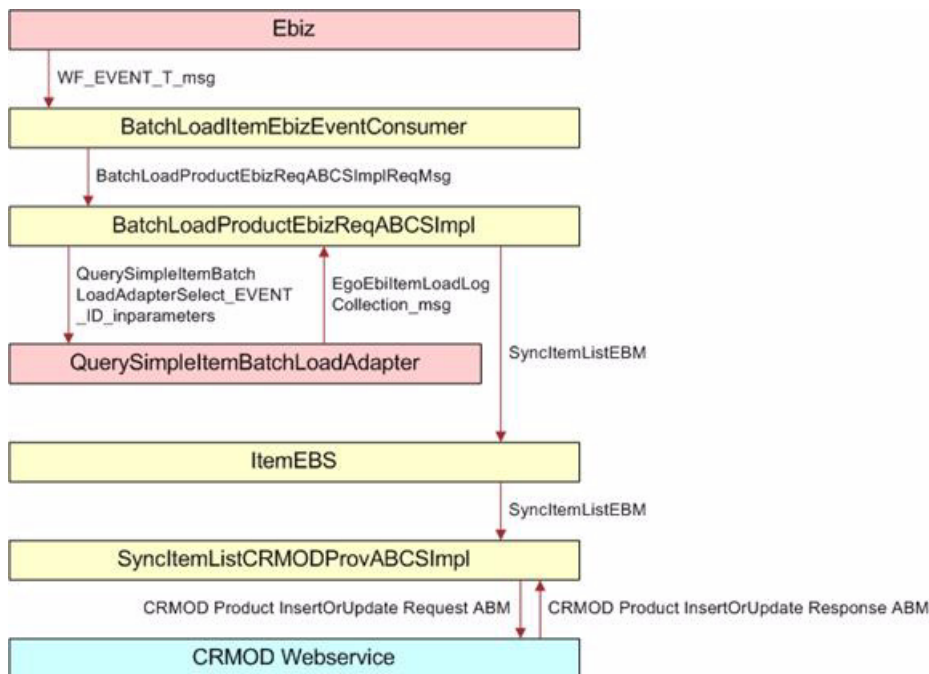

When you initiate the product batch load process, the following events occur:

1. The `BatchLoadItemEbizEventConsumer` listens to business events and receives the `WF_EVENT_T_message` event payload for the batch itemLoad event.

The `BatchLoadItemEbizEventConsumer` routes the complete event payload to `BatchLoadProductEbizReqABCImpl`.
2. The `BatchLoadProductEbizReqABCImpl` service calls the Enterprise Business Service (EBS) based on the event payload, and then transforms to the `SyncItemListEBM` and invokes the `ItemEBSV2` with operation `SyncItemList`.
 - a. As part of the enrichment process, the `BatchLoadProductEbizReqABCImpl` queries the `EGO_ITEM_SYNC_OP_V` view object through the Oracle E-Business Suite adapter `QuerySimpleItemBatchLoadAdapter` based on the event payload to get the `EgoItemSyncOpVCollection_msg`.

- b. As part of the transformation process, the BatchLoadProductEbizReqABCImpl transforms the EgoItemSyncOpVCollection_msg message into the SyncItemListEBM.
 - c. SyncItemListEBM invokes the ItemEBSV2 with the operation SyncItemList. The ItemEBSV2 is a routing service with several operations on the Item Enterprise Business Message (EBM).
 - d. In the process, the cross-reference is created by concatenation of the inventory item ID, organization ID, and operating unit.
3. The ItemEBSV2 routes the SyncItemListEBM to the SyncItemListCRMODProvABCImpl.
4. The SyncItemListCRMODProvABCImpl transforms the SyncItemListEBM to the CRM On Demand product message and then calls the CRM On Demand product Upsert web service to synchronize the product.

The CRM On Demand web service completes the request and returns a response message. In the process, the cross-reference is linked to the CRM On Demand IDs of the product.

2.4.2 Solution Assumptions and Constraints

1. Before running the batch data loads, you must run the EGO_EBI_ITEM_LOAD.GENERATE_EVENTS procedure to generate the batchload events.

The procedure selects all active products for a given organization from Oracle E-Business Suite. To select only a subset of the products in Oracle E-Business Suite for batch data load, you must modify the PL/SQL filter clause in the GENERATE_EVENTS procedure.
2. To synchronize products from multiple organizations, you must run the procedure for each organization individually.

You must run the EGO_EBI_ITEM_LOAD.PURGE_EVENTLOG procedure after synchronizing all the products from one organization and before synchronizing the next organization.
3. The batch size specified for the EGO_EBI_ITEM_LOAD.GENERATE_EVENTS procedure must not be greater than 20.
4. Only orderable products from the Inventory Validation organization are synchronized.

2.4.3 Running the Product Batch Load Process

This topic describes how to perform the product batch load.

To run the product batch load:

1. Run the EGO_EBI_ITEM_LOAD.GENERATE_EVENTS procedure once for each organization for which you want to synchronize product data from Oracle E-Business Suite to CRM On Demand, specifying values for the BatchSize and MaxEvents parameters.

All active products for a given organization from Oracle E-Business Suite are selected.
2. To select a subset of the products in an organization for batch data load, modify the PL/SQL filter clause shown in [Example 2-3](#) in the EGO_EBI_ITEM_LOAD.GENERATE_EVENTS procedure:

Example 2-3 PL/SQL Filter Clause

```

SELECT INVENTORY_ITEM_ID, ORGANIZATION_ID, NULL
FROM MTL_SYSTEM_ITEMS_B
WHERE ORGANIZATION_ID = p_organization_id
AND bom_item_type in (1, 2, 4)
AND customer_order_flag = 'Y'
AND customer_order_enabled_flag = 'Y';

```

The procedure publishes items from the organization provided in the parameter `p_organization_id`. The `p_organization_id` is the ID of the inventory validation organization.

When you run the `EGO_EBI_ITEM_LOAD.GENERATE_EVENTS` procedure for the first time, all the eligible item IDs are entered into the `EGO_EBI_ITEM_LOAD_LOG` file and the number of events specified in the `Max_Events` parameter are generated. Each event contains the number of items specified by the `Batch_Size` parameter.

3. After all the events are raised and consumed successfully, run the `EGO_EBI_ITEM_LOAD.PURGE_EVENTLOG` procedure to purge all the records from the `EGO_EBI_ITEM_LOAD_LOG`.
4. To publish items from another organization, repeat steps 1 through 3.

You can use the script in [Example 2-4](#) for loading batches of product data. Copy the script and edit as appropriate for your implementation:

Example 2-4 Script to Load Batches of Product Data

```

DECLARE
l_BATCH_SIZE NUMBER; l_MAX_EVENTS NUMBER; l_ERR_MSG VARCHAR2(200); p_org_id
NUMBER;
BEGIN
l_BATCH_SIZE := 20; l_MAX_EVENTS := 50; l_ERR_MSG := NULL; p_org_id := 204;
EGO_EBI_ITEM_LOAD.GENERATE_EVENTS (
p_organization_id=> p_org_id, p_batch_size => l_BATCH_SIZE, p_max_events => l_MAX_
EVENTS, X_ERR_MSG => l_ERR_MSG
); END;

```

Process Integration for Customer Management

This chapter provides an overview of customer management process integration and includes the following sections:

- [Section 3.1, "Overview"](#)
- [Section 3.2, "Customer Data Synchronization"](#)
- [Section 3.3, "Synchronizing Accounts from CRM On Demand to Oracle E-Business Suite"](#)
- [Section 3.4, "Synchronizing Accounts from Oracle E-Business Suite to CRM On Demand"](#)
- [Section 3.5, "Oracle CRM On Demand Interfaces"](#)
- [Section 3.6, "Oracle E-Business Suite Interfaces"](#)
- [Section 3.7, "Core AIA Components"](#)
- [Section 3.8, "Integration Services"](#)

3.1 Overview

The process integration for customer account management between Oracle E-Business Suite and CRM On Demand supports these integration flows:

- **Batch load account data**

This flow enables the extract, transformation, and initial load of account data from Oracle E-Business Suite to CRM On Demand. This process also establishes the cross-reference of account data between Oracle E-Business Suite and CRM On Demand.
- **Synchronize accounts from Oracle E-Business Suite to CRM On Demand**

This flow enables the synchronization of accounts from Oracle E-Business Suite to CRM On Demand. When an account is created or updated in Oracle E-Business Suite, the account details, such as addresses, contacts, and phone and fax information, are synchronized to CRM On Demand.
- **Synchronize accounts from CRM On Demand to Oracle E-Business Suite**

This flow enables the synchronization of customer accounts from CRM On Demand to Oracle E-Business Suite. When a new account is created in CRM On Demand that is marked for synchronization, that is, the Integration Status field is set to Sync ON, a real-time synchronization flow is initiated to synchronize the

CRM On Demand account to the related party and account in Oracle E-Business Suite.

- Update and synchronize accounts from CRM On Demand to Oracle E-Business Suite

This flow enables the synchronization of account updates from CRM On Demand to Oracle E-Business Suite for account records that have been flagged for synchronization within CRM On Demand, that is, for records in which the Integration Status field is set to Sync ON.

- Merge accounts

This flow is initiated in Oracle E-Business Suite when an account is merged into another account. The corresponding merge operation is then performed in CRM On Demand on the related accounts. Upon merge completion, the child records of the losing account record point to the winning account record.

- Merge parties

This flow is initiated in Oracle E-Business Suite when an organization party is merged into another party. All of the child records that belong to the surviving party are synchronized to CRM On Demand after the merge.

For more information about initial batch loading of data, see [Chapter 2, "Initial Loading and Synchronization of Data"](#).

3.1.1 Solution Assumptions and Constraints

These are the integration solution assumptions and constraints:

1. The synchronization of account hierarchies across systems, that is, account-to-account relationships, is not in the scope of this release.
2. To initiate the account synchronization, you must run a concurrent job in Oracle E-Business Suite after any creates or updates to accounts or parties.

A concurrent job is a batch job that raises events for creates or updates since the last concurrent job.

3. Bill-To and Ship-To usage on the same account address record in Oracle E-Business Suite is not supported. If the same address (Account-Site) is to be designated as Bill-To and Ship-To address in Oracle E-Business Suite, create two addresses with the different Site Usage Types associate to each. If you do not create addresses with the different Site Usage Types, unpredictable results occur while syncing from CRM On Demand to Oracle E-Business Suite.
4. As part of this integration, the customer number and the site number are autogenerated.

In Oracle E-Business Suite, the system parameters Auto Generate Customer Number and Auto Generate Site Number are set at the Operating Unit level. The value for these parameters is set to Y so that customer number and site number are autogenerated in Oracle E-Business Suite.

5. The account integration in version 3.1 of the Process Integration Pack (PIP) does not include a mapping of the CRM On Demand Account Description or Furigana name because the CustomerParty Enterprise Business Object (EBO) does not support these attributes.
6. Within Oracle E-Business Suite, you can create multiple phone numbers for an account or account-contact with an associated type (main, fax, and so on), but can specify only one primary phone number across types.

Within CRM On Demand, separate fields capture the main phone number, fax number, and so on, and only one of each. From CRM On Demand to Oracle E-Business Suite, the mapping is straightforward, that is, the main phone number in CRM On Demand is mapped to the telephone number in Oracle E-Business Suite. From Oracle E-Business Suite to CRM On Demand, the first active phone number that appears in the CustomerParty Enterprise Business message (EBM) message is synchronized with CRM On Demand.

7. When synching account-contact telephone numbers from Oracle E-Business Suite to CRM On Demand, the Communication Type and Purpose fields must be set as follows if the telephone number entered in Oracle E-Business Suite is to successfully synchronize to CRM On Demand:

Table 3–1 Communication Type and Purpose for CRM On Demand Telephone Mapping

Oracle E-Business Suite Communication Type	Oracle E-Business Suite Communication Purpose	CRM On Demand Telephone Mapping
Telephone	Personal	HomePhone
Telephone	Business	WorkPhone
Mobile	not applicable	Cellular

8. Within Oracle E-Business Suite, Party_Site (address) assignments across multiple accounts are not supported, that is, a Party_Site associated with an Organization party can be assigned only to one account.

If a single Party_Site is assigned to multiple accounts, updates to the address information within CRM On Demand may not propagate across the accounts for which the address is shared.

Figure 3–1 illustrates the overall flow for the account process integration:

Figure 3-1 Customer Account Process Integration Flow

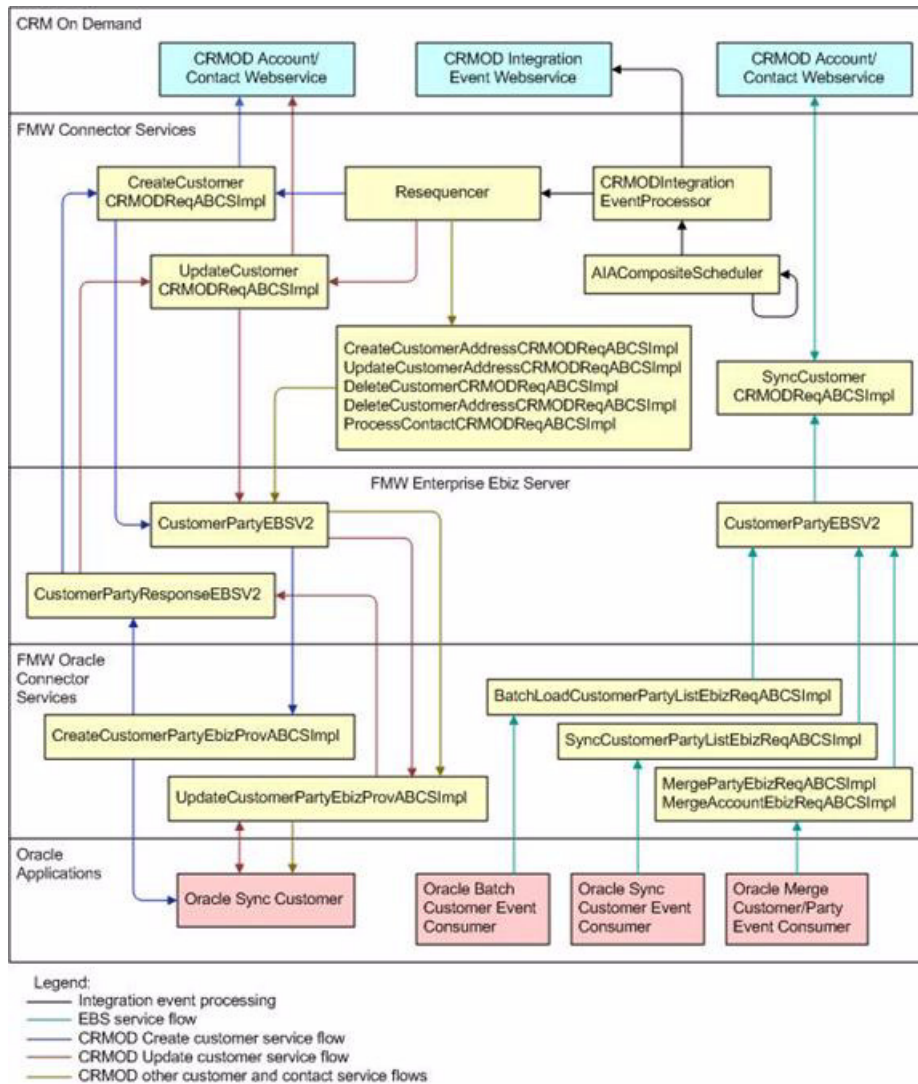

When a new customer account is created or updated in Oracle E-Business Suite, run a concurrent job (TCA Business Object Events - Raise Events) from the Trading Community Manager responsibility. The synchronize flow is initiated after this request finishes successfully. The corresponding primary, bill to, and ship to addresses are captured with the account and synchronized. Similarly, the contacts associated with the account are also synchronized.

Any updates to the account (or related addresses or contacts) in Oracle E-Business Suite are also synchronized with CRM On Demand. The updates to accounts in CRM On Demand are synchronized with Oracle E-Business Suite only if they have been synchronized before and if the account records are flagged for synchronization in CRM On Demand.

When an account is inactivated in Oracle E-Business Suite, it is inactivated in CRM On Demand; that is, if Account Status is set to Inactive in Oracle E-Business Suite, the corresponding account in CRM On Demand is also set to Inactive. The cross-references between the two inactivated accounts remain unchanged, and subsequent updates to the accounts continue to be synchronized.

Note: An account that is set to Inactive in Oracle E-Business Suite is set to Inactive at the account level, not at the organization or party level.

3.2 Customer Data Synchronization

After the initial load of customer account data from Oracle E-Business Suite to CRM On Demand is complete, mapped attributes of account and account-contact records that exist in both applications are synchronized bidirectionally when accounts and account-contacts are created or updated so that data integrity is maintained.

Account data is synchronized when a new account is created, or whenever an existing account record that exists in both applications and that is flagged for synchronization in CRM On Demand is changed in either application.

The Oracle Lead to Order Integration Pack for Oracle CRM On Demand and Oracle E-Business Suite PIP enables you to designate the specific account and account-contact records that are to be enabled for synchronization from CRM On Demand to Oracle E-Business Suite. All newly created or updated accounts are synchronized from Oracle E-Business Suite to CRM On Demand.

These synchronization rules apply:

- New customer accounts and account-contacts created in CRM On Demand that are flagged for synchronization propagate to Oracle E-Business Suite.
- In Oracle E-Business Suite, you cannot flag a specific account for synchronization to CRM On Demand. All customer accounts (that is, all Organization parties with an associated account number) created or updated in Oracle E-Business Suite initiate synchronization to CRM On Demand.
 - Data associated with accounts that are updated in CRM On Demand and that are flagged for synchronization propagate to Oracle E-Business Suite.
 - Account data updated in Oracle E-Business Suite propagates to CRM On Demand.
 - If the account in Oracle E-Business Suite has not previously been synchronized and an update is made in Oracle E-Business Suite, the account is created in CRM On Demand.
- Accounts and account-contacts created in CRM On Demand that have not been flagged for synchronization are synchronized to Oracle E-Business Suite when the associated CRM On Demand opportunity is converted to an Oracle E-Business Suite quote or order.

3.2.1 Enabling Account Synchronization in CRM On Demand

In CRM On Demand, the Integration Status field on the Account detail, Contact detail, or Product detail page indicates whether:

- A record is enabled for synchronization (Sync On)
- A record is not enabled for synchronization (Sync Off)
- A record has failed to synchronize (Sync Failed)

If a record fails to synchronize, an error message is logged to the Integration Message field on the record.

You can set the value of the Integration Status field using the following procedure.

To enable a record for synchronization to Oracle E-Business Suite:

1. Navigate to the Account Detail or Contact Detail page as appropriate.
2. Set the value of the **Integration Status** field to **Sync On**.

The **Integration Status** field of an account that is synchronized from Oracle E-Business Suite to CRM On Demand is automatically set to **Sync On**.

3. Save the record.

Depending on your business environment, you can:

- Optionally allow users to set the value of the **Integration Status** field on the Account detail and Contact detail pages manually.
- Define business rules that determine when the value of the **Integration Status** field is **Sync On** by default. You can define business rules using the **Expression Builder** functionality for the **Integration Status** field.

For more information about Expression Builder, see *CRM On Demand Online Help*.

- Assign responsibility for flagging records for synchronization from CRM On Demand to Oracle E-Business Suite to a designated administration user role within your organization.

[Table 3–2](#) describes the expected behavior when the integration status of a record changes.

Table 3–2 Expected Behavior for Integration Status Changes

Integration Status	Resultant Behavior	Details
From Sync Off to Sync On or from Blank to Sync On	Results in an insert of the corresponding record from CRM On Demand to Oracle E-Business Suite.	Insert, update, and delete association and disassociation transactions are captured by workflow or integration events on the CRM On Demand side and placed in the Integration Event Queue for processing. At this point, the corresponding record is enabled for sync to the target application, that is, Oracle E-Business Suite.
From Sync On to Sync Off	Results in no new updates going from CRM On Demand to Oracle E-Business Suite. New updates in CRM On Demand are not tracked. Updates to CRM On Demand from Oracle E-Business Suite still occur.	Insert, update, and delete association and disassociation transactions are no longer captured by workflow or integration events on the CRM On Demand side and are not placed in the Integration Event Queue for processing. At this point, the corresponding record is disabled for synchronization with Oracle E-Business Suite.
From Sync On to Sync Failed	Results in no new updates going from CRM On Demand to Oracle E-Business Suite. Updates from Oracle E-Business Suite to CRM On Demand continue to be processed (if possible).	The toggle to this state should happen automatically only if a sync failure that is either related to a business rule failing or a system error. If the integration status is Sync Failed, any insert, update, and delete association and disassociation transactions are no longer captured by workflow or integration events on the CRM On Demand side and are not placed in the Integration Event queue for processing. At this point, the corresponding record is disabled for sync to Oracle E-Business Suite.
From Sync Failed to Sync On	Results in a resync of the record from CRM On Demand to Oracle E-Business Suite	After the reason for the sync failure has been corrected, an admin user can set the integration status back to Sync On, which results in a resync from CRM On Demand to Oracle E-Business Suite. Once again, insert, update, and delete association and disassociation transactions are captured by workflow or integration events on the CRM On Demand side and placed in the Integration Event queue for processing. At this point, the corresponding record is enabled for sync to the target application, that is, Oracle E-Business Suite.

Note: When the Sync flag for an account is set to Off, changes to the account-addresses continue to be synchronized. Synchronization status is maintained only for parent-level objects, such as the Account object.

Because synchronization status is not maintained for child-level objects, such as for account-addresses, the address continues to be synchronized even if the status of the parent object is set to **Sync Off**. If the **Account Sync** flag is set to off and any associated contact is set to **Sync On**, the contact changes propagate. If you do not want these changes to be synchronized, set the Sync flag to *Off* for both the account and the contact.

3.3 Synchronizing Accounts from CRM On Demand to Oracle E-Business Suite

Synchronizing accounts from CRM On Demand to Oracle E-Business Suite includes the following process integrations:

- Synchronizing new accounts from CRM On Demand to Oracle E-Business Suite
- Synchronize new account integration flow
- Updating and synchronizing accounts from CRM On Demand to Oracle E-Business Suite
- Update and synchronize account integration flow
- Deleting accounts in CRM On Demand
- Synchronizing new account-contacts
- Synchronize new account-contacts integration flow
- Updating and synchronizing account-contacts
- Update and synchronize account-contact integration flow
- Deleting account-contacts in CRM On Demand

3.3.1 Synchronizing New Accounts from CRM On Demand to Oracle E-Business Suite

The Create Customer Account integration flow is initiated in CRM On Demand when a new account is created that has been flagged for synchronization. Within CRM On Demand, a workflow that has been defined triggers an integration event that captures the details associated with the creation of the account and places a message in the CRM On Demand integration event queue. The CRMOnDemandIntegrationEventProcessor process in the middle tier polls the CRM On Demand integration event queue at configurable intervals, picks up the account creation message, and makes the appropriate call to Oracle E-Business Suite to create the corresponding account and cross-reference entry in the SOA XREF DB. From this point forward, the account is considered synchronized and subsequent updates to the account in either system are propagated between the two.

During the Opportunity to Quote or Opportunity to Sales Order conversion process, if the account associated with the opportunity has not been synchronized previously to Oracle E-Business Suite, it is synchronized during the conversion process.

3.3.2 Synchronizing New Account Integration Flow

This integration uses the following interfaces:

- CreateCustomerCRMODReqABCImpl
- CreateCustomerPartyEbizProvABCImpl

3.3.3 Updating and Synchronizing Accounts from CRM On Demand to Oracle E-Business Suite

When an existing account record that has been flagged for synchronization is updated in CRM On Demand, the corresponding account record in Oracle E-Business Suite is updated with the changes that were made in CRM On Demand for the mapped attributes.

Account-contact records created or updated in CRM On Demand that are flagged for synchronization and that are also associated with an account that has been synchronized to Oracle E-Business Suite are also synchronized.

3.3.4 Updating and Synchronizing Account Integration Flow

This integration flow uses the following interfaces:

- CreateCustomerAddressCRMODReqABCImpl
- UpdateCustomerAddressCRMODReqABCImpl
- UpdateCustomerCRMODReqABCImpl
- ProcessContactCRMODReqABCImpl
- UpdateCustomerPartyEbizProvABCImpl

3.3.5 Deleting Accounts in CRM On Demand

The delete account integration flow is initiated in CRM On Demand when an existing integrated account record is deleted from the database.

The deletion of the integrated account record from CRM On Demand initiates a process that deletes cross-reference records to the corresponding data in Oracle E-Business Suite in the SOA XREF database but does not delete the account data in Oracle E-Business Suite.

When an account is deleted in CRM On Demand, the cross-reference records related to the account are deleted, that is, the account ID, phone, and fax records. The cross-reference records for the address-related information, such as the shipping address, the billing address, and the alternate address, are not deleted.

3.3.6 Synchronizing New Account-Contacts from CRM On Demand to Oracle E-Business Suite

The Create Account-Contact integration flow is initiated in CRM On Demand when a new account-contact is created that has been flagged for synchronization. An account-contact that is flagged for synchronization is synchronized only if the primary account with which it is associated has been successfully synchronized to Oracle E-Business Suite. Contacts that are not associated with an account are not synchronized to Oracle E-Business Suite. Synchronizing a contact, which is associated with several accounts, is not supported.

New account-contacts created in CRM On Demand create a corresponding account-contact in Oracle E-Business Suite. Cross-reference entries for the synchronized account-contacts are made in the SOA XREF database.

3.3.7 Synchronizing New Account-Contact Integration Flow

This integration uses the following interfaces:

- ProcessContactCRMODReqABCSImpl
- UpdateCustomerPartyEbizProvABCSImpl

3.3.8 Updating and Synchronizing Account-Contacts from CRM On Demand to Oracle E-Business Suite

When an existing account-contact record that has been flagged for synchronization is updated in CRM On Demand, the corresponding account-contact record in Oracle E-Business Suite is updated with the changes that were made in CRM On Demand. The synchronization of account-contact record updates is bidirectional across CRM On Demand and Oracle E-Business Suite.

When the account-contact work phone number, cellular phone number, work fax number, or email address is deleted in CRM On Demand, the corresponding entries in Oracle E-Business Suite are set to Inactive.

When the primary active account-contact telephone number, mobile number, fax number, and email address are set to inactive in Oracle E-Business Suite, the corresponding entries in CRM On Demand are deleted.

For account-contact records, only the primary email address in Oracle E-Business Suite is synchronized to the Email field in CRM On Demand.

For accounts, the primary web site is synchronized to the CRM On Demand web field.

The first phone, fax, or mobile number that appears in the CustomerParty EBM that is active is synchronized to CRM On Demand.

3.3.9 Update and Synchronize Account-Contact Integration Flow

This integration flow uses the following interfaces:

- ProcessContactCRMODReqABCSImpl
- UpdateCustomerPartyEbizProvABCSImpl

3.3.10 Deleting Account-Contacts in CRM On Demand

CRM On Demand users who have the appropriate privileges can delete an account-contact. Within Oracle E-Business Suite, users cannot delete an account-contact, but they can inactivate it.

When an integrated account-contact is deleted in CRM On Demand, the corresponding cross-reference in the SOA XREF DB is removed, but the status of the account-contact in Oracle E-Business Suite does not change; it is not deleted or inactivated.

When the status of an integrated account-contact is set to Inactive in Oracle E-Business Suite, the corresponding account-contact in CRM On Demand remains unchanged. The cross-reference between the two entities is also unchanged, and subsequent updates to the entities continue to synchronize even though the status of the account-contact in Oracle E-Business Suite is Inactive.

The integration does not support the restoration of deleted accounts or accounts-contacts; that is, if you delete and then restore a synchronized account-contact, the results are unpredictable; for example, duplicate data may be generated in Oracle E-Business Suite.

When an integrated account-contact is disassociated from its parent account in CRM On Demand, the corresponding account-contact in Oracle E-Business Suite is set to Inactive status. If the status of the account-contact is subsequently set to Active in Oracle E-Business Suite, the association between the records is again established in CRM On Demand, and the account-contact is synchronized from Oracle E-Business Suite to CRM On Demand. If the account-contact is again associated with the account in CRM On Demand, the account-contact in Oracle E-Business Suite is reset to Active status and the record is synchronized from CRM On Demand to Oracle E-Business Suite without a duplicate record being created in Oracle E-Business Suite.

3.4 Synchronizing Accounts from Oracle E-Business Suite to CRM On Demand

Synchronizing accounts from Oracle E-Business Suite to CRM On Demand includes the following process integrations:

- Batch Loading Accounts from Oracle E-Business Suite to CRM On Demand
- Synchronizing New Accounts from Oracle E-Business Suite to CRM On Demand
- Synchronize Customer Account Integration Flow
- Merging Accounts from Oracle E-Business Suite to CRM On Demand
- Merge Account Integration Flow
- Merging Parties from Oracle E-Business Suite to CRM On Demand
- Merge Party Integration Flow

3.4.1 Batch Loading Accounts from Oracle E-Business Suite to CRM On Demand

You initiate the Batchload Customer Account integration flow in Oracle E-Business Suite when performing the initial data load from Oracle E-Business Suite to CRM On Demand. Details related to the account (account number, addresses, contacts, phone number, fax number, email address, web address, and so on) are synchronized to CRM On Demand; this includes associated account-contacts and account-addresses.

For information about the initial batch loading of customer account data, see [Chapter 2, "Initial Loading and Synchronization of Data"](#).

3.4.2 Synchronizing New Accounts from Oracle E-Business Suite to CRM On Demand

You initiate the Synchronize Customer Account integration flow in Oracle E-Business Suite when you create a new account or update an existing account. Details related to the account (account number, addresses, contacts, phone number, fax number, email address, web address, and so on) are synchronized to CRM On Demand.

When an account is created or updated in Oracle E-Business Suite, a record is written to a tracking table. Raising a Trading Community Architecture (TCA) business event causes all of the account records in the tracking table to be stamped with an event identifier and queue event message to be sent to the Oracle Advanced Queue (AQ). The synchronize account process retrieves the message from the AQ, reads the event identifier, and invokes the TCA Application Programming Interface (API) to extract all of the created or updated account information.

A create or update event is tracked in the following situations:

- When a new party and account is created; the create account business event is raised.

- When a party or account is updated; the update account business event is raised.
- When an account is created on an existing party; the update account business event is raised.
- When the SyncCustomerPartyList operation accepts the list of accounts, the requester Application Business Connector (ABC) integration service passes the entire list of accounts to the CustomerPartyEBSV2Enterprise Business Service (EBS) and invokes the corresponding provider ABC implementation service.

Figure 3–2 provides an overview of the Synchronize Customer Account integration flow:

Figure 3–2 Synchronize Customer Account Integration Flow

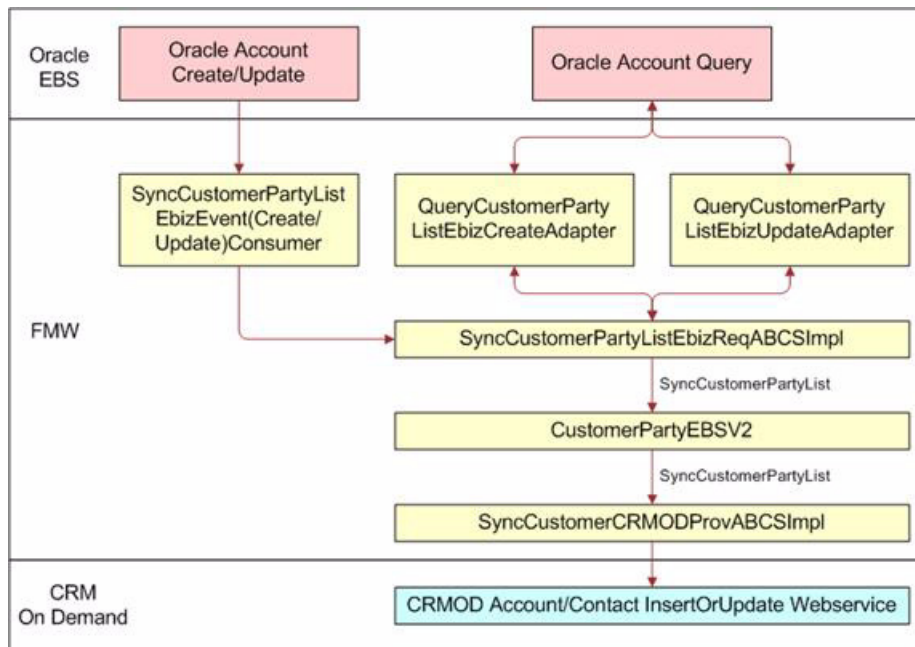

3.4.3 Synchronize Customer Account Integration Flow

This integration flow uses the following interfaces:

- SyncCustomerPartyListEbizEventCreateConsumer
- SyncCustomerPartyListEbizEventUpdateConsumer
- QueryCustomerPartyListEbizCreateAdapter
- QueryCustomerPartyListEbizUpdateAdapter
- SyncCustomerPartyListEbizReqABCImpl
- CustomerPartyEBSV2
- SyncCustomerCRMODProvABCImpl

Figure 3–3 illustrates the Synchronize Account integration flow:

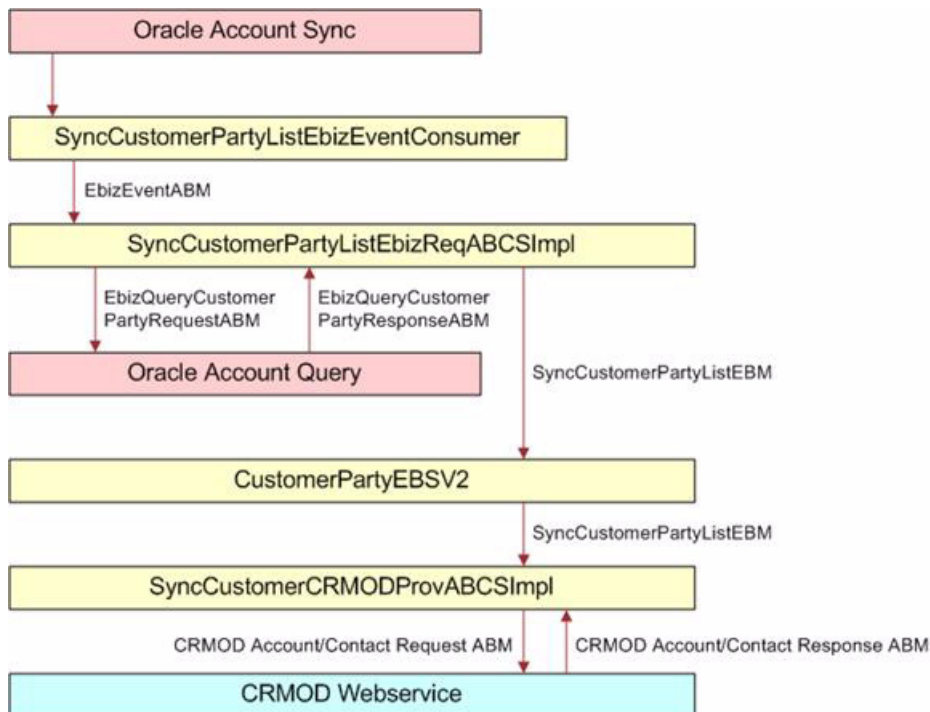
Figure 3–3 Synchronize Account Flow Sequence Diagram

When you initiate the Synchronize Account process, the following events occur:

1. In Oracle Applications, a user navigates to the Customer Standard form (or any other form that allows the creation of customer accounts) and creates an account with address and contact details.

An administrator either manually runs or schedules periodic execution of the TCA Raise Business Events concurrent program to raise the business events for the account creation. The events are captured in a database table to which the SyncCustomerPartyListEbizEventConsumer is listening. Different events are raised for a create scenario and an update scenario.

Note: The TCA Raise Business Events concurrent program can be scheduled to run periodically at defined intervals, for example, every three minutes.

2. The SyncCustomerPartyListEbizEventConsumer retrieves the event payload from the queue and routes the request to the SyncCustomerPartyListEbizReqABCImpl service.

The create event is retrieved from the queue by the SyncCustomerPartyListEbizEventCreateConsumer and the update event is retrieved from the queue by the SyncCustomerPartyListEbizEventUpdateConsumer.

This service has two operations, create, and update, for actions of the same name. The routing occurs based on the payload received from the event.

3. The event payload received by the SyncCustomerPartyListEbizReqABCImpl contains only the event identifier, not the entire account detail. Therefore, account details must be fetched from Oracle E-Business Suite based on the event ID.

When you use the Query Apps adapters `QueryCustomerPartyListEbizCreateAdapter` and `QueryCustomerPartyListEbizUpdateAdapter`, the account details are fetched based on the kind of action, update, or create.

4. The Query adapters (`QueryCustomerPartyListEbizCreateAdapter` and `QueryCustomerPartyListEbizUpdateAdapter`) query the Oracle E-Business Suite database with the `EbizQueryCustomerPartyRequestABM` and fetch the account payload corresponding to the event ID, which is the `EbizQueryCustomerPartyResponseABM`.
5. In the `SyncCustomerPartyListEbizReqABCSImpl`, the `QueryResponseABM` is transformed into the `SyncCustomerPartyListEBM`, and the `SyncCustomerPartyList` operation of the `CustomerPartyEBSV2` is invoked with this EBM.
6. The `CustomerPartyEBSV2` service routes the `SyncCustomerPartyListEBM` to the `SyncCustomerCRMODProvABCSImpl`.

In this service, the `SyncCustomerPartyListEBM` is transformed into the CRM On Demand Account/Contact Request Application Business Message (ABM), and the CRM On Demand web service for account creation or update is invoked.

7. The `CRMODCustomerUpsert` web service actually creates or updates the account, address, and contact in CRM On Demand and returns the appropriate response, `CRM On Demand Account/Contact Response ABM`.

This response is received by the `SyncCustomerCRMODProvABCSImpl` service.

8. In the `SyncCustomerCRMODProvABCSImpl` service, the `CRM On Demand Account/Contact Response ABM` is transformed into the `SyncCustomerPartyListResponseEBM`, during which the cross-reference data is updated with the CRM On Demand identifiers.

The Account Update flow ends at this point; no response is sent back to Oracle E-Business Suite.

3.4.4 Merging Accounts from Oracle E-Business Suite to CRM On Demand

You initiate the Merge Account integration flow in Oracle E-Business Suite when you merge an account into another account in Oracle E-Business Suite. A corresponding account merge operation is performed in the target CRM On Demand system.

When accounts are merged in Oracle E-Business Suite, a business event is raised in Oracle E-Business Suite. The event message contains an account merge header identifier. The message is added to the AQ queue. The `MergeAccountEbizEventAdapter` retrieves the message from the queue and passes it to the `MergeAccountEbizReqABCSImpl`. The process reads the identifier and invokes the TCA API to extract account merge information.

[Table 3–3](#) outlines the synchronization outcome of several scenarios when the account merge process is initiated in Oracle E-Business Suite.

Table 3–3 Synchronization Outcome for Account Merge Process

Scenario	Outcome
Two accounts that belong to the same party are merged in Oracle E-Business Suite. Neither account was previously synchronized to CRM On Demand.	The winning account in Oracle E-Business Suite is synchronized to CRM On Demand.
Two accounts that belong to the same party are merged in Oracle E-Business Suite. Both accounts were previously synchronized to CRM On Demand.	Attributes of the losing account, such as address and contacts, are incorporated into the winning account. The status of the losing account is set to Inactive in CRM On Demand.
Two accounts that belong to different parties are merged in Oracle E-Business Suite. These are the related scenarios: 1. The parties were merged first in Oracle E-Business Suite. 2. Merged the accounts under the parties from step 1 in Oracle E-Business Suite. 3. Merged the accounts that belonged to different parties in Oracle E-Business Suite and the same operating unit without previously merging the parties.	1. The merge at the party level was successful in Oracle E-Business Suite. 2. The merge failed in Oracle E-Business Suite and the synchronization to CRM On Demand was not triggered. 3. The merge was successful in Oracle E-Business Suite and the synchronization to CRM On Demand was triggered. CRM On Demand was updated successfully.

Figure 3–4 illustrates the Merge Account integration flow:

Figure 3–4 Merge Account Integration Flow

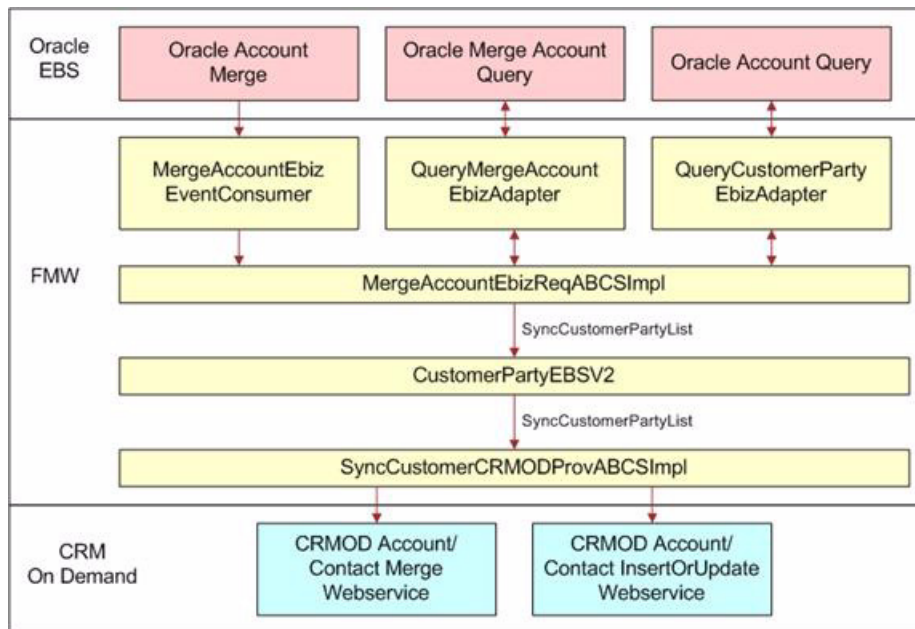

3.4.5 Merge Account Integration Flow

This integration flow uses the following interfaces:

- MergeAccountEbizEventConsumer
- MergeAccountEbizReqABCSImpl
- CustomerPartyEBSV2
- CustomerPartyResponseEBSV2
- SyncCustomerCRMODProvABCSImpl
- QueryMergeAccountEbizAdapter
- QueryCustomerPartyEbizAdapter

Figure 3–5 illustrates the Merge Account integration flow:

Figure 3–5 Merge Account Flow Sequence Diagram

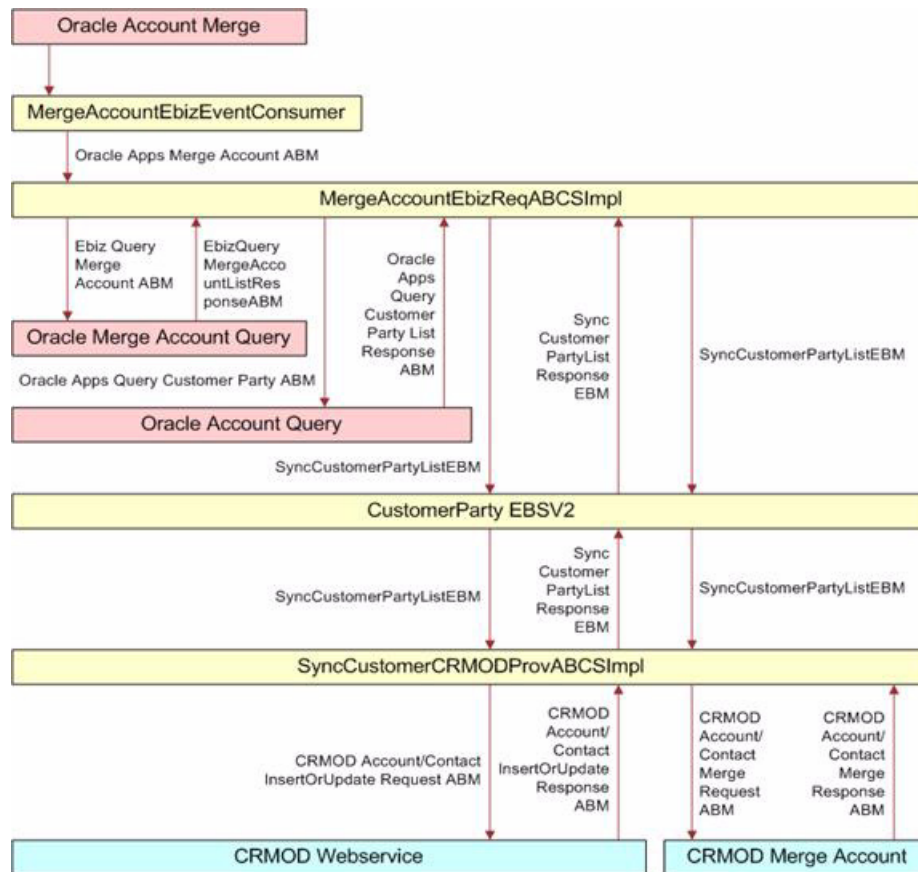

When you initiate the merge account process, the following events occur:

1. In Oracle Applications, a user performs an account merge using the Account Merge form. The merge involves two entities, the Winning Account (To account) and the Losing Account (From account).

The Account Merge operation generates a concurrent request that does the actual merge in Oracle E-Business Suite; then it raises the business events to the queue, where a consumer Oracle Apps adapter (MergeAccountEbizEventConsumer) is listening.

2. The MergeAccountEbizEventConsumer retrieves the event payload from the queue and routes the request to the SyncCustomerParty operation of the MergeAccountEbizReqABCImpl service.

3. The event payload received by the MergeAccountEbizReqABCImpl service contains only the event identifier, not details of the entire account.

The account details must be fetched from Oracle E-Business Suite based on the event ID. You use the Query Apps adapters QueryMergeAccountEbizAdapter and QueryCustomerPartyEbizAdapter to fetch the account details.

4. The QueryMergeAccountEbizAdapter fetches the Winning Account and Losing Account identifiers from Oracle E-Business Suite based on the event ID in the request payload.

This response is then used to build the QueryCustomerPartyABM message, which is then used to fetch the individual account details.

5. The QueryCustomerPartyEbizAdapter service fetches the account details (addresses, contact points, contacts, and so on) from Oracle E-Business Suite and sends the response back as QueryAppsCustomerPartyListResponseABM.
6. The response from the QueryCustomerPartyEbizAdapter is transformed into the SyncCustomerPartyListEBM by the MergeAccountEbizReqABCSImpl service.
Then the SyncCustomerPartyList operation of the CustomerPartyEBSV2 service is invoked.
7. The CustomerPartyEBSV2 service routes the SyncCustomerPartyListEBM to the SyncCustomerCRMODProvABCSImpl, which then transforms the EBM to the CRMODSyncAccountRequestABM and invokes the Upsert CRM On Demand web service.
The response sent by the Upsert CRM On Demand web service is then transformed into the SyncCustomerPartyListResponseEBM, during which the cross-reference data is updated.
The response is sent back to the MergeAccountEbizReqABCSImpl using the CustomerPartyResponseEBSV2 service.
8. The account merge into CRM On Demand occurs in two stages.
 - a. The losing account data is synchronized to the winning account (based on an option selected during the merge that specifies whether to create the same address) using the Upsert CRM On Demand web service.
 - b. The Update CRM On Demand web service is used to update the losing account status to Inactive in CRM On Demand.
9. As the second part of the merge, the MergeAccountEbizReqABCSImpl invokes the SyncCustomerPartyList operation of the CustomerPartyEBSV2 service, which in turn routes the EBM to the SyncCustomerCRMODProvABCSImpl.
10. Based on a flag in the EBM, the SyncCustomerCRMODProvABCSImpl transforms the SyncCustomerPartyListEBM to the CRMODUpdateAccountReqABM and invokes the Update CRM On Demand Account web service to update the losing account status to Inactive in CRM On Demand.
11. The response received from the web service is then used to update the cross-reference data while being transformed to the SyncCustomerPartyListResponseEBM.
12. The Merge Account flow ends with no further responses sent back to Oracle E-Business Suite.

3.4.6 Merging Parties from Oracle E-Business Suite to CRM On Demand

You initiate the Merge Party integration flow in Oracle E-Business Suite when you merge an organization party into another party in Oracle E-Business Suite. Because the party ID is part of the Oracle ID in the cross-reference ID, the Merge Party flow updates the corresponding Oracle ID value in the cross-reference ID. In addition, all accounts of the surviving party in Oracle E-Business Suite are synchronized to CRM On Demand after the merge.

When parties are merged in Oracle E-Business Suite, a business event is raised in Oracle E-Business Suite. The event message contains the batch and winning party identifier. The message is added to the AQ. The MergePartyEbizEventAdapter

retrieves the message from the AQ and passes it to the MergePartyEbizReqABCImpl. The process reads the identifiers and invokes the TCA API to extract merge party information.

Table 3–4 outlines the synchronization outcome of several scenarios when the party merge process is initiated in Oracle E-Business Suite.

Table 3–4 Synchronization Outline for Party Merge Process

Scenario	Outcome
Two parties are merged in Oracle E-Business Suite and the accounts associated with the winning party were not previously synchronized to CRM On Demand.	The accounts associated with the winning party are synchronized to CRM On Demand and the attributes of the winning party are synchronized to the accounts of the losing party.
Two parties are merged in Oracle E-Business Suite and the accounts associated with the losing party were not previously synchronized to CRM On Demand.	After the merge, the winning party contains the losing party accounts and all the winning party accounts (including the accounts of the losing party) are synchronized to CRM On Demand.
Two parties are merged in Oracle E-Business Suite and the accounts associated with both parties were not previously synchronized to CRM On Demand.	After the merge, the winning party contains the losing party accounts and all the winning party accounts (including the accounts of the losing party) are synchronized to CRM On Demand.
Two parties are merged in Oracle E-Business Suite and the accounts associated with both were previously synchronized to CRM On Demand.	After the merge, the attributes of the winning party are incorporated into the accounts of the losing party.

Figure 3–6 illustrates the Merge Party integration flow:

Figure 3–6 Merge Party Integration Flow

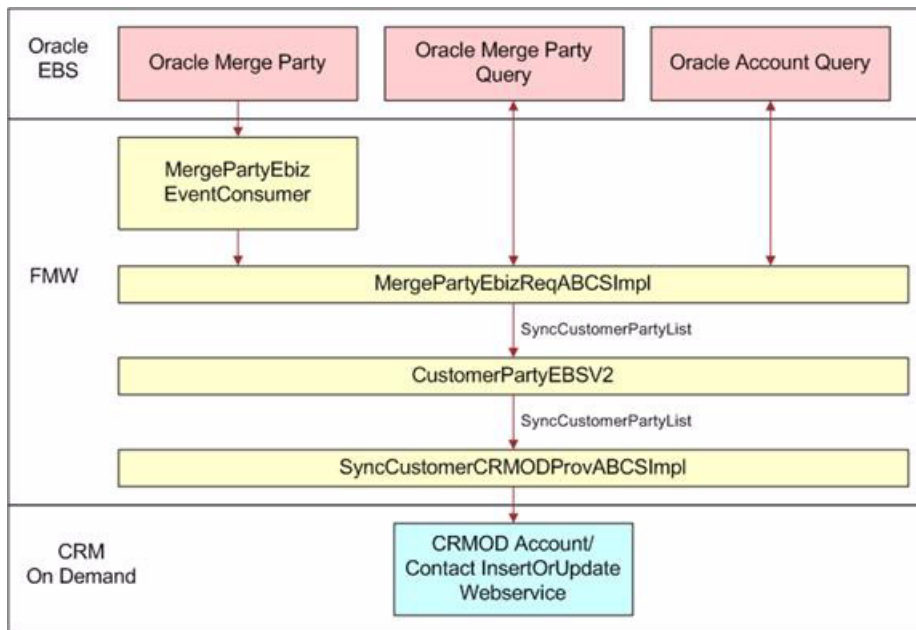

3.4.7 Merge Party Integration Flow

This integration flow uses the following interfaces:

- MergePartyEbizEventConsumer
- MergePartyEbizReqABCImpl
- CustomerPartyEBSV2
- SyncCustomerCRMODProvABCImpl
- QueryRelatedOrgCustEbizAdapter
- QueryMergeOrgCustEbizAdapter
- QueryPartyMergeEbizAdapter

Figure 3–7 illustrates the Merge Party integration flow:

Figure 3–7 Merge Party Flow Sequence Diagram

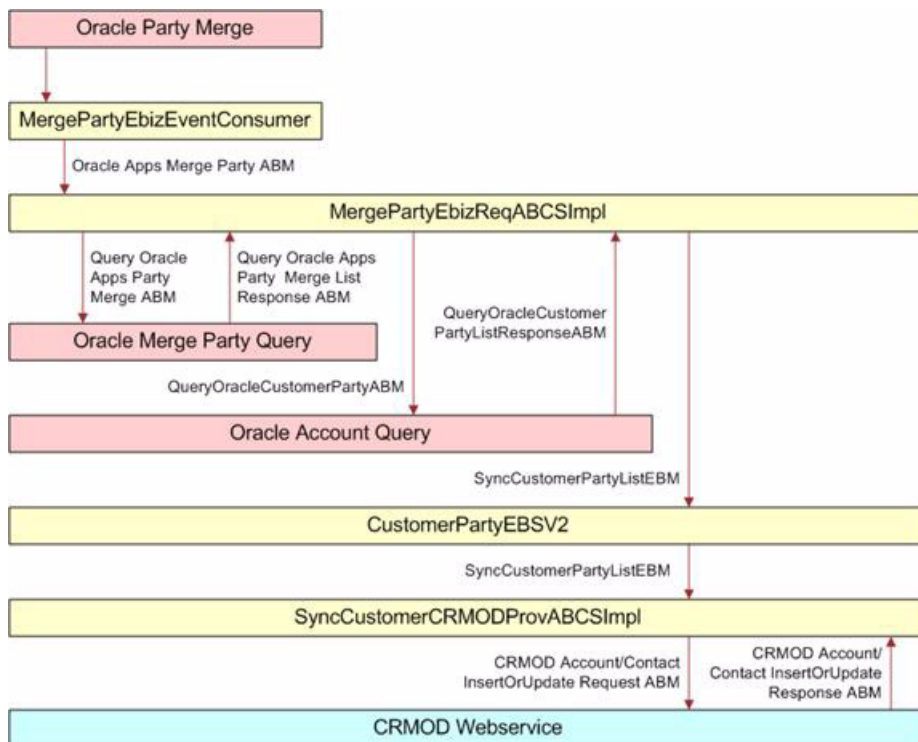

When you initiate the Merge Party process, the following events occur:

1. In Oracle Applications, a user performs a party merge using the Party Merge form. The merge involves two entities, the Winning Party (To account) and the Losing Party (From account).

The Party Merge operation generates a concurrent request that does the actual merge in Oracle E-Business Suite and then raises the business events to the queue, where a consumer Oracle E-Business Suite adapter (MergePartyEbizEventConsumer) is listening.

2. The MergePartyEbizEventConsumer retrieves the event payload from the queue and routes the request to the SyncCustomerParty operation of the MergePartyEbizReqABCImpl service.

3. The event payload received by the MergePartyEbizReqABCImpl contains only the event identifier, not details of the entire account.

Therefore, account details must be fetched from Oracle E-Business Suite based on the event ID. Use the Query Apps adapters QueryPartyMergeEbizAdapter, QueryMergeOrgCustEbizAdapter, and QueryRelatedOrgCustEbizAdapter to fetch the account details. When the parties being merged are of type Organization, use QueryMergeOrgCustEbizAdapter. When the parties being merged are not of type Organization, use QueryRelatedOrgCustEbizAdapter.

4. The QueryPartyMergeEbizAdapter fetches the Winning Account and Losing Account identifiers from Oracle E-Business Suite based on the event ID in the request payload.

This response is then used to build the QueryCustomerPartyABM message, which is then used to fetch the individual account details.

5. The QueryMergeOrgCustEbizAdapter service fetches account details for the Organization type parties (addresses, contact points, contacts, and so on) from Oracle E-Business Suite and sends the response back as QueryAppsCustomerPartyListResponseABM.

The QueryRelatedOrgCustEbizAdapter service fetches account details for parties being merged that are not of type Organization.

6. The response from the QueryMergeOrgCustEbizAdapter (or QueryRelatedOrgCustEbizAdapter) is transformed into the SyncCustomerPartyListEBM by the MergePartyEbizReqABCImpl service, which then invokes the SyncCustomerPartyList operation of the CustomerPartyEBSV2 service.
7. The CustomerPartyEBSV2 service routes the SyncCustomerPartyListEBM to the SyncCustomerCRMODProvABCImpl, which then transforms the EBM into the CRMODSyncAccountRequestABM and invokes the Upsert CRM On Demand web service.

Because no parties are available in CRM On Demand, the Merge service is not used in this flow. Instead, the Sync service is used to synchronize the accounts of the parties being merged in Oracle E-Business Suite.

8. The response sent by the Upsert CRM On Demand web service is then transformed into the SyncCustomerPartyListResponseEBM, during which the cross-reference data is updated.

The Merge Party flow ends at this point, and no further responses are sent back to Oracle E-Business Suite.

3.5 Oracle CRM On Demand Interfaces

The CRM On Demand web service provided for the Customer Management flow integration is

`document/urn:crmondemand/ws/account/10/2004:AccountInsertOrUpdate.`

3.6 Oracle E-Business Suite Interfaces

These Oracle E-Business Suite web services are available for the Customer Management flow integration:

Inbound to Oracle E-Business Suite Web Services

This integration uses these Oracle artifacts:

- Service Name: HZ_ORG_CUST_BO_PUB.GET_ORG_CUSTS_CREATED
- Service Name: HZ_ORG_CUST_BO_PUB.GET_ORG_CUSTS_UPDATED
- Service Name: HZ_AIA_CUSTOM_PKG.SYNC_ACCT_ORDER
- Service Name: HZ_AIA_CUSTOM_PKG.get_acct_merge_obj
- Service Name: HZ_AIA_CUSTOM_PKG.get_party_merge_objs
- Service Name: HZ_AIA_CUSTOM_PKG.get_merge_org_custs
- Service Name: HZ_AIA_CUSTOM_PKG.get_related_org_cust_objs

Outbound from Oracle E-Business Suite Event Interfaces

These events are raised in Oracle and are consumed by this integration:

- oracle.apps.ar.hz.OrgCustBO.create
- oracle.apps.ar.hz.OrgCustBO.update
- oracle.apps.ar.hz.CustAccount.merge
- oracle.apps.ar.hz.Party.merge
- oracle.apps.ar.hz.ebi.custLoad
- HZ_EBI_CUST_LOAD.GENERATE_EVENTS
- HZ_EBI_CUST_LOAD.Get_Org_Custs_BO
- HZ_EBI_CUST_LOAD.PURGE_EVENTLOG
- HZ_EBI_CUST_LOAD.REGENERATE_FAILED_EVENT

For more information about Oracle E-Business Suite web services and documentation prior to Release 12.1.3, see the library on Oracle Technology Network: <http://www.oracle.com/technetwork/documentation/applications-167706.html?> For Oracle E-Business Suite documentation for R12.1.3 and beyond, see this library: http://download.oracle.com/docs/cd/E18727_01/index.htm.

3.7 Core AIA Components

The Customer Management integration uses the following horizontal components:

- CustomerPartyEBO
- InterfaceCustomerToFulfillmentEBF
- QueryCustomerPartyListEBM
- QueryCustomerPartyListResponseEBM
- SyncCustomerPartyListEBM
- SyncCustomerPartyListResponseEBM
- CustomerPartyEBSV2
- CreateCustomerPartyEBM
- CreateCustomerPartyResponseEBM
- UpdateCustomerPartyEBM

- UpdateCustomerPartyResponseEBM
- CustomerPartyResponseEBS

The core EBO and EBM XML Schema Definition (XSD) files can be located by EBO within this parent folder: \$AIA_HOME/AIAMetaData/AIAComponents/EnterpriseObjectLibrary/Core/EBO/.

The core Oracle E-Business Suite Web Service Definition Language (WSDL) files can be located by EBO within this parent folder: \$AIA_HOME/AIAMetaData/AIAComponents/EnterpriseBusinessServiceLibrary/Core/EBO/.

For detailed information about individual EBOs and EBMs, click the AIA Reference Doc link on EBO and EBM detail pages in Oracle Enterprise Repository.

For more information about using the Oracle Enterprise Repository and configuring it to provide the AIA Reference Doc link, see *Oracle Fusion Middleware Developer's Guide for Oracle Application Integration Architecture Foundation Pack 11g Release 1*, "Configuring and Using Oracle Enterprise Repository as the Oracle AIA SOA Repository."

EBOs can be extended, for instance, to add new data elements. These extensions are protected and remain intact after a patch or an upgrade if AIA guidelines are adhered to.

For more information, see *Oracle Fusion Middleware Concepts and Technologies Guide for Oracle Application Integration Architecture Foundation Pack 11g Release 1*, "Understanding Extensibility."

3.8 Integration Services

These services are delivered with this integration:

- CustomerPartyEBSV2
- CustomerPartyResponseEBSV2
- InterfaceCustomerToFulfillmentEBF
- SyncCustomerCRMODProvABCImpl
- SyncCustomerPartyListEbizReqABCImpl
- SyncCustomerPartyListEbizReqABCImpl
- SyncCustomerPartyListEbizReqABCImpl
- MergeAccountEbizReqABCImpl
- MergePartyEbizReqABCImpl
- SyncCustomerPartyListEbizEventConsumer
- MergeAccountEbizEventConsumer
- MergePartyEbizEventConsumer
- SyncCustomerPartyListEbizAdapter
- CreateCustomerCRMODReqABCImpl
- UpdateCustomerCRMODReqABCImpl
- DeleteCustomerCRMODReqABCImpl
- CreateCustomerAddressCRMODReqABCImpl

- UpdateCustomerAddressCRMODReqABCSImpl
- DeleteCustomerAddressCRMODReqABCSImpl
- QueryCustomerPartyListCRMODProvABCSImpl
- ProcessContactCRMODReqABCSImpl
- CreateCustomerPartyEbizProvABCSImpl
- UpdateCustomerPartyEbizProvABCSImpl
- TransformAppContextEbizService
- QueryResponsibilityEbizAdapter
- AIACompositeScheduler
- CRMOnDemandIntegrationEventProcessor

For more information, see *Oracle Fusion Middleware Developer's Guide for Oracle Application Integration Architecture Foundation Pack 11g Release 1*, "Configuring and Using Oracle Enterprise Repository as the Oracle AIA SOA Repository."

3.8.1 CustomerPartyEBSV2

The CustomerPartyEBSV2 exposes all of the enterprise operations that can be performed with a CustomerParty enterprise object. All of the Customer Management integration flows use the operations provided by this enterprise business service.

The CustomerPartyEBSV2 service uses these operations:

- QueryCustomerPartyList
- SyncCustomerPartyList
- CreateCustomerParty
- UpdateCustomerParty

For more information about this enterprise business flow, see *Oracle Fusion Middleware Developer's Guide for Oracle Application Integration Architecture Foundation Pack 11g Release 1*, "Designing and Developing Enterprise Business Services" and *Oracle Fusion Middleware Concepts and Technologies Guide for Oracle Application Integration Architecture Foundation Pack 11g Release 1*, "Understanding Enterprise Business Services."

3.8.2 CustomerPartyResponseEBSV2

The CustomerPartyResponseEBSV2 exposes all of the enterprise response operations that can be performed with a CustomerParty enterprise object. All of the Customer Management integration flows use the response operations provided by this enterprise business service.

The CustomerPartyResponseEBSV2 enterprise business service uses these operations:

- SyncCustomerPartyListResponse
- CreateCustomerPartyResponse
- UpdateCustomerPartyResponse

For more information about this enterprise business flow, see *Oracle Fusion Middleware Developer's Guide for Oracle Application Integration Architecture Foundation Pack 11g Release 1*, "Designing and Developing Enterprise Business Services" and *Oracle Fusion Middleware Concepts and Technologies Guide for Oracle Application Integration Architecture Foundation Pack 11g Release 1*, "Understanding Enterprise Business Services."

3.8.3 InterfaceCustomerToFulfillmentEBF

The InterfaceCustomerToFulfillmentEBF enterprise business flow is implemented as an asynchronous Business Process Execution Language (BPEL) process by using the asynchronous message exchange pattern (with delayed response) framework of AIA.

This enterprise business flow creates or synchronizes all the customer accounts and related components (such as address and contacts) to the appropriate fulfillment system. This service is invoked from the Order integration flow with a list of customer account IDs, address IDs, contact IDs, and the target system ID. When the process is complete, a response is sent back to the Order flow confirming that all accounts, addresses, and contacts have been set up in the target fulfillment system and that Order processing can continue. In case of an error, an error code is returned, signaling that Order processing cannot continue.

For Assumption and Constraint: a single target back-office system is identified within the Order flow, and this information is passed to this service through the EBM header. The source CRM system must also be passed through the EBM header.

This service involves a single operation, and the input is an instance of the ProcessCustomerPartyListEBM message containing the target fulfillment system identifier in the EBM header. The data area of the message contains one or more account IDs and, for each account, one or more address and contact IDs that must be synchronized to the target fulfillment system. Also, enough identifying information must be available to support querying back to the proper CRM source system for the detailed account, customer, and contact data. The service looks up the cross-reference values for organization ID. If any of the IDs are not present in the source CRM system, the processes end due to error.

The service also establishes the cross-reference for account ID, contact ID, and address ID between common values and corresponding Oracle Apps IDs.

The return message contains the same list of account IDs that were passed in the request, with additional flags to indicate success or failure and appropriate error messages for each account.

The service also assumes that before the Order process is called, invoking this service would have established the cross-reference for the CRM On Demand to common ID for all new accounts, addresses, and contacts that are part of the CRM On Demand sales order or quote.

3.8.4 SyncCustomerCRMODProvABCImpl

The SyncCustomerCRMODProvABCImpl service transforms the SyncCustomerPartyListEBM messages into the appropriate CRM On Demand AccountABM format and invokes the CRM On Demand Account Upsert web service operation. If the input SyncCustomerPartyListEBM contains contact-related details, then it transforms to CRM On Demand Contact ABM format and invokes the CRM On Demand Contact Upsert web service operation. It also includes compensation handlers.

These preprocesses are included in the SyncCustomerCRMODProvABCImpl to ensure that ABC services are extensible:

- PreprocessABM
- PreprocessEBM

3.8.5 SyncCustomerPartyListEbizReqABCSEmpl

The SyncCustomerPartyListEbizReqABCSEmpl service is responsible for transforming the Oracle E-Business Suite account, contact, or address created or updated event message into the appropriate SyncCustomerPartyListEBM format and invoking the SyncCustomerPartyList operation of the CustomerPartyEBSV2.

This service has two asynchronous operations: create and update.

3.8.6 SyncCustomerPartyListEbizProvABCSEmpl

The CustomerPartyEBSV2 invokes the SyncCustomerPartyListEbizProvABCSEmpl service when the routing rules determine that Oracle Apps is to be the service provider of the SyncCustomerPartyList Oracle E-Business Suite operation. This determination occurs during the integration flow that is initiated by the account create processing portion of the Sales Order flow.

This service has one synchronous request and reply operation SyncCustomerPartyList.

3.8.7 MergeAccountEbizReqABCSEmpl

The MergeAccountEbizReqABCSEmpl service is responsible for transforming the Oracle Apps account, contact, or address merge event message into the appropriate SyncCustomerPartyListEBM format and invoking the CustomerPartyEBSV2.

This service has one asynchronous request operation: SyncCustomerParty.

3.8.8 MergePartyEbizReqABCSEmpl

The MergePartyEbizReqABCSEmpl service is responsible for transforming the Oracle Apps account, contact, or address merge event message into the appropriate SyncCustomerPartyEBM format.

This service has one asynchronous request and reply operation SyncCustomerParty.

3.8.9 SyncCustomerPartyListEbizEventConsumer

The SyncCustomerPartyListEbizEventConsumer service is responsible for retrieving the Oracle create or update account business event payloads from the AQ and invoking the appropriate operation of the requester Application Business Connector Service (ABCS) SyncCustomerPartyEbizReqABCSEmpl.

Two business events, each with one operation, are available for reading each of the three types of Oracle E-Business Suite messages from the AQ:

- oracle.apps.ar.hz.OrgCustBO.create
- oracle.apps.ar.hz.OrgCustBO.update

The retrieval of the event from the queue is performed according to the correlation ID of the event in the AQ. For customer account create events, the correlation ID is oracle.apps.ar.hz.OrgCustBO.create. For customer account update events, the correlation ID is oracle.apps.ar.hz.OrgCustBO.update.

3.8.10 MergeAccountEbizEventConsumer

The MergeAccountEbizEventConsumer service is responsible for retrieving the Oracle account merge business event payloads from the AQ and invoking the appropriate operation of the requester ABCS. For the account merge, the correlation ID is oracle.apps.ar.hz.CustAccount.merge and the event adapter is

MergeAccountEbizEventAdapter. The process of retrieving the event from the queue depends on the correlation ID of the event in the AQ.

One business event with one operation is available for reading each of the three types of Oracle Apps messages from the AQ: oracle.apps.ar.hz.CustAccount.merge.

3.8.11 MergePartyEbizEventConsumer

The MergePartyEbizEventConsumer service is responsible for retrieving the Oracle party merge business event payloads from the AQ and invoking the appropriate operation of the Requester ABCS. For the party merge, the correlation ID is oracle.apps.ar.hz.Party.merge and the event adapter is MergePartyEbizEventAdapter. The event retrieval operation is performed according to the event correlation ID in AQ.

One business event with one operation is available for reading each of the three types of Oracle Apps messages from the AQ: oracle.apps.ar.hz.Party.merge.

3.8.12 SyncCustomerPartyListEbizAdapter

The SyncCustomerPartyListEbizAdapter service is an Oracle E-Business Suite Adapter service registered in mediator. This adapter service exposes the HZ_AIA_CUSTOM_PUB.sync_acct_order PL/SQL API.

This wrapper API is delivered as part of Oracle E-Business Suite HZ.N.

This service is the interface through which an order is created in Oracle E-Business Suite, and it is invoked by the SyncCustomerPartyListEbizProvABCServiceImpl as part of the Update Customer and Create Order integration flow.

The SyncCustomerPartyListEbizAdapter service exposes the Sync customer party operation of the PL/SQL wrapper API. This operation is a synchronous request and reply operation. By registering this adapter service in Mediator Component, Mediator Component exposes a Simple Object Access Protocol (SOAP) binding that is used in this integration to invoke the service from the SyncCustomerPartyListEbizProvABCServiceImpl service.

3.8.13 CreateCustomerCRMReqABCServiceImpl

The CreateCustomerCRMReqABCServiceImpl service receives the account insert integration event from CRM On Demand. It then queries CRM On Demand to determine whether multiple addresses exist for the customer, whether any contacts are associated with the account, and whether its status is set to Sync On. If multiple addresses exist, the service combines the information into one single message event before transforming the message from CRM On Demand format into the CreateCustomerPartyEBM format. After transforming the message, this service invokes the CustomerPartyEBSV2. After it receives a response from the CreateCustomerPartyEbizProvABCServiceImpl service, it updates the On Demand Account external system ID with the Oracle E-Business Suite account ID.

3.8.14 UpdateCustomerCRMReqABCServiceImpl

The UpdateCustomerCRMReqABCServiceImpl receives an account update integration event from CRM On Demand. The service converts the event message from CRM On Demand format to UpdateCustomerPartyEBM format and invokes the UpdateCustomerPartyEBS.

In cases in which the account has not been synchronized to Oracle E-Business Suite, the service queries CRM On Demand to fetch full information about the account,

including account addresses and contacts that are associated with it and flagged for synchronization. The service then converts the message to UpdateCustomerPartyEBM format and invokes the CreateCustomerPartyEBS to enable the Oracle E-Business Suite application to create an account, including addresses and contacts if necessary.

After UpdateCustomerCRMODReqABCImpl gets a response from CreateCustomerPartyEbizProvABCImpl or UpdateCustomerPartyEbizProvABCImpl, it updates the On Demand Account external system ID with the Oracle E-Business Suite account ID.

3.8.15 DeleteCustomerCRMODReqABCImpl

The DeleteCustomerCRMODReqABCImpl service receives an account delete integration event from CRM On Demand. The service converts the message from CRM On Demand format to UpdateCustomerPartyEBM format and deletes account-related cross-reference details, and the process ends.

For this service to function properly, these criteria must be met:

- The account ID must exist in the CRM On Demand message.
- The host ID must exist in the CRM On Demand message.
- The CRM On Demand input message can contain only one account.
- The CRM On Demand input message contains only delete account information.

Account addresses are not included in the message. If address information exists in the message, it is ignored and not transformed.

One asynchronous one-way operation is provided:
DeleteCustomerCRMODReqABCImpl interface.

3.8.16 CreateCustomerAddressCRMODReqABCImpl

The CreateCustomerAddressCRMODReqABCImpl service receives an address insert integration event from CRM On Demand. The service checks whether the address has a cross-reference ID. If so, the address has been processed during account creation and no further processing is required. If the cross-reference ID does not exist, the service transforms the event message from CRM On Demand format to UpdateCustomerPartyEBM format and invokes the UpdateCustomerPartyEBS.

One asynchronous one-way operation is provided by the
CreateCustomerAddressCRMODReqABCImpl interface service.

3.8.17 UpdateCustomerAddressCRMODReqABCImpl

The UpdateCustomerAddressCRMODReqABCImpl service receives an address update integration event from CRM On Demand. The service converts the event message from CRM On Demand format to UpdateCustomerPartyEBM format and invokes the UpdateCustomerPartyEBS.

For this service to function properly, these criteria must be met:

- The account ID must exist in the CRM On Demand message.
- The host ID must exist in the CRM On Demand message.
- The CRM On Demand input message can contain only one address.
- The CRM On Demand input message must contain some information about the address account.

Only the account ID is used during transforming to supply account identification. All other information about the account is discarded because the purpose of this service is to update an address, not an account.

One asynchronous one-way operation is provided by the UpdateCustomerAddressCRMODReqABCImpl interface service.

3.8.18 DeleteCustomerAddressCRMODReqABCImpl

The DeleteCustomerAddressCRMODReqABCImpl service receives an address delete integration event from CRM On Demand. The service converts the message from CRM On Demand format to UpdateCustomerPartyEBM format, deletes On Demand address-related cross-reference details, and invokes UpdateCustomerPartyEBS.

The Address Delete integration event occurs only when a CRM On Demand user deletes an individual address. The Address Delete integration event is not generated automatically when a CRM On Demand user deletes an account that is associated with addresses.

For this service to function properly, these criteria must be met:

- The account ID must exist in the CRM On Demand message.
- The host ID must exist in the CRM On Demand message.
- The CRM On Demand input message can contain only one address.
- The CRM On Demand input message contains the deleted address information and some information about the address account.

Only the account ID is used during transforming to supply account identification. All other information about the account is discarded because the purpose of this service is to update an address, not an account.

One asynchronous one-way operation is provided by the DeleteCustomerAddressCRMODReqABCImpl interface service.

3.8.19 QueryCustomerPartyListCRMODProvABCImpl

The QueryCustomerPartyListCRMODProvABCImpl service receives the QueryCustomerPartyListEBM as the input message and transforms it to a CRM On Demand Account Query request message.

The CRM On Demand Account Query request message queries all the account-related details, including the address and contacts associated with the account, then filters the details that are not required according to the query criteria specified in the input EBM message. The data is then transformed into a QueryCustomerPartyListResponseEBM message.

The QueryCustomerPartyListCRMODProvABCImpl service is invoked during the Opportunity-to-Order or the /Quotes conversion process Opportunity-to-Quote conversion process when the account and contact associated with an opportunity have not synchronized to Oracle E-Business Suite.

3.8.20 ProcessContactCRMODReqABCImpl

ProcessContactCRMODReqABCImpl receives contact create, update, association, and disassociation values with the account and delete integration event from CRM On Demand. Then the service converts the message from CRM On Demand format to the UpdateCustomerPartyEBM format and invokes UpdateCustomerPartyEBS.

For this service to function properly, these criteria must be met:

- The contact ID must exist in the CRM On Demand message.
- The host ID must exist in the CRM On Demand message

3.8.21 CreateCustomerPartyEbizProvABCImpl

The CustomerPartyEBSV2 service invokes the CreateCustomerPartyEbizProvABCImpl service when the routing rules determine that Oracle E-Business Suite is to be the service provider of the CreateCustomerParty Oracle E-Business Suite operation. This determination occurs during the integration flow that is initiated by the create account processing in CRM On Demand.

3.8.22 UpdateCustomerPartyEbizProvABCImpl

The CustomerPartyEBSV2 service invokes the UpdateCustomerPartyEbizProvABCImpl service when the routing rules determine that Oracle E-Business Suite is to be the service provider of the UpdateCustomerParty Oracle E-Business Suite operation. This flow is initiated when an address or contact associated with an account is created or updated, or when an account is updated in CRM On Demand.

3.8.23 TransformAppContextEbizService

TransformAppContextEbizService is invoked by the Oracle E-Business Suite providers to obtain the application context information that is required to invoke the Oracle E-Business Suite APIs through the Oracle E-Business Suite adapter service. The TransformAppContextEbizService service obtains details such as the Oracle E-Business Suite responsibility ID and the organization ID from the configuration properties.

For more information about the service properties for the TransformAppContextEbizService service, see *Configuring the Oracle Lead to Order Integration Pack for Oracle CRM On Demand and*.

3.8.24 QueryResponsibilityEbizAdapter

The QueryResponsibilityEbizAdapter service makes sure that the Oracle E-Business Suite responsibility exists in the Oracle E-Business Suite database by running a query. The query is invoked from the TransformAppContextEbizService service.

3.8.25 AIACompositeScheduler

AIACompositeScheduler invokes the CRMOnDemandActivationAgent service. AIACompositeScheduler is a utility component that is used by Process Integration Packs (PIP) to schedule a Service-Oriented Architecture (SOA) composite to be invoked at the specified time interval. For example, it can schedule a SOA composite to be invoked every 30 seconds. It supports scheduling composites in cluster environment as well.

Properties of AIACompositeScheduler are specified in web.xml. Administrators can change these properties dynamically through a deployment plan.

For more information about how to modify and how to deploy AIACompositeScheduler, see *Oracle Application Integration Architecture Process Integration Pack Utilities Guide*, "AIACompositeScheduler," Modifying AIACompositeScheduler Properties.

3.8.26 CRMOnDemandIntegrationEventProcessor

The CRMOnDemandIntegrationEventProcessor service is invoked by the CRMOnDemandActivationAgent; the CRM On Demand host ID is provided as input to the process. The CRMOnDemandIntegrationEventProcessor service queries up to a maximum of 100 integration events in the default queue using CRM On Demand integration event web services. The messages are then sent to the appropriate resequencers (CustomerCRMODRoutingService and ContactCRMODRoutingService), which act as middle-tier queues. Resequencers then route events one by one to the appropriate CRM OnDemand requesters.

Also, import the CRM On Demand certificate to Web Logic. If you do not import the certificate, you might encounter the following error:
sun.security.provider.certpath.SunCertPathBuilderException: unable to find valid certification path to requested target.

Process Integration for Product Management

This chapter provides an overview of the product management process integration and includes the following sections:

- [Section 4.1, "Overview"](#)
- [Section 4.2, "Product Synchronization"](#)
- [Section 4.3, "Oracle CRM On Demand Interfaces"](#)
- [Section 4.4, "Oracle E-Business Suite Interfaces"](#)
- [Section 4.5, "Core AIA Components"](#)
- [Section 4.6, "Integration Services"](#)

4.1 Overview

The process integration for product management supports the Synchronize Items Integration flow, which enables the synchronization of simple products from Oracle E-Business Suite to CRM On Demand. This one-way flow of data from Oracle E-Business Suite to CRM On Demand is initiated when simple products are created or updated in Oracle E-Business Suite.

Figure 4–1 illustrates the overall flow for the process integration:

Figure 4–1 Product Management Integration Flow

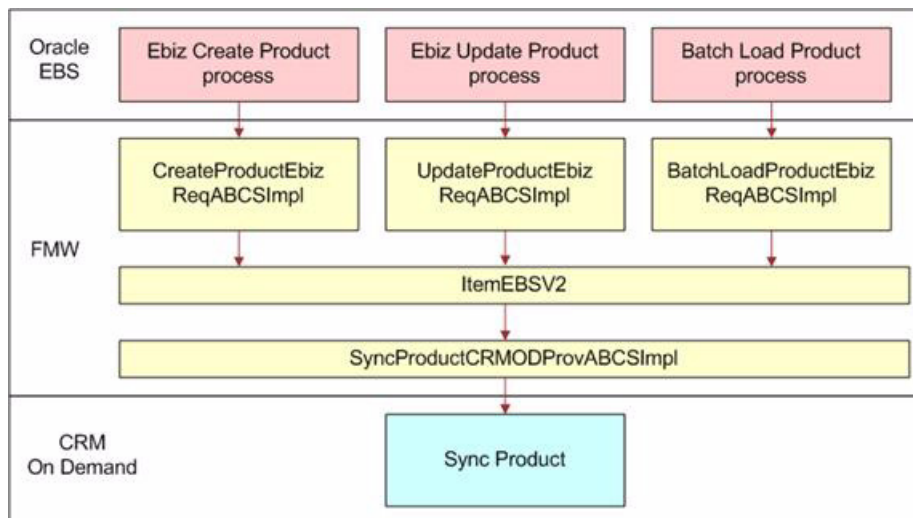

4.1.1 Solution Assumptions and Constraints

The integration design assumes that the following statements are true:

1. Product data integration is a one-way flow from Oracle E-Business Suite to CRM On Demand. After items are synchronized to CRM On Demand, modifications made to the products in CRM On Demand are not synchronized back to Oracle E-Business Suite.
2. Only selected item attributes are synchronized to CRM On Demand, as follows:
 - Item Name (part of the Key Flex Field structure)
 - Item Description
 - Item Type
 - Item Status
 - Order Management-related attributes (orderable flag, customer ordered flag)
3. Nonorderable items are not loaded into CRM On Demand as simple products.

Only products in Oracle E-Business Suite that are marked as both Customer Ordered and Customer Order Enabled are synchronized to CRM On Demand except in the following circumstances:

 - The service configuration flag PUBLISH_ALL_PRODUCT is set to N by default, which means that only products that are marked as Customer Order Enabled are synchronized to Oracle E-Business Suite. You can change the value of this property to Y, in which case all products, whether orderable or not, are synchronized to CRM On Demand.
 - If you change the Customer Order Enabled status of a product from Y (orderable) to N (nonorderable), the product continues to synchronize to CRM On Demand.
4. Item Name in Oracle E-Business Suite comprises concatenated key flex field segments. It cannot exceed 50 characters in length.
5. Special characters such as '&' should not be used in the Oracle E-Business Suite Item Name definition.
6. If a product is updated in Oracle E-Business Suite, and if the product is synchronized to CRM On Demand, the update is also synchronized to CRM On Demand.
7. Products cannot be deleted in Oracle E-Business Suite or CRM On Demand.
8. Products that are part of the product batch load into Oracle E-Business Suite are not synchronized to CRM On Demand.

4.2 Product Synchronization

The Synchronize Items integration flow enables the synchronization of items from Oracle E-Business Suite to CRM On Demand. This synchronization is a one-way feed from Oracle E-Business Suite to CRM On Demand. After items are created or updated in Oracle E-Business Suite, a business event is triggered that enables the synchronization of items from Oracle E-Business Suite to CRM On Demand. This flow is used for incremental loads (manual creation of products) or run-time updates. For high-volume product data loads from Oracle E-Business Suite to CRM On Demand, use the Batch Data Load integration flow that is supported by this Process Integration Pack (PIP).

Only customer-orderable items are synchronized as part of this flow. The following attributes of an item are synchronized and passed to CRM On Demand:

- Item Name (part of the Key Flex Field structure)
- Item Description
- Item Type
- Item Status
- Order Management-related attributes (orderable flag, customer ordered flag)

4.2.1 Create Items Flow

This integration flow uses the following interfaces:

- CreateItemEbizEventConsumer
- CreateProductEbizReqABCImpl
- ItemEBSV2
- SyncItemListCRMODProvABCImpl

Figure 4–2 illustrates the Create Item integration flow:

Figure 4–2 Create Item Flow Sequence Diagram

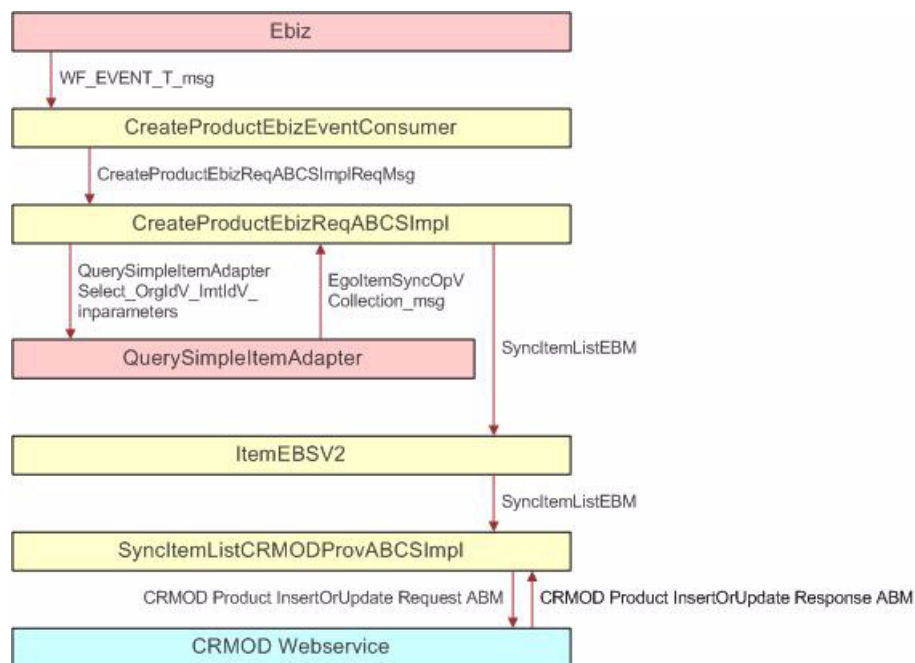

When you initiate the process, the following events occur:

1. The CreateItemEbizEventConsumer listens to business events and receives the WF_EVENT_T_msg event payload for the Create event. The CreateItemEbizEventConsumer is routed to the CreateProductEbizReqABCImpl with the complete event payload.
2. The CreateProductEbizReqABCImpl invokes the ItemEBSV2 with the operation SyncItemList.

- As part of the enrichment process, the CreateProductEbizReqABCImpl queries the EGO_ITEM_SYNC_OP_V view object through the Oracle E-Business Suite adapter QuerySimpleItemAdapter based on event payload to get the EgoItemSyncOpVCollection_msg.
 - As part of the transformation process, the CreateProductEbizReqABCImpl transforms the EgoItemSyncOpVCollection_msg message into the SyncItemListEBM. Invoke the ItemEBSV2 with the operation SyncItemList. The ItemEBSV2 is a routing service with several operations on the Item enterprise business message (EBM). In the process, the cross-reference is created by concatenating the inventory item ID, organization ID, and operating unit.
3. The ItemEBSV2 routes the SyncItemListEBM to the SyncProductCRMODProvABCImpl.
 4. The SyncItemListCRMODProvABCImpl transforms the SyncItemListEBM to the CRM On Demand product message and then calls a CRM On Demand product Upsert web service to synchronize the product.

The CRM On Demand web service completes the request and returns a response message. In the process, the cross-reference is linked to the CRM On Demand IDs of the product.

4.2.2 Update Items Integration Flow

This integration flow uses the following interfaces:

- UpdateItemEbizEventConsumer
- UpdateProductEbizReqABCImpl
- ItemEBSV2
- SyncItemListCRMODProvABCImpl

[Figure 4–3](#) illustrates the Update Items integration flow:

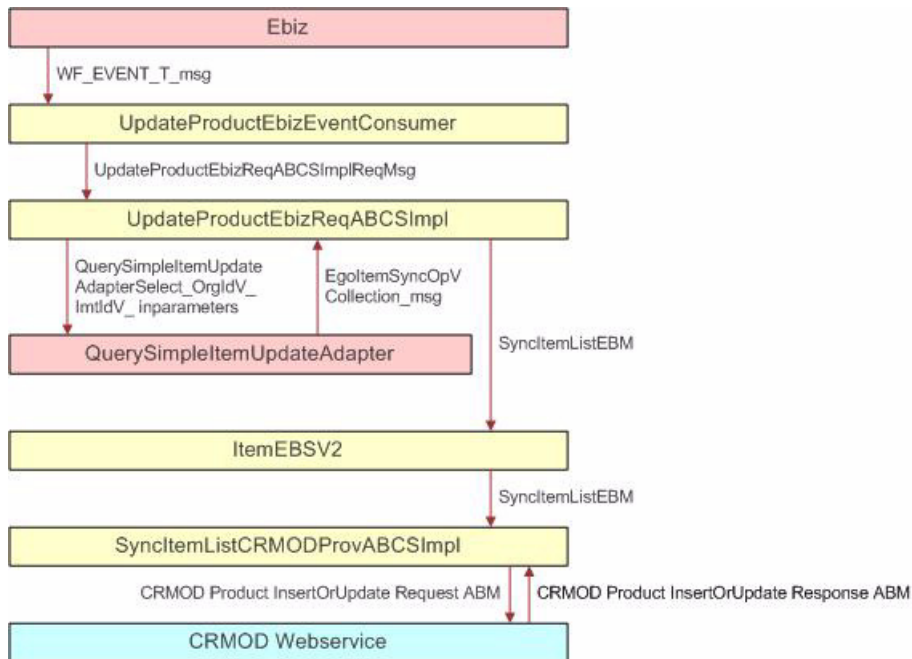
Figure 4–3 Update Items Flow Sequence Diagram

When you initiate the process, the following events occur:

1. The `UpdateItemEbizEventConsumer` listens to business events and receives the `WF_EVENT_T_msg` event payload for update event.
The `UpdateItemEbizEventConsumer` is routed to `UpdateProductEbizReqABCImpl` with the complete Event payload.
2. `UpdateProductEbizReqABCImpl` service calls the Enterprise Business Service (EBS) based on the event payload, and then transforms to the `SyncItemListEBM` and invokes the `ItemEBSV2` with operation `SyncItemList`.
 - a. As part of the enrichment process, the `UpdateProductEbizReqABCImpl` queries the `EGO_ITEM_SYNC_OP_V` view object through the Oracle E-Business Suite adapter `QuerySimpleItemUpdateAdapter` based on the event payload to get the `EgoItemSyncOpVCollection_msg`.
 - b. As part of the transformation process, `UpdateProductEbizReqABCImpl` transforms the `EgoItemSyncOpVCollection_msg` message into the `SyncItemListEBM`.
 - c. `ItemEBSV2` with the operation `SyncItemList` is invoked. `ItemEBSV2` is a routing Mediator Component service with several operations on the Item EBM.
 - d. In the process, the cross-reference is created by concatenating the inventory item ID, organization ID, and operating unit.
3. `ItemEBSV2` routes the `SyncItemListEBM` to `SyncItemListCRMODProvABCImpl`.
4. `SyncItemListCRMODProvABCImpl` transforms `SyncItemListEBM` to the CRM On Demand Product message and then calls the CRM On Demand product Upsert web service to synchronize the product.

The CRM On Demand web service completes the request and returns a response message. In the process, the cross-reference is linked with the CRM On Demand IDs of the product.

4.2.3 Batchload Items Integration Flow

This integration flow uses the following interfaces:

- BatchLoadItemEbizEventConsumer
- BatchLoadProductEbizReqABCImpl
- ItemEBSV2
- SyncItemListCRMODProvABCImpl

You initiate the Batchload Items integration flow in Oracle E-Business Suite when performing the initial data load from Oracle E-Business Suite to CRM On Demand. Details related to the item are synchronized to CRM On Demand.

For information about the initial batch loading of customer account data, see [Chapter 2, "Initial Loading and Synchronization of Data"](#).

4.3 Oracle CRM On Demand Interfaces

The CRM On Demand web service provided for the Product Management integration flow is the `document/urn:crmondemand/ws/product/10/2004:ProductInsertOrUpdate` service.

4.4 Oracle E-Business Suite Interfaces

These are the Oracle E-Business Suite web services provided for the Product Management integration flow.

Outbound from Oracle E-Business Suite Event Interfaces

- `oracle.apps.ego.item.postItemCreate`
- `oracle.apps.ego.item.postItemUpdate`
- `oracle.apps.ego.ebi.itemLoad`

Oracle E-Business Suite View Interfaces

`EGO_ITEM_SYNC_OP_V`

For more information about Oracle E-Business Suite web services and documentation prior to Release 12.1.3, see the library on Oracle Technology Network: <http://www.oracle.com/technetwork/documentation/applications-167706.html?> For Oracle E-Business Suite documentation for R12.1.3 and beyond, see this library: http://download.oracle.com/docs/cd/E18727_01/index.htm.

4.5 Core AIA Components

The Product Management integration flow uses the following delivered core components:

- ItemCompositionEBO
- ItemEBO
- ItemListEBM
- ItemEBSV2

The core EBO and EBM XML Schema Definition files can be located by Enterprise Business Object (EBO) within this parent folder: \$AIA_HOME/AIAMetaData/AIAComponents/EnterpriseObjectLibrary/Core/EBO/.

The core Oracle E-Business Suite Web Service Definition Language (WSDL) files can be located by EBO within this parent folder: \$AIA_HOME/AIAMetaData/AIAComponents/EnterpriseBusinessServiceLibrary/Core/EBO/.

For detailed documentation of individual EBOs and EBMs, click the AIA Reference Doc link on EBO and EBM detail pages in Oracle Enterprise Repository.

For more information about using the Oracle Enterprise Repository and configuring it to provide the AIA Reference Doc link, see *Oracle Fusion Middleware Developer's Guide for Oracle Application Integration Architecture Foundation Pack 11g Release 1*, "Configuring and Using Oracle Enterprise Repository as the Oracle AIA SOA Repository."

EBOs can be extended, for instance, to add new data elements. These extensions are protected and remain intact after a patch or an upgrade.

For more information, see *Oracle Fusion Middleware Concepts and Technologies Guide for Oracle Application Integration Architecture Foundation Pack 11g Release 1*, "Understanding Extensibility."

4.6 Integration Services

These services are delivered with this integration:

- ItemEBSV2
- CreateProductEbizReqABCImpl
- UpdateProductEbizReqABCImpl
- BatchLoadProductEbizReqABCImpl
- SyncItemListCRMOPProvABCImpl
- CreateItemEbizEventConsumer
- UpdateItemEbizEventConsumer
- BatchloadItemEbizEventConsumer

For more information, see *Oracle Fusion Middleware Developer's Guide for Oracle Application Integration Architecture Foundation Pack 11g Release 1*, "Configuring and Using Oracle Enterprise Repository as the Oracle AIA SOA Repository."

4.6.1 ItemEBSV2

ItemEBSV2 is a lightweight mediator routing service that exposes all of the enterprise operations that can be performed on an Item EBO.

The SyncItemList operation is provided by ItemEBSV2.

For SyncItem (Simple Product), whenever an item is created or updated in the Item master in Oracle E-Business Suite, a business event is raised to synchronize the item to CRM On Demand.

Synchronization is required only for items that belong to OE Item Validation Org that are customer orderable and have Item Type = {Model, Option Class, and Standard}. The business event does not discriminate between items based on this mentioned constraint-the event is triggered regardless of these constraints.

The ItemEBSV2 service uses these operations:

- Post Item Create: oracle.apps.ego.item.postItemCreate
- Post Item Update: oracle.apps.ego.item.postItemUpdate
- Item BatchLoad: oracle.apps.ego.ebi.itemLoad

For more information about this Oracle E-Business Suite, see *Oracle Fusion Middleware Developer's Guide for Oracle Application Integration Architecture Foundation Pack 11g Release 1*, "Designing and Developing EBSs" and *Oracle Fusion Middleware Concepts and Technologies Guide for Oracle Application Integration Architecture Foundation Pack 11g Release 1*, "Understanding EBSs."

4.6.2 CreateProductEbizReqABCImpl

The CreateProductEbizReqABCImpl service is a Business Process Execution Language (BPEL) process. It is responsible for calling the Oracle E-Business Suite Product web service based on the event payload to get the Oracle E-Business Suite Product Application Business Message (ABM) and for transforming the Oracle E-Business Suite Product ABM messages into the appropriate item EBM format and invoking the SyncItem Oracle E-Business Suite operation.

By default, an orderable product associated with the OE:Item Validation Org is synchronized to CRM On Demand. To bypass validation against the OE:Item Validation Org, the configuration property `BYPASS_ITEMVALIDATIONORG_FLAG` must be set to Y. The `INVENTORY_LOCATION_ID XREF` must be set up with all the OE:Item Validation Org. To synchronize nonorderable products, set the configuration property `PUBLISH_ALL_PRODUCT` to Y.

This is a single operation service. It accepts an Oracle E-Business Suite Product message as a request and does not return a response.

4.6.3 UpdateProductEbizReqABCImpl

The UpdateProductEbizReqABCImpl is a BPEL process that is responsible for calling the Oracle E-Business Suite Product web service based on the event payload to get the Oracle E-Business Suite Product ABM and transforming the Oracle E-Business Suite Product ABM messages into the appropriate Item EBM format and invoking the SyncItemList Oracle E-Business Suite operation. By default, an orderable product associated with the OE:Item validation organization is synchronized to CRM On Demand. To bypass validation against the OE:Item Validation Org, the configuration property `BYPASS_ITEMVALIDATIONORG_FLAG` must be set to Y. The `INVENTORY_LOCATION_ID XREF` must be set up with all the OE:Item Validation Org.

This is a single operation service. It accepts an Oracle E-Business Suite Product message as a request and does not return a response.

4.6.4 BatchLoadProductEbizReqABCImpl

The BatchLoadProductEbizReqABCImpl is a BPEL process that is responsible for calling the Oracle E-Business Suite Product web service based on the event payload to get the Oracle E-Business Suite Product ABM and transforming the Oracle E-Business Suite Product ABM messages into the appropriate Item EBM format and invoking the SyncItemList Oracle E-Business Suite operation. This service does not do any filtering of product; any product part of the event is published in the SyncItemList Oracle E-Business Suite operation.

This is a single operation service. It accepts an Oracle E-Business Suite product message as a request and does not return a response.

4.6.5 CreateItemEbizEventConsumer

The CreateItemEbizEventConsumer has an Oracle Apps adapter configured to listen for create business events with routing services.

One service with one operation is available to read the Oracle E-Business Suite message EbizSyncProductReqMsg from the Oracle AQ "WF_BPEL_Q": CreateItemEbizEventConsumer.

This service is implemented as a Mediator Component process with an Oracle Apps adapter for listening to business event and routing services.

4.6.6 UpdateItemEbizEventConsumer

The UpdateItemEbizEventConsumer has an Oracle Apps adapter configured to listen for update business events with routing services.

One service with one operation is available to read the Oracle E-Business Suite message EbizSyncProductReqMsg from the Oracle Advanced Queue (AQ) "WF_BPEL_Q": UpdateItemEbizEventConsumer.

This service is implemented as a Mediator Component process with an Oracle Apps adapter for listening to business events and routing services.

4.6.7 BatchloadItemEbizEventConsumer

The BatchloadItemEbizEventConsumer has an Oracle Apps adapter configured to listen for Batchload business events with routing services.

One service with one operation is available to read the Oracle E-Business Suite message EbizSyncProductReqMsg from the Oracle AQ "WF_BPEL_Q": BatchloadItemEbizEventConsumer

This service is implemented as a Mediator Component process with an Oracle Apps adapter for listening to business events and routing services.

Process Integration for Opportunity to Quote and Order Management

This chapter provides an overview of the process integration for quote and order management and includes the following sections:

- [Section 5.1, "Overview"](#)
- [Section 5.2, "Create Sales Quote Integration Flow"](#)
- [Section 5.3, "Create Sales Order Integration Flow"](#)
- [Section 5.4, "Oracle CRM On Demand Interfaces"](#)
- [Section 5.5, "Oracle E-Business Suite Interfaces"](#)
- [Section 5.6, "Core AIA Components"](#)
- [Section 5.7, "Integration Services"](#)

5.1 Overview

The Oracle Lead to Order Integration Pack for Oracle CRM On Demand and Oracle E-Business Suite PIP enables users within CRM On Demand to directly convert an opportunity in CRM On Demand to a quote in the Oracle CRM HTML Quoting module or to a quote or order within the Oracle Order Management (OM) module, passing specific details of the CRM On Demand opportunity to the CRM HTML quote, the Order Management quote, or the Order Management order.

Multiple quotes or orders can be associated with a single opportunity. After an opportunity has been converted to a quote or order, CRM On Demand users can navigate to a read-only view of the OM quote or order, or to a transactional view of the Oracle CRM HTML quote.

Note: You can implement only one quote or order management business process in each deployment: CRM On Demand Opportunity-to-HTML Quote or CRM On Demand Opportunity-to-OM Order or CRM On Demand Opportunity-to-OM Quote.

The process integration for order and quote management between Oracle E-Business Suite and CRM On Demand supports the following integration flows:

- **Create Sales Quote (CRM HTML quote or Order Management quote)**
Enables the creation of quotes from CRM On Demand to Oracle E-Business Suite.
- **Create Sales Order**

Enables the creation of orders from CRM On Demand to Oracle E-Business Suite.

When the Opportunity-to-Quote or Opportunity-to-Order conversion process is initiated, the following events occur:

1. The Opportunity-to-Quote or Opportunity-to-Order conversion process is initiated when a sales user clicks the New Quote or New Order button on the Opportunity Detail page in the respective Quote or Order applet.
2. A new record is inserted in the corresponding quote or order applet with a quote or order creation status of In Progress. The quote or order integration message, quote or order number values, quote or order created date, and quote or order ID are null at this point.
3. A configured workflow invokes an integration event and a transaction is placed in the CRM On Demand integration event Priority Queue.
4. A Business Process Execution Language (BPEL) process polls the CRM On Demand integration event Priority Queue at prescribed intervals and adds the event to the resequencer queue. The resequencer then dispatches each event to the appropriate services to create the quote or order within Oracle E-Business Suite.
5. A message is sent back to CRM On Demand indicating either that the quote or order creation process finished successfully, that is, the quote or order is created with a quote or order number, or that the quote or order creation process has failed, that is, the quote or order creation status is set to Failed with the reason noted in the quote or order Integration Message field.

When a quote or order is successfully created, the quote or order Creation Status value is set to Created. The quote or order created date and the quote or order ID are sent to CRM On Demand.

By default, orders are created in Oracle E-Business Suite with a status of Entered. However, if you require that an order be created under a different default status, you can set an alternate default order status in the Enterprise Business message (EBM).

For more information about setting the default status of orders, see [Section 6.3.3, "Changing the Default Status of New Orders in Oracle E-Business Suite"](#).

6. The quote or order creation process is asynchronous; sales users must query the Opportunity detail page again to review the status of the quote or order creation process.
7. After the quote or order is successfully created, sales users can review the OM quote or order details by clicking the order number, then clicking a configured web link that displays the Oracle E-Business Suite OM Quote or Order Details page.

Customers who have enabled the Preview object in CRM On Demand can access the OM Quote or Order Details page directly from the Preview dialog box by clicking the Preview button beside the Order number or placing their cursor on the order number in CRM On Demand, then clicking the configured web link in the Details page. Users are prompted for their Oracle E-Business Suite user credentials if no session to Oracle E-Business Suite is active.

For more information about configuring the web link, see [Section 6.4.1.3, "Create the Web Link to View Orders or Quotes in Oracle E-Business Suite"](#)

The following opportunity attributes are synchronized and passed to Oracle E-Business Suite:

- Opportunity Name

- Account
- Primary Contact
- Bill/Ship-To Address details
- CRM OD-Opportunity-Revenue Lines (optional)

5.1.1 Solution Assumptions and Constraints

These are the assumptions and constraints for the quote and order management integration:

1. Only quotes and orders created through the integration are represented within CRM On Demand. Users cannot view quotes or orders created outside of the integration from within the CRM On Demand quote and order object views.
2. Orders created from a quote are not represented within CRM On Demand. Only quotes and orders directly created from a CRM On Demand opportunity are represented within CRM On Demand.
3. Oracle recommends that the Delete privilege in CRM On Demand be granted only to administrative users and not to sales users.

If a quote or order conversion from an opportunity fails, the administrator or sales user must address the cause of the failure and resubmit the quote or order for creation. Quotes or orders that have failed to convert can be deleted by a user who has been granted the appropriate privileges.

4. Oracle E-Business Suite sales users who are assigned the Quoting responsibility must be configured as resources of type Employee or Partner to enable the Opportunity-to-HTML Quote conversion process.

Other resource types are not supported.

5. The following Order statuses from Oracle E-Business Suite are supported:
 - Entered
 - Booked

Orders are submitted with a status of Entered by default. Creating an order in Booked status requires more data validation.

6. Products on the CRM On Demand Opportunity must be synchronized from Oracle E-Business Suite to CRM On Demand before order or quote creation is attempted; otherwise, the order or quote creation process fails if product data is not passed to the quote or order.
7. Oracle E-Business Suite pricing is not integrated to CRM On Demand and is not used to price products that are associated with a CRM On Demand opportunity.

When you create an opportunity in CRM On Demand, you can manually enter pricing information. When you convert that opportunity to a quote or sales order, which is created in Oracle E-Business Suite, the quote or sales order uses the pricing information that is defined and configured in Oracle E-Business Suite.
8. The Opportunity field in the Oracle CRM HTML quoting module does not refer to the CRM On Demand opportunity.
9. The Quote and Order objects within CRM On Demand were introduced for the Oracle Lead to Order Integration Pack for Oracle CRM on Demand and Oracle E-Business Suite Process Integration Pack (PIP).

Extensions or additional integration to these objects is not supported.

10. Orders originating from a CRM On Demand opportunity are marked as such, that is, a CRM On Demand opportunity is converted to an Oracle E-Business Suite quote, and the Oracle E-Business Suite quote is converted to a sales order in Order Management.

The Order Source Reference field for the sales order form within Order Management is populated with the CRM On Demand opportunity ID.

5.2 Create Sales Quote Integration Flow

This integration flow uses the following interfaces:

- SalesQuoteEBS
- SalesQuoteResponseEBS
- SalesQuoteOrchestrationEBS
- SalesQuoteOrchestrationResponseEBS
- InterfaceSalesQuoteToFulfillmentEBF
- InterfaceSalesQuoteToCustomerEBF
- CreateSalesQuoteEbizProvABCImpl
- ProcessSalesQuoteCRMODReqABCImpl
- ProcessSalesOrderCRMODReqABCImpl
- CRMOnDemandPriorityIntegrationEventProcessor

[Figure 5-1](#) illustrates the Create Sales Quote integration flow:

Figure 5-1 Create Sales Quote Integration Flow

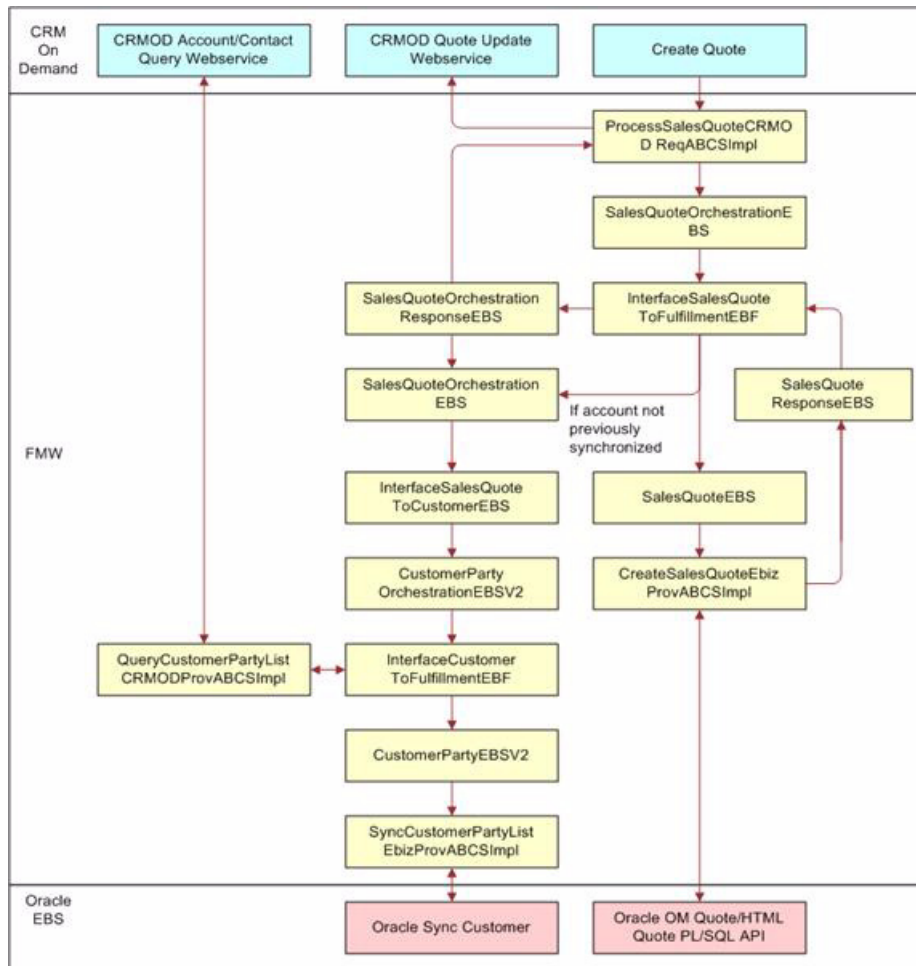

When you initiate the Create Sales Quote process, the following events occur:

1. The `ProcessSalesQuoteCRMODReqABCSImpl` service invokes the `ProcessSalesQuote` operation of `SalesQuoteOrchestrationEBS`, with `ProcessSalesQuoteEBM` as input.
The `SalesQuoteOrchestrationEBS` then routes `ProcessSalesQuoteEBM` to the `InterfaceSalesQuoteToFulfillmentEBF` enterprise business flow.
2. If the customer associated with the opportunity has not been synchronized to Oracle E-Business Suite previously, then `InterfaceSalesQuoteToFulfillmentEBF` invokes `InterfaceSalesQuoteToCustomer` of `SalesQuoteOrchestrationEBS`.

The `InvokeInterfaceSalesQuoteToCustomer` property in the `AIAConfigurationProperties.xml` file (located under the `InterfaceSalesQuoteToFulfillmentEBF` service) and the account synchronization history determine whether customer synchronization occurs. If you change the `InvokeInterfaceSalesOrderToCustomer` property value to false, customer synchronization does not occur.

3. The `InterfaceSalesQuoteToCustomerEBF` process transforms `ProcessSalesQuoteEBM` into `ProcessCustomerPartyListEBM`, which contains a list of the account, contact, and address IDs that were referenced on the quote.

4. InterfaceSalesQuoteToCustomerEBF invokes InterfaceCustomerToFulfillment of CustomerPartyOrchestrationEBSV2, which then routes ProcessCustomerPartyListEBM to InterfaceCustomerToFulfillmentEBF.
5. InterfaceCustomerToFulfillmentEBF invokes QueryCustomerPartyListCRMODProvABCImpl using CustomerPartyEBSV2 to query CRM On Demand for the values of the account, account billing, and shipping address and the opportunity primary contact fields.
6. Upon receiving a response from the QueryCustomerPartyListCRMODProvABCImpl service, InterfaceCustomerToFulfillmentEBF invokes SyncCustomerPartyListEbizProvABCImpl using CustomerPartyEBSV2 to synchronize the account, opportunity primary contact, primary billing, and shipping address values to Oracle E-Business Suite.
7. InterfaceSalesQuoteToFulfillmentEBF performs a transformation to generate CreateSalesQuoteEBM, which is used to invoke CreateSalesQuote of SalesQuoteEBS.
8. SalesQuoteEBS routes CreateSalesQuote invocation to CreateSalesQuoteEbizProvABCImpl.

CreateSalesQuoteEbizProvABCImpl transforms CreateSalesQuoteEBM into the Oracle Process Order Application Business Message (ABM) to create an Order Management quote or into the Oracle Create Sales Quote ABM to create an Oracle CRM HTML quote, depending on the value specified for the CRMQuoteProvider property in the AIA_HOME/aia_instance/instancename/AIAMetaData/config/AIAConfigurationProperties.xml file.

For more information about configuring the CRMQuoteProvider property, see [Section 6.4.1.1, "Enabling the Order Management Quoting Module"](#).

9. If an Order Management quote is created:
 - a. CreateSalesQuoteEbizProvABCImpl invokes the ProcessOrder operation of ProcessSalesOrderEbizAdapter.

ProcessSalesOrderEbizAdapter invokes the appropriate Oracle Process Order PL/SQL Application Program Interface (API), which results in the creation of an OM quote in Oracle E-Business Suite. The OM Quote creation uses the OM Order creation API.
 - b. Upon completion and response from ProcessSalesOrderEbizAdapter, CreateSalesQuoteEbizProvABCImpl generates the response EBM (during which the Oracle IDs are added to the XREF table) and replies to SalesQuoteResponseEBS, which in turn is routed back to InterfaceSalesQuoteToFulfillmentEBF.
 - c. InterfaceSalesQuoteToFulfillmentEBF sends a response to SalesQuoteOrchestrationResponseEBS, which in turn routes a response to ProcessSalesQuoteCRMODReqABCImpl so that it can update the quote created date, ID, and number values on the CRM On Demand quote record.
10. If an Oracle CRM HTML quote is created:
 - CreateSalesQuoteEbizProvABCImpl invokes the Create Quote operation of the CreateSalesQuoteEbizAdapter service. This service invokes the appropriate Oracle Create Quote PL/SQL API, which results in the creation of a CRM quote in Oracle E-Business Suite. The PL/SQL API for R12 version has a different number of parameters than in 11.5.10, so the R12 service name is

CreateSalesQuoteEbizR12VersionAdapter. The service configuration parameter Routing.CreateSalesQuoteEbizAdapter.EBIZ_01.EndpointURL must be set accordingly.

For more information about setting up Routing.CreateSalesQuoteEbizAdapter.EBIZ_01.EndpointURL, see *Oracle Fusion Middleware Concepts and Technologies Guide for Oracle Application Integration Architecture Foundation Pack 11g Release 1*, "Installing the Lead to Order: CRM OD - EBS PIP," Updating the AIA Configuration Properties.

- Upon completion and response from CreateSalesQuoteEbizAdapter, CreateSalesQuoteEbizProvABCImpl generates the response EBM (during which the Oracle IDs are added to the cross-reference table) and replies to SalesQuoteResponseEBS, which in turn is routed back to InterfaceSalesQuoteToFulfillmentEBF. InterfaceSalesQuoteToFulfillmentEBF sends a response back to SalesQuoteOrchestrationResponseEBS, which in turn routes a response EBM back to ProcessSalesQuoteCRMReqABCImpl so that it can update the quote created date, ID, and number values to the On Demand Quote record.

5.3 Create Sales Order Integration Flow

The Create Sales Order integration flow enables sales users to convert an opportunity in CRM On Demand to an order in the Order Management (OM) module, taking context from the CRM On Demand opportunity and passing specific details to the Oracle E-Business Suite order.

After sales orders are submitted to Oracle E-Business Suite, they are frozen in CRM On Demand. When the order has been successfully submitted to Oracle E-Business Suite, the order creation status is updated in CRM On Demand. The order submission initiates the synchronization of accounts from CRM On Demand to Oracle E-Business Suite if the accounts were not synchronized to Oracle E-Business Suite previously.

This integration flow uses the following interfaces:

- SalesOrderEBSV2
- SalesOrderResponseEBSV2
- SalesOrderOrchestrationEBSV2
- SalesOrderOrchestrationResponseEBSV2
- InterfaceSalesOrderToFulfillmentEBF
- InterfaceSalesOrderToCustomerEBF
- InterfaceCustomerToFulfillmentEBF
- SyncCustomerPartyListEbizProvABCImpl
- QueryCustomerPartyListCRMReqABCImpl
- CreateSalesOrderEbizProvABCImpl
- ProcessSalesOrderCRMReqABCImpl
- CRMReqPriorityIntegrationEventProcessor

Figure 5–2 illustrates the Create Sales Order integration flow:

Figure 5–2 Create Sales Order Integration Flow

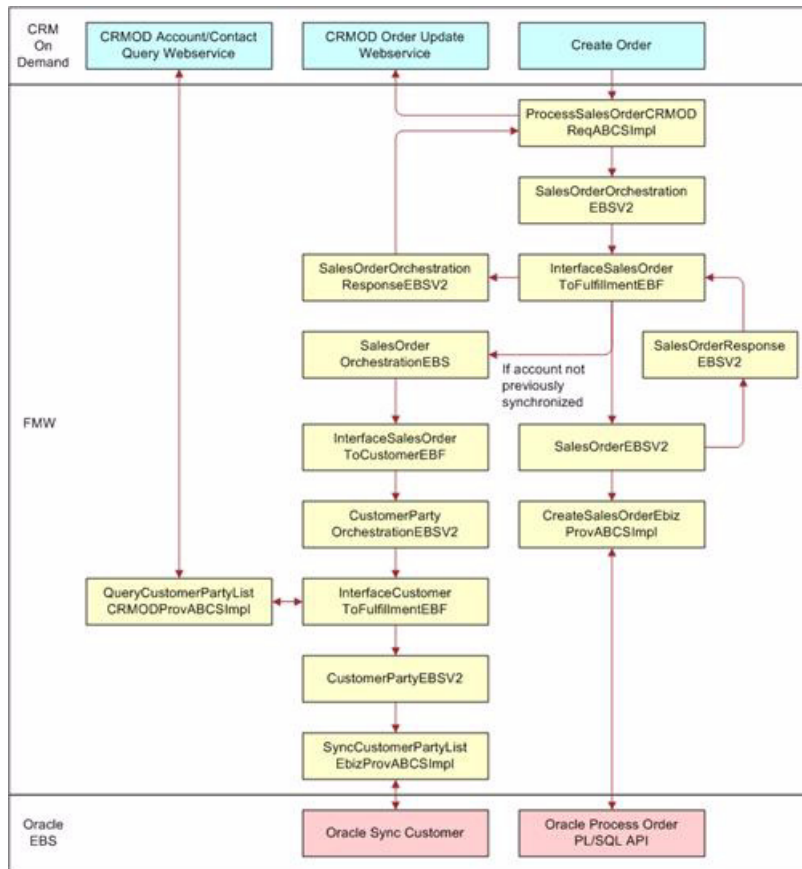

When you initiate the Create Sales Order process, the following events occur:

1. ProcessSalesOrderCRMReqABCImpl invokes the ProcessSalesOrder operation of SalesOrderOrchestrationEBSV2, with ProcessSalesOrderEBM as input.

SalesOrderOrchestrationEBSV2 then routes ProcessSalesOrderEBM to the InterfaceSalesOrderToFulfillmentEBF enterprise business flow.

2. If the customer associated with the opportunity has not been synchronized to Oracle E-Business Suite previously, InterfaceSalesOrderToFulfillmentEBF invokes the InterfaceSalesOrderToCustomer operation of SalesOrderOrchestrationEBSV2.

The InvokeInterfaceSalesOrderToCustomer property in the AIAConfigurationProperties.xml file (located under the InterfaceSalesOrderToFulfillmentEBF service) and the account synchronization history of the account determine whether customer synchronization occurs. The default value of the InvokeInterfaceSalesOrderToCustomer property is true. If you change this value to false, customer synchronization never occurs.

3. The InterfaceSalesOrderToCustomerEBFV2 process transforms ProcessSalesOrderEBM into ProcessCustomerPartyListEBM, which contains a list of the account, contact, and address IDs that were referenced on the order.
4. The InterfaceSalesOrderToCustomerEBFV2 invokes the InterfaceCustomerToFulfillment operation of CustomerPartyOrchestrationEBSV2, which then routes ProcessCustomerPartyListEBM to InterfaceCustomerToFulfillmentEBF.

5. `InterfaceCustomerToFulfillmentEBF` invokes `QueryCustomerPartyListCRMODProvABCSImpl` using `CustomerPartyEBSV2` to query CRM On Demand for the values of the account, account billing and shipping address, and opportunity primary contact fields.
6. Upon receiving a response from `QueryCustomerPartyListCRMODProvABCSImpl`, `InterfaceCustomerToFulfillmentEBF` invokes `SyncCustomerPartyListEbizProvABCSImpl` using `CustomerPartyEBSV2` to synchronize the account, opportunity primary contact, and primary billing and shipping address values to Oracle E-Business Suite.
7. `InterfaceSalesOrderToFulfillmentEBF` performs a transformation to generate `CreateSalesOrderEBM`, which is used to invoke the Create Sales Order operation of `SalesOrderEBSV2`.
8. `SalesOrderEBSV2` routes Create Sales Order invocation to `CreateSalesOrderEbizProvABCSImpl`.

`CreateSalesOrderEbizProvABCSImpl` transforms `CreateSalesOrderEBM` into the Oracle Process Order Application Business message (ABM) to create an Order Management order.

- a. `CreateSalesOrderEbizProvABCSImpl` invokes the `ProcessOrder` operation of `ProcessSalesOrderEbizAdapter`.
- b. Upon completion and response from `ProcessSalesOrderEbizAdapter`, `CreateSalesOrderEbizProvABCSImpl` generates the response EBM (during which the Oracle IDs are added to the cross-reference table) and replies to `SalesOrderResponseEBSV2`, which in turn is routed back to `InterfaceSalesOrderToFulfillmentEBF`.

`InterfaceSalesOrderToFulfillmentEBF` sends a response to `SalesOrderOrchestrationResponseEBSV2`, which in turn routes a response EBM back to `ProcessSalesOrderCRMODReqABCSImpl` so that it can update the order created date, order ID, and order number values to the CRM On Demand order record.

5.4 Oracle CRM On Demand Interfaces

These CRM On Demand web services are available for the Opportunity-to-Quote and Opportunity-to-Order process integration flows:

- `document/urn:crmondemand/ws/ecbs/order/10/2004:OrderUpdate`
- `document/urn:crmondemand/ws/ecbs/order/10/2004:OrderQueryPage`
- `document/urn:crmondemand/ws/ecbs/quote/10/2004:QuoteUpdate`
- `document/urn:crmondemand/ws/ecbs/quote/10/2004:QuoteQueryPage`

5.5 Oracle E-Business Suite Interfaces

The Oracle E-Business Suite inbound web services are available for the Opportunity-to-Quote and Opportunity-to-Order process integration flows:

- `Process Sales Order service (OE_INBOUND_INT.PROCESS_ORDER_25)`
- `CreateSalesQuoteService (ASO_QUOTE_EBIZAD.CREATE_QUOTE_SERVICE)`

5.6 Core AIA Components

The Quote and Order Management integration flow uses the following delivered core components:

- SalesQuoteEBO
- ProcessSalesQuoteEBM
- ProcessSalesQuoteResponseEBM
- CreateSalesQuoteEBM
- CreateSalesQuoteResponseEBM
- CustomerPartyEBO
- ProcessCustomerPartyListEBM
- ProcessCustomerPartyListResponseEBM
- QueryCustomerPartyListEBM
- SyncCustomerPartyListEBM
- SalesOrderEBO
- ProcessSalesOrderEBM
- ProcessSalesOrderResponseEBM
- CreateSalesOrderEBM
- CreateSalesOrderResponseEBM

The core Enterprise Business Object (EBO) and EBM XML Schema Definition (XSD) files can be located by EBO within this parent folder: \$AIA_HOME/AIAMetaData/AIAComponents/EnterpriseObjectLibrary/Core/EBO/.

The core Oracle E-Business Suite Web Service Definition Language (WSDL) files can be located by EBO within this parent folder: \$AIA_HOME/AIAMetaData/AIAComponents/EnterpriseBusinessServiceLibrary/Core/EBO/.

For detailed documentation of individual EBOs and EBMs, click the AIA Reference Doc link on EBO and EBM detail pages in Oracle Enterprise Repository.

For more information about using the Oracle Enterprise Repository and configuring it to provide the AIA Reference Doc link, see *Oracle Fusion Middleware Developer's Guide for Oracle Application Integration Architecture Foundation Pack 11g Release 1*, "Configuring and Using Oracle Enterprise Repository as the Oracle AIA SOA Repository."

EBOs can be extended, for instance, to add new data elements. These extensions are protected and remain intact after a patch or an upgrade.

For more information, see *Oracle Fusion Middleware Concepts and Technologies Guide for Oracle Application Integration Architecture Foundation Pack 11g Release 1*, "Understanding Extensibility."

5.7 Integration Services

These services are delivered with this integration:

- SalesQuoteEBS
- SalesQuoteResponseEBS

- SalesQuoteOrchestrationEBS
- SalesQuoteOrchestrationResponseEBS
- InterfaceSalesQuoteToFulfillmentEBF
- InterfaceSalesQuoteToCustomerEBF
- CreateSalesQuoteEbizProvABCImpl
- ProcessSalesQuoteCRMODReqABCImpl
- CRMOnDemandPriorityIntegrationEventProcessor
- SalesOrderEBSV2
- SalesOrderResponseEBSV2
- SalesOrderOrchestrationEBSV2
- SalesOrderOrchestrationResponseEBSV2
- InterfaceSalesOrderToFulfillmentEBF
- InterfaceSalesOrderToCustomerEBF
- InterfaceCustomerToFulfillmentEBF
- SyncCustomerPartyListEbizProvABCImpl
- QueryCustomerPartyListCRMODProvABCImpl
- CreateSalesOrderEbizProvABCImpl
- ProcessSalesOrderCRMODReqABCImpl
- ProcessSalesOrderCRMODReqABCImpl
- CustomerPartyOrchestrationEBSV2
- ProcessSalesOrderEbizAdapter

For more information, see *Oracle Fusion Middleware Developer's Guide for Oracle Application Integration Architecture Foundation Pack 11g Release 1*, "Configuring and Using Oracle Enterprise Repository as the Oracle AIA SOA Repository."

5.7.1 SalesQuoteEBS

The SalesQuoteEBS service provides the basic request operations that can be performed against the SalesQuote EBO. This service is invoked for both the CRM HTML and the Order Management Create Quote integration flows.

The SalesQuoteEBS service uses the CreateSalesQuote operation.

5.7.2 SalesQuoteResponseEBS

The SalesQuoteEBS and SalesQuoteResponseEBS services provide the basic request and response operations that can be performed against the SalesQuote EBO. These services are invoked for both the CRM HTML and the Order Management Create Quote integration flows.

The SalesQuoteEBS service uses the CreateSalesQuoteResponse operation.

5.7.3 SalesQuoteOrchestrationEBS

The SalesQuoteOrchestrationEBS provides request operation routing to process a sales quote through a business process flow. This service is invoked as part of the Create Quote integration flow.

The SalesQuoteOrchestrationEBS service uses these operations:

- ProcessSalesQuote
This operation is routed to the InterfaceSalesQuoteToFulfillment operation of the same Oracle E-Business Suite. To insert a custom orchestration process into the integration flow, define a routing rule to route the ProcessSalesQuote operation to the custom orchestration process instead of to the InterfaceSalesQuoteToFulfillment.
- InterfaceSalesQuoteToFulfillment
This operation is routed to the InterfaceSalesQuoteToFulfillmentEBF.
- InterfaceSalesQuoteToCustomer
This operation is routed to the InterfaceSalesQuoteToCustomerEBF.

5.7.4 SalesQuoteOrchestrationResponseEBS

SalesQuoteOrchestrationResponseEBS provides response operation routing to process a sales quote through a business process flow. This service is invoked as part of the Create Quote integration flow. SalesQuoteOrchestrationResponseEBS exposes the asynchronous response and fault operations for each of the request operations.

SalesQuoteOrchestrationResponseEBS uses these operations:

- InterfaceSalesQuoteToFulfillmentResponse
This operation is routed to the caller of the ProcessSalesQuote operation (ProcessSalesQuoteCRMReqABCSImpl).
- InterfaceSalesQuoteToCustomerResponse
This operation is routed to the caller of the InterfaceSalesQuoteToCustomer operation (InterfaceSalesQuoteToFulfillmentEBF).

5.7.5 InterfaceSalesQuoteToFulfillmentEBF

InterfaceSalesQuoteToFulfillmentEBF interfaces a sales quote to a back-office fulfillment system. This service is invoked as part of the Create Quote integration flow.

At a high level, the InterfaceSalesQuoteToFulfillmentEBF business process flow performs two actions:

- Interfaces the customer accounts from the quote to the fulfillment system by invoking the InterfaceSalesQuoteToCustomerEBF service
- Creates the quote in the fulfillment system using the SalesQuoteEBS Create operation

The InterfaceSalesQuoteToFulfillmentEBF business process is an asynchronous process. Upon completion, it invokes the InterfaceSalesQuoteToFulfillmentResponse operation of the SalesQuoteOrchestrationResponseEBS.

Two inbound operations are in the InterfaceSalesQuoteToFulfillmentEBF process:

- The InterfaceSalesQuoteToFulfillment operation initiates the InterfaceSalesQuoteToFulfillmentEBF process.

- The CreateSalesQuoteResponse operation receives the asynchronous callbacks from the other service operations that the InterfaceSalesQuoteToFulfillmentEBF process invokes.

5.7.6 InterfaceSalesQuoteToCustomerEBF

The InterfaceSalesQuoteToCustomerEBF service is responsible for extracting the list of distinct customer accounts, addresses, and contacts from the quote and invoking the InterfaceCustomerToFulfillmentEBF service. This service is invoked as part of the Create Quote integration flow.

The InterfaceSalesQuoteToCustomerEBF enterprise business flow is implemented as an asynchronous request and callback BPEL process.

5.7.7 CreateSalesQuoteEbizProvABCImpl

The CreateSalesQuoteEbizProvABCImpl service is a provider Application Business Connector Service (ABCS) implementation that creates either an Oracle E-Business Suite Order Management quote or an Oracle CRM HTMLQuoting module quote. This service is invoked as part of the Create Quote integration flow.

The CreateSalesQuoteEbizProvABCImpl business process is an asynchronous process. Upon completion, the CreateSalesQuoteEbizProvABCImpl service invokes the CreateSalesQuoteResponse operation of the SalesQuoteResponseEBS service.

5.7.8 ProcessSalesQuoteCRMReqABCImpl

The ProcessSalesQuoteCRMReqABCImpl service receives the Quote Create Integration event from CRM On Demand and then queries CRM On Demand to obtain the opportunity, associated accounts, and contact details. The message is transformed into a ProcessSalesQuoteEBM service and the SalesQuoteOrchestrationEBS service is invoked.

After the ProcessSalesQuoteCRMReqABCImpl service receives the response from the CreateSalesQuoteEbizProvABCImpl service, the process updates the CRM On Demand quote details with the Oracle E-Business Suite Quote ID and the quote creation date and sets the status to Created.

If the Opportunity-to-Quote conversion fails, the CRM On Demand Error Handler is invoked and it updates the quote status in CRM On Demand to Failed.

For this service to function properly, these criteria must be met:

- The quote ID must exist in the CRM On Demand message.
- The host ID must exist in the CRM On Demand message.

5.7.9 CRMOnDemandPriorityIntegrationEventProcessor

The CRMOnDemandPriorityIntegrationEventProcessor service is invoked by the CRMOnDemandActivationAgent service. The inputs to CRMOnDemandPriorityIntegrationEventProcessor are 'EventCount' and 'QueueName'.

The CRMOnDemandPriorityIntegrationEventProcessor service then sends the event messages to the PriorityCRMModRoutingService, the resequencer that acts as the middle-tier queue. The resequencer then routes events one by one to either the ProcessSalesQuoteCRMReqABCImpl or the ProcessSalesOrderCRMReqABCImpl service for processing.

5.7.10 SalesOrderEBSV2

The SalesOrderEBSV2 service provides basic request and response operations that can be performed against the SalesOrderEBO. This service is invoked as part of the create order integration flow.

- The SalesOrderEBSV2 services use the CreateSalesOrder operation.
- The SalesOrderEBSV2 service is implemented as a Mediator Component routing service.

5.7.11 SalesOrderResponseEBSV2

The SalesOrderResponseEBSV2 service provides the basic response operations that can be performed against the SalesOrderEBO. This service is invoked as part of the create order integration flow.

The SalesOrderResponseEBSV2 service uses the CreateSalesOrderResponse operation.

The SalesOrderResponseEBSV2 service is implemented as a Mediator Component routing service.

5.7.12 SalesOrderOrchestrationEBSV2

The SalesOrderOrchestrationEBSV2 and SalesOrderOrchestrationResponseEBSV2 provides request and response operation routing to process a sales order through a business process flow. These services are invoked as part of the create order integration flow.

The SalesOrderOrchestrationResponseEBSV2 service exposes the asynchronous response operations for each of the request operations.

These are the SalesOrderOrchestrationEBSV2 operations:

- ProcessSalesOrder
This operation is routed to the InterfaceSalesOrderToFulfillment operation of the same Oracle E-Business Suite.
You can insert a custom orchestration process into the flow by defining a routing rule that is routed to the custom orchestration process rather than the InterfaceSalesOrderToFulfillment operation.
- InterfaceSalesOrderToFulfillment
This operation routes to the InterfaceSalesOrderToFulfillmentEBF.
- InterfaceSalesOrderToCustomer
This operation routes to the InterfaceSalesOrderToCustomerEBFV2.

These are the SalesOrderOrchestrationResponseEBSV2 operations:

- ProcessSalesOrderResponse
This operation is intended to route to the caller of the ProcessSalesOrder operation as indicated in the EBM header. However, no routing targets are provided because the ProcessSalesOrderCRMODReqABCImpl does not expect to receive a response.
- InterfaceSalesOrderToFulfillmentResponse
This operation routes to the ProcessSalesOrderResponse operation as indicated in the EBM header.

- InterfaceSalesOrderToCustomerResponse

This operation routes to the caller of the InterfaceSalesOrderToCustomer operation (InterfaceSalesOrderToFulfillmentEBF) as indicated in the EBM header.

5.7.13 CustomerPartyOrchestrationEBSV2

The CustomerPartyOrchestrationEBSV2 service provides a request operation that can be performed against the order to synchronize the customer information by invoking InterfaceCustomerToFulfillmentEBF. This service is invoked as part of the Create Order process.

The CustomerPartyOrchestrationEBSV2 service uses the InterfaceCustomerToFulfillment operation.

5.7.14 InterfaceSalesOrderToFulfillmentEBF

The InterfaceSalesOrderToFulfillmentEBF service is an Enterprise Business Flow (EBF) that interfaces a sales order to a back-office fulfillment system. This service is invoked as part of the create order integration flows.

This process performs the following high-level actions:

1. Interfaces customer accounts from the order to the fulfillment system.

The InterfaceSalesOrderToCustomerEBFV2 is invoked for this. This step can be configured so that it can be suppressed.

2. Creates the order in the fulfillment system using the SalesOrderEBSV2 Create operation.

The InterfaceSalesOrderToFulfillmentEBF is an asynchronous BPEL process. Upon completion, it invokes the InterfaceSalesOrderToFulfillmentResponse operation of the SalesOrderOrchestrationResponseEBSV2.

This EBF has five inbound operations. The first initiates the process, and the remaining operations receive the asynchronous callbacks from the other service operations that this process invokes:

- InterfaceSalesOrderToFulfillment
- InterfaceSalesOrderToCustomerResponse
- CreateSalesOrderResponse
- UpdateSalesOrderResponse
- SyncSalesOrderListResponse

These are the transformations carried out by the service:

- ProcessSalesOrderEBM to CreateSalesOrderEBM
- ProcessSalesOrderEBM and CreateSalesOrderResponseEBM to UpdateSalesOrderEBM

5.7.15 InterfaceSalesOrderToCustomerEBF

The InterfaceSalesOrderToCustomerEBFV2 service extracts the list of distinct customer accounts, addresses, and contacts from the order and invokes the InterfaceCustomerToFulfillmentEBF service. This service is invoked as part of the Create Order or Sync Revised Order integration flow.

The `InterfaceSalesOrderToCustomerEBFV2` enterprise business flow is implemented as an asynchronous request+callback BPEL process.

These are the transformations carried out by the `InterfaceSalesOrderToCustomerEBF`:

- `ProcessSalesOrderEBM` to `ProcessCustomerPartyListEBM`
This transformation must pass a list of accounts referenced in the order (for example, the order header-level and line-level accounts) and the bill-to and ship-to addresses referenced for each account. This list must not contain duplicates.
- `ProcessSalesOrderEBM + ProcessCustomerPartyListResponseEBM` to `ProcessSalesOrderResponseEBM`
This transformation passes through success or error messages.

5.7.16 `InterfaceCustomerToFulfillmentEBF`

For a description of this service, see [Section 3.8.3](#), "`InterfaceCustomerToFulfillmentEBF`".

5.7.17 `SyncCustomerPartyListEbizProvABCImpl`

For a description of this service, see [Section 3.8.6](#), "`SyncCustomerPartyListEbizProvABCImpl`".

5.7.18 `QueryCustomerPartyListCRMODProvABCImpl`

For a description of this service, see [Section 3.8.19](#), "`QueryCustomerPartyListCRMODProvABCImpl`".

5.7.19 `CreateSalesOrderEbizProvABCImpl`

The `CreateSalesOrderEbizProvABCImpl` service provides the Oracle E-Business Suite implementation for the `CreateSalesOrder` operation of the `SalesOrderEBSV2`. This service is invoked as part of the create order integration flow using the `CreateSalesOrder` operation of the `SalesOrderEBSV2`.

This service invokes the Process Sales Order PL/SQL API in Oracle E-Business Suite using the `ProcessSalesOrderEbizAdapter` service registered in Mediator Component.

When complete, the `CreateSalesOrderEbizProvABCImpl` service invokes the `CreateSalesOrderResponse` operation of the `SalesOrderResponseEBSV2`.

These are the transformations:

- `CreateSalesOrderEBM` to `ProcessSalesOrder ABM`.
- `ProcessSalesOrderResponse ABM` to `CreateSalesOrderResponseEBM`.

The `CreateSalesOrderEbizProvABCImpl` application business connector service is implemented as an asynchronous BPEL process.

The `ORDER_HOLD_ID` service is an inbound Advanced Queue (AQ) adapter service; it does not have a public interface. The service is initiated by Mediator Component when the subscription event occurs.

5.7.20 ProcessSalesOrderCRMODReqABCImpl

The ProcessSalesOrderCRMODReqABCImpl service receives the Order Create Integration event from CRM On Demand and then queries CRM On Demand to obtain the opportunity and associated account and contact details.

The ProcessSalesOrderCRMODReqABCImpl service then transforms the message to a ProcessSalesOrderEBM service and invokes the SalesOrderOrchestrationEBS service. After it receives a response from the CreateSalesOrderEbizProvABCImpl process, it updates the CRM On Demand order details with the Oracle E-Business Suite order ID, order creation date, and status. If the Opportunity-to-Order conversion fails, the CRM On Demand Error Handler is invoked and it updates the order status in CRM On Demand to Failed.

For this service to function properly, these criteria must be met:

- The order ID must exist in the CRM On Demand message.
- The host ID must exist in the CRM On Demand message.

Part II

Implementing the Delivered Integrations

This part contains the following chapters:

- [Chapter 6, "Configuring Oracle Lead to Order Integration Pack for Oracle CRM On Demand and Oracle E-Business Suite"](#)
- [Chapter 7, "Configuring and Mapping Custom Fields in Oracle CRM On Demand"](#)

Configuring Oracle Lead to Order Integration Pack for Oracle CRM On Demand and Oracle E-Business Suite

This chapter includes the following sections:

- [Section 6.1, "Prerequisites"](#)
- [Section 6.2, "Data Requirements"](#)
- [Section 6.3, "Setting Up Oracle E-Business Suite"](#)
- [Section 6.4, "Setting Up Oracle CRM On Demand"](#)
- [Section 6.5, "Working with Domain Value Maps"](#)
- [Section 6.6, "Working with Cross-References"](#)
- [Section 6.7, "Handling Errors"](#)
- [Section 6.8, "Viewing EIMs"](#)
- [Section 6.9, "Configuring the Oracle Lead to Order Integration Pack for Oracle CRM On Demand and Oracle E-Business Suite PIP"](#)

6.1 Prerequisites

This section discusses prerequisites and includes the following topics:

- [Section 6.1.1, "Customer Management Prerequisites"](#)
- [Section 6.1.2, "Product Management Prerequisites"](#)
- [Section 6.1.3, "Opportunity to Quote and Order Prerequisites"](#)

6.1.1 Customer Management Prerequisites

The prerequisites include:

- The customer management process integration does not have a dependency on other processes being run; however, the Organization cross-reference must be set up first.

For more information about setting up cross-references, see [Appendix C, "Settings for Multi-Org Implementation"](#)

You do not have to perform this step if you are using Oracle E-Business Suite Release 11.5.10.2.

- If account synchronization is to occur in near real time, you must schedule the TCA Raise Business Event concurrent program to run at specified intervals.

6.1.2 Product Management Prerequisites

The process integration for product management has no prerequisites.

6.1.3 Opportunity to Quote and Order Prerequisites

The prerequisites include:

- In CRM On Demand, you must enable the Opportunity-to-Quote or the Opportunity-to-Order business process as described in "Implementing the Opportunity to Quote or Order Business Process."
- Products are synchronized from Oracle E-Business Suite to CRM On Demand.
- Customer information is synchronized between Oracle E-Business Suite and CRM On Demand.

6.2 Data Requirements

Data requirements indicate the mandatory data that must be provided to make the integration flows successful.

This section includes the following topics:

- [Section 6.2.1, "Data Requirements for Customer Management"](#)
- [Section 6.2.2, "Data Requirements for Product Management"](#)
- [Section 6.2.3, "Data Requirements for Opportunity to Quote and Order"](#)

6.2.1 Data Requirements for Customer Management

The data requirements include:

- Oracle E-Business Suite profile options must be specified.
 - For Oracle E-Business Suite Release 12.1.1 or later, you must specify the MO: Operating Unit profile option.
 - For Oracle E-Business Suite Release 11.5.10CU2 and Release 12.1.1 or later, the values of the Auto Generate Customer Number and Auto Generate Site Number EBS profile parameters are set to Y at the operating unit level so that customer number and site number are automatically generated in EBS.
- Address data to be synchronized must have address line 1, city, state, and zip code.
- Locations cannot be shared by different organization parties in Oracle E-Business Suite, and addresses cannot be shared between accounts in CRM On Demand.
- In Oracle E-Business Suite, the contact should be associated at the account level only.

For the Order Management Application Programming Interface (API) to process the contact, it should not be associated at multiple levels of an account, for example, not at the account site (address) level.

If the contact used in CRM On Demand during Order submit is associated with several accounts and contact points (phone numbers or email address) are present,

then order submission is not supported because the Oracle E-Business Suite API for contact update or create does not support shared contact points.

6.2.2 Data Requirements for Product Management

Only items associated with an Oracle E-Business Suite OE Item Validation Organization are synchronized from Oracle E-Business Suite to CRM. You must add the IDs of the validation organizations to the INVENTORY_LOCATION_ID cross-reference table.

For more information about adding organization IDs to the INVENTORY_LOCATION_ID cross-reference table, see *Oracle Fusion Middleware Installation and Upgrade Guide for Oracle Application Integration Architecture Foundation Pack 11g Release 1*.

6.2.3 Data Requirements for Opportunity to Quote and Order

The data requirements include:

- To convert an opportunity to a quote or order, you must supply the account details with the opportunity.

Primary contact and product revenue line details are optional.

- If you have implemented Oracle CRM HTML quoting, you must set the value of the ASO: Automatic Sales Team Assignment profile option to NONE.

6.3 Setting Up Oracle E-Business Suite

This section describes the tasks that you must perform in Oracle E-Business Suite (Oracle E-Business Suite) to implement the Oracle Lead to Order Integration Pack for Oracle CRM On Demand and Oracle E-Business Suite PIP and discusses how to:

- Change the email address.
- Grant access to the 360 Degree view in Oracle E-Business Suite.
- Change the default status of new orders in Oracle E-Business Suite.
- Assign sales rep.

Note: Ensure that you have applied all of the Oracle E-Business Suite patches listed in *Oracle Fusion Middleware Concepts and Technologies Guide for Oracle Application Integration Architecture Foundation Pack 11g Release 1*, "Software and Hardware Requirements."

6.3.1 Changing the Email Address

When CRM On Demand is configured to implement the CRM HTML quoting integration, the sales user email ID in CRM On Demand must match the sales person's email ID in his or her JFT Resource profile in Oracle E-Business Suite (specifically, it must match the source_email value in the jtf_rs_resource_extns table in Oracle E-Business Suite). This topic describes how to identify the email resource ID of a sales person in Oracle E-Business Suite so that you can ensure that it matches the sales user's email address within CRM On Demand.

CRM HTML quoting requires that the sales person resource ID be used to create a quote in Oracle E-Business Suite. The quote that is created is associated with the ID of

the sales person, and to view the quote in Oracle E-Business Suite, the sales person's login ID must be used.

CRM On Demand sends the sales person's email address in the request to create the quote. The email address is used by the CreateSalesQuoteEbizProvABCImpl Business Process Execution Language (BPEL) process to obtain the sales person's email resource ID from Oracle E-Business Suite using the Service QueryJTFResourceSalesPersonAdapter.

To change the email address:

1. Log in to Oracle E-Business Suite.
2. Select the Human Resources responsibilities for your organization.
3. Click **Enter and Maintain under People**.
4. Search for the employee.
5. Update the email under **Office Details**.
6. Select the **CRM Administrator**, <organization> responsibility.
7. Click **Run under Resource Manager : Others : Requests to run Synchronize Employee Concurrent Requests**.

Use the default parameters to run the request.

8. Verify the email address in the JFT Resource profile by issuing the query in [Example 6-1](#):

Example 6-1 Query for JFT Resource profile

```
Select resource_id, source_email, decode (category, 'EMPLOYEE', 1, 'PARTNER', 2, 'PARTY', 3, 'SUPPLIER_CONTACT', 4, 'OTHER', 5, 'TBH', 6) preference from jtf_rs_resource_extns RS where source_email like '&email_id_form_CRMOD' and user_id is not null and exists (select salesrep_id from jtf_rs_salesreps where resource_id = RS. resource_id) and rownum = 1 order by preference.
```

Where *email_id_form_CRM OD* is the email in the request EBM

Note: You must replace `email_id_from_CRMOD` text with either email from the request EBM or the value passed for step 5.

For more information about JFT resource and sales person information, see *Oracle Common Application Components User's Guide in 11i*. In R12, use the *Oracle Trading Community Architecture User Guide: B25893-01*

6.3.2 Granting Access to the 360 Degree View in Oracle E-Business Suite

To enable users to launch the Oracle E-Business Suite Transaction View from CRM On Demand, you must grant users the Oracle Customers Online User or Super user responsibilities.

6.3.3 Changing the Default Status of New Orders in Oracle E-Business Suite

When a new order is created, the default status of the new order in Oracle E-Business Suite is ENTERED. This default value is determined by the value of the OrderStatus property in the AIA Configuration file for the ProcessSalesOrderCRMReqABCImpl service.

To change the default status value of new orders in Oracle E-Business Suite, you must change the value of the OrderStatus property in the AIA configuration file.

To change the default status of new orders in Oracle E-Business Suite:

1. Locate the following file:

*AIA_HOME/aia_
instance/instancename/AIAMetaData/config/AIAConfigurationProperties.xml*

2. Search for the ProcessSalesOrderCRMReqABCSImpl service.

3. Update the OrderStatus property with the new default status value.

The possible values for the OrderStatus property are configured in the ORDER_STATUS domain value map (DVM) in the COMMON value.

4. Log in to the AIA Console `http://<server name>:<port number>/AIA/` with the server administrator user name.

5. In the AIA Console, navigate to **Setup, Configuration**.

6. Click **Reload** to save the changes that you have made.

6.3.4 Assigning Sales Rep

CRM Quote requires that the sales rep assigned to the "<Operating Unit>" be the sales rep.

For more information, see [Appendix C, "Settings for Multi-Org Implementation"](#).

6.3.5 Creating Oracle E-Business Suite System Profiles

You must set the following profile options in Oracle EBS:

1. Log in to Oracle E-Business Suite using the System Administrator responsibility.
2. Open the System Profile Values form.
3. Query these profile options E-Business Suite 11.5.10.2 and set the indicated values at the site level:
 - HZ: Execute API Callouts to 'All Events Enabled' or 'Only Business Object Events Enabled'
 - HZ: Format Business Object Business Events as Bulk to 'N'
 - HZ: Generate Party Number to 'Yes'
 - HZ: Generate Party Site Number to 'Yes'
4. Query these profile options E-Business Suite 12.1.x. and set the indicated values at the site level:
 - HZ: Raise API Events to 'All Events Enabled' or 'Only Business Object Events Enabled'
 - HZ: Format Business Object Business Events as Bulk to 'N'
 - HZ: Generate Party Number to 'Yes'
 - HZ: Generate Party Site Number to 'Yes'

6.4 Setting Up Oracle CRM On Demand

This section describes the tasks that you must perform in CRM On Demand to implement the Oracle Lead to Order Integration Pack for Oracle CRM On Demand and Oracle E-Business Suite PIP and includes the following topics:

- [Section 6.4.1, "Implementing the Opportunity to Quote or Order Business Process"](#)
- [Section 6.4.2, "Setting Up the CRM On Demand Integration User"](#)
- [Section 6.4.3, "Creating the Custom Fields Required to Support the Integration"](#)
- [Section 6.4.4, "Creating the Web Link for the 360 Degree View"](#)
- [Section 6.4.5, "Configuring AIACompositeScheduler Service"](#)
- [Section 6.4.6, "Configuring the Integration Event Queues"](#)
- [Section 6.4.7, "Configuring Integration and Workflow Events in CRM On Demand"](#)
- [Section 6.4.8, "Setting Up Synchronization Failure Lists"](#)
- [Section 6.4.9, "Setting Up Synchronization Failure Alerts"](#)
- [Section 6.4.10, "Session Management"](#)

6.4.1 Implementing the Opportunity to Quote or Order Business Process

To implement the Opportunity-to-Quote or Opportunity-to-Order functionality provided by the Oracle Lead to Order Integration Pack for Oracle CRM On Demand and Oracle E-Business Suite PIP, you must perform several tasks:

1. (Optional) Enable the Order Management Quoting module.
2. Enable the order and quote object in CRM On Demand.
3. Create the web link to enable CRM On Demand users to view orders and quotes in Oracle E-Business Suite.
4. Display quote or order details on a page, for example, the Opportunity Details page.
5. Grant users access to the **Quote** or **Order applet** on a page.
6. Ensure that the sales user's email address in CRM On Demand equals the corresponding sales user's email address in Oracle E-Business Suite.

For more information about verifying a sales user's email address in Oracle E-Business Suite, see [Section 6.3.1, "Changing the Email Address"](#).

6.4.1.1 Enabling the Order Management Quoting Module

If you choose to implement the Opportunity-to-Quote process integration, you can use the functionality provided by either of the following modules:

- CRM On Demand Opportunity to Oracle CRM HTML Quoting
- CRM On Demand Opportunity to Order Management Quoting

The Oracle CRM HTML Quoting module is enabled by default. If you prefer to use the Order Management quoting module, you must update the CRMQuoteProvider service configuration property in the AIAConfigurationProperties.xml file as described in the following procedure.

To enable the Order Management Quoting module:

1. Locate the following file:

*AIA_HOME/aia_
instance/instancename/AIAMetaData/config/AIAConfigurationProperties.xml.*

2. Search for the CreateSalesQuoteEbizProvABCServiceImpl service.
3. Change the value of the CRMQuoteProvider property to **False**.
The CRMQuoteProvider property is set to true by default, which means that Oracle CRM HTML Quoting is enabled. To enable the Order Management Quoting module, change the value to false.
4. Log in to the AIA Console `http://<server name>:<port number>/AIA/` with the server administrator user name.
5. In the AIA Console, navigate to **Setup, Configuration**.
6. Click **Reload** to save the changes that you have made.
7. Restart the SOA server.

6.4.1.2 Enabling the Order or Quote Object in CRM On Demand

To implement the Opportunity-to-Quote or Opportunity-to-Order business processes, you must enable the Order and Quote objects in CRM On Demand.

To enable the Order or Quote objects in CRM On Demand:

1. Log in to CRM On Demand.
2. On the welcome page, click the Admin link.
3. On the Admin Homepage, navigate to **Role Management & Access Profiles**, and then **Role Management**.
4. In the Role Management wizard, perform the following steps:
 - a. Select the role name for which you want to enable the Quote or Order objects.
 - b. In Step 2, **Record Type Access**, select the **Can Access**, **Can Read**, and **Can Create** check boxes for the Order or Quote objects.
 - c. In Step 5, Tab **Access & Order**, move the **Order** or **Quote** items from the **Not Available** to the **Selected** Tab section.
 - d. Click **Finish**.
5. Click **Admin, User Management and Access Controls, Access Profiles**.
6. In the Access Profiles wizard, perform the following steps:
 - a. Click **Edit Link** beside the role name for which you want to enable the Quote or Order objects.
 - b. For step 2, **Specify Access Levels**, change the value of the **Default Access** field for the Order or Quote objects from **No Access** to **Read/Edit for Sales Users**. Set to **Read/Edit/Delete** for the appropriate administrative users.
7. Click **Finish**.

6.4.1.3 Create the Web Link to View Orders or Quotes in Oracle E-Business Suite

A web link is used to enable CRM On Demand users to view the orders and quotes in Oracle E-Business Suite that are associated with a CRM On Demand opportunity.

This topic describes how to create the web link for the Order object, and how to add the web link to the **Order Details** page. Use the same procedure to create a web link for the Quote object and to add it to the **Quote Details** page.

To create the web link to enable CRM On Demand users to view orders in Oracle E-Business Suite:

1. Log in to CRM On Demand
2. On the welcome page, click the Admin link.
3. On the Admin Homepage, navigate to **Application Customization, Order**, and click **Order Field setup**.
4. Click the **New Field** button and enter the following values:
 - a. In the Name field, enter the name for the web link you are creating.
 - b. In the Field Type field, select **Web link**.
 - c. Save the record.
5. On the Order Fields page, click **Edit Web Link** beside the Web link field that you created in the previous step.

The Edit Web Link page appears.

6. In the Edit Web Link page, set the focus on the Display Text field, and then select **Order Number** from the Order field.

The value of the Display Text field is similar to Order: %%%Order_Number%%%. The value "%%%Order_Number%%%" is displayed in the **Link Properties** URL column.

7. In the **Web Link Target** field, select **Open in New Window**.
8. Configure one URL as appropriate:

- a. For Order Management orders, specify the following URL:

```
http://Oracle E-Business Suite Host:port/OA_
HTML/OA.jsp?OAFunc=ONT_PORTAL_ORDERDETAILS
&HeaderId=%%Order_Id%%&&addBreadCrumb=Y
```

- b. For Order Management quotes, specify the following URL:

```
http://Oracle E-Business Suite Host:port/OA_
HTML/OA.jsp?OAFunc=ONT_PORTAL_ORDERDETAILS
&HeaderId=%%Quote_Id%%&&addBreadCrumb=Y
```

- c. For Oracle CRM HTML quotes on release 11.5.10.2:

- i. Specify this URL to get the JFN token, where *ebusinesssuiteserver:port* is your E-Business Suite server name and port name.:

```
http://<<ebusinesssuiteserver:port>>/OA_
HTML/qotSSbcJfnToken.jsp?qotRespKey=HTML_QUOTING_SALES_
AGENT
```

- ii. Replace HTML_QUOTING_SALES_AGENT with the responsibility that you are using. If you are using several responsibilities, you must get this token for each one. Example: Responsibility Key: HTML_QUOTING_SALES_AGENT JFN Token:

```
jfn=ZG2CEA6CEBABDF177950927FE65D4DBFD2DF1FACE827272872EE91FA
689615D43B44DFB00D207A89882A640D55DEB2E24836
```

- iii. Append the JFN token to this URL:

```
http://<<ebusinesssuiteserver:port>>/OA_
HTML/qotSZzpAppsLink.jsp?qotHdrId=%%Quote_
Id%%&qotReqSetCookie=Y&qotDetCode=QUOTE&qotFrmMainFile=qo
tSZzdContainer.jsp&<<JFN token calculated in the step i>>
```

- d. For Oracle CRM HTML quotes on release 12, specify the following URL, where Oracle E-Business Suite Host:port is your Oracle E-Business Suite host name and port name: `http://Oracle E-Business Suite Host:port/OA_HTML/OA.jsp?OAFunc=QOT_OAUI_QUOTE_DETAILS&QotIntgEvtSrc=CRMOD&QotIntgEvt=Event.QuoteDet&QotIntgEvtVal=%%Quote_Id%%&addBreadCrumb=Y`
9. To add the web link to the Order Details page, perform the following steps.
 - a. Navigate to **Admin, Application Customization**.
 - b. Click **Order, Order Page Layout**.
 - c. Select the **Copy Link against Order Page Standard Layout** option.
The page layout wizard is displayed.
 - d. In Step 1, **Layout Name**, specify Oracle E-Business Suite Order Layout as the layout name.
 - e. In Step 3, **Field Layout**, move the web Link field that you created from the **Available Order Fields** section to the **Key Order Information** section.
 - f. Click **Finish**.
 - g. Navigate to **Admin, User Management & Access control, and Role Management**.
 - h. Click the **Edit** link beside the role to which you want to assign the page layout.
 - i. In Step 6, **Page Layout Assignment**, select Oracle E-Business Suite Order Layout as the Order page layout.
The default value is **Order Page Standard layout**.

6.4.1.4 Granting Access to the Quote or Order Applet to User Roles and Users

To enable users to view the quote or order information on a page, you must configure the Quote or Order object to appear as an applet on the relevant page, then grant specific users or user roles access to the relevant applet on the page.

Note: Ensure that you have completed the steps in Enabling the Order or Quote Object in CRM On Demand before performing the procedure in this topic.

This topic describes how to grant users access to the Quote applet on the Opportunity Details page. Use the same procedure to grant users access to the Quote applet on the Account Details page, or to grant users access to the Order applet on the Opportunity or Account Details page. Simply substitute the relevant object and page names when following the steps in the procedure.

To grant access to the Quote applet on the Opportunity Details page:

1. Log in to CRM On Demand.
2. On the welcome page, click the **Admin**.
3. On the Admin Homepage, navigate to **User Management & Access Profiles**, and **Access Profiles**.
4. Select the role for which you want to grant access to the Quote applet.
5. Click step 2, **Specify Access Levels**, and then Opportunity related information.

6. For the quote object, change the value of the **Access level** from **No access** to **View**.
7. Click **Related Information** beside the **Account** item.
8. For the quote or order object, change the setting from **No Access** to **View**.

6.4.1.5 Displaying Quote or Order Details on a Page

You can choose to display quote or order details on the **Opportunity** or **Account Details** page according to your preferences.

This topic describes how to configure the Quote object so that users can view quote details on the Opportunity Details page. Use the same procedure to configure the quote object to appear on the Account Details page, or to configure the Order object to appear on the Opportunity or Account Details page. Simply substitute the relevant object and page names when following the steps in the procedure.

To configure quote details to appear on the Opportunity Details page:

1. Log in to CRM On Demand.
2. On the welcome page, click the **Admin**.
3. On the Admin Homepage, navigate to **Application Customization, Opportunity, Opportunity Related Information Layout, Quotes**.
4. Arrange the columns using the default layout, or edit the layout as required.
5. On the Admin Homepage, navigate to **Application Customization, Opportunity, Opportunity Page Layout**.
6. Click the **Edit** link beside the **Page layout** name.
7. Click Step 4, **Related Information**.
8. Drag the **Quote** object into the **Display Information** section.
9. Click Step 5, **Related Information Layout**.
10. Select the quote layout that you created in step 4.

6.4.2 Setting Up the CRM On Demand Integration User

Before you can use the Oracle Lead to Order Integration Pack for Oracle CRM On Demand and Oracle E-Business Suite PIP, you must set up an integration user within CRM On Demand. This section discusses how to:

- Define integration users in CRM On Demand.
- Update integration user information in CRM On Demand.

Note: This topic provides information about the values that you must define in CRM On Demand to support the Oracle Lead to Order Integration Pack for Oracle CRM On Demand and Oracle E-Business Suite PIP.

For more information about creating custom fields, see *CRM On Demand Online Help*, "Administering Siebel CRM On Demand," User Management and Access Controls.

6.4.2.1 Defining an Integration User in CRM On Demand

To define an integration user in CRM On Demand:

1. Log in to CRM On Demand.

2. On the Welcome page, click the **Admin**.
3. On the Admin Homepage, click the **User Management & Access Controls** link.
4. On the **User Management & Access Controls** page, click the **Role Management** link in the **Role Management** section.
5. On the **Role List** page, click **Edit** next to an existing name to update an existing user, or click **New User** to create a user.
6. Ensure that the user has these privileges set up:
 - Manage Data Rules - Manage Workflow Rules
 - Manage Integration Event Queue

Note: If these privileges are not available to you in the Administration user interface, or if the size of the default integration event queue is less than 500,000, contact your CRM On Demand system administrator to ensure that these privileges and settings are enabled for the integration user.

6.4.2.2 Updating Integration User Information in CRM On Demand

After you set up an integration user, changes to that user may be required. For example, you might want to change the user ID or password. To change the user ID or password, you must update the *AIAConfigurationsProperties.xml*.

For more information, see *Oracle Application Integration Architecture Process Integration Pack Utilities Guide*, "Session Pool Manager."

6.4.3 Creating the Custom Fields Required to Support the Integration

This topic describes how to configure the custom fields required by the Oracle Lead to Order Integration Pack for Oracle CRM On Demand and Oracle E-Business Suite PIP in CRM On Demand.

A custom pick list field that is defined within CRM On Demand controls whether records are to be synchronized to Enterprise Business Suite. This field is also used to display information if synchronization of a record fails. A synchronization status field, Integration Status, and corresponding long text field, Integration Message, provide details of a failed synchronization. These fields must be defined on the Account, Contact, Product, and Lead objects. Oracle recommends that these fields be made available only to administrators, and not to CRM On Demand sales users. Business rules can be defined to set the default Integration Status value to either Sync On or Sync Off using the CRM On Demand Expression Builder.

For more information, see *CRM On Demand Online Help*, "Administering Siebel CRM On Demand," Application Customization.

The process of configuring custom fields to support the integration involves the following steps:

1. Create these custom fields:
 - a. An Integration Status field for the Account, Contact, Product, and Lead objects in CRM On Demand.
 - b. An Integration Message field for the Account, Contact, and Product objects in CRM On Demand (you do not have to create this field for lead objects).
2. Add the custom fields to page layouts.

- a. After you create the Integration Status and Integration Message fields, you must add them to page layouts so that the fields are available to system administrators and end users.
 - b. The Account, Contact, Product, and Lead page layouts must contain the Integration Status and Integration Message field for the PIP to function.
 - c. After you add the new fields to these page layouts, you must also point the Administrator user role to the updated page layouts.
3. Set up field mapping for lead conversion.
 - a. After you have created the Integration Status and Integration Message fields and added them to the appropriate page layouts, you must set up field mapping information to support the CRM On Demand lead conversion process.
 - b. The lead conversion process requires that the Integration Status field from the Lead page layout is mapped to the Integration Status field from the Account page layout and Contact page layout.

6.4.3.1 Creating the Integration Status Fields

You define integration status and message fields on the CRM On Demand Account, Contact, Product, and Lead objects.

Note: These instructions provide details for creating the Integration Status field for the Account object only. You must also create this field for the Product, Contact, and Lead objects.

To set up the Integration Status field:

1. Log in to CRM On Demand.
2. From the welcome page, navigate to **Admin, Application Customization, Record Type Setup: object link, Field Management: object Field Setup**.

In this navigation, object is the object type for which you are setting the synchronization status, that is, **Account, Contact, Product, or Lead**.

Note: The Integration Message field is not required for the Lead object.

3. On the Object Fields page, click **New Fields**.
4. On the Object Field Edit page, complete the following fields, and click Save:

Table 6–1 Object Field Edit Fields

Field	value
Display Name	Integration Status
Field Type	Picklist

5. Return to the Object Fields page and locate the **Integration Status** field.
6. Click the **Edit Picklist** link that is associated with the **Integration Status** field.
7. Enter these picklist values for the **Integration Status** field:

Table 6–2 Picklist Values for the Integration Status Field

Order	ID	Picklist Values
1	Sync ON	Sync ON
2	Sync OFF	Sync OFF
3	Sync FAILED	Sync FAILED

Note: You must disable the **No Value** row.

8. Navigate back to the Object Fields page, and click **New Fields**.
9. On the Object Field Edit page, complete these fields as follows, and then click **Save**.

Table 6–3 Object Field Edit Fields

Field	Value
Display Name	Integration Message
Field Type	Text (Long)

10. From the Object Fields page, click **Rename Fields, Advanced**, and enter these field values:

Table 6–4 Object Fields Values

Field	Value
Display Name	Integration Status
Integration Tag	plSync_Status
Display Name	Integration Message
Integration Tag	ltComments

6.4.3.2 Adding Integration Fields to a Page Layout

After you create the Integration Status and Integration Message fields, you must add them to several page layouts so that they are available to system administrators.

To add the integration fields to the Admin layout, complete these steps for the account, contact, product, and lead objects:

1. Log in to CRM On Demand.
2. From the welcome page, navigate to **Admin, Application Customization, Record Type Setup: object link, Page Layout Management: object Layout, Edit Sections** (Administrator).

In this navigation, object is the object type for which you are amending the page layout, that is, account, contact, product, or lead.

3. On the **Section Names Setup** page, name one available section Oracle E-Business Suite Integration and click **Save**.
4. Return to the **Page Layout** page, and click the **Edit** link associated with the Administrators version of the object page.
5. Click **Next** twice, stopping when you reach step 3, **Field Layout**.

6. Add the **Integration Status** and **Integration Message** fields to the **Oracle E-Business Suite Integration** section and click **Finish**.
7. Assign the modified page layouts to the Admin user role.

Note: This procedure documents the recommended method of adding Integration Status and Integration Message fields to page layouts. You can, however, place these fields anywhere on the Account, Contact, Product, and Lead Detail pages, and assign the modified page layouts to any role you choose.

6.4.3.3 Configuring the Account-Contact Field

To configure the Account-Contact field:

1. Log in to CRM On Demand.
2. From the welcome page, navigate to **Admin, Application Customization, Record Type Setup: Account, Account Contact Field Setup**.
3. On the Account Contact Fields page, mark the following fields as *Required*:
 - Account ID
 - Contact ID

6.4.3.4 Mapping Integration Fields for the Lead Conversion

After you create the custom Integration Status field for the Lead, Account, and Contact objects, you must map the fields used in the integration from the Lead object to the Account, Contact, and Opportunity objects.

To map the Integration Status field:

1. Log in to CRM On Demand.
2. From the welcome page, navigate to **Admin, Business Process Management: Data Rules & Assignment, and Lead Conversion Mapping**.
3. Perform the mapping as listed in the [Table 6-5](#):

Table 6-5 Mapping for Integration Status Field

Lead	Contact	Account	Opportunity
Address1	Contact Address1	Billing Address1	NA
Address2	Contact Address2	Billing Address2	NA
Address3	Contact Address3	Billing Address3	NA
Annual Revenues	NA	Annual Revenues	NA
Cellular Phone #	Cellular Phone #	NA	NA
City	Contact City	Billing City	NA
Company	NA	Account Name	NA
Country	Contact Country	Billing Country	NA
Description	NA	NA	Description
Email	Email	NA	NA
Estimated Close Date	NA	NA	Close Date
Furigana First Name	Furigana First Name	NA	NA
Furigana Last Name	Furigana Last Name	NA	NA

Table 6–5 (Cont.) Mapping for Integration Status Field

Lead	Contact	Account	Opportunity
Industry Id	Industry Id	NA	NA
Integration Status	Integration Status	Integration Status	NA
Job Title	Job Title	NA	NA
Mr./Ms.	Mr./Mrs.	NA	NA
Never Email	Never Email	NA	NA
Next Step	NA	NA	Next Step
Number Of Employees	NA	Number Of Employees	NA
PO Box/Sorting Code	Contact PO Box/Sorting Code	Billing PO Box/Sorting Code	NA
Potential Revenue	NA	NA	Revenue
Primary Phone #	Work Phone #	NA	NA
Province	Contact Province	Billing Province	NA
Sales Rep Id	Primary Owner Id	Primary Owner Id	Primary Owner Id
Source	Lead Source	NA	Lead Source
US State	Contact US State	Billing US State	NA
Work Fax #	Work Fax #	NA	NA
Zip/Post Code	Contact ZIP/Post Code	Billing ZIP/Post Code	NA
Campaign Id	Campaign Id	Campaign Id	Campaign Id
Lead Currency	NA	Account Currency	Opportunity Currency

4. Click **Save**.

6.4.4 Creating the Web Link for the 360 Degree View

The Oracle Lead to Order Integration Pack for Oracle CRM On Demand and Oracle E-Business Suite PIP enables users to review back-office Oracle E-Business Suite transaction details for the account they are viewing from within CRM On Demand. An administrator can configure a web link that enables end users to launch the Oracle E-Business Suite Transaction View from the Account Details page for the account they are reviewing. This topic describes how to configure the web link for 360 Degree view.

For more information about the tasks that you must perform to enable user access to the 360 Degree View feature, see [Section 6.3.2, "Granting Access to the 360 Degree View in Oracle E-Business Suite"](#).

6.4.4.1 About Using the Web Link for the 360 Degree View

Accessing the Oracle Customers Online application from CRM On Demand includes the following steps:

1. The administrator configures a web link on the Account Details page within CRM On Demand and enables access to end users as is appropriate for their business.
2. From CRM On Demand, the user clicks the web link that has been set up to access the Oracle Customer's Online 360 Degree Transaction View page.
3. The system opens a new browser window to display the **360 Degree Transaction View** page.
4. Upon the first invocation of the 360 Degree Transaction View page, the user is required to log in using his or her Oracle E-Business Suite credentials. Upon

subsequent invocations, the user login information is cached, and no additional login is required, provided the login session is valid and has not timed out.

Note: Users must have the Customer Online Super User responsibility to access the 360 Degree Transaction View page in Oracle E-Business Suite.

5. The 360 Degree Transaction View page is launched, enabling users to review account details directly from CRM On Demand by launching an in-context Oracle E-Business Suite page.

The controls for the application are loaded, based on the form data that is passed through the URL (account ID and customer name).

Note: From this page, the user has full access to the responsibilities granted in Oracle E-Business Suite.

6. The user finishes viewing the account details and closes the new browser window.

6.4.4.2 Configuring the Web Link for the 360 Degree View

Web links are configured within CRM On Demand with context-sensitive parameters that enable you to define:

- The application, form, and version to launch.
- The data to pass to Oracle E-Business Suite to retrieve the appropriate record.

For more information about creating Web links in CRM On Demand, see *CRM On Demand Online Help*, "Administering Siebel CRM On Demand," Application Customization.

The following procedure describes how to configure the web link to launch the **Oracle E-Business Suite Transaction View** from an Account Detail page.

To set up the web link for account integration, complete these steps:

1. Log in to CRM On Demand.
2. From the welcome page, navigate to **Admin, Application Customization**.
3. From the Application Customization page, navigate to **Record Type Setup: Account**, and **Account Management: Account Field Setup**.
4. From the Account Fields page, click **New Field**, and create these fields:

Table 6–6 Account Fields Values

Field	Value
Display Name	Enter the name of the field as you want it to appear on the user interface, for example, <i>360° View</i> .
Field Type	<i>Web Link</i>

5. From the Account Fields page, click the **Edit Web Link** for the new **Web link** field.
6. From the Edit Web Link page, specify how you want the system to display the application when opened.

Oracle recommends that you select the **Open in New Window** option.

7. Specify the URL of Oracle E-Business Suite as follows:

```
http://Oracle E-Business Suite_Host:Port/OA_
HTML/OA.jsp?OAFunc=IMC_NG_360_VIEW_FUNC&
ImcEBIAccountId=%%%External_System_
Id%%%&ImcPartyName=%%%Name%%%
```

In this URL, Oracle E-Business Suite_Host:Port is the name and port of your Oracle E-Business Suite host server.

8. Complete the steps, as defined by CRM On Demand, to finish the web link setup.
9. After you create the web link, you must add the web link to the **Account Page Layout**, and then assign the updated page layout to the appropriate user roles.

Note: Detailed instructions regarding the Page Layout Wizard are included in CRM On Demand Online Help.

6.4.5 Configuring AIACompositeScheduler Service

For a cluster install, refer to *Oracle Application Integration Architecture Process Integration Pack Utilities Guide*, "Deploying AIACompositeScheduler on Weblogic Cluster" and note ID 1348907.1 on My Oracle Support.

For more information about how to modify AIACompositeScheduler, see Oracle Application Integration Architecture Process Integration Pack Utilities Guide, "AIACompositeScheduler," Modifying AIACompositeScheduler Properties.

6.4.6 Configuring the Integration Event Queues

Within CRM On Demand, integration events are stored as XML files and are placed in integration event queues for processing. Two queues must exist to process the integration events:

- The default queue, which is available by default
- The priority queue, which you must create.

Each company has an integration event file limit that specifies the maximum number of integration event files that can exist in CRM On Demand for that company. The recommended limit is 500,000. A company can create multiple queues and specify different queue sizes for each, but the total combined size of all the queues cannot exceed the maximum limit specified for the company. The recommended queue size for the default queue is 450,000. The recommended size of the Priority Queue is 50,000.

In addition to creating the Priority Queue, you must configure the time zone and picklist format for the integration event default queue. Use the following procedures to perform each of these tasks.

To create the Priority Queue:

1. Log in to CRM On Demand.
2. From the welcome page, navigate to **Admin, Integration Event Administration**.
3. Click **Integration Event Queue Management**.
4. Click **New Queue**.
5. For the **Queue Name** field, enter **PriorityQueue**.
6. Enter a value for the **Queue Size** field, for example, *50,000*, and save the record.

Configure the integration event default queue as described in the following procedure.

To configure the time zone and picklist format for the default queue:

1. Log in to CRM On Demand.
2. From the welcome page, navigate to **Admin, Integration Event Administration**.
3. Edit the **Default Queue**.
4. In the **Time Zone** field, select **UTC**.
5. In the **Picklist Format** field, select **Language Independent Value**.

6.4.7 Configuring Integration and Workflow Events in CRM On Demand

This section provides an overview of integration and workflow event configuration and discusses how to:

- Define workflow rule conditions.
- Create and configure integration events.

Note: The documentation in this section provides information and examples that are specific to the Oracle Lead to Order Integration Pack for Oracle CRM On Demand and Oracle E-Business Suite PIP.

For more information, see *CRM On Demand Online Help*, "Administering Siebel CRM On Demand," Data Management Tools and *CRM On Demand Online Help*, "Administering Siebel CRM On Demand," Business Process Management.

6.4.7.1 Understanding Integration and Workflow Event Configuration

To enable the synchronization of account and account address data between CRM On Demand and Oracle E-Business Suite, you must first define workflow rule conditions for several workflow events in CRM On Demand. [Table 6–7](#) lists the workflow events that you must configure, and specifies the workflow rule condition that you must use:

Table 6–7 Workflow Events and Rule Conditions Configuration Fields

Workflow Name	Record Type	Trigger Event	Workflow Rule Condition
Account Delete	Account	When record is deleted	([<plSync_Status_ITAG>]=LookupValue("OCC_CUST_LOV_ACCOUNT_0", "Sync ON")) OR ([<plSync_Status_ITAG>]=LookupValue("OCC_CUST_LOV_ACCOUNT_0", "Sync FAILED"))
Account Insert	Account	When new record is saved	[<plSync_Status_ITAG>]=LookupValue("OCC_CUST_LOV_ACCOUNT_0", "Sync ON")
Account Update	Account	When modified record is saved	([<plSync_Status_ITAG>]=LookupValue("OCC_CUST_LOV_ACCOUNT_0", "Sync ON"))
Contact Insert	Contact	When new record is saved	([<plSync_Status_ITAG>]=LookupValue("OCC_CUST_LOV_CONTACT_0", "Sync ON"))
Contact Update	Contact	When modified record is saved	([<plSync_Status_ITAG>]=LookupValue("OCC_CUST_LOV_CONTACT_0", "Sync ON"))

Table 6–7 (Cont.) Workflow Events and Rule Conditions Configuration Fields

Workflow Name	Record Type	Trigger Event	Workflow Rule Condition
Contact Delete	Contact	When record is deleted	([<plSync_Status_ITAG>]=LookupValue("OCC_CUST_LOV_CONTACT_0", "Sync ON")) OR ([<plSync_Status_ITAG>]=LookupValue("OCC_CUST_LOV_CONTACT_0", "Sync FAILED"))
Contact-Account-Assoc	Contact	After association with parent	([<plSync_Status_ITAG>]=LookupValue("OCC_CUST_LOV_CONTACT_0", "Sync ON"))
Contact-Account-Disassoc	Contact	After disassociation with parent	([<plSync_Status_ITAG>]=LookupValue("OCC_CUST_LOV_CONTACT_0", "Sync ON"))
Account-Contact-Assoc	Account	After association with parent	([<plSync_Status_ITAG>]=LookupValue("OCC_CUST_LOV_ACCOUNT_0", "Sync ON"))
Account-Contact-Disassoc	Account	After disassociation with parent	([<plSync_Status_ITAG>]=LookupValue("OCC_CUST_LOV_ACCOUNT_0", "Sync ON"))

After you define workflow rule conditions, you must create and configure an integration event for several account, address, contact, order, and quote workflows. [Table 6–8](#) lists the workflows for which you must create integration events and includes the configuration data that you must use:

Table 6–8 Workflows and Integration Events Configuration Fields

Workflow Name	Action Name/ Queue Name for Integration Event Creation	Trigger Event	Configuration Data
Account Delete	Account - Delete Default Queue	When record is deleted	No configuration required.
Account Insert	Account - Insert Default Queue	When new record is saved	Select these fields for tracking: Account Currency Account Name Account Type Annual Revenues Main Fax # Main Phone # Number of Employees Public Company Status Integration Status Web Site
Account Update	Account - Update Default Queue	When modified record is saved	Select these fields for tracking: Account Currency Account Name Account Type Annual Revenues Main Fax # Main Phone # Number of Employees Public Company Status Integration Status Web Site

Table 6–8 (Cont.) Workflows and Integration Events Configuration Fields

Workflow Name	Action Name/ Queue Name for Integration Event Creation	Trigger Event	Configuration Data
Address Delete	Address - Delete Default Queue	When record is deleted	No configuration required.
Address Insert	Address - Insert Default Queue	When new record is saved	Select these fields for tracking: Address 3 City Country County Description Postal Code Province State Street Address Street Address 2
Address Update	Address - Update Default Queue	When modified record is saved	Select these fields for tracking: Address 3 City Country County Description PostalCode Province State Street Address Street Address 2
Contact Insert	Contact - Insert Default Queue	When new record is saved	Select these fields for tracking: Account Id Cellular Phone # Email First Name Home Phone # Job Title Last Name Middle Name Mr./Ms. Integration Status Work Fax # Work Phone #

Table 6–8 (Cont.) Workflows and Integration Events Configuration Fields

Workflow Name	Action Name/ Queue Name for Integration Event Creation	Trigger Event	Configuration Data
Contact Update	Contact - Update Default Queue	When modified record is saved	Select these fields for tracking: Account Id Cellular Phone # Email First Name Home Phone # Job Title Last Name Middle Name Mr./Ms. Integration Status Work Fax # Work Phone #
Contact Delete	Contact - Delete Default Queue	When record is deleted	No configuration required.
Contact-Account-Assoc	Contact-Account-Assoc Default Queue	After association with parent	No configuration required.
Contact-Account-Disassoc	Contact-Account-Disassoc Default Queue	After disassociation with parent	No configuration required.
Account-Contact-Assoc	Account-Contact-Assoc Default Queue	After association with parent	No configuration required.
Account-Contact-Disassoc	Account-Contact-Disassoc Default Queue	After disassociation with parent	No configuration required.
Account Contact Insert	Account Contact - Insert Default Queue	When new record is saved	Select these fields for tracking: Account ID Contact ID
Account Contact Update	Account Contact - Update Default Queue	When modified record is saved	Select these fields for tracking: Account ID Contact ID

Table 6–8 (Cont.) Workflows and Integration Events Configuration Fields

Workflow Name	Action Name/ Queue Name for Integration Event Creation	Trigger Event	Configuration Data
Account Contact Delete	Account Contact - Delete Default Queue	When record is deleted	No configuration required.
Order Insert	Order - Insert Priority Queue	When new record is saved	Select these fields for tracking: <i>Created:</i> Date Currency Description External Flag External System Id Id <i>Modified:</i> Date Order Created Order Creation Status Order Id Order Integration Message Order Num Order Number Order Type
Quote Insert	Order - Insert Priority Queue	When new record is saved	Select these fields for tracking: <i>Created:</i> Date Currency Description External Flag External System Id Id <i>Modified:</i> Date Name Quote Created Quote Creation Status Quote Id Quote Integration Message Quote Num Quote Number Exchange Date

6.4.7.2 Defining Workflow Rule Conditions

To define workflow rule conditions:

1. Log in to CRM On Demand.
2. On the welcome page, click the **Admin**.
3. On the Admin Home page, click the **Workflow Configuration** link in the Business Process Management section.
4. On the Workflow Rules List page, to update the workflow rule, click the **Edit** link next to the it.

5. On the Workflow Rule Edit page, use the **Expression Builder** to update the workflow rule condition.
6. Complete the steps 1 to 5 for the **Account - Delete**, **Account - Insert**, and **Account - Update** workflows.

6.4.7.3 Creating and Configuring Integration Events

To create integration events:

1. Log in to CRM On Demand.
2. On the welcome page, click the **Admin**.
3. On the Admin Homepage, click the **Workflow Configuration** link in the Business Process Management section.
4. On the Workflow Rules List page, to update the workflow rule, click it.
5. On the Workflow Rule Detail page, select **Create Integration Event** from the **Action** menu.
6. On the Workflow Action Edit page, specify the appropriate values for the **Action Name** field and the **Queue Name** field, select the **Active** option and click **Save**.
7. Configure the integration event as described in the following procedure:
 - a. Access the Workflow Rule Details page for the selected workflow item.
 - b. Click the **Configure** link for the integration event you must configure.
 - c. Select the specified fields for tracking, and then click **Save**.

6.4.8 Setting Up Synchronization Failure Lists

Administrators require a simple way to review records that have failed to synchronize and take the appropriate corrective action. The List feature for accounts and contacts provides a means for an administrator to generate a list of records for which synchronization has failed.

To set up synchronization failure lists

1. Log in as an administrator.
2. For the account and contact objects, complete steps a through f.
 - a. Navigate to Object Homepage, **Object Lists**, and then **New**.
Replace **Object** with the name of an object, for example, *Contact Homepage*.
 - b. Set the following criteria:
 - Field. Integration Status
 - Condition. Equal to
 - Filter Value(s). Sync FAILED
 - c. Select the following fields for display in the list:
 - Integration Status
 - Integration Message
 - Other fields relevant to the object
 - d. Click **Save**.
 - e. Set the following fields:

List Name. Object Sync Failures

List Accessibility. Private

- f. Click **Save and Run**.

6.4.9 Setting Up Synchronization Failure Alerts

Alerts can be configured within Oracle CRM On Demand such that when a record has failed to synchronize, a designated user receives a failure alert by email that can indicate the record that has failed to synchronize and the reason for failure.

To set up synchronization failure alerts:

1. Navigate to **Admin, Workflow Configuration**.
2. Click **New** and add the following workflow rule:

In the **Action** Pane, choose **Menu** and then **Create Email Notification**, and then add the following action:

 - a. Action Name. Opportunity Sync Failure Alert
 - b. Active. Selected
 - c. Email Message (To*, Subject*, Message Body*). Specify message details to be sent to your administrator if there is a synchronization failure.
3. Click **New** and add the following workflow rule:
 - a. Workflow Name. Account Sync Failure Alert
 - b. Active. Selected
 - c. Record Type. Account
 - d. Trigger Event. When Modified Record Saved
 - e. Workflow Rule Condition.

```
[<p1Sync_Status_ITAG>]=LookupValue("OCC_CUST_LOV_ACCOUNT_0", "Sync FAILED")
```
4. In the **Action** Pane, choose **Menu** and then **Create Email Notification**, and add the following action:
 - a. Action Name. Account Sync Failure Alert
 - b. Active. Selected
 - c. Email Message (To*, Subject*, Message Body*). Specify message details to be sent to your administrator if there is a synchronization failure.
5. Click **New** and add the following workflow rule:
 - a. Workflow Name. Contact Sync Failure Alert
 - b. Active. Selected
 - c. Record Type. Contact
 - d. Trigger Event. When Modified Record Saved
 - e. Workflow Rule Condition.

```
[<p1Sync_Status_ITAG>]=LookupValue("OCC_CUST_LOV_CONTACT_0", "Sync FAILED")
```

6. In the **Action Pane**, choose **Menu** and then **Create Email Notification**, and add the following action:
 - a. Action Name. Contact Sync Failure Alert
 - b. Active. Selected
 - c. Email Message (To*, Subject*, Message Body*). Specify message details to be sent to your administrator if there is a synchronization failure.

6.4.10 Session Management

All operations including create, read, update, and delete in CRM On Demand are performed by CRM On Demand public web services. For all web service calls to CRM On Demand, a valid session ID is required. As part of the data synchronization architecture, a pool of CRM On Demand sessions is created on demand. Different BPEL processes that make web service calls to CRM On Demand reuse these sessions.

This pool of CRM On Demand sessions in the SOA server are managed by the AIA Common Utility called Session Pool Manager (SPM). SPM manages sessions for multiple instances of CRM On Demand and other Oracle application web servers. Each application web server instance is identified by a host ID. The default host ID for this PIP is CRMOD_01.

For more information about SPM, see *Oracle Application Integration Architecture Process Integration Pack Utilities Guide*, "Session Pool Manager."

6.5 Working with Domain Value Maps

Domain value maps (DVMs) are a standard feature of the Oracle SOA Suite that enable you to equate lookup codes and other static values across applications. Examples are "FOOT" and "FT" or "US" and "USA."

DVMs are static in nature, though administrators can add additional maps as needed. Transactional business processes never update DVMs—they only read from them. They are stored in XML files and cached in memory at run time.

These are the DVMs for the Oracle Lead to Order Integration Pack for Oracle CRM On Demand and Oracle E-Business Suite PIP:

Note: If you have defined custom values for any picklist fields in CRM On Demand that are to be synchronized to Oracle E-Business Suite, the corresponding DVM must be configured with the required mapping.

Table 6–9 DVMs for Oracle Lead to Order Integration Pack for Oracle CRM On Demand and Oracle E-Business Suite

DVM Type	DVM Column Name	Description
ADDRESS_COUNTRYID	EBIZ_01, COMMON, CRM OD_01	Country codes
STATE	EBIZ_01, COMMON, CRM OD_01	State codes
PROVINCE	EBIZ_01, COMMON, CRM OD_01	Province codes
ORDER_SOURCE_ID	COMMON, EBIZ_01	Mapping for multiple sources of Order or Quote
CONTACT_SALUTATION	EBIZ_01, COMMON, CRM OD_01	Salutation (such as Mr., Mrs., and so on)
CUSTOMERPARTY_STATUSCODE	EBIZ_01, COMMON, CRM OD_01	Account status codes
PHONENUMBER_TYPE	EBIZ_01, COMMON, CRM OD_01	Phone number type codes (such as home, work, mobile, fax, and so on)

Table 6–9 (Cont.) DVMs for Oracle Lead to Order Integration Pack for Oracle CRM On Demand and Oracle E-Business Suite

DVM Type	DVM Column Name	Description
SITEUSAGE_CODE	EBIZ_01, COMMON, CRM OD_01	Address site usage code (such as bill to, ship to, and so on)
ITEM_TYPE	EBIZ_01, COMMON, CRM OD_01	Mapping of Oracle E-Business Suite Item Types to CRM On Demand Product Types
CURRENCY_CODE	EBIZ_01, COMMON, CRM OD_01	Currency codes
ORDER_STATUS	EBIZ_01, COMMON, CRM OD_01	Order and quote status codes
ORDER_TYPE	EBIZ_01, COMMON, CRM OD_01	Type of order (such as sales order, RMA, quote, and so on)
PRODUCT_STATUS	EBIZ_01, COMMON, CRM OD_01	Product status codes
CUSTOMERPARTY_NUMBERLABEL	COMMON, EBIZ_01	Type of revenue (for example, Annual Revenue)

For information about additional DVM setup for multi-org implementation, see [Appendix C, "Settings for Multi-Org Implementation"](#).

For more information about DVMs, see *Oracle Fusion Middleware Developer's Guide for Oracle Application Integration Architecture Foundation Pack 11g Release 1, "Understanding Message Transformation, Enrichment, and Configuration," Domain Value Maps*.

6.6 Working with Cross-References

Cross-references map and connect the records within the application network, and they enable these applications to communicate in the same language. The integration server stores the relationship in a persistent way so that others can refer to it.

These are the cross-references for the Oracle Lead to Order Integration Pack for Oracle CRM On Demand and Oracle E-Business Suite PIP:

Table 6–10 Cross-References for Oracle Lead to Order Integration Pack for Oracle CRM On Demand and Oracle E-Business Suite

Table	Column	Description	Usage
CUSTOMERPARTY_PARTYID	EBIZ_01	Customer party ID	Lookup: populated during customer, sales order, or sales quote flow
	COMMON	System-generated GUID	Lookup: populated during customer, sales order, or sales quote flow
	CRM OD_01	Account ID	Lookup: populate during customer, sales order, or sales quote flow
CUSTOMERPARTY_ACCOUNTID	EBIZ_01	Customer account ID	Lookup: populated during customer, sales order, or sales quote flow
	COMMON	System-generated GUID	Lookup: populated during customer, sales order, or sales quote flow
	CRM OD_01	Account ID	Lookup: populated during customer, sales order, or sales quote flow

Table 6–10 (Cont.) Cross-References for Oracle Lead to Order Integration Pack for Oracle CRM On Demand and Oracle E-Business Suite

Table	Column	Description	Usage
CUSTOMERPARTY_ADDRESSID	EBIZ_01	Address (location) ID	Lookup: populated during customer, sales order, or sales quote flow
	COMMON	System-generated GUID	Lookup: populated during customer, sales order, or sales quote flow
	CRM OD_01	Address ID	Lookup: populated during customer, sales order, or sales quote flow
CUSTOMERPARTY_CONTACTID	EBIZ_01	Contact/Person IDs	Lookup: populated during customer, sales order, or sales quote flow
	COMMON	System-generated GUID	Lookup: populated during customer, sales order, or sales quote flow
	CRM OD_01	Contact ID	Lookup: populated during customer, sales order, or sales quote flow
CUSTOMERPARTY_LOCATIONREFID	EBIZ_01	Address (location) ID	Lookup: populated during customer, sales order, or sales quote flow
	COMMON	System-generated GUID	Lookup: populated during customer, sales order, or sales quote flow
	CRM OD_01	Address ID	Lookup: populated during customer, sales order, or sales quote flow
CUSTOMERPARTY_PARTYLOCATIONID	EBIZ_01	Party address ID	Lookup: populated during customer, sales order, or sales quote flow
	COMMON	System-generated GUID	Lookup: populated during customer, sales order, or sales quote flow
	CRM OD_01	Address ID	Lookup: populated during customer, sales order, or sales quote flow
CUSTOMERPARTY_ACCOUNT_PHONECOMMID	EBIZ_01	Account phone contact point	Lookup: populated during customer, sales order, or sales quote flow
	COMMON	System-generated GUID	Lookup: populated during customer, sales order, or sales quote flow
	CRM OD_01	Account ID	Lookup: populated during customer, sales order, or sales quote flow
CUSTOMERPARTY_ACCOUNT_FAXCOMMID	EBIZ_01	Account fax contact point	Lookup: populated during customer, sales order, or sales quote flow
	COMMON	System-generated GUID	Lookup: populated during customer, sales order, or sales quote flow
	CRM OD_01	Account ID	Lookup: populated during customer, sales order, or sales quote flow

Table 6–10 (Cont.) Cross-References for Oracle Lead to Order Integration Pack for Oracle CRM On Demand and Oracle E-Business Suite

Table	Column	Description	Usage
CUSTOMERPARTY_ACCOUNT_ WEBCOMMID	EBIZ_01 column	Account email/Web contact points	Lookup: populated during customer, sales order, or sales quote flow
	COMMON	System-generated GUID	Lookup: populated during customer, sales order, or sales quote flow
	CRM OD_01	Account ID	Lookup: populated during customer, sales order, or sales quote flow
CUSTOMERPARTY_CONTACT_ PHONECOMMID	EBIZ_01 column	Contact phone contact point	Lookup: populated during customer, sales order, or sales quote flow
	COMMON	System-generated GUID	Lookup: populated during customer, sales order, or sales quote flow
	CRM OD_01	Contact ID: HOME Contact ID: WORK Contact ID: MOBILE	Lookup: populated during customer, sales order, or sales quote flow If this is a contact home phone, then the cross-reference value is Contact Id: Home. If this is a work phone, then the cross-reference value is Contact Id: WORK, and so on.
CUSTOMERPARTY_CONTACT_ FAXCOMMID	EBIZ_01	Contact's fax contact point	Lookup: populated during customer, sales order, or sales quote flow
	COMMON	System-generated GUID	Lookup: populated during customer, sales order, or sales quote flow
	CRM OD_01	Contact ID	Lookup: populated during customer, sales order, or sales quote flow
CUSTOMERPARTY_CONTACT_ EMAILCOMMID	EBIZ_01	Contact email/Web contact point	Lookup: populated during customer, sales order, or sales quote flow
	COMMON	System-generated GUID	Lookup: populated during customer, sales order, or sales quote flow
	CRM OD_01	Contact ID	Lookup: populated during customer, sales order, or sales quote flow
CUSTOMERPARTY_ PARTYCONTACTID	EBIZ_01	Party contact IDs	Lookup during sales order flow, lookup: populated during customer flow
	COMMON	System-generated GUID	Lookup during sales order flow, lookup: populated during customer flow
	CRM OD_01	Contact ID	Lookup during sales order flow, lookup: populated during customer flow
SALESORDER_ID	EBIZ_01	Sales order ID	Populated by sales order flow
	COMMON	System-generated GUID	Populated by sales order flow
	CRM OD_01	Order ID	Populated by sales order flow

Table 6–10 (Cont.) Cross-References for Oracle Lead to Order Integration Pack for Oracle CRM On Demand and Oracle E-Business Suite

Table	Column	Description	Usage
SALESORDER_LINEID	EBIZ_01	Sales order line ID	Populated by sales order flow
	COMMON	System-generated GUID	Populated by sales order flow
	CRM OD_01	Product revenue ID	Populated by sales order flow
QUOTE_ID	EBIZ_01	Quote ID	Populated by sales quote flow
	COMMON	System-generated GUID	Populated by sales quote flow
	CRM OD_01	Quote ID	Populated by sales quote flow
QUOTE_LINEID	EBIZ_01	Quote line ID	Populated by sales quote flow
	COMMON	System-generated GUID	Populated by sales quote flow
	CRM OD_01	Quote ID	Populated by sales quote flow
ORGANIZATION_ID	EBIZ_01	Organization/business unit IDs	Lookup during sales order, sales quote, and customer flow
	COMMON	System-generated GUID	Lookup during sales order, sales quote, and customer flow
	CRM OD_01		
ITEM_ITEMID	EBIZ_01	Item/product ID	Lookup during sales order/sale quote flow Lookup: populated during item flow
	COMMON	System-generated GUID	Lookup during sales order/sale quote flow Lookup: populate during item flow
	CRM OD_01	Product ID	Lookup during sales order/sale quote flow Lookup: populate during item flow
INVENTORY_LOCATION_ID USER_NAME	EBIZ_01	Org Id	You must complete this table manually after you have installed the Oracle Lead to Order Integration Pack for Oracle CRM On Demand and Oracle E-Business Suite PIP. For more information , see <i>Oracle Fusion Middleware Installation and Upgrade Guide for Oracle Application Integration Architecture Foundation Pack 11g Release 1</i>
	COMMON	GUID	You must complete this table manually after you have installed the Oracle Lead to Order Integration Pack for Oracle CRM On Demand and Oracle E-Business Suite PIP. For more information , see <i>Oracle Fusion Middleware Installation and Upgrade Guide for Oracle Application Integration Architecture Foundation Pack 11g Release 1</i>
	EBIZ_01	Ebiz user ID	Lookup during sales order, sales quote, and customer flow
	COMMON	System-generated unique ID	Lookup during sales order, sales quote, and customer flow
	CRM OD_01	CRM On Demand integration user ID	Lookup during sales order, sales quote, and customer flow

For information about the additional cross-reference table setup for multi-org implementation, see [Appendix C, "Settings for Multi-Org Implementation"](#).

For more information about cross-references, see *Oracle Fusion Middleware Developer's Guide for Oracle SOA Suite Oracle Fusion Middleware Infrastructure Components and Utilities User11g Release 1*, "Understanding Message Transformation, Enrichment, and Configuration," Cross-References.

6.7 Handling Errors

Based on the roles defined for the services, email notifications are sent if a service ends in error. [Table 6–11](#) lists the errors that are caused by the Oracle Lead to Order Integration Pack for Oracle CRM On Demand and Oracle E-Business Suite PIP services.

Table 6–11 Errors Caused by Oracle Lead to Order Integration Pack for Oracle CRM On Demand and Oracle E-Business Suite

Error Code	Message Text
AIA_ERR_AIAO2C2_1001	Timeout while waiting for a response from the InterfaceCustomerToFulfillmentEBF service.
AIA_ERR_AIAO2C2_1002	Timeout while waiting for a response from the InterfaceSalesOrderToCustomerEBFV2 service.
AIA_ERR_AIAEBSI_0001	Failed to fetch the Sales Representative Resource ID. Please make sure the Sales Representative email addresses are identical in both systems.

For more information about the errors caused by CRM On Demand or Oracle E-Business Suite, see that product's documentation.

For more information about AIA error handling, see the *Oracle Fusion Middleware Infrastructure Components and Utilities User's Guide for Oracle Application Integration Architecture Foundation Pack 11g Release 1*, "Setting Up and Using Error Handling and Logging."

6.7.1 About the Error Handler Service

The CRM On Demand to Oracle E-Business Suite flows consist of a central error handling process, the CRMOnDemandErrorHandler service. Faults generated from the CRM On Demand requester ABCSs and Oracle E-Business provider ABCS/EBFs (Enterprise Business Flow) are published to the AIA Java Message Service (JMS) error queue. The CRM On Demand error handler service subscribes to the error queue for CRM On Demand requester faults only; the CRM On Demand error handler service then processes each fault according to the type of fault (see retryable and nonretryable faults). The AIA default error handler service subscribes to the error queue for other service faults; the service then processes each fault (regardless of the type of fault) by sending an email to the OracleAIACSR user (see Setup Error Notification Roles and Users) with the content of the fault.

6.7.1.1 CRM On Demand to Oracle E-Business Suite Error Processing Flow

The following steps outline the processing that results if errors occur when information is synchronized from CRM On Demand to Oracle E-Business Suite.

1. Events are pulled from the CRM On Demand server and sent to middle-tier queues called resequencers.

Resequencers store events in different groups. Account and account address events are grouped by account ID so that the account and address events (for example, create account, update account, create address, update address, and so on) of the same account are stored in one group with account ID as the group ID. Similarly, contact events are grouped by contact ID, and order and quote events are grouped by order ID and quote ID respectively.

For more information about resequencer queues, see *Oracle Fusion Middleware Developer's Guide for Oracle Application Integration Architecture Foundation Pack 11g Release 1*.

2. The resequencers retrieve each event from the queue, initiate a global transaction to process the event, and route the event to the appropriate CRM On Demand requester to start synchronizing the event to Oracle E-Business Suite.
3. If a service fails because of a business or system error, then it publishes the fault message to the AIA JMS error queue with one type code:
 - AIA_EH_ONDEMAND: for CRM On Demand requester services or EBIZ provider services
 - AIA_EH_DEFAULT: for other services
4. The error is passed from the service that generated the error to previous calling services until it is received by the CRM On Demand requester. Each service that receives the fault publishes the fault to the AIA JMS error queue with a type code.
5. When an error occurs, the global transaction initiated by the resequencer is eventually rolled back and the group to which the event belongs becomes blocked. When a group is blocked, any subsequent events from the same group are not processed, although the resequencer can process events for other groups that are not blocked.
6. The CRM On Demand error handler service subscribes to the JMS error queue if the type code is AIA_EH_ONDEMAND.

After the error is received by the CRM On Demand error handler service, the service determines whether the error is a retryable or non-retryable error:

- If an error is retryable, the service sends a notification email with the word SYSTEM in the email subject line, with the fault information, for example, service name, group ID, service ID, and so on.
- If an error is not retryable, the service skips the event in the resequencer so that the next event (if any) in the same group can continue to be processed.

It also updates the corresponding CRM On Demand record associated with the event; the Integration Status field is set to Sync FAILED and the Integration Message field is updated with the instance ID of the requester service. A notification email is also sent, but it does not contain the word SYSTEM in the email subject line.

For more information about configuring email addresses to receive these notifications, see *Oracle Fusion Middleware Infrastructure Components and Utilities User's Guide for Oracle Application Integration Architecture Foundation Pack 11g Release 1*, "Setting Up and Using Error Handling and Logging"

6.7.1.2 Setting Up CRM On Demand Error Handler

The installation process takes care of the setting up CRM On Demand Error Handler. [Table 6-12](#) lists the services and their attributes for which the setup is required:

Table 6–12 Services and Attributes for CRM On Demand

Service Name	System Code	Error Type	Error Ext Handler
InterfaceCustomerToFulfillmentEBF	NA	AIA_EH_ONDEMAND	ERRORHANDLER_EXT
InterfaceSalesQuoteToFulfillmentEBF	NA	AIA_EH_ONDEMAND	ERRORHANDLER_EXT
InterfaceSalesOrderToCustomerEBFV2	NA	AIA_EH_ONDEMAND	ERRORHANDLER_EXT
CreateSalesOrderEbizProvABCImpl	EBIZ_01	AIA_EH_ONDEMAND	ERRORHANDLER_EXT
SyncItemListCRMODProvABCImpl	EBIZ_01	AIA_EH_ONDEMAND	ERRORHANDLER_EXT
UpdateCustomerPartyEbizProvABCImpl	EBIZ_01	AIA_EH_ONDEMAND	ERRORHANDLER_EXT
SyncCustomerPartyListEbizProvABCImpl	EBIZ_01	AIA_EH_ONDEMAND	ERRORHANDLER_EXT
CreateSalesQuoteEbizProvABCImpl	EBIZ_01	AIA_EH_ONDEMAND	ERRORHANDLER_EXT
CreateCustomerPartyEbizProvABCImpl	EBIZ_01	AIA_EH_ONDEMAND	ERRORHANDLER_EXT
CreateCustomerAddressCRMODReqABCImpl	CRMOD_01	AIA_EH_ONDEMAND	ERRORHANDLER_EXT
CreateCustomerCRMODReqABCImpl	CRMOD_01	AIA_EH_ONDEMAND	ERRORHANDLER_EXT
DeleteCustomerAddressCRMODReqABCImpl	CRMOD_01	AIA_EH_ONDEMAND	ERRORHANDLER_EXT
UpdateCustomerAddressCRMODReqABCImpl	CRMOD_01	AIA_EH_ONDEMAND	ERRORHANDLER_EXT
UpdateCustomerCRMODReqABCImpl	CRMOD_01	AIA_EH_ONDEMAND	ERRORHANDLER_EXT
ProcessSalesOrderCRMODReqABCImpl	CRMOD_01	AIA_EH_ONDEMAND	ERRORHANDLER_EXT
ProcessContactCRMODReqABCImpl	CRMOD_01	AIA_EH_ONDEMAND	ERRORHANDLER_EXT
DeleteCustomerCRMODReqABCImpl	CRMOD_01	AIA_EH_ONDEMAND	ERRORHANDLER_EXT
ProcessSalesQuoteCRMODReqABCImpl	CRMOD_01	AIA_EH_ONDEMAND	ERRORHANDLER_EXT

6.7.1.3 About Retryable and Non-Retryable Errors

Within the Oracle Lead to Order Integration Pack for Oracle CRM On Demand and Oracle E-Business Suite PIP, errors are categorized as retryable errors or non-retryable errors.

About Retryable Errors

Retryable errors are system errors. If a retryable error occurs, the original message can be resubmitted by Enterprise Manager 11g Fusion Middleware Control (Oracle Enterprise Manager).

The notification email, sent when a retryable error occurs, contains the string SYSTEM in the email subject line. The email includes a Corrective Action link to it.

When a system error occurs, correct the error, and then resubmit the message in Oracle Enterprise Manager.

The CRM On Demand Error Handling Service identifies an error as a system error by searching the error message text for a specific string or pattern that matches the text for a system error code. The error message text is read from the SysErrorCodes property of the CRMOnDemandErrorHandlerService Service Configuration in the AIAConfigurationProperties.xml file.

The SysErrorCodes property is set as the following string:

```
<Property name="SysErrorCodes">ORABPEL-11622</Property>
```

Note: ORABPEL-11622 indicates that the Oracle E-Business Suite system is down.

The SysErrorCodes property accepts regular expressions (regex). You can edit the regex string by changing the regex pattern to locate system errors that are specific to your environment. For example, if you edit the regex string as follows, any error message that contains the text ORABPEL-02181, ORA320, or any string beginning with SIEBEL-11* is identified as a system error.

```
<Property
name="SysErrorCodes">ORABPEL-11622 | ORA320 | SIEBEL-11* </Property>
```

About Non-Retryable Errors

Non-retryable errors (business errors) are generally the result of user errors, for example, incorrect or missing data in a record. These types of error messages are skipped in the resequencer queue, and processing moves to the next message. You should not resubmit non-retryable messages using Oracle Enterprise Manager. You must correct the CRM On Demand record causing the error, and then set the **Integration Status** field to **Sync On**. The record is then synchronized again to Oracle E-Business Suite.

About Enterprise Manager for Resubmitting Failed Messages

If a message fails due to a system error (retryable error), it remains in the resequencer and blocks any subsequent messages that belong to the same group. Oracle Enterprise Manager provides means to unlock the locked group and resubmit (or terminate) a failed message.

After fixing the system error, to resubmit a failed message follow these steps:

1. Log in to Oracle Enterprise Manager Fusion Middleware Control.
2. Locate the resequencer containing the faulted message and click it.
3. Select **Faults and Rejected Messages**.
4. Click **Recovery** for the faulted message.

A window appears with the message ID and Recovery state.

5. Click **Recoverable**.
6. Click **Retry**.

The message is resubmitted.

6.7.2 Setup Error Notification Roles and Users

For more information about AIA error handling, see *Oracle Fusion Middleware Infrastructure Components and Utilities User's Guide for Oracle Application Integration Architecture Foundation Pack 11g Release 1*, "Setting Up and Using Error Handling and Logging."

6.7.3 Resubmitting Failed Messages in Oracle E-Business Suite

Events that are initiated in Oracle E-Business Suite are placed in the Oracle Advanced Queue (AQ) in the Oracle E-Business Suite database under the queue name WF_BPEL_Q. The WF_BPEL_Q queue is located in the WF_BPEL_QTAB queue table. The WF_BPEL_QTAB queue table also maintains a queue, AQ\$_WF_BPEL_QTAB_E, for holding messages that have failed due to errors.

Messages that are processed successfully are removed from the WF_BPEL_Q queue. If an error occurs during the message processing, the transaction is rolled back and the

AQ messaging system moves the message from the WF_BPEL_Q queue to the AQ\$_WF_BPEL_QTAB_E queue.

The PIP installation process creates several consumer adapter services, for example, CreateItemEbizEventConsumer. The consumer services create a subscription to the main business events that are processed in the Oracle E-Business Suite database and these subscriptions add messages to the WF_BPEL_Q queue. The consumer services then read the messages from the WF_BPEL_Q queue.

Administrators can use the message submit utility provided by the AIA Foundation Pack to resubmit failed messages after taking corrective action to resolve the error that caused the message to fail. Resubmitting a message moves the message from the AQ\$_WF_BPEL_QTAB_E queue to the WF_BPEL_Q queue so that the message can be reprocessed.

The following procedure describes how to resubmit a message that has failed.

To resubmit a message:

1. Obtain the message ID for the event that failed from the BPEL Instance:
 - a. Open the Error Notification email, which has a subject line similar to this:
Error in AIA UpdateProductEbizReqABCImpl Process
 - b. Open the attachment, which contains the Faulting Service Instance ID.
 - c. In the BPEL console, open the BPEL instance for the Faulting Service Instance ID.
 - d. In the **receiveInput** step, note the value of the EVENT_DATA field in the message, for example:
`<EVENT_DATA>7342C2350EDEA30DE040B98B97154924<EVENT_DATA>`
2. Log in to the SOA server.
3. If you are using a Microsoft Windows environment, run the `$AIA_HOME\bin\aiainv.bat` file.
4. If you are using a Linux environment, perform the following steps:
 - a. Source `$AIA_HOME/bin/aiainv.sh`.
 - b. Navigate to the `$AIA_HOME/util/AIAMessageResubmissionUtil` directory.
 - c. Edit the `ResubmitBuild.properties` file and set the properties listed in [Table 6–13](#) to the respective values:

Table 6–13 Properties for ResubmitBuild.properties field

Property	Value
jdbc_url	For the jdbc_url, specify the Oracle E-Business Suite database name using a format similar to this: jdbc:oracle:thin:@<dbhostname>:<dbport>:dbSID
Username	The Oracle E-Business Suite database schema user name.
Password	Password. The Oracle E-Business Suite database schema password.
IntermediateSenderResourceTypeCode	1
Set IntermediateSenderResourceID	WF_BPEL_Q
IntermediateSenderMessageID	The value of the EVENT_DATA field obtained in step 1d.
TableName	WF_BPEL_QTAB

5. Run the following command:

```
ant -buildfile MessageResubmit.xml
```

For more information, see the *Oracle Fusion Middleware Infrastructure Components and Utilities User's Guide for Oracle Application Integration Architecture Foundation Pack* "Using the Message Resubmission Utility".

6.7.4 Throttling Oracle E-Business Suite Messages in the 11G Fusion Middleware

If a large number of events are generated at a time in Oracle E-Business Suite, Oracle Advanced Queue can contain many messages, which can lead to a decrease in performance. To avoid this situation, you can configure the number of messages that are processed at a time by Oracle Advanced Queue by setting the JAVA VM system property called `adapter.aq.dequeue.threads` for the server to more than 1 (default).

Oracle recommends that you set the value of the `adapter.aq.dequeue.threads` property to 5 during the initial batch loading of account and product data.

For more information, see *Oracle Fusion Middleware User's Guide for Technology Adapters, 11g, Release 1*, "Oracle JCA Adapter for AQ".

To set the Java VM system property:

1. Log in to the console.
2. Navigate to **Environment, Servers**.
3. In the Servers table, click the name of the Managed Server (for example, `soa_server1`) to configure.
4. Select **Configuration, Server Start**.
5. Set `Dadapter.aq.dequeue.threads=3` for the argument.
6. Save and restart the Managed Server.

6.8 Viewing EIMs

For more information about using XSL Mapping Analyzer (XMAN), see *Oracle Fusion Middleware Infrastructure Components and Utilities User's Guide for Oracle Application Integration Architecture Foundation Pack 11g Release 1*, Using the XSL Mapping Analyzer.

For more information about how services are mapped, see the My Oracle Support document: *EBO Implementation Maps (EIMs) 881022.1*.

6.9 Configuring the Oracle Lead to Order Integration Pack for Oracle CRM On Demand and Oracle E-Business Suite PIP

Configure these properties in the `AIAConfigurationProperties.xml` file. The file is located in `AIA_HOME>/aia_instances/$INSTANCE_NAME/AIAMetaData/config/`. Entries in the `AIAConfigurationProperties.xml` file are case-sensitive.

For more information about requirements for working with `AIAConfigurationProperties.xml`, see *Oracle Fusion Middleware Developer's Guide for Oracle Application Integration Architecture Foundation Pack 11g Release 1*, "Building AIA Integration Flows," How to Set Up AIA Workstation.

[Table 6–14](#) lists the settings for the system properties:

Table 6–14 System Properties

Property Name	Value/Default Value	Description
EBIZ_01.SERVER_TIMEZONE	GMT-08:00	This is the Oracle E-Business Suite server time zone. Change this value as appropriate.

Table 6–15 lists the properties for the TransformAppContextEbizService service:

Table 6–15 Properties for the TransformAppContextEbizService Service

Property Name	Value/Default Value	Description
TransformAppContextEbizService.Soap.EndpointURL	http://<SOA_HOST>:<SOA_PORT>/soa-infra/services/default/TransformAppContextEbizService/TransformAppContextEbizService	End point URI of the Ebiz adapter.
TransformAppContextEbizService.EBIZ_01.ResponsibilityDVM	ORACLE_RESPONSIBILITY	
TransformAppContextEbizService.DefaultUser	OPERATIONS	Default integration user in Oracle E-Business Suite. This user should be able to create the customer, order, and quote in Oracle E-Business Suite.
TransformAppContextEbizService.DefaultOperatingUnit	204	Default operating unit in Oracle E-Business Suite in which the quote or order is created. This should be set to the correct operating unit.
TransformAppContextEbizService.DefaultResponsibility	Order Management Super User	Default responsibility for creating the order or quote in Oracle E-Business Suite. This is set in the DefaultUser. This responsibility should be in Oracle E-Business Suite.
Routing.QueryResponsibilityEbizAdapter.RouteToCAVS	true/false Default = false	Governs whether the service routes the message to the Composite Application Validation System (CAVS) end point. The default value is false, which does not route to CAVS. If set to true, it is routed to CAVS using the end point specified in the CAVS.EndpointURI property.
Routing.QueryRespEbizAdapter.CAVS.EndpointURI	http://\${http.hostname}:\${http.port}/AIVValidationSystemServlet/synresponse simulator	CAVS end point URI, when CAVS is enabled.
Default.SystemID	EBIZ_01	Ebiz system code such as EBIZ_01, defined in Business Service Repository (BSR) to which data is synced. The system code value present in the Enterprise Business Message (EBM) header of the incoming message takes precedence over this property value.
Routing.QueryRespEbizAdapter.EBIZ_01.EndpointURI	http://<SOA_HOST>:<SOA_PORT>/soa-infra/services/default/QueryResponsibilityEbizAdapter/QueryResponsibilityEbizAdapter_ep	

Table 6–16 lists the properties for the BatchLoadCustomerPartyListEbizReqABCSImpl service:

Table 6–16 Properties for the BatchLoadCustomerPartyListEbizReqABCImpl Service

Property Name	Value/Default Value	Description
Default.SystemID	No default value	Ebiz system code (such as EBIZ_01, defined in BSR) to which data is synchronized. The system code value present in the EBM header of the incoming message takes precedence over this property value.
Routing.BatchLoadCustomerPartyListEbizAdapter.EBIZ_01.EndpointURI	http://<SOA_HOST>:<SOA_PORT>/soa-infra/services/default/BatchLoadCustomerPartyListEbizAdapter/BatchLoadCustomerPartyListEbizAdapter_ep	End point URI of the Ebiz adapter.
Routing.BatchLoadCustomerPartyListEbizAdapter.CAVS.EndpointURI	http://<SOA_HOST>:<SOA_PORT>/AIAValidationSystemServlet/asyncrequestrecipient	CAVS end point URI, when CAVS is enabled.
Routing.BatchLoadCustomerPartyListEbizAdapter.RouteToCAVS	true/false Default = false	Governs whether the service routes the message to the CAVS end point. The default value is false, which does not route to CAVS. If set to true, it routes to CAVS using the end point specified in the CAVS.EndpointURI property.
Routing.CustomerPartyEBSV2.SyncCustomerPartyList.CAVS.End point URI	http://\${http.hostname}:\${http.port}/AIAValidationSystemServlet/asyncrequestrecipient	CAVS end point URI, when CAVS is enabled.
Routing.CustomerPartyEBSV2.SyncCustomerPartyList.MessageProcessingInstruction.EnvironmentCode	PRODUCTION	Governs whether the message is routed to CAVS or to the specified target service. The default value is PRODUCTION, which routes to the target service.
Routing.CustomerPartyEBSV2.SyncCustomerPartyList.RouteToCAVS	true/false Default = false	Governs whether the service routes the message to the CAVS end point. The default value is false, which does not route to CAVS. If set to true, it routes to CAVS using the end point specified in the CAVS.EndpointURI property.
ABCSExtension.PreXformCreateABMtoEBMABM	true/false Default = false	Governs whether Application Business Connector Service (ABCS) extension is enabled at the predefined plug-into point. If set to true, then the Extension process (defined along AIA ABCS extension guidelines) is invoked.
ABCSExtension.PreInvokeCustEBSEBM	true/false Default = false	Governs whether ABCS extension is enabled at the predefined plug-into point. If set to true, then the Extension process (defined along AIA ABCS extension guidelines) is invoked.

Table 6–17 lists the properties for the BatchLoadProductEbizReqABCImpl service:

Table 6–17 Properties for the BatchLoadProductEbizReqABCSEmpl Service

Property Name	Value/Default Value	Description
Default.SystemID	EBIZ_01	Ebiz system code (such as EBIZ_01, defined in BSR) to which data is synchronized. The system code value present in the EBM header of the incoming message takes precedence over this property value.
Routing.QuerySimpleItemBatchLoadAdapter.EBIZ_01.EndpointURI	http://<SOA_HOST>:<SOA_PORT>/soa-infra/services/default/QuerySimpleItemBatchLoadAdapter/QuerySimpleItemBatchLoadAdapter_ep	End point URI of Ebiz Adapter.
Routing.QuerySimpleItemBatchLoadAdapter.RouteToCAVS	true/false Default = false	Governs whether the service routes the message to the CAVS end point. The default value is false, which does not route to CAVS. If set to true, it routes to CAVS using the end point specified in the CAVS.EndpointURI property.
Routing.QuerySimpleItemBatchLoadAdapter.CAVS.EndpointURI	http://\${http.hostname}:\${http.port}/AIAValidationSystemServlet/asyncreponse recipient	CAVS end point URI, when CAVS is enabled.
Routing.ItemEBSV2.SyncItemList.RouteToCAVS	true/false Default = false	Governs whether the service routes the message to the CAVS end point. The default value is false, which does not route to CAVS. If set to true, it routes to CAVS using the end point specified in the CAVS.EndpointURI property.
Routing.ItemEBSV2.SyncItemList.MessageProcessingInstruction.EnvironmentCode	Default = PRODUCTION	Governs whether the message is routed to CAVS or to the specified target service. The default value is PRODUCTION, which routes to the target service.
Routing.ItemEBSV2.SyncItemList.CAVS.End point URI	http://<SOA_HOST>:<SOA_PORT>/AIAValidationSystemServlet/asyncreponse recipient	CAVS End point URI, when CAVS is enabled.
ABCSExtension.PreXformABM ToEBM	true/false Default = false	Governs whether ABCS extension is enabled at the predefined plug-into point. If set to true, then the Extension process (defined along AIA ABCS extension guidelines) is invoked.
ABCSExtension.PreInvokeItem EBSEBM	true/false Default = false	Governs whether ABCS extension is enabled at the predefined plug-into point. If set to true, then the extension process (defined along AIA ABCS extension guidelines) is invoked.
SourceMilestone	WF_BPEL_Q	The source AQ Queue from which the batchload messages are coming.

Table 6–18 lists the properties for the CreateProductEbizReqABCSEmpl service:

Table 6–18 Properties for the CreateProductEbizReqABCSEImpl Service

Property Name	Value/Default Value	Description
Default.SystemID	EBIZ_01	Ebiz system code (such as EBIZ_01, defined in BSR) to which data is synchronized. The system code value present in the EBM header of the incoming message takes precedence over this property value.
Routing.QuerySimpleItemAdapter.EBIZ_01.EndpointURI	http://<SOA_HOST>:<SOA_PORT>/soa-infra/services/default/QuerySimpleItemAdapter/QuerySimpleItemAdapter_ep?WSDL	End point URI of Ebiz Adapter.
Routing.QuerySimpleItemAdapter.RouteToCAVS	true/false Default = false	Governs whether the service routes the message to the CAVS end point. The default value is false, which does not route to CAVS. If set to true, it routes to CAVS using the end point specified in the CAVS.EndpointURI property.
Routing.ItemEBSV2.SyncItemList.RouteToCAVS	true/false Default = false	Governs whether the service routes the message to the CAVS end point. The default value is false, which does not route to CAVS. If set to true, it routes to CAVS using the End point specified in the CAVS.EndpointURI property.
Routing.ItemEBSV2.SyncItemList.MessageProcessingInstruction.Environment Code	Default value = PRODUCTION	Governs whether the message is routed to CAVS or to the specified target service. The default value is PRODUCTION, which routes to the target service.
Routing.ItemEBSV2.SyncItemList.CAVS.End point URI	http://<SOA_HOST>:<SOA_PORT>/AIAValidationSystemServlet/asyncresponserecipient	CAVS end point URI, when CAVS is enabled.
Routing.QuerySimpleItemAdapter.CAVS.End point URI	http://<SOA_HOST>:<SOA_PORT>/AIAValidationSystemServlet/asyncresponserecipient	CAVS end point URI, when CAVS is enabled.
BYPASS_ITEMVALIDATIONORG_FLAG	Y/N Default value=N	This property controls bypassing the validation of the organization associated with an item against OE:Item Validation Org. By default, the organization associated with an Item is validated against OE:Item Validation Org.
ABCSExtension.PreXformABMToEBM	true/false Default = false	Governs whether ABCS extension is enabled at the predefined plug-in to point. If set to true, then the Extension process (defined along AIA ABCS extension guidelines) is invoked.
ABCSExtension.PreInvokeItem EBSEBM	true/false Default = false	Governs whether ABCS extension is enabled at the predefined plug-in to point. If set to true, then the Extension process (defined along AIA ABCS extension guidelines) is invoked.
PUBLISH_ALL_PRODUCT	Y/N Default = N	Governs whether to synchronize both nonorderable and orderable products (when value is Y) or sync only nonorderable products while performing Item sync (when value is N).

Table 6–19 lists the properties for the UpdateProductEbizReqABCSEImpl service:

Table 6–19 Properties for the UpdateProductEbizReqABCServiceImpl Service

Property Name	Value/Default Value	Description
Default.SystemID	EBIZ_01	Ebiz system code (such as EBIZ_01, defined in BSR) to which data is synchronized. The system code value present in the EBM header of the incoming message takes precedence over this property value.
Routing.QuerySimpleItemUpdateAdapter.EBIZ_01.EndpointURI	http://<SOA_HOST>:<SOA_PORT>/soa-infra/services/default/QuerySimpleItemUpdateAdapter/QuerySimpleItemUpdateAdapter_ep?WSDL	End point URI of Ebiz Adapter.
Routing.QuerySimpleItemUpdateAdapter.RouteToCAVS	true/false Default = false	Governs whether the service routes the message to the CAVS end point. The default value is false, which does not route to CAVS. If set to true, it routes to CAVS using the end point specified in the CAVS.EndpointURI property.
BYPASS_ITEMVALIDATION_ORG_FLAG	Y/N Default =N	This property controls bypassing the validation of the organization associated with an item against OE:Item Validation Org. By default, the organization associated with an item is validated against OE:Item Validation Org.
ABCSExtension.PreXformABMToEBM	true/false Default = false	Governs whether ABCS extension is enabled at the predefined plug-in to point. If set to true, then the Extension process (defined along AIA ABCS extension guidelines) is invoked.
ABCSExtension.PreInvokeItem EBSEBM	true/false Default = false	Governs whether ABCS extension is enabled at the predefined plug-in to point. If set to true, then the Extension process (defined along AIA ABCS extension guidelines) is invoked.
Routing.ItemEBSV2.SyncItemList.RouteToCAVS	true/false Default = false	Governs whether the service routes the message to the CAVS. The default value is false, which does not route to CAVS. If set to true, it routes to CAVS using the end point specified in the CAVS.EndpointURI property.
Routing.ItemEBSV2.SyncItemList.MessageProcessingInstruction.Environment Code	Default value = PRODUCTION	Governs whether the message is routed to CAVS or to the specified target service. The default value is PRODUCTION, which routes to the target service.
Routing.ItemEBSV2.SyncItemList.CAVS.Endpoint URI	http://<SOA_HOST>:<SOA_PORT>/AIAValidationSystemServlet/asyncreponserecipient	CAVS end point URI, when CAVS is enabled.
Routing.QuerySimpleItemUpdateAdapter.CAVS.EndpointURI	http://<SOA_HOST>:<SOA_PORT>/AIAValidationSystemServlet/asyncreponserecipient	CAVS end point URI, when CAVS is enabled.

Table 6–20 lists the properties for the CreateSalesOrderEbizProvABCServiceImpl service:

Table 6–20 Properties for the CreateSalesOrderEbizProvABCSTmpl Service

Property Name	Value/Default Value	Description
Default.SystemID	EBIZ_01	Ebiz system code (such as EBIZ_01, defined in BSR) from which requests originate for this process.
Routing.ProcessSalesOrderEbizAdapter.EBIZ_01.EndpointURI	http://<SOA_HOST>:<SOA_PORT>/soa-infra/services/default/ProcessSalesOrderEbizAdapter/ProcessSalesOrderEbizAdapter_ep	End point URI of the Ebiz adapter.
Routing.ProcessSalesOrderEbizAdapter.RouteToCAVS	true/false Default = false	Governs whether the service routes the message to the CAVS end point. The default value is false, which does not route to CAVS. If set to true, it routes to CAVS using the end point specified in the CAVS.EndpointURI property.
Routing.ProcessSalesOrderEbizAdapter.CAVS.EndpointURI	http://<SOA_HOST>:<SOA_PORT>/AIAValidationSystemServlet/syncresponsesimulator	CAVS end point URI, when CAVS is enabled.
Routing.SalesOrderResponseEBSV2.CreateSalesOrderResponse.RouteToCAVS	true/false Default = false	Governs whether the service routes the message to the CAVS end point. The default value is false, which does not route to CAVS. If set to true, it routes to CAVS using the end point specified in the CAVS.EndpointURI property.
Routing.SalesOrderResponseEBSV2.CreateSalesOrderResponse.CAVS.EndpointURI	http://<SOA_HOST>:<SOA_PORT>/AIAValidationSystemServlet/asyncreponserrecipient	CAVS end point URI, when CAVS is enabled.
RMAOrderTypes	RMA	This property defines the value for RMA order types. The list of code values that represent RMA order types. This affects the attribute mappings. This is a comma-separated (no spaces) list of string values.
ABCSExtension.PreXformEBMToABM	true/false Default = false	Governs whether ABCS extension is enabled at the predefined plug-in to point. If set to true, then the Extension process (defined along AIA ABCS extension guidelines) is invoked.
ABCSExtension.PreInvokeProcessSOEbizAdapter	true/false Default = false	Governs whether ABCS extension is enabled at the predefined plug-in to point. If set to true, then the Extension process (defined along AIA ABCS extension guidelines) is invoked.
ABCSExtension.PostInvokeProcessSOEbizAdapter	true/false Default = false	Governs whether ABCS extension is enabled at the predefined plug-in to point. If set to true, then the Extension process (defined along AIA ABCS extension guidelines) is invoked.

Table 6–20 (Cont.) Properties for the CreateSalesOrderEbizProvABCImpl Service

Property Name	Value/Default Value	Description
ABCSExtension.PostXformABMToEBM	true/false Default = false	Governs whether ABCS extension is enabled at the predefined plug-in to point. If set to true, then the Extension process (defined along AIA ABCS extension guidelines) is invoked.
OrderSourceReference	COMMON/SourceSystemIdentifier Default=COMMON Change this property to OrderSourceReference so that the Oracle E-Business Suite OSR field contains the value of the opportunity ID from the EBM field as follows: corecom:SourceDocumentReference/corecom:DocumentIdentification/corecom:ContextID[@schemeID="OrderSourceReference"]	Property to decide whether OSR holds the common ID or source system identifier.
DefaultOrderSourceId	28	Property to supply the ORDER_SOURCE_ID by default if a data value map lookup failure occurs for quotes.

Table 6–21 lists the properties for the InterfaceSalesOrderToFulfillmentEBF service:

Table 6–21 Properties for the InterfaceSalesOrderToFulfillmentEBF Service

Property Name	Value/Default Value	Description
InterfaceSalesOrderToCustomer	True	Controls whether the InterfaceSalesOrderToCustomerEBF is invoked during order processing.
InterfaceSalesOrderToCustomerResponseRequired	True	Controls whether the InterfaceSalesOrderToCustomerEBF Response is Required during order processing. This must be set to false for the Lead-to-Order: CRM On Demand - Oracle E-Business Suite PIP. The value is set to false during the installation of the PIP.
UpdateSalesOrder	True	Governs whether the Update Order operation has to perform to update the sales order in the source system during order processing. This must be set to false for the Lead-to-Order: CRM On Demand - Oracle E-Business Suite PIP. The value is set to false during the installation of the PIP.
UpdateSalesOrder.ResponseRequired	False	Governs whether a response is required from UpdateSalesOrder.
RMAOrderTypes	RMA	This property defines the value for RMA order types and comprises a list of code values that represent RMA order types. During processing of orders with this type, customer synchronization does not occur. This is a comma-separated (no spaces) list of string values.
InterfaceSalesOrderToCustomer.AsyncTimeoutDuration	PT5M30S	Duration to wait for the asynchronous callback from the InterfaceSalesOrderToCustomer service. If a response is not received within the wait duration, a fault occurs.
CreateSalesOrder.AsyncTimeoutDuration	PT3M	Duration to wait for the asynchronous CreateSalesOrderResponse callback from the SalesOrderResponseEBS service. If a response is not received within the wait duration, a fault occurs.
CreateSalesOrder.ResponseRequired	True	Governs whether response is required from CreateSalesOrder.

Table 6–21 (Cont.) Properties for the InterfaceSalesOrderToFulfillmentEBF Service

Property Name	Value/Default Value	Description
UpdateSalesOrder.AsyncTimeoutDuration	PT1M	Duration to wait for the asynchronous UpdateSalesOrderResponse callback from the SalesOrderResponseEBS service. If a response is not received within the wait duration, a fault occurs.
Routing.SalesOrderEBSV2.CreateSalesOrder.RouteToCAVS	true/false Default = false	Governs whether the service routes the message to the CAVS end point. The default value is false, which does not route to CAVS. If set to true, it routes to CAVS using the end point specified in the CAVS.EndpointURI property.
Routing.SalesOrderEBSV2.CreateSalesOrder.CAVS.EndpointURI	http://<SOA_HOST>:<SOA_PORT>/AIAValidationSystemServlet/asyncresponsesimulator	CAVS end point URI, when CAVS is enabled.
Routing.SalesOrderEBSV2.UpdateSalesOrder.RouteToCAVS	true/false Default = false	Governs whether the service routes the message to the CAVS end point. The default value is false, which does not route to CAVS. If set to true, it routes to CAVS using the end point specified in the CAVS.EndpointURI property.
Routing.SalesOrderEBSV2.UpdateSalesOrder.CAVS.EndpointURI	http://<SOA_HOST>:<SOA_PORT>/AIAValidationSystemServlet/asyncresponsesimulator	CAVS end point URI, when CAVS is enabled.
Routing.SalesOrderOrchestrationEBSV2.InterfaceSalesOrderToCustomer.RouteToCAVS	true/false Default = false	Governs whether the service routes the message to the CAVS end point. The default value is false, which does not route to CAVS. If set to true, it routes to CAVS using the end point specified in the CAVS.EndpointURI property.
Routing.SalesOrderOrchestrationEBSV2.InterfaceSalesOrderToCustomer.CAVS.EndpointURI	http://<SOA_HOST>:<SOA_PORT>/AIAValidationSystemServlet/asyncresponsesimulator	CAVS end point URI, when CAVS is enabled.
Routing.SalesOrderOrchestrationResponseEBSV2.InterfaceSalesOrderToFulfillmentResponse.RouteToCAVS	true/false Default = false	Governs whether the service routes the message to the CAVS end point. The default value is false, which does not route to CAVS. If set to true, it routes to CAVS using the end point specified in the CAVS.EndpointURI property.
Routing.SalesOrderOrchestrationResponseEBSV2.InterfaceSalesOrderToFulfillmentResponse.CAVS.EndpointURI	http://<SOA_HOST>:<SOA_PORT>/AIAValidationSystemServlet/asyncresponserecipient	CAVS end point URI, when CAVS is enabled.
isLegacyEbizProviderSupported	True/false Default=false	This must be set to true for the Lead-to-Order: CRM On Demand - Oracle E-Business Suite PIP. The value is set to true during the installation of the PIP.
SyncSalesOrder.ResponseRequired	True	Governs whether response is required from SyncSalesOrder.
SyncSalesOrder.AsyncTimeoutDuration	PT3M	Governs the duration to wait for the response.
Routing.SalesOrderEBSV2.SyncSalesOrderList.RouteToCAVS	True/false Default=false	Governs whether the service routes the message to the CAVS end point. The default value is false, which does not route to CAVS. If set to true, it routes to CAVS using the end point specified in the CAVS.EndpointURI property.
Routing.SalesOrderEBSV2.SyncSalesOrderList.CAVS.EndpointURI	http://<SOA_HOST>:<SOA_PORT>/AIAValidationSystemServlet/asyncresponsesimulator	CAVS end point URI, when CAVS is enabled.

Table 6–22 lists the properties for the InterfaceSalesOrderToCustomerEBFV2 service:

Table 6–22 Properties for the InterfaceSalesOrderToCustomerEBFV2 Service

Property Name	Value/Default Value	Description
Routing.SalesOrderOrchestrationResponseEBSV2.InterfaceSalesOrderToCustomerResponse.RouteToCAVS	true/false Default = false	Governs whether the service routes the message to the CAVS. The default value is false, which does not route to CAVS. If set to true, it routes to CAVS using the end point specified in the CAVS.EndpointURI property.
Routing.SalesOrderOrchestrationResponseEBSV2.InterfaceSalesOrderToCustomerResponse.CAVS.End point URI	http://<SOA_HOST>:<SOA_PORT>/AIAValidationSystemServlet/asyncreponserecipient	CAVS end point URI, when CAVS is enabled.
InterfaceCustomerToFulfillment.AsyncTimeoutDuration	PT5M	Duration to wait for the asynchronous InterfaceCustomerToFulfillmentResponse callback from the SalesOrderOrchestrationResponseEBS service. If a response is not received within the wait duration, a fault occurs.
InterfaceCustomerToFulfillmentResponseRequired	True	Governs whether the InterfaceCustomerToFulfillmentResponse is Required. This must be set to false for the Lead-to-Order: CRM On Demand - Oracle E-Business Suite PIP. The value is set to false during the installation of the PIP.
Routing.CustomerPartyOrchestrationEBSV2.InterfaceCustomerToFulfillment.RouteToCAVS	true/false Default=false	Governs whether the service routes the message to the CAVS. The default value is false, which does not route to CAVS. If set to true, it routes to CAVS using the end point specified in the CAVS.EndpointURI property.
Routing.CustomerPartyOrchestrationEBSV2.InterfaceCustomerToFulfillment.CAVS.EndpointURI	http://<SOA_HOST>:<SOA_PORT>/AIAValidationSystemServlet/asyncreponsesimulator	CAVS end point URI, when CAVS is enabled.

Table 6–23 lists the properties for the InterfaceCustomerToFulfillmentEBF service:

Table 6–23 Properties for the InterfaceCustomerToFulfillmentEBF Service

Property Name	Value/Default Value	Description
InterfaceCustomerToFulfillment	true/false Default = true	Standard properties to control EBF functionality.
ProcessCustomerPartyList	true/false Default = true	Standard properties to control EBF functionality.
SyncCustomerPartyList.AsyncTimeoutDuration	Default value = PT5M	Specifies the time for which the service waits to receive a response. If a response is not received within this time, the process times out and terminates.
Routing.CustomerPartyEBSV2.SyncCustomerPartyList.MessageProcessingInstruction.EnvironmentCode	Default value = PRODUCTION	Governs whether the message is routed to CAVS or to the specified target service. The default value is PRODUCTION, which routes to the target service.
Routing.CustomerPartyEBSV2.QueryCustomerPartyList.MessageProcessingInstruction.EnvironmentCode	Default value = PRODUCTION	Governs whether the message is routed to CAVS or to the specified target service. The default value is PRODUCTION, which routes to the target service.
Routing.CustomerPartyEBSV2.SyncCustomerPartyList.RouteToCAVS	true/false Default = false	Governs whether the service routes the message to the CAVS end point. The default value is false, which does not route to CAVS. If set to true, it routes to CAVS using the end point specified in the CAVS.EndpointURI property.
Routing.CustomerPartyEBSV2.QueryCustomerPartyList.RouteToCAVS	true/false Default = false	Governs whether the service routes the message to the CAVS end point. The default value is false, which does not route to CAVS. If set to true, it routes to CAVS using the end point specified in the CAVS.EndpointURI property.

Table 6–23 (Cont.) Properties for the InterfaceCustomerToFulfillmentEBF Service

Property Name	Value/Default Value	Description
Routing.CustomerPartyEBSV2.SyncCustomerPartyList.CAVS.EndpointURI	http://<SOA_HOST>:<SOA_PORT>/AIAValidationSystemServlet/asyncresponsesimulator	CAVS end point URI, when CAVS is enabled.
Routing.CustomerPartyEBSV2.QueryCustomerPartyList.CAVS.EndpointURI	http://<SOA_HOST>:<SOA_PORT>/AIAValidationSystemServlet/syncresponsesimulator	CAVS end point URI, when CAVS is enabled.
SyncCustomerPartyListResponseRequired	True/false Default = true	Governs whether a response is required from SyncCustomerPartyList. This must be set to false for the Lead-to-Order: CRM On Demand - Oracle E-Business Suite PIP. The value is set to false during the installation of the PIP
Routing.CustomerPartyOrchestrationResponseEBSV2.InterfaceCustomerToFulfillmentResponse.MessageProcessingInstruction.EnvironmentCode	Default = PRODUCTION	Governs whether the message is routed to CAVS or to the specified target service. The default value is PRODUCTION, which routes to the target service.
Routing.CustomerPartyOrchestrationResponseEBSV2.InterfaceCustomerToFulfillmentResponse.RouteToCAVS	True/false Default=false	Governs whether the service routes the message to the CAVS end point. The default value is false, which does not route to CAVS. If set to true, it routes to CAVS using the end point specified in the CAVS.EndpointURI property.
Routing.CustomerPartyOrchestrationResponseEBSV2.InterfaceCustomerToFulfillmentResponse.CAVS.EndpointURI	http://<SOA_HOST>:<SOA_PORT>/AIAValidationSystemServlet/asyncrequestrecipient	CAVS end point URI, when CAVS is enabled.

Table 6–24 lists the properties for the SyncCustomerPartyListEbizReqABCImpl service:

Table 6–24 Properties for the SyncCustomerPartyListEbizReqABCImpl Service

Property Name	Value/Default Value	Description
Default.SystemID	No default value	Ebiz system code (such as EBIZ_01, defined in BSR) from which requests originate for this process.
Routing.QueryCustomerPartyListEbizCreate.CAVS.EndpointURI	http://<SOA_HOST>:<SOA_PORT>/AIAValidationSystemServlet/syncresponsesimulator	CAVS end point URI, when CAVS is enabled.
Routing.QueryCustomerPartyListEbizCreate.RouteToCAVS	true/false Default = false	Governs whether the service routes the message to the CAVS end point. The default value is false, which does not route to CAVS. If set to true, it routes to CAVS using the end point specified in the CAVS.EndpointURI property.
Routing.QueryCustomerPartyListEbizCreateAdapter.EBIZ_01.EndpointURI	http://<SOA_HOST>:<SOA_PORT>/soa-infra/services/default/QueryCustomerPartyListEbizCreateAdapter/QueryCustomerPartyListEbizCreateAdapter_ep	End point URI of the Ebiz adapter.
Routing.QueryCustomerPartyListEbizUpdate.CAVS.EndpointURI	http://<SOA_HOST>:<SOA_PORT>/AIAValidationSystemServlet/syncresponsesimulator	CAVS end point URI, when CAVS is enabled.
Routing.QueryCustomerPartyListEbizUpdate.RouteToCAVS	true/false Default = false	Governs whether the service routes the message to the CAVS end point. The default value is false, which does not route to CAVS. If set to true, it routes to CAVS using the end point specified in the CAVS.EndpointURI property.

Table 6–24 (Cont.) Properties for the SyncCustomerPartyListEbizReqABCSEImpl Service

Property Name	Value/Default Value	Description
Routing.QueryCustomerPartyListEbizUpdateAdapter.EBIZ_01.EndpointURI	http://<SOA_HOST>:<SOA_PORT>/soa-infra/services/default/QueryCustomerPartyListEbizUpdateAdapter/QueryCustomerPartyListEbizUpdateAdapter_ep	End point URI of the Ebiz adapter.
Routing.CustomerPartyEBSV2.SyncCustomerPartyList.RouteToCAVS	true/false Default = false	Governs whether the service routes the message to the CAVS end point. The default value is false, which does not route to CAVS. If set to true, it routes to CAVS using the end point specified in the CAVS.EndpointURI property.
Routing.CustomerPartyEBSV2.SyncCustomerPartyList.MessageProcessingInstruction.EnvironmentCode	Default value = PRODUCTION	Governs whether the message is routed to CAVS or to the specified target service. The default value is PRODUCTION, which routes to the target service.
Routing.CustomerPartyEBSV2.SyncCustomerPartyList.CAVS.End point URI	http://<SOA_HOST>:<SOA_PORT>/AIAValidationSystemServlet/asyncrequestrecipient	CAVS end point URI, when CAVS is enabled.
ABCSExtension.PreXformCreateABMtoEBMABM	true/false Default = false	Governs whether ABCS extension is enabled at the predefined plug-in point. If set to true, then the Extension process (defined along AIA ABCS extension guidelines) is invoked.
ABCSExtension.PreXformUpdateABMtoEBMABM	true/false Default = false	Governs whether ABCS extension is enabled at the predefined plug-in point. If set to true, then the Extension process (defined along AIA ABCS extension guidelines) is invoked.
ABCSExtension.PreInvokeCustEBSEBM	true/false Default = false	Governs whether ABCS extension is enabled at the predefined plug-in point. If set to true, then the Extension process (defined along AIA ABCS extension guidelines) is invoked.
SyncAllContactRelationshipTypes	true/false Default = false. Recommended value = true	Allows the integration to synchronize "account contacts" created for relationships when the RELATIONSHIP_TYPE is different to Organization-Contact. For example, "Employment". Set this property to true if you have or use account contacts with a relationship that is not of Organization-Contact type.

Table 6–25 lists the properties for the MergeAccountEbizReqABCSEImpl service:

Table 6–25 Properties for the MergeAccountEbizReqABCSEImpl Service

Property Name	Value/Default Value	Description
Default.SystemID	No default value	Ebiz system code (such as EBIZ_01, defined in BSR) from which requests originate for this process.
Routing.QueryMergeAccountEbizAdapter.EBIZ_01.EndpointURI	http://<SOA_HOST>:<SOA_PORT>/soa-infra/services/default/QueryMergeAccountEbizAdapter/QueryMergeAccountEbizAdapter_ep	End point URI of the Ebiz adapter.
Routing.QueryMergeAccountEbizAdapter.CAVS.EndpointURI	http://<SOA_HOST>:<SOA_PORT>/AIAValidationSystemServlet/synchronousresponsesimulator	CAVS end point URI, when CAVS is enabled.

Table 6–25 (Cont.) Properties for the MergeAccountEbizReqABCSEImpl Service

Property Name	Value/Default Value	Description
Routing.QueryMergeAccountEbizAdapter.RouteToCAVS	true/false Default = false	Governs whether the service routes the message to the CAVS end point. The default value is false, which does not route to CAVS. If set to true, it routes to CAVS using the end point specified in the CAVS.EndpointURI property.
Routing.QueryCustomerPartyEbizAdapter.EBIZ_01.EndpointURI	http://<SOA_HOST>:<SOA_PORT>/soa-infra/services/default/QueryCustomerPartyEbizAdapter/QueryCustomerPartyEbizAdapter_ep	End point URI of the Ebiz adapter.
Routing.QueryCustomerPartyEbizAdapter.CAVS.EndpointURI	http://<SOA_HOST>:<SOA_PORT>/AIAValidationSystemServlet/syncresponsesimulator	CAVS end point URI, when CAVS is enabled.
Routing.QueryCustomerPartyEbizAdapter.RouteToCAVS	true/false Default = false	Governs whether the service routes the message to the CAVS end point. The default value is false, which does not route to CAVS. If set to true, it routes to CAVS using the end point specified in the CAVS.EndpointURI property.
Routing.CustomerPartyEBS.SyncCustomerPartyList.CAVS.EndpointURI	http://<SOA_HOST>:<SOA_PORT>/AIAValidationSystemServlet/asyncrequestrecipient	CAVS end point URI, when CAVS is enabled.
Routing.CustomerPartyEBS.SyncCustomerPartyList.RouteToCAVS	true/false Default = false	Governs whether the service routes the message to the CAVS end point. The default value is false, which does not route to CAVS. If set to true, it routes to CAVS using the end point specified in the CAVS.EndpointURI property.
Routing.CustomerPartyEBS.SyncCustomerPartyList.MessageProcessingInstruction.EnvironmentCode	Default value = PRODUCTION	Governs whether the message is routed to CAVS or to the specified target service. The default value is PRODUCTION, which routes to the target service.
ABCSExtension.PreXformSyncAcctABMToEBMABM	true/false Default = false	Governs whether ABCS extension is enabled at the predefined plug-into point. If set to true, then the Extension process defined along AIA ABCS extension guidelines) is invoked.
ABCSExtension.PreXformMergeAcctABMToEBMABM	true/false Default = false	Governs whether ABCS extension is enabled at the predefined plug-into point. If set to true, then the Extension process (defined along AIA ABCS extension guidelines) is invoked.
ABCSExtension.PreInvokeCustPartyEBS EBM	true/false Default = false	Governs whether ABCS extension is enabled at the predefined plug-into point. If set to true, then the Extension process (defined along AIA ABCS extension guidelines) is invoked.

Table 6–26 lists the properties for the MergePartyEbizReqABCSEImpl service:

Table 6–26 Properties for the MergePartyEbizReqABCImpl Service

Property Name	Value/Default Value	Description
Default.SystemID	No default value	Ebiz system code (such as EBIZ_01, defined in BSR) from which requests originate for this process.
Routing.QueryPartyMergeEbizAdapter.EBIZ_01.EndpointURI	http://<SOA_HOST>:<SOA_PORT>/soa-infra/services/default/QueryPartyMergeEbizAdapter/QueryPartyMergeEbizAdapter_ep	End point URI of the Ebiz adapter.
Routing.QueryPartyMergeEbizAdapter.CAVS.EndpointURI	http://<SOA_HOST>:<SOA_PORT>/AIAValidationSystemServlet/syncresponsesimulator	CAVS end point URI, when CAVS is enabled.
Routing.QueryPartyMergeEbizAdapter.RouteToCAVS	true/false Default = false	Governs whether the service routes the message to the CAVS end point. The default value is false, which does not route to CAVS. If set to true, it routes to CAVS using the end point specified in the CAVS.EndpointURI property.
Routing.QueryMergeOrgCustEbizAdapter.EBIZ_01.EndpointURI	http://<SOA_HOST>:<SOA_PORT>/soa-infra/services/default/QueryMergeOrgCustEbizAdapter/QueryMergeOrgCustEbizAdapter_ep	End point URI of the Ebiz adapter.
Routing.QueryMergeOrgCustEbizAdapter.CAVS.EndpointURI	http://<SOA_HOST>:<SOA_PORT>/AIAValidationSystemServlet/syncresponsesimulator	CAVS end point URI, when CAVS is enabled.
Routing.QueryMergeOrgCustEbizAdapter.RouteToCAVS	true/false Default = false	Governs whether the service routes the message to the CAVS end point. The default value is false, which does not route to CAVS. If set to true, it routes to CAVS using the end point specified in the CAVS.EndpointURI property.
Routing.QueryRelatedOrgCustEbizAdapter.EBIZ_01.EndpointURI	http://<SOA_HOST>:<SOA_PORT>/soa-infra/services/default/QueryRelatedOrgCustEbizAdapter/QueryRelatedOrgCustEbizAdapter_ep	End point URI of the Ebiz adapter.
Routing.QueryRelatedOrgCustEbizAdapter.CAVS.EndpointURI	http://<SOA_HOST>:<SOA_PORT>/AIAValidationSystemServlet/syncresponsesimulator	CAVS end point URI, when CAVS is enabled.
Routing.QueryRelatedOrgCustEbizAdapter.RouteToCAVS	true/false Default = false	Governs whether the service routes the message to the CAVS end point. The default value is false, which does not route to CAVS. If set to true, it routes to CAVS using the end point specified in the CAVS.EndpointURI property.
Routing.CustomerPartyEBS.SyncCustomerPartyList.CAVS.EndpointURI	http://<SOA_HOST>:<SOA_PORT>/AIAValidationSystemServlet/asyncrequestrecipient	CAVS end point URI, when CAVS is enabled.
Routing.CustomerPartyEBS.SyncCustomerPartyList.MessageProcessingInstruction.EnvironmentCode	Default value = PRODUCTION	Governs whether the message is routed to CAVS or to the specified target service. The default value is PRODUCTION, which routes to the target service.
Routing.CustomerPartyEBS.SyncCustomerPartyList.RouteToCAVS	true/false Default = false	Governs whether the service routes the message to the CAVS end point. The default value is false, which does not route to CAVS. If set to true, it routes to CAVS using the end point specified in the CAVS.EndpointURI property.

Table 6–26 (Cont.) Properties for the MergePartyEbizReqABCServiceImpl Service

Property Name	Value/Default Value	Description
ABCSExtension.PreXformABMToEBMABM	true/false Default = false	Governs whether ABCS extension is enabled at the predefined plug-into point. If set to true, then the Extension process (defined along AIA ABCS extension guidelines) is invoked.
ABCSExtension.PreXformRelatedABMToEBMABM	true/false Default = false	Governs whether ABCS extension is enabled at the predefined plug-into point. If set to true, then the Extension process (defined along AIA ABCS extension guidelines) is invoked.
ABCSExtension.PreInvokeSyncCustomerPartyEBSEBM	true/false Default = false	Governs whether ABCS extension is enabled at the predefined plug-into point. If set to true, then the Extension process (defined along AIA ABCS extension guidelines) is invoked.

Table 6–27 lists the properties for the SyncCustomerPartyListEbizProvABCServiceImpl service:

Table 6–27 Properties for the SyncCustomerPartyListEbizProvABCServiceImpl Service

Property Name	Value/Default Value	Description
Routing.SyncCustomerPartyListPersonEbizAdapter.EBIZ_01.EndpointURI	http://<SOA_HOST>:<SOA_PORT>/soa-infra/services/default/SyncCustomerPartyListPersonEbizAdapter/SyncCustomerPartyListPersonEbizAdapter_ep	End point URI of the Ebiz adapter.
Routing.SyncCustomerPartyListPersonEbizAdapter.CAVS.EndpointURI	http://<SOA_HOST>:<SOA_PORT>/AIAValidationSystemServlet/syncresponsesimulator	CAVS end point URI, when CAVS is enabled.
Default.SystemID	No default value	Ebiz system code (such as EBIZ_01, defined in BSR) to which data is synced. The system code value present in the EBM header of the incoming message takes precedence over this property value.
Routing.SyncCustomerPartyListEbizAdapter.EBIZ_01.EndpointURI	http://<SOA_HOST>:<SOA_PORT>/soa-infra/services/default/SyncCustomerPartyListEbizAdapter/SyncCustomerPartyListEbizAdapter_ep	End point URI of the Ebiz adapter.
Routing.SyncCustomerPartyListEbizAdapter.CAVS.EndpointURI	http://<SOA_HOST>:<SOA_PORT>/AIAValidationSystemServlet/syncresponsesimulator	CAVS end point URI, when CAVS is enabled.
Routing.SyncCustomerPartyListEbizAdapter.RouteToCAVS	true/false Default = false	Governs whether the service routes the message to the CAVS end point. The default value is false, which does not route to CAVS. If set to true, it routes to CAVS using the end point specified in the CAVS.EndpointURI property.
Routing.SyncCustomerPartyListPersonEbizAdapter.RouteToCAVS	False	Governs whether the service routes the message to the CAVS end point. The default value is false, which does not route to CAVS. If set to true, it routes to CAVS using the end point specified in the CAVS.EndpointURI property.
Routing.CustomerPartyResponseEBSV2.SyncCustomerPartyListResponse.MessageProcessingInstruction.EnvironmentCode	Default value = PRODUCTION	Governs whether the message is routed to CAVS or to the specified target service. The default value is PRODUCTION, which routes to the target service.

Table 6–27 (Cont.) Properties for the SyncCustomerPartyListEbizProvABCsImpl Service

Property Name	Value/Default Value	Description
Routing.CustomerPartyResponseEBSV2.SyncCustomerPartyListResponse.RouteToCAVS	true/false Default = false	Governs whether the service routes the message to the CAVS end point. The default value is false, which does not route to CAVS. If set to true, it routes to CAVS using the end point specified in the CAVS.EndpointURI property.
Routing.CustomerPartyResponseEBSV2.SyncCustomerPartyListResponse.CAVS.End point URI	http://<SOA_HOST>:<SOA_PORT>/AIAValidationSystemServlet/asyncrequestrecipient	CAVS end point URI, when CAVS is enabled.
ABCSExtension.PreXformEBMtoABMEBM	true/false Default = false	Governs whether ABCS extension is enabled at the predefined plug-in point. If set to true, then the Extension process (defined along AIA ABCS extension guidelines) is invoked.
ABCSExtension.PreInvokeEbizAdapterABM	true/false Default = false	Governs whether ABCS extension is enabled at the predefined plug-in point. If set to true, then the Extension process (defined along AIA ABCS extension guidelines) is invoked.
ABCSExtension.PostInvokeEbizAdapterABM	true/false Default = false	Governs whether ABCS extension is enabled at the predefined plug-in point. If set to true, then the Extension process (defined along AIA ABCS extension guidelines) is invoked.
ABCSExtension.PostXformABMtoEBMEBM	true/false Default = false	Governs whether ABCS extension is enabled at the predefined plug-in point. If set to true, then the Extension process (defined along AIA ABCS extension guidelines) is invoked.

Table 6–28 lists the properties for the InterfaceSalesQuoteToFulfillmentEBF service:

Table 6–28 Properties for the InterfaceSalesQuoteToFulfillmentEBF Service

Property Name	Value/Default Value	Description
InterfaceSalesQuoteToCustomer	true/false	The default value is true. Controls whether the InterfaceQuoteToCustomerEBF is invoked during Quote processing.
InterfaceSalesQuoteToCustomerResponseReq	true/false	The default value is false. Controls whether to wait for a response from the InterfaceQuoteToCustomerEBF. If set to true, then the global transaction commits at the point.
InterfaceSalesQuoteToCustomer.AsyncTimeoutDuration	Duration (for example, 'PT5M30S' represents 5 min, 30 seconds)	Duration to wait for the asynchronous callback from the InterfaceSalesQuoteToCustomer service. If a response is not received within the wait duration, a fault occurs.
CreateSalesQuote.AsyncTimeoutDuration	Duration (for example, 'PT5M30S' represents 5 min, 30 seconds)	Duration to wait for the asynchronous CreateSalesQuoteResponse callback from the SalesQuoteResponseEBS service. If a response is not received within the wait duration, a fault occurs.
Routing.SalesQuoteEBS.CreateSalesQuote.RouteToCAVS	true/false	Enable/disable CAVS.
Routing.SalesQuoteEBS.CreateSalesQuote.CAVS.EndpointURI	http://<SOA_HOST>:<SOA_PORT>/AIAValidationSystemServlet/asyncresponsesimulator	CAVS End point URL with optional simulator ID included in the query string.

Table 6–28 (Cont.) Properties for the InterfaceSalesQuoteToFulfillmentEBF Service

Property Name	Value/Default Value	Description
Routing.SalesQuoteOrchestrationEBS.InterfaceSalesQuoteToCustomer.RouteToCAVS	true/false	Enable/disable CAVS.
Routing.SalesQuoteOrchestrationEBS.InterfaceSalesQuoteToCustomer.CAVS.Endpoint URI	http://<SOA_HOST>:<SOA_PORT>/AIAValidationSystemServlet/asyncresponsesimulator	CAVS End point URL with optional simulator ID included in the query string.
Routing.SalesQuoteOrchestrationResponseEBS.InterfaceSalesQuoteToFulfillmentResponse.RouteToCAVS	true/false	Enable/disable CAVS.
Routing.SalesQuoteOrchestrationResponseEBS.InterfaceSalesQuoteToFulfillmentResponse.CAVS.Endpoint URI	http://<SOA_HOST>:<SOA_PORT>/AIAValidationSystemServlet/asyncresponserecipient	CAVS End point URL with optional simulator ID included in the query string.

Table 6–29 lists the properties for the CreateCustomerPartyEbizProvABCImpl service:

Table 6–29 Properties for the CreateCustomerPartyEbizProvABCImpl Service

Property Name	Value/Default Value	Description
Default.SystemID	No default value	Ebiz system code (such as EBIZ_01, defined in BSR) to which data is synced. The system code value present in the EBM header of the incoming message takes precedence over this property value.
Routing.CreateCustomerPartyEbizAdapter.EBIZ_01.EndpointURI	http://<SOA_HOST>:<SOA_PORT>/soa-infra/services/default/SyncCustomerPartyListEbizAdapter/SyncCustomerPartyListEbizAdapter_ep	End point URI of the Ebiz adapter.
Routing.CreateCustomerPartyEbizAdapter.CAVS.EndpointURI	http://<SOA_HOST>:<SOA_PORT>/AIAValidationSystemServlet/asyncresponsesimulator	CAVS end point URI, when CAVS is enabled.
Routing.CreateCustomerPartyEbizAdapter.RouteToCAVS	true/false Default = false	Governs whether the service routes the message to the CAVS end point. The default value is false, which does not route to CAVS. If set to true, it routes to CAVS using the end point specified in the CAVS.EndpointURI property.
Routing.CustomerPartyResponseEBSV2.CreateCustomerPartyResponse.MessageProcessingInstruction.EnvironmentCode	Default value = PRODUCTION	Governs whether the message is routed to CAVS or to the specified target service. The default value is PRODUCTION, which routes to the target service.
Routing.CustomerPartyResponseEBSV2.CreateCustomerPartyResponse.RouteToCAVS	true/false Default = false	Governs whether the service routes the message to the CAVS end point. The default value is false, which does not route to CAVS. If set to true, it routes to CAVS using the end point specified in the CAVS.EndpointURI property.
Routing.CustomerPartyResponseEBSV2.CreateCustomerPartyResponse.CAVS.EndpointURI	http://<SOA_HOST>:<SOA_PORT>/AIAValidationSystemServlet/asyncrequestrecipient	CAVS end point URI, when CAVS is enabled.
ABCSExtension.PreXformEBMtoABMEM	true/false Default = false	Governs whether ABCS extension is enabled at the predefined plug-into point. If set to true, then the Extension process (defined along AIA ABCS extension guidelines) is invoked.
ABCSExtension.PreInvokeEbizAdapterABM	true/false Default = false	Governs whether ABCS extension is enabled at the predefined plug-into point. If set to true, then the Extension process (defined along AIA ABCS extension guidelines) is invoked.

Table 6–29 (Cont.) Properties for the CreateCustomerPartyEbizProvABCServiceImpl Service

Property Name	Value/Default Value	Description
ABCSExtension.PostInvokeEbizAdapterABM	true/false Default = false	Governs whether ABCS extension is enabled at the predefined plug-into point. If set to true, then the Extension process (defined along AIA ABCS extension guidelines) is invoked.
ABCSExtension.PostXformABMtoEBMBM	true/false Default = false	Governs whether ABCS extension is enabled at the predefined plug-into point. If set to true, then the Extension process (defined along AIA ABCS extension guidelines) is invoked.
ABCSExtension.PreXformEBMtoPersonABMEBM	true/false Default = false	Governs whether ABCS extension is enabled at the predefined plug-into point. If set to true, then the Extension process (defined along AIA ABCS extension guidelines) is invoked.
ABCSExtension.PostXformPersonABMtoEBMEBM	true/false Default = false	Governs whether ABCS extension is enabled at the predefined plug-into point. If set to true, then the Extension process (defined along AIA ABCS extension guidelines) is invoked.

Table 6–30 lists the properties for the UpdateCustomerPartyEbizProvABCServiceImpl service:

Table 6–30 Properties for the UpdateCustomerPartyEbizProvABCServiceImpl Service

Property Name	Value/Default Value	Description
Default.SystemID	No default value	Ebiz system code (such as EBIZ_01, defined in BSR) to which data is synced. The system code value present in the EBM header of the incoming message takes precedence over this property value.
Routing.SyncCustomerPartyListEbizAdapter.EBIZ_01.EndpointURI	http://<SOA_HOST>:<SOA_PORT>/soa-infra/services/default/SyncCustomerPartyListEbizAdapter/SyncCustomerPartyListEbizAdapter_ep	End point URI of the Ebiz adapter.
Routing.SyncCustomerPartyListEbizAdapter.CAVS.EndpointURI	http://<SOA_HOST>:<SOA_PORT>/AIAValidationSystemServlet/syncreponsesimulator	CAVS end point URI, when CAVS is enabled.
Routing.SyncCustomerPartyListEbizAdapter.RouteToCAVS	true/false Default = false	Governs whether the service routes the message to the CAVS end point. The default value is false, which does not route to CAVS. If set to true, it routes to CAVS using the end point specified in the CAVS.EndpointURI property.
Routing.CustomerPartyResponseEBSV2.UpdateCustomerPartyResponse.MessageProcessingInstruction.EnvironmentCode	Default value = PRODUCTION	Governs whether the message is routed to CAVS or to the specified target service. The default value is PRODUCTION, which routes to the target service.
Routing.CustomerPartyResponseEBSV2.UpdateCustomerPartyResponse.RouteToCAVS	true/false Default = false	Governs whether the service routes the message to the CAVS end point. The default value is false, which does not route to CAVS. If set to true, it routes to CAVS using the end point specified in the CAVS.EndpointURI property.
Routing.CustomerPartyResponseEBSV2.UpdateCustomerPartyResponse.CAVS.EndpointURI	http://<SOA_HOST>:<SOA_PORT>/AIAValidationSystemServlet/asyncrequestrecipient	CAVS end point URI, when CAVS is enabled.

Table 6–30 (Cont.) Properties for the UpdateCustomerPartyEbizProvABCImpl Service

Property Name	Value/Default Value	Description
ABCSExtension.PreXformEBMtoABMEM	true/false Default = false	Governs whether ABCS extension is enabled at the predefined plug-into point. If set to true, then the Extension process (defined along AIA ABCS extension guidelines) is invoked.
ABCSExtension.PreInvokeEbizAdapterABM	true/false Default = false	Governs whether ABCS extension is enabled at the predefined plug-into point. If set to true, then the Extension process (defined along AIA ABCS extension guidelines) is invoked.
ABCSExtension.PostInvokeEbizAdapterABM	true/false Default = false	Governs whether ABCS extension is enabled at the predefined plug-into point. If set to true, then the Extension process (defined along AIA ABCS extension guidelines) is invoked.
ABCSExtension.PostXformABMtoEBMEM	true/false Default = false	Governs whether ABCS extension is enabled at the predefined plug-into point. If set to true, then the Extension process (defined along AIA ABCS extension guidelines) is invoked.
ABCSExtension.PreXformEBMtoPersonABMEM	true/false Default = false	Governs whether ABCS extension is enabled at the predefined plug-into point. If set to true, then the Extension process (defined along AIA ABCS extension guidelines) is invoked.
ABCSExtension.PostXformPersonABMtoEBMEM	true/false Default = false	Governs whether ABCS extension is enabled at the predefined plug-into point. If set to true, then the Extension process (defined along AIA ABCS extension guidelines) is invoked.

Table 6–31 lists the properties for the InterfaceSalesQuoteToCustomerEBF service:

Table 6–31 Properties for the InterfaceSalesQuoteToCustomerEBF Service

Property Name	Value/Default Value	Description
Routing.SalesOrderOrchestrationEBSV2.InterfaceCustomerToFulfillment.RouteToCAVS	true/false	Enable/disable CAVS.
Routing.SalesOrderOrchestrationEBSV2.InterfaceCustomerToFulfillment.CAVS.EndpointURI	http://<SOA_HOST>:<SOA_PORT>/AIAValidationSystemServlet/asyncreponsesimulator	CAVS End point URL with optional simulator ID included in the query string.
Routing.SalesQuoteOrchestrationResponseEBS.InterfaceSalesQuoteToCustomerResponse.RouteToCAVS	true/false	Enable/disable CAVS.
Routing.SalesQuoteOrchestrationResponseEBS.InterfaceSalesQuoteToCustomerResponse.CAVS.End point URI	http://<SOA_HOST>:<SOA_PORT>/AIAValidationSystemServlet/asyncreponsesrecipient	CAVS End point URL with optional simulator ID included in the query string.
InterfaceCustomerToFulfillment.AsyncTimeoutDuration	Duration (for example, 'PT5M30S' represents 5 min, 30 seconds)	Duration to wait for the asynchronous InterfaceCustomerToFulfillmentResponse callback from the SalesQuoteOrchestrationResponseEBS service. If a response is not received within the wait duration, a fault occurs.

Table 6–32 lists the properties for the CreateSalesQuoteEbizProvABCImpl service:

Table 6–32 Properties for the CreateSalesQuoteEbizProvABCSEBIZ_01 Service

Property Name	Value/Default Value	Description
Default.SystemID	EBIZ_01	Ebiz system code (such as EBIZ_01, defined in BSR) from which requests originate for this process.
Routing.ProcessSalesOrderEbizAdapter.RouteToCAVS	true/false	Governs whether the service routes the message to the CAVS. The default is false.
Routing.ProcessSalesOrderEbizAdapter.CAVS.EndpointURI	http://://<SOA_HOST>:<SOA_PORT>/AIAValidationSystemServlet/syncreponsesimulator	CAVS end point URI, when CAVS is enabled.
Routing.ProcessSalesOrderEbizAdapter.EBIZ_01.EndpointURI	http://<SOA_HOST>:<SOA_PORT>/soa-infra/services/default/ProcessSalesOrderEbizAdapter/ProcessSalesOrderEbizAdapter_ep	End point URI of the Ebiz adapter.
Routing.CreateSalesQuoteEbizAdapter.RouteToCAVS	true/false	Governs whether the service routes the message to the CAVS. The default is false.
Routing.CreateSalesQuoteEbizAdapter.CAVS.EndpointURI	http://://<SOA_HOST>:<SOA_PORT>/AIAValidationSystemServlet/syncreponsesimulator	CAVS end point URI, when CAVS is enabled.
Routing.CreateSalesQuoteEbizAdapter.EBIZ_01.EndpointURI	http://<SOA_HOST>:<SOA_PORT>/soa-infra/services/default/CreateSalesQuoteEbizAdapter/CreateSalesQuoteEbizAdapter_ep</Property	End point URI of the Ebiz adapter. The end point URI depends on the EBIZ system (EBIZ_01) version. If the EBIZ system is 11.5.10, use http://<SOA_HOST>:<SOA_PORT>/soa-infra/services/default/CreateSalesQuoteEbizAdapter/CreateSalesQuoteEbizAdapter_ep, which is the default. If the EBIZ system is R12.1.1 and above use http://<SOA_HOST>:<SOA_PORT>/soa-infra/services/default/CreateSalesQuoteEbizAdapter/CreateSalesQuoteEbizR12VersionAdapter_ep.
Routing.QueryJTFResourceSalesPersonAdapter.RouteToCAVS	true/false	Governs whether the service routes the message to the CAVS. The default is false.
Routing.QueryJTFResourceSalesPersonAdapter.CAVS.EndpointURI	http://://<SOA_HOST>:<SOA_PORT>/AIAValidationSystemServlet/syncreponsesimulator	CAVS end point URI, when CAVS is enabled.
Routing.QueryJTFResourceSalesPersonAdapter.EBIZ_01.EndpointURI	http://<SOA_HOST>:<SOA_PORT>/soa-infra/services/default/QueryJTFResourceSalesPersonAdapter/QueryJTFResourceSalesPersonAdapter_ep	End point URI of the Ebiz adapter for the Query JTF resource sales person.
Routing.SalesQuoteResponseEBS.CreateSalesQuoteResponse.RouteToCAVS	true/false	Governs whether the service routes the message to the CAVS end point. The default value is false, which does not route to CAVS. If set to true, it routes to CAVS using the end point specified in the CAVS.EndpointURI property.
Routing.SalesQuoteResponseEBS.CreateSalesQuoteResponse.CAVS.EndpointURI	http://<SOA_HOST>:<SOA_PORT>/AIAValidationSystemServlet/asyncreponserecipient	CAVS end point URI, when CAVS is enabled.
ABCSExtension.PreProcessEBM	true/false	The default is false. Governs whether ABCS extension is enabled at the predefined plug-into point. If set to true, then the Extension process (defined along AIA ABCS extension guidelines) is invoked before transforming the Request EBM to ABM.

Table 6–32 (Cont.) Properties for the CreateSalesQuoteEbizProvABCSEmpl Service

Property Name	Value/Default Value	Description
ABCSExtension.PreProcessABM	true/false	The default is false. Governs whether ABCS extension is enabled at the predefined plug-into point. If set to true, then the Extension process (defined along AIA ABCS extension guidelines) is invoked before invoking the ABS.
ABCSExtension.PostProcessABM	true/false	The default is false. Governs whether ABCS extension is enabled at the predefined plug-into point. If set to true, then the Extension process (defined along AIA ABCS extension guidelines) is invoked before transforming the ABM to EBM.
ABCSExtension.PostProcessEBM	true/false	The default is false. Governs whether ABCS extension is enabled at the predefined plug-into point. If set to true, then the Extension process (defined along AIA ABCS extension guidelines) is invoked before invoking the response.
TRACE.LOG.ENABLED	true/false	The default is false. Controls the Trace log creation.
DefaultQuoteSourceId	integer	The default is 29. Property to supply the ORDER_SOURCE_ID by default if a data value map lookup failure exists for quotes.
CRMQuoteProvider	true/false	The default is true. Controls whether to create CRM Quote or OM Quote in Oracle E-Business Suite.

Configuring and Mapping Custom Fields in Oracle CRM On Demand

This chapter provides an overview of how to create custom fields in CRM On Demand and synchronize those fields to Oracle E-Business Suite. This chapter includes the following sections:

- [Section 7.1, "Overview"](#)
- [Section 7.2, "Creating a Custom Field in CRM On Demand"](#)
- [Section 7.3, "Adding Custom Fields in CRM On Demand"](#)
- [Section 7.4, "Updating the CRM On Demand Schema and WSDL"](#)
- [Section 7.5, "Adding the Custom Fields to the Common Utility Query XSL Files"](#)
- [Section 7.6, "Mapping Custom Fields in the BPEL Process Custom XSL Files"](#)
- [Section 7.7, "Deploying the BPEL Process After Amending the Custom XSL File"](#)

7.1 Overview

This chapter describes the steps involved in creating custom fields in CRM On Demand and synchronizing those fields to Oracle E-Business Suite. Perform the following tasks in this sequence:

1. Create a custom field in CRM On Demand.
2. Add custom fields in CRM On Demand.
3. Update the CRM On Demand schema and Web Service Definition Language (WSDL) in the Service-Oriented Architecture (SOA) server.
4. Add the custom fields to the *Common Utility Query XSL* files.
5. Map the custom field in the BPEL process custom XSL files.
6. Deploy the BPEL process.

Note: Do not add custom fields to CRM On Demand Quote and Order objects that are marked Required. It causes the integration to fail because the quote and order conversion processes cannot determine the values to enter in the required fields.

7.2 Creating a Custom Field in CRM On Demand

This topic describes how to create a custom field in CRM On Demand.

To create a custom field:

1. Perform step 4 of the procedure, [Section 6.4.3.1, "Creating the Integration Status Fields"](#).
2. Click **Rename Fields, Advanced**.
3. Note the **Integration** Tag created for the custom field that you just created.

7.3 Adding Custom Fields in CRM On Demand

This custom field is for multi-org implementation only.

For more information, see [Appendix C, "Settings for Multi-Org Implementation"](#)

7.4 Updating the CRM On Demand Schema and WSDL

This topic describes how to update the schema and WSDL in the SOA server.

To update the schema and WSDL:

1. Log in to Oracle CRM On Demand as a user with Administrator privileges.
2. Navigate to **Admin, Web Services Administration**, and select **Web Services v 1.0 Services**.
3. Select the relevant record type.
4. Click the **Download Custom WSDL** link.
5. Search for the **Custom Field Integration** Tag assigned to the field that you created in the [Section 7.2, "Creating a Custom Field in CRM On Demand"](#) procedure.

For example, if you created a custom field titled Phone Extension, it appears as follows:

```
<xsd:element name="PhoneExtension" type="xsdLocal:string10"/>
```

6. Log in to the SOA server.

For more information, see *Oracle Fusion Middleware Developer's Guide for Oracle Application Integration Architecture Foundation Pack 11g Release 1, "Using MDS in AIA."*

7. Navigate to AIA_HOME>/AIAMetaData/AIAComponents/ApplicationObjectLibrary/CRMOD/V1/wsdls.

A WSDL file exists for each object type; the format of the file name is *ObjectName.wsdl*.

8. Locate the WSDL for the object for which you created the custom field.
9. Take a backup copy of the *object.wsdl* file.
10. Edit the *object.wsdl* file by adding the tag in [Example 7-1](#) as the last element under the `<xsd:complexType name="object">` node:

Example 7-1 Tag for Object.wsdl File

```
<xsd:sequence>
<!-- Existing Fields -->
<!-- Custom Field Added -->
<xsd:element name="PhoneExtension"
```



```

type="xsdLocal1:string10"/>
</xsd:sequence>
</xsd:complexType>

```

[Example 7-2](#) shows the entry for the Account object:

Example 7-2 Account Object Entry

```

<xsd:complexType name="Account">
<xsd:sequence>
<!-- Existing Fields -->
<!-- Custom Field Added -->
<xsd:element name="PhoneExtension"
type="xsdLocal1:string10"/>
</xsd:sequence>
</xsd:complexType>

```

11. Repeat the same procedure for the schema file for the relevant object.

On Demand object schema files are located in the <AIA_HOME>/AIAMetaData/AIAComponents/ApplicationObjectLibrary/CRM OD/V1/schemas directory.

Ensure that the WSDL and schema files are edited correctly. If they are not, the relevant BPEL processes do not deploy successfully.

7.5 Adding the Custom Fields to the Common Utility Query XSL Files

A query XSL file exists for every parent object, such as an Account or Contact object. You must add details relating to the custom fields that you create to the XSL file of the object for which you created the custom field. This topic describes the mentioned task.

Note: If an XSL file does not exist for an object, for example, for the Product object, you do not have to perform the steps in this procedure.

To add custom fields to the Common Utility Query XSL files:

1. Locate the XSL files by navigating to <AIA_HOME>/AIAMetaData/AIAComponents/ApplicationObjectLibrary/CRM OD/V1/utills.

The format of the name of each XSL file is *XFormCRMObjectNametQuery.xml*.

2. Take a backup copy of the XSL file for the relevant object.
3. Edit the XSL file by adding the Integration tag assigned to each custom field that you created to the XSL file for the object.

Add the Integration tag after the plSync_Status element. For example, if a custom field named Alternate Name is created for the Account object, and if it has an Integration tag of lt_AlternateName, the XSL file looks like [Example 7-3](#):

Example 7-3 XSL File

```

<xsl:if test="$QueryChildrenOnly != 'Y'">
<od:ParentAccountId/>
<!--Already Defined Mappings --
<od>Status/>
<od:plSync_Status/>
<od:lt_AlternateName/>

```

```
</xsl:if>
```

7.6 Mapping Custom Fields in the BPEL Process Custom XSL Files

To ensure that the custom fields you create in CRM On Demand can be synchronized to Oracle E-Business Suite, you must add details relating to the custom fields to the custom XSL files of the BPEL processes associated with the relevant object.

[Table 7-1](#) lists the BPEL processes and the associated custom XSL files that must be edited whenever a custom field has to be mapped, for each object type.

Table 7-1 BPEL Processes and XSL Files for Objects

Object	BPEL Process	Custom XSL file
Account	SyncCustomerCRMODProvABCSImpl	CustomerEBM_to_AccountABM_Custom.xml
	CreateCustomerCRMODReqABCSImpl	CreateCustomerCRMODABM_To_CreateCustomerPartyEBM_Custom.xml
	UpdateCustomerCRMODReqABCSImpl	UpdateCustomerCRMODABM_To_UpdateCustomerPartyEBM_Custom.xml
Contact	SyncCustomerCRMODProvABCSImpl	CustomerEBMList_To_ContactABMList_Custom.xml
	ProcessContactCRMODReqABCSImpl	Xform_ContactABMReqMsg_to_CustomerPartyEBMReqMsg_Custom.xml
Product	SyncItemListCRMODProvABCSImpl	ItemEBMList_to_ProductABMList_Custom.xml

You can locate the BPEL processes for which an XSL file must be changed on the SOA server at `AIA_HOME/services/Core/CRMOD`.

This topic describes procedures to map the custom field `Account AlternateName`, which has an Integration Tag of `It_AlternateName`, in a provider BPEL process and a requester BPEL process. The `Account` object `AlternateName` field is a custom field to the `CustomerPartyAccount/Name` Element in the `CustomerPartyEBO`.

Note: Do not change existing field mappings defined for the Oracle Lead to Order Integration Pack for Oracle CRM On Demand and Oracle E-Business Suite PIP. Amending these field mappings can cause the integration to function incorrectly.

7.6.1 Mapping the Custom Field in a Provider BPEL Process

This topic describes how to map the custom field `Account AlternateName` in a provider BPEL process.

For account objects, field mappings have to be defined in the `CustomerEBM_to_AccountABM_Custom.xml` file of the `SyncCustomerCRMODProvABCSImpl` BPEL process.

[Example 7-4](#) illustrates the contents of the `CustomerEBM_to_AccountABM_Custom.xml` file.

Example 7-4 Contents for the `CustomerEBM_to_AccountABM_Custom.xml` File

```
<xsl:stylesheet version="1.0" namespacedeclarations >
<!-- User Defined Templates -->
<xsl:template name="AddressType_ext"/>
<xsl:template name="AccountType_ext"/>
</xsl:stylesheet>
```

Two templates are defined: one for the account and another for addresses. When a new custom field is created that represents parent or top-level account details, the corresponding mappings must be defined within the template named AccountType_ext.

The following steps are used to map the **Name** field from the CustomerPartyAccount node in the CustomerPartyEBM to the **AlternateName** custom field created in CRM On Demand.

To map the **Name** field to the **AlternateName** field in the Provider BPEL process:

1. Identify the template in which the field has to be mapped.
2. Check the name space of the **Name** field in the CustomerPartyEBO and note the corresponding namespace prefix from the custom XSL file.

In this example, the prefix is

```
custebo=http://xmlns.oracle.com/EnterpriseObjects/Core/EBO/CustomerParty/V2
```

3. Check the name space of the **AlternateName** field in the CustomerPartyEBO and note the corresponding namespace prefix from the custom XSL file.

In this example, the namespace prefix and value is

```
xsdLocal1="urn:/crmondemand/xml/account"
```

4. Identify the XPATH expression for the Name source field in the CustomerPartyEBO.

The following example illustrates the XPATH expression, excluding the namespace prefix:

```
SyncCustomerPartyListEBM/DataArea/SyncCustomerPartyList/
CustomerPartyAccount/Name
```

5. To map the custom field, **AltenateName**, add the following under the template AccountType_ext:

```
<xsdLocal1:lt_AlternateName>
<xsl:value-of select="custebo:Name"/>
</xsdLocal1:lt_AlternateName>
```

By default, the main XSL file that performs the mapping between Enterprise Business Message (EBM) and the Account CRM On Demand Application Business Message ABM loops through each CustomerPartyAccountNode. If any field under this node must be mapped, then just specifying the Name field is sufficient.

For example, if the Name field exists in the Organization node, which is a child of SyncCustomerPartyList, then the XPATH is similar to the following:

```
<xsl:value-of select=" ../corecom:Organization/custebo:Name" />
```

where "../" indicates to move the control out of CustomerPartyAccount and refer the **Name** field under the Organization node.

[Example 7-5](#) illustrates the *CustomerEBM_to_AccountABM_Custom.xsl* after you have completed the mapping:

Example 7-5 CustomerEBM_to_AccountABM_Customer.xsl

```
<xsl:stylesheet version="1.0"
xmlns:xsdLocal1="urn:/crmondemand/xml/account"
xmlns:corecom="http://xmlns.oracle.com/EnterpriseObjects/Core/Common/V2
xmlns:custebo="http://xmlns.oracle.com/EnterpriseObjects/Core/EBO/CustomerParty/V2
```

```

" >
<xsl:template name="AddressType_ext"/>
<xsl:template name="AccountType_ext"/>
<!--Map Name Field in CustomerPartyAccount Node to AlternateName -->
<xsdLocal1:lt_AlternateName>
<xsl:value-of select="custebo:Name"/>
</xsdLocal1:lt_AlternateName>
<!--Map Organization/MissionStatement to Custom AccountStmnt Field -->
<xsdLocal1:lt_AccountStatement>
<xsl:value-of select="corecom:Organization/corecom:MissionStatement"/>
</xsdLocal1:lt_AccountStatement >
</ xsl:template >
</xsl:stylesheet>

```

7.6.2 Mapping the Custom Field in a Requester BPEL Process

This topic describes how to map the custom field Account AlternateName in a requester BPEL process.

In the topic Mapping the Custom Field in a Provider BPEL Process, the AlternateName field from CRM On Demand was mapped to the Name field in the CustomerPartyAccount node of the CustomerPartyEBO for the Account object. The flows affected by this mapping are:

- CreateCustomerCRMODReqABCImpl
- UpdateCustomerCRMODReqABCImpl

For the CreateCustomerCRMODReqABCImpl BPEL, the custom XSL file is *CreateCustomerCRMODABM_To_CreateCustomerPartyEBM_Custom.xsl*.

[Example 7-6](#) describes the contents of the *CreateCustomerCRMODABM_To_CreateCustomerPartyEBM_Custom.xsl* file:

Example 7-6 CreateCustomerCRMODABM_To_CreateCustomerPartyEBM_Custom.xsl File

```

<xsl:stylesheet version="2.0"
xmlns:customcorecom="http://xmlns.oracle.com/EnterpriseObjects/Core/Custom/Common/V2"
xmlns:corecom="http://xmlns.oracle.com/EnterpriseObjects/Core/Common/V2"
xmlns:customebo="http://xmlns.oracle.com/EnterpriseObjects/Core/Custom/EBO/CustomerParty/V2">
<xsl:template name="CreateCustomerParty_ext">
<!-- Customers add transformations here -->
</xsl:template>
. . . . .
<xsl:template name="PartyContact_ext">
<!-- Customers add transformations here -->
</xsl:template>
</xsl:stylesheet>

```

The following steps are used to map the custom field in the Requester BPEL process.

To map the **Name** field to the **AlternateName** field in the Requester BPEL process:

1. The *CreateCustomerCRMODABM_To_CreateCustomerPartyEBM_Custom.xsl* file has extension templates defined for each node that is available in the CustomerPartyEBO. Identify the Extension Template in which the CRM On Demand custom field must be mapped.

In this example, the template name is "CustomerPartyAccount_ext"

2. Check the namespace for the AlternateName field and note the corresponding namespace prefix that is specified in the appropriate custom XSL file.

In this example, the namespace prefix and value is
xsdLocal1="urn:/crmondemand/xml/account"

3. Check the name space for the Name field in the CustomerPartyEBO and note the corresponding namespace prefix from the custom XSL file.

In this example, it is
ebo=http://xmlns.oracle.com/EnterpriseObjects/Core/EBO/CustomerParty/V2

4. Identify the XPATH expression for the source field AlternateName in the CRM On Demand Account schema.

The following example illustrates the XPATH expression, excluding the namespace prefix: ListOfAccount/Account/AlternateName.

5. To map the AlternateName custom field, add the following under the template named "AccountType_ext"

```
<ebo:Name>
<xsl:value-of select="xsdLocal1:AlternateAddress" />
</ebo:Name>
```

6. Repeat the same procedure for the UpdateCustomerCRMODReqABCSImpl BPEL process.

[Example 7-7](#) illustrates the contents of the CreateCustomerCRMODABM_To_CreateCustomerPartyEBM_Custom.xsl file after you have completed the mapping:

Example 7-7 CreateCustomerCRMODABM_To_CreateCustomerPartyEBM_Custom.xsl File

```
<xsl:stylesheet version="2.0"
xmlns:customcorecom="http://xmlns.oracle.com/EnterpriseObjects/Core/Custom/Common/V2"
xmlns:corecom="http://xmlns.oracle.com/EnterpriseObjects/Core/Common/V2"
xmlns:ebo="http://xmlns.oracle.com/EnterpriseObjects/Core/EBO/CustomerParty/V2"
xmlns:customebo="http://xmlns.oracle.com/EnterpriseObjects/Core/Custom/EBO/CustomerParty/V2"
xmlns:xsdLocal1="urn:/crmondemand/xml/account">
. . . . . All Other Defined Templates . . . . .
<xsl:template name="CustomerPartyAccount_ext">
<!-- Newly Added Mapping -->
<ebo:Name>
<xsl:value-of select="xsdLocal1:AlternateAddress" />
</ebo:Name>
</xsl:template>
```

7.7 Deploying the BPEL Process After Amending the Custom XSL File

The procedure in this topic describes how to deploy the BPEL process after you amended the related custom XSL file.

To deploy the BPEL process, copy the appropriate BPEL process, for example, the SyncCustomerCRMODProvABCSImpl process, to a temporary folder as follows:

1. Navigate to the <aia.home> directory and run the following command:

```
Source bin/aiaenv.sh
```

2. Go to the appropriate process directory folder on the SOA server by running the following command:

```
cd BPEL Process Name
```
3. Run the following command:

```
(ant -f build.xml)
```
4. Verify that the process was deployed.
5. Restart the SOA server.

Order and Quote Object Definitions

This appendix provides reference information about the Quote and Order objects used with the Oracle Lead to Order Integration Pack for Oracle CRM On Demand and Oracle E-Business Suite PIP.

For more information about CRM On Demand objects, see the *Oracle Web Services On Demand Guide*.

A.1 Quote Object

The Quote object enables you to reference quotes created in Oracle E-Business Suite using the Opportunity-to Quote conversion process provided by the Oracle Lead to Order Integration Pack for Oracle CRM On Demand and Oracle E-Business Suite PIP.

A.1.1 Methods Called

[Table A-1](#) lists the methods called by the Quote service.

Table A-1 Methods called by the Quote Service

Name as Defined in Service
QuoteQueryPage
QuoteUpdate

A.1.2 Fields

[Table A-2](#) details the required and read-only fields for the Quote object.

Table A-2 Required and Read-only Fields for the Quote Object

Field Name	Type
Id	Required The Id field is a system-generated field and cannot be updated.
OpportunityAccountId	Read Only
OpportunityExternalSystemId	Read Only
OpportunityIntegrationId	Read Only
BusinessAccountExternalSystemId	Read Only
BusinessAccountIntegrationId	Read Only
BusinessAccountLocation	Read Only
QuoteCreationStatus	Picklist

[Table A-3](#) details the pick map fields for the Quote object.

Table A-3 Pick Map Fields for the Quote Object

Pick Map Field	Maps To
Owner	OwnerId
OpportunityExternalSystemId	OpportunityId
OpportunityIntegrationId	OpportunityId
BusinessAccountExternalSystemId	BusinessAccountId
BusinessAccountIntegrationId	BusinessAccountId

[Table A-4](#) lists the user key field for the Quote object.

Table A-4 User Key Field for the Quote Object

User Key Field Combinations
QuoteNum

A.2 Order Object

The Order object enables you to reference orders created in Oracle E-Business Suite using the Opportunity-to-Order conversion process provided by the Oracle Lead to Order Integration Pack for Oracle CRM On Demand and Oracle E-Business Suite PIP.

A.2.1 Methods Called

[Table A-5](#) lists the methods called by the Order service.

Table A-5 Methods Called by the Order Service

Name as Defined in Service
OrderQueryPage
OrderUpdate

A.2.2 Fields

[Table A-6](#) details the required and read-only fields for the Order object.

Table A-6 Required and Read-only Fields for the Order Object

Field Name	Type
Id	Required The Id field is a system-generated field and cannot be updated.
OpportunityAccountId	Read Only
OpportunityExternalSystemId	Read Only
OpportunityIntegrationId	Read Only
BusinessAccountExternalSystemId	Read Only
BusinessAccountIntegrationId	Read Only
BusinessAccountLocation	Read Only

Table A-6 (Cont.) Required and Read-only Fields for the Order Object

Field Name	Type
OrderCreationStatus	PickList

[Table A-7](#) details the pick map fields for the Order object.

Table A-7 Pick Map Fields for the Order Object

Pick Map Field	Maps To
Owner	OwnerId
OpportunityExternalSystemId	OpportunityId
OpportunityIntegrationId	OpportunityId
BusinessAccountExternalSystemId	BusinessAccountId
BusinessAccountIntegrationId	BusinessAccountId

[Table A-8](#) lists the user key field for the Order object.

Table A-8 User Key Field for the Order Object

User Key Field Combinations
OrderNum

Attribute Mapping Information

This appendix describes the mapped attributes of customer, product, quote, and order records that are synchronized between Oracle CRM On Demand and Oracle E-Business Suite.

B.1 Customer Data Mappings

Table B-1 lists the mapped attributes of customer records that are synchronized between Oracle E-Business Suite and Oracle CRM On Demand.

Note: The full name of each of the EBOs listed in the EBO column of the following table includes the prefix CreateCustomerPartyEBM/DataArea/CreateCustomerParty. This is not listed in the table.

Table B-1 Mapped attributes of Customer Records

EBO	CRM On Demand	CRM On Demand	Oracle E-Business Suite	
/	Account	Contact	Organization	Org-Contact
PartyLocation/LocationReference/Address/LineOne	Address	/	Address 1	/
PartyLocation/LocationReference/Address/LineTwo	StreetAddress2	/	Address 2	/
PartyLocation/LocationReference/Address/LineThree	StreetAddress3	/	Address 3	
PartyLocation/LocationReference/Address/CityName	City	/	City	
PartyLocation/LocationReference/Address/StateName	StateProvince	/	State	/
PartyLocation/LocationReference/Address/ProvinceName	Province	/	Province	/
PartyLocation/LocationReference/Address/CountryCode	Country	/	Country	/
PartyLocation/LocationReference/Address/PostalCode	ZipCode	/	Postal Code	/
PartyLocation/LocationReference/Address/CountyName	County	/	County	/
PartyContact/Contact/ContactPhoneCommunication/PhoneCommunication/CompleteNumber	MainPhone	/	Telephone	/

Table B-1 (Cont.) Mapped attributes of Customer Records

EBO	CRM On Demand	CRM On Demand	Oracle E-Business Suite
PartyContact/Contact/ContactFaxCommunication/FaxCommunication/CompleteNumber	MainFax	/	Fax /
PartyContact/Contact/ContactWebsiteCommunication/WebsiteCommunication/WebsiteURI	WebSite	/	URL /
PartyContact/Contact/ContactPhoneCommunication/PhoneCommunication/CompleteNumber		HomePhone	Telephone (Purpose: Personal)
PartyContact/Contact/ContactPhoneCommunication/PhoneCommunication/CompleteNumber		WorkPhone	Telephone (Purpose: Business)
PartyContact/Contact/ContactPhoneCommunication/PhoneCommunication/CompleteNumber		CellularPhone	Mobile
PartyContact/Contact/ContactFaxCommunication/FaxCommunication/CompleteNumber		WorkFax	Fax
PartyContact/Contact/ContactEmailCommunication/EmailCommunication/URI		ContactEmail	Email
PartyContact/Contact/JobTitle		JobTitle	JobTitle
PartyContact/Contact/PersonName/FirstName		ContactFirstName	First Name
PartyContact/Contact/PersonName/MiddleName		Middle Name	MiddleName
PartyContact/Contact/PersonName/FamilyName		ContactLastName	Last Name
PartyContact/Contact/PersonName/Salutation		MrMrs	Prefix
Organization/Name	AccountName		Organization
Organization/TotalEmployeeCount	NumberOfEmployees		Organization Total
Organization/PreferredFunctionalCurrencyCode	CurrencyCode		Currency Preference
Organization/OrganizationFinancialStatement/OrganizationFinancialNumber/Amount	AnnualRevenues		Annual Revenue
CustomerPartyAccount/Status/Code	Status		Account Status
CustomerPartyAccount/CustomerPartyAccountSite/CustomerPartyAccountSiteUsage/Usage/UsageCode	Address Description		Purpose Account Site Level

Figure B-1 illustrates the account mapping between Oracle E-Business Suite and CRM On Demand:

Figure B-1 Customer Account Data Mappings

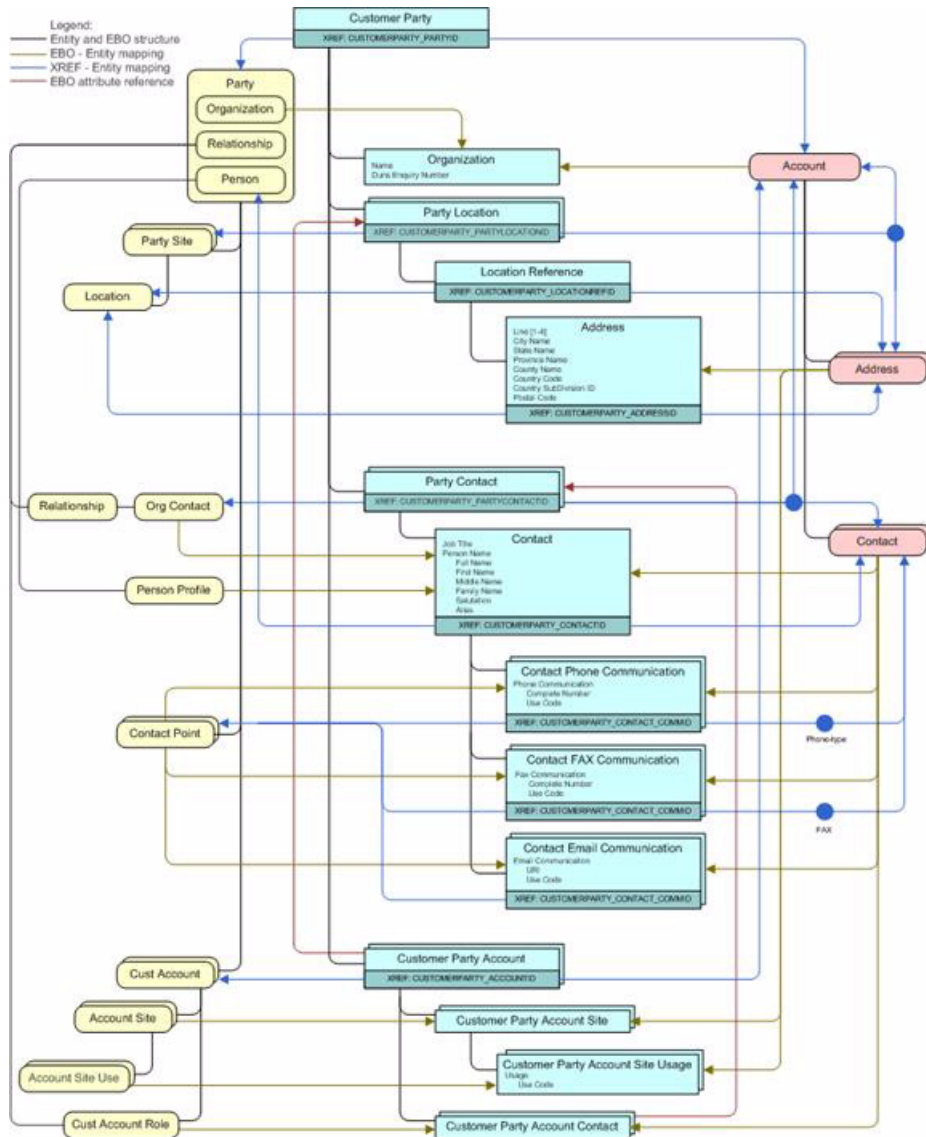

B.2 Product Data Mappings

Table B-2 lists the mapped attributes of product records that are synchronized between Oracle E-Business Suite and Oracle CRM On Demand.

Table B-2 Mapped Attributes of Product Records

EBO	CRM On Demand	Oracle E-Business Suite
ItemEBO/Name	Name	ProductDefinition/ProductName
ItemEBO/Description	Description	ProductDefinition/Description
ItemEBO/TypeCode	Type	ItemType
ItemEBO/Status/Code	Status	InventoryItemStatusCode
ItemEBO/ItemOrderManagementCharacteristics/ SaleableIndicator	Orderable	CustomerOrderFlag
ItemEBO/ItemOrderManagementCharacteristics/ OrderableIndicator	Orderable	CustomerOrderEnabledFlag

B.3 Quote Data Mappings

Table B–3 describes the mapped attributes of quote records that are synchronized between Oracle E-Business Suite and Oracle CRM On Demand.

Table B–3 Mapped Attributes of Quote Records

EBO	CRM On Demand	Oracle E-Business Suite (OM Quote)	Oracle E-Business Suite (CRM Quote)
SalesQuoteEBO/Identification/ BusinessComponentID	QuoteId		
SalesQuoteEBO/Identification/ ApplicationObjectKey/ID	QuoteId	P_HEADER_REC/ ORIG_ SYS_DOCUMENT_REF P_LINE_TBL/P_LINE_TBL_ ITEM/ ORIG_SYS_ DOCUMENT_REF	P_QTE_HEADER_REC/ ORIGINAL_SYSTEM_ REFERENCE
SalesQuoteEBO/Identification/ID	QuoteId		
SalesQuoteEBO/Identification/ Revision/Number			
SalesQuoteEBO/ BusinessUnitReference/ BusinessUnitIdentification/ BusinessComponentID		P_HEADER_REC/ORG_ID	P_QTE_HEADER_REC/ ORG_ID
SalesQuoteEBO/Name	Opportunity Name	P_HEADER_REC/ SALES_ DOCUMENT_NAME	P_QTE_HEADER_REC/ QUOTE_NAME
SalesQuoteEBO/CurrencyCode	CurrencyCode	P_HEADER_REC/ TRANSACTIONAL_CURR_ CODE	P_QTE_HEADER_REC/ CURRENCY_CODE
SalesQuoteEBO/ SalesOpportunityReference/ SalesOpportunityIdentification/ ApplicationObjectKey/ID	OpportunityId	P_HEADER_REC/ ORIG_ SYS_DOCUMENT_REF	P_QTE_HEADER_REC/ ORIGINAL_SYSTEM_ REFERENCE
SalesQuoteEBO/ CustomerPartyReference/ PartyIdentification/ BusinessComponentID	AccountId		P_QTE_HEADER_REC/ PARTY_ID P_QTE_HEADER_REC/ CUST_PARTY_ID
SalesQuoteEBO/ CustomerPartyReference/ CustomerPartyAccountIdentification/ BusinessComponentID	AccountId	P_HEADER_REC/ SOLD_ TO_ORG_ID	P_QTE_HEADER_REC/ CUST_ACCOUNT_ID
SalesQuoteEBO/ CustomerPartyReference/ Contact/Identification/ BusinessComponentID	ContactId		
SalesQuoteEBO/ CustomerPartyReference/Contact/ Identification/AlternateObjectKey/ ID[@schemeID='CUSTOMERPARTY_ PARTYCONTACTID_GUID']	ContactId	P_HEADER_REC/ SOLD_ TO_ORG_CONTACT_ID	P_QTE_HEADER_REC/ ORG_CONTACT_ID
SalesQuoteEBO/ BillToPartyReference/ PartyIdentification/ BusinessComponentID	AccountId	P_HEADER_REC/ INVOICE_TO_PARTY_ID	P_QTE_HEADER_REC/ INVOICE_TO_PARTY_ID
SalesQuoteEBO/ BillToPartyReference/ CustomerPartyAccountIdentification/ BusinessComponentID	AccountId	P_HEADER_REC/ INVOICE_TO_CUSTOMER_ ID	P_QTE_HEADER_REC/ INVOICE_TO_CUST_ ACCOUNT_ID

Table B-3 (Cont.) Mapped Attributes of Quote Records

EBO	CRM On Demand	Oracle E-Business Suite (OM Quote)	Oracle E-Business Suite (CRM Quote)
SalesQuoteEBO/ BillToPartyReference/ LocationReference/ LocationIdentification/ BusinessComponentID	PrimaryBillTo AddressId		
SalesQuoteEBO/ BillToPartyReference/ LocationReference/ LocationIdentification/ AlternateObjectKey/ ID[@schemeID= 'CUSTOMERPARTY_ PARTYLOCATIONID_GUID']	PrimaryBillTo AddressId	P_HEADER_REC/ INVOICE_TO_PARTY_SITE_ ID	P_QTE_HEADER_REC/ INVOICE_TO_PARTY_ SITE_ID
SalesQuoteEBO/ShipToPartyReferenc e/PartyIdentification/BusinessComp onentID	AccountID	P_HEADER_REC/ SHIP_ TO_PARTY_ID	P_HD_SHIPMENT_ REC/SHIP_TO_PARTY_ID
SalesQuoteEBO/ShipToPartyReferenc e/CustomerPartyAccountIdentificatio n/BusinessComponentID	AccountID	P_HEADER_REC/ SHIP_ TO_CUSTOMER_ID	P_HD_SHIPMENT_ REC/SHIP_TO_CUST_ ACCOUNT_ID
SalesQuoteEBO/ShipToPartyReferenc e/LocationReference/LocationIdentifi cation/BusinessComponentID	PrimaryShipTo AddressId		
SalesQuoteEBO/ ShipToPartyReference/ LocationReference/ LocationIdentification/ AlternateObjectKey/ ID[@schemeID= 'CUSTOMERPARTY_ PARTYLOCATIONID_GUID']	PrimaryShipTo AddressId	P_HEADER_REC/ SHIP_ TO_PARTY_SITE_ID	P_HD_SHIPMENT_ REC/SHIP_TO_PARTY_ SITE_ID
SalesQuoteEBO/ SalesPersonPartyReference/ Contact/ ContactEmailCommunication/ EmailCommunication	EMailAddr		P_QTE_HEADER_REC/ RESOURCE_ID
SalesQuoteEBO/SalesQuoteLine	Product	P_LINE_TBL/P_LINE_TBL_ ITEM	P_QTE_LINE_TBL/ P_QTE_ LINE_REC
SalesQuoteEBO/SalesQuoteLine/ Identification/BusinessComponentID	ProductRevenueId		
SalesQuoteEBO/SalesQuoteLine/ Identification/ApplicationObjectKey/ ID	ProductRevenueId	P_LINE_TBL/P_LINE_TBL_ ITEM/ORIG_SYS_LINE_REF	
SalesQuoteEBO/SalesQuoteLine/ Identificaton/ID	ProductPart Number		
SalesQuoteEBO/SalesQuoteLine/ Quantity	Quantity	P_LINE_TBL/P_LINE_TBL_ ITEM/ORDERED_ QUANTITY	P_QTE_LINE_TBL/ P_QTE_ LINE_REC/ QUANTITY
SalesQuoteEBO/SalesQuoteLine/ Quantity/@unitCode		P_LINE_TBL/P_LINE_TBL_ ITEM/ORDER_QUANTITY_ UOM	P_QTE_LINE_TBL/ P_QTE_ LINE_REC/ UOM_CODE
SalesQuoteEBO/SalesQuoteLine/ ProductID	ProductID	P_LINE_TBL/P_LINE_TBL_ ITEM/INVENTORY_ITEM_ ID	P_QTE_LINE_TBL/ P_QTE_ LINE_REC/
ItemReference/ItemIdentification/ BusinessComponentID			INVENTORY_ITEM_ID

B.4 Order Data Mappings

Table B-4 lists the mapped attributes of order records that are synchronized between Oracle E-Business Suite and Oracle CRM On Demand.

Table B-4 Mapped Attributes of Order Records

EBO	CRM On Demand	Oracle E-Business Suite
SalesOrderEBO/Identification/ID	Id	
SalesOrderEBO/Identification/ ApplicationObjectKey/ID	Id	
SalesOrderEBO/Identification/ BusinessComponentID	Id	P_HEADER_REC/ ORIG_SYS_ DOCUMENT_REF P_LINE_TBL/P_LINE_TBL_ITEM/ ORIG_SYS_DOCUMENT_REF
SalesOrderEBO/CurrencyCode	CurrencyCode	P_HEADER_REC/ TRANSACTIONAL_ CURR_CODE
SalesOrderEBO/OrderDateTime	OrderCreationDate	P_HEADER_REC/ORDERED_DATE
SalesOrderEBO/TypeCode	SALESORDER	P_HEADER_VAL_REC/ORDER_TYPE P_HEADER_REC/ORDER_SOURCE_ ID P_HEADER_REC/ TRANSACTION_ PHASE_CODE
SalesOrderEBO/BillToPartyReference/ PartyIdentification/BusinessComponentID	AccountId	
SalesOrderEBO/BillToPartyReference/ PartyIdentification/ApplicationObjectKey/ID	AccountId	
SalesOrderEBO/BillToPartyReference/ CustomerPartyAccountIdentification/ BusinessComponentID	AccountId	
SalesOrderEBO/BillToPartyReference/ CustomerPartyAccountIdentification/ ApplicationObjectKey/ID	AccountId	
SalesOrderEBO/BillToPartyReference/ LocationReference/LocationIdentification/ BusinessComponentID	PrimaryBillToAddressId	
SalesOrderEBO/BillToPartyReference/ LocationReference/LocationIdentification/ ApplicationObjectKey/ID	PrimaryBillToAddressId	
SalesOrderEBO/BillToPartyReference/ LocationReference/Address/Identification/Busi nessComponentID	PrimaryBillToAddressId	
SalesOrderEBO/BillToPartyReference/ LocationReference/LocationIdentification/ AlternateObjectKey/ID	PrimaryBillToAddressId	
SalesOrderEBO/CustomerPartyReference/ PartyIdentification/BusinessComponentID	AccountId	
SalesOrderEBO/CustomerPartyReference/ PartyIdentification/ApplicationObjectKey/ID	AccountId	
SalesOrderEBO/CustomerPartyReference/ CustomerPartyAccountIdentification/ BusinessComponentID	AccountId	P_HEADER_REC/SOLD_TO_ORG_ID
SalesOrderEBO/CustomerPartyReference/ CustomerPartyAccountIdentification/ ApplicationObjectKey/ID	AccountId	
SalesOrderEBO/CustomerPartyReference/ Contact/Identification/BusinessComponentID	KeyContactId	
SalesOrderEBO/CustomerPartyReference/ Contact/Identification/ApplicationObjectKey/ ID	KeyContactId	
SalesOrderEBO/ShipToPartyReference/ PartyIdentification/BusinessComponentID	AccountId	

Table B-4 (Cont.) Mapped Attributes of Order Records

EBO	CRM On Demand	Oracle E-Business Suite
SalesOrderEBO/ShipToPartyReference/ PartyIdentification/ApplicationObjectKey/ID	AccountId	
SalesOrderEBO/ShipToPartyReference/ CustomerPartyAccountIdentification/ BusinessComponentID	AccountId	
SalesOrderEBO/ShipToPartyReference/ CustomerPartyAccountIdentification/ ApplicationObjectKey/ID	AccountId	
SalesOrderEBO/ShipToPartyReference/ LocationReference/LocationIdentification/ BusinessComponentID	PrimaryShipToAddressId	
SalesOrderEBO/ShipToPartyReference/ LocationReference/LocationIdentification/ ApplicationObjectKey/ID	PrimaryShipToAddressId	
SalesOrderEBO/ShipToPartyReference/ LocationReference/Address/Identification/ BusinessComponentID	PrimaryShipToAddressId	
SalesOrderEBO/ShipToPartyReference/ LocationReference/Address/Identification/ ApplicationObjectKey/ID	PrimaryShipToAddressId	
SalesOrderEBO/SourceDocumentReference/ DocumentIdentification/ContextId	OpportunityId	
SalesOrderEBO/SalesOrderLine	For each Opportunity revenue line	P_LINE_TBL/P_LINE_TBL_ITEM P_LINE_VAL_TBL/P_LINE_VAL_TBL_ ITEM
SalesOrderEBO/SalesOrderLine/Identification/ ApplicationObjectKey/ID	ProductRevenueId	
SalesOrderEBO/SalesOrderLine/Identification/ BusinessComponentID	ProductRevenueId	P_LINE_TBL/P_LINE_TBL_ITEM/ ORIG_SYS_LINE_REF
SalesOrderEBO/SalesOrderLine/ OrderQuantity	Quantity	P_LINE_TBL/P_LINE_TBL_ITEM/ ORDERED_QUANTITY
SalesOrderEBO/SalesOrderLine/ ItemReference/ItemIdentification/ BusinessComponentID	ProductId	P_LINE_TBL/P_LINE_TBL_ITEM/ INVENTORY_ITEM_ID
SalesOrderEBO/SalesOrderLine/ ItemReference/ItemIdentification/ ApplicationObjectKey/ID	ProductId	
SalesOrderEBO/SalesOrderLine/ ItemReference/Name	ProductName	
SalesOrderEBO/SalesOrderLine/Status/ Code	OrderStatus	

Settings for Multi-Org Implementation

This appendix describes usage of the multi-org feature and various setups required for its implementation.

Note: Multi-org is implemented in CRM On Demand at the account level only. Usage of the multi-org feature in CRM On Demand is optional.

C.1 Multi-Org Usage at Account Level in CRM On Demand

The section includes the following topics:

- [Section C.1.1, "When Multi-Org is not Implemented in CRM On Demand at Account Level"](#)
- [Section C.1.2, "Use Cases for Multi-Org not Implemented in CRM On Demand at Account Level"](#)
- [Section C.1.3, "When Multi-Org is Implemented in CRM On Demand at Account Level"](#)
- [Section C.1.4, "Use Cases for Multi-Org Implemented in CRM On Demand at Account level"](#)
- [Section C.1.5, "Customization for Multi-Org Implementation in CRM On Demand at Account Level"](#)

C.1.1 When Multi-Org is not Implemented in CRM On Demand at Account Level

If the users do not implement the multi-org functionality, the synchronization flow does not pass any operating unit (OU) between CRM On Demand and Oracle E-Business Suite. The account site in Oracle E-Business Suite uses the default OU set in the AIA Configuration Property.

For more information, see *Oracle Fusion Middleware Concepts and Technologies Guide for Oracle Application Integration Architecture Foundation Pack 11g Release 1*, Defining the Application Context for E-Business Suite Service Calls.

C.1.2 Use Cases for Multi-Org not Implemented in CRM On Demand at Account Level

Example 1: When account is created in CRM On Demand and synched to Oracle E-Business Suite

[Table C-1](#) lists the final representation of the data in Oracle E-Business Suite that is synched from CRM On Demand:

Table C-1 Oracle E-Business Suite Data Synched from CRM On Demand

Account	Account Number	cust_account_site_id	OU#
ABC Ltd	1004	126633	204
ABC Ltd	1004	126644	204
ABC Ltd	1004	202804	204

Note: Default OU setup in the AIA Configuration Property is 204.

During the synchronization from CRM On Demand to Oracle E-Business Suite, the account flow does not pass any OU from CRM On Demand to Oracle E-Business Suite. The Oracle E-Business Suite provider uses the default OU set in the AIA Configuration Property.

Example 2: When account is created in Oracle E-Business Suite and synched to CRM On Demand:

The following is an example of when the users are not implementing the multi-org functionality in CRM On Demand and they have set a non default OU in Oracle E-Business Suite.

Table C-2 lists the data created in Oracle E-Business Suite:

Table C-2 Data Created in Oracle E-Business Suite

Account	Account Number	cust_account_site_id	OU#
Traverse Ltd	2004	11234	103

Note: Default OU setup in the AIA Configuration Property is 204.

Table C-3 lists the data synched to CRM On Demand from Oracle E-Business Suite:

Table C-3 CRM On Demand Data Synched from Oracle E-Business Suite

Account	Account Number	RowID	AddressRowID
Traverse Ltd	QA3456		QA1234

Example 3: When account is updated in CRM On Demand and synched to Oracle E-Business Suite:

Using example 2, when the account is updated in CRM On Demand and synched to Oracle E-Business Suite, the synchronization flow creates a new account site, 11235 in Oracle E-Business Suite, under the default operating unit 204. Both the account sites 11234 and 11235 in Oracle E-Business Suite point to the same physical address.

Table C-4 Account Sites in Oracle E-Business Suite

Account	Account Number	cust_account_site_id	OU#
Traverse Ltd	2004	11234	103
Traverse Ltd	2004	11235	204

C.1.3 When Multi-Org is Implemented in CRM On Demand at Account Level

If the users implement the multi-org functionality:

1. They implement the multi-org functionality in version 2.
2. They have set up multi-org functionality per the implementation guide.

Constraints for the users implementing the multi-org functionality:

1. In Oracle E-Business Suite, multi-org is implemented at the account site (address) level.
2. CRM On Demand allows multi-org representation at the account level only - that is, all addresses for a given account have one OU.
3. CRM On Demand does not allow adding custom field at the account site (address) level.

Note: For a given account, it is not recommended to have different OU at the account site level in Oracle E-Business Suite because CRM On Demand supports OU at the account level only.

C.1.4 Use Cases for Multi-Org Implemented in CRM On Demand at Account level

Example 1: Account created in CRM On Demand and synched to Oracle E-Business Suite

Table C-5 lists the sample data created in CRM On Demand:

Note: In CRM On Demand, OU is at the account level.

Table C-5 Sample Data Created in CRM On Demand

Account	Account Number	Row ID	AddressRow ID	Account OU #
ABC Ltd	QA1004		QA126633	C 82
ABC Ltd	QA 1004		QA 126644	
ABC Ltd	QA 1004		QA 202804	

Table C-6 lists the final data synched to Oracle E-Business Suite from CRM On Demand:

Table C-6 Final Data Synched to Oracle E-Business Suite from CRM On Demand

Account	Account Number	cust_account_site_id	OU #
ABC Ltd	1004	126633	82
ABC Ltd	1004	126644	82
ABC Ltd	1004	202804	82

Note: Default OU set in the AIA Configuration Property is 204.

In this example, account ABC Ltd has three account sites created in Oracle E-Business Suite with the same OU (82) as the one entered in CRM On Demand.

Example 2: Update from CRM On Demand and sync to Oracle E-Business Suite

During update from CRM On Demand, if the user selects a different OU, the account flow passes the new OU and it creates three new account sites in Oracle E-Business Suite for this new OU. All the three new account sites point to the same physical address.

Table C-7 uses the same data set from the example 1 and lists the final data synched to Oracle E-Business Suite as part of the update process:

Table C-7 Final Data Synched to Oracle E-Business Suite during Update Process

Account	Account Number	cust_account_site_id	OU #
ABC Ltd	1004	126633	82
ABC Ltd	1004	126644	82
ABC Ltd	1004	202804	82
ABC Ltd	1004	202807	204
ABC Ltd	1004	202802	204
ABC Ltd	1004	202801	204

Example 3: Account created in Oracle E-Business Suite and synched to CRM On Demand.

Table C-8 lists the data created in Oracle E-Business Suite:

Table C-8 Data Created in Oracle E-Business Suite

Account	Account Number	cust_account_site_id	OU #
ABC Ltd	1004	126633	82
ABC Ltd	1004	126644	82
ABC Ltd	1004	202804	82

When synching to CRM On Demand, the CRM On Demand account web services always use the default OU as defined in CRM On Demand.

Note: In CRM On Demand, OU is at the account level.

Table C-9 lists the final data synched to CRM On Demand from Oracle E-Business Suite:

Table C-9 Final Data Synched to CRM On Demand from Oracle E-Business Suite

Account	Account Number	Row ID	Address_Row ID	Account OU #
ABC Ltd	1004		QA126633	C 204
ABC Ltd	1004		126644	
ABC Ltd	1004		202804	

For more information, see *Oracle Lead to Order Integration Pack for Oracle CRM On Demand and Oracle E-Business Suite Implementation Guide*.

C.1.5 Customization for Multi-Org Implementation in CRM On Demand at Account Level

If the user wants to bring back the OU from Oracle E-Business Suite to CRM On Demand, the user has to customize the CRM On Demand provider flow and Oracle E-Business Suite requester flow to receive the OU from Oracle E-Business Suite and sync it to CRM On Demand, else, the flow creates the account with the default OU.

For more information about how to implement the multi-org feature, see these sections: [Section C.2, "Populating Initial Data for Cross-References"](#), [Section C.3, "Setting Up Domain Value Maps"](#), [Section C.4, "Adding Custom Fields in CRM On Demand"](#), and [Section C.5, "Assigning Sales Rep"](#).

C.2 Populating Initial Data for Cross-References

To populate initial data for cross-references:

You must manually populate the ORGANIZATION_ID and USER_NAME cross-reference table after the install because no process flow exists for this synchronization. Manually add the data into this table using the sql insert statements. The ORGANIZATION_ID table holds the information for business units among the edge applications and the common value.

Sample sql statement (for ORGANIZATION_ID table):

EBIZ_01

```
INSERT INTO XREF_DATA (XREF_TABLE_NAME, XREF_COLUMN_NAME, ROW_
NUMBER, VALUE, IS_DELETED, LAST_MODIFIED) VALUES
(oramds:/apps/AIAMetaData/xref/ORGANIZATION_ID.xref, 'EBIZ_01',
'ROWNUM_ORG_1', '204', 'OPERATIONS', SYSTIMESTAMP)
```

CRM OD_01

```
INSERT INTO XREF_DATA (XREF_TABLE_NAME, XREF_COLUMN_NAME, ROW_
NUMBER, VALUE, IS_DELETED, LAST_MODIFIED) VALUES
(oramds:/apps/AIAMetaData/xref/ORGANIZATION_ID.xref, 'CRM OD_
01', 'ROWNUM_ORG_1', '204', 'N', SYSTIMESTAMP)
```

COMMON

```
INSERT INTO XREF_DATA (XREF_TABLE_NAME, XREF_COLUMN_NAME, ROW_
NUMBER, VALUE, IS_DELETED, LAST_MODIFIED) VALUES
(oramds:/apps/AIAMetaData/xref/ORGANIZATION_ID.xref, 'COMMON',
'ROWNUM_ORG_1', '1001001', 'N', SYSTIMESTAMP)
```

For each set, which includes *EBIZ_01*, *CRM OD_01*, and *COMMON*, the row numbers must be identical to link these records to each other.

For more information on populating cross-references, see the *Oracle Fusion Middleware Developer's Guide for Oracle SOA Suite*, "Working with Cross References".

C.3 Setting Up Domain Value Maps

This setup is required only for multi-org implementation.

1. Using your web browser, log in to the SOA Composer (<http://<machine name>:<soa-infra port>/soa/composer>).
2. Click **Open** and select **Open DVM**.
3. Scroll down to find *ORACLE_RESPONSIBILITY.dvm*. Highlight it and click **Open**.

4. Click **Edit**.
5. Click **Add** to add new DVM rows.
6. Set ORACLE_RESPONSIBILITY.

You must specify a valid responsibility that is assigned privileges to operate in the operating unit, and the responsibility must be assigned to the specified user. The default responsibility is set in the AIA Service configuration file "TransformAppContextEbizService.DefaultResponsibility" property for the service name "TransformAppcontextEbizService"

7. Insert rows for:

- a. EBIZ_USER_OU

Enter the user name and organization ID in a format such as USER_NAME:ORGANIZATION_ID. (Example: OPERATIONS:204)

- b. EBIZ_RESP

Enter the responsibility to be used for the user and organization specified. (Example: EBIZ_RESP - Order Management Super User, Vision Operations (USA))

- c. Setting ORDER_TYPE

This must be set up if you are implementing the Opportunity to OM order flow. The ORDER_TYPE DVM must have EBS order type ID for each operating unit set in the ORGANIZATION_ID cross-reference.

8. To find the EBS ORDER_TYPE ID:

- a. Log in to Oracle E-Business Suite.
- b. Select the "Order Management Super User <OU>" responsibility for the operating unit.
- c. Click **Assign** under **Setup: Transaction Types**.
- d. Find the transaction type <Transaction Type> for the operating unit for which you want the orders to be created. The integration supports only one transaction type for all the orders created through the integration.
- e. Connect to the Oracle E-Business Suite DB and run the following query:

```
select ta.transaction_type_id
from oe_transaction_types_all ta, oe_transaction_types_t1 t1
where ta.transaction_type_id = t1.transaction_type_id and t1.language =
'US'
and t1.name like '<Transaction Type> ' and ta.org_id = <ORGANIZATION_ID>
```

9. Insert rows in ORDER_TYPE.dvm:

- a. COMMON

Insert one for each operating unit. It can be any desired value if it is unique for each operating unit.

- b. EBIZ_01

Insert one for each EBS operating unit.

- c. CRM OD_01

Insert one each for the operating unit that can be entered in CRM On Demand, concatenated with '::SALESORDER'. For example, 204 is an operating unit that

can be entered in the CRM On Demand Account Details UI. So the value entered here should be: `204::SALESORDER`.

10. Set QUOTE_TYPE

This must be set up if you are implementing the opportunity to OM Quote Flow. The QUOTE_TYPE DVM must have EBS quote type ID for each operating unit set in the ORGANIZATION_ID cross-reference. The CRM quote takes the quote type from the EBS profile option **ASO: Default Order Type**. This should be set at the correct responsibility level.

11. To find the EBS ORDER_TYPE ID:

- a. Log in to Oracle E-Business Suite.
- b. Select the "Order Management Super User <OU>" responsibility for the operating unit.
- c. Click **Assign** under **Setup: Transaction Types**.
- d. Find the transaction type *<Transaction Type>* for the operating unit for which you want the orders to be created. The integration supports only one transaction type for all the orders created through the integration.
- e. Connect to the Oracle E-Business Suite DB and run the following query:

```
select ta.transaction_type_id
from oe_transaction_types_all ta, oe_transaction_types_tl t1
where ta.transaction_type_id = t1.transaction_type_id and t1.language =
'US'
and t1.name like '<Transaction Type> ' and ta.org_id = =<ORGANIZATION_ID>
```

12. Insert rows in QUOTE_TYPE.dvm:

a. COMMON

Insert one for each operating unit. It can be any desired value if it is unique for each operating unit.

b. EBIZ_01

Insert one for each EBS operating unit

c. CRM OD_01

Insert one each for the operating unit that can be entered in CRM On Demand, concatenated with '::QUOTE'. For example, `204` is an operating unit that can be entered in the CRM On Demand Account Details UI. So the value entered here should be `204::QUOTE`.

C.4 Adding Custom Fields in CRM On Demand

This custom field is for multi-org implementation only.

To add operating units in the Account fields:

1. Log in to CRM On Demand.
2. Navigate to **Admin, Application Customization**.
3. Select the Account object.
4. Select **Account Field Setup** and click **New Field**.
 - a. Enter Operating Unit for the display name.

Additional Business Event Subscription Setup for Product Sync Events

In Oracle E-Business Suite, items are created in the Master Organization, and assigned to Inventory Organizations from the Item Master Org. In the delivered Process Integration Pack (PIP), default subscriptions are created for two events raised for item create and update: `oracle.apps.ego.item.postItemUpdate`, and `oracle.apps.ego.item.postItemCreate`. These subscriptions trigger the item sync flow for every item created or updated in any inventory organization. The integration flows propagate the item create and update to CRM On Demand, if the inventory organization is mapped in the `INVENTORY_LOCATIONS XREF` table.

It is recommended to optimize the default subscriptions to only trigger the item create and update flows for the subset of inventory organizations relevant for order processing in the PIP. This is the set of item validation organizations.

D.1 Setting Up Subscription

By default, the subscription for the `oracle.apps.ego.item.postItemUpdate` and `oracle.apps.ego.item.postItemCreate` events is processed by the PLSQL function `aia_custom_subscription_pkg.aia_item_subscription`. This package is created in Oracle E-Business Suite at the time of the PIP deployment.

In addition, a PLSQL package called `aia_item_subscript_params_pkg` is applied to specify the parameters used in the PLSQL package subscription. The default source for this package is available in the following file: `"$AIA_HOME/services/core/Ebiz/AdapterServices/CreateItemEbizEventConsumer/aia_item_subscription_params_pkg.sql"`

The following three variables must be modified as follows:

- `g_validate_subscription`
Values for this should be Y or N.
 - N (default): This value implements the delivered behavior. That is, subscription triggers the item sync flow for every item created or updated in any inventory organization
 - Y: This value triggers the item sync flow for item created or updated in the master or item validation orgs specified in the `g_master_organization_id` and `g_itemValidationOrgs` variables.
- `g_master_organization_id`
Set to the ID of the item master org. Example: `g_master_organization_id Number:=204`.

- `g_itemValidationOrgs`

Set to list of Ids of Item Validation Orgs. This list should include all the organizations from the INVENTORY_LOCATIONS XREF table Example: `g_itemValidationOrgs NumberList:= NumberList(204,911)`.

- When setup is completed, item creates and updates are synced for organizations listed in `g_itemValidationOrgs` (204 and 911).

After making these changes, recompile the `aia_item_subscript_params_pkg` package against the Oracle E-Business Suite database (Apps Schema).