

# StorageTek LibraryStation

---

## Configuration and Administration Guide

Version 7.2

**ORACLE**

Part Number: E37805-01  
October 2012

Submit comments about this document to [STP\\_FEEDBACK\\_US@ORACLE.COM](mailto:STP_FEEDBACK_US@ORACLE.COM).

Oracle welcomes your comments and suggestions for improving this book. Contact us at [STP\\_FEEDBACK\\_US@ORACLE.COM](mailto:STP_FEEDBACK_US@ORACLE.COM). Please include the title, part number, issue date, and revision.

Copyright © 2012, Oracle and/or its affiliates. All rights reserved.

This software and related documentation are provided under a license agreement containing restrictions on use and disclosure and are protected by intellectual property laws. Except as expressly permitted in your license agreement or allowed by law, you may not use, copy, reproduce, translate, broadcast, modify, license, transmit, distribute, exhibit, perform, publish, or display any part, in any form, or by any means. Reverse engineering, disassembly, or decompilation of this software, unless required by law for interoperability, is prohibited.

The information contained herein is subject to change without notice and is not warranted to be error-free. If you find any errors, please report them to us in writing.

If this is software or related software documentation that is delivered to the U.S. Government or anyone licensing it on behalf of the U.S. Government, the following notice is applicable:

U.S. GOVERNMENT RIGHTS Programs, software, databases, and related documentation and technical data delivered to U.S. Government customers are "commercial computer software" or "commercial technical data" pursuant to the applicable Federal Acquisition Regulation and agency-specific supplemental regulations. As such, the use, duplication, disclosure, modification, and adaptation shall be subject to the restrictions and license terms set forth in the applicable Government contract, and, to the extent applicable by the terms of the Government contract, the additional rights set forth in FAR 52.227-19, Commercial Computer Software License (December 2007). Oracle USA, Inc., 500 Oracle Parkway, Redwood City, CA 94065.

This software or hardware is developed for general use in a variety of information management applications. It is not developed or intended for use in any inherently dangerous applications, including applications which may create a risk of personal injury. If you use this software or hardware in dangerous applications, then you shall be responsible to take all appropriate fail-safe, backup, redundancy, and other measures to ensure the safe use. Oracle Corporation and its affiliates disclaim any liability for any damages caused by use of this software or hardware in dangerous applications.

Oracle is a registered trademark of Oracle Corporation and/or its affiliates. Oracle and Java are registered trademarks of Oracle and/or its affiliates. Other names may be trademarks of their respective owners.

AMD, Opteron, the AMD logo, and the AMD Opteron logo are trademarks or registered trademarks of Advanced Micro Devices. Intel and Intel Xeon are trademarks or registered trademarks of Intel Corporation. All SPARC trademarks are used under license and are trademarks or registered trademarks of SPARC International, Inc. UNIX is a registered trademark licensed through X/Open Company, Ltd.

This software or hardware and documentation may provide access to or information on content, products, and services from third parties. Oracle Corporation and its affiliates are not responsible for and expressly disclaim all warranties of any kind with respect to third-party content, products, and services. Oracle Corporation and its affiliates will not be responsible for any loss, costs, or damages incurred due to your access to or use of third-party content, products, or services.

# Contents

---

## **Preface 11**

Access to Oracle Support 11

Related Documentation 12

Conventions for Reader Usability 13

    Typographic 13

    Syntax Flow Diagrams 13

    Flow Lines 13

    Single Required Choice 13

    Single Optional Choice 14

    Defaults 14

    Repeat Symbol 14

    Control Statements 17

## **1. Introduction 19**

    What is LibraryStation? 19

    How Does LibraryStation Work? 20

        Request Processing 21

## **2. Configuration 23**

    Overview 23

    Typical LibraryStation Configurations 24

        LibraryStation Client/Server Environment 27

        System Redundancy Options 28

    Verifying Software and Hardware Requirements 29

        Software Requirements 29

Hardware Requirements	30
Configuring Communication Facilities	31
ONC/RPC Support	31
LU6.2 Support	32
Configuring Security Measures	36
Drive Access Security	36
Volume Access Security	36
Allocating the Persistent Data File	50
The PDF in a Multiple Host Environment	51
Configuring the LibraryStation Hostid	52
Configuring Drive Device Numbers	54
Configuring the LSINIT Control Statement	59
LSINIT Control Statement Format	59
Required Keyword Parameters of LSINIT	63
Optional Keyword Parameters of LSINIT	64
LSINIT Implications for Multiple MVS Host Installations	69
Configuring the LSDEF Data Set	70
Defining LSDEF File Statements	70
CLIENTID Statement	71
SPNUM Statement	72
VIRTACS Statement	74
Allocating the LSDEF Data Set	75
Configuring the HSC Started Task Procedure	76
Reconfiguring the HSC LIBGEN	78
Verifying LibraryStation Configuration	79
Step 1: CPA, TCP/IP, and LAN Verification	79
Step 2: LibraryStation Verification	79
<b>3. Commands</b>	<b>81</b>
Overview	81
Relationship to HSC Commands	82
LibraryStation Command Summary	83
Online Help for LibraryStation Commands	84
Operating States	84

Command Descriptions 85

Activate Standby 85

Cancel 86

CLrlock 87

Display CMd 89

Display DRive 90

Display Request 93

Display Status 95

Idle 96

INit 98

SEt 100

Start 102

STOp 103

Trace 105

Vary DRive 110

**4. Administration and Maintenance 113**

System Administration 113

Making Additional Tape Cartridge Drives Available to LibraryStation 114

Making Existing Tape Cartridge Drives Unavailable to LibraryStation 115

Modifying LibraryStation Operating Characteristics 116

LibraryStation Diagnostic Tools 117

Logging 117

Tracing 118

SLGDIAG Installation Verification Program 119

Network Diagnostic Tools 124

LibraryStation Failure Recovery 124

Persistent Data File (PDF) Failure Recovery 125

Cross Host Recovery 128

**5. Starting and Stopping LibraryStation 129**

Starting LibraryStation 129

Stopping LibraryStation 130

<b>6. Messages and Codes</b>	<b>131</b>
Overview	131
Message Format	132
Message Descriptions	132
Variable Definitions	133
Message Listing	134
Abend Reason Codes	183
System Return Codes	183
Remote Procedure Call (RPC) Messages	186
<b>A. Configuration Worksheet</b>	<b>189</b>
<b>B. Migration and Coexistence</b>	<b>195</b>
Migration	195
Coexistence	195
<b>C. Gathering Diagnostic Materials</b>	<b>197</b>
LibraryStation Diagnostic Materials	197
Tape Format	197
<b>Index</b>	<b>215</b>

# Figures

---

FIGURE 1-1	Flow of Requests and Responses through LibraryStation	22
FIGURE 2-1	Typical LibraryStation Configuration for ONC/RPC Clients	25
FIGURE 2-2	Typical LibraryStation Configuration for LU6.2 Clients	26
FIGURE 2-3	LibraryStation Client/Server Environment	27
FIGURE 2-4	Sample VTAM Setup APPL Statement	33
FIGURE 2-5	Sample APPC Side Information File - Part 1	34
FIGURE 2-6	Sample APPC Side Information File - Part 2	35
FIGURE 2-7	Sample SLILIBRY Macro with LibraryStation Hostid	52
FIGURE 2-8	Sample LIBGEN with LibraryStation Device Numbers	56
FIGURE 2-9	LSINIT Control Statement Syntax	62
FIGURE 2-10	CLIENTID LSDEF Statement Syntax	71
FIGURE 2-11	SPNUM LSDEF Statement Syntax	72
FIGURE 2-12	VIRTACS LSDEF Statement Syntax	74
FIGURE 2-13	Sample LSDEF Data Set Allocation	75
FIGURE 2-14	Sample HSC Cataloged Procedure Updated for LibraryStation	76
FIGURE 3-1	Activate Standby Command Syntax	85
FIGURE 3-2	Cancel Command Syntax	86
FIGURE 3-3	CLrlock Command Syntax	87
FIGURE 3-4	Display CMd Syntax	89
FIGURE 3-5	Display DRive Command Syntax	90
FIGURE 3-6	Display Request Command Syntax	93
FIGURE 3-7	Display Status Command Syntax	95
FIGURE 3-8	Idle Command Syntax	96
FIGURE 3-9	INit Command Syntax	98
FIGURE 3-10	SEt Command Syntax	100

FIGURE 3-11	Start Command Syntax	102
FIGURE 3-12	STOp Command Syntax	103
FIGURE 3-13	Trace Command Syntax	105
FIGURE 3-14	Vary DRive Command Syntax	110
FIGURE 4-1	Sample SYSLOG Output	117
FIGURE 4-2	JCL for SLGDIAG Installation Verification Program	120
FIGURE 4-3	JCL for Rebuilding PDF Indexes	126
FIGURE 4-4	JCL for Redefining the PDF	127



# Tables

---

TABLE 2-1	Command to Application Name Cross Reference	46
TABLE 2-2	LSINIT Keyword Parameters	60
TABLE 3-1	LibraryStation Operator Command Summary	83
TABLE 6-1	Variable Data Definitions	133
TABLE 6-2	Abend Reason Codes	183
TABLE 6-3	System Return Codes	183



# Preface

---

This publication provides configuration and administration information for Oracle's StorageTek LibraryStation software. It is intended for storage administrators, system programmers and operators responsible for configuring and maintaining LibraryStation.

---

## Access to Oracle Support

Oracle customers have access to electronic support through My Oracle Support:

<http://www.oracle.com/support/contact.html>

<http://www.oracle.com/accessibility/support.html> (for hearing impaired)

---

## Related Documentation

### StorageTek Enterprise Library Software (ELS)

- *Introducing ELS*
- *Installing ELS*
- *ELS Command, Control Statement, and Utility Reference*
- *ELS Syntax Quick Reference*
- *ELS Messages and Codes*
- *ELS Programming Reference*
- *ELS Legacy Interfaces Reference*
- *Configuring HSC and VTCS*
- *Managing HSC and VTCS*
- *Configuring and Managing SMC*
- *ELS Disaster Recovery and Offsite Data Management Guide*

### StorageTek LibraryStation

- *LibraryStation Syntax Quick Reference*

### Oracle's StorageTek Removable Media Library Software (RMLS/CSC)

- *RMLS/CSC User's Guide*

### IBM JES3

- *z/OS JES3 Initialization and Tuning Reference*

---

# Conventions for Reader Usability

## Typographic

Some JCL examples in this guide include *italic* type. Italic type is used to indicate a variable. You must substitute an actual value for these variables.

The use of mixed upper and lower case characters for commands, control statements, and parameters indicates that lower case letters may be omitted to form abbreviations. For example, you may simply enter POL when executing the POLicy command.

## Syntax Flow Diagrams

Syntax flow diagramming conventions include the following:

### Flow Lines

Syntax diagrams consist of a horizontal base line, horizontal and vertical branch lines, and the text for a command, control statement, macro, or utility. Diagrams are read left to right, and top to bottom. Arrows indicate flow and direction.

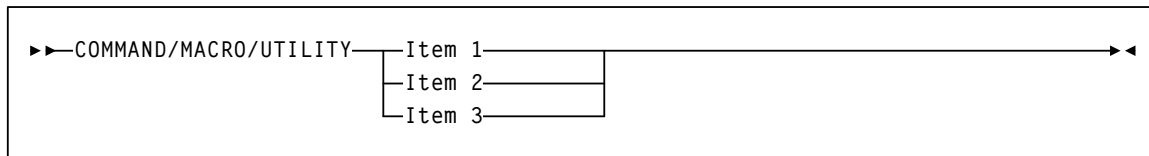

### Single Required Choice

Branch lines (without repeat arrows) indicate that a single choice must be made. If one of the items to choose from is positioned on the baseline of the diagram, one item must be selected.

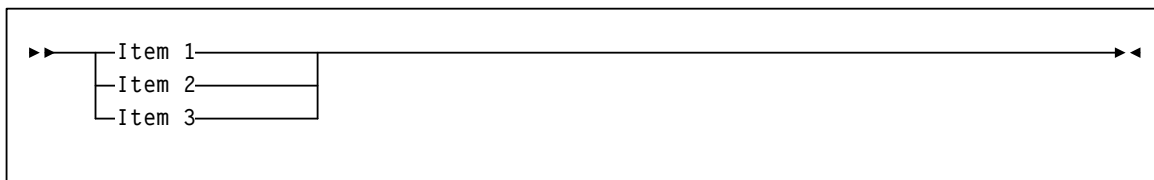

## Single Optional Choice

If the first item is positioned on the line below the baseline, one item may be optionally selected.

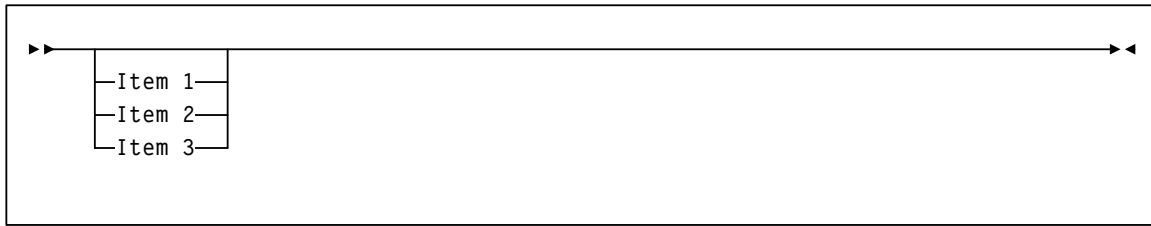

## Defaults

Default values and parameters appear above the baseline.

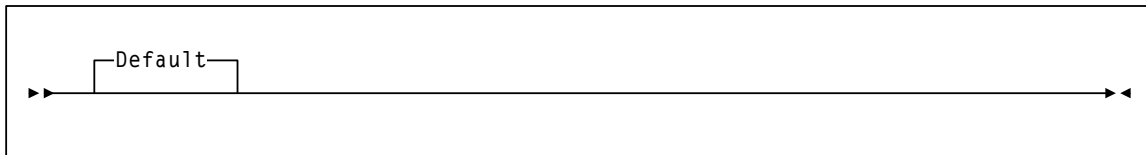

Some keyword parameters provide a choice of values in a stack. When the stack contains a default value, the keyword and the value choices are placed below the baseline to indicate that they are optional, and the default value appears above the keyword line.

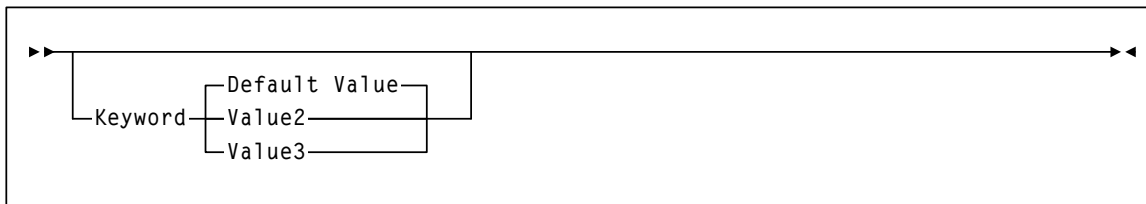

## Repeat Symbol

A repeat symbol indicates that more than one choice can be made or that a single choice can be made more than once. The following example indicates that a comma is required as the repeat delimiter.

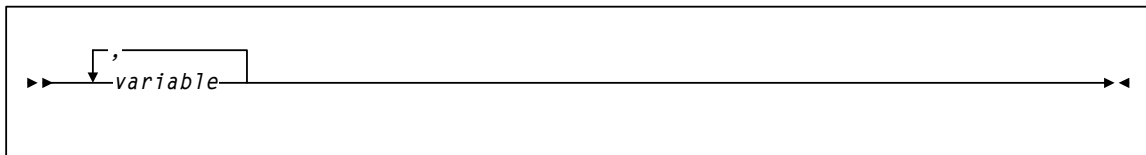

## Keywords

All command keywords are shown in all upper case or in mixed case. When commands are not case sensitive, mixed case implies that the lowercase letters may be omitted to form an abbreviation.

## Variables

Italic type is used to indicate a variable.

## Alternatives

A bar ( | ) is used to separate alternative parameter values.

## Optional

Brackets [ ] are used to indicate that a command parameter is optional.

## Delimiters

If a comma (,), a semicolon (;), or other delimiter is shown with an element of the syntax diagram, it must be entered as part of the statement.

## Ranges

An inclusive range is indicated by a pair of elements of the same length and data type, joined by a dash. The first element must be strictly less than the second element.

A hexadecimal range consists of a pair of hexadecimal numbers (for example, 0A2-0AD, or 000-0FC).

A decimal range consists of a pair of decimal numbers (i.e., 1-9, or 010-094). Leading zeros are not required. The decimal portion is referred to as an incremental range. The character positions of the incremental portion of both range elements must match, and the non incremental characters of the first element must be identical to those of the second element.

A numeric VOLSER range (*vol-range*) consists of a pair of VOLSER elements containing a decimal numeric portion of 1 to 6 digits (for example, ABC012-ABC025, or X123CB-X277CB). The decimal portion is referred to as an incremental range. The following additional restrictions apply:

- The character positions of the incremental portion of both range elements must match.
- The non incremental characters of the first element must be identical to those of the second element.
- You cannot increment two portions of a range element. If 111AAA is the first element, you cannot specify 112AAB for the second element.

- If a VOLSER range contains more than one decimal portion, any portion is valid as the incremental range. For example:

A00B00                    the largest range that can be specified is A00B00 through A99B99.  
A0B0CC                    the largest range that can be specified is A0B0CC through A9B9CC.  
000XXX                    the largest range that can be specified is 000XXX through 999XXX.

An alphabetic VOLSER range (*vol-range*) consists of a pair of VOLSER elements containing an incremental portion of 1 to 6 characters (for example, 000AAA-000ZZZ, or 9AAA55-9ZZZ55). This portion is referred to as an incremental range. The following additional restrictions apply:

- The character positions of the incremental portion of both range elements must match.
- The non incremental characters of the first element must be identical to those of the second element.
- You cannot increment two portions of a range element. If 111AAA is the first element, you cannot specify 112AAB for the second element.
- The alphabetic portion of the VOLSER range is defined as being from character A to Z. To increment multi-character sequences, each character increments to Z. For instance, ACZ is part of the AAA-AMM range. Examples are:

A00A0-A99A0                    increments VOLSERs A00A0 through A09A0, then A10A0 through A99A0.  
9AA9A-9ZZ9A                    increments VOLSERs 9AA9A through 9AZ9A, then 9BA9A through 9ZZ9A.  
111AAA-111ZZZ                    increments VOLSERs 111AAA through 111AAZ, then 111ABA through 111ZZZ  
999AM8-999CM8                    increments VOLSERs 999AM8 through 999AZ8, then 999BA8 through 999CM8  
A3BZZ9-A3CDE9                    increments VOLSERs A3BZZ9 through A3CAA9, then A3CAB9 through A3CDE9  
AAAAAA-AAACCC                    increments VOLSERs AAAAAA through AAAAAZ, then AAAABA through AAACCC  
CCNNN-DDDNNN                    increments VOLSERs CCNNN through CCCNNZ, then CCCNOA through DDDNNN \*

\* **Caution:** This is a very large range.



The number of volumes in an alphabetic VOLSER range depends on the number of elements in the incrementing portion of the VOLSER range. For an A to Z range in each character position, the number of volumes can be calculated by 26 to the power of the number of positions that are being incremented.

A-Z	$26^1$	26
AA-ZZ	$26^2$	676
AAA-ZZZ	$26^3$	17,576
AAAA-ZZZZ	$26^4$	456,976
AAAAA-ZZZZZ	$26^5$	11,881,376
AAAAAA-ZZZZZZ	$26^6$	308,915,776

## Lists

A list consists of one or more elements. If more than one element is specified, the elements must be separated by a comma or a blank space, and the entire list must be enclosed in parentheses.

## Blanks

Keyword parameters and values may be separated by any number of blanks.

## Control Statements

The standard syntax conventions for control statements are as follows:

- The only valid control statement information area is from column 1 to column 72. Columns 73-80 are ignored.
- Parameters may be separated by one or more blanks or a comma.
- A value is associated with a parameter by an equal (=) sign or by enclosing the value in parentheses, and concatenating it immediately after the parameter.
- Case (upper or lower) is ignored in actual control statements.
- Continuations are supported by including a plus (+) sign at the end of the line to be continued. A control statement is terminated if the statement is not continued.
- /\* and \*/ can be used to enclose comments in the job stream. HSC PARMLIB members and definition data sets must specify comments in this format.
  - A comment is not required as the first control statement of any PARMLIB member.
  - Comments can be continued over multiple lines, but cannot be nested.
  - The maximum length for any control statement is 1024 characters.



# Introduction

---

---

## What is LibraryStation?

LibraryStation provides a communications interface between HSC and one or more open systems clients running on different hosts.

LibraryStation allows these network clients to access the library services of a StorageTek Nearline Automated Cartridge System (ACS) through the MVS host system. LibraryStation executes in the HSC address space on MVS.

---

**Note** – LibraryStation 7.2 does **not** support Oracle's StorageTek Client System Component (MVS/CSC) clients. StorageTek SMC software, along with its integrated HTTP server, provides communication between MVS hosts in an MVS-only environment. Refer to the publication *Configuring and Managing SMC* for more information.

---

LibraryStation provides software support and an interface for the Open Systems Nearline Network protocol. This includes an Open Network Computing Remote Procedure Call (ONC/RPC) client and a System Network Architecture (SNA LU6.2) client. This protocol defines valid requests from network client systems and corresponds to an application layer protocol of the International Standards Organization (ISO) Open Systems Interconnection (OSI) reference model.

Additionally, LibraryStation provides an operator command set that allows you to control LibraryStation operation through the HSC operator console.

## How Does LibraryStation Work?

LibraryStation acts as a control path interface between client systems and HSC. Client systems use two methods to communicate with LibraryStation:

- For ONC/RPC clients, Open Systems Nearline Network protocol requests and corresponding replies are processed by the Client System Interface (CSI).
- For SNA LU6.2 clients, Open Systems Nearline Network protocol requests and corresponding replies are processed by the Client Server Communications Interface (CSCI).

A hardware and software connection between the MVS system and network is required:

- For ONC/RPC clients:
  - The hardware connection is provided by a network interface adaptor that converts data on the Ethernet network to IBM channel commands. Depending on the TCP/IP communication product you choose, several types of network interface adapters may be used for a connection to an Ethernet network. Consult your TCP/IP vendor for a list of supported network adapters.
  - The software connection is provided by one of various TCP/IP communication products including IBM TCP/IP and CA Insinuator TCPaccess Communications Server. These products translate the data to a format that is understood by MVS applications such as LibraryStation.
- For SNA LU6.2 clients:
  - The hardware necessary to provide network connectivity between the client system and LibraryStation is not provided by Oracle. Typical configurations use an IBM 3172 or IBM 3174 Interconnect Controller to connect to a token ring network where the client system is also attached. It is also possible to use channel-to-channel connections where the client resides on another MVS system.
  - The software connection is provided by APPC/MVS and VTAM. APPC/MVS provides a programming interface to LibraryStation while VTAM controls the physical hardware.

When a client system makes a library services request, such as a mount or dismount request, LibraryStation translates the request into a format that the HSC understands. The HSC in turn delivers the request to the Library Management Unit (LMU) through the use of an establishment controller (an IBM 3174, for example) just as if the request had originated from the HSC.

When the HSC needs to respond to the originator, LibraryStation translates the response from the HSC format to the format expected by the client system. After a cartridge is mounted using this control path sequence, the client system can begin moving data to or from a cartridge drive that is attached to the library and connected directly to the client system. This separate data path uses a channel that is supported by the client; an ESCON, FIPS-60 "Bus and Tag," or SCSI channel.

## Request Processing

The flow of requests and responses between the network client system and the Library Management Unit (LMU) of the ACS is described below. Communications occur through a control path from the client system, through the HSC host to the LMU and back. [FIGURE 1-1 on page 22](#) illustrates the flow of requests and responses. ONC/RPC clients are used in this example.

1. The client system initiates communication with the MVS host by sending an Open Systems Nearline Network (OSNN) protocol request over the network to the network interface adaptor (for example, the StorageTek™ 9300-001 Control Path Adaptor). This request could specify actions such as a tape volume mount or a query for information.
2. The network interface adaptor passes the packet through the IBM channel to the communication subsystem software on the MVS host, IBM TCP/IP for example.
3. The communication subsystem manages multiple communications connections and directs the communications packet to LibraryStation.
4. LibraryStation interprets the packet's information and protocols. LibraryStation may pass the request to the HSC for further processing and delivery to the LMU, or it may process the request directly.
5. The LMU initiates library operation, including robotic activity.
6. The LMU sends its response to the HSC for further processing and delivery to LibraryStation.
7. LibraryStation interprets the message information and protocols and passes the response to the Communications subsystem.
8. The Communications subsystem provides additional communications information required for the response to be received by the network client and sends the message to the network interface adaptor.
9. The network interface adaptor passes the packet back to the client system through the network (Ethernet, Token Ring, etc.)
10. The client system receives the response message from LibraryStation.
11. Data transfers between the client system and the ACS occur through separate ESCON, FIPS-60 "Bus and Tag" or SCSI data paths.

How Does LibraryStation Work?

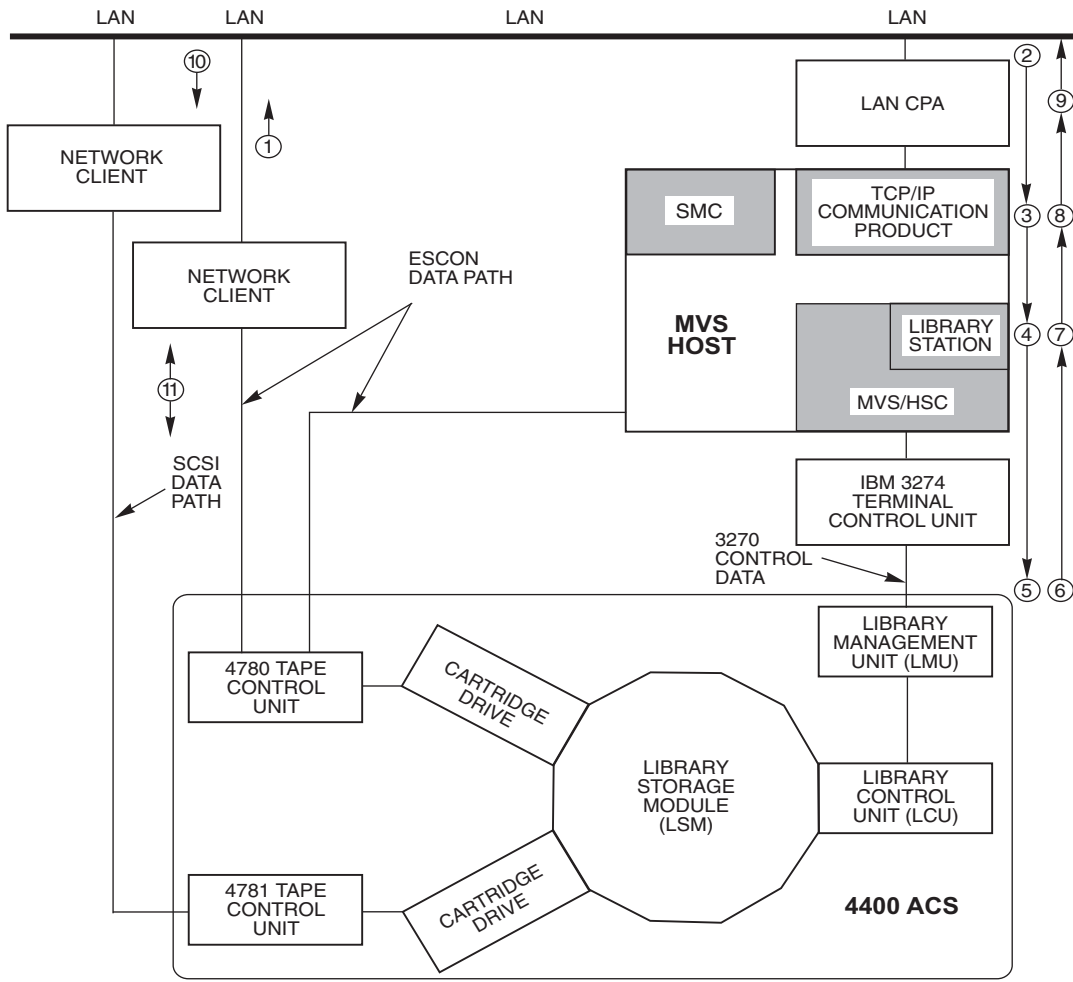

C46255

FIGURE 1-1 Flow of Requests and Responses through LibraryStation

# Configuration

---

---

## Overview

LibraryStation must be installed prior to performing LibraryStation configuration tasks. LibraryStation software is installed from the StorageTek Enterprise Library Software (ELS) installation tape onto the MVS host system using the IBM SMP/E utility. Refer to the publication *Installing ELS for LibraryStation* installation instructions.

Once LibraryStation installation is complete, you must perform the following configuration tasks described in this chapter:

- [Verifying Software and Hardware Requirements](#)
- [Configuring Communication Facilities](#)
- [Configuring Security Measures](#)
- [Allocating the Persistent Data File](#)
- [Configuring the LibraryStation Hostid](#)
- [Configuring Drive Device Numbers](#)
- [Configuring the LSINIT Control Statement](#)
- [Configuring the LSDEF Data Set](#)
- [Configuring the HSC Started Task Procedure](#)
- [Reconfiguring the HSC LIBGEN](#)
- [Starting LibraryStation](#)
- [Verifying LibraryStation Configuration](#)

A configuration worksheet is included in [Appendix A](#). As you complete configuration tasks, record site-specific information on this worksheet.

## Typical LibraryStation Configurations

LibraryStation provides the following capabilities that are not found in a normal HSC configuration without LibraryStation:

- The HSC system serves as a conduit for control path communication between network client systems and the ACS system.
- The data path between the Nearline ACS and network client system is independent of the HSC system. Depending on the control unit, the data path can be ESCON, FIPS-60 "Bus and Tag" or SCSI.

LibraryStation functions are made possible with the addition of hardware and software elements that are not present in the normal HSC configuration:

- An open systems network client system.
- LibraryStation software for protocol support between the network client system and the HSC host system.
- TCP/IP communications software for ONC/RPC support, APPC/MVS and VTAM for SNA LU6.2 support.
- For ONC/RPC support, a network interface adaptor that provides an IBM channel connection to an Ethernet local area network (LAN). Depending on the TCP/IP communication product you choose, various network interface adapters can be used for this connection. Consult your TCP/IP vendor for a list of supported network adapters.
- For LU6.2 support, many hardware configurations can be used. Typical configurations use an IBM 3172 or 3174 establishment controller to connect to a token ring network.

Typical LibraryStation configurations are illustrated on the following pages.



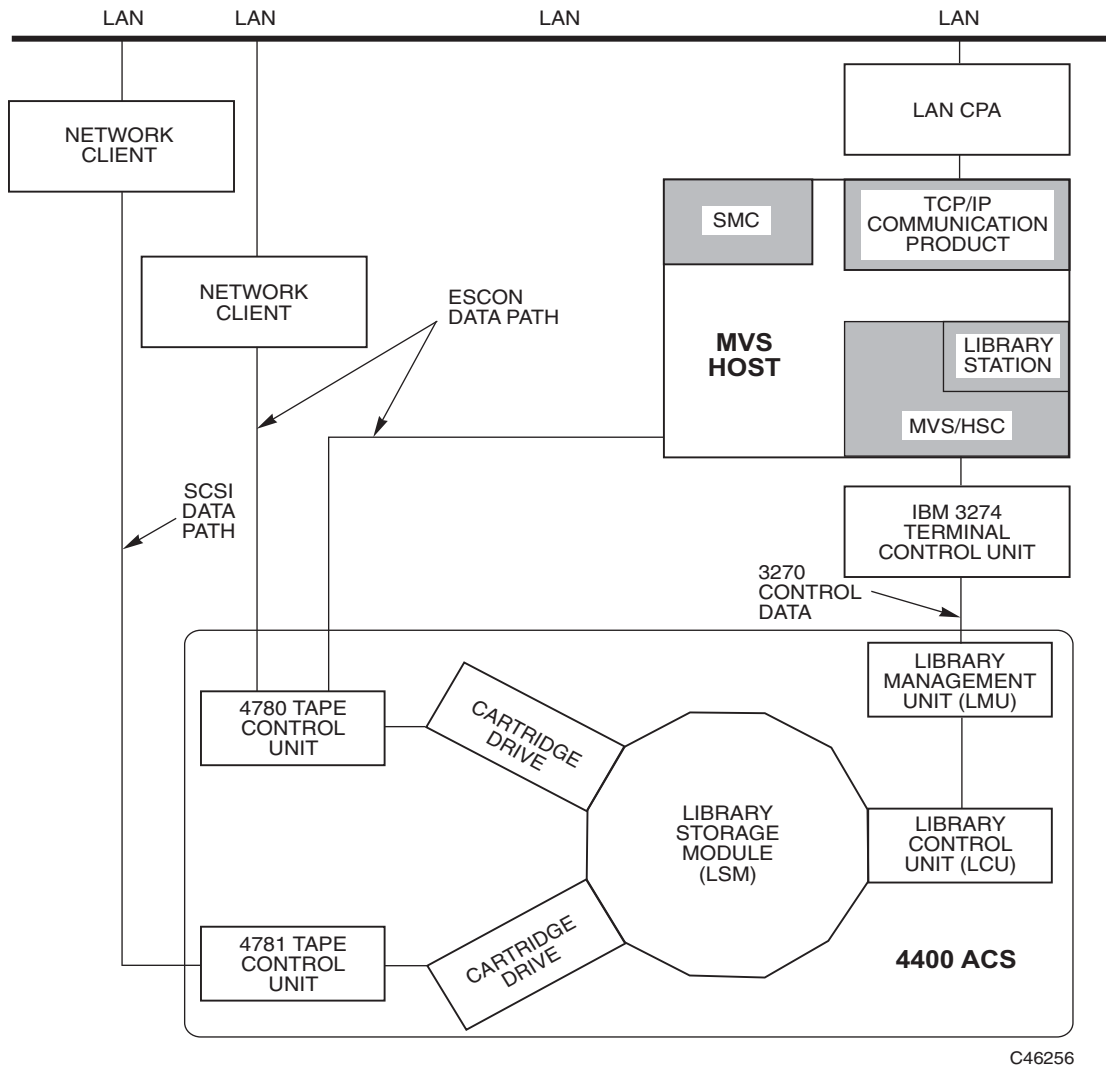
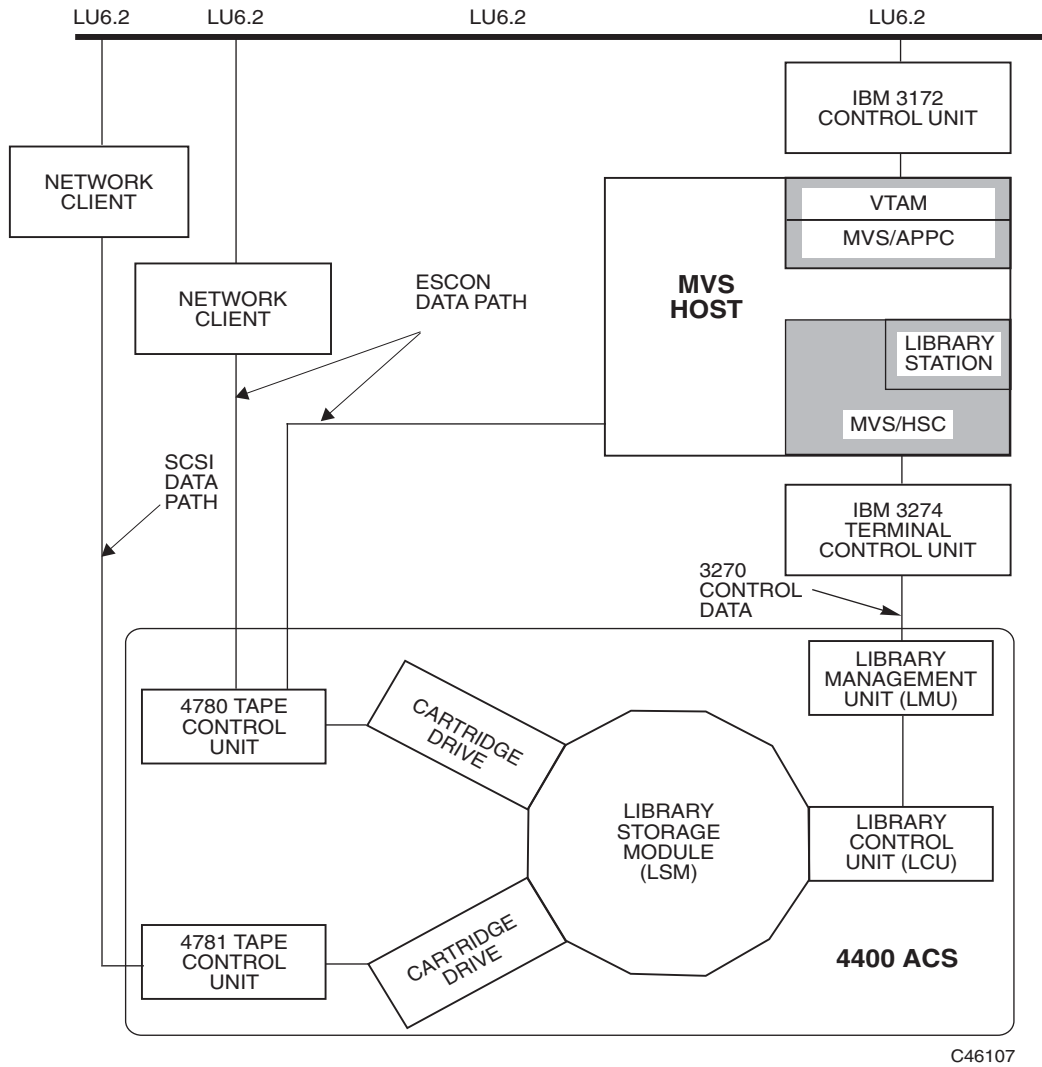

FIGURE 2-1 Typical LibraryStation Configuration for ONC/RPC Clients



C46107

FIGURE 2-2 Typical LibraryStation Configuration for LU6.2 Clients

## LibraryStation Client/Server Environment

The LibraryStation client/server environment consists of a single LibraryStation server attached to various open systems network clients. LibraryStation communicates with these clients using RPC or LU6.2 communication types.

Certain clients can issue drive and volume locking requests to serialize resources. LibraryStation stores drive and volume locking information in a component known as the Persistent Data File (PDF).

The PDF is required for clients that utilize drive and volume locking. You must enable the PDF using one of the two methods described in [“Allocating the Persistent Data File” on page 50](#).

---

**Note** – To ensure the integrity of the information stored in the PDF, only one LibraryStation server can execute in the LibraryStation client/server environment.

---

The following figure illustrates the LibraryStation client/server environment:

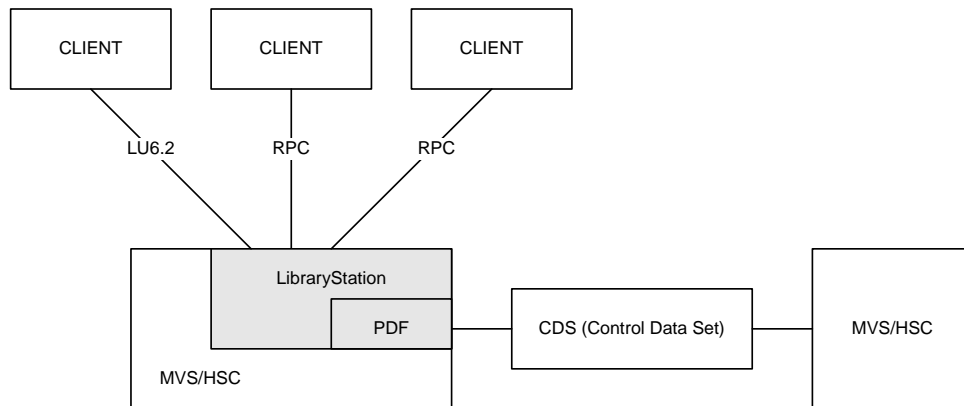

**FIGURE 2-3** LibraryStation Client/Server Environment

To ensure the integrity of the information stored in the PDF, any client using volume locking must secure the locked volumes using LibraryStation client volume access. See [“Configuring Security Measures” on page 36](#) for more information.

## System Redundancy Options

For system redundancy in the event of a failure on the MVS host system from which LibraryStation is normally executed, LibraryStation software can be made available to more than one MVS host system attached to the same Nearline ACS library complex.

If the HSC host system fails in this scenario, LibraryStation can be automatically initialized on an alternate host system via a host communication request. Or, LibraryStation can be manually initialized from an alternate host system using the LibraryStation LS INit operator command. See the HOSTID and DEFER parameters in [“Configuring the LSINIT Control Statement” on page 59](#).

LibraryStation software can be made available to multiple hosts either by installing it directly on each host or by installing it on DASD that is shared among the hosts. However, each host that will be capable of initializing LibraryStation must also have the HSC, a communications subsystem, and a network interface adaptor installed. The initializing hosts must also access a common PARMLIB data set.

# Verifying Software and Hardware Requirements

## Software Requirements

LibraryStation software requirements include the following:

Category	Supported Software
Operating system	MVS (All IBM-supported versions of z/OS) (JES2 and JES3 environments)
Required software	<ul style="list-style-type: none"> <li>■ LibraryStation 7.2</li> <li>■ HSC 7.2</li> </ul>
Optional supporting software (can be installed at any time before or after LibraryStation software is installed)	<ul style="list-style-type: none"> <li>■ Tape Management System (TMS) that implements management of tape pools (for example, CA-1)</li> <li>■ System Authorization Facility (SAF) security system that checks LibraryStation requests for authorization using the IBM MVS RACROUTE request facility (for example, RACF)</li> </ul>
TCP/IP communications	<ul style="list-style-type: none"> <li>■ IBM TCP/IP Release 3.1 or higher</li> <li>■ CA Unicenter TCPAccess Communications Server Release 5.0 or higher</li> <li>■ CA Unicenter TCPAccess X.25 Server Release 1 or higher</li> </ul>
SNA LU 6.2 communications	<ul style="list-style-type: none"> <li>■ IBM ACF/VTAM Release 3.4.2 or higher</li> <li>■ IBM APPC/MVS communication services</li> </ul>
HSC Server System Communications	<ul style="list-style-type: none"> <li>■ IBM ACF/VTAM Release 3.4.2 or higher.</li> <li>■ LMU Microcode Release 1.5.x or higher is required for multiple-level host-to-host communications.</li> </ul>

Verify that all required software packages are installed and check off each installed component on the LibraryStation Configuration Worksheet in [Appendix A](#).

## Hardware Requirements

LibraryStation hardware requirements include the following:

Category	Supported Hardware
Processor	IBM or compatible processor running MVS (any IBM-supported version of z/OS)
StorageTek Nearline Automated Cartridge System (ACS) library hardware	Refer to the publication <i>Installing ELS</i> .
Communications	<ul style="list-style-type: none"> <li>■ For installations using a TCP/IP communications product such as IBM TCP/IP or CA Unicenter TCPaccess Communications Server, a network interface adapter is required. Consult your TCP/IP vendor for a list of supported network adapters.</li> <li>■ For installations using APPC/MVS, the network hardware that provides connectivity to the client must be installed. This hardware is not provided by Oracle. Typical configurations might use an IBM 3172 or IBM 3174 Interconnect Controller to connect to a token ring network. Channel-to-channel connections are also possible; essentially, any connection that VTAM supports can be used.</li> </ul>

Verify that all required hardware packages are installed and check off each installed component on the LibraryStation Configuration Worksheet in [Appendix A](#).

---

# Configuring Communication Facilities

Based on the type of client systems LibraryStation will support, various communications facilities must be installed. This chapter contains information regarding installation and configuration of these facilities.

## ONC/RPC Support

A TCP/IP communications product, such as IBM TCP/IP or CA Unicenter TCPAccess Communications Server, must be installed for LibraryStation to support ONC/RPC clients. Consult your TCP/IP vendor for specific installation procedures.

## Domain Name Resolution

If you are using IBM TCP/IP for TCP/IP communications, the SAS/C socket library uses the following procedure to resolve host names and addresses:

---

**Note** – If you are using CA Unicenter TCPAccess TCP/IP products, the following procedure does not apply. Contact your CA TCPAccess Network Administrator.

---

1. The SAS/C socket library looks for the ETC.RESOLV.CONF data set. If this data set is not found, the SAS/C socket library looks for the TCPIP\_PREFIX.ETC.RESOLV.CONF data set; the MVS data set equivalent to /etc/resolv/conf.
  - If it finds either of these data sets, the socket library performs the requested queries through the resolver and returns any answer it receives.
  - If no answer is received, the socket library performs the actions in step 3, below.
  - If neither data set is found, the socket library performs the actions in step 2, below.
2. It looks for the data set in the format of the IBM TCPIP.DATA data set.
  - If the NSINTERADDR statement in this data set specifies the use of the resolver and name server, the socket library performs the specified queries and returns any answer it receives.
  - If no answer is received, the socket library performs the actions in step 3, below.
3. It looks for the TCPIP\_PREFIX.ETC.HOSTS data set; the MVS data set equivalent to /etc/hosts. If it finds the data set, the socket library returns the result, including failure.

The SAS/C environment has a limit of three name servers, and thus the SAS/C socket library only recognizes the first three name servers specified in this data set.

---

**Note** – Contact your TCP/IP Networking Administrator for details regarding the content and format of the configuration data sets mentioned above.

---

## Resolving the TCPIP\_PREFIX High Level Qualifier

The high level qualifier for the previously listed data sets defaults to TCPIP (IBM convention), or can be set using the DATASETPREFIX statement in the IBM TCP/IP configuration data set TCPIP.DATA. To access this data set, add the following DD statement to the HSC Started Task procedure:

```
//SYSTCPD DD DSN=ddd.eee.fff(anyname)
```

This DD statement identifies the data set used to obtain parameters defined by the IBM TCPIP.DATA configuration data set. Refer to the *IBM TCP/IP Customization and Administration Guide* for more information.

## LU6.2 Support

IBM APPC/MVS and VTAM are required to support SNA LU6.2 clients.

The following steps must be performed if LibraryStation will be used to communicate with LU6.2 clients. These steps should be performed by an experienced network systems programmer who is familiar with VTAM, APPC/MVS, and the physical network hardware used to connect the client system to MVS. It may also be necessary to involve the network administrator who is responsible for the client system.

Before performing these steps, verify that the following prerequisite requirements are met:

- MVS is the installed operating system.
- VTAM 3.4 or later is installed and operational.
- All network hardware used to connect the client system to MVS is installed and properly defined to VTAM.

It may be helpful to have the following publications available for reference:

- *IBM MVS/ESA Planning: APPC Management*
- *IBM VTAM Customization*
- *IBM VTAM Resource Definition Reference*
- *IBM VTAM Network Implementation Guide*

If you are not familiar with APPC/MVS, take time to familiarize yourself with the *IBM MVS/ESA Planning: APPC Management manual*.

---

**Note** – The examples provided in this description use LIBSTAT as the Logical Unit (LU) name for LibraryStation. This can be changed to meet any LU naming conventions your installation may require.

---



## VTAM Setup

1. A local Logical Unit for LibraryStation must be defined with a VTAM application (APPL) definition statement in SYS1.VTAMLST. This is the Logical Unit that the client system will use in order to connect to LibraryStation. The Logical Unit is defined to APPC using an LUADD statement in the APPCPMLS SYS1.PARMLIB member and it is also specified in the APPC side information entry that LibraryStation uses in order to register with APPC.

Details about creating the APPCPMLS member in SYS1.PARMLIB and the APPC side information file are provided later in this description. The following APPL statement can be used:

```
LIBSTAT      APPL      ACBNAME=LIBSTAT,
                  APPC=YES,
                  AUTOSES=0,
                  DDRAINL=NALLOW,
                  DLOGMOD=APPCHOST,
                  DMINWNL=5,
                  DMINWNR=5,
                  DRESPL=NALLOW,
                  DSESLIM=10,
                  LMDENT=19,
                  MODETAB=LOGMODES,
                  PARSESS=YES,
                  SECACPT=CONV,
                  SRBEXIT=YES,
                  VPACING=1
```

**FIGURE 2-4** Sample VTAM Setup APPL Statement

2. Logon mode entries necessary for LU6.2 sessions must be compiled into the logon mode table that exists in SYS1.VTAMLIB. The required entries are SNASVCMG and APPCHOST. These entries can be found in the SYS1.SAMPLIB member ATBLMODE.

The *IBM MVS/ESA Planning: APPC Management manual* provides more details about defining the local Logical Unit and logon mode entry.

---

**Note** – Other VTAM setup is required to define the physical connection between the client system and MVS. An experienced network systems programmer should be involved in this setup and it should be completed before installing LibraryStation.

---

## APPC/MVS Configuration

The setup for APPC/MVS consists of the following steps:

1. Create a member in SYS1.PARMLIB named APPCPMLS with the following information (or add to an existing APPCPMxx member):

```
LUADD ACBNAME(LIBSTAT) BASE NOSCHED TPDATA(side_info_file)
SIDEINFO DATASET(side_info_file)
```

where: *side\_info\_file* is the name of the VSAM KSDS that contains APPC side information for the installation (see step 2).

---

**Note** – If a Base already exists, do not include “BASE” in the statement above.

---

The *IBM MVS/ESA Planning: APPC Management* manual describes the APPCPMxx parmlib statement in more detail.

When APPC is started through the use of the START APPC MVS command, you must specify the last two letters of the member name on the START command, as shown in the following example:

```
START APPC, SUB=MSTR, APPC=LS
```

The *IBM MVS/ESA Planning: APPC Management* manual provides detailed information about starting and stopping APPC. It also includes instructions for displaying the status of APPC using the DISPLAY APPC command.

2. Create the APPC side information file and add an entry for LibraryStation.

The following JCL can be used to define and populate an APPC side information file suitable for LibraryStation operation. If your site already has a side information file defined, you only need to run the INITSIDE step.

```
//DEFAPPC JOB job card information
//DEFSIDE EXEC PGM=IDCAMS
//SYSPRINT DD SYSOUT=*
//SYSABEND DD SYSOUT=*
//AMSDUMO DD SYSOUT=*
//SYSIN DD *
DEFINE CLUSTER (NAME(cluster_name) _
VOLUME(volser) _
INDEXED REUSE _
SHAREOPTIONS(3 3) _
RECORDSIZE(248 248) _
KEYS(112 0) _
RECORDS(5 5)) _
DATA _
(NAME(cluster_name.DATA)) _
INDEX _
(NAME(cluster_name.INDEX))
```

**FIGURE 2-5** Sample APPC Side Information File - Part 1

```

//INITSIDE EXEC PGM=ATBSDFMU
//SYSPRINT DD SYSOUT=*
//SYSSDLIB DD DSN=cluster_name,DISP=SHR
//SYSSDOUT DD SYSOUT=*
//SYSIN DD DATA,DLM='JR'
SIADD
    DESTNAME(LIBSTAT)
    TPNNAME(CSCI)
    PARTNER_LU(LIBSTAT)
    MODENAME(APPCHOST)

```

**FIGURE 2-6** Sample APPC Side Information File - Part 2

### *cluster\_name*

The file name specified here is used on the SIDEINFO DATASET statement in the APPCPMLS parmlib member (see step 1 above).

### *PARTNER\_LU*

used by LibraryStation when it registers with the APPC address space. It is also used by the SLGDIAG utility to define the destination Logical Unit. This Logical Unit name must match the name (LIBSTAT) that was chosen on the VTAM APPL statement. See [“VTAM Setup” on page 33](#).

### *MODENAME*

the name of the logon mode that controls the session between LibraryStation and the client application. A sample logon mode (APPCHOST) is provided. See [“VTAM Setup” on page 33](#).

## APPC/MVS Operation

Prior to starting LibraryStation, APPC/MVS and VTAM should be up and all physical and logical units used to connect the client system to the LibraryStation Logical Unit should be active. This can be done either manually with operator commands or automatically at IPL. Contact your network system programmer for help. The *IBM MVS/ESA Planning: APPC/MVS Management Manual* describes the start command for starting APPC/MVS. The *IBM VTAM Operation Manual* describes commands for starting VTAM and for activating logical units.

# Configuring Security Measures

Network client access to library resources is controlled by LibraryStation security measures. Resources that may require access control fall into three categories: tape cartridge drives, volumes, and client commands.

Depending on your security decisions, one or more of the tasks described in this chapter may require specific parameter settings or additional work on your part **before** you reconfigure the HSC LIBGEN.

## Drive Access Security

Access to tape cartridge drives is controlled by limiting the number of drives that are available to LibraryStation. LibraryStation drives are defined in the HSC LIBGEN as belonging to the host associated with the NETHOST keyword in the LSINIT control statement. Drives that are not associated with this hostid are restricted from use by the network.

To restrict the number of tape cartridge drives the network can use, you must define which specific drives are available to LibraryStation. This procedure is described in [“Configuring Drive Device Numbers” on page 54](#).

## Volume Access Security

LibraryStation provides two levels of access security for client’s volumes. Neither, one, or both can be implemented. One level of security allows protection of MVS volumes from all network clients. The other level of security allows volume access on a client-by-client basis. Both levels are implemented using RACROUTE calls to specify authorization to use the volume.

The IBM RACROUTE request specifies the APPL=‘SLGSTATN’ parameter. This can be used by your SAF exits to identify that the request came from LibraryStation.

When using either method of volume authorization checking, you must write security rules to allow or deny access to the volumes. See [“Implementing Network-Level Volume Authorization Checks” on page 39](#) for more information.

---

**Note** – In an environment running LibraryStations with NOPDF and PDF options, use of LibraryStation volume access security is critical for protection of both MVS and network client volumes.

---

The following parameters of the LSINIT statement influence both levels of volume authorization checking.

```
LSINIT VSECLOG(YES) AUTHCLS(#LSTAPE) VOLNOPRF(ALLOW)
```

where:

#### **VSECLOG(YES)**

Setting the VSECLOG parameter to YES causes volume security violations to be logged on the MVS system log and in the HSC job log. It is recommended that VSECLOG be set to YES during initial testing of volume authorization. After you are satisfied that volume authorization is working as desired, you can change the parameter to NO to stop receiving these messages.

#### **AUTHCLS(#LSTAPE)**

This parameter defines the security class to which the volumes are defined. The above example defines a new security class called #LSTAPE. Once you have picked a security class, use that name for the AUTHCLS parameter value.

The default value for AUTHCLS is TAPEVOL. If you are using a security product that also provides the TAPEDSN class, it is recommended that TAPEVOL not be used. Some security products alter the list of users allowed to access a volume when the TAPEDSN class is also being used. This can cause LibraryStation authority checking to fail, thus allowing inappropriate access.

An alternative to the TAPEVOL class is the FACILITY class. This is a defined class to some security products and thus does not require you to create a new security class.

You can define your own security class to be used in the RACROUTE calls. Be sure to follow all the steps required by your security package to define and activate the class.

#### **VOLNOPRF(ALLOW)**

Volumes not defined to the security class are considered to be available for any client request. If you have many MVS volumes and you use the RACF security product, you can prevent clients from accessing undefined volumes by setting VOLNOPRF to DENY as a parameter on the LSINIT statement. If a volume is unknown to RACF, read or write access to the volume is denied. VOLNOPRF works in conjunction with VOLACC or VOLAUTH.

Record site specific values for these parameters in [Appendix A](#).

## Network-Level Volume Authorization Checks

When your installation wants to protect MVS volumes from all network clients and does not want to protect one client's volumes from another client, network-level volume authorization checking is a good choice for volume protection.

Network-level volume authorization checks work in the following manner. When a client requests access to a volume, an IBM RACROUTE call with REQUEST=AUTH is issued to the System Authorization Facility (for example, RACF) to determine whether LibraryStation has access to the volume. If LibraryStation's access to the volume is not sufficient, the client request is denied. For example, when a client requests to eject a volume, LibraryStation must have UPDATE authority to that volume for the client eject request to succeed. If LibraryStation has no access or only READ access to the volume, the client eject request fails. The client is notified that the volume is in use. A complete list of client requests with required LibraryStation authority for network-level volume authorization is provided in "Implementing Network-Level Volume Authorization Checks" below.

The VOLAUTH parameter of the LSINIT statement determines if network-level volume authorization is in effect.

```
LSINIT VOLAUTH (YES) , VSECLOG (YES) , AUTHCLS (#LSTAPE) , VOLNOPRF (ALLOW)
```

where:

### **VOLAUTH(YES)**

Setting the VOLAUTH parameter to YES or letting it default to YES enables network-level volume authorization checking.

Record your value for this parameter on the LibraryStation Configuration Worksheet in [Appendix A](#).

## Implementing Network-Level Volume Authorization Checks

If you plan to require network volume-access security, you must use a security product (for example, RACF) on your MVS system.

To enable this level of volume-access control, you could use the following steps:

1. Create a security id for LibraryStation. LibraryStation issues the RACROUTE REQUEST=AUTH macro from the HSC address space. The security id associated with the RACROUTE request will be the security id defined for the HSC address space. Follow the rules of your security package for defining a security id for a started task. Do not give the security id any special privileges.
2. If you are not using the TAPEVOL or FACILITY security class, create a security class for the tape volumes.
3. Activate the security class you are using.
4. Define volumes to the security class.
5. Write security rules to allow LibraryStation (the HSC started-task security id) the appropriate access to the library volumes.
6. To prevent clients from mounting scratch volumes meant only for HSC use, define separate scratch subpools for LibraryStation. See [“Scratch Pool Processing” on page 47](#) for more information.
7. Verify that the VOLAUTH parameter of the LSINIT statement is set to YES or allowed to default. See [“Configuring Drive Device Numbers” on page 54](#) for a description of the VOLAUTH parameter.

SAF checks are issued for the following requests:

- Requests requiring a minimum of READ authority:
  - Dismount
  - Mount with read-only option
  - Query\_volume
- Requests requiring a minimum of UPDATE authority:
  - Eject
  - Mount
  - Set\_scratch

If you plan not to require network volume-access security, you should disable it by specifying VOLAUTH(NO) in the LSINIT control statement.

*Example 1 - Restricting all MVS volumes from network client use*

To restrict MVS volumes from network client use of any kind, you could use the following steps:

1. Create a security id for LibraryStation by defining a security id for the HSC started task.
2. Using your security product:
  - Use the FACILITY class to define volumes, and activate the class.
  - Reserve volumes 000000-199999 for MVS use only. (Write rules to deny access to these volumes for the LibraryStation security id.)
  - Reserve volumes 200000-200099 for client use. (Write rules to allow UPDATE access to these volumes for the LibraryStation security id.)
3. Set up the LibraryStation scratch pool so that no MVS volumes reside in the pool. To allow this, add the following statement to the HSC parameter data set:  

```
SCRPOOL NAME(LIBSTA) , RANGE(200000-200099)
```

(The scratch pool is associated with LibraryStation in the next step.)
4. Update the LSINIT control statement in the HSC parameter data set:  

```
LSINIT COMMONSP(LIBSTA) AUTHCLS(FACILITY) VSECLOG(YES)  
      NETHOST(hostid)
```

Volume authorization is active by default. All client volumes are in one subpool that does not contain any MVS-only volumes. All volumes are defined to the FACILITY security class and security violations are to be logged on the MVS system log.

As a result, when a client request is received for a volume, RACROUTE is issued. If the volume is in the range for MVS-only volumes, access is denied and message SLS3945I is issued to the MVS system log. If the volume is in the range for client volumes, access is allowed and the client request continues to execute.



*Example 2 - Restricting most MVS volumes from network client use*

To restrict most MVS volumes from network client use of any kind, while allowing the clients to share a few MVS volumes in read-only mode, you could use the following steps:

1. Create a security id for LibraryStation by defining a security id for the HSC started task.
2. Use your security product to:
  - Use the FACILITY class to define volumes, and activate the class.
  - Reserve volumes 000000-199999 for MVS use only. (Write rules to deny access to these volumes for the LibraryStation security id.)
  - Reserve volumes 200000-200099 for client use. (Write rules to allow UPDATE access to these volumes for the LibraryStation security id.)
  - Allow the volumes 300000-300005 to be shared by MVS and the clients. Clients are only allowed to read these volumes. (Write rules to allow READ access to these volumes for the LibraryStation security id.)
3. To set up the LibraryStation scratch pool so that no MVS volumes reside in the pool, add the following statement to the HSC parameter data set:
 

```
SCRPOOL NAME(LIBSTA) , RANGE(200000-200099)
```

 (The scratch pool is associated with LibraryStation in the next step.)
4. Update the LSINIT control statement in the HSC parameter data set:
 

```
LSINIT COMMONSP(LIBSTA) AUTHCLS(FACILITY) VSECLOG(YES)
      NETHOST(hostid)
```

Volume authorization is active by default. This statement defines all client volumes in one subpool that does not contain any MVS-only volumes. All volumes are defined to the FACILITY security class and security violations are to be logged on the MVS system log.

When a client request is received for a volume, RACROUTE is issued. If the volume is in the range for MVS-only volumes, access is denied and message SLS3945I is issued to the MVS system log. If the volume is in the range for client volumes, access is allowed and the client request continues to execute. If the volume is in the shared range of volume serials and the client request requires UPDATE authority, access is denied and message SLS3945I is issued to the MVS system log. If the volume is in the shared range of volume serials and the client request requires READ authority, access is allowed.

## Client-Level Volume Authorization

If you would like to limit the volumes that a specific client can access, use client-level volume authorization. This level associates a security id with a client. This security id is used in the RACROUTE call to determine whether the client has the authority required to perform its request. Client-level volume authorization can be used to protect a client's volume from another client and to protect MVS volumes from specific clients.

When using client-level volume authorization, the clients must be defined in the LSDEF file. The CLIENTID statement in that file associates a security id with the client's network identifier. That security id is used in the RACROUTE call to determine whether the client has authority to the volume. See [“Configuring the LSDEF Data Set” on page 70](#) for more information on the LSDEF Data Set.

Client-level volume authorization works in the following manner. When a client requests access to a volume, and IBM RACROUTE REQUEST=AUTH call is issued to the System Authorization Facility specifying the client's security id and the volume serial number to determine whether the client has access to the volume. If the client's access to the volume is not sufficient, the client request is denied. For example, when a client requests to eject a volume, the client must have UPDATE authority to that volume for the eject to succeed. If the client has no access or only READ access to the volume, the eject request fails. The client is notified that access has been denied or that the volume is not in the library. The response depends on the network protocol level supported by the client. A complete list of client requests with required client authority for client-level authorization is provided in [“Implementing Client-Level Volume Authorization Checks” on page 43](#).

The VOLACC parameter of the LSINIT statement determines if client-level volume authorization is in effect.

```
LSINIT VOLACC (YES) VSECLOG (YES) AUTHCLS (#LSTAPE) VOLNOPRF (ALLOW)
      VOLAUTH (NO)
```

where:

### **VOLACC(YES)**

Setting the VOLACC parameter to YES enables client-level volume authorization checking. The default is NO.

---

**Note** – VOLACC(YES) is supported only when COMMTYPE is specified as RPC or LU6.

---

### **VOLAUTH(NO)**

Network-level volume authorization is active by default. In the example above, network-level volume authorization is turned off. Clients can also be restricted from MVS volumes by using client-level volume authorization checking.

Record your value for this parameter on the LibraryStation Configuration Worksheet in [Appendix A](#).

## Implementing Client-Level Volume Authorization Checks

If you plan to require security for volume access on a client level, you must install a security product (for example, RACF) on your MVS host system.

To enable volume-access control at the client level, you could use the following steps:

1. Create a security id for each client.
2. Add a CLIENTID parameter in the LSDEF file for each client. See [“Configuring the LSDEF Data Set” on page 70](#) for more information.
3. Create a security class for the tape volumes if you are not using the TAPEVOL or FACILITY security class.
4. Activate the security class you are using.
5. Define volumes to the security class.
6. Write security rules to allow the client security id appropriate access to the library volumes.
7. Verify that LSINIT parameter VOLACC is set to YES. See [“Configuring the LSINIT Control Statement” on page 59](#) for more information.

LibraryStation issues RACROUTE calls for the following client network requests:

- These requests require a minimum of READ authority:
  - Dismount
  - Mount with read-only option
  - Query\_volume
- These requests require UPDATE authority:
  - Eject
  - Lock
  - Mount
  - Mount\_scratch
  - Set\_scratch
  - Unlock

*Example 1 - Separating volumes for two clients and for MVS*

To keep volumes separate for two clients and for MVS, you could use the following steps:

1. Use your security package to create a security id for each client in the complex.
2. Update the LSDEF file to associate the network location of the client with its security id. For example:

```
CLIENTID IPADDR(129.xx.xx.xxx) NAME(CLIENT1)
CLIENTID LUNAME(CLINT2LU) NAME(CLIENT2)
```

(In this example, one client is using TCP/IP and the other is using LU6.2.)

3. Use your security package to:
  - Use the FACILITY class to define volumes, and activate the class.
  - Reserve volumes 000000-199999 for MVS use only. (Write rules to deny access to these volumes for both CLIENT1 and CLIENT2.)
  - Reserve volumes 200000-299999 for CLIENT1 use. (Write rules to allow UPDATE access to these volumes for CLIENT1 and rules to deny access to these volumes for CLIENT2.)
  - Reserve volumes 300000-399999 for CLIENT2 use. (Write rules to allow UPDATE access to these volumes for CLIENT2 and rules to deny access to these volumes for CLIENT1.)

4. Update the LSINIT control statement in the HSC parameter data set as follows:

```
LSINIT VOLACC(YES) VOLAUTH(NO) AUTHCLS(FACILITY) VSECLOG(YES)
```

Volume authorization is active by default. This control statement turns off volume authorization and activates volume-access checking at the client level. Volumes are defined to the FACILITY security class, and security violations are to be logged on the MVS system log.

As a result, when a client request is received for a volume, RACROUTE is issued. If the volume is in the range for MVS-only volumes, access is denied. If the volume is in the range for CLIENT1 volumes, access is allowed for CLIENT1 and denied for CLIENT2. If the volume is in the range for CLIENT2 volumes, access is allowed for CLIENT2 and denied for CLIENT1. Whenever access is denied, message SLS3945I is issued to the MVS system log.

## Volume Security Hierarchy

When both methods of volume security checking are specified (VOLAUTH and VOLACC parameters), the specific client volume-access checking is performed first.

The client commands that access volumes and are under the sphere of both the VOLAUTH and VOLACC parameter checking are:

- Dismount
- Eject
- Mount
- Query\_volume
- Set\_scratch

The client commands that are under the sphere of only the client volume access (VOLACC parameter) are:

- Lock
- Mount\_scratch
- Unlock

---

**Note** – The *mount with read\_only option* listed under the client volume access is not a separate command. The read\_only option is specified by a parameter of the client MOUNT command.

---

If you plan not to require volume-access security on a client level, you can leave the VOLACC parameter unspecified in the LSINIT control statement.

## Subpool Security Implications

For installations that use VOLAUTH only, network requests to mount scratch volumes do not pass through the IBM RACROUTE request mechanism. VOLACC issues RACROUTE calls for scratch mounts; VOLAUTH does not.

For VOLAUTH-only installations, network clients can mount any volume that is both identified as a scratch volume in the HSC Control Data Set (CDS), and defined in a scratch subpool known to the client. Consequently, for VOLAUTH-only installations, you must define subpools to contain only those volumes that network clients are allowed to mount. This is done in the HSC SCRPOOL control statement. See [“Scratch Pool Processing” on page 47](#) for more information about defining subpools.

Network requests to mark a volume as scratch go through the IBM RACROUTE request check, preventing clients from scratching a volume they would not normally have access to and then performing mount scratch requests until the desired volume is mounted. However, if the HSC SCRATCH UPDATE utility is run to mark the volume as scratch, and if MVS and the client share a scratch pool, the clients could gain access to the volume.

## Command Access Security

RACF is the only security package supported by LibraryStation for command-level authorization checks. Access to commands is controlled by RACROUTE request calls to the System Authorization Facility (for example, RACF) to determine whether the command can be used by a network-attached user. Commands that SAF indicates cannot be accessed are not available to the client.

If you plan to require security for command access on a client level using RACROUTE calls to the System Authorization Facility (SAF), you must install RACF on your MVS host system, and you must enable the CMDACC parameter (CMDACC(YES)) in the LSINIT control statement. See [“Configuring the LSINIT Control Statement” on page 59](#).

To enable this level of access control, perform the following steps:

1. Use your security product to create a security id for the client.
2. Notify LibraryStation of the userid for the client by adding a CLIENTID parameter to the LSDEF file for the client. See [“Configuring the LSDEF Data Set” on page 70](#) for a description of the CLIENTID parameter.
3. Define the commands as applications to the security product as follows:

**TABLE 2-1** Command to Application Name Cross Reference

Command	Application Name
CANCEL	SLGCANCL
CLEAR_LOCK	SLGCLRLK
DISMOUNT	SLGDISMO
EJECT	SLGEJECT
ENTER	SLGENTER
IDLE	SLGIDLE
LOCK	SLGLOCK
MOUNT	SLGMOUNT
MOUNT_SCRATCH	SLGMSCRT
QUERY	SLGQUERY
QUERY_LOCK	SLGQUYLK
SET_SCRATCH	SLGSETSC
START	SLGSTART
UNLOCK	SLGUNLOK
VARY	SLGVARY
VIRTUAL_MOUNT	SLGVMNT

4. Write rules to allow the client to read the application.
5. Activate the APPL class.
6. The startup parameter CMDACC in the LSINIT statement can be used to enable or disable command authorization checks. This parameter is disabled by default. Verify that the CMDACC parameter is set to YES. See [“Configuring the LSINIT Control Statement” on page 59](#) for a description of the CMDACC parameter.

Commands that SAF indicates cannot be accessed are reported as “access denied” or “invalid command”.

If you plan not to require command access security on a client level, you can leave the CMDACC parameter in the LSINIT control statement unspecified.

## Scratch Pool Processing

LibraryStation relies on HSC to define the scratch pools it uses. HSC has a common, unnamed scratch pool that contains all scratch volumes. It also defines multiple, named scratch subpools that are subsets of the common pool. These scratch subpools are defined in the HSC PARMLIB by SCRPOOL statements. These statements indicate ranges of volumes that belong to the scratch subpool. If a volume also has the “scratch” attribute, then it can be selected for scratch mounting.

```
SCRPOOL NAME(LIBSTAT) , RANGE(LS1###-LS13##) , LABEL(SL)
SCRPOOL NAME(LSPOOL) , RANGE(LS13#1-LS14##) , LABEL(SL)
```

---

### Note –

---

1. If you use the HOSTID parameter on the SCRPOOL statement, it should point to your HSC host.
2. The time taken by Library Station to complete a query scratch request is proportional to the number of volumes included with the RANGE parameter. If you use ranges that include a large number of volumes, a query scratch can take a long time.

The scratch subpools may also be defined using the Scratch Subpool User Exit (SLSUX03), but the SCRPOOL statements are preferred. The ranges of volumes in the SCRPOOL statements can overlap, so some volumes can be in multiple scratch subpools.

LibraryStation only has access to named HSC scratch subpools that are identified for its use. These are identified in two ways.

1. The COMMONSP parameter of the LSINIT statement points LibraryStation’s scratch pool 0 to a named HSC scratch subpool. This scratch pool, and therefore this statement, are required for LibraryStation.

```
COMMONSP(LIBSTAT)
```

2. The SPNUM statement in the LSDEF data set equates a LibraryStation numeric scratch pool (0-65534) to an HSC-named scratch subpool. This statement is useful for clients who use scratch pools other than 0. For example:

```
SPNUM NUM(2) SPNAME(LSPOOL1)
SPNUM NUM(2) SPNAME(LSPOOL2) IPADDR(1.2.3.4)
```

In this example, the client at address 1.2.3.4 would get volumes from LSPOOL2 when referring to pool 2, and all other clients would get volumes from LSPOOL1.

Because HSC scratch subpools are defined during initialization, they, as well as LibraryStation scratch pools, are static. New scratch pools cannot be dynamically defined. New volumes outside the defined range cannot be dynamically included in a scratch pool. Also, a volume can be defined in the ranges for two scratch subpools. Thus, scratching it in one automatically scratches it in the other. For this reason, you may want to avoid overlapping pools if you want to keep volumes separate for various clients or for HSC. If you want distinct subpools for HSC and for clients, you should code the Job Processing User Exit (SLSUX01) not to select from the LibraryStation subpools if an HSC subpool is depleted. LibraryStation scratch requests do not use the exit, so their selection is always from the specified subpool.

---

**Note** – LibraryStation scratch mount requests have no interface to a Tape Management System (TMS) on MVS, so the subpools used by LibraryStation should not be defined to the TMS. Defining a subpool to the TMS may cause the TMS to have incorrect status for volumes if they are mounted by a client that does not have an interface to the TMS. For a TMS that works on the client side, take special care to keep the HSC scratch information synchronized with that in your TMS, because HSC can change scratch volumes without the knowledge of the client.

---

If your installation contains volumes stored on various media types, you can segregate them in scratch pools through careful definition of the HSC scratch subpools. Even if you do not segregate the pools, during scratch mounting, LibraryStation picks a volume whose medium is appropriate for the drive type. LibraryStation gets its scratch counts for selection from HSC VOLATTR statements, so VOLATTR statements should be coded for all non-standard volumes in scratch ranges.

LibraryStation has a POOLCHK parameter on the LSINIT statement that affects the scratching of volumes.

- With POOLCHK set to YES (the default), a set scratch request for a volume and a scratch pool ensures that the volume is defined in that pool before scratching the volume.
- With POOLCHK set to NO, no checking is done to see whether the volume is defined in any scratch pool before scratching it.



## Security Summary

The following list summarizes the methods available to you for ensuring that network clients cannot circumvent MVS access controls:

- Restrict the number of tape cartridge drives the network can use in the HSC LIBGEN for the hostid in the NETHOST keyword.
- Use SAF security checks for volume access control.
- Write rules that grant the HSC update authority for only those volumes the network is permitted to use, and also to prevent MVS users from accessing network client volumes.
- Write rules to manage volume access for individual clients.
- Define the subpools to contain only volumes the network is permitted to use.
- If you are using RACF, deny access to undefined volumes.
- Use SAF security checks for command authorization control.

Record your value for this parameter on the LibraryStation Configuration Worksheet in [Appendix A](#).

## Allocating the Persistent Data File

LibraryStation software includes a Database Manager (DBM) that is initialized during LibraryStation initialization. The DBM is responsible for managing several pertinent data objects that are not maintained by the HSC, including resource locks and drive status.

Data objects managed by the DBM are stored in one or more VSAM files. These files are collectively referred to as the Persistent Data File (PDF).

The PDF contains the following data objects:

- Volume records  
Volume records contain only a lockid. They exist only while the volume is locked and are automatically deleted when the volume is unlocked.
- Drive records  
A single drive record exists for each drive configured to LibraryStation. Each drive record consists of a lockid as well as status and state information.
- Lockid records  
One lockid record exists for each unique lock identifier that has been assigned to the requesting clients. The lockid record contains a lock identifier and the associated owner of the lock.

The PDF VSAM data sets are initially defined during LibraryStation installation. This procedure is contained in the publication *Installing ELS*.

---

**Note** – If you are migrating from a previous release of LibraryStation, you must delete the existing PDF and define a new PDF for LibraryStation 7.2. Refer to the publication *Installing ELS* for this procedure.

---

After LibraryStation is installed, these data sets can be allocated using either of the following two methods:

- Specify the PDF and PDFX keywords on the LSINIT control statement. This method is required when requesting cross host recovery support.
- Specify the SLSPDF and SLSPDFX DD statements in your HSC Started Task Procedure.

## The PDF in a Multiple Host Environment

LibraryStation software can be installed on or made available to more than one host system. However, it can only be fully-initialized on one host system at a time. For system redundancy in the event of a failure, more than one host system can be made capable of fully-initializing LibraryStation.

- Using Cross host recovery (implemented with the XHREC LSINIT parameter), the active LibraryStation automatically notifies standby LibraryStations to begin initialization. The first standby LibraryStation that is notified becomes active.
- LibraryStation can also be manually initiated from an alternate host using the LS INIT operator command.

See the CHREC, HOSTID and DEFER options in [“Configuring the LSINIT Control Statement” on page 59](#) for more information.

---

### Note –

- You must allocate a single Persistent Data File (PDF) using one of the methods described in this chapter.

You must specify the keyword parameter NOPDF in the LSINIT control statement for all other LibraryStations that will be active at the same time. This parameter is not required when defining standby LibraryStations. See [“Configuring the LSINIT Control Statement” on page 59](#) for more information about the NOPDF and XHREC LSINIT parameters.

- A single PDF is defined for LibraryStation, and the host system where LibraryStation is initialized must have access to the DASD volume where the PDF is located. Thus, in a multiple host environment where more than one host is capable of initializing LibraryStation, the PDF must be located on shared DASD that is accessible to each initializing host.
- To prevent the corruption of the PDF, LibraryStation issues a SYSTEMS ENQ. The ENQ QNAME is the HSC ENQ QNAME specified by the MAJNAME parameter of the HSC LIBGEN. The ENQ RNAME is LS:ACTIVE.

If you make LibraryStation software available to more than one host, you are responsible for propagating the SYSTEMS ENQ to each host. This can be done via Global Resource Serialization (GRS) or a functionally equivalent product.

---

## Configuring the LibraryStation Hostid

A LibraryStation hostid must be defined in the HSC LIBGEN. This hostid is associated in the HSC LIBGEN with the cartridge drives that are assigned to LibraryStation. The hostid you define in this task will be used as the value for the NETHOST parameter in the LSINIT statement.

During operation, the LibraryStation hostid is specified by LibraryStation to the HSC for network drive requests. Additionally, this hostid is required for the HSC Mount and Dismount commands if operators are to mount or dismount volumes on cartridge drives assigned to LibraryStation.

---

**Note** – The NETHOST parameter specification on the LSINIT control statement must match the hostid that you define in this task. See [“Configuring the LSINIT Control Statement” on page 59](#) for more information about the NETHOST parameter.

---

To configure the HSC LIBGEN Hostid for LibraryStation, modify the HSC SLILIBRY macro in the HSC LIBGEN to define the LibraryStation hostid. SLILIBRY defines the global characteristics of the library. The SLILIBRY HOSTID parameter identifies each host that accesses the ACS and is the parameter you will modify to create your LibraryStation hostid.

The following sample illustrates where your hostid appears in the SLILIBRY macro.

```

*
      SLILIBRY  SMF=255 .                                X
              HOSTID=( HSC1 , LSID)                     X
             >NNLBDRV=( CARTAPEA , CARTAPEB ) ,         X
              DELDISP=NOSCRATCH ,                       X
              ACSLIST=NAMEACS ,                          X
              MAJNAME=STKALSON ,                          X
              COMPRFX=# ,                                X
              SCRLABL=SL ,                                X
              EJCTPAS=GOODDAY ,                           X
              CLNPRFX=CLN
*
    
```

**FIGURE 2-7** Sample SLILIBRY Macro with LibraryStation Hostid

The LibraryStation hostid you define in this task can consist of one to eight alphanumeric characters. You might consider including the letters "LS" in the name to identify it as your LibraryStation hostid. Refer to the publication *Configuring HSC and VTCS* for more information about the HSC LIBGEN process.

The SLIACS macro no longer requires a STATION parameter for each hostid in the configuration. **This parameter is optional.** If STATION is specified, parameters can be omitted for hosts that are not attached to the ACS by using the comma delimiter as follows:

Example:

```
STATION= ( , STN1)
```

where HOST0 does not have a defined connection and STN1 is a defined connection to Host.

In addition, the SLISTATN macro entry with a dummy address is no longer required and should not be entered.

Refer to the publication *ELS Programming Reference* for more information about the macros and parameters mentioned above.

Enter your LibraryStation hostid on the LibraryStation Configuration Worksheet in [Appendix A](#).

---

# Configuring Drive Device Numbers

In this task, you configure device numbers in the HSC LIBGEN for tape cartridge drives that are assigned to LibraryStation.

Device numbers must be assigned in the HSC LIBGEN for network tape cartridge drives used by LibraryStation. The tape cartridge drives represented by the assigned device numbers are associated with LibraryStation via the HSC LIBGEN hostid defined in the previous chapter.

Additionally, all LibraryStation drives must be defined in the LIBGEN for the HSC host on which LibraryStation is executed. Failure to do so results in LibraryStation drives with unknown device types.

Device numbers must be assigned in the HSC LIBGEN for network tape cartridge drives used by LibraryStation. The tape cartridge drives represented by the assigned device numbers are associated with LibraryStation via the HSC LIBGEN hostid defined in the previous chapter.

---

**Note** – Access to tape cartridge drives is controlled by limiting the number of drives that are available to LibraryStation. By not defining MVS drives for the LibraryStation hostid, you prevent network mounts and dismounts on these drives. See [“Configuring Security Measures” on page 36](#) for more information.

---

Device numbers can consist of three or four hexadecimal characters. All numbers are valid because device numbers are only associated with the LibraryStation hostid.

In addition, you must collect associated information for each device number you define. The following information is required by the HSC LIBGEN macros for each number:

- The ACS number where the drive is located
- The LSM number where the drive is located
- The drive panel number where the drive is located

Refer to the publication *ELS Programming Reference* for more information about the SLILSM, SLIDLIST, and SLIDRIVS macros.

Enter your device numbers and associated location information on the LibraryStation Configuration Worksheet in [Appendix A](#).

The process of defining device numbers for LibraryStation tape cartridge drives is somewhat dependent on your current configuration and how you intend to control network access to your tape cartridge drives. This process is outlined below in general terms, followed by a sample scenario that illustrates the steps you might take to achieve specific results.

Generally, defining device numbers for LibraryStation drives requires the following steps:

1. Add or modify the SLILSM macro

The SLILSM macro defines the panel numbers for an LSM. If this macro does not already include the drive panels you wish to make available to LibraryStation, modify it to define the physical location of these drive panels.

2. Add or modify the SLIDLIST macro

The SLIDLIST macro identifies which unique host addresses are associated with tape cartridge drives residing on a specific drive panel.

If you modified a SLILSM macro in the previous step, you must create a new SLIDLIST macro for each new panel.

If you did not modify a SLILSM macro, you still must modify existing SLIDLIST macros to define their relationship to the new LibraryStation hostid.

---

**Note** – HOSTDRV parameter operands in the SLIDLIST macro correspond to HOSTID parameter operands in the SLILIBRY macro.

---

The association is positional, so that the first hostid identified in the SLILIBRY macro is associated with the first hostdrv identified in the SLIDLIST macro, the second hostid is associated with the second hostdrv, and so on.

If the number of HOSTDRV operands in any SLIDLIST macro do not equal the number of HOSTID operands in the SLILIBRY macro, the HSC cannot be successfully initialized.

3. Add or modify the SLIDRIVS macro

The SLIDRIVS macro identifies whether or not tape cartridge drives in the panel specified in the SLIDLIST macro are available to the hostid associated with the HOSTDRV operand.

If the drives are available to the hostid, assign device numbers in the SLIDRIVS macro.

If the drives are not available to the hostid, enter position holding commas in the SLIDRIVS macro. Device numbers are not assigned.

---

**Note** – LibraryStation provides no automatic means of sharing tape cartridge drives between the MVS host and client systems. If a drive is being shared, you must use manual procedures to vary the drive offline to MVS and online to the client, and vice versa.

---

The following sample LIBGEN illustrates the process described above. Note that this sample contains only those macros and parameters that are pertinent to this discussion and does not represent a complete and functional HSC LIBGEN.

```

*
      SLILIBRY  HOSTID=(HSC1,LSID)
                        ACSLIST=NAMEACS
*
NAMEACS  SLIALIST  ACS0,ACS1
*
ACS0     SLIACS   LSM=LSM0,LSM1
*
LSM0     SLILSM   DRIVE=(1,2,10),
                        DRVELST=(PANEL1,PANEL2,PANEL10)
*
PANEL1   SLIDLIST  HOSTDRV=(DRV1,DRV1)
DRV1     SLIDRIVS  ADDRESS=(410,411,412,413)
*
PANEL2   SLIDLIST  HOSTDRV=(DRV2,DUMMY2)
DRV2     SLIDRIVS  ADDRESS=(414,415,416,417)
DUMMY2   SLIDRIVS  ADDRESS=(,,)
*
PANEL10  SLIDLIST  HOSTDRV=(DUMMY3,DRV3)
DUMMY3   SLIDRIVS  ADDRESS=(,,)
DRV3     SLIDRIVS  ADDRESS=(418,419,41A,41B)
*

```

**FIGURE 2-8** Sample LIBGEN with LibraryStation Device Numbers

This example provides the following conclusions:

- About the system:
  - The SLILIBRY macro indicates there are two hosts, named HSC1 and LSID. The second hostid, LSID, is the LibraryStation hostid.
  - The SLIALIST macro indicates there are two ACSs, represented by ACS0 and ACS1.
  - The assembler label (ACS0) preceding the SLIACS macro indicates the macros that follow are for ACS0.
  - The SLIACS macro indicates there are two LSMs in ACS0, represented by LSM0 and LSM1.
  - The assembler label (LSM0) preceding the SLILSM macro indicates the macros that follow are for LSM0 in ACS0.
- About the drive panels:
  - The DRIVE parameter in the SLILSM macro indicates there are three drive panels (1, 2, and 10) in LSM0. The first and second drive panels are the first and second panels sequentially in the LSM; the third drive panel is the tenth sequential panel in the LSM.
  - The DRVELST parameter in the SLILSM macro establishes the assembler labels to be referenced by subsequent SLIDLIST macros. These labels (PANEL1, PANEL2, and PANEL10) correspond positionally to the DRIVE parameter operands, so that PANEL1 represents the first drive panel and PANEL10 represents the third drive panel.



- About PANEL1:
  - The assembler label (PANEL1) preceding the first SLIDLIST macro indicates the macro is for the drive panel represented by PANEL1 in the prior SLILSM macro.
  - The HOSTDRV operands (DRV1,DRV1) indicate by their relative positions that tape cartridge drives on PANEL1 are available to both of the hostids that were established in the SLILIBRY macro.
  - The assembler label (DRV1) preceding the first SLIDRIVS macro indicates the device numbers are being created for tape cartridge drives in PANEL1, which was associated with DRV1 in the previous SLIDLIST macro.
  - The device numbers that are created in the ADDRESS parameter apply to both hosts since the previous SLIDLIST macro made tape cartridge drives on this panel available to both hosts.
  - LibraryStation provides no automatic means of sharing tape cartridge drives between the MVS host and client systems. If a drive is being shared, you must use manual procedures to vary the drive offline to MVS and online to the client and vice versa.
- About PANEL2:
  - The assembler label (PANEL2) preceding the second SLIDLIST macro indicates the macro is for the drive panel represented by PANEL2 in the previous SLILSM macro.
  - The unique HOSTDRV operands (DRV2,DUMMY2) indicate that separate instructions for each host will be provided in the subsequent SLIDRIVS macros.
  - The assembler label (DRV2) preceding the second SLIDRIVS macro indicates the device numbers are being created for drives in PANEL2, which was associated with DRV2 in the previous SLIDLIST macro.
  - Since DRV2 was the first HOSTDRV operand in the previous SLIDLIST macro, this SLIDRIVS macro applies to the first hostid (HSC1) in the SLILIBRY macro.
  - The assembler label (DUMMY2) preceding the third SLIDRIVS macro indicates the device numbers are being created for PANEL2, which was associated with DUMMY2 in the previous SLIDLIST macro.
  - Since DUMMY2 was the second HOSTDRV operand in the previous SLIDLIST macro, this SLIDRIVS macro applies to the second hostid (LSID) in the SLILIBRY macro. Since no device numbers are defined here in the ADDRESS parameter, host LSID is precluded from accessing PANEL2 drives.
  - Thus, tape cartridge drives in the second drive panel are available to host HSC1 but are not available to LibraryStation.

- About PANEL10:
  - The assembler label (PANEL10) preceding the third SLIDLIST macro indicates the device numbers are being created for tape cartridge drives in the panel represented by PANEL10 in the previous SLILSM macro.
  - The unique HOSTDRV operands (DUMMY3,DRV3) indicate that separate instructions for each host will be provided in the subsequent SLIDRIVS macros.
  - The assembler label (DUMMY3) preceding the fourth SLIDRIVS macro indicates the device numbers are being created for PANEL10, which was associated with DUMMY3 in the previous SLIDLIST macro.
  - Since DUMMY3 was the first HOSTDRV operand in the previous SLIDLIST macro, it applies to the first hostid (HSC1) in the SLILIBRY macro. Since no device numbers are defined here in the ADDRESS parameter, host HSC1 is precluded from accessing PANEL10 drives.
  - The assembler label (DRV3) preceding the fifth SLIDRIVS macro indicates the device numbers are being created for PANEL10, which was associated with DRV3 in the previous SLIDLIST macro.
  - Since DRV3 was the second HOSTDRV operand in the previous SLIDLIST macro, it applies to the second hostid (LSID) in the SLILIBRY macro. Thus, the device numbers that are created here in the ADDRESS parameter apply to LibraryStation only.
  - Further, since no device numbers were created in the SLIDRIVS macro for DUMMY3, drives on PANEL10 are exclusively for access by LibraryStation.

---

**Note** – Some HSC publications state that library station device numbers can be set using the HSC Set Utility with the SLISTATN option. This is a generic reference to LMU station device numbers and is **not** a reference to the LibraryStation product described in this publication. LibraryStation device numbers **cannot** be set using the SLISTATN option of the HSC Set utility.

---

---

# Configuring the LSINIT Control Statement

An LSINIT control statement must be specified in the HSC SLSSYSxx parameter data set to initialize the LibraryStation software with necessary parameters. LibraryStation cannot be initialized unless the LSINIT control statement is present.

In addition to its role in LibraryStation initialization, the LSINIT control statement contains parameter settings that define volume security, the default scratch subpool, the TCP/IP subsystem, and network call/response wait times.

Refer to the *ELS Command, Control Statement, and Utility Reference* for more information about the HSC parameter data set and control statement format.

## LSINIT Control Statement Format

Keyword parameters of the LSINIT control statement define how LibraryStation functions at your installation and provide the HSC with information about your software implementation. Keyword parameters can be specified in any order. When not specified, most keywords assume default values. LibraryStation accepts (tolerates) multiple occurrences of a keyword. The value assigned to a keyword reflects the last occurrence of a keyword within a command.

The following sample illustrates the LSINIT control statement. This example shows the two parameters required in all instances, NETHOST and COMMONSP.

```
LSINIT NETHOST(LSID) COMMONSP(SP01)
```

Keyword parameters for the LSINIT control statement are summarized in [TABLE 2-2 on page 60](#) and then described individually. NETHOST and COMMONSP are the only parameters required in all instances. These three parameters are described first. The remaining parameters are described in alphabetical order. See [“Required Keyword Parameters of LSINIT” on page 63](#).

**TABLE 2-2** LSINIT Keyword Parameters

<b>Keyword</b>	<b>Function</b>
COMMONSP	Specifies the HSC common scratch subpool name to be used as the default scratch subpool for LibraryStation
NETHOST	Specifies the LibraryStation hostid to which network drives are assigned
AUTHCLS	Specifies the SAF class that should be used with the RACROUTE mechanism if volume authorization checking is active
CMDACC	Specifies whether or not command authorization checks should be performed on a client level
COMMTYPE	Specifies which communication method(s) LibraryStation uses to communicate with clients
CREQLOG	Enables/disables logging of network client mount/dismount requests
DEFER	Allows LibraryStation initialization to be deferred
HOSTID	Specifies the hostid of the HSC system where LibraryStation is executed
LSDEF	Provides the name of a data set that contains various LibraryStation definition statements
NOPDF	Disables the Persistent Data File (PDF)
PDF	Specifies the data set name to be dynamically allocated as the Persistent Data File
PDFX	Specifies the data set name to be dynamically allocated as the path to the Persistent Data File alternate index
POOLCHK	Specifies whether or not volumes can be scratched when the wrong scratch pool is put in the network scratch request
REQTIME	Defines the amount of time after which LibraryStation drops messages waiting to be sent to clients
RETCOUNT	Defines the number of times that LibraryStation attempts to transmit a message across the network
RETTIME	Defines the minimum amount of time that LibraryStation waits between attempts to establish a network connection
SYMDESTN	Specifies the symbolic destination name that contains the transaction program name and local logical unit name that LibraryStation uses to register with APPC/MVS for SNA LU6.2 communication.
TCPNAME	Specifies any StorageTek compatible TCP/IP communications product
TCPPORT	Specifies a TCP port used for TCP/IP communications.
VOLACC	Specifies whether or not volume authorization checks should be performed on a client level
VOLAUTH	Specifies whether or not volume authorization checks should be performed on a network level

**TABLE 2-2** LSINIT Keyword Parameters (Continued)

<b>Keyword</b>	<b>Function</b>
VOLNOPRF	Specifies, for users of RACF and VOLAUTH, whether or not volumes undefined to RACF may be accessed by network clients
VSECLOG	Specifies whether or not message SLS3945I is issued to the system log when access to a volume is denied
XHREC	Enables cross host recovery support

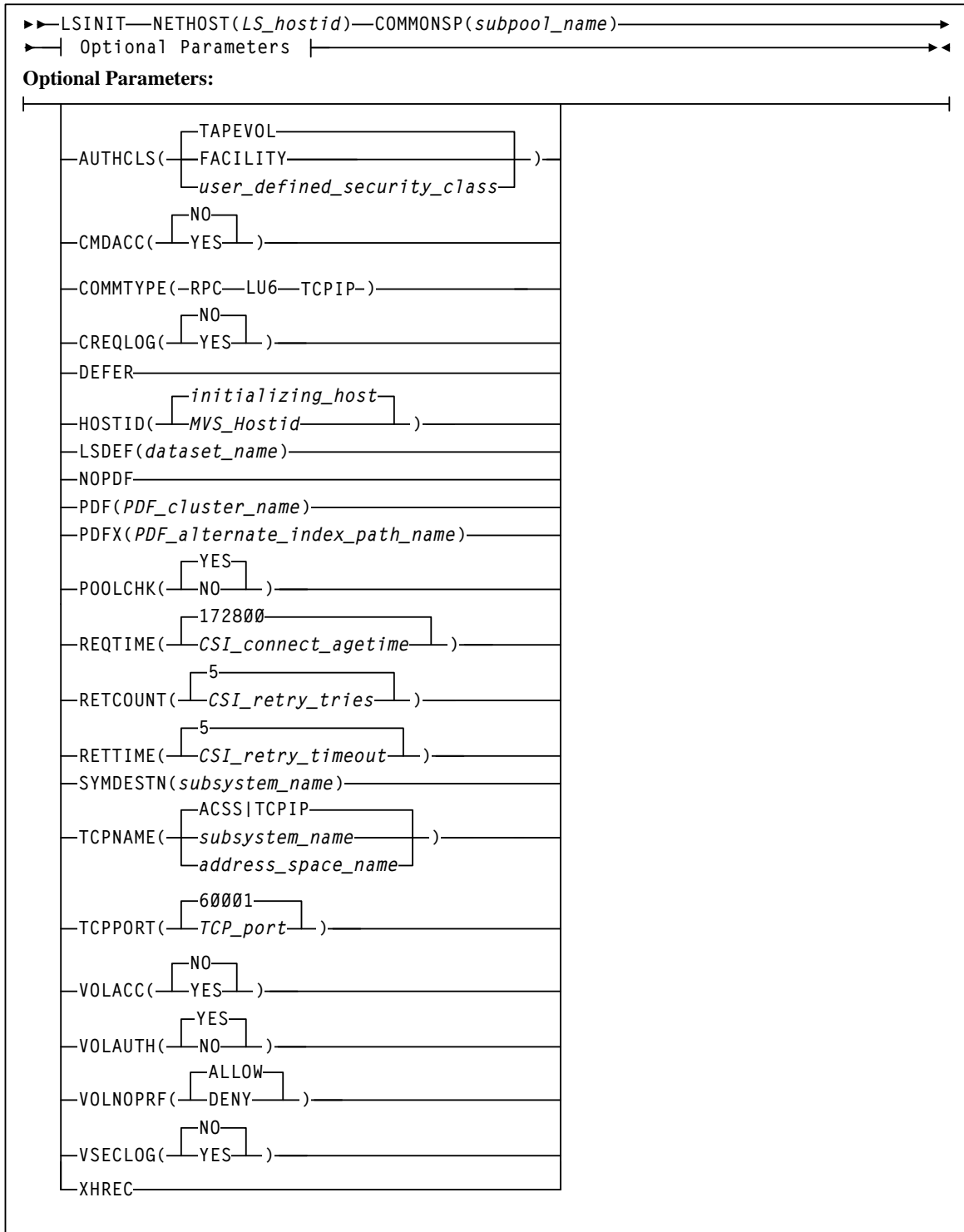

FIGURE 2-9 LSINIT Control Statement Syntax

---

**Note –**

- NETHOST and COMMONSP are the only required parameters for all installations. All others are optional, with one exception: NOPDF is required for clients that do not use drive and volume locking.
  - You can separate parameters using either blanks or commas.
  - See [“Conventions for Reader Usability” on page 17](#) for flow diagram and control statement syntax conventions.
- 

## Required Keyword Parameters of LSINIT

The required keyword parameters for the LSINIT control statement are:

### **NETHOST**(*LS\_hostid*)

Specifies the LibraryStation hostid to which network drives are attached. This parameter is required.

The hostid identified here is supplied to the HSC via the LIBGEN process (see [“Configuring the LibraryStation Hostid” on page 52](#)). The tape cartridge drives that LibraryStation uses are also identified as being attached to this hostid through the HSC LIBGEN process. LibraryStation specifies this hostid to the HSC for network drive requests.

---

**Note –** Your entry must match the LibraryStation hostid you defined in [“Configuring the LibraryStation Hostid” on page 52](#).

---

See [“Configuring Security Measures” on page 36](#) for information about how this parameter can affect LibraryStation security

### **COMMONSP**(*subpool\_name*)

Specifies the HSC scratch subpool name to be used as the default scratch pool. This parameter is required.

HSC POOLPARAM control statements define pool information for a server complex in the form of named pools of specific types.

HSC VOLPARAM statements define a volser, volser list, or volser range to be associated with the specified POOLPARAM statement.

POOLPARAM and VOLPARAM statements are defined in the SLSPARM data set, and are loaded using the SET VOLPARAM command.

If the SLSPARM data set included a POOLPARAM statement specifying NAME=LSPOOL, LSINIT would then require the keyword parameter COMMONSP(LSPOOL).

Refer to the *ELS Command, Control Statement, and Utility Reference* for more information about POOLPARAM and VOLPARAM control statements, and the SET VOLPARAM command.

If you want to map additional LibraryStation scratch pools to HSC subpools, use the LSDEF SPNUM statement to map scratch pools other than 0. See [“Scratch Pool Processing” on page 47](#).

See [“Configuring Security Measures” on page 36](#) for information about how the COMMONSP parameter can affect LibraryStation security.

## Optional Keyword Parameters of LSINIT

The optional keyword parameters for the LSINIT control statement are:

### **AUTHCLS([TAPEVOL | FACILITY | *user\_defined\_security\_class*])**

This parameter is optional. TAPEVOL is the default. It specifies the SAF class to be used with the RACROUTE mechanism if volume authorization or volume access is active. Volumes to be protected should be defined as entities in the specified SAF class. The customer can define a new security authorization class for tape volumes. If the customer does so, note that the class must be defined to the security package, added to the user SAF routing table, and activated. If all these steps are not completed, all volumes can be accessed by all clients. It is recommended that you use the VSECLOG parameter to create system log messages along with test volumes defined to the new security class to verify that volume security is working as desired.

The value for the *user\_defined\_security\_class* parameter must consist of four to eight characters. TAPEVOL or FACILITY can't be specified for this value, though derivatives of these words are valid. See [“Configuring Security Measures” on page 36](#) for more information on configuring security measures.

### **CMDACC([NO | YES])**

Specifies whether command authorization checks should be performed at a client level. These checks are issued through an IBM RACROUTE request to the System Authorization Facility (SAF). The default value is NO.

See [“Configuring Security Measures” on page 36](#) for information about how this parameter can impact LibraryStation security.

### **COMMTYPE(RPC LU6 TCPIP)**

Specifies which communication method LibraryStation uses to communicate with clients. The method can be RPC, LU6, or TCPIP. If more than one is selected, separate them with a space or comma.

- *RPC* is specified if LibraryStation will communicate with ONC/RPC clients only.
- *LU6* is specified if LibraryStation will communicate with SNA LU6.2 clients only.
- *TCPIP* is specified if LibraryStation will communicate with clients that support CSCI communications using TCP/IP communication method.

If the COMMTYPE keyword is not specified, the default is RPC.



**CREQLOG([YES | NO])**

Specifies whether or not network client mount/dismount requests are logged. If YES is specified, logging is enabled and message SLS3730I is displayed. This message identifies the network id and client userid of the client that issued the request. In addition:

- If the VOLACC LSINIT parameter is set to YES, message 3728I is displayed.

---

**Note** – VOLACC(YES) is supported only when COMMTYPE is specified as RPC or LU6.

---

- If the VOLAUTH LSINIT parameter is set to YES, message 3729I is displayed.

If the CREQLOG LSINIT parameter is set to NO, logging is disabled and no messages are displayed. The default is NO.

**DEFER**

Specifies that LibraryStation initialization is to be deferred at HSC initialization. If XHREC is also specified on the LSINIT statement, LibraryStation initializes to standby status.

LibraryStation can be started by issuing the LS INIT command. LibraryStation in standby mode can also be started by issuing the LS ACTIVATE STANDBY command or by cross host recovery communication.

See [“LSINIT Implications for Multiple MVS Host Installations” on page 69](#) for more information about situations where you may need to use DEFER.

When DEFER is not specified, LibraryStation is initialized automatically during HSC initialization.

**HOSTID(MVS\_hostid)**

Specifies the hostid of the MVS host system on which LibraryStation is executed. This host identifier is specified to the HSC via the LIBGEN process. The default is the initializing HSC hostid.

---

**Note** – In a multiple MVS host configuration, this parameter determines which host will initialize LibraryStation. If you are making LibraryStation available to more than one host system, see [“LSINIT Implications for Multiple MVS Host Installations” on page 69](#) for more information about multiple host installation planning.

---

**LSDEF(dataset\_name)**

Specifies the name of a data set that contains various LibraryStation definition statements. The name must be fully qualified and cataloged. If the data set named is a partitioned data set, the member name must also be included and the data set name should be enclosed in single quotation marks. Comment statements beginning with an asterisk in column one are not valid.

See [“Configuring the LSDEF Data Set” on page 70](#) for information about the statements that can be contained in the data set.

**NOPDF**

Disables the Persistent Data File (PDF). This keyword **must** be specified for clients that do not utilize drive and volume locking.

If the NOPDF keyword is specified, you cannot specify the PDF or PDFX keywords. The default is running with a PDF.

**PDF(*PDF\_cluster\_name*)**

Specifies the data set name to be dynamically allocated as the Persistent Data File. If PDF is specified, PDFX must also be specified. See [“Allocating the Persistent Data File” on page 50](#) for a description of the Persistent Data File.

**PDFX(*PDF\_alterate\_index\_path\_name*)**

Specifies the data set name to be dynamically allocated as the path to the Persistent Data File alternate index. If PDFX is specified, PDF must also be specified. Be sure to specify the path name to the alternate index and not the name of the alternate index itself. See [“Allocating the Persistent Data File” on page 50](#) for a description of the Persistent Data File alternate index.

**POOLCHK(*YES | NO*)**

Specifies whether a volume can be used as a scratch volume when the wrong scratch pool is specified in the request for a scratch volume. If YES is specified, the volume is checked to see if it can be made a scratch volume and assigned to the indicated scratch pool. If NO is specified, the volume is used as a scratch volume even if the scratch pool specified in the request is not the scratch pool the volume is assigned to through the HSC SCRPOOL statement. The default is YES.

**REQTIME(*CSI\_connect\_agerime*)**

Defines the amount of time (in seconds) after which LibraryStation drops messages waiting to be sent to clients. This parameter is specified only if COMMTYPE is specified as RPC.

The value for REQTIME can be any decimal integer in the range 600 - 31536000. Thus, the maximum is one year. If the value specified is outside this range, REQTIME defaults to 172800 seconds (48 hours). When an invalid REQTIME value is specified using the SET operator command, the last valid REQTIME value is used.

**RETCOUNT(*CSI\_retry\_tries*)**

Defines the number of times LibraryStation attempts to transmit a message across the network. This parameter is specified only if COMMTYPE is specified as RPC.

The value for RETCOUNT can be any decimal integer in the range 0 - 999999999. The default value is 5. Network clients should have a similar retry parameter.

**RETTIME(*CSI\_retry\_timeout*)**

Defines the minimum amount of time (in seconds) that LibraryStation waits between attempts to establish a network connection. This parameter is specified only if COMMTYPE is specified as RPC.

The value for RETTIME can be any decimal integer in the range 0 - 999999999. The default value is 5 seconds. Network clients should have a similar timeout parameter.

**SYMDESTN**(*subsystem\_name*)

Specifies the symbolic destination name that contains the transaction program name and local logical unit name that LibraryStation uses to register with APPC/MVS for SNA LU6.2 communication. The symbolic destination name must be the name of an entry in the active APPC/MVS side information file that represents LibraryStation. This parameter is used only if COMMTYPE is specified as LU6.

If the SYMDESTN keyword is not specified, the default is LIBSTAT.

See [“APPC/MVS Configuration” on page 34](#) for information about how the side information entry is built.

**TCPNAME**([*subsystem\_name* | *address\_space\_name*])

Specifies the subsystem name or address space name of the TCP/IP stack used for TCP/IP communications. Valid TCP/IP communications software includes IBM TCP/IP, CA Unicenter TCPaccess Communications Server, and CA Unicenter TCPaccess X.25. This parameter is specified only if COMMTYPE is specified as RPC or TCPIP.

*subsystem\_name* specifies the subsystem name of the TCP/IP stack that was specified during installation of the TCP/IP communications software. It must consist of one to four alphanumeric or national (#, @, \$) characters, the first character being alphabetic or national.

*address\_space\_name* specifies the address space name of the TCP/IP stack that was specified during the installation of the TCP/IP communications software. It must consist of one to eight alphanumeric or national characters.

If TCPNAME is specified, its value is used assuming it is valid. If not specified, the default value (ACSS or TCPIP) is assumed:

- ACSS is the default value for CA Unicenter TCPaccess Communications Server or CA Unicenter TCPaccess X.25.
- TCPIP is the default value for IBM TCP/IP.

---

**Note** – The LCFSSID keyword parameter is no longer supported by LibraryStation. Using this keyword will generate an error message.

---

Additionally, when the TCP/IP product specified with a TCPNAME parameter is not active, the following defaults are used:

- If the TCPLINK data set is included in the STEPLIB concatenation, TCPaccess with a default TCPNAME value of ACSS is used.
- If the TCPLINK data set is not included in the STEPLIB concatenation, IBM TCP/IP with a default TCPNAME value of TCPIP is used.

**TCPPORT**(*TCP\_port*)

Specifies a TCP port used for TCP/IP communications. This parameter is specified only if COMMTYPE is specified as TCPIP.

The value for TCPPORT must be between 1 and 65535. If the value specified is outside this range, TCPPORT takes the default value. The default value is 60001.

**VOLACC([NO | YES])**

Specifies whether volume authorization checks should be performed on a client level. These checks are issued through the IBM RACROUTE request to the System Authorization Facility (SAF). The default value is NO. For clients to use any volumes with VOLACC(YES), you must have LSDEF CLIENTID statements for those clients.

See [“Configuring Security Measures” on page 36](#) for information about how this parameter can impact LibraryStation security.

**VOLNOPRF([ALLOW | DENY])**

Specifies whether volumes not defined to RACF are allowed client read and update access. ALLOW is the default. Either VOLAUTH(YES) or VOLACC(YES) is required for the VOLNOPRF parameter to take effect.

**VOLAUTH([YES | NO])**

Specifies whether volume authorization checks should be performed on a network level. These checks are issued through the IBM RACROUTE request mechanism to the System Authorization Facility (SAF). The default value is YES.

See [“Configuring Security Measures” on page 36](#) for information about how this parameter can impact LibraryStation security.

**VSECLOG([NO | YES])**

This parameter is optional. It specifies whether message SLS3945I is issued to the system log when access to a volume is denied. NO is the default. Either VOLACC and/or VOLAUTH must be set to YES for this message to be issued.

**XHREC**

Specifies that cross host recovery be enabled. If XHREC is specified, PDF must also be specified. Only one active LibraryStation can act as a server for open system clients. Cross host recovery allows other LibraryStations to be started as standby servers for the open system clients. The first standby LibraryStation to begin initialization becomes the active LibraryStation. Subsequent LibraryStations initialize to standby status.

If the active LibraryStation terminates, a cross host communication is sent to all HSCs sharing the CDS. The first standby LibraryStation to initialize becomes the active LibraryStation. All LibraryStations that wish to access the PDF and participate in cross host recovery must specify XHREC.

Enter your LSINIT parameters on the LibraryStation Configuration Worksheet in [Appendix A](#).

## LSINIT Implications for Multiple MVS Host Installations

As previously described in “[System Redundancy Options](#)” on page 28, LibraryStation can be made available to more than one MVS host in a library complex, either by installing the software directly on each host or by installing it on DASD that is shared among the hosts.

Making LibraryStation available to more than one host is useful for system redundancy, so that LibraryStation software can be manually initiated from an alternate host if the host that normally initiates LibraryStation fails.

Each host that is capable of initializing LibraryStation to support ONC/RPC clients must have the HSC, TCP/IP, and network interface adaptor installed in addition to the LibraryStation software. Additionally, the hosts must access a common PARMLIB data set.

Each host that is capable of initializing LibraryStation to support SNA LU6.2 clients must have the HSC, APPC/MVS, and physical and logical units installed in addition to the LibraryStation software.

The HOSTID, XHREC, and DEFER parameters on the LSINIT control statement determine how LibraryStation is initialized:

- automatically to active status when the HSC is initialized on that host
- automatically to standby status
- deferred until the LSINIT command is issued

The HOSTID parameter in an LSINIT control statement for each host system determines whether LibraryStation can be initialized from that host.

The XHREC parameter enables cross host communication. The first LibraryStation to initialize becomes active. Subsequent LibraryStations initialize to standby status.

The DEFER parameter defers LibraryStation initialization to active status. When XHREC is also specified, LibraryStation initializes to standby status.

The following scenarios illustrate how this works.

- Scenario 1: A single host that is automatically initialized.

```
LSINIT NETHOST(LSID) COMMONSP(SP01) HOSTID(MVS1)
```

In this scenario, LibraryStation is initialized automatically on host MVS1 when the HSC is initialized on that host.

- Scenario 2: Two hosts, with the second host serving as an alternate host.

```
LSINIT NETHOST(LSID) COMMONSP(SP01) HOSTID(MVS1) DEFER
LSINIT NETHOST(LSID) COMMONSP(SP01) HOSTID(MVS2) DEFER
LSINIT HOSTID(MVS1)
```

In this scenario, initialization is deferred for both hosts at HSC initialization. LibraryStation is then initialized on host MVS1 by the LS INit operator command. If host MVS1 fails, host MVS2 can be initialized by an LS INit command issued by the MVS operator at that host system. Scenario #2 also applies to a situation where there are more than two hosts but only the first two are capable of initializing LibraryStation. Since there are no LSINIT statements created for MVS3, MVS4, and so on, those host systems cannot initialize LibraryStation.

---

**Note** – Even though you can enable LibraryStation to initialize on more than one host, it can only be fully initialized on one host system at a time. Also, each host that is capable of initializing LibraryStation must have access to the DASD volume where the Persistent Data File (PDF) is located.

---

If you enable LibraryStation to initialize on more than one host, you are responsible for propagating the SYSTEMS ENQ to each host. Failure to do so may corrupt the PDF when an alternate host is initialized or if two hosts attempt to initialize the software at the same time.

See [“The PDF in a Multiple Host Environment” on page 51](#) for more information about PDF requirements in a multiple host environment.

---

## Configuring the LSDEF Data Set

### Defining LSDEF File Statements

The LSDEF data set contains various LibraryStation definition statements. Valid LSDEF statements for LibraryStation use are described below. Each statement can be included as many times as necessary to define all existing items. For example, there can be an SPNUM statement for each scratch pool.

LSDEF statements are only required in the LSDEF data set under the following circumstances:

- CLIENTID statements are required if you are using volume access control or command access control.
- SPNUM statements are required if you are using scratch pools other than pool number 0 or mapping scratch pools by client.
- VIRTACS statements are required if you are allowing network clients to connect to VSM.

---

**Note** – You can include non-LibraryStation statements in the LSDEF data set, but LibraryStation ignores these statements.

---

## CLIENTID Statement

The CLIENTID statement associates a client to a System Authorization Facility (such as RACF) user identifier.

---

**Note** – The CLIENTID statement is supported only when COMMTYPE is specified as RPC or LU6.

---

### Syntax

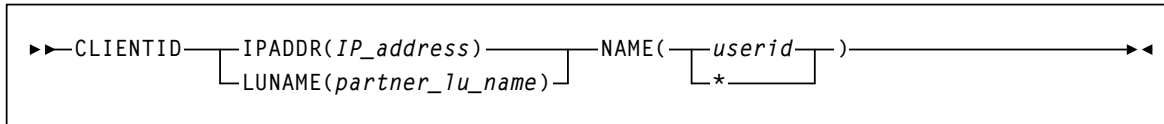

FIGURE 2-10 CLIENTID LSDEF Statement Syntax

### Parameters

#### IPADDR(*IP\_address*)

Specifies the Internet address of the primary local area network (LAN) or server. The Internet address is in standard Internet dotted decimal format (for example, 128.2.33.9). Valid values can range from 0 to 255.

#### LUNAME(*fully\_qualified\_partner\_lu\_name*)

Specifies the logical unit name of the client that communicates with LibraryStation. Specify this keyword value in the format NETID.LUNAME. The value can consist of 3 to 17 alphanumeric characters (including the decimal).

#### NAME(*userid* | \*)

Specifies the userid that determines if the client is permitted access to the resource. The NAME value can consist of one to eight alphanumeric characters or \*. If the value is specified as \*, the IPADDR or LUNAME is not translated and whatever value is in the packet in the access-id field is used for authorization checks.

Either IPADDR or LUNAME must be specified.

This association is only used when either the VOLACC or CMDACC parameter of the LSINIT statement is set to YES.

When the same client address is specified on more than one CLIENTID statement, the last statement is used. When the same userid is specified on more than one CLIENTID statement, all associated clients use the same userid.

See [“Configuring Security Measures” on page 36](#) for additional information about LibraryStation security measures.

Enter your CLIENTID parameters on the LibraryStation Configuration Worksheet in [Appendix A](#).

## SPNUM Statement

This statement equates an HSC scratch subpool with a LibraryStation scratch pool.

---

**Note** – The SPNUM statement is supported only when COMMTYPE is specified as RPC or LU6.

---

### Syntax

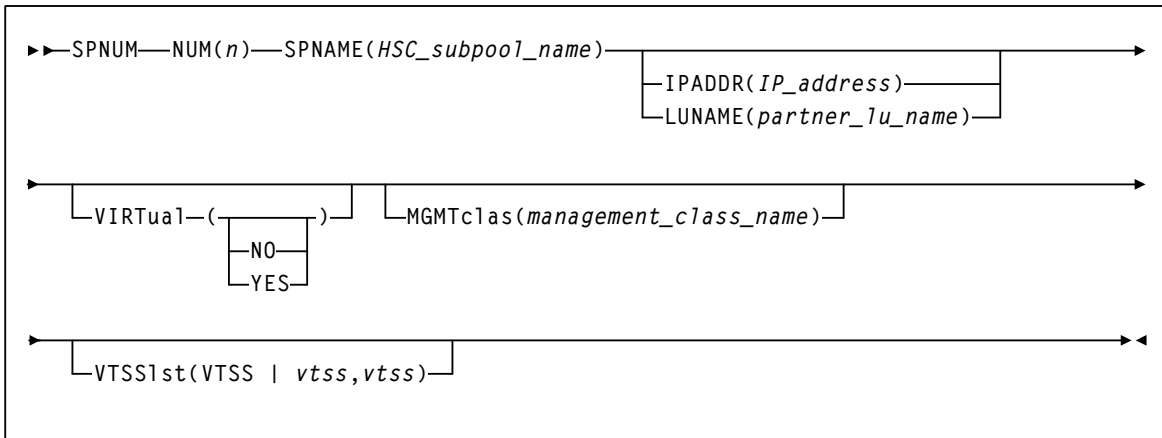

FIGURE 2-11 SPNUM LSDEF Statement Syntax

### Parameters

#### NUM(*n*)

Specifies the numeric LibraryStation scratch pool to which the HSC scratch subpool defined with a SCRPOOL command is equated to. *n* can have values from 0 to 65534.

#### SPNAME(*HSC\_subpool\_name*)

Specifies the name of the HSC scratch subpool that is to be equated to the LibraryStation scratch pool. The SPNAME value can consist of 1 to 13 characters. Blank spaces are not permitted.

#### IPADDR(*IP\_address*)

Specifies the Internet address of the primary local area network (LAN) or server. The Internet address is in standard Internet dotted-decimal format (for example, 128.2.33.9). Valid values can range from 0 to 255.

#### LUNAME(*fully\_qualified\_partner\_lu\_name*)

Specifies the logical unit name of the client that communicates with LibraryStation. Specify this keyword value in the format NETID.LUNAME. The value can consist of 3 to 17 alphanumeric characters (including the decimal).



There can be several SPNUM statements, each equating an HSC scratch subpool to a LibraryStation scratch pool. If the same value for NUM is specified on more than one SPNUM statement, the last statement is used. If the same HSC scratch subpool name is specified on more than one SPNUM statement, all the associated LibraryStation scratch pools will use the same HSC scratch subpool.

If IPADDR or LUNAME is coded, only requests from the specified client will use that scratch pool mapping. See [“Scratch Pool Processing” on page 47](#) for information about scratch pools.

### **VIRTual**

Specifies whether the subpool contains VTVs.

#### **NO**

The subpool does not contain VTVs.

#### **YES**

The subpool contains VTVs.

---

**Note** – If VIRTual is not specified, the subpool can contain both real volumes and VTVs.

---

### **MGMTclas**

Specifies the name of a Management Class you defined on the HSC MGMTclas control statement.

*managment\_class\_name*

The Management Class name.

### **VTSS**

Specifies a maximum of 16 VTSSs used to satisfy the mount request.

*vtssname1...vtssname16*

The names of up to 16 VTSSs.

Each VTSS name must correspond to a VTSS name specified on a VIRTACS statement.

## **Example**

```
SPNUM NUM(2) SPNAME(LSPOOL1)
SPNUM NUM(2) SPNAME(LSPOOL2) IPADDR(1.2.3.4)
```

In this example, the client at address 1.2.3.4 would get volumes from LSPOOL2 when referring to pool 2, and all other clients would get volumes from LSPOOL1.

Enter your SPNUM parameters on the LibraryStation Configuration Worksheet in [Appendix A](#).

## VIRTACS Statement

The VIRTACS statement defines a virtual ACS that maps to a VTSS to allow clients to connect to VSM.

### Syntax

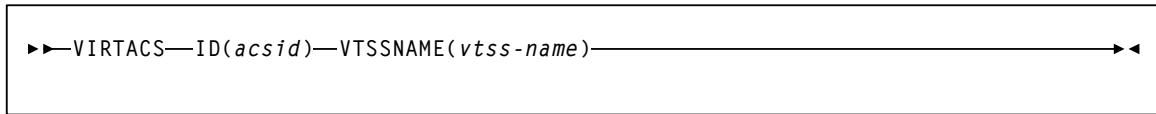

FIGURE 2-12 VIRTACS LSDEF Statement Syntax

### Parameters

#### ID

Specifies a virtual SCS ID.

*acsid*

a decimal virtual ACS ID.

#### VTSSNAME

Specifies the VTSS name that maps to the virtual ACS ID.

*vtss-name*

A VTSS name.

## Allocating the LSDEF Data Set

Once LSDEF statements are defined, you must allocate, catalog, and populate the LSDEF data set. This data set can be a sequential data set or a member of a partitioned data set (PDS).

Perform the following steps:

1. Use the following sample code to allocate and catalog the LSDEF data set.

```
//          EXEC PGM=IEFBR14
//LSDEFDD   DD DSN=SLS.LSDEF ,
//          UNIT=SYSDA,SPACE=(TRK,(1,1)),
//          DCB=(RECFM=FB,LRECL=80,BLKSIZE=3120),
//          DISP=(NEW,CATLG)
```

**FIGURE 2-13** Sample LSDEF Data Set Allocation

2. Populate the data set with the LSDEF statements you defined earlier in this chapter. Refer to the statement information you entered on the LibraryStation Configuration Worksheet in [Appendix A](#).

## Configuring the HSC Started Task Procedure

You must update the started task procedure in your system cataloged procedure library to include the LibraryStation load libraries, and if applicable, the Persistent Data File (PDF) DD statements. (Alternately, the PDF and PDFX data files can be allocated dynamically at system initialization by using the PDF and PDFX parameters of the LSINIT statement.)

---

**Note** – The LibraryStation (SLCLINK) DD statement must precede the ELS (SEALINK) data set in the STEPLIB concatenation.

---

The following example represents the base JCL shipped in the LibraryStation SAMPLIB.

```
//SLS0      PROC
//IEFPROC   EXEC PGM=SLSBINIT,
//          TIME=1440,
//          REGION=6M,
//          DPRTY=(7,5),
//          PARM='E(E086) F(23) M(00) SSYS(SLS0)'
//*
//STEPLIB   DD      DISP=SHR,DSN=SLC.SLCLINK /* LS load mods */
//          DD      DISP=SHR,DSN=SLS.SEALINK /* ELS load mods */
//          DD      DISP=SHR,DSN=SLC.SACLINK /* SAS/C load mods */
//          DD      DISP=SHR,DSN=SLC.CSLLINK /* SAS/C CSL API */
//*
//SLSPDF    DD      DISP=OLD,DSN=cluster_name
//SLSPDFX   DD      DISP=OLD,DSN=path_name
//SLSSYS00  DD      DISP=SHR,DSN=SLS.PARMS
//SLSUEXIT  DD      DISP=SHR,DSN=your.load.module.library
```

**FIGURE 2-14** Sample HSC Cataloged Procedure Updated for LibraryStation

Perform the following steps to update the started task procedure:

1. Add the LibraryStation load libraries, created during installation, to the STEPLIB DD concatenation. These include the SLCLINK and SACLINK load libraries.
2. The STEPLIB concatenation can dictate which TCP/IP communication stack is used for LibraryStation. If CA Unicenter TCPAccess TCP/IP products are to be used, the TCPLINK data set must be included. Add the following DD statement to the STEPLIB concatenation:

```
DD DSN=IOS.TCPLINK,DISP=SHR /* optional TCP */
```

---

**Note** – The TCPLINK data set must precede the SACLINK data set in the STEPLIB concatenation.

---

3. If you are using a TCP/IP product to support ONC/RPC clients, add the following DD statement to the HSC Started Task Procedure:

```
//SYSTCPD DD DSN=ddd.eee.fff(anyname)
```

This DD statement identifies the data set used to obtain parameters defined by the IBM TCPIP.DATA configuration data set. See [“ONC/RPC Support” on page 31](#) for more information.

4. Add the two DD statements required for the Persistent Data File, SLSPDF and SLSPDFX. To do this, replace *cluster\_name* and *path\_name* in the started task procedure with the same data set names you used for *cluster\_name* and *path\_name* in the PDF.

---

**Note** – Alternately, the PDF and PDFX data sets can be allocated dynamically at system initialization by using the PDF and PDFX parameters of the LSINIT statement. See [“Configuring the LSINIT Control Statement” on page 59](#) for more information.

---

5. Verify that REGION=6M or more in the IEFPROC of your started task procedure.
6. If SNA LU6.2 clients are to be supported, LibraryStation requires modules that reside in the MVS data set SYS1.CSSLIB. If SYS1.CSSLIB is not in your installation’s link list, add it to the STEPLIB DD concatenation. SYS1.CSSLIB must be an authorized data set.

## Reconfiguring the HSC LIBGEN

Earlier, in [“Configuring the LibraryStation Hostid”](#) on page 52 you modified the HSC LIBGEN in order to define the LibraryStation hostid.

However, these and any other HSC LIBGEN modifications are not effective until you reconfigure the LIBGEN. Reconfiguring the LIBGEN creates a new library control data set. This is accomplished with the MVS Start command, using the Reconfig parameter to start the HSC catalog procedure.

Refer to the publication *Configuring HSC and VTCS* for detailed information about reconfiguring the HSC LIBGEN.

---

**Note** – Some HSC publications state that library station device numbers can be set using the HSC Set Utility with the SLISTATN option. This is a generic reference to LMU station device numbers and is **not** a reference to the LibraryStation product. LibraryStation device numbers **cannot** be set using the SLISTATN option of the HSC Set utility.

---

---

# Verifying LibraryStation Configuration

Once you have completed the LibraryStation configuration tasks, you can start the LibraryStation software. See [“Starting LibraryStation” on page 129](#) for more information.

Once LibraryStation is started, you can verify LibraryStation configuration settings; the CPA, TCP/IP, and LAN as well as basic LibraryStation operation. Perform the following steps:

## Step 1: CPA, TCP/IP, and LAN Verification

Successful installation of the TCP/IP communication product, CPA, and LAN can be verified by initiating commands from other processors on the LAN. These commands could include PING and RPCINFO, which are typically implemented on LAN-connected processors.

- A PING command executed as

```
PING host
```

(where *host* is the name or Internet address of the MVS processor where LibraryStation will execute) should receive a response such as “host is active.”

- An RPCINFO command executed as

```
RPCINFO -P host
```

(where *host* is the name or Internet address of the MVS processor where LibraryStation will execute) should receive two or more responses indicating RPC program numbers, versions, protocols, and port numbers for registered RPC programs. When LibraryStation is active, its program number (300031) will be displayed.

## Step 2: LibraryStation Verification

Use the SLGDIAG installation verification program to verify basic operation of LibraryStation independent of network or client activity. SLGDIAG generates basic query, mount, and dismount requests to LibraryStation. When SLGDIAG has executed successfully, LibraryStation is considered to be ready for operation.

See [“SLGDIAG Installation Verification Program” on page 119](#) for more information about the SLGDIAG installation verification program.





# Commands

---

---

## Overview

Operator interactions in a LibraryStation environment include LibraryStation operator commands, HSC operator commands, and TCP/IP operator commands:

- LibraryStation operator commands are described in this chapter.
- HSC operator commands are described in the *ELS Command, Control Statement, and Utility Reference*.
- TCP/IP commands are described in the documentation provided by your TCP/IP vendor.

LibraryStation operator commands provide an interface for the MVS operator to start, stop, and control LibraryStation processing. This includes canceling active requests and displaying status of entries within LibraryStation.

## Relationship to HSC Commands

For LibraryStation network functions not specifically implemented as LibraryStation operator commands, there are HSC commands that perform the necessary functions, such as Mount.

LibraryStation commands are distinguished from HSC commands by the letters LS in front of the command (such as **LS START**). The command string is preceded by a site-dependent initial prefix character, such as a period. LibraryStation uses the prefix character that is defined for HSC commands in the HSC LIBGEN.

LibraryStation commands can be entered using any of the allowable HSC command formats, such as:

```
.LS START
.LS, START
.LS  START
.LS,  START
F HSC0,LS START
```

Syntax is checked when a LibraryStation command is issued by the MVS operator. If the syntax is incorrect, an error message is generated. See [Chapter 6, “Messages and Codes”](#) for specific message information.

# LibraryStation Command Summary

LibraryStation commands are summarized in the following table. Note that commands in this table are shown in mixed case; lower case letters may be omitted to form abbreviations (such as “**STO**” for the **STOp** command and “**S**” for the **Start** command).

**TABLE 3-1** LibraryStation Operator Command Summary

<b>Command</b>	<b>Function</b>
Activate Standby	Notifies standby LibraryStations to begin initialization
Cancel	Stops processing of a LibraryStation client request or operator command
CLrlock	Removes all active and pending locks from a library drive.
Display CCommand	Displays online help for specific LibraryStation commands
Display DRive	Displays the status of drives that are attached to the network served by LibraryStation
Display Request	Displays the status of all or specified active LibraryStation client requests and operator commands
Display Status	Displays the status of LibraryStation processing Idle Quiesces LibraryStation client request and operator command processing
Idle	Quiesces LibraryStation client request and operator command processing
INit	Initializes LibraryStation in the HSC address space
SEt	Changes certain LSINIT parameter values
Start	Changes LibraryStation from quiesced to fully functional
STOp	Terminates LibraryStation processing in the HSC address space
Trace	Traces LibraryStation processes
Vary DRive	Changes the state of a library drive to be available or unavailable to LibraryStation

---

# Online Help for LibraryStation Commands

Similarly to HSC, online help is available for LibraryStation commands. The LS Display Cmd operator command is used to display information about specific LibraryStation commands. For example:

```
LS DISPLAY CMD (START)
```

or

```
LS DISPLAY COMMAND (START)
```

displays information about the LS Start command.

These examples can also be abbreviated as follows:

```
LS D CM(S)
```

or

```
LS D CO(S)
```

---

## Operating States

LibraryStation has three operating states. Other than during initialization, termination, or in standby status, LibraryStation is always in one of these states:

- RUN

LibraryStation is active. This is the normal operating state. Operator commands and client requests are accepted in this state.

- IDLE PENDING

LibraryStation is in the process of quiescing. This state is entered following the issuance of a LibraryStation Idle command by the operator or an Idle request from the client. Current client requests are processed in this state. Operator commands and certain client requests (Cancel, Idle, Query, Query\_Lock, Start, and Vary) are accepted in this state. A LibraryStation Start command is required to return to RUN state from the IDLE PENDING state.

- IDLE

LibraryStation has quiesced. This state is entered after current client requests are processed in the IDLE PENDING state following the issuance of a LibraryStation Idle operator command or client request. Operator commands and certain client requests (Cancel, Idle, Query, Query\_Lock, Start, and Vary) are accepted in this state. A LibraryStation Start command is required to return to RUN state from the IDLE state.

The current operating state is identified when the Display Status operator command or Query Server client request is issued.

See [Chapter 5, “Starting and Stopping LibraryStation”](#) for information about starting and stopping the LibraryStation software.

# Command Descriptions

This section describes LibraryStation commands. Syntax, parameter descriptions, and examples are included for each command.

See [“Conventions for Reader Usability” on page 17](#) for syntax flow diagramming conventions.

## Activate Standby

The Activate Standby command notifies one or more LibraryStations in standby status to begin initialization. The first standby LibraryStation that starts initialization becomes active.

This command can be entered to any SLS subsystem with a LibraryStation in defer, standby, or active status.

### Syntax

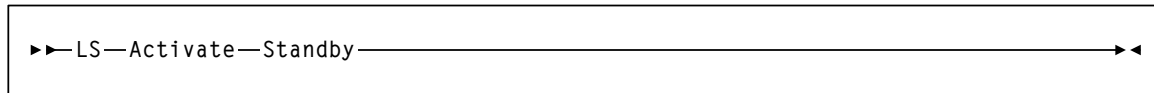

**FIGURE 3-1** Activate Standby Command Syntax

### Parameters

#### Activate

initiates the Activate command.

#### Standby

indicates a standby LibraryStation is to be activated.

### Example

```
.LS A S
```

This example requests that a standby LibraryStation become active.

### Output

A message is sent to the console where the Activate Standby command was issued. For example:

```
SLS3382I Standby LibraryStations notified
```

## Cancel

The Cancel command attempts to terminate a previous command or client application request. The specified request is stopped when LibraryStation receives the Cancel command. No attempt is made to undo any activity that was completed before the Cancel command was received.

The following requests may be cancelled:

- Eject
- Enter
- Lock
- Query
- Query\_Lock
- Set\_Scratch

## Syntax

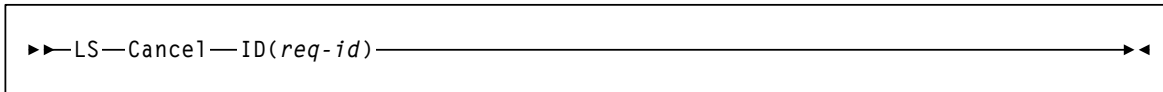

```
>>LS—Cancel—ID(req-id)
```

FIGURE 3-2 Cancel Command Syntax

## Parameters

### Cancel

initiates the Cancel command.

### ID

indicates that a specific request is to be cancelled.

*req-id*

identifies the specific request to cancel. The valid range is 1-65535.

## Example

```
.LS C ID(3128)
```

In this example, request 3128 is cancelled.

## Output

Messages are sent to the console where the Cancel command was issued. For example:

```
SLS3412I Request 3128 not cancelled; request not active
SLS3448I Cancel of request 3488 scheduled
```



## Examples

```
.LS CL DR(51F)
.LS CL DRIVEI(01:0F:10:2)
```

In these examples, all active and pending locks were removed for the following:

- Device number 51F
- Drive number-3 on panel-10, in LSM-0F, of ACS-01

## Output

Messages are sent to the console where the CLrlock command was issued. For example:

```
SLS3473I Clearlock response
Drive (51F) (00:00:00:00) Status: all locks are cleared
```

In this example, all active and pending locks were removed for Device number 51F.

```
SLS3473I Clearlock response
Drive (000) (01:0F:10:2) Status: no locks found for resource
```

In this example, no locks were found for the third drive on panel-10, in LSM-F, of ACS-01.

```
SLS3473I Clearlock response
Drive 00:00:01:00 is not configured to LS
```

In this example, an invalid drive was entered.

See [Chapter 6, “Messages and Codes”](#) for additional information about specific messages displayed.



## Display CMd

The Display CMd command displays syntax and usage information about specific LibraryStation commands.

### Syntax

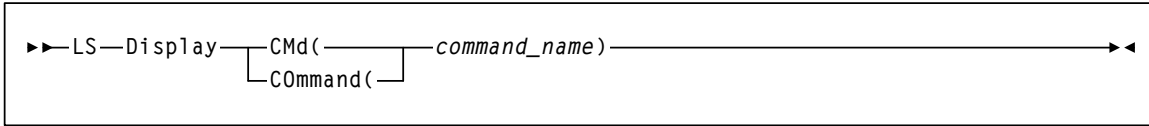

FIGURE 3-4 Display CMd Syntax

### Parameters

#### Display

initiates the Display command.

#### CMd or COmmand

indicates that a LibraryStation command follows.

#### *command-name*

specifies the name of the LibraryStation command to display information about.

---

**Note** – LibraryStation commands may be abbreviated as indicated in the syntax diagrams for each command. For example, Cancel maybe abbreviated to C.

---

### Examples

```

.LS D CM(C)
.LS D CM(D)
.LS D CO(V)
  
```

These examples display information about the LibraryStation Cancel, Display, and Vary commands.

### Output

Online help information is sent to the console where the Display CMd command was issued.

## Display DRive

The Display Drive command displays the status of the drives that are attached to the network served by LibraryStation.

---

**Note** – References to library drives in LibraryStation commands refer only to the drives as viewed from the network clients. For example, the LibraryStation Display Drive command does not display information about MVS-attached drives that are not known to the network client system.

---

### Syntax

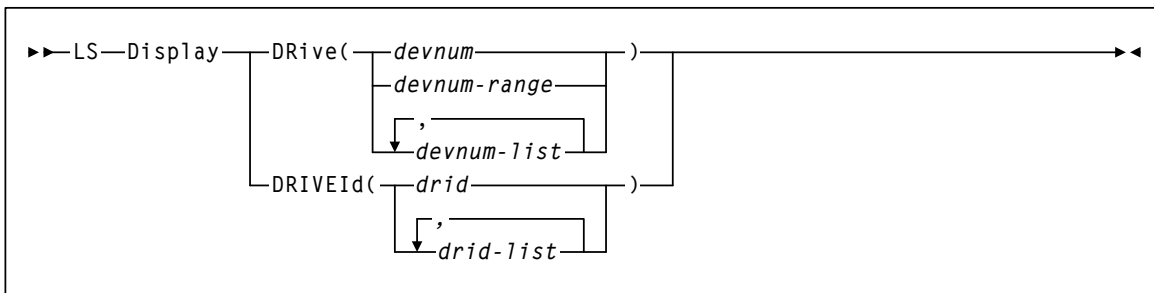

FIGURE 3-5 Display DRive Command Syntax

### Parameters

#### Display

initiates the Display command.

#### DRive

specifies that drive status is requested for specific device numbers.

*devnum* or *devnum-range* or *devnum-list*

identifies one or more device numbers to display status for.

*devnum-range* is specified as two device numbers joined by a dash.

*devnum-list* elements may be either a single device number or a range of device numbers, with each list element separated by a comma or a blank.

Device numbers are defined in the HSC LIBGEN and are composed of three or four hexadecimal characters.

A range of numbers is valid for the *devnum* format only. The range may consist of 2 to 42 valid device numbers. If a range is specified, only existing LibraryStation-defined drives are reported. If no LibraryStation drives are defined in that range, an appropriate message is issued.

## DRIVEId

specifies that drive status is requested for specific driveids.

### *drid* or *drid-list*

identifies a single driveid or a list of driveids. Driveids can be specified using the following format:

*AA:LL:PP:NN*

where:

- *AA* is the ACS number (00-7E hexadecimal)
- *LL* is the LSM number (00-23 hexadecimal)
- *PP* is the drive panel number within the LSM (1-10 decimal)
- *NN* is the relative drive number within the panel (0-19 decimal)

---

**Note** – The “Drive Worksheet” on page 92 can be used to record site-specific information needed for this command.

---

## Examples

```
.LS D DR(51F)
.LS D DR(51C-51F)
.LS D DR(51C,51D)
.LS D DRIVEI(01:0F:10:2)
```

In these examples, status is displayed for:

- Device number 51F
- A range of device numbers from 51C through 51F
- A list of device numbers 51C and 51D
- Drive number-3 on panel-10, in LSM-0F, of ACS-01

## Output

Messages are sent to the console where the Display Drive command was issued. For example:

```
SLS3472I Display drive response
Drive (051F) (00:01:10:03) Type 4490 ONLINE, available
```

See [Chapter 6, “Messages and Codes”](#) for additional information about specific messages that are displayed.



# Display Request

The Display Request command displays the status of all or selected active requests.

## Syntax

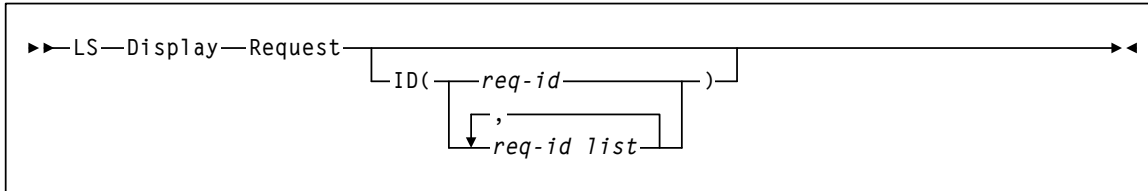

FIGURE 3-6 Display Request Command Syntax

## Parameters

### Display

initiates the Display command.

### Request

specifies that request status is to be displayed.

### ID

indicates that a specific requestid to display follows. If ID is not specified, all active and pending requests are listed.

*req-id* or *req-id list*

specifies a single request number or a list of request numbers separated by a comma or a blank. The valid range is 1-65535.

## Examples

```

.LS D R
.LS D R ID(2134)
.LS D R ID(2135,2138,2150)
  
```

In these examples, the following requests are displayed:

- All requests are displayed
- Request 2134 is displayed
- Request 2135, 2138, and 2150 are displayed

## Output

Messages are sent to the console where the Display Request command was issued. For example:

```
SLS3469I Request status  
Request 02134: command QUERY status PENDING
```

See [Chapter 6, “Messages and Codes”](#) for additional information about specific messages that are displayed.

## Display Status

The Display Status command displays the status of LibraryStation processing, including standby status and LibraryStation state (RUN, IDLE, or IDLE PENDING) and the number of current and pending requests for mounts, dismounts, enters, and ejects.

### Syntax



FIGURE 3-7 Display Status Command Syntax

### Parameters

#### Display

initiates the Display command.

#### Status

specifies that LibraryStation status is to be displayed.

### Example



This example displays LibraryStation status.

### Output

Messages are sent to the console where the Display Status command was issued. For example:

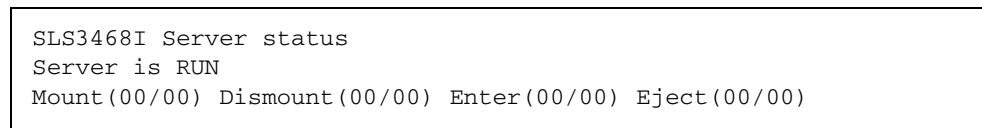

Message SLS3468I in the sample output indicates that LibraryStation is in RUN state. In other instances, this message can indicate IDLE PENDING or IDLE operating states. This message can also indicate that LibraryStation is initializing. See [“Operating States” on page 84](#) for descriptions of LibraryStation operating states.

Message SLS3468I in the sample output also indicates the number of current and pending requests for mounts, dismounts, enters, and ejects. The number to the left of “/” indicates current requests, while the number to the right of “/” indicates pending requests.

See [Chapter 6, “Messages and Codes”](#) for additional information about specific messages that are displayed.

## Idle

The Idle command quiesces processing of LibraryStation network requests.

When Idle is issued, LibraryStation moves from RUN state to IDLE PENDING state, which indicates that LibraryStation is in the process of quiescing. All current client requests are completed when LibraryStation is in this state. Operator commands and some client requests (Cancel, Idle, Query, Query\_Lock, Start, and Vary) are accepted in this state.

When all client requests have been processed in the IDLE PENDING state, LibraryStation enters IDLE state. In this state, LibraryStation has quiesced. Operator commands are accepted, as are the following client requests: Cancel, Idle, Query, Query\_Lock, Start, and Vary.

## Restarting LibraryStation After Idle

An LS Start command must be issued to return LibraryStation to its normal processing state (RUN) after an Idle command has been issued.

Use the LibraryStation Display Status command to display the current operating state.

## Syntax

```
▶▶—LS—Idle—————▶▶
```

**FIGURE 3-8** Idle Command Syntax

## Parameters

Idle

initiates the Idle command.

## Example

```
.LS I
```

This example quiesces LibraryStation request processing.



## Output

Messages are sent to the console that issued the Idle command. For example:

```
SLS3919I LS is now idle  
SLS3404I IDLE command successfully executed  
SLS3422I IDLE is currently pending
```

See [Chapter 6, “Messages and Codes”](#) for additional information about specific messages that are displayed.

## INit

The Init command initializes LibraryStation in the HSC address space.

### Syntax

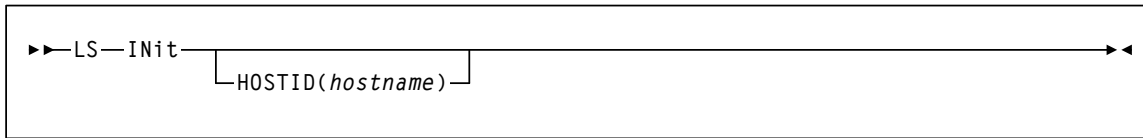

FIGURE 3-9 INit Command Syntax

### Parameters

#### INit

initiates the INit command.

#### HOSTID

specifies that the command is only to be executed if the host name identified by *hostname* matches the HSC *hostid* of the host system from which the command is executed.

#### *hostname*

identifies the host to use for HOSTID.

For systems where LibraryStation has been made available to more than one HSC host, the HOSTID (*hostname*) parameter allows you to place the Init command in the HSC PARMLIB control data set in conjunction with the LSINIT DEFER parameter.

Thus, LibraryStation can be configured to start automatically during HSC initialization on the host system identified in the HOSTID parameter. If this host system fails, the MVS operator can start LibraryStation manually on an alternate host by issuing the Init command from that host.

### Examples

```
.LS IN
.LS IN HOSTID(MVS1)
```

These examples initialize LibraryStation. The first example initializes LibraryStation on the host from which it is issued. The second example initializes LibraryStation on host "MVS1." The second example would typically be issued from within the PARMLIB control data set. (This example would have to be issued from host MVS1 to be successful.)

## Output

Messages are sent to the console where the Init command was issued. For example:

```
SLS3350I LS initialization started (V7.2.0)
SLS3128I LM has been restarted; LM state is running
SLS3247I CSI network interface state active
SLS3352I LS initialization complete
```

See [Chapter 6, “Messages and Codes”](#) for additional information about specific messages that are displayed.

## SEt

The Set command changes the values of certain LSINIT control statement parameters. Any parameter changed with the Set command will only have its new value until HSC is restarted and the LSINIT command is reprocessed.

The PDF and PDFX values are for the dynamically allocated PDF and PDFX only. If you use the Set command to display the values for the PDF and PDFX and the values are reported to be undefined, then there is no dynamic allocation and the PDF and PDFX used are specified in the startup JCL.

### After the SET Command

After the Set command is issued, the LibraryStation parameter will have the new value, and LibraryStation will begin using it. The LSDEF value is only checked when LibraryStation is initialized and doesn't take effect until LibraryStation is stopped and initialized again. However, if the HSC is restarted, this value is no longer in effect.

If the changes made by the Set command are to be permanent, changes equivalent to the Set command changes should be made to the LSINIT parameters.

To display the current value of the parameter, enter the Set command specifying the parameter without any options.

### Syntax

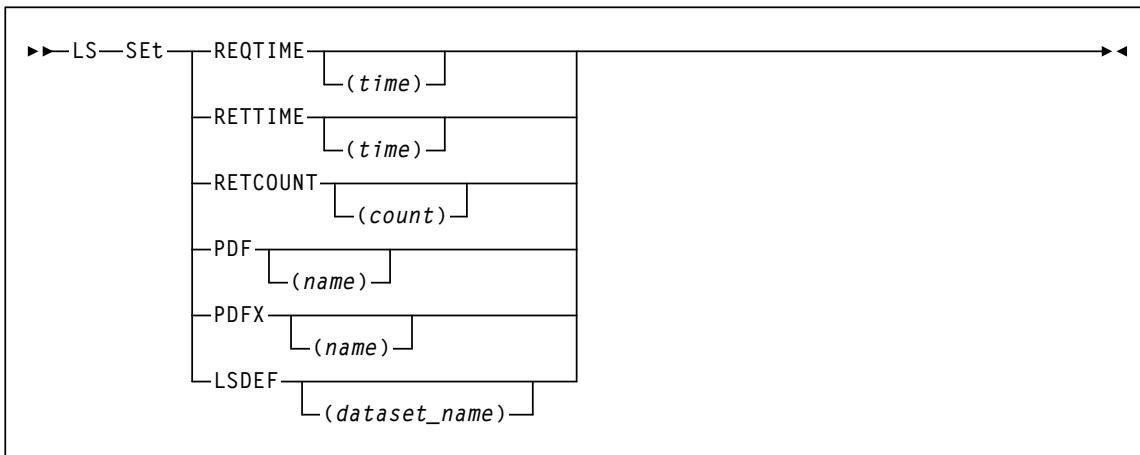

FIGURE 3-10 SEt Command Syntax

## Parameters

See [“Optional Keyword Parameters of LSINIT” on page 64](#) for a complete description of the valid values for these keywords.

## Example

```
.LS SET LSDEF  
.LS SET RETTIME(20)
```

The first example displays the current value set for LSDEF. The second example changes the minimum number of seconds that LibraryStation waits between attempts to establish a network connection.

## Output

Messages are sent to the console that issued the Set command. For example:

```
SLS3463I Current LSDEF value is MY.LSDEF.FILE  
SLS3464I RETTIME set to 20
```

See [Chapter 6, “Messages and Codes”](#) for additional information about specific messages that are displayed.

## Start

The Start command changes the state of LibraryStation from quiesced (IDLE or IDLE PENDING) to fully functional (RUN).

### Restarting LibraryStation After Idle

A LibraryStation Start command must be issued to return LibraryStation to its normal processing state (RUN) after an Idle command has been issued.

Use the LibraryStation Display Status command to display the current operating state.

### Syntax

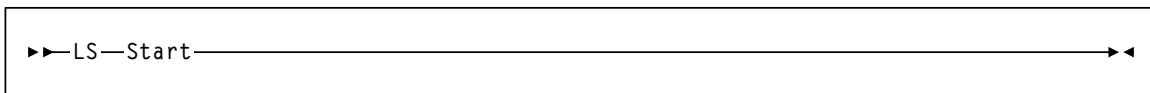

```
▶—LS—Start—————▶◀
```

FIGURE 3-11 Start Command Syntax

### Parameters

#### Start

initiates the Start command.

### Example



```
.LS S
```

This example starts LibraryStation after it has been quiesced.

### Output

Messages are sent to the console where the Start command was issued. For example:

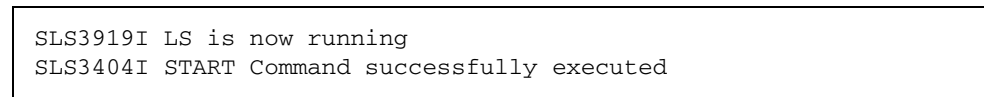

```
SLS3919I LS is now running  
SLS3404I START Command successfully executed
```



## Examples

```
.LS STO  
.LS STO FORCE
```

These examples terminate LibraryStation. The second example terminates LibraryStation immediately.

## Output

Messages are sent to the console where the Stop command was issued. For example:

```
SLS3919I LS is now IDLE  
SLS3361I LS termination started  
SLS3362I LS termination complete  
SLS3368I LS stopped
```

See [Chapter 6, “Messages and Codes”](#) for additional information about specific messages that are displayed.



## Trace

The Trace command traces LibraryStation processes, including detailed startup and termination data, network client requests and responses, error conditions, state changes, and operator command requests.

---

**Note** – The LibraryStation Trace command is generally not used by customers except at the request of StorageTek Support personnel while diagnosing a problem. It is only included here with the standard operator commands so that you will have reference information available if you are instructed to run Trace.

---

The LibraryStation Trace command uses the MVS Generalized Trace Facility (GTF) through the HSC. Consequently, several MVS and HSC procedures must be performed before LibraryStation tracing can work properly. See “Tracing” on page 118 for more information about tracing prerequisites.

## Syntax

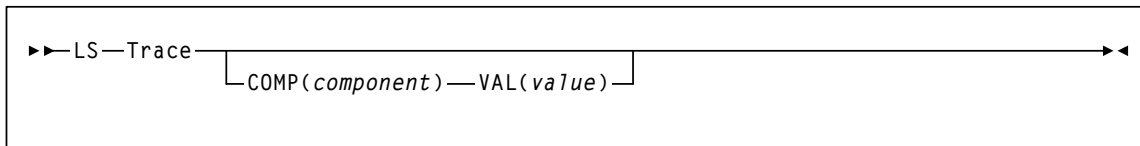

FIGURE 3-13 Trace Command Syntax

## Parameters

### Trace

initiates the Trace command. If no other parameters are specified, the current LibraryStation component trace settings are displayed.

### COMP

indicates that a character component to trace will be identified next.

#### *component*

A single component identifier or a list of component identifiers to use for the trace command. The component identifiers are as follows:

CAP	CAP Request Processor
CL	Common Library
CSCI	Client Server Communication Interface
CSI	Client System Interface
DB	Persistent Data File Manager
HIF	HSC Interface
IF	Information Manager
IT	Initialization/Termination

LM	Library Manager
LO	Lock Manager
MT	Mount Request Processor
QU	Query Request Processor
SA	System Administrator
SCR	Scratch Request Processor
VA	Vary Request Processor

**VAL**

indicates that a trace map bit value will be identified next.

*value*

The following values are the same for each component:

00000000	Turns off tracing for the specified component
80000000	Module entry and exit. The GTF record identifier is D001 for module entry, D002 for module exit. <b>Warning:</b> This value can impact system performance.

Some components and processors also trace various stages or inputs/outputs during their processing, as described below.

The CAP processor also provides trace information that contains the CAP request packet.

40000000	CAP request packet. The GTF record identifier is D500.
20000000	CAP response packet. The GTF record identifier is D501.

The CL component provides trace information containing IPC information.

40000000	IPC information. The GTF record identifier for IPC open is D150; IPC transmit is D151; IPC read is D152.
20000000	XCF information. The GTF record identifier for XCF open is D153; XCF transmit is D154; XCF read is D155.

The CSCI component provides the following trace information:

40000000	Important variable values for all CSCI sub components.
08000000	Entry/Exit for the PER component.
04000000	Important variable values for the PER component.
00800000	Entry/Exit for the LU6 component.
00400000	Important variable values for the LU6 component.
00200000	All CPI/C calls issued by the LU6 component.
00080000	Entry/Exit for the XDR component.
00040000	Important variable values for the XDR component.
00008000	Entry/Exit for the CIF component.
00004000	Important variable values for the CIF component.
00000800	Entry/Exit for the IPC component.
00000400	Important variable values for the IPC component.

The CSI component traces various processing information described below.

20000000	Signal received. GTF record identifier is D752.
10000000	CSI initiation. GTF record identifier is D753.
08000000	CSI termination. GTF record identifier is D754.
04000000	Request packet arrival from the network interface. GTF record identifier is D755.
02000000	Response packet sent to the network interface. GTF record identifier is D756.
00400000	CSI state change. GTF record identifier is D759.
00200000	Miscellaneous communications data area information. GTF record identifier is D75A.

The LM component provides the following trace information:

40000000	Entry parameters. GTF record identifier is D351.
20000000	Signal received. GTF record identifier is D352.
10000000	LM initialization. GTF record identifier is D353.
08000000	LM termination. GTF record identifier is D354.
04000000	Request received from the CSI component. GTF record identifier is D355.
02000000	Request received from the SA component. GTF record identifier is D356.
01000000	Request received from LibraryStation. GTF record identifier is D357.
00800000	Request processor creation. GTF record identifier is D358.
00400000	LM state change. GTF record identifier is D359.
00200000	Request processor termination. GTF record identifier is D35A.

The MT processor provides tracing information for request and response packets.

00000001	Mount request packet. GTF record identifier is D600.
00000010	Mount response packet. GTF record identifier is D601.

The IF component provides the following trace information packets:

40000000	ACS record. GTF record identifier is D250.
20000010	LSM record. GTF record identifier is D251.
10000000	CAP record. GTF record identifier is D252.

The HIF component provides the following trace information packet.

40000000	Trace point record. GTF record identifier is D100 for BEFORE HSC call, D101 for AFTER HSC call. Module name and offset are needed from the trace record to determine HSC call.
----------	--

If any trace value is set for a specific component, GTF record type D000 will also be produced if the component has provided for its issuance. The D000 trace record consists of one word that indicates how many words of data follow.

## Example

```
.LS T COMP(IT) VAL(80000000)
```

This example traces module entry and exit for the LibraryStation Initiation/Termination (IT) component.

## Output

LibraryStation messages are sent to the console that issued the Trace command. For example:

```
SLS3470I Trace command status
LS trace mask 80000000 set for IT component
```

Trace output data is sent to the GTF Trace data set for use by StorageTek Support.

See [Chapter 6, "Messages and Codes"](#) for additional information about specific messages that are displayed.

## Vary DRIve

The Vary Drive command varies the state of a library drive as seen by the network.

---

**Note** – References to library drives in LibraryStation commands refer only to the drives as viewed from the network clients. LibraryStation does not affect MVS-attached drives. For example, the LibraryStation Vary Drive command does not perform an MVS Vary of the drive.

---

### Syntax

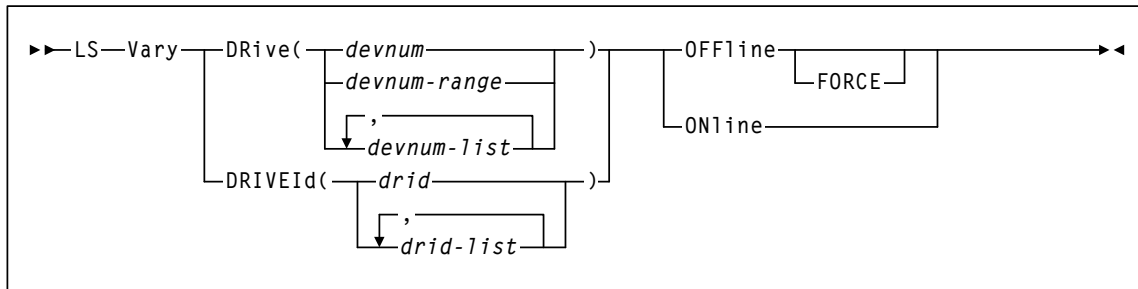

FIGURE 3-14 Vary DRIve Command Syntax

### Parameters

#### Vary

initiates the Vary command.

#### DRIve

specifies that a drive state change is requested for specific device numbers.

##### *devnum*

specifies that drive status is requested for specific device numbers.

##### *devnum or devnum-range or devnum-list*

identifies one or more device numbers to display status for.

*devnum-range* is specified as two device numbers joined by a dash.

*devnum-list* elements may be either a single device number or a range of device numbers, with each list element separated by a comma or a blank.

Device numbers are defined in the HSC LIBGEN and are composed of three or four hexadecimal characters.

A range of numbers is valid for the *devnum* format only. The range may consist of 2 to 42 valid device numbers. If a range is specified, only existing LibraryStation-defined drives are reported. If no LibraryStation drives are defined in that range, an appropriate message is issued.

**DRIVEId**

specifies that a drive state change is requested for specific driveids.

*drid or drid-list*

identifies a single driveid or a list of driveids. Driveids can be specified using the following format:

*AA:LL:PP:NN*

where:

- *AA* is the ACS number (00-7E hexadecimal)
- *LL* is the LSM number (00-23 hexadecimal)
- *PP* is the drive panel number within the LSM (1-10 decimal)
- *NN* is the relative drive number within the panel (0-19 decimal)

---

**Note** – Site-specific information required for this command was recorded on the “Drive Worksheet” on page 92.

---

**OFFline**

makes the drive unavailable for requests from LibraryStation network clients.

**FORCE**

forces the drive offline immediately, even if the drive is in use (as shown by the Display Drive command). This parameter is only valid for OFFLINE requests and should only be used after determining that the device is not in use.

**ONline**

makes the drive available for requests from LibraryStation network clients.

**Examples**

```
.LS V DR(51F) ON
.LS V DR(51C-51F) OFF
.LS V DR(51C,51D) ON
.LS V DRIVEI(01:0F:10:2) OFF FORCE
```

In these examples, the following devices are varied:

- Device number 51F is varied online
- A range of device numbers from 51C through 51F is varied offline
- A list of device numbers 51C and 51D are varied online
- Drive number-3 on panel-10, in LSM-0F, of ACS-01 is forced offline immediately

## Output

Messages are sent to the console where the Vary Drive command was issued. For example:

```
SLS3471I Vary command status  
Drive (051F) (00:00:09:00) varied ONLINE
```

See [Chapter 6, “Messages and Codes”](#) for additional information about specific messages that are displayed.



## Administration and Maintenance

---

This chapter describes ongoing system administration and maintenance procedures, including:

- Administration procedures to change the number of tape cartridge drives available to LibraryStation or add LibraryStation to additional MVS hosts.
- Administration procedures to modifying LibraryStation operating characteristics in the LSINIT control statement.
- Maintenance procedures that may be required to recover from a hardware or software failure during LibraryStation operation.
- Diagnostic tools you may use or that StorageTek Support personnel may ask you to use in the event of system failures or performance problems.

---

### System Administration

This section describes administrative procedures you may perform as your LibraryStation system hardware and software configurations change. The following administrative scenarios are discussed:

- Making additional tape cartridge drives available to LibraryStation
- Making existing tape cartridge drives unavailable to LibraryStation
- Modifying LSINIT Operating Characteristics

## Making Additional Tape Cartridge Drives Available to LibraryStation

The number of tape cartridge drives that can be accessed by LibraryStation was initially established during LibraryStation configuration. However, As your system requirements change, you may need to make additional drives available for network mounts and dismounts.

---

**Note** – See “[Configuring Security Measures](#)” on page 36 before making additional tape cartridge drives available to LibraryStation.

---

Tape cartridge drives are made available to LibraryStation through the HSC LIBGEN. You must modify one or more macros in the LIBGEN to make additional tape cartridge drives available to LibraryStation.

Specifically, you need to modify the SLIDLIST macro for the drive panel containing the tape cartridge drives you wish to make available to LibraryStation. If new device numbers are being created, you must also create new SLIDRIVS macros containing those device numbers.

For example, suppose the HSC LIBGEN contains the following macros:

```

SLILIBRY HOSTID=(HSC1,LSID)
PANEL2  SLIDLIST HOSTDRV=(DRV1,DUMMY1)
DRV1    SLIDRIVS ADDRESS=(410,411,412,413)
DUMMY1  SLIDRIVS ADDRESS=(,,,)

```

In this example, drives in PANEL2 are available to hostid HSC1 but not to LibraryStation (hostid LSID). If you wish to make the drives in PANEL2 available to LibraryStation but unavailable to HSC1, modify the SLIDLIST macro as follows:

```

PANEL2  SLIDLIST HOSTDRV=(DUMMY1,DRV1)

```

The drive panel is now available only to LibraryStation.

When you have finished modifying HSC LIBGEN macros, you may need to reconfigure the LIBGEN:

- If the changes only involved changing device numbers in SLIDRIVS macros, you can use the Set utility (SLIDRIVS option) to implement the changes.
- If the changes involved more than simply changing device numbers, you must reconfigure the LIBGEN using the MVS Start command with the Reconfig parameter in the PROC.

Refer to the *ELS Programming Reference* for detailed information about individual HSC macros, the Set utility, and the reconfiguration process.

---

**Note** – Some HSC publications state that library station device numbers can be set using the HSC Set Utility with the SLISTATN option. This is a generic reference to LMU station device numbers and is **not** a reference to the LibraryStation product described here. LibraryStation device numbers **cannot** be set using the SLISTATN option of the HSC Set utility.

---

## Making Existing Tape Cartridge Drives Unavailable to LibraryStation

The number of tape cartridge drives that can be accessed by LibraryStation was initially established during LibraryStation configuration. As your system requirements change, you may need to make existing drives unavailable for network mounts and dismounts.

Tape cartridge drives are made available to LibraryStation through the HSC LIBGEN. You must modify one or more macros in the LIBGEN to make existing tape cartridge drives unavailable to LibraryStation.

Specifically, you need to modify the SLIDLIST macro for the drive panel containing the tape cartridge drives you want to make unavailable to LibraryStation.

For example, suppose the HSC LIBGEN contains the following macros:

```
SLILIBRY HOSTID=(HSC1,LSID)
PANEL2 SLIDLIST HOSTDRV=(DRV1,DRV1)
```

This macro indicates that the drive panel is available to both hostids in the SLILIBRY macro. To make the drive panel represented as PANEL2 unavailable to LibraryStation, replace the operand in the same position as the hostid LSID in the SLILIBRY macro with a dummy operand, such as DUMMY1. For example:

```
PANEL2 SLIDLIST HOSTDRV=(DRV1,DUMMY1)
```

Then add a new SLIDRIVS macro for the dummy operand, with no device numbers assigned. For example:

```
DUMMY1 SLIDRIVS ADDRESS=(,,)
```

The drive panel is now available only to the hostid that occupies the first position in the SLILIBRY HOSTDRV parameter.

When you have finished modifying HSC LIBGEN macros, you may need to reconfigure the LIBGEN:

- If your changes only involved changing device numbers in SLIDRIVS macros, you can use the Set utility (SLIDRIVS option) to implement the changes.
- If the changes involved more than simply changing device numbers, you must reconfigure the LIBGEN using the MVS Start command with the Reconfig parameter in the PROC.

Refer to the *ELS Programming Reference* for detailed information about individual HSC macros, the Set utility, and the reconfiguration process.

---

**Note** – Some HSC publications state that library station device numbers can be set using the HSC Set Utility with the SLISTATN option. This is a generic reference to LMU station device numbers and is **not** a reference to the LibraryStation product described here. LibraryStation device numbers **cannot** be set using the SLISTATN option of the HSC Set utility.

---

## Modifying LibraryStation Operating Characteristics

LibraryStation operating characteristics can be modified in several ways:

- Any LSINIT parameter can be changed by updating the LSINIT statements and then restarting the HSC.

See [“Configuring the LSINIT Control Statement” on page 59](#) for information about changing LSINIT parameters.

- Several LSINIT parameters (such as LSDEF) can be temporarily changed with the Set command but the changes are not effective until LibraryStation is stopped and re-initialized. These changes remain in effect until the HSC is restarted.
- Other LSINIT parameters (REQTIME, RETTIME, RETCOUNT) can be temporarily changed with the Set command and the changes are effective immediately. These changes remain in effect until the HSC is restarted.
- The Persistent Data File (PDF) can be modified at any time, but these changes are not effective until LibraryStation is stopped and re-initialized.
- See [“Allocating the Persistent Data File” on page 50](#) for information about changing the PDF file.
- The LSDEF parameter file can be modified at any time, but these changes are not effective until LibraryStation is stopped and re-initialized.

See [“Configuring the LSDEF Data Set” on page 70](#) for information about changing the LSDEF files.

# LibraryStation Diagnostic Tools

Several diagnostic tools are included with or are available to LibraryStation, including the following:

- Logging of high-level events to the MVS SYSLOG file
- Tracing of detailed system-level information through the MVS Generalized Trace Facility (GTF)
- LibraryStation system analysis independent of network or client activity through the SLGDIAG installation verification program
- Network and client system analysis through diagnostic tools supplied by the TCP/IP communications product and network client systems

Each tool is described in this section.

## Logging

Logging is the recording of high-level information and is meant for customer information and initial debugging. Activities that are logged during LibraryStation operation provide an audit trail of information that is useful in determining the state of LibraryStation during problem occurrences.

Information about LibraryStation initialization, termination, error conditions, and state changes is logged continuously in the MVS SYSLOG file. The message prefix SLS3 identifies LibraryStation events in the file, as shown in the figure below.

---

**Note** – The HSC also outputs messages for LibraryStation events. These messages appear with LibraryStation messages in the SYSLOG file.

---

```
08.14.55 STC 2998 >SLS0000I LS D S
08.14.57 STC 2998 >SLS3416I Server is RUN
08.14.57 STC 2998 >SLS3417I Mount(00/00) Dismount(00/00) Enter(00/00) Eject(00/00)
08.15.02 STC 2998 >SLS0000I LS D DR(A30)
08.15.03 STC 2998 >SLS3467I Drive(A30)(00:00:00)(00:00:09:00) Type 4480 ONLINE, avail
08.15.33 STC 2998 >SLS0000I LS D R
08.15.34 STC 2998 >SLS3418I Request 00003: command QUERY status PENDING
08.15.44 STC 2998 >SLS0000I LS I
08.15.44 STC 2998 >SLS3919I LS is now IDLE
08.15.44 STC 2998 >SLS3404I IDLE command successfully executed
08.15.54 STC 2998 >SLS0000I LS S
08.15.54 STC 2998 >SLS3919I LS is now running
08.15.54 STC 2998 >SLS3404I START command successfully executed
```

**FIGURE 4-1** Sample SYSLOG Output

## Tracing

LibraryStation generates trace information that can be recorded in the MVS Generalized Trace Facility (GTF) along with HSC trace information.

Detailed system-level information is traced, including startup and termination data, network client requests and responses, error conditions, state changes, and operator command requests.

---

**Note** – Normally, you will only activate tracing when requested to do so by StorageTek Support personnel. Current HSC procedures for collecting GTF trace information and forwarding it to StorageTek Support are also applicable for LibraryStation.

---

LibraryStation tracing is dynamically invoked with the LS Trace command. However, since tracing requires the GTF software and also relies on HSC tracing facilities, the following procedures must be performed before LibraryStation tracing can work properly:

1. GTF must be started to create GTF output for events.  
Refer to the *ELS Programming Reference* for more information about using GTF.
2. The HSC Trace command must be run with the component name LS (such as TRACE LS) to make tracing available to LibraryStation.  
Refer to the *ELS Command, Control Statement, and Utility Reference* for more information about the HSC Trace command.

When GTF is started and the TRACE LS command has been issued, the LibraryStation Trace command can be run. The trace records for LibraryStation are user GTF records. An eventid is assigned to the HSC, and the HSC assigns an internal subtype designation. Specific subtypes are assigned for use by LibraryStation.

For MVS/ESA, trace information collected with GTF is extracted and printed using the IBM IPCS utility with the GTFTRACE subcommand. For MVS/XA, the AMDPRDMP utility serves this purpose.

See [“Trace” on page 105](#) for information about the specifics of running the LibraryStation Trace command.

## SLGDIAG Installation Verification Program

The SLGDIAG installation verification program verifies basic LibraryStation operation independent of network or client activity. SLGDIAG generates basic query, mount, and dismount requests to LibraryStation.

The LibraryStation requests are generated by a program executable as a batch job on the MVS server processor and passed to LibraryStation.

---

**Note** – Though SLGDIAG is specified for use as a batch program invoked through JCL, you could choose to make SLGDIAG available as a started task or as a TSO-startable program.

---

SLGDIAG requires the use of an available tape drive and tape cartridge and must be executed on the same MVS host system where LibraryStation is initialized. You may choose to dedicate a tape cartridge to this purpose to make SLGDIAG a readily-available operator tool.

SLGDIAG exercises LibraryStation using the following interfaces

- ONC/RPC interface through TCP/IP
- SNA LU6.2 interface using APPC/MVS
- TCP/IP (CSCI)

For this reason, TCP/IP or APPC/MVS (depending on which interface is used) must be operational, though it need not be in actual contact with an external network.

---

**Note** – The following example displays the basic format of the code needed to perform this procedure. For best results, use the sample JCL contained in the data set defined by the SLCSAMP SMP/E DDDEF, member name SLGDJCL

---

```
//SLGDIAG JOB ( installation options )
//*
/** THIS JOB RUNS LIBRARYSTATION DIAGNOSTICS PGM
/** ----- SLGDIAG -----
//RUNDIAG EXEC PGM=SLGDIAG ,
// PARM='diag_keywords'
//STEPLIB DD DISP=SHR,DSN=high_level_index.SLCLINK
// DD DISP=SHR,DSN=high_level_index.SACLINK
// DD DISP=SHR,DSN=high_level_index.CSSLINK
//SYSPRINT DD SYSOUT=A
//SYSIN DD diag_keywords_file
=COMMTYPE=RPC|LU6|TCPIP
=DRIVE=drv
=VOLUME=vol
/*
```

**FIGURE 4-2** JCL for SLGDIAG Installation Verification Program

---

**Note** –

- Add the following DD statement if SNA LU6.2 is a supported client through APPC/MVS:  
DD DSN=SYS1.CSSLIB,DISP=SHR  
SYS1.CSSLIB must be an authorized data file.
- Add the following DD statement if CA Unicenter TCPaccess TCP/IP products are used:  
DD DSN=IOS.TCPLINK,DISP=SHR  
The TCPLINK data set must precede the SACLINK data set.
- Add the following DD statement if IBM TCP/IP is used to support ONC/RPC clients:  
//SYSTCPD DD DSN=*ddd.eee.fff*(anyname)

The SLGDIAG *diag\_keywords* may be specified in either the EXEC PARM statement or they may be provided in a file.

- If *diag\_keywords* are specified in the EXEC PARM statement, the SYSIN DD statement in the JCL example is not required.
- If the *diag\_keywords* are specified in the EXEC PARM statement, the keywords are separated by blanks.
- If the *diag\_keywords* are provided in a file (or in the JCL input stream), each keyword must be specified on a separate line, beginning in column-1.
- All *diag\_keywords* must be immediately preceded and followed by an equal sign (=). Lines that do not begin with equal will be ignored.
- The value to be assigned to the keyword is provided immediately to the right of the keyword's trailing equal sign.



- The SLGDIAG keyword parameters can be specified in any order.
  - Keywords may not contain imbedded blanks.
  - If any of the keywords are specified more than once, the last specification is the one that is used.
  - Sequence numbers in a keyword file are not allowed. SLGDIAG will not accept these lines.
  - If you misspell a keyword, the keyword's default is assumed.
-

## SLGDIAG Supported Keywords

The following keywords are supported by SLGDIAG:

### **=VOLUME=*vol***

Specifies the volume to be mounted and dismounted. This keyword is required (except with VSM). There is no default.

### **=DRIVE=*drv***

Specifies the drive on which the volume is mounted. The drive is specified in the format *aa,ll,pp,d*, where *aa* is the ACS number, *ll* is the LSM number, *pp* is the panel number, and *d* is the relative drive number on the panel. This keyword is required. There is no default.

### **=COMMTYPE=*RPC | LU6 | TCPIP***

Specifies which communication method(s) to use to communicate with LibraryStation. This keyword is optional. The default is *RPC*.

- If *RPC* is specified, SLGDIAG uses TCP/IP communications to send messages to LibraryStation.
- If *LU6* is specified, SLGDIAG uses APPC/MVS to send messages to LibraryStation.
- If *TCPIP* is specified, SLGDIAG uses TCP/IP (CSCI) communications to send messages to LibraryStation.

### **=TCPIPTEST=*YES | NO***

This keyword enables you to test your LibraryStation TCP/IP configuration. Unlike other SLGDIAG keywords, this keyword can be included in an SLGDIAG job submitted prior to starting LibraryStation. This keyword is optional. The default is *NO*.

- If *YES* is specified, SLGDIAG tests your LibraryStation TCP/IP configuration.
- If *NO* is specified, this test is disabled.

### **=TCPNAME=*comm\_service\_name***

Specifies the TCP/IP communications service. The keyword specified must match the TCPNAME parameter specification on the LSINIT statement. This keyword is optional and is used only when =COMMTYPE=*RPC* or *TCPIP*.

### **=TCPPORT=*TCP\_port***

Specifies a TCP port used for TCP/IP communications. This keyword is optional and is used only when =COMMTYPE=*TCPIP*.

The value for TCPPORT must be between 1 and 65535. If the value specified is outside this range, TCPPORT takes the default value of 60001.

### **=SYMDESTN=*sym\_dest\_name***

Specifies the symbolic destination name that represents the transaction program and local logical unit that LibraryStation uses to register with APPC/MVS. The symbolic designation name must be the name of an entry in the active APPC/MVS side information file that represents LibraryStation. See [“APPC/MVS Configuration” on page 34](#) for information about how the side information entry is built. This keyword is optional and is used only if =COMMTYPE=*LU6*. The default is LIBSTAT.

**=VIRTUAL\_DRIVE=*acsid,lsmid,panelid,driveid***

Specifies a virtual drive (VTD).

You can use SLGDIAG to verify LibraryStation operation with VSM in either of the following ways:

- To verify LibraryStation operation with only VSM (but not with HSC), specify the =VIRTUAL\_DRIVE= parameter to query the specified VTD.
- To verify LibraryStation operation with VSM and HSC in the same batch job, specify the =VIRTUAL\_DRIVE= parameter and also the existing =DRIVE= and =VOLUME= parameters (which request a mount/dismount on the specified Nearline transport).

The volume and transport information supplied to SLGDIAG are turned into valid LibraryStation ONC/RPC or SNA LU6.2 requests. These requests are forwarded to LibraryStation and the responses from LibraryStation to these requests are recorded.

A return code of 00, 04, 08, or 12 is returned by the SLGDIAG job step, indicating:

- (RC=00) The test completed successfully.
- (RC=04) The test failed because of a parameter error or request failure.
- (RC=08) The test failed because of a LibraryStation or HSC software error, an abend, or process failure.
- (RC=12) The test failed because of a network communication error.

Additional information about test failure is logged on the SYSPRINT data set. If SLGDIAG fails, refer to the SYSPRINT data set for messages that will help you determine the reason for the failure. Then correct the problem and run SLGDIAG again.

## Network Diagnostic Tools

The TCP/IP communication product and the client processor(s) together contain tools to validate access to LibraryStation. While not strictly part of the LibraryStation product, these tools are necessary to diagnose the total library environment.

For example, network-attached clients should be able to use PING and RPCINFO to verify communications over the LAN through the CPA to the TCP/IP communication product.

- A PING command executed as

```
PING host
```

(where host is the name or Internet address of the MVS processor where LibraryStation will execute) should receive a response such as "host is active."

- An RPCINFO command executed as

```
RPCINFO -P host
```

(where host is the name or Internet address of the MVS processor where LibraryStation will execute) should receive two or more responses indicating RPC program numbers, versions, protocols, and port numbers for registered RPC programs. When LibraryStation is active, its program number (300031) will be displayed.

If APPC/MVS is used, the MVS DISPLAY APPC and DISPLAY NET commands can be used as an aid in problem determination. APPC/MVS and VTAM console messages can contain vital information necessary to identify and correct problems. It is also possible to run VTAM traces and format them using IPCS.

---

## LibraryStation Failure Recovery

In a failure situation, The primary responsibility of LibraryStation is to maintain the consistency of internal data so that it can be retrieved during failure recovery.

After a system failure, LibraryStation software is automatically reinstated after HSC recovery has completed. The LibraryStation software performs self-recovery procedures to return LibraryStation to an operable state.

Operator intervention is required in a failure situation only if LibraryStation or component software fails during recovery processing, or if an ACS library component must be placed offline due to a hardware failure.

If an unrecoverable failure of the LibraryStation software occurs, issue the LS STOP operator command, followed by the LS INIT operator command. If this does not correct the problem, the HSC can be terminated to Base Service Level and then brought up to Full Service Level.

## Persistent Data File (PDF) Failure Recovery

After an HSC failure, the PDF alternate index may lose synchronization with its base cluster if an I/O between the two was in progress when the abend occurred.

LibraryStation notifies you of this condition by generating error message SLS3300I during initialization. This message indicates that PDF indexes cannot be accessed or have become unsynchronized. See [Chapter 6, “Messages and Codes”](#) for detailed information regarding this message. LibraryStation cannot be successfully initialized until the condition is corrected.

Perform the following steps to recover from a PDF software error:

---

**Note** – The PDF must not be currently allocated to the HSC address space. Consequently, you must terminate the HSC to Base Service Level before performing this procedure.

---

1. Rebuild the PDF indexes.

The JCL in [FIGURE 4-3 on page 126](#) can be used to rebuild PDF indexes. This JCL is a **representation** of the code you will need to perform this procedure. It may not be the most accurate or most recent representation available. For best results, refer to the sample JCL contained in the data set defined by the SLCSAMP SMP/E DDDEF. The member name is SLGDBNX.

2. Initialize the HSC and LibraryStation.

- If initialization is successful, continue with your normal operation.
- If LibraryStation cannot be initialized because the PDF problem has not been corrected, continue with the next step.

3. If rebuilding the PDF indexes did not correct the problem, you will need to redefine the PDF as you did during LibraryStation installation. Refer to the publication *Installing ELS* for information on defining the PDF data sets. Note that the server’s lock information is lost when you rebuild the PDF.

The JCL in [FIGURE 4-4 on page 127](#) can be used to redefine the PDF. This JCL is a **representation** of the code needed to perform this procedure. It may not be the most accurate or most recent representation available.

If you must redefine the PDF, be sure to set site-specific variables (such as NAME, VOLUMES, and RECORDS variables) to their previous values. Refer to the publication *Installing ELS* for site-specific information you may need for this step.

4. After you have redefined the PDF, initialize the HSC and LibraryStation.

- If initialization is successful, continue with your normal operation
- If LibraryStation cannot be initialized because the PDF problem has not been corrected, continue with the next step

5. If reallocating the PDF does not correct the problem, you likely have a hardware problem in the device where the PDF is physically located. In this case, you must reallocate the PDF on a different volume. Be sure to set site-specific variables the same as they were previously, except for the VOLUME field. Enter the volser for the new DASD volume where the PDF is to be allocated in the VOLUME field.

```

//SLGDBNX JOB job card info
//*
/* NOTE: IDCAMS BLDINDEX will attempt to do an internal sort.
/*      If there is insufficient virtual storage it may be
/*      necessary to add IDCUTx DD statements.  See IBM
/*      Access Method Services manual for more details.
/*
//BLDNDX   EXEC PGM=IDCAMS
//SYSPRINT DD SYSOUT= *
//SYSIN    DD *
    DELETE (alternate_index_name) AIX
    DEFINE ALTERNATEINDEX (
        NAME(alternate_index_name)
        RELATE(cluster_name)
        KEYS(10 2)
        RECORDS(2000,4000)
        RECORDSIZE(27 27)
        VOLUMES(volser)
        UNIQUEKEY
        UNIQUE
        UPGRADE )
    DEFINE PATH (
        NAME(path_name)
        PATHENTRY(alternate_index_name))
    BLDINDEX
        INDATASET(cluster_name)
        OUTDATASET(alternate_index_name)
    LISTCAT ENTRIES(
        cluster_name
        alternate_index_name
        path_name) ALL
/*

```

**FIGURE 4-3** JCL for Rebuilding PDF Indexes

```

//SLGDBCR JOB job card info
//*
/* NOTE: A minimum of 1 Meg of virtual storage is needed
/* for this job, i.e., use REGION=1M on the job card
/*
//CREATEDB EXEC PGM=IDCAMS
//SYSPRINT DD SYSOUT=*
//INPUT DD *
000000000000 DB INITIALIZATION RECORD
//SYSIN DD *
DELETE (cluster_name) CLUSTER
DEFINE CLUSTER (
  NAME(cluster_name)
  VOLUMES(volser)
  RECORDS(2000,4000)
  RECORDSIZE(30 100)
  KEYS(12 0)
  UNIQUE )
REPRD INFILE(INPUT)
      OUTDATASET(cluster_name)
DEFINE ALTERNATEINDEX (
  NAME(alternate_index_name)
  RELATE(cluster_name)
  KEYS(10 2)
  RECORDS(2000,4000)
  RECORDSIZE(27 27)
  VOLUMES(volser)
  UNIQUEKEY
  UNIQUE
  UPGRADE )
DEFINE PATH (
  NAME(path_name)
  PATHENTRY(alternate_index_name)
BLDINDEX
  INDATASET(cluster_name)
  OUTDATASET(alternate_index_name)
LISTCAT ENTRIES (
  cluster_name
  alternate_index_name
  path_name) ALL

```

**FIGURE 4-4** JCL for Redefining the PDF

## Cross Host Recovery

Cross host recovery provides a standby server for open system clients, eliminating the need to manually start another LibraryStation when the active LibraryStation is terminated.

With cross host recovery enabled, at termination, the active LibraryStation notifies the standby LibraryStation(s). The first standby LibraryStation to receive the request becomes the active LibraryStation for open system clients. See [“Configuring the LSINIT Control Statement” on page 59](#) for more information about cross host recovery and the XHREC LSINIT parameter.



# Starting and Stopping LibraryStation

---

This chapter includes information for stopping and Starting LibraryStation.

---

## Starting LibraryStation

LibraryStation requires an LSINIT control statement in order to initialize. This control statement is established in the HSC SLSSYSxx parameter data set during LibraryStation installation and configuration.

Depending on site-specific LSINIT control statement parameters, LibraryStation can be initialized in any of the following ways:

- Automatically, during the HSC initialization process
- Manually, when the LibraryStation LS Init operator command is issued after HSC initialization
- Via cross host request, when the LibraryStation is in standby status and the active LibraryStation supporting cross host recovery terminates

---

**Note** – If LibraryStation is installed on or made available to more than one host system through shared DASD, initialization can occur from any host system authorized by the LSINIT control statement parameters to start LibraryStation.

---

If syntax errors occur on the LSINIT statement or in processing the options data sets indicated by parameters on the LSINIT statement, error messages will be generated. When an error message is encountered, see [Chapter 6, “Messages and Codes”](#) for specific message information.

LibraryStation initialization proceeds to a state in which network and/or operator requests for LibraryStation services can be processed. Any resources required by LibraryStation are allocated, checks are made to insure that Communication Interface is available, and interfaces to HSC are checked for operability.

The following conditions cause LibraryStation to be aborted:

- Resources Unavailable

LibraryStation could not acquire the necessary resources for successful initialization. The SYSLOG is updated with the error condition and LibraryStation terminates.

- Startup Parameter Errors

Errors in the startup LSINIT statement cause LibraryStation to terminate. The SYSLOG is updated with the error condition and LibraryStation terminates.

The following conditions cause LibraryStation to be functionally degraded when initialized:

- ONC/RPC Unavailable

Network communications are unavailable due to an inability to register ONC/RPC services. LibraryStation periodically attempts to register ONC/RPC services.

- MVS/APPC Unavailable

Network communications are unavailable due to an inability for LibraryStation to register with MVS/APPC. This would normally indicate that the MVS/APPC address space is not active. LibraryStation periodically attempts to register with MVS/APPC.

---

## Stopping LibraryStation

LibraryStation can be terminated in either of the following ways:

- Automatically, when HSC is terminated or changed to base level
- Manually, by the MVS operator using the LibraryStation LS Stop command

At termination, communication with network clients is discontinued and resources acquired by LibraryStation are returned to the operating system. All outstanding requests and replies are allowed to complete, except when the LS Stop command includes a Force parameter.

Significant events that occur during termination are recorded in the SYSLOG. The log records the start of termination as well as subsequent events.

LibraryStation processing of operator commands is stopped. The SYSLOG records the start of termination. If an error should occur during termination, the error is recorded in the SYSLOG and termination continues. When termination completes, LibraryStation resources are returned to the operating system, and a termination complete message is recorded in the SYSLOG.

If cross host recovery support is specified, the active LibraryStation issues an LS initialization request to all other active HSC subsystems during termination. The first standby LibraryStation to begin initialization becomes the active LibraryStation.

# Messages and Codes

---

---

## Overview

This chapter provides information about messages and codes issued by LibraryStation. This information is provided to help system programmers and operators:

- initialize Librarystation
- monitor LibraryStation activity
- diagnose and correct LibraryStation problems
- keep LibraryStation running correctly

## Message Format

LibraryStation system messages help you interpret and respond to the informational, diagnostic, and error messages issued by LibraryStation during operation.

Messages are displayed on the console in the following format:

```
SLSnnnnx message-text
```

where:

- SLS identifies LibraryStation
- *nnnn* is a four-digit message identifier
- *x* is a message type identifier, as follows:
  - D = decision
  - E = error
  - I = information
  
- *message-text* is the actual text displayed on the job log or system log.

---

**Note** – The HSC Display Message facility can also be used to display information about LibraryStation messages. For example, the command D MSG (3999) displays information about message SLS3999I.

---

---

## Message Descriptions

This chapter provides a description for each SMC message. In addition to the message number and message text, this description includes the following:

### **Explanation**

The explanation describes the message.

### **System Action**

The system action describes how LibraryStation reacts when a message-triggering event occurs.

### **User Response**

The user response describes how the user should respond to the message. In many cases, no response is required.

# Variable Definitions

*Italicized* text indicates variable data that is replaced by actual values when messages are issued. Message-specific information is symbolized as follows:

**TABLE 6-1** Variable Data Definitions

<b>Variable Data</b>	<b>Definition</b>
<i>AA</i>	ACSid
<i>AA:LL</i>	CAPid or LSMid location (ACSid and LSMid or CAPid)
<i>AA:LL:PP:DD</i>	Drive location (ACSid, LSMid, panel, device number)
<i>AA:LL:PP:RR:CC</i>	Cartridge location (LSMid, panel, row and column)
<i>C</i>	Variable information (character data)
<i>ddd.ddd.ddd.ddd</i>	Indicates dotted-decimal form used for Internet addresses
<i>D</i>	Indicates a decimal value
<i>volser</i>	Volume serial number
various letters (i.e., C, E, F, etc.)	Variable information (character data)
<i>X</i>	Indicates a hexadecimal value
{ }	Indicates available choices
[ ]	Indicates an optional field (may not appear in message)

---

# Message Listing

The following messages are listed numerically.

## **SLS3000I**

variable message text

**Explanation:** Contains variable message text that can be used as a diagnostic aid.

**System Action:** None.

**User Response:** None.

## **SLS3101I**

Unexpected status *SSSSSSSS* for command *CCCCCCCC*

**Explanation:** An unexpected status *SSSSSSSS* during acknowledgment or response processing was detected for command *CCCCCCCC*.

**System Action:** Acknowledgment or response is NOT sent to the client issuing the command. LibraryStation processing continues.

**User Response:** If the problem persists, contact StorageTek Software Support.

## **SLS3102I**

Unexpected task creation failure on request *RRRRRRRR*, RC = *EEEEEEEE*

**Explanation:** .LibraryStation was unable to create a task to process request *RRRRRRRR*. System return code (errno) was *EEEEEEEE*.

**System Action:** The task is not created for request *RRRRRRRR*, and the request is rejected. LibraryStation processing continues.

**User Response:** If the problem persists, contact StorageTek Software Support.

## **SLS3103I**

Unexpected index *IIIIIIII* for command *CCCCCCCC*

**Explanation:** During LibraryStation termination, an outstanding request *CCCCCCCC* caused an invalid table index *IIIIIIII* to be found.

**System Action:** LibraryStation termination continues.

**User Response:** If the problem persists, contact StorageTek Software Support.

## **SLS3104I**

Failed to allocate IPC mechanism, RC = *EEEEEEEE*

**Explanation:** LibraryStation was unable to create an IPC mechanism for processing a request. The IPC creation return code was *EEEEEEEE*.

**System Action:** The request is rejected. LibraryStation processing continues.

**User Response:** If the problem persists, contact StorageTek Software Support.

**SLS3105I**

Invalid address AAAAAAAAAA for message

**Explanation:** LibraryStation cannot send a response back to IPC socket address AAAAAAAAAA.

**System Action:** The response is not sent. LibraryStation processing continues.

**User Response:** If the problem persists, contact StorageTek Software Support.

**SLS3106I**

Invalid search direction DDDDDDDD

**Explanation:** LibraryStation request table search received an invalid search direction DDDDDDDD.

**System Action:** The request currently being processed is rejected. LibraryStation processing continues.

**User Response:** If the problem persists, contact StorageTek Software Support.

**SLS3107I**

Invalid exit status SSSSSSSS returned from process id PPPPPPPP

**Explanation:** LibraryStation detected an exiting request process PPPPPPPP with an invalid exit status SSSSSSSS.

**System Action:** LibraryStation processing continues.

**User Response:** If the problem persists, contact StorageTek Software Support.

**SLS3108I**

Invalid message identifier IIIIIIII

**Explanation:** LibraryStation detected an invalid message identifier IIIIIIII while processing the final or intermediate response for the request.

**System Action:** The response message is not sent. LibraryStation processing continues.

**User Response:** If the problem persists, contact StorageTek Software Support.

**SLS3109I**

Invalid terminate flag FFFFFFFF

**Explanation:** LibraryStation received an invalid terminate flag FFFFFFFF during termination.

**System Action:** LibraryStation termination continues.

**User Response:** If the problem persists, contact StorageTek Software Support.

**SLS3110I**

Unable to access queue member MMMMMMMM

**Explanation:** LibraryStation detected an inaccessible queue member MMMMMMMM during request processing.

**System Action:** The current request is rejected. LibraryStation processing continues.

**User Response:** If the problem persists, contact StorageTek Software Support.

**SLS3111I**

Unable to delete queue member *MMMMMMMM*

**Explanation:** LibraryStation detected a queue member *MMMMMMMM* during request processing that could not be deleted.

**System Action:** LibraryStation processing continues.

**User Response:** If the problem persists, contact StorageTek Software Support.

**SLS3112I**

Unable to find matching queue member to process id *PPPPPPPP*

**Explanation:** LibraryStation was unable to find the matching queue member after process id *PPPPPPPP* terminated.

**System Action:** LibraryStation processing continues.

**User Response:** If the problem persists, contact StorageTek Software Support.

**SLS3113I**

Unable to create request queue *QQQQQQQQ*

**Explanation:** LibraryStation was unable to create queue *QQQQQQQQ*.

**System Action:** Processing for the current request is terminated. LibraryStation processing continues.

**User Response:** If the problem persists, contact StorageTek Software Support.

**SLS3114I**

Received null pointer to request packet

**Explanation:** LibraryStation detected a bad request pointer during request processing.

**System Action:** Processing for the current request is terminated. LibraryStation processing continues.

**User Response:** If the problem persists, contact StorageTek Software Support.

**SLS3115I**

Blank socket name for message destination

**Explanation:** LibraryStation cannot send a response back to a blank IPC socket.

**System Action:** The response message is not sent. LibraryStation processing continues.

**User Response:** If the problem persists, contact StorageTek Software Support.

**SLS3116I**

Message sequence out of order; final already received

**Explanation:** LibraryStation detected a message sequence out of order during request response processing.

**System Action:** The additional response is not sent to the request submitter. LibraryStation processing continues.

**User Response:** If the problem persists, contact StorageTek Software Support.



**SLS3117I**

Unexpected error *EEEEEEEE*; LM terminating

**Explanation:** The LibraryStation Library Manager (LM) detected an unrecoverable error during request processing.

**System Action:** The Library Manager terminates. LibraryStation will attempt to recover.

**User Response:** If the problem persists, contact StorageTek Software Support.

**SLS3118I**

Unexpected LM state *SSSSSSSS*; LM terminating

**Explanation:** The LibraryStation Library Manager (LM) detected an invalid system state.

**System Action:** The Library Manager terminates. LibraryStation will attempt to recover.

**User Response:** If the problem persists, contact StorageTek Software Support.

**SLS3119I**

Final response generated for *CCCCCCCC*; status *SSSSSSSS* sent to *RRRRRRRR*

**Explanation:** LibraryStation sent status *SSSSSSSS* for command *CCCCCCCC* to socket *RRRRRRRR* during completion processing.

**System Action:** LibraryStation processing continues.

**User Response:** If the problem persists, contact StorageTek Software Support.

**SLS3120I**

Unexpected exit status *SSSSSSSS* from command *CCCCCCCC*

**Explanation:** LibraryStation detected an invalid status *SSSSSSSS* from a request process for command *CCCCCCCC*.

**System Action:** LibraryStation processing continues.

**User Response:** If the problem persists, contact StorageTek Software Support.

**SLS3121I**

Transmission of message to itself on socket *SSSSSSSS*

**Explanation:** LibraryStation detected an attempt to send a request packet to itself on socket *SSSSSSSS*.

**System Action:** The request packet is not sent. LibraryStation processing continues.

**User Response:** If the problem persists, contact StorageTek Software Support.

**SLS3122I**

Residual request RRRRRRRR detected: queue QQQQQQQQ, process id PPPPPPPP

**Explanation:** LibraryStation detected a nonreturning process for request RRRRRRRR in queue QQQQQQQQ. The nonreturning process had process id PPPPPPPP.

**System Action:** A final response is sent to the request originator. LibraryStation processing continues.

**User Response:** If the problem persists, contact StorageTek Software Support.

**SLS3123I**

Error in request queue QQQQQQQQ; queue recreated

**Explanation:** LibraryStation detected an abnormal queue condition in queue QQQQQQQQ.

**System Action:** The request queue is recreated. LibraryStation processing continues.

**User Response:** If the problem persists, contact StorageTek Software Support.

**SLS3124I**

Inconsistencies found in request queue QQQQQQQQ corrected

**Explanation:** LibraryStation detected an inconsistency in queue QQQQQQQQ.

**System Action:** The inconsistent queue is corrected. LibraryStation processing continues.

**User Response:** If the problem persists, contact StorageTek Software Support.

**SLS3125I**

Unexpected member identifier IIIIIIII

**Explanation:** LibraryStation detected an abnormal request table queue member IIIIIIII.

**System Action:** The unexpected queue member is removed from the queue. LibraryStation processing continues.

**User Response:** If the problem persists, contact StorageTek Software Support.

**SLS3126I**

Unexpected status SSSSSSSS for request member MMMMMMMM

**Explanation:** LibraryStation detected an unexpected status SSSSSSSS during request completion processing for queue member MMMMMMMM.

**System Action:** The member is removed from the request queue. LibraryStation processing continues.

**User Response:** If the problem persists, contact StorageTek Software Support.

**SLS3128I**

LM has been restarted; LM state is RUN

**Explanation:** The LibraryStation Library Manager (LM) was restarted. The current state is RUN.

**System Action:** LibraryStation processing continues.

**User Response:** None.

**SLS3129I**

Queue access for member *MMMMMMMM* failed

**Explanation:** The LibraryStation Library Manager (LM) detected an abnormal request queue accessing member *MMMMMMMM*.

**System Action:** The Library Manager terminates. LibraryStation will attempt to recover.

**User Response:** If the problem persists, contact StorageTek Software Support.

**SLS3130I**

Process *CCCCCCCC* terminated; status *SSSSSSSS*, process id *PPPPPPPP*

**Explanation:** LibraryStation detected an exiting process for command *CCCCCCCC* with status *SSSSSSSS*.

**System Action:** LibraryStation processing continues.

**User Response:** If the problem persists, contact StorageTek Software Support.

**SLS3131I**

Exit status *SSSSSSSS* received from *CCCCCCCC*, process id *PPPPPPPP*

**Explanation:** LibraryStation detected an exiting process for command *CCCCCCCC* with status *SSSSSSSS*.

**System Action:** LibraryStation processing continues.

**User Response:** If the problem persists, contact StorageTek Software Support.

**SLS3132I**

*CCCCCCCC* process failed to start up

**Explanation:** LibraryStation detected a process creation failure for command *CCCCCCCC*.

**System Action:** The failed process is removed. LibraryStation processing continues.

**User Response:** If the problem persists, contact StorageTek Software Support.

**SLS3134I**

Query request not found on request queue

**Explanation:** LibraryStation was unable to find the request queue member for a query server request.

**System Action:** The query server request is not processed. LibraryStation processing continues.

**User Response:** If the problem persists, contact StorageTek Software Support.

**SLS3201I**

Unmapped previously registered RPC service

**Explanation:** LibraryStation is registering as an RPC service but was already registered. The previous registration is dropped.

**System Action:** LibraryStation processing continues.

**User Response:** None.

**SLS3202I**

Creation of RPC TCP service failed

**Explanation:** LibraryStation was attempting to assign port, socket, and transport identifiers for RPC TCP services and was unable to do so.

**System Action:** LibraryStation continues to attempt the assignation every 30 seconds.

**User Response:** Verify that all software required for network communications has been initiated.

**SLS3203I**

Registration of RPC TCP service failed

**Explanation:** LibraryStation was unable to register as an RPC TCP service.

**System Action:** LibraryStation continues to attempt to register every 30 seconds.

**User Response:** Verify that all software required for network communications has been initiated.

**SLS3204I**

Creation of RPC UDP service failed

**Explanation:** LibraryStation was attempting to assign port, socket, and transport identifiers for RPC UDP services and was unable to do so.

**System Action:** LibraryStation continues to attempt the assignation every 30 seconds.

**User Response:** Verify that all software required for network communications has been initiated.

**SLS3205I**

Registration of RPC UDP service failed

**Explanation:** LibraryStation was unable to register as an RPC UDP service.

**System Action:** LibraryStation continues to attempt to register every 30 seconds.

**User Response:** Verify that all software required for network communications has been initiated.

**SLS3206I**

Initiation of CSI failed

**Explanation:** LibraryStation was unable to initialize the CSI component. The initialization failed due to conditions other than the network interface service.

**System Action:** LibraryStation CSI attempts to initialize five times. If the CSI is unable to initialize, LibraryStation terminates.

**User Response:** Contact StorageTek Software Support.

**SLS3207I**

Creation of connect queue failed

**Explanation:** The LibraryStation CSI connection queue could not be created.

**System Action:** LibraryStation CSI initiation fails.

**User Response:** Contact StorageTek Software Support.

**SLS3208I**

Creation of network output queue failed

**Explanation:** The LibraryStation CSI network output queue could not be created.

**System Action:** LibraryStation CSI initiation fails.

**User Response:** Contact StorageTek Software Support.

**SLS3209I**

Queue member locate failed for CCCCCC queue, member DDDDD

**Explanation:** LibraryStation was attempting to locate a member of a queue and was unable to do so.

**System Action:** The member of the queue is ignored. LibraryStation processing continues.

**User Response:** None.

**SLS3210I**

Queue member deletion failed for CCCCCC queue, member DDDDD

**Explanation:** LibraryStation was attempting to delete a member of a queue and was unable to do so.

**System Action:** The member of the queue is ignored.

**User Response:** None.

**SLS3211I**

Operating system error DDDDD

**Explanation:** A system routine failure occurred.

**System Action:** LibraryStation processing continues.

**User Response:** Contact StorageTek Software Support.

**SLS3212I**

Unexpected signal received, value *DDDDD*

**Explanation:** LibraryStation received an undefined signal.

**System Action:** The signal is ignored.

**User Response:** None.

**SLS3213I**

Invalid RPC procedure number

**Explanation:** The LibraryStation CSI detected an invalid RPC procedure number.

**System Action:** The request is ignored.

**User Response:** None.

**SLS3215I**

RPC reply to client request message failed

**Explanation:** An attempt to acknowledge a client request message failed.

**System Action:** LibraryStation processing continues.

**User Response:** None.

**SLS3216I**

RPC TCP client connection failed, reason *CCCCCCCC*, address *DDDDDDDDDD*, port *DDDDDDDD*

**Explanation:** The LibraryStation CSI attempted to connect with the client but failed.

**System Action:** LibraryStation continues to attempt to connect every 30 seconds.

**User Response:** Verify that all software required for network communications has been initiated.

**SLS3217I**

RPC UDP client connection failed, reason *CCCCCCCC*, address *DDDDDDDDDD*, port *DDDDDDDD*

**Explanation:** The LibraryStation CSI attempted to connect with the client but failed.

**System Action:** LibraryStation continues to attempt to connect every 30 seconds.

**User Response:** Verify that all software required for network communications has been initiated.

**SLS3218I**

Invalid network protocol

**Explanation:** LibraryStation determined that the client request was neither UDP or TCP protocol.

**System Action:** LibraryStation ignores the client request.

**User Response:** Verify that TCP or UDP protocol is being used for client requests.

**SLS3219I**

Queue creation failure

**Explanation:** The LibraryStation CSI connection queue could not be initialized.

**System Action:** LibraryStation CSI initiation fails.

**User Response:** Contact StorageTek Software Support.

**SLS3220I**

Queue member status request failed for CCCCCCCC queue, member  
DDDDD

**Explanation:** LibraryStation was attempting to locate a member of a queue and was unable to do so.

**System Action:** The member of the queue is ignored.

**User Response:** None.

**SLS3221I**

Queue member insert request failed for CCCCCCCC queue, member  
DDDDD

**Explanation:** LibraryStation was attempting to add a member to a queue and was unable to do so.

**System Action:** The new member is discarded.

**User Response:** None.

**SLS3222I**

Cleanup of CCCCCCCC queue, member DDDDD removed

**Explanation:** LibraryStation has removed a member from a queue that has aged beyond the time specified by the REQTIME keyword on the LSINIT initialization parameter statement.

**System Action:** LibraryStation processing continues.

**User Response:** None.

**SLS3223I**

Undefined message has been discarded

**Explanation:** LibraryStation received a message packet that was too small or that was undefined to LibraryStation.

**System Action:** LibraryStation discards the message packet.

**User Response:** None.

**SLS3225I**

Message for unknown client discarded

**Explanation:** LibraryStation received a message packet for an unknown client.

**System Action:** LibraryStation discards the message packet.

**User Response:** None.

**SLS3227I**

Cannot read message from LM

**Explanation:** The LibraryStation CSI was unable to read a message packet from the Library Manager (LM).

**System Action:** LibraryStation ignores the message packet.

**User Response:** None.

**SLS3228I**

Cannot send message to network, reason CCCCCCCC, address  
DDDDDDDDDD, port DDDDD

**Explanation:** LibraryStation attempted to send a message packet to the network but was unable to do so.

**System Action:** The message packet is discarded.

**User Response:** None.

**SLS3230I**

XDR message translation failure

**Explanation:** LibraryStation attempted to translate a field of a client message and failed.

**System Action:** LibraryStation ignores the message.

**User Response:** None.

**SLS3231I**

Error freeing XDR argument memory

**Explanation:** LibraryStation attempted to free memory containing XDR arguments and failed.

**System Action:** LibraryStation processing continues.

**User Response:** Contact StorageTek Software Support.

**SLS3232I**

Dropping queue message, address DDDDDDDDDDD, port DDDDD,  
identifier DDDDD, protocol DDDDD, connect type DDDDD

**Explanation:** A client message has not been sent and the connect\_agetime interval has expired. The client message is discarded.

**System Action:** The client message is deleted from the queue.

**User Response:** None.

**SLS3233I**

Improperly defined network host name or address

**Explanation:** LibraryStation attempted to determine the network host name or address and was unable to do so.

**System Action:** The LibraryStation CSI process fails.

**User Response:** Verify that the host network name and address are correctly defined in the TCP/IP configuration.



**SLS3234I**

Duplicate packet from LM discarded

**Explanation:** The LibraryStation Library Manager (LM) sent the same message packet more than once.

**System Action:** The duplicate message packet is ignored.

**User Response:** None.

**SLS3236I**

Duplicate packet from network discarded, address DDDDDDDDDD,  
process ID DDDDD, sequence number DDDDDDDD

**Explanation:** The network sent a duplicate message packet.

**System Action:** The duplicate packet is ignored.

**User Response:** None.

**SLS3237I**

Unexpected network failure status, error *DDDD*

**Explanation:** A system routine failure occurred. The network error number is displayed. The description of each possible error number follows.

<b>Error Number:</b>	<b>Descriptive Error Text:</b>
101	Interrupted system call
102	I/O error
103	Bad file number
104	Not enough core
105	Permission denied
106	Bad address
107	Invalid argument
108	File table overflow
109	Too many open files
110	Broken pipe
111	Operation would block
112	Operation now in progress
113	Operation already in progress
114	Socket operation on nonsocket
115	Destination address required
116	Message too long
117	Protocol wrong type for socket
118	Protocol not available
119	Protocol not supported
120	Socket type not supported
121	Operation not supp'd on socket
122	Protocol family not supported
123	Address fam not supp by proto
124	Address already in use
125	Can't assign requested address
126	Network is down
127	Network is unreachable
128	Network dropped conn on reset
129	Software caused conn abort
130	Connection reset by peer
131	No buffer space available
132	Socket is already connected

133	Socket is not connected
134	Can't send aft socket shutdown
135	Connection timed out
136	Connection refused
137	Host is down
138	No route to host
139	ICMP source quench received
140	Destination unreachable
141	USER configuration error
142	System related error
143	Transport provider ended
144	API subsystem ended

**System Action:** LibraryStation processing continues.

**User Response:** Contact StorageTek Software Support.

**SLS3238I**

Invalid command specified in message

**Explanation:** LibraryStation received an unrecognized command in a message packet.

**System Action:** The message packet is ignored.

**User Response:** None.

**SLS3239I**

Invalid type specified in message

**Explanation:** LibraryStation received an unrecognized type in a message packet.

**System Action:** The message packet is ignored.

**User Response:** None.

**SLS3240I**

Invalid connection queue aging time *TTTTT* specified; default of *DDDDDDDD* seconds substituted

**Explanation:** The LibraryStation initiation parameter REQTIME specified on the LSINIT control statement has an invalid value. This is the period of time after which LibraryStation will no longer retain messages for possible retransmission to client systems that were unreachable.

**System Action:** The default value of 172800 seconds, or 48 hours, was used.

**User Response:** The command should be corrected to avoid future error messages.

**SLS3241I**

Invalid location type specified in message

**Explanation:** LibraryStation received an unrecognized location type in a message packet.

**System Action:** The message packet is ignored.

**User Response:** None.

**SLS3242I**

Invalid version number *DDDDD* specified in message

**Explanation:** An unsupported or invalid version number was set in a message packet.

**System Action:** The message packet is ignored.

**User Response:** None.

**SLS3243I**

Invalid procedure specified in CSI message header

**Explanation:** The LibraryStation CSI message header contained an invalid procedure identifier.

**System Action:** LibraryStation continues to process the message packet.

**User Response:** None.

**SLS3244I**

Invalid translation syntax specified in CSI message header

**Explanation:** The LibraryStation CSI determined that the translation syntax was not XDR.

**System Action:** LibraryStation continues to process the message.

**User Response:** None.

**SLS3245I**

Invalid transmission protocol specified in CSI message header

**Explanation:** The LibraryStation CSI determined that the transmission protocol was not TCP, UDP, or ADI.

**System Action:** LibraryStation continues to process the message.

**User Response:** None.

**SLS3246I**

Network interface failure, attempting recovery

**Explanation:** The network interface has failed after being available.

**System Action:** LibraryStation frees up the network interface resources and attempts to restart the network interface.

**User Response:** Verify that all software required for network communications is operational.

**SLS3247I**

CSI network interface state {active|startup}

**Explanation:** The LibraryStation CSI network interface state is now active or is being restarted.

**System Action:** LibraryStation processing continues.

**User Response:** None.

**SLS3256I**

{Sending|Receiving} net CCCCCCCC,  
{REQUEST|ACKNOWLEDGE|INTERMEDIATE|FINAL}, SSI seq: DDDDDDDD,  
hdrseq: DDDDDDDD

**Explanation:** LibraryStation is either sending or receiving a message packet. This information is provided to allow the sending/receiving client to validate packet sequencing and uniqueness. CCCCCCCC is the command associated with the request. SSI seq: DDDDDDDD is the sequence number of the requesting client, and hdr seq: DDDDDDDD is the sequence number of the packet.

**System Action:** LibraryStation processing continues.

**User Response:** None.

**SLS3300I**

PDF error, key=XXXXXXXXXXXX, func=CCCCCCC

**Explanation:** An unrecoverable I/O error has occurred. "Key" is the key of the record involved and "func" is the name of the routine where the I/O error occurred.

**System Action:** The I/O operation is not performed.

**User Response:** If the problem is hardware-related, reallocate the PDF and restart LibraryStation. If the problem persists, contact StorageTek Software Support.

**SLS3301I**

PDF error, incorrect length record: DDDD

**Explanation:** A record was retrieved from the database that was not the length that was expected. DDDD is the length of the record retrieved.

**System Action:** The I/O request will fail.

**User Response:** If the problem persists, contact StorageTek Software Support.

**SLS3302I**

Error closing PDF

**Explanation:** An error was encountered while closing the Persistent Data File (PDF).

**System Action:** None.

**User Response:** None, except it may indicate a hardware problem with the device where the PDF resides.

**SLS3303I**

No LS drives configured

**Explanation:** During LibraryStation initialization, it was determined that no drives were LIBGENed for LibraryStation use.

**System Action:** Initialization continues but any network requests that need a drive will fail.

**User Response:** Add LibraryStation drives in the MVS/HSC LIBGEN.

**SLS3304I**

Unable to open the PDF

**Explanation:** During LibraryStation initialization, an attempt to open the Persistent Data File (PDF) failed.

**System Action:** LibraryStation will terminate.

**User Response:** Verify that the PDF has been properly allocated. If the problem persists, contact StorageTek Software Support.

**SLS3350I**

LS initialization started (VN.N.N)

**Explanation:** LibraryStation initialization has started. N.N.N is the LibraryStation version number.

**System Action:** None.

**User Response:** None.

**SLS3351I**

LS restarted task CCCCCC

**Explanation:** A LibraryStation task failed and was restarted.

**System Action:** None.

**User Response:** None.

**SLS3352I**

LS initialization complete

**Explanation:** LibraryStation has completed initialization.

**System Action:** None.

**User Response:** None.

**SLS3353I**

Invalid PID XXXXXXXX received

**Explanation:** An internal error was detected. A function returned an invalid value.

**System Action:** LibraryStation processing continues.

**User Response:** Contact StorageTek Software Support.

**SLS3354I**

LS task CCCCCC failed - terminating

**Explanation:** The LibraryStation task CCCCCC failed excessively.

**System Action:** LibraryStation terminates.

**User Response:** Attempt to restart LibraryStation with the LS INIT command. If LibraryStation continues to fail, contact StorageTek Software Support.

**SLS3355I**

Exit status (NNN), CCCCCC1, received from CCCCCC2

**Explanation:** A LibraryStation task CCCCCC2 terminated prematurely with the specified status.

**System Action:** If the status in CCCCCC1 is DATABASE\_ERROR,RECOVERY\_FAILED, or CONFIGURATION\_ERROR, LibraryStation will terminate. Otherwise, it will attempt to restart the task.

**User Response:** If LibraryStation terminates, attempt to restart it with the LS INIT command. If LibraryStation continues to fail, contact StorageTek Software Support.

**SLS3356I**

Signal NN received from CCCCCC

**Explanation:** The LibraryStation task CCCCCC terminated after receiving the specified signal.

**System Action:** LibraryStation attempts to restart the task.

**User Response:** None.

**SLS3357I**

Error received, ret = *NNN*, error = *NNN*

**Explanation:** An internal error was received. A function returned an invalid value.

**System Action:** LibraryStation terminates.

**User Response:** Attempt to restart LibraryStation with the LS INIT command. If LibraryStation continues to fail, contact StorageTek Software Support.

**SLS3358I**

LS unable to create a task - terminating

**Explanation:** LibraryStation attempted to attach a task and failed.

**System Action:** LibraryStation terminates.

**User Response:** Attempt to restart LibraryStation with the LS INIT command. If LibraryStation continues to fail, contact StorageTek Software Support.

**SLS3359I**

LS task *CCCCCCC* failed to initialize

**Explanation:** A task attached by LibraryStation failed to signal the parent that it had completed initialization.

**System Action:** LibraryStation terminates.

**User Response:** Attempt to restart LibraryStation with the LS INIT command. If LibraryStation continues to fail, contact StorageTek Software Support.

**SLS3360I**

*CCCCCCC* received unexpected signal *NNN*

**Explanation:** A LibraryStation task received a signal it was not designed to handle.

**System Action:** LibraryStation processing continues.

**User Response:** Contact StorageTek Software Support.

**SLS3361I**

LS termination started

**Explanation:** LibraryStation has started terminating.

**System Action:** Termination continues.

**User Response:** None.

**SLS3362I**

LS termination complete

**Explanation:** LibraryStation has completed termination.

**System Action:** None.

**User Response:** None.



**SLS3363I**

Copyright (C) 1992, 2010, Oracle and/or its affiliates.  
All rights reserved.

**Explanation:** This message is issued at LibraryStation initialization.

**System Action:** None.

**User Response:** None.

**SLS3364I**

Duplicate LSINIT command ignored

**Explanation:** A second LSINIT control statement was specified in the MVS/HSC parameter data set.

**System Action:** LSINIT commands after the first are ignored.

**User Response:** Remove the extra LSINIT statements from the MVS/HSC parameter data set.

**SLS3365I**

LS initialization deferred

**Explanation:** The DEFER option was specified in the LSINIT statement in the MVS/HSC parameter data set.

**System Action:** LibraryStation does not automatically initialize at MVS/HSC initialization.

**User Response:** Use the LS INIT operator command to start LibraryStation.

**SLS3366I**

LS active on CCCCCCCC

**Explanation:** At LibraryStation initialization, it was determined that another instance of LibraryStation was active. To prevent damage to the LibraryStation PDF, a SYSTEMS ENQ is used to ensure that no other copy of LibraryStation is active in the GRS ring. CCCCCCCC is the GRS SYSNAME on which the other instance of LibraryStation is active.

**System Action:** LibraryStation does not initialize.

**User Response:** Determine the correct host on which to execute LibraryStation. Shutdown LibraryStation on the other host. The ENQ qname is the HSC ENQ qname. This can be displayed with an HSC "D CDS" command. The ENQ rname is "LS:ACTIVE".

**SLS3367I**

LS not enabled for host

**Explanation:** While processing the STOP or INIT command, it was found that LibraryStation had not been enabled for the host with a valid LSINIT statement in the MVS/HSC parameter data set.

**System Action:** Command processing terminates.

**User Response:** Put a valid LSINIT statement in the MVS/HSC parameter data set and restart the MVS/HSC, or issue the command on a host that is enabled.

**SLS3368I**

LS stopped

**Explanation:** The LS STOP command has completed and LibraryStation has stopped.

**System Action:** None.

**User Response:** None.

**SLS3369I**

LS INIT command HOSTID CCCCCCCC does not match

**Explanation:** The HOSTID keyword was specified with the LS INIT command. However, the HOSTID specified does not match that of the executing host.

**System Action:** Command processing terminates.

**User Response:** Specify the command with the correct HOSTID or omit the HOSTID.

**SLS3370I**

Error opening dataset specified on LSDEF keyword

**Explanation:** The LSINIT keyword LSDEF indicated a data set name, but there was an error opening the data set.

**System Action:** LibraryStation does not initialize.

**User Response:** Correct the problem with the data set, or specify the command with the correct data set name.

**SLS3371I**

Value XXXXX not supported for CCCCCCCC DDDDDDDD parameter,  
line *n*

**Explanation:** The definition file for LSDEF had an invalid value, XXXXX, for the DDDDDDDD parameter on the CCCCCCCC statement on line *n*.

**System Action:** LibraryStation continues initialization, but the statement is not used.

**User Response:** Correct the problem with the parameter value and reinitialize LibraryStation.

**SLS3372I**

Unrecognized statement CCCCCCCC found in LSDEF file, line *n*

**Explanation:** An initial keyword for a statement in the LSDEF file was found on line *n* that was not recognized as a valid keyword for the LSDEF file.

**System Action:** LibraryStation continues initialization, but the statement is not used.

**User Response:** Correct the keyword name or remove it and reinitialize LibraryStation.

**SLS3373I**

CLIENTID missing required keyword LUNAME or IPADDR, line *n*

**Explanation:** The CLIENTID statement on line *n* had none of LUNAME or IPADDR, or XCFNAME specified. One of these must be specified on the CLIENTID statement.

**System Action:** LibraryStation continues initialization, but the statement is not used.

**User Response:** Put one of the keywords on the CLIENTID statement and reinitialize LibraryStation.

**SLS3374I**

Disallowed duplicate value XXXXX on CCCCCC DDDDDDD parameter, line *n*

**Explanation:** The definition file for LSDEF had a value, XXXXX, for the DDDDDDD parameter on the CCCCCC statement on line *n*. The value duplicated a previous value, and the duplication is disallowed.

**System Action:** LibraryStation continues initialization, but the statement is not used.

**User Response:** Give the parameter a unique value and reinitialize LibraryStation.

**SLS3375I**

Medium MMMMMMM is incompatible with drive type DDDDDDD on DRVMED statement, line *n*

**Explanation:** A medium value was specified on the DRVMED statement on line *n* for a drive type with which it is incompatible.

**System Action:** LibraryStation continues initialization, but the statement is not used.

**User Response:** Use a medium value that is appropriate for the drive and reinitialize LibraryStation.

**SLS3376I**

LS does not support this MVS release

**Explanation:** An attempt was made to initialize LibraryStation on a release of MVS that it does not support.

**System Action:** LibraryStation does not initialize.

**User Response:** Initialize LibraryStation on a system that is MVS/SP 3or MVS 4.2 and above.

**SLS3379I**

LibraryStation failed to initialize due to a startup parameter error

**Explanation:** The most likely cause is an invalid parameter in the LSINIT Control Statement. Refer to the *LibraryStation Administration and Configuration Guide*.

**System Action:** LibraryStation terminates.

**User Response:** Attempt to restart LibraryStation with the LS INIT command. If LibraryStation continues to fail, contact StorageTek Software Support.

**SLS3380I**

Ambiguous RETCOUNT parameter provided in LSINIT command string.

**Explanation:** RETCOUNT parameter is not usable with specified COMMTYPE.

**System Action:** The RETCOUNT parameter is ignored.

**User Response:** Either remove the RETCOUNT from the LSINIT statement or change COMMTYPE (LU6/XCF) to RPC.

**SLS3381I**

LS is in standby status

**Explanation:** Cross host recovery support for open systems clients (XHREC) was requested for this LibraryStation. Either DEFER was specified on the LSINIT statement or LibraryStation initialization determined that a LibraryStation is active on another host and has allocated the persistent data file.

**System Action:** None.

**User Response:** None.

**SLS3382I**

Standby LS notification sent

**Explanation:** Cross host recovery support was requested for this LibraryStation. When this LibraryStation terminated, a host communication was sent to all active HSCs. LibraryStations in standby status that receive this communication will attempt to become active.

**System Action:** None.

**User Response:** None.

**SLS3383I**

LS not active on this host

**Explanation:** The LS STOP command was issued but LibraryStation was not active on this host.

**System Action:** None.

**User Response:** None.

**SLS3384I**

Activate Standby not supported for this configuration

**Explanation:** The LS ACTIVATE STANDBY command was issued but LibraryStation on this host has allocated the PDF and has not been initialized with cross host recovery support.

**System Action:** None.

**User Response:** None.

**SLS3385I**

Standby LS notification received

**Explanation:** A cross host communication has been received requesting LibraryStation initialization.

**System Action:** If LibraryStation is in standby status on this host, initialization begins. The first LibraryStation to receive the request and begin initialization becomes active.

**User Response:** None.

**SLS3386I**

Too many values specified for VTSSLST parameter of the SPNUM statement

**Explanation:** More values were specified than the maximum allowed.

**System Action:** The SPNUM statement is ignored.

**User Response:** Either remove the SPNUM statement or change the values of the VTSSLST parameter.

**SLS3387I**

Unable to obtain configuration data for VIRTACS *vtssname*

**Explanation:** During initialization LibraryStation attempted to obtain configuration data from HSC for VIRTACS *vtssname*, but the configuration data was not available.

**System Action:** The VIRTACS *vtssname* is ignored, LibraryStation will continue processing the next VIRTACS statement.

**User Response:**

- If the VTSS *vtssname* is offline to HSC, vary it online and reinitialize LibraryStation.
- If the VTSS *vtssname* is not defined to HSC, either remove the VIRTACS statement or ignore the message.

**SLS3401I**

Invalid command CCCCCCCC

**Explanation:** An attempt was made to enter a command that was not a valid LibraryStation command.

**System Action:** The command is not executed.

**User Response:** Enter the correct command.

**SLS3402I**

Error processing CCCCCCCC command

**Explanation:** A system error occurred when processing a LibraryStation command.

**System Action:** The command is not executed.

**User Response:** Contact StorageTek Software Support.

**SLS3403I**

Command required

**Explanation:** An attempt was made to direct a command to LibraryStation but the command was missing.

**System Action:** The command is not executed.

**User Response:** Enter the correct command.

**SLS3404I**

{START|IDLE} command successfully executed

**Explanation:** A Start or Idle command was entered and has been successfully executed.

**System Action:** LibraryStation processing continues.

**User Response:** None.

**SLS3406I**

Command CCCCCC not executed; LS not available

**Explanation:** An attempt was made to enter a command when LibraryStation was not active or was in standby status.

**System Action:** The command is not executed.

**User Response:** Once LibraryStation has been initialized and is active, re-enter the command.

**SLS3407I**

Command INIT not executed; LS already initialized

**Explanation:** The operator command ".LS INIT" was entered, but LibraryStation had already been initialized.

**System Action:** The INIT command is ignored. The system state remains unchanged.

**User Response:** None.

**SLS3408I**

DRIVE or DRIVEID keyword required

**Explanation:** A Vary command was entered and did not specify a drive identifier.

**System Action:** The command is not executed.

**User Response:** Re-enter the Vary command specifying a drive identifier.

**SLS3409I**

ONLINE or OFFLINE keyword required

**Explanation:** A Vary command was entered and did not specify ONLINE or OFFLINE.

**System Action:** The command is not executed.

**User Response:** Re-enter the Vary command specifying ONLINE or OFFLINE.

**SLS3411I**

LSM in driveid {AA:LL:PP:NN} not in configuration

**Explanation:** A command was entered referring to an invalid LSMid.

**System Action:** The command is not executed.

**User Response:** Re-enter the command specifying the correct LSMid.

**SLS3412I**

Request *DDDDD* not cancelled; request not active

**Explanation:** A Cancel command was issued for a requestid that was not active.

**System Action:** The command is not executed.

**User Response:** Re-enter the command specifying the correct requestid.

**SLS3413I**

Drive *CCCCCC* not configured to LS

**Explanation:** A command was entered referring to an invalid driveid.

**System Action:** The command is not executed.

**User Response:** Re-enter the command specifying the correct driveid.

**SLS3414I**

Request *DDDDD* is noncancelable

**Explanation:** A Cancel command was issued for a requestid that cannot be cancelled.

**System Action:** The command is not executed.

**User Response:** Re-enter the command specifying the correct requestid.

**SLS3415I**

Drive (*XXXX*) (*AA:LL:PP:NN*) varied {ONLINE|OFFLINE}

**Explanation:** A Vary command was entered for a drive and has successfully completed.

**System Action:** LibraryStation processing continues.

**User Response:** None.

**SLS3416I**

Server is {idle|idle pending|running|initializing|standby}

**Explanation:** A Display Status command was issued. The current state of LibraryStation is displayed.

**Idle** - LibraryStation has quiesced and is not accepting requests.

**Idle pending** - LibraryStation is quiescing and is not accepting requests.

**Running** - LibraryStation is active.

**Initializing** - LibraryStation is initializing.

**Standby** - LibraryStation is in standby status and is not accepting requests.

**System Action:** LibraryStation processing continues.

**User Response:** None.

**SLS3417I**

Mount (DDDDD1/DDDDD2) Dismount (DDDDD1/DDDDD2)  
Enter (DDDDD1/DDDDD2) Eject (DDDDD1/DDDDD2)

**Explanation:** A Display Status command was issued. For each request type, DDDDD1 indicates the number of current requests and DDDDD2 indicates the number of pending requests.

**System Action:** LibraryStation processing continues.

**User Response:** None.

**SLS3418I**

Request DDDDD: command CCCCCCCC status CCCCCCCC

**Explanation:** A Display Request command was issued. The command and status of the associated request are displayed.

**System Action:** LibraryStation processing continues.

**User Response:** None.

**SLS3419I**

No requests outstanding

**Explanation:** A Display Request command was issued. No requests are active or queued at this time.

**System Action:** LibraryStation processing continues.

**User Response:** None.

**SLS3422I**

IDLE is currently pending

**Explanation:** An Idle command was issued. One or more requests are outstanding.

**System Action:** LibraryStation processing continues. When all outstanding requests have completed, the LibraryStation state becomes idle.

**User Response:** To determine which requests are outstanding, a Display Request command can be issued.

**SLS3425I**

ACS AA not in configuration

**Explanation:** A command was entered referring to an invalid ACSid.

**System Action:** The command is not executed.

**User Response:** Re-enter the command specifying the correct ACSid.

**SLS3430I**

Drive (XXXX) (AA:LL:PP:NN) currently in use

**Explanation:** A Vary command was entered referring to a drive that is in use.

**System Action:** The command is not executed.

**User Response:** Re-enter the command when the drive is available.



**SLS3431I**

VARY command currently in process for drive  
(XXXX) (AA:LL:PP:NN)

**Explanation:** A Vary command was entered referring to a drive that is already the object of a previous Vary command.

**System Action:** The command is not executed.

**User Response:** Re-enter the command when the prior Vary command completes.

**SLS3432I**

LS DISPLAY command requires a display type

**Explanation:** A Display command was entered without specifying a display type.

**System Action:** The command is not executed.

**User Response:** Re-enter the Display command specifying the type of display.

**SLS3433I**

CCCCCCC command cancelled

**Explanation:** A Cancel command was entered and has successfully completed.

**System Action:** LibraryStation processing continues.

**User Response:** None.

**SLS3434I**

LS trace mask XXXXXXXX set for CCCC component

**Explanation:** A Trace command was entered and has successfully initiated tracing for the component specified.

**System Action:** LibraryStation processing continues.

**User Response:** None.

**SLS3436I**

{AA:LL:PP:NN} is an invalid driveid

**Explanation:** A command was entered referring to a driveid that is invalid.

**System Action:** The command is not executed.

**User Response:** Re-enter the command specifying a valid driveid.

**SLS3437I**

Operator command service has encountered an IPC failure

**Explanation:** An interprocess communication failure has occurred while attempting to process an operator command.

**System Action:** The operator command is not executed.

**User Response:** Contact StorageTek Software Support.

**SLS3438I**

Request ID (DDDDD) not in range (1-65535)

**Explanation:** A Query Request command was issued for an invalid requestid value.

**System Action:** LibraryStation processing continues.

**User Response:** Re-enter the command with a valid requestid value.

**SLS3439I**

Driveid format invalid

**Explanation:** A driveid was entered that did not conform to proper driveid format.

**System Action:** The operator command is not executed for that driveid.

**User Response:** Re-enter command specifying proper driveid format.

**SLS3440I**

{AA:LL:PP:NN}{ACS|LSM|PANEL|DRIVE} specification is invalid

**Explanation:** A driveid was entered that did not have a proper element specification.

**System Action:** The operator command is not executed for that driveid.

**User Response:** The displayed message gives the element in question: ACS, LSM, DRIVE, or PANEL. Re-enter the command with the proper element specification.

**SLS3441I**

Range exceeds 100 allowable drives

**Explanation:** A command was entered that specified a range of drives that was greater than 100.

**System Action:** Only the first 100 drives are used.

**User Response:** Re-enter the command specifying a range less than 100.

**SLS3442I**

Maximum allowed configured drives in request is 42

**Explanation:** A command was entered that specified a range of drives that contained more than 42 LibraryStation-configured drives.

**System Action:** Only the first 42 LibraryStation-configured drives are used.

**User Response:** Re-enter the command specifying less than 42 drives.

**SLS3443I**

Last drive processed was (XXXX)

**Explanation:** A command was entered that specified either more than 42 LibraryStation-configured drives, or a range that specified more than 100 total drives. The last drive processed is displayed.

**System Action:** LibraryStation processing continues.

**User Response:** Enter the command with less than 42 LibraryStation-configured drives or a range of fewer than 100 drives.

**SLS3444I**

{Drive|Drives} {XXXX/XXXX-XXXX} {is|are} not configured to LS

**Explanation:** A command was entered that contains drives that are not configured to LibraryStation. The drives are listed.

**System Action:** LibraryStation processing continues.

**User Response:** Re-enter the command with drives that are configured to LibraryStation.

**SLS3445I**

Component id CCCC is not valid

**Explanation:** A Trace command was entered with an invalid component id.

**System Action:** LibraryStation processing continues.

**User Response:** Re-enter the command with a valid component id.

**SLS3447I**

LS services have terminated

**Explanation:** While responding to an operator command, LibraryStation has become unavailable.

**System Action:** None.

**User Response:** Examine the SYSLOG and the HSC job log to determine why LibraryStation became unavailable. Re-enter the command after LibraryStation becomes available.

**SLS3448I**

Cancel of request DDDDD scheduled

**Explanation:** A Cancel command was entered for a specific requestid and has been successfully initiated.

**System Action:** LibraryStation processing continues.

**User Response:** None.

**SLS3463I**

Current CCCCCC value is DDDDDDD

**Explanation:** The SET command was entered with no value specified for the SET parameter. The SET command displays the current value for the option CCCCCC is the parameter specified on the SET command. DDDDDDD is the current value for the parameter.

**System Action:** None.

**User Response:** None.

**SLS3464I**

CCCCCCCC set to DDDDDDDD

**Explanation:** The parameter specified on the SET command has been set to the indicated value. CCCCCCCC is the option entered on the SET command. DDDDDDDD is the value entered on the SET command.

**System Action:** None.

**User Response:** None.

**SLS3465I**

SET parameter missing

**Explanation:** A SET command was issued with no parameter.

**System Action:** SET command processing terminates.

**User Response:** Refer to the *LibraryStation Configuration and Administration Guide* or issue the LS "Display CMd SET" command to determine the supported parameters for the SET command.

**SLS3466I**

Value not supported for SET CCCCCCCC parameter, value DDDDDD ignored

**Explanation:** An invalid value was specified for the SET command option. CCCCCCCC is the parameter entered on the SET command. DDDDDD is the value entered on the SET command.

**System Action:** SET command processing terminates.

**User Response:** Refer to the *LibraryStation Configuration and Administration Guide* to determine the supported values for the specified SET parameter.

**SLS3467I**

Drive (XXXX) (AA:LL:PP:NN) Type drive\_type{ONLINE|OFFLINE}, {in use|available|not in library}[,VVVVVV]

**Explanation:** A Display DDrive command was issued. The driveid is displayed in MVS device number and LibraryStation driveid formats. The drive type reported is as defined on an LSDEF DRIVETYP NAME statement. The drive state and status are displayed. If a volume is mounted on the drive, the volume serial is also displayed.

**System Action:** LibraryStation processing continues.

**User Response:** None.

**SLS3468I**

Server status

Server is {IDLE|IDLE PENDING|RUN|INITIALIZING|STANDBY}  
 Mount (DDDDD1/DDDDD2) Dismount (DDDDD1/DDDDD2)  
 Enter (DDDDD1/DDDDD2) Eject (DDDDD1/DDDDD2)

**Explanation:** A Display Status command was issued. The current state of LibraryStation is displayed.

**IDLE** - LibraryStation has quiesced and is not accepting requests.

**IDLE PENDING** - LibraryStation is quiescing and is not accepting requests.

**RUN** - LibraryStation is active.

**INITIALIZING** - LibraryStation is initializing.

**STANDBY** - LibraryStation is in standby status and is not accepting requests.

For each request type, DDDDD1 indicates the number of current requests and DDDDD2 indicates the number of pending requests.

**System Action:** LibraryStation processing continues.

**User Response:** None.

**SLS3469I**

Request status XXX

Request DDDDD: command CCCCCCCC status CCCCCCCC

**Explanation:** A Display Request command was issued. The command and status of the associated request are displayed. DDDDD is the requestid of the Display Request command just issued.

**System Action:** LibraryStation processing continues.

**User Response:** None.

**SLS3470I**

Trace command status

LS trace mask XXXXXXXX set for CCCC component Component id  
 CCCC is not valid

**Explanation:** A Trace command was entered. The trace mask is displayed for every component specified unless the component id entered is invalid.

**System Action:** LibraryStation processing continues.

**User Response:** Re-enter the command with a valid component id for any component ids that were invalid.

**SLS3471I**

Vary command status

```

Drive (XXXX) (AA:LL:PP:NN) varied {ONLINE|OFFLINE}
Drive (XXXX) (AA:LL:PP:NN) currently in use
VARY command currently in process for drive
(XXXX) (AA:LL:PP:NN)
LSM in driveid {AA:LL:PP:NN}not in configuration
ACS in driveid {AA:LL:PP:NN}not in configuration
{AA:LL:PP:NN}{ACS|LSM|PANEL|DRIVE} specification is invalid
Drive {XXXX|AA:LL:PP:NN}is not configured to LS
    
```

**Explanation:** A Vary command was entered for one or more drives. One message line is created for each drive in the request. The message line contains the status of the vary request for that drive. The Vary command has either completed successfully, been issued before for the drive or the drive is busy and cannot be varied at this time

Input to the command may have been invalid or incomplete. An invalid or unconfigured drive may have been specified as input to the Vary command. The specification of the drive id may be invalid. The drive may not be defined to LibraryStation.

**System Action:** LibraryStation processing continues.

- If the drive has been successfully varied, no response is required.
- If the drive is in use, re-enter the command when the drive is available.
- If a previous Vary command for a drive is in process, re-enter the command when the prior Vary command completes.
- If the LSM or ACS are not configured, re-enter the command specifying the correct LSMid or ACSid.
- If the driveid specification was incorrect, the displayed message provides the element in question: ACS, LSM, DRIVE or PANEL. Re-enter the command with the proper element specification.
- If the drive is not configured to LibraryStation, re-enter the command with drives that are configured.

**SLS3472I**

Display drive response

```
Drive (XXXX)(AA:LL:PP:NN)Type drive_type
{ONLINE|OFFLINE}, {in use|available|not in library} [,VVVVVV]
LSM in driveid {AA:LL:PP:NN} not in configuration
ACS in driveid {AA:LL:PP:NN} not in configuration
{AA:LL:PP:NN} {ACS|LSM|PANEL|DRIVE} specification is invalid
Drive {XXXX|AA:LL:PP:NN} is not configured to LS
```

**Explanation:** A Display DRive | DRIVEId command was entered for one or more drives. One message line is created for each drive in the request. The message line contains the status of that drive. The driveid is displayed in MVS device number and LibraryStation driveid formats. The drive type reported is as defined on an LSDEF DRIVETYP NAME statement. The drive state and status are displayed. If a volume is mounted on the drive, the volume serial is also displayed.

Input to the command may have been invalid or incomplete. An invalid or unconfigured drive may have been specified as input to the Display DRive | DRIVEId command. The specification of the driveid may be invalid. The drive may not be defined to LibraryStation.

**System Action:** LibraryStation processing continues.

- If the drive has been successfully displayed, no response is required.
- If the LSM or ACS are not configured, re-enter the command specifying the correct LSMid or ACSid.
- If the drive specification was incorrect, the displayed message provides the element in question: ACS, LSM, DRIVE or PANEL. Re-enter the command with the proper element specification.
- If the drive is not configured to LibraryStation, re-enter the command with drives that are configured.

**SLS3473I**

```

Clearlock response
Drive (XXXX) (AA:LL:PP:NN) {Status: all locks are cleared|Status:
no lock found for resource|Error: SSSSSSSS}
LSM in driveid {AA:LL:PP:NN} not in configuration
ACS in driveid {AA:LL:PP:NN} not in configuration
{AA:LL:PP:NN}{ACS|LSM|PANEL|DRIVE} specification is invalid
Drive {XXXX|AA:LL:PP:NN} is not configured to LS
    
```

**Explanation:** .A CLrlock DRive|DRIVEId command was entered for a single drive. The drive and the status of the Clearlock are displayed. If all locks were cleared, this indicates that the drive no longer has any outstanding lock associated with it and is now available for use. If no locks were found, the drive was either entered incorrectly or there is some other problem that is causing it to be unavailable.

Input to the command may have been invalid or incomplete. An invalid or unconfigured drive may have been specified as input to the CLrlock DRIVE command. The specification of the drive may be invalid. The drive may not be defined to LibraryStation. If an unexpected error response is encountered, the error message format displays the clear\_lock\_drv\_status SSSSSSSS to assist in problem analysis.

**System Action:** If lock(s) are found for the specified drive, they are removed from the system. LibraryStation processing continues.

- If all locks were cleared, the drive is now available for use. If no locks were found, the drive or driveid may have been specified incorrectly. Continue diagnosis to determine the problem.
- If the LSM or ACS are not configured, re-enter the command specifying the correct LSMid or ACSid.
- If the driveid specification was incorrect, the displayed message provides the element in question: ACS, LSM, PANEL, or DRIVE. Re-enter the command with the proper element specification.
- If the drive is not configured to LibraryStation, re-enter the command with a drive that is configured.
- If an error was encountered, refer to the *CSC Developer's Toolkit, ACSAPI Programmer's Guide* for a list of the clear\_lock\_drv\_status and drv\_status. If an unexpected error response is encountered that cannot be diagnosed, Contact StorageTek Software Support.

**SLS3475I**

Current Trace Settings:

**Explanation:** The LibraryStation Trace command has been issued with no parameters. The SLS3475I message lists all of the LibraryStation components with their corresponding trace map bit settings.

**System Action:** None.

**User Response:** None.



**SLS3477D**

VAL '8XXXXXXX' or greater may impact system performance; Reply 'YES' to Trace

**Explanation:** A Trace VAL of '8XXXXXXX' traces module entry and exit to GTF. This can impact system performance.

**System Action:** LibraryStation tracing waits for an operator response.

**User Response:** Respond with "YES" if tracing is to proceed. Any other response cancels the TRace request.

**SLS3478I**

LS Trace request canceled

**Explanation:** A reply other than "YES" was received from an SLS3477D WTOR message. A Trace VAL value of '8000000' or greater may impact system performance; Reply "YES" to allow tracing. Any other response cancels the LS Trace request.

**System Action:** The LS Trace request is canceled.

**User Response:** Re-issue the LS Trace command with a VAL less than '8000000' or respond "YES" to the SLS3477D message if tracing is to proceed.

**SLS3599I**

LS command processing not active

**Explanation:** An attempt was made to enter a command when LibraryStation was not active.

**System Action:** The command is not executed.

**User Response:** Once LibraryStation has been initialized, re-enter the command.

**SLS3601I**

Processing VOLUME(*volser*), DRIVE(*AA:LL:PP:NN*), COMMTYPE(*CCC*),  
{TCPNAME(*CCCC*) | SYMDESTN(*CCCCCCCC*) | XCF(*G G G G, M M M M*) }

**Explanation:** The diagnostic test program is attempting to run diagnostic tests using volume *volser* on the library drive specified (*AA:LL:PP:NN*). If the COMMTYPE is RPC the tests will be done using the TCP protocol identified by TCPNAME. If the COMMTYPE is LU6 then the tests will be done using the symbolic destination name identified by SYMDESTN. If the COMMTYPE is XCF then the tests will be done using XCF with the group and member name specified.

**System Action:** The diagnostic test program continues.

**User Response:** None.

**SLS3602I**

{HSC|LS} is inactive or not installed

**Explanation:** The diagnostic test program has determined that the MVS/HSC or LibraryStation has not been installed and/or activated.

**System Action:** The diagnostic test program ends execution of its test suites.

**User Response:** Verify that the MVS/HSC and LibraryStation are correctly installed and started.

**SLS3603I**

Unable to acquire a network packet buffer

**Explanation:** The diagnostic test program has failed while attempting to acquire the memory to create a network request to send to LibraryStation.

**System Action:** The diagnostic test program ends execution of its test suites.

**User Response:** Contact StorageTek Software Support.

**SLS3604I**

Unable to initialize RPC network communications

**Explanation:** The diagnostic test program has been unsuccessful in establishing an RPC connection with the LibraryStation program. This message is accompanied by other more detailed messages that specify the reason for the connection failure.

**System Action:** The diagnostic test program ends execution of its test suites.

**User Response:** Examine the messages issued immediately before this summary message. Remedy the problems listed in these messages and run the diagnostic test program again.

**SLS3606I**

RPC error sending {QUERY|MOUNT|DISMOUNT} request to network task

**Explanation:** The diagnostic test program has been unsuccessful in sending an RPC message to the LibraryStation program. The RPC message contained a (QUERY|MOUNT|DISMOUNT) request. This message is accompanied by other more detailed messages that specify the reason for the transmission failure.

**System Action:** The diagnostic test program ends execution of its test suites.

**User Response:** Examine the messages issued immediately before this summary message. Remedy the problems listed in these messages and run the diagnostic test program again.

**SLS3607I**

{QUERY|MOUNT|DISMOUNT} request successfully sent to network task

**Explanation:** The diagnostic test program has been successful in sending an RPC message to the LibraryStation program. The message contains a (QUERY|MOUNT|DISMOUNT) request.

**System Action:** The diagnostic test program continues execution of its test suites.

**User Response:** None.

**SLS3608I**

Time out waiting for {ACKNOWLEDGEMENT|RESPONSE} from  
{QUERY|MOUNT|DISMOUNT} request

**Explanation:** The diagnostic test program has timed out waiting for an RPC message from the LibraryStation program. This message was expected to contain an (ACKNOWLEDGEMENT|RESPONSE) from a message successfully sent that contained a (QUERY|MOUNT|DISMOUNT) request.

**System Action:** The diagnostic test program ends execution of its test suites.

**User Response:** Examine the MVS SYSLOG for messages pertaining to LibraryStation activity. If messages indicate that LibraryStation received the diagnostic program request and responded, compare the destination program number, address, and port with the same information written to the diagnostic program SYSPRINT data set. Contact StorageTek Software Support for assistance.

**SLS3611I**

Failure creating UDP transport mapping

**Explanation:** The diagnostic test program was unsuccessful in establishing a UDP transport (socket) to use for communications with LibraryStation.

**System Action:** The diagnostic test program ends execution of its test suites.

**User Response:** Contact StorageTek Software Support.

**SLS3612I**

Failure registering as a client

**Explanation:** The diagnostic test program was unsuccessful in registering with RPC as a client service for communications with LibraryStation.

**System Action:** The diagnostic test program ends execution of its test suites.

**User Response:** Contact StorageTek Software Support.

**SLS3613I**

Failure creating RPC connection, RPC msg is *MMMMM*

**Explanation:** The diagnostic test program was unsuccessful in establishing a UDP connection with the LibraryStation registered program number.

**System Action:** The diagnostic test program ends execution of its test suites.

**User Response:** Contact StorageTek Software Support.

**SLS3614I**

Failure sending RPC request, RPC msg is *MMMMM*

**Explanation:** The diagnostic test program was unsuccessful in sending a message using the UDP protocol to the LibraryStation registered program number.

**System Action:** The diagnostic test program ends execution of its test suites.

**User Response:** Contact StorageTek Software Support.

**SLS3615I**

Invalid RPC procedure number received

**Explanation:** The diagnostic test program received a message from LibraryStation or another application that it could not identify.

**System Action:** The diagnostic test program ends execution of its test suites.

**User Response:** Contact StorageTek Software Support.

**SLS3616I**

Network packet error occurred in XDR translation

**Explanation:** The diagnostic test program was unsuccessful in decoding (deserializing) a message received from LibraryStation or another application.

**System Action:** The diagnostic test program ends execution of its test suites.

**User Response:** Contact StorageTek Software Support.

**SLS3617I**

QUERY SERVER response: state {RUNNING | IDLE | IDLE\_PENDING},  
status {SUCCESS | PROCESS\_FAILURE | DATABASE\_ERROR}, free  
cells NNNNNN

**Explanation:** The diagnostic test program has received and decoded a final response message for a Query\_server request that it sent to LibraryStation. The message contains the results that LibraryStation sent to the diagnostic test program. "Free cells" indicates all free cells in all ACSs.

**System Action:** The diagnostic test program continues execution of its test suites.

**User Response:** None.

**SLS3618I**

MOUNT response: valid volser, drive AA:LL:PP:NN, status  
CCCCCCCC

**Explanation:** The diagnostic test program has received and decoded a final response message for a Mount request for valid *volser* on driveid *AA:LL:PP:NN* that it sent to LibraryStation. The message contains the Status request that LibraryStation sent to the diagnostic test program.

**System Action:** The diagnostic test program continues execution of its test suites.

**User Response:** None.

**SLS3619I**

DISMOUNT response: valid volser, drive AA:LL:PP:NN, status  
CCCCCCCC

**Explanation:** The diagnostic test program has received and decoded a final response message for a Dismount request for valid *volser* on driveid *AA:LL:PP:NN* that it sent to LibraryStation. The message contains the Status request that LibraryStation sent to the diagnostic test program.

**System Action:** The diagnostic test program continues execution of its test suites.

**User Response:** None.

**SLS3620I**

Received request response for unsupported diagnostic command

**Explanation:** The diagnostic test program received a response message from LibraryStation for a command that it does not support.

**System Action:** The diagnostic test program ends execution of its test suites.

**User Response:** Contact StorageTek Software Support.

**SLS3621I**

{QUERY|MOUNT|DISMOUNT} request acknowledgment received

**Explanation:** The diagnostic test program received an acknowledgment message from LibraryStation for the command listed in the message text.

**System Action:** The diagnostic test program continues execution of its test suites.

**User Response:** None.

**SLS3622I**

Invalid library client parameters: PPPPPPPP, status SSSSSSSS

**Explanation:** The diagnostic test program determined that an input parameter was invalid.

**System Action:** The diagnostic test program ends execution of its test suites.

**User Response:** Correct the invalid parameter and rerun the diagnostic test program.

**SLS3623I**

Error obtaining transient program number

**Explanation:** The diagnostic test program was unable to obtain a program number to use for registering as a client service.

**System Action:** The diagnostic test program ends execution of its test suites.

**User Response:** Contact StorageTek Software Support.

**SLS3624I**

Error obtaining host name or inet address, status CCCCCCCC

**Explanation:** The diagnostic test program experienced an RPC error while querying RPC for the local host's internet address. This address is used to communicate with LibraryStation on this host. The status CCCCCCCC of the error is listed in the message text.

**System Action:** The diagnostic test program ends execution of its test suites.

**User Response:** Contact StorageTek Software Support.

**SLS3625I**

Library diagnostic test program ended with RC = {0|4|8|12}

**Explanation:** The diagnostic test program has ended. The highest return code encountered while running the diagnostic test program is listed in the message text.

**System Action:** All diagnostic test program processing is now ended.

**User Response:** Examine the return code. The description of the severity and nature of the return codes is

- 0 - All diagnostic tests completed successfully
- 4 - A diagnostic request to Query, Mount or Dismount was not successful
- 8 - LibraryStation or MVS/HSC software error (ABEND or STATUS\_PROCESS\_FAILURE)
- 12 - Network Communications failed or LibraryStation of MVS/HSC inactive or not installed

If the return code is not 0, then examine the messages in the SYSPRINT data set to determine the nature and extent of the error conditions. Correct the problems and rerun the diagnostic test program until a return code of 0 is returned.

**SLS3627I**

Invalid diagnostic request CCCCCCCC received

**Explanation:** A request was received that is not supported by the diagnostic test program.

**System Action:** The diagnostic test program ends execution of its test suites.

**User Response:** Contact StorageTek Software Support.

**SLS3628I**

Received network packet from netaddr NNNNNNNN, port NNNN

**Explanation:** The diagnostic test program received a message from LibraryStation or another application. The network address and port of the sender are listed in the message text.

**System Action:** The diagnostic test program continues execution of its test suites.

**User Response:** None.

**SLS3629I**

Failure unmapping previously registered RPC service

**Explanation:** The diagnostic test program was attempting to unmap its registered program number from RPC during shutdown and encountered an error.

**System Action:** Shutdown and termination of the diagnostic test program continues.

**User Response:** Contact StorageTek Software Support.

**SLS3633I**

```
Processing VOLUME volser, DRIVEID(AA:LL:PP:NN), COMMTYPE(CCC),
{TCPNAME(CCCCCCCC) | SYMDESTN(CCCCCCCC) | XCF(GGGG,MMMM) }
```

**Explanation:** The diagnostic test program is attempting to run diagnostic tests using volume *volser* on the library drive specified (AA:LL:PP:NN). If the COMMTYPE is RPC, the tests will be done using TCP identified by TCPNAME. If the COMMTYPE is LU6 then the tests will be done using the symbolic destination name identified by SYMDESTN. If the COMMTYPE is XCF then the tests will be done using XCF with the group and member name specified.

**System Action:** The diagnostic test program continues execution of its test suites.

**User Response:** None.

**SLS3634I**

```
Processing VIRTUAL_DRIVE(XXXX), COMMTYPE(CCC),
{TCPNAME(CCCCCCCC) | SYMDESTN(CCCCCCCC) | XCF(GGGG,MMMM) }
```

**Explanation:** The diagnostic test program is attempting to run diagnostic tests using virtual\_drive XXXX where XXXX is the MVS unit address of the virtual\_drive. If the COMMTYPE is RPC, the tests will be done using TCP identified by TCPNAME. If the COMMTYPE is LU6 then the tests will be done using the symbolic destination name identified by SYMDESTN. If the COMMTYPE is XCF then the tests will be done using XCF with the group and member name specified.

**System Action:** The diagnostic test program continues execution of its test suites.

**User Response:** None.

**SLS3635I**

```
QUERY DRIVE response: query_drive_status
{SUCCESS|PROCESS_FAILURE},VIRTUAL_DRIVE(XXXX), VOLUME volser,
drive_status{PROCESS_FAILURE|DRIVE_IN_USE|DRIVE_AVAILABLE}
```

**Explanation:** The diagnostic test program has received and decoded a final response message for a Query\_Drive request that it sent to LibraryStation. The message contains the results that LibraryStation sent to the diagnostic test program. XXXX is the MVS unit address of the virtual\_drive.

**System Action:** The diagnostic test program continues execution of its test suites.

**User Response:** None.

**SLS3637I**

```
Validate TCP/IP response: status SSSSSSSS
```

**Explanation:**

- If SSSSSSSS = PROCESS\_FAILURE, the GETHOSTNAME or the GETHOSTBYNAME function has failed.
- If SSSSSSSS = SUCCESS, the GETHOSTNAME and GETHOSTBYNAME functions were successful.
- If SSSSSSSS = PROCESS\_FAILURE, the SLGDIAG job ends with an RC=8.
- If SSSSSSSS = SUCCESS, the SLGDIAG job ends with an RC=0.

**User Response:** None.

**SLS3638I**

TCPIPTEST=YES is only valid when COMMTYPE=RPC

**Explanation:** The TCPIPTEST=YES parameter is only valid when COMMTYPE=RPC.

**System Action:** The SLGDIAG job ends with an RC=4.

**User Response:** Correct the COMMTYPE and resubmit the job.

**SLS3701I**

Unexpected vary state CCCCCCCC detected

**Explanation:** An invalid condition was detected.

**System Action:** The Vary request stops.

**User Response:** Contact StorageTek Software Support.

**SLS3702I**

Drive (XXXX) (AA:LL:PP:NN) now {ONLINE | OFFLINE}

**Explanation:** The specified drive has been varied online or offline.

**System Action:** None.

**User Response:** None.

**SLS3726I**

Invalid Mount/Dismount command CCCCCCCC received

**Explanation:** The LibraryStation Mount/Dismount process has received an unexpected command CCCCCCCC from the Library Manager (LM) component.

**System Action:** The processing of this unexpected command is aborted.

**User Response:** Contact StorageTek Software Support.

**SLS3728I**

RRRRRRRRRRRRR from client NNNNNNNNNNNNNNNN UUUUUUUUU of  
CCCCCCC(VVVVVV) on drive(XXXX) (AA:LL:PP:NN) - {READ  
auth'd|UPDATE auth'd|authorized}

**Explanation:** A network request RRRRRRRRRRRRRR from LibraryStation client netaddr NNNNNNNNNNNNNNNN client userid UUUUUUUUUU has attempted to access volume VVVVVV defined in security class CCCCCCCC. Drive (XXXX) (AA:LL:PP:NN) was specified in the request. Access is either READ or UPDATE authorized for a mount request; or simply authorized for a dismount request.

**System Action:** LibraryStation processing continues.

**User Response:** No response is required.



**SLS3729I**

RRRRRRRRRRRRR from client NNNNNNNNNNNNNNN of CCCCCC(VVVVVV)  
on drive(XXXX) (AA:LL:PP:NN) - {READ authorized|UPDATE  
authorized|authorized}

**Explanation:** A network request RRRRRRRRRRRRRR from LibraryStation client netaddr NNNNNNNNNNNNNNNN has attempted to access volume VVVVVV defined in security class CCCCCC. Drive (XXXX) (AA:LL:PP:NN) was specified in the request. Access is either READ or UPDATE authorized for a mount request; or simply authorized for a dismount request.

**System Action:** Librarystation processing continues.

**User Response:** No response is required.

**SLS3730I**

RRRRRRRRRRRRR from client NNNNNNNNNNNNNNN UUUUUUUU of  
CCCCC(VVVVVV) {on|from} drive(XXXX) (AA:LL:PP:NN) - Complete

**Explanation:** A network request RRRRRRRRRRRRRR from LibraryStation client netaddr NNNNNNNNNNNNNNN client userid UUUUUUUU has successfully completed the request for volume VVVVVV defined in security class CCCCCC using drive (XXXX) (AA:LL:PP:NN). For mount/dismount requests client userid UUUUUUUU is only visible if VOLACC(YES) has been specified in the LSINIT control statement. Client userid UUUUUUUU is never visible for mount scratch requests.

**System Action:** Librarystation processing continues.

**User Response:** No response is required.

**SLS3800I**

All lock identifiers in use

**Explanation:** A lock request has been received but there are no lock identifiers values that are available for use.

**System Action:** The lock request fails.

**User Response:** Probable client error. Contact StorageTek Software Support.

**SLS3850I**

Unable to register with APPC/MVS - not available

**Explanation:** LibraryStation has attempted to register for allocation with the APPC/MVS address space but APPC/MVS is not up.

**System Action:** LibraryStation will continue to try to register with APPC every 30 seconds.

**User Response:** Start APPC/MVS.

**SLS3851I**

APPC/MVS error: FFFFFFFF, AAAAAAAA, EE, RR, SSSSSSSS

**Explanation:** The LibraryStation function FFFFFFFF issued the APPC/MVS call AAAAAAAA which resulted in an error. EE is the return code and RR is the reason code returned by AAAAAAAA. SSSSSSSS is the symbolic destination name that LibraryStation used to register with APPC/MVS.

**System Action:** If the problem occurs during LibraryStation initialization, initialization fails. If the problem occurs after LibraryStation initialization is complete, LibraryStation processing continues, however, LU6.2 client communication may not be possible. LibraryStation will try to recover by attempting to reregister with APPC/MVS.

**User Response:** See *IBM Application Development: Writing Servers for APPC/MVS* (GC28-1070) for a detailed explanation of each possible combination of return code EE and reason code RR. Note: If an error occurs on the APPC/MVS "Register-for-Allocates" (ATBRFA2) call, this usually indicates there is a problem with the side information identified by the symbolic destination name SSSSSSSS. If the problem persists contact StorageTek Software Support.

**SLS3852I**

LU6.2 error: FFFFFFFF, CCCCCC, EE, [PPPPPPPP]

**Explanation:** An LU6.2 communication error occurred between LibraryStation and a client system. The LU6.2 LibraryStation function FFFFFFFF issued the CPI/C call CCCCCC which resulted in an error. EE is the error return code from CCCCCC. PPPPPPPP is the logical unit name of the client system.

**System Action:** All communication with the client system ceases. If the error occurred while LibraryStation is processing a request, all responses for that request are lost.

**User Response:** See *IBM System Application Architecture Common Programming Interface Communications Reference* (SC26-4399) for detailed information about the error return code. Note: A return code of 17 (CM\_DEALLOCATED\_ABEND) usually means that the client system has terminated abnormally and does not indicate a LibraryStation problem. If the problem persists, contact StorageTek Software Support.

**SLS3855**

TCP/IP fail: AAAAA.BBBBB, CCCCC, DDDDD

**Explanation:** The routine AAAAA has attempted a call to a TCP/IP routine and received a BBBBB condition. The numeric error code received is CCCCC and this decodes to the reason DDDDD.

**System Action:** Depending upon the routine involved and the conditions under which the error occurred, the connection to the client system may either be closed or the server function may shut down.

**SLS3856I**

Routine AAAAA reported: BBBBB

**Explanation:** The routine AAAAA has discovered the problem BBBBB.

**System Action:** Depending upon the routine involved and the conditions under which the error occurred, the connection to the client system may either be closed or the server function may shut down.

**SLS3857I**

TCP/IP Server started on port XXXXXX

**Explanation:** The server for CSCI requests over TCP/IP has been started and will listen for connections from clients on port XXXXX.

**System Action:** None.

**User Response:** None.

**SLS3858I**

TCP/IP Server stopped

**Explanation:** The server for CSCI requests has terminated.

**System Action:** None.

**User Response:** None.

**SLS3902I**

Memory allocation failed

**Explanation:** An attempt was made to allocate more memory than was available.

**System Action:** The current process fails. LibraryStation processing continues.

**User Response:** Contact StorageTek Software Support.

**SLS3905I**

Unexpected network communications error; status NNNNNNNN

**Explanation:** LibraryStation received a network interface failure. NNNNNNNN is the status code for the failure. Possible status codes are STATUS\_NI\_FAILURE and STATUS\_RPC\_FAILURE.

**System Action:** LibraryStation processing continues.

**User Response:** Verify that TCP/IP and the TCP/IP Portmapper are active, and that TCP/IP is configured properly. If the problem persists, contact StorageTek Software Support.

**SLS3911I**

Sending message to socket SSSSSSSS failed

**Explanation:** A LibraryStation process was unable to send a message to another process, socket name SSSSSSSS.

**System Action:** LibraryStation processing continues.

**User Response:** If the problem persists, contact StorageTek Software Support.

**SLS3912I**

Signaling process PPPPPPPP with SSSSSSSS failed on EEEEEEEE

**Explanation:** LibraryStation was unable to signal process PPPPPPPP with signal SSSSSSSS. Error return code was EEEEEEEE.

**System Action:** The process signaled is assumed to be terminated. LibraryStation processing continues.

**User Response:** If the problem persists, contact StorageTek Software Support.

**SLS3919I**

LS is now idle/idle pending/running

**Explanation:** LibraryStation has received an Idle or Start command. The command status is idle, idle pending, or running.

**System Action:** When LibraryStation is idle, no network requests are accepted or processed.

When LibraryStation is idle pending, all outstanding network requests are processed until the queue of requests is empty or until the time limit of 5 minutes has transpired. If the time limit expires, all remaining requests are canceled and LibraryStation will become idle.

When LibraryStation is running, network requests are accepted and processed.

**User Response:** None.

**SLS3924I**

Unexpected command CCCCCCCC

**Explanation:** LibraryStation has detected a request with an unexpected command type CCCCCCCC.

**System Action:** The request is not processed. LibraryStation processing continues.

**User Response:** If the problem persists, contact StorageTek Software Support.

**SLS3931I**

Unexpected request originator 00000000

**Explanation:** A LibraryStation request processor received a request from a type 00000000 process.

**System Action:** The request is ignored and the request processor terminates. LibraryStation processing continues.

**User Response:** If the problem persists, contact StorageTek Software Support.

**SLS3932I**

Unexpected signal SSSSSSSS

**Explanation:** A LibraryStation process received an unexpected signal SSSSSSSS.

**System Action:** The signal is ignored. LibraryStation processing continues.

**User Response:** If the problem persists, contact StorageTek Software Support.

**SLS3933I**

Unexpected state SSSSSSSS

**Explanation:** A LibraryStation process encountered a LibraryStation state SSSSSSSS it was not prepared for.

**System Action:** The process may or may not be able to recover; normally it will terminate. LibraryStation processing continues.

**User Response:** If the problem persists, contact StorageTek Software Support.

**SLS3934I**

Unexpected status SSSSSSSS

**Explanation:** A LibraryStation process encountered a LibraryStation status SSSSSSSS it was not prepared for.

**System Action:** The process may or may not be able to recover; normally it will terminate. LibraryStation processing continues.

**User Response:** If the problem persists, contact StorageTek Software Support.

**SLS3935I**

Unexpected type TTTTTTTT

**Explanation:** A LibraryStation process encountered a LibraryStation type TTTTTTTT it was not prepared for.

**System Action:** The process may or may not be able to recover; normally it will terminate. LibraryStation processing continues.

**User Response:** If the problem persists, contact StorageTek Software Support.

**SLS3939I**

Unsupported version VVVVVVVV packet discarded

**Explanation:** LibraryStation has received a request with an unsupported version VVVVVVVV.

**System Action:** Processing of the request is terminated and the request is discarded. LibraryStation processing continues.

**User Response:** Determine the LibraryStation network client(s) that is incompatible with the LibraryStation release being used. If the problem persists, contact StorageTek Software Support.

**SLS3944I**

CCCCCCCCCCCCCCCCCCCCCCCCCCCCCCCC

**Explanation:** An error occurred in LibraryStation.  
CCCCCCCCCCCCCCCCCCCCCCCCCCCCCCCC contains information about where the error occurred.

**System Action:** The active task terminates. A dump may be taken prior to the issuance of this message.

**User Response:** If LibraryStation terminates, attempt to restart it with the LS INIT operator command. If LibraryStation continues to fail, contact StorageTek Software Support.

**SLS3945I**

CCCCCCC1 authorize failed; client NNNNNNNNNNNNNNNN CCCCCCCC2  
tried CCCCCC3 of CCCCCCCC4(VVVVVV)

**Explanation:** A LibraryStation client, netaddr NNNNNNNNNNNNNNNN, userid CCCCCCCC2 (VOLACC(YES)) or the HSC address space (VOLAUTH(YES)) has attempted to access a volume and has been denied. The client issued a command CCCCCC1 that required authority READ or UPDATE to the volume. The volume VVVVVV is defined in security class CCCCCCCC4.

**System Action:** The client request is rejected. LibraryStation processing continues.

**User Response:** If the problem persists, contact your security administrator.

**SLS3946I**

CCCCCCC1 received CCCCCC2 error rc = EE1 rsn = EE2 A nonzero return code was received from XCF macro CCCCCC2 The hexadecimal return code is EE1. The hexadecimal reason code is EE2.

**Explanation:** Depending of the severity of the problem, XCF signalling may continue.

**User Response:** Locate the return and reason code for the specified macro in the appropriate IBM manual documenting the XCF macros and attempt to correct the problem. For IXCJOIN, return code 8, reason code 8 indicates that the member already exists. If the problem persists, contact StorageTek Software Support.

**SLS3947I**

CCCCCCC1 received error rc = EE from CCCCCC2

**Explanation:** While processing requests related to XCF, the hexadecimal return code EE was received.

**System Action:** Depending of the severity of the problem, XCF signalling may continue.

**User Response:** Contact StorageTek Software Support.

**SLS3998I**

Format undefined for message code DDDD

**Explanation:** A LibraryStation module attempted to issue a message but no message template exists.

**System Action:** LibraryStation processing continues.

**User Response:** Contact StorageTek Software Support.

**SLS3999I**

CCCCCCC1 received unexpected status SSSSSSSSSSSS from CCCCCC2

**Explanation:** One module CCCCCC1 received an unexpected return code from another module CCCCCC2.

**System Action:** LibraryStation processing continues.

**User Response:** Contact StorageTek Software Support.

---

## Abend Reason Codes

Under certain conditions, LibraryStation purposely abends with a user completion code 1096 (X'448'). The LibraryStation routine that issues the abend typically takes an SVC dump and produces a SYS1.DUMP data set. It provides an abend reason code that appears in register 15 when the abend occurs.

LibraryStation abend reason codes are listed in the following table:

**TABLE 6-2** Abend Reason Codes

Hex Value	Module Name	Description
X'1001'	SLGHADM	An error was detected when calling SLSSRMM to determine all valid drive and media types.
X'1002'	SLGHDRM	An error was detected when calling SLSSRMM to determine all valid media types for a specific drive type.
X'1003'	SLGHTDM	An error was detected when calling SLSSRMM to determine all valid media types for a specific drive type.

---

## System Return Codes

System return codes (also called "Errno values") are displayed with LibraryStation messages. The system return code message represents the most recent error or warning condition detected by the runtime library. If no error or warning condition is detected, the value is 0.

System return codes are listed in the following table:

**TABLE 6-3** System Return Codes

Number	Description
1	Math domain error.
2	Math range error
3	Out of memory
4	File not open.
5	File not found.
6	File attribute conflict.
7	Unsupported I/O operation.
8	No space in file.
9	Physical device error.
10	Previous error not cleared.
11	Data conversion error.

TABLE 6-3 System Return Codes (Continued)

Number	Description
12	Internal limit exceeded.
13	Undefined argument value.
14	System interface error.
15	File format errors.
16	Incorrect function usage.
17	Runtime system internal error.
18	Function precluded by runtime operations.
19	File in use.
20	Interrupted by signal.
21	Attempt to add record with duplicate key.
22	File contents correct or incorrect.
23	Program does not have access to this socket.
24	Nonblocking I/O in use and call would have blocked.
25	The connection has begun but control is returned so that the call will not block. The connection is complete when the select() call says that the socket is ready for writing.
26	(Nonblocking I/O) an earlier connect call has not yet completed.
27	The given file descriptor is not a socket.
28	Socket operation requires a destination address.
29	A datagram socket could not accommodate a message as large as this one.
30	Protocol not consistent with socket type.
31	Socket option or option level not consistent with protocol.
32	Unknown or invalid protocol.
33	Socket type not supported.
34	The call does not support this type of socket.
35	Invalid or unsupported protocol family.
36	Addressing family not supported or not consistent with socket type.
37	The given address is already in use.
38	The given address is not available on the local host.
39	Can't talk to the networking software on this machine, or the local host's network is down.
40	This host cannot reach the specified destination network.
41	The peer's host dropped or reset its network communications.
42	The local communications software aborted the connection.
43	The connection was reset by the peer.
44	The operating system did not have enough memory to perform the requested operation.



**TABLE 6-3** System Return Codes (Continued)

<b>Number</b>	<b>Description</b>
45	The socket is already connected.
46	The given socket is not connected.
47	The session has already been shut down.
48	The attempt to establish a connection times-out.
49	The connection attempt was refused.
50	Socket operation failed because the destination host was down.
51	Socket operation failed because the destination host was unreachable.
100	Dead lock.
101	TCB attach failure.
102	TCB search failure.

## Remote Procedure Call (RPC) Messages

Remote Procedure Call (RPC) messages (also called “Sperrno values”) are communication-related messages that provide information about remote communications between LibraryStation and a network client system.

RPC messages include the following:

RPC: SUCCESS

**Explanation:** Successful completion.

RPC: CAN'T ENCODE ARGUMENTS

**Explanation:** The client could not XDR the arguments it is to pass to the remote procedure.

RPC: CAN'T DECODE RESULT

**Explanation:** The client could not XDR the result returned from the remote procedure.

RPC: UNABLE TO SEND

**Explanation:** The client could not send an RPC CALL to the remote procedure.

RPC: UNABLE TO RECEIVE

**Explanation:** The client could not receive the RPC REPLY from the remote procedure.

RPC: TIMED OUT

**Explanation:** The client did not get a response from the server within an allowable amount of time.

RPC: INCOMPATIBLE VERSIONS OF RPC

**Explanation:** The version of the RPC protocol used by the server and the client are not equal.

RPC: AUTHENTICATION ERROR

**Explanation:** The authentication check failed on the remote system.

RPC: PROGRAM UNAVAILABLE

**Explanation:** The program is not available on the remote system.

RPC: PROGRAM/VERSION MISMATCH

**Explanation:** The program and version are not available on the remote system.

RPC: PROCEDURE UNAVAILABLE

**Explanation:** The requested procedure of the selected program on the remote system is not available for use.

RPC: CAN'T DECODE ARGUMENTS

**Explanation:** The remote system could not understand the arguments passed to the selected program.

RPC: REMOTE SYSTEM ERROR

**Explanation:** The remote system had a major failure while trying to execute the selected program.

RPC: UNKNOWN HOST

**Explanation:** The user selected a remote host system which is unknown to the DNR.

RPC: UNKNOWN PROTOCOL

**Explanation:** The user specified an unsupported protocol to be used for transport.

RPC: PORT MAPPER FAILURE

**Explanation:** The remote host's portmapper could not be communicated with properly.

RPC: PROGRAM NOT REGISTERED

**Explanation:** The remote program is not registered with the remote host's portmapper.

RPC: FAILED (UNSPECIFIED ERROR)

**Explanation:** The error was not specific enough to justify its own error code.

RPC: (UNKNOWN ERROR CODE)

**Explanation:** The error is not decipherable.



# Configuration Worksheet

Use this worksheet to record site-specific information generated through completion of the LibraryStation configuration tasks included in [Chapter 2](#). This worksheet is helpful as a reference for future LibraryStation configuration modifications.

1. Enter a checkmark for each installed component.

✓	Software Component	Release
	LibraryStation	
	MVS	
	HSC	
	TCP/IP	
	APPC/MVS	
	VTAM	

✓	Hardware Component
	IBM or compatible processor running MVS (any IBM-supported version of z/OS)
	StorageTek Nearline Automated Cartridge System (ACS) library hardware
	Network Interface Adaptor
	SNA network hardware
	Coupling Facility (CF) or Channel to Channel (CTC) Device

2. Check Yes or No in response to each security question.

<b>LibraryStation Security Measures</b>	<b>Yes ✓</b>	<b>No ✓</b>
Do you plan to restrict the number of tape cartridge drives the network can use?		
Do you plan to enable SAF checks?		
Do you have a SAF product installed?		
Do you plan to restrict network access to volumes?		
Do you plan to check volume authorization on a client level?		
Do you plan to define restricted volumes to a security class other than TAPEVOL?		
Are you using RACF and would you like to deny access to undefined volumes?		
Do you plan to check command authorization on a client level?		
Do you want to log volume security violations?		

3. Enter the LibraryStation hostid to be defined in the HSC LIBGEN and used as the value for the NETHOST parameter in the LSINIT statement.

LibraryStation NETHOST Hostid:	
--------------------------------	--

4. Enter the device number and associated location information for each tape cartridge drive that will be assigned to LibraryStation.

<b>ACS #</b>	<b>LSM #</b>	<b>Drive Panel #</b>	<b>Row #</b>	<b>Device #</b>	<b>Device Type</b>

5. Enter information about the parameters you will include in the LSINIT statement.

At the minimum, you **must** enter site-specific variable information for NETHOST and COMMONSP. For the remaining parameters, enter information only if you plan to override default settings. If you have more than one initializing host, prepare a separate worksheet for each host.

<b>Keyword</b>	<b>Enter Parameters for the LSINIT Control Statement</b>
COMMONSP (required)	
NETHOST (required)	
AUTHCLS	
CMDACC	
COMMTYPE	
CREQLOG	
DEFER	
HOSTID	
LSDEF	
NOPDF	
PDF	
PDFX	
POOLCHK	
REQTIME	
RETCOUNT	
RETTIME	
SYMDESTN	
TCPNAME	
TCPPORT	
VOLACC	
VOLAUTH	
VOLNOPRF	
VSECLOG	
XHREC	







## Migration and Coexistence

---

This appendix provides guidelines for migration from previous releases of LibraryStation to LibraryStation 7.2. Coexistence guidelines are also provided.

---

### Note –

- LibraryStation 7.2 does not support StorageTek Client System Component (MVS/CSC) clients. StorageTek SMC software, along with its integrated HTTP server, provides communication between MVS hosts in an MVS-only environment. Refer to the publication *Configuring and Managing SMC* for more information.
  - Your site may have specific conditions that require special precautions and procedures. If so, contact StorageTek Software Support for assistance.
- 

---

## Migration

Perform the following steps:

1. Ensure that HSC has already been migrated to release 7.2.
2. Make the LibraryStation 7.2 LINKLIB available through the MVS LINKLIST facility or a STEPLIB DD statement in the LibraryStation started task procedure.
3. Make any parameter changes necessary to enable new functionality, if desired.
4. Start LibraryStation 7.2.

---

## Coexistence

For LibraryStation, the term “coexistence” implies the ability for a specific LibraryStation release to execute with a specific HSC release.

- LibraryStation 7.2 can coexist with HSC release 7.2 only.
- LibraryStation releases prior to 7.2 cannot coexist with HSC 7.2.



## Gathering Diagnostic Materials

---

During problem resolution, StorageTek Software Support may request that you provide specific diagnostic material. While printed format may be accepted, machine readable data (on magnetic tape) is preferred. For small amounts of data, you may be requested to FAX the data. This may significantly reduce the time needed to resolve your problem.

---

### LibraryStation Diagnostic Materials

StorageTek Software Support may request the following diagnostic materials:

- Details of circumstances
- GTF Trace data set
- MVS SYSLOG
- LAN packet trace
- Dump data set
- Startup parameters defined (including LSINIT and LSDEF control statements)
- HSC LIBGEN
- Copy of HSC Control Data Set (CDS)
- Copy of LibraryStation Persistent Data File (PDF)

---

### Tape Format

If a tape of your diagnostic materials is requested, copy the requested files to tape using standard utility programs.

If a tape of your `SYSMDUMP` or `SYS1.DUMP` is requested, dump using `IEBGENER` or `IPCS DCB=(RECFM=FB,LRECL=4160,BLKSIZE=4160)`. Failure to follow this requirement may delay problem resolution.

Include a description of the tape contents, including any information necessary for StorageTek Software Support to retrieve the files from the tape (i.e., tape volume serial number and label attributes, number of tape files, file names and attributes, etc.).



# Glossary

---

This glossary defines terms and abbreviations used in this publication.

---

## A

**Abnormal end of task (abend)** A software or hardware problem that terminates a computer processing task.

**ACSid** A method used in the LIBGEN process to identify ACSs by using decimal digits, 00 to 99.

**ACS** *See* Automated Cartridge System.

**ACS library** A library is composed of one or more Automated Cartridge Systems (ACSs), attached cartridge drives, and cartridges residing in the ACSs.

**address** Coded representation of hardware id, or the destination or origination of data.

**allocation** The assignment of resources to a specific task.

**asynchronous transmission** Character-oriented data transmission (as distinct from IBM's block-mode transmission).

**Automated Cartridge System (ACS)** A fully-automated, cartridge storage and retrieval library subsystem consisting of one or more Library Storage Modules (LSMs) connected by pass-thru ports.

**Automated Cartridge System Library Software (ACSLs)** The library control software, which runs in the UNIX®-based Library Control System.

**automatic mode** A relationship between an LSM and all attached hosts. LSMs operating in automatic mode handle cartridges without operator intervention. This is the normal operating mode of an LSM that has been modified online. The opposite situation is "manual mode." *See* manual mode.

---

## B

**bar code** A code consisting of a series of bars of varying widths. This code appears on the external label attached to the spine of a cartridge and is equivalent to the volume serial number (volser). This code is read by the robot's machine vision system.

**BISYNC** Binary Synchronous Communications. An early low-level protocol developed by IBM and used to transmit data on a synchronous communications link. It is a form of data transmission in which synchronization of characters is controlled by timing signals generated at the sending and receiving stations.

---

## C

**CAPid** A CAPid uniquely defines the location of a CAP by the LSM on which it resides. A CAPid is of the form "AA:LL:CC" where "AA:LL" is the LSMid and "CC" is the two digit CAP number.

**cartridge** The plastic housing around the tape. It is approximately 4 inches (100 mm) by 5 inches (125 mm) by 1 inch (25 mm). The tape is threaded automatically when loaded in a transport. A plastic leader block is attached to the tape for automatic threading. The spine of the cartridge contains an OCR/Bar Code label listing the VOLSER (tape volume identifier).

**Cartridge Access Port (CAP)** An assembly that allows several cartridges to be inserted into or ejected from an LSM without human entry into the LSM.

**cartridge drive (CD)** A hardware device containing two or four cartridge transports and associated power and pneumatic supplies.

**cartridge tape I/O driver** Operating system software that issues commands (for example, read, write, and rewind) to cartridge subsystems. It is the software focal point for attaching a particular type of control unit. (An example is Oracle's StorageTek CARTLIB product.)

**cartridge transport** *See* transport.

**CDS** *See* Control Data Set.

**cell** A receptacle in the LSM in which a single cartridge is stored.

**CGI** Common Gateway Interface

**channel** A device that connects the host and main storage with the input and output devices' control units. A full-duplex channel has two paths (that is, 2 wires, or one wire with signals at two frequencies). A half-duplex channel requires that one port receives while the other transmits.

**channel-to-channel (CTC)** Refers to the communication (transfer of data) between programs on opposite sides of a channel-to-channel adapter.(I)

**client** The ultimate user of the ACS services as provided by the Library Control System.

**client link** The communications link between the LCS and a client.



**client-server** A model of interaction in a distributed system in which a program at one site serves a request to a program at another site and awaits a response. The requesting program is called a client; the program satisfying the request is called a server.

**client system** The system to which the LCS provides an interface to a StorageTek Automated Cartridge System.

**coaxial cable** A transmission medium used in data transmissions for networks using synchronous communications, as opposed to twisted-pair, the primary medium for asynchronous RS-232 communications.

**complex** A system composed of other systems, specifically the ACS server system and the client system.

**connected mode** A relationship between a host and an ACS. In this mode, the host and an ACS are capable of communicating (in the sense that at least one station to this ACS is online).

**connection number** The unique identifier on the server for a communications path. The number is assigned by TCP/IP to identify the unique connection between the server node and a specific port on the server, and the client node and a specific port on the client. The connection number exists only as long as the connection exists.

**console** The primary I/O device to control a session on a system.

**control data set (CDS)** The data set used by the host software to control the functions of the automated library. Also called a library database.

**Control Path Adaptor (CPA)** A Bus-Tech, Inc. hardware device that allows communications between a host processor's block multiplexer channel and a local area network.

**Control Unit (CU)** A microprocessor-based unit situated locally between a channel and an I/O device. It translates channel commands into device commands and sends device status to the channel.

**CTC** Channel-to-channel.

---

## D

**Data Path Adapter** A hardware device which translates from a client computing system's data protocol to the data protocol of the StorageTek Control Unit or IMU. An example is DEC's TC44-AA/BA STI-to-4400 ACS Interconnect.

**data set** A set of records treated as a unit.

**data sharing** The ability of concurrent subsystems or application programs to directly access and change the same data while maintaining data integrity.(I)

**device number** A four-digit hexadecimal number that uniquely identifies a device attached to a processor.

**direct access storage device (DASD)** IBM's term for a disk drive storage device.

**disconnected mode** A relationship between a host and an ACS. In this mode, the host and the ACS are not capable of communicating (there are no online stations to this ACS).

**dotted-decimal notation** The syntactic representation of a 32-bit integer that consists of four 8-bit numbers written in base ten with periods (dots) separating them. In TCP/IP descriptions, dotted-decimal notation is used for Internet addresses.

**drive panel** An LSM wall containing tape transports. The drive panel for a T9840 transport can contain either 10 or 20 transports. The drive panel for a non-T9840 transport can contain a maximum of 4 transports.

**dump** A printed representation of the contents of main storage at time *t*. This representation is used for debugging purposes.

**dynamic server switching** The capability of switching server processors when a system failure occurs on the active server.

---

## E

**ECART** Enhanced Capacity Cartridge.

**Enhanced Capacity Cartridge** A cartridge that has a length of 1100 feet and can be used only on 36-track transports (i.e., 4490, 9490, and 9490EE).

**Enterprise Systems Connection (ESCON)** A set of products and services that provides a dynamically connected environment using optical cables as a transmission medium.(I)

**error codes (EC)** Numeric codes displayed by messages indicating the type of problem that caused an error.

**error recovery procedures (ERP)** Procedures designed to help isolate and, where possible, to recover from errors in equipment.

**ESCON** Enterprise Systems Connection.

**Ethernet** One LAN architecture using a bus topology that allows a variety of computers to be connected to a common shielded coaxial spine. The Ethernet architecture is similar to the IEEE 802.3 standard.

---

## F

**file** A set of related records treated as a unit.

**File Transfer Protocol (FTP)** A TCP/IP command that provides a way to transfer files between machines connected through TCP/IP.

**foreign socket** One of two end-points in a TCP/IP connection-oriented protocol. Specifies the address of a foreign host that can connect to the server.

---

## G

**GB** 1,073,741,834 bytes of storage

---

## H

**handshake** A flow-of-control signal sent by one process to another.

**helical cartridge** A high capacity, helical scan cartridge that can hold up to 50GB of uncompressed data. This cartridge can be used only on RedWood (SD-3) transports.

**host computer** A computer that controls a network of computers.

**Host Software Component (HSC)** Software running on the Library Control System processor that controls the functions of the ACS.

**Host Software Component utilities** Utilities provided by the VM/HSC that can be executed from the HSCUTIL virtual machine. *See* client-initiated utilities.

**HSC** *See* Host Software Component.

**HTTP** Hypertext Transfer Protocol.

---

## I

**IEEE 802.3** A standard produced by the IEEE and accepted worldwide for local area networks using CSMA/CD (Carrier Sense Multiple Access with Collision Detection).

**ICRC** Improved Cartridge Recording Capacity. A compression and compaction feature that increases the amount of data that can be stored on a 1/2-inch cartridge.

**initial program load (IPL)** A process that activates a machine reset.

**Interactive Storage Management Facility** A series of applications for defining DFSMS/MVS storage groups and classes.

**Internet** A collection of networks using TCP/IP that functions as a virtual network.

**Internet address** The numbering system used to specify a network or host on that network for TCP/IP communications. Standard Internet address notation is dotted-decimal format.

**Internet Protocol (IP)** Formal description of messages and rules two networks use to exchange messages.

**ISMF** Interactive Storage Management Facility.

---

## J

**job control language (JCL)** A problem oriented language designed to describe a job's processing requirements to an operating system.

**JES** Job entry subsystem.(I)

**JES2** An MVS subsystem that receives jobs into the system, converts them to internal format, selects them for execution, processes their output, and purges them from the system. In an installation with more than one processor, each JES2 processor independently controls its job input, scheduling, and output processing. *See also* JES3.(I)

**JES3** An MVS subsystem that receives jobs into the system, converts them to internal format, selects them for execution, processes their output, and purges them from the system. In complexes that have several loosely coupled processing units, the JES3 program manages processors so that the global processor exercises centralized control over the local processors and distributes jobs to them via a common job queue. *See also* JES2.(I)

---

## L

**LAN** *See* local area network.

**LCS** *See* Library Control System.

**LCS processor console** The Library Control System processor console is used to control the VM operating system (for the VM-based LCS).

**LCU** *See* Library Control Unit.

**LIBGEN** The process of defining the configuration of a library to the VM/HSC.

**library cartridge transport** *See* transport.

**library complex** A library complex consists of one HSC Control Data Set (CDS) and may contain up to 256 Automatic Cartridge Systems (ACSs), each of which may contain up to 24 Library Storage Modules (LSMs).

**library control component** Software that controls the mounting and dismounting of cartridges in an ACS.

**library control platform** The hardware and software that provides the proper environment for the Library Control System.

**library control processor** Properly configured computer hardware that supports the operation of the Library Control System.

**Library Control Software** A library control component, the client system interface, and library utilities.

**Library Control System (LCS)** The library control platform and the Library Control Software.

**Library Control Unit (LCU)** The portion of an LSM that controls the movements of the robot.

**library database** A file or data set containing information about the location and status of the removable media volumes, such as cell location, scratch status. Also called a control data set (CDS).

**library drive** A cartridge drive in the ACS, as distinct from a stand-alone cartridge drive.

**Library Management Unit (LMU)** A hardware and software product that coordinates the activities of one or more LSMs/LCUs.

**library mode** The operation of a 4480 Cartridge Subsystem as part of a 4400 Automated Cartridge System, as opposed to manual mode, in which the operator inserts cartridges into the transports. *See* manual mode.

**LibraryStation** Software that allows MVS hosts to share ACS facilities with client systems.

**Library Storage Module (LSM)** The standard LSM (4410) a twelve-sided structure with storage space for up to around 6000 cartridges. It also contains a free-standing, vision-assisted robot that moves the cartridges between their storage cells and attached transports. *See* also PowderHorn, SL3000, SL8500, and WolfCreek.

**LMU** *See* Library Management Unit.

**local area network (LAN)** A network in a small (local) geographic area.

**local port** The designation of a given application or process among many that are available for a TCP/IP-capable host processor.

**local socket** The address combination of a TCP/IP-capable host's network address and a specific port for an application process.

**logical port (LP)** CLS software that interfaces with the client system. The CLSLP is one of the software components used to pass data between the client system and the VM/HSC.

**LP** *See* logical port.

**LSM** *See* Library Storage Module.

**LSMid** An LSMid is composed of the ACSid joined to (concatenated with) the LSM number.

**LSM number** A method used to identify an LSM. An LSM number is the result of defining the SLIACS macro LSM parameter during a LIBGEN. The first LSM listed in this parameter acquires the LSM number of 00 (decimal) the second LSM listed acquires a number of 01, and so forth, until all LSMs are identified (up to a maximum of 99).

---

## M

**manual mode** Operation of a cartridge drive apart from an ACS. *See* library mode.

**master LMU** The LMU currently controlling the functional work of the ACS in a dual LMU configuration.

**mixed configuration** A configuration that contains different types of cartridge drives in both manual and library modes.

**modem** A device that enables digital data to be transmitted over an analog transmission facility.

**multi-client** The environment where more than one (homogenous or heterogeneous) client system is connected to one LCS.

**MVS system console** The MVS/CSC provides an operator interface through the MVS system console.

---

## O

**OCR label** Optical character recognition label. An external label attached to the spine of a cartridge that is both human and machine readable.

**operator console** In this publication, the operator console refers to the MVS client system console.

**operating system (OS)** Software that controls the execution of programs that facilitate overall system operation.

---

## P

**Pass-thru Port (PTP)** A mechanism that allows a cartridge to be passed from one LSM to another in a multiple LSM ACS.

**Persistent Data File (PDF)** One or more VSAM data files that contain data objects including resource locks and drive status that are managed by the LibraryStation DBM.

**physical port** The communications hardware required to support a server/client link.

**physical volume** A physically bound unit of data file media. *See* cartridge.

**pool** A collection of tape cartridges having one or more similar features or attributes, such as a pool of scratch tapes.

**PowderHorn (9310)** The high-performance version of the standard LSM.

**pre-configured package** A storage server package including all hardware, software, and configuration parameter settings delivered by the vendor.

**product change request (PCR)** A request for enhancement to a product. Normally, this request comes from a client, but may come from Oracle.

**program temporary fix (PTF)** A software release designed to remedy one or a series of defects.

**program update tape (PUT)** One or more tapes containing updates to, or new versions of, the MVS/CSC system software.

**protocol** A formal description of message formats and the rules two or more machines must follow to exchange these messages.

---

## R

**Resource Access Control Facility (RACF)** An IBM-licensed program that provides access control by identifying and verifying the users to the system.

**recovery** Automatic or manual procedures to resolve problems in the server system.

**reel-id** Identifier of a specific tape volume. Equivalent to volume serial number (VOLSER).

**request** Term used to refer to commands issued to the 4400 ACS to perform a tape-related function.



---

## S

**scratch tape** A tape that is available to any user because it is not owned.

**scratch tape subpool** A defined subset of all scratch tapes. Subpools are composed of one or more ranges of volumes with similar physical characteristics (type of volume—reel or cartridge, reel size, length, physical location, and so on). Some installations may also subdivide their scratch pools by other characteristics such as label type.

**SD-3** The StorageTek helical cartridge transport. Also known as RedWood.

**server** A library control system such as HSC. In SMC a server is represented by a named SERVER path to a named TAPEPLEX. While the StorageTek HTTP server software component is required as the middle ware on the remote host, the server, as far as SMC is concerned is the library control system operating on the remote host.

**socket** A unique address on a network plus a node address plus the id of one specific application on a specific network. An abstraction used by TCP/IP.

**standard capacity cartridge** A cartridge that can be used on any longitudinal transport (i.e., 4480, 4490, 9490, or 9490EE).

**standby** The status of a station that has been varied online but is connected to the standby LMU of a dual LMU ACS.

**standby LMU** The redundant LMU in a dual LMU configuration that is ready to take over in case of a Master LMU failure or when the operator issues a SWITCH command.

**station** A hardware path between the host computer and an LMU over which the VM/HSC and LMU send control information.

**Storage Management Component (SMC)** Software interface between IBM's z/OS operating systems and StorageTek real and virtual tape hardware. SMC performs the allocation processing, message handling, and SMS processing for the ELS solution.

**storage server** A set of hardware and software products designed to enable heterogeneous computer systems to use automated tape cartridge library services.

**switchover** The assumption of master LMU function by the standby LMU.

**synchronous** *See* BISYNC.

**synchronous LAN** Local area network built on synchronous communications.

**Systems Network Architecture (SNA)** A description of the logical structure, formats, protocols, and operational sequences for transmitting information units through and controlling the configuration and operation of networks.

---

## T

**tape drive** A tape processing device consisting of up to four transports in a cabinet. A drive can refer to an individual transport.

**tape library management system (TLMS)** TLMS, as used in this publication, refers to any tape library management system, not to CA-1.

**TCP/IP** Transmission Control Protocol/Internet Protocol.

**trace event type** Types of event traced through the system when tracing is enabled.

**trace file** A file that contains information useful for debugging the system.

**transaction** A specific set of input that triggers the execution of a specific process.

**Transmission Control Protocol (TCP)** An inter-network standard protocol that provides a full-duplex stream service.

**transport** An electro-mechanical device used to thread, position, and read or write from a tape.

---

## U

**UCB** Unit Control Block.

**userid** Sometimes referred to as the VM userid, the userid is the name that identifies a specific “virtual machine” user or client.

**utility** Program that performs a function ancillary to the chief function(s) of a computer system.

---

## V

**virtual machine (VM)** A functional simulation of a computer and its associated devices. Each virtual machine is controlled by a suitable operating system.

**virtual storage** A feature of the OS where main storage requirements are allocated by segments (or pages) as needed by programs, thus creating the apparent existence of unlimited or virtual storage.

**Virtual Storage Manager (VSM)** A storage solution that virtualizes volumes and transports in a VTSS buffer in order to improve media and transport use.

**Virtual Tape Control System (VTCS)** The primary host code for the Virtual Storage Manager (VSM) solution. This code operates in a separate address space, but communicates closely with HSC.

**Virtual Tape Storage Subsystem (VTSS)** The DASD buffer containing virtual volumes (VTVs) and virtual drives (VTDs). The VTSS is a StorageTek RAID 6 hardware device with microcode that enables transport emulation. The RAID device can read and write "tape" data from/to disk, and can read and write the data from/to a real tape drive (RTD).

**Virtual Telecommunications Access Method (VTAM)** IBM host-resident communications software that serves as a common interface for communications.

**VM** *See* virtual machine.

**VM/SP or VM/XA** A proprietary operating system of IBM corporation that consists mainly of two major components, CP and CMS.

**volume** A tape cartridge (data carrier) that is mounted or dismounted as a unit.

**volume serial number (VOLSER)** An identifier of a physical volume.

---

## W

**WolfCreek (9360)** The high-performance LSM with a smaller capacity than the standard LSM.

---

## X

**XCF** Cross-system coupling facility.

---

## Z

**ZCART** An extended-enhanced cartridge that uses a thinner media to provide twice the capacity of the enhanced capacity (ECART) cartridge. This cartridge has a length of 2200 feet and can be used only on TimberLine 9490EE 36-track transports.

---

## Numerics

**802.3** See IEEE 802.3.

**3270** IBM synchronous, block-mode, half-duplex terminals preferred for use with IBM 370 and related types of machine.

**3270 protocol** A telecommunications protocol that supports networks of 327x CRTs on IBM mainframes.

**3274** Terminal control unit used on the ACS for processor-to-LMU communications.

**3480** IBM's 18-track half-inch cartridge tape drive model.

**3490** IBM's 36-track half-inch cartridge tape drive model.

**3590** IBM's newest cartridge tape drive model that supports 128-track recording technique.

**4400 Automated Cartridge System (ACS)** A fully automated, cartridge-based, 18-track storage and retrieval library. A 4400 ACS consists of 1 to 256 LMUs with each LMU connected to from 1 to 24 LSMs.

**4410** The standard Library Storage Module (LSM).

**4411** Library Control Unit (LCU).

**4480** The StorageTek 18-track 1/2-inch cartridge transport.

**4480 Cartridge Subsystem** The StorageTek 4480 Cartridge Subsystem consists of a control unit (CU) plus cartridge drives (CDs).

**4490** The StorageTek 36-track long-tape cartridge transport with ESCON support. Also known as Silverton.

**4780** Same as a 4480, but is used for attachment to certain non-IBM computers.

**8380** The StorageTek DASD system.

**9310** The PowderHorn, a high-performance version of the standard LSM (4410)

**9360** The WolfCreek, a high-performance LSM with a smaller capacity than the standard LSM (4410).

**9490** The StorageTek 36-track cartridge transport. Also known as TimberLine.

**9490EE** The StorageTek 36-track cartridge transport. Also known as TimberLine EE.

**SL3000** The StorageTek high performance library scalable from 200 to 3,000 cartridge slots.

**SL8500** The StorageTek high performance library scalable from 29 terabytes to 70 petabytes with up to 70,000 tape slots.

**T9840A** The StorageTek access-centric cartridge transport capable of reading and writing 9840A cartridges.

**T9840B** The StorageTek access-centric cartridge transport capable of reading and writing T9840B cartridges.

**T9840C** The StorageTek access-centric cartridge transport capable of reading and writing T9840C cartridges.

**T9840D** The StorageTek access-centric cartridge transport capable of reading and writing T9840D cartridges.

**T9940A** The StorageTek capacity-centric cartridge transport capable of reading and writing 60GB T9940A cartridges.

**T9940B** The StorageTek capacity-centric cartridge transport capable of reading and writing 200GB T9940B cartridges.

**T10000** The StorageTek high-capacity cartridge transport capable of reading and writing 120GB or 500GB T10000 cartridges.

**T10000B** The StorageTek high-capacity cartridge transport capable of reading and writing 240GB or 1TB T10000 cartridges.



# Index

---

## A

abend reason codes, 183  
Activate Standby operator command, 85  
administration  
  adding drives, 114  
  overview, 113  
  removing drives, 115  
APPC/MVS support, 34  
AUTHCLS keyword parameter, LSINIT, 64

## C

Cancel operator command, 86  
cartridge tape drives  
  access security, 36  
  adding, 114  
  removing, 115  
CLIENTID LSDEF statement  
  description, 71  
  parameters, 71  
  syntax, 71  
client-level volume authorization, 42  
Clrlock operator command, 87  
CMDACC keyword parameter, LSINIT, 64  
command access security, 46  
commands  
  Activate Standby, 85  
  Cancel, 86  
  Clrlock, 87  
  Display Cmd, 89  
  Display Drive, 90  
  Display Request, 93  
  Display Status, 95  
  Idle, 96  
  Init, 98  
  messages, 84  
  overview, 81  
  relationship to HSC commands, 82  
  Set, 100  
  Start, 102  
  Stop, 103  
  summary, 83

Trace, 105  
Vary Drive, 110  
COMMONSP keyword parameter, LSINIT, 63  
COMMTYPE keyword parameter, LSINIT, 64  
communication facilities  
  APPC/MVS support, 34  
  configuring, 31  
  LU6.2 support, 32  
  ONC/RPC support, 31  
  VTAM support, 33  
configuration  
  allocating the Persistent Data File, 50  
  client/server environments, 27  
  communication facilities, 31  
  drive device numbers, 54  
  hardware requirements, 30  
  HSC LIBGEN, 78  
  HSC started task procedure, 76  
  LibraryStation Hostid, 52  
  LSDEF data set, 70  
  LSINIT control statement, 59  
  security measures, 36  
  software requirements, 29  
  system redundancy, 28, 69  
  typical configurations, 24  
  verifying LibraryStation, 79  
conventions  
  control statements, 17  
  typographic, 13  
CREQLOG keyword parameter, LSINIT, 65  
cross host recovery, 128

## D

database manager, 50  
default scratch subpool, 63  
defer initialization at startup, 68  
DEFER keyword parameter, LSINIT, 65  
description of LibraryStation, 19  
device numbers, configuring, 54  
diagnostic tools, 117  
Display Cmd operator command, 89

Display Drive operator command, 90  
Display Request operator command, 93  
Display Status operator command, 95  
domain name resolution, 31  
drives  
    access security, 36  
    adding, 114  
    removing, 115  
dynamic server switching, 128

## E

Errno values, 183  
errors, recovery, 124  
event logging, 117

## F

failure recovery, 124  
flow of requests and responses, 21

## H

hardware components, 24  
hardware requirements, 30  
help  
    online, 84  
Host Software Component (HSC)  
    interaction with LibraryStation, 20  
    LIBGEN, 36, 78  
    request processing, 21  
    started task procedure, 76  
hostid  
    configuring, 52  
    LibraryStation, 63  
    MVS, 65  
HOSTID keyword parameter, LSINIT, 65

## I

Idle operator command, 96  
Init operator command, 98  
initializing LibraryStation, 129  
installation, LibraryStation, 23, 81, 187

## K

keyword parameters, LSINIT  
    AUTHCLS, 64  
    CMDACC, 64  
    COMMONSP, 63  
    COMMTYPE, 64  
    CREQLOG, 65  
    DEFER, 65  
    HOSTID, 65  
    LSDEF, 65  
    NETHOST, 63  
    NOPDF, 66  
    PDF, 66

PDFX, 66  
POOLCHK, 66  
REQTIME, 66  
RETCOUNT, 66  
RETTIME, 66  
SYMDESTN, 67  
TCPNAME, 67  
TCPPOINT, 67  
VOLACC, 68  
VOLAUTH, 68  
VOLNOPRF, 68  
VSECLOG, 68  
XHREC, 68

keywords, SLGDIAG utility, 122

## L

LIBGEN, Host Software Component, 36, 78  
LibraryStation  
    administration, 113  
    client/server environments, 27  
    command summary, 83  
    default scratch subpool, 63  
    description, 19  
    failure recovery, 124  
    hardware requirements, 30  
    hostid, 63  
    how it works, 20  
    installation, 23, 81, 187  
    LSDEF data set, 75  
    messages, 84  
    operating states, 84  
    request processing, 21  
    software and hardware components, 24  
    software requirements, 29  
    starting, 129  
    stopping, 130  
logging, 117  
LSDEF data set  
    allocating, 75  
    configuring, 70  
LSDEF file statements  
    CLIENTID, 71  
    SPNUM, 72  
    VIRTACS, 74  
LSDEF keyword parameter, LSINIT, 65  
LSINIT control statement  
    AUTHCLS keyword parameter, 64  
    CMDACC keyword parameter, 64  
    COMMONSP keyword parameter, 63  
    COMMTYPE keyword parameter, 64  
    configuring, 59  
    CREQLOG keyword parameter, 65  
    DEFER keyword parameter, 65  
    format, 59  
    HOSTID keyword parameter, 65  
    keyword parameters, 60



- LSDEF keyword parameter, 65
- NETHOST keyword parameter, 63
- NOPDF keyword parameter, 66
- PDF keyword parameter, 66
- PDFX keyword parameter, 66
- POOLCHK keyword parameter, 66
- REQTIME keyword parameter, 66
- RETCOUNT keyword parameter, 66
- RETTIME keyword parameter, 66
- SYMDESTN keyword parameter, 67
- TCPNAME keyword parameter, 67
- TCPPORT keyword parameter, 67
- VOLACC keyword parameter, 68
- VOLAUTH keyword parameter, 68
- VOLNOPRF keyword parameter, 68
- VSECLOG keyword parameter, 68
- XHREC keyword parameter, 68
- LSINIT control statement, modifying, 116
- LU6.2 support, 22

## M

- messages, 84
  - abend reason codes, 183
  - descriptions, 132
  - format, 132
  - listing, 134
  - RPC messages, 186
  - system return codes, 183
  - variable definitions, 133
- multiple host configuration, 28

## N

- NETHOST keyword parameter, LSINIT, 63
- network diagnostic tools, 124
- network-level volume authorization checks, 38
- NOPDF keyword parameter, LSINIT, 66

## O

- ONC/RPC support, 31
- online help, 84
- operating states, 84
- overview, LibraryStation commands, 81

## P

- PDF keyword parameter, LSINIT, 66
- PDFX keyword parameter, LSINIT, 66
- Persistent Data File (PDF)
  - allocating, 50
  - description, 50
  - failure recovery, 125
  - rebuilding, 125
- POOLCHK keyword parameter, LSINIT, 66

## R

- RACROUTE calls, 36
- REQTIME keyword parameter, LSINIT, 66
- request processing, 21
- requirements
  - hardware, 30
  - software, 29
- RETCOUNT keyword parameter, LSINIT, 66
- RETTIME keyword parameter, LSINIT, 66
- return codes, 183
- RPC messages, 186

## S

- scratch pool processing, 47
- SCRPOOL control statement, 45
- security measures
  - client volume authority, defining, 68
  - client-level volume authorization, 42
  - command access, 46
  - command volume authority, defining, 64
  - drive access, 36
  - subpools, 45
  - summary, 49
  - volume access, 36
  - volume authority, defining, 68
- security measures, configuring, 36
- Set operator command, 100
- SLGDIAG utility, 79
  - keywords, 122
  - using, 119
- software components, 24
- software requirements, 29
- Sperrno values, 186
- SPNUM LSDEF statement
  - description, 72
  - example, 73
  - parameters, 72
  - syntax, 72
- Start operator command, 102
- started task procedure, HSC, 76
- starting LibraryStation, 129
- Stop operator command, 103
- stopping LibraryStation, 130
- subpool security implications, 45
- subpool, default scratch, volume security, 47
- SYMDESTN keyword parameter, LSINIT, 67
- syntax
  - CLIENTID LSDEF statement, 71
  - SPNUM LSDEF statement, 72
  - VIRTACS LSDEF statement, 74
- SYSLOG entries, 117
- System Authorization Facility (SAF), 36, 38, 42, 46
- system redundancy, 28, 69

system return codes, 183

## **T**

tape cartridge drives

- access security, 36

- adding, 114

- changing device numbers, 115

- removing, 115

tape format, 197

TCP\_IP\_PREFIX High Level Qualifier, 32

TCPNAME keyword parameter, LSINIT, 67

TCP\_PORT keyword parameter, LSINIT, 67

tools, network diagnostic, 124

Trace operator command, 105

tracing, 118

## **V**

variable definitions, 133

Vary Drive operator command, 110

verification, configuration, 79

VIRTACS LSDEF statement

- description, 74

- parameters, 74

- syntax, 74

VOLACC keyword parameter, LSINIT, 68

VOLAUTH keyword parameter, LSINIT, 68

VOLNOPRF keyword parameter, LSINIT, 68

volume access security, 36

VSECLOG keyword parameter, LSINIT, 68

VTAM support, 33

## **X**

XHREC keyword parameter, LSINIT, 68