

Oracle Utilities
Application Framework
Administration Guide
Release 4.2.0 Service Pack 2
E37885-04

December 2013

Oracle Utilities Application Framework Administration Guide

Release 4.2.0 Service Pack 2

E37885-04

December 2013

Copyright © 2000, 2013, Oracle and/or its affiliates. All rights reserved.

This software and related documentation are provided under a license agreement containing restrictions on use and disclosure and are protected by intellectual property laws. Except as expressly permitted in your license agreement or allowed by law, you may not use, copy, reproduce, translate, broadcast, modify, license, transmit, distribute, exhibit, perform, publish, or display any part, in any form, or by any means. Reverse engineering, disassembly, or decompilation of this software, unless required by law for interoperability, is prohibited.

If this is software or related documentation that is delivered to the U.S. Government or anyone licensing it on behalf of the U.S. Government, the following notice is applicable:

U.S. GOVERNMENT END USERS: Oracle programs, including any operating system, integrated software, any programs installed on the hardware, and/or documentation, delivered to U.S. Government end users are "commercial computer software" pursuant to the applicable Federal Acquisition Regulation and agency-specific supplemental regulations. As such, use, duplication, disclosure, modification, and adaptation of the programs, including any operating system, integrated software, any programs installed on the hardware, and/or documentation, shall be subject to license terms and license restrictions applicable to the programs. No other rights are granted to the U.S. Government.

This software or hardware is developed for general use in a variety of information management applications. It is not developed or intended for use in any inherently dangerous applications, including applications that may create a risk of personal injury. If you use this software or hardware in dangerous applications, then you shall be responsible to take all appropriate fail-safe, backup, redundancy, and other measures to ensure its safe use. Oracle Corporation and its affiliates disclaim any liability for any damages caused by use of this software or hardware in dangerous applications.

Oracle and Java are registered trademarks of Oracle and/or its affiliates. Other names may be trademarks of their respective owners. Intel and Intel Xeon are trademarks or registered trademarks of Intel Corporation. All SPARC trademarks are used under license and are trademarks or registered trademarks of SPARC International, Inc. AMD, Opteron, the AMD logo, and the AMD Opteron logo are trademarks or registered trademarks of Advanced Micro Devices. UNIX is a registered trademark of The Open Group.

This software or hardware and documentation may provide access to or information on content, products, and services from third parties. Oracle Corporation and its affiliates are not responsible for and expressly disclaim all warranties of any kind with respect to third-party content, products, and services. Oracle Corporation and its affiliates will not be responsible for any loss, costs, or damages incurred due to your access to or use of third-party content, products, or services.

Contents

Overview.....	19
Defining General Options.....	20
Defining Installation Options.....	20
Installation Options - Main.....	20
Installation Options - Messages.....	21
Installation Options - Algorithms.....	21
Installation Options - Accessible Modules.....	23
Installation Options - Installed Products.....	23
Support For Different Languages.....	23
User Language.....	24
Additional Topics.....	24
Defining Languages.....	24
Defining Countries.....	25
Country - Main.....	25
Country - States.....	26
Defining Currency Codes.....	26
Defining Time Zones.....	26
Designing Time Zones.....	27
Setting Up Time Zones.....	27
Setting Up Seasonal Time Shift.....	28
Defining Geographic Types.....	28
Defining Work Calendar.....	29
Defining Display Profiles.....	29
Defining Phone Types.....	30
Setting Up Characteristic Types & Values.....	31
There Are Four Types Of Characteristics.....	31
Searching By Characteristic Values.....	31
Characteristic Type - Main.....	32
Characteristic Type - Characteristic Entities.....	33
Setting Up Foreign Key Reference Information.....	33
Information Description Is Dynamically Derived.....	34
Navigation Information Is Dynamically Derived.....	34
Search Options.....	35
Foreign Key Reference - Main.....	35
Defining Feature Configurations.....	36
Feature Configuration - Main.....	36
Feature Configuration - Messages.....	37
Defining Master Configurations.....	37
Setting Up Master Configurations.....	37
Master Configuration.....	37
Master Configuration Details.....	38
Miscellaneous Topics.....	38
Attachments.....	38
Attachment Information — Main.....	38
Creating an Attachment Business Object.....	38
Module Configuration.....	39
Menu Item Suppression.....	39
Menu Suppression.....	39
Turn Off A Function Module.....	40

Global Context Overview.....	40
System Data Naming Convention.....	40
Base Product System Data.....	40
Implementation System Data.....	41
Caching Overview.....	41
Server Cache.....	41
Client Cache.....	43
Debug Mode.....	43
System Override Date.....	44
Advanced Search Options.....	44
Defining Security & User Options.....	45
The Big Picture of Application Security.....	45
Application Security.....	45
Importing LDAP Users and User Groups.....	46
Action Level Security.....	47
Field Level Security.....	47
Encryption and Masking.....	48
Identify the Fields to Be Masked.....	48
Create a Security Type For Each Logical Field.....	48
Create An Algorithm For Each Security Type.....	49
Create A Feature Configuration For Each Secured Element.....	49
Grant Access Rights To The User Groups.....	52
Additional Masking Information.....	52
The Base Package Controls One User, One User Group, And Many Application Services..	53
How To Copy User Groups From The Demonstration Database.....	53
If You Work In A Non-English Language.....	54
One Time Only - Set Up A DB Process To Copy User Groups.....	54
Run The Copy User Groups DB Process.....	54
The Big Picture of Row Security.....	55
Access Groups, Data Access Roles and Users.....	55
Defining Application Services.....	56
Application Service - Main.....	56
Application Service - Application Security.....	56
Defining Security Types.....	57
Security Type - Main.....	57
Defining User Groups.....	57
User Group - Main.....	58
User Group - Application Services.....	58
User Group - Users.....	59
Defining Access Groups.....	59
Defining Data Access Roles.....	60
Data Access Role - Main.....	60
Data Access Role - Access Group.....	60
Defining Users.....	61
User Interface Tools.....	62
Defining Menu Options.....	62
Menu - Main.....	62
Menu - Menu Items.....	63
The Big Picture of System Messages.....	65
Defining System Messages.....	65
Message - Main.....	65
Message - Details.....	66
The Big Picture of Portals and Zones.....	67
Portals Are Made Up of Zones.....	67

Zones May Appear Collapsed When a Page Opens.....	67
Changing Portal Preferences.....	67
Zones Appear By Default.....	68
Granting Access to Zones.....	68
Zone Type vs. Zone.....	68
Fixed Zones versus Configurable Zones.....	69
There Are Three Types of Portals.....	69
Common Characteristics of Stand-Alone Portals.....	70
Putting Portals on Menus.....	70
Granting Access to A Portal.....	70
Portal Hierarchies.....	71
Custom Look and Feel Options.....	71
User Interface.....	71
UI Map Help.....	72
Setting Up Portals and Zones.....	72
Defining Zone Types.....	72
Defining Zones.....	79
Zone - Main.....	79
Zone - Portal.....	80
Zone How To Guide.....	80
How to Add a New Zone.....	80
Zone Help Text.....	81
Maintaining Embedded Help.....	82
Defining Context-Sensitive Zones.....	82
Defining Portals.....	83
Defining Display Icons.....	84
Defining Navigation Keys.....	85
Navigation Key Types.....	85
Navigation Key vs. Navigation Option.....	85
The Flexibility of Navigation Keys.....	85
Linking to External Locations.....	86
Overriding Navigation Keys.....	86
Maintaining Navigation Key.....	86
Defining Navigation Options.....	87
Navigation Option - Main.....	88
Navigation Option - Tree.....	89
Defining COBOL Program Options.....	90
COBOL Program - Main.....	90
Database Tools.....	91
Defining Environment Reference Options.....	91
Defining Table Options.....	92
Table - Main.....	92
Table - Table Field.....	94
Table - Constraints.....	94
Table - Referred by Constraints.....	95
Defining Field Options.....	96
Field - Main.....	96
Field - Tables Using Field.....	97
Defining Maintenance Object Options.....	97
Maintenance Object - Main.....	97
Maintenance Object - Options.....	98
Maintenance Object - Algorithms.....	98
Maintenance Object - Maintenance Object Tree.....	99
Defining Database Process Options.....	100

Database Process - Main.....	100
Database Process - DB Process Tree.....	101
Defining Database Process Instruction Options.....	101
Database Process Instruction - Main.....	101
Database Process Instruction - DB Process Instruction Tree.....	103
Defining Look Up Options.....	103
Lookup - Main.....	103
Defining Extendable Lookups.....	104
Extendable Lookup - Main.....	104
The Big Picture Of Audit Trails.....	105
Captured Information.....	105
How Auditing Works.....	105
The Audit Trail File.....	106
How To Enable Auditing.....	106
Turn On Auditing For a Table.....	106
Specify The Fields and Actions To Be Audited.....	107
Audit Queries.....	107
Audit Query by User.....	107
Audit Query by Table / Field / Key.....	108
Bundling.....	109
About Bundling.....	109
Sequencing of Objects in a Bundle.....	109
Recursive Key References.....	110
Owner Flags on Bundled Entities.....	110
Configuring Maintenance Objects for Bundling.....	110
Making Maintenance Objects Eligible for Bundling.....	111
Adding a Foreign Key Reference.....	111
Creating a Physical Business Object.....	111
Creating a Bundling Add Business Object.....	111
Adding the Current Bundle Zone.....	112
Adding a Customized Entity Search Query Zone to the Bundle Export Portal.....	112
Working with Bundles.....	113
Creating Export Bundles.....	113
Creating and Applying Import Bundles.....	114
Editing Export Bundles.....	114
Editing Import Bundles.....	114
Revision Control.....	115
About Revision Control.....	115
Turning On Revision Control.....	115
Configuring Maintenance Objects for Revision Control.....	116
Working with Revision Control.....	116
Checking Out an Object.....	117
Checking In an Object.....	117
Reverting Changes.....	117
Forcing a Check In or Restore.....	118
Deleting an Object.....	118
Restoring an Object.....	118
Working with Revision History.....	118
Searching for Revision History.....	119
To Do Lists.....	120
The Big Picture of To Do Lists.....	120
To Do Entries Reference A To Do Type.....	120
To Do Entries Reference A Role.....	121
To Do Entries Can Be Rerouted (Or Suppressed) Based On Message Number.....	121

The Priority Of A To Do Entry.....	122
Working On A To Do Entry.....	123
Launching Scripts When A To Do Is Selected.....	123
To Do Entries Have Logs.....	123
How Are To Do Entries Created?.....	123
To Do Entries Created By Background Processes.....	124
Dedicated To Do Background Processes.....	124
To Dos Created for Object-Specific Error Conditions.....	124
To Dos Created by Background Processes for Specific Conditions.....	125
To Do Entries Created By Algorithms.....	125
To Do Entries Created Via an XAI Service.....	125
To Do Entries Created Manually.....	125
The Lifecycle Of A To Do Entry.....	126
Linking Additional Information To A To Do Entry.....	127
Implementing Additional To Do Entry Business Rules.....	127
To Do Entries May Be Routed Out Of The System.....	127
Periodically Purging To Do Entries.....	128
Setting Up To Do Options.....	129
Installation Options.....	129
To Do Information May Be Formatted By An Algorithm.....	129
Set Additional Information Before A To Do Is Created.....	129
Alerts.....	129
Next Assignment Algorithm.....	129
Messages.....	130
Feature Configuration.....	130
Defining To Do Roles.....	130
To Do Role - Main.....	130
To Do Role - To Do Types.....	131
Defining To Do Types.....	131
To Do Type - Main.....	131
To Do Type - Roles.....	132
To Do Type - Sort Keys.....	132
To Do Type - Drill Keys.....	133
To Do Type - Message Overrides.....	133
To Do Type - To Do Characteristics.....	133
To Do Type - Algorithms.....	134
List of System To Do Types.....	135
Implementing The To Do Entries.....	135
Defining Background Processes.....	136
The Big Picture of Background Processes.....	136
Background Processing Concepts.....	136
Parameters Supplied To Background Processes.....	137
Override Maximum Errors in Batch Process Parameter.....	138
Extra Parameters.....	139
Indicating a File Path.....	139
Processing Errors.....	139
System Background Processes.....	140
Submitting Batch Jobs.....	140
Technical Implementation Of Online Batch Submission.....	140
A PERL Program Determines If There's Work To Do.....	140
A Common Routine Is Invoked When Batch Programs Complete.....	141
Polling Frequency.....	141
Parallel Background Processes.....	142
Optimal Thread Count.....	142

How to Re-extract Information.....	143
How to Submit Batch Jobs.....	143
How to Track Batch Jobs.....	143
How to Restart Failed Jobs and Processes.....	143
Defining Batch Controls.....	144
Batch Control - Algorithms.....	145
The Big Picture of Requests.....	146
Request Type Defines Parameters.....	146
Previewing and Submitting a Request	146
To Do Summary Email.....	146
Exploring Request Data Relationships.....	147
Defining a New Request.....	147
Setting Up Request Types.....	147
Maintaining Requests.....	148
Defining Algorithms.....	149
The Big Picture Of Algorithms.....	149
Algorithm Type Versus Algorithm.....	150
How To Add A New Algorithm.....	150
Minimizing The Impact Of Future Upgrades.....	150
Setting Up Algorithm Types.....	151
List of Algorithm Types.....	152
Setting Up Algorithms.....	152
Defining Script Options.....	153
The Big Picture Of Scripts.....	153
Scripts Are Business Process-Oriented.....	153
A Script Is Composed Of Steps.....	154
Designing And Developing Scripts.....	154
A Script May Declare Data Areas.....	154
Designing Generic Scripts.....	155
Securing Script Execution.....	155
You Can Import Sample Scripts From The Demonstration Database.....	155
The Big Picture Of BPA Scripts.....	155
How To Invoke Scripts.....	156
Developing and Debugging Your BPA Scripts.....	156
Launching A Script From A Menu.....	156
Launching A Script When Starting The System.....	157
Executing A Script When A To Do Entry Is Selected.....	157
The Big Picture Of Script Eligibility Rules.....	158
Script Eligibility Rules Are Not Strictly Enforced.....	158
You Can Mark A Script As Always Eligible.....	158
You Can Mark A Script As Never Eligible.....	158
Criteria Groups versus Eligibility Criteria.....	159
Defining Logical Criteria.....	160
Examples Of Script Eligibility Rules.....	160
A Script With A Time Span Comparison.....	160
A Script With Service Type Comparison.....	161
Examples of BPA Scripts.....	162
Set Up/Change Customer Web Self-Service Password.....	162
Create A Trouble Order Without An Account.....	163
Add A New Person To An Account.....	166
Reprint A Bill - Long Version.....	171
Reprint A Bill - Short Version.....	174
Payment Extensions.....	176
The Big Picture Of Server-Based Scripts.....	181

Plug-In Scripts.....	181
A Plug-In Script's API.....	181
Setting Up Plug-In Scripts.....	182
Service Scripts.....	182
A Service Script's API.....	183
Invoking Service Scripts.....	183
Debugging Server-Based Scripts.....	183
How To Copy A Script From The Demonstration Database.....	183
If You Work In A Non-English Language.....	184
One Time Only - Set Up A DB Process To Copy Scripts.....	184
Run The Copy Scripts DB Process.....	185
Maintaining Scripts.....	185
Script - Main.....	185
Script - Step.....	186
How To Set Up Each Step Type.....	187
Common Step Types To All Script Types.....	187
Step Types Applicable to BPA Scripts only.....	192
Additional Topics.....	198
How To Find The Name Of User Interface Fields.....	198
How To Find The Name Of Page Data Model Fields.....	199
How To Find The Name Of A Button.....	199
How To Substitute Variables In Text.....	201
How To Use HTML Tags And Spans In Text Strings and Prompts.....	201
How To Use Constants In Scripts.....	201
How To Use Global Variables.....	202
How To Name Temporary Storage Fields.....	202
How To Work With Dates.....	202
How To Use To Do Fields.....	204
How To Reference Fields In Data Areas.....	205
Script - Data Area.....	205
Script - Schema.....	206
Script - Eligibility.....	206
Merging Scripts.....	208
Script Merge.....	208
Resequencing Steps.....	209
Removing a Step from Script.....	209
Adding a Step to a Script.....	210
Removing an Uncommitted Step from a Script.....	210
Maintaining Functions.....	210
Function - Main.....	211
Function - Send Fields.....	211
Function - Receive Fields.....	212
Data Synchronization.....	213
Defining Sync Requests.....	213
The Big Picture of Sync Requests.....	213
Capturing the Change.....	213
Sync Request Maintenance Object.....	214
Sync Request Business Object.....	214
Designing Your Sync Requests.....	215
Sync Requests.....	215
Sync Request Query.....	215
Sync Request Portal.....	216
Sync Request Actions.....	216
Related Sync Request.....	216

Sync Request.....	216
Sync Request - Log.....	216
Application Viewer.....	217
Application Viewer Toolbar.....	217
Data Dictionary Button.....	217
Physical and Logical Buttons.....	217
Collapse Button.....	218
Attributes and Schema Button.....	218
Maintenance Object Button.....	218
Group and Ungroup List Buttons.....	218
Algorithm Button.....	219
Batch Control Button.....	219
To Do Type Button.....	219
Description and Code Buttons.....	219
Cobol Source Button.....	219
Load Source Button.....	220
Used By and Uses Buttons.....	220
Service XML Button.....	220
Select Service Button.....	221
Java Docs Button.....	221
Classic Button.....	221
Preferences Button.....	221
Help Button.....	221
About Button.....	222
Slider Icon.....	222
Data Dictionary.....	222
Using the Data Dictionary List Panel.....	222
Primary And Foreign Keys.....	222
Field Descriptions Shown.....	223
Using the Data Dictionary Detail Panel.....	223
Related Tables View.....	223
Table Detail View.....	223
Column Detail View.....	224
Lookup Values.....	224
Maintenance Object Viewer.....	224
Using the Maintenance Object List Panel.....	224
Using the Maintenance Object Detail Panel.....	225
Algorithm Viewer.....	225
Using the Algorithm Viewer List Panel.....	225
Using the Algorithm Plug-In Spot Detail Panel.....	225
Using the Algorithm Type Detail Panel.....	225
Using the Algorithm Detail Panel.....	226
Batch Control Viewer.....	226
Using the Batch Control Viewer List Panel.....	226
Using the Batch Control Detail Panel.....	226
To Do Type Viewer.....	226
Using the To Do Type Viewer List Panel.....	227
Using the To Do Type Detail Panel.....	227
Source Code Viewer.....	227
Using the Source Code Viewer List Panel.....	227
Using the Source Code Viewer Detail Panel.....	228
Service XML Viewer.....	228
Using the Service XML Viewer Overview Panel.....	228
Using the Service XML Viewer Detail Panel.....	228

Java Docs Viewer.....	229
Using the Java Docs Viewer List Panel.....	229
Using the Java Package Detail Panel.....	229
Using the Java Interface / Class Detail Panel.....	229
Application Viewer Preferences.....	229
Application Viewer Stand-Alone Operation.....	230
Stand-Alone Configuration Options.....	230
Example Application Viewer Configuration.....	231
Application Viewer Generation.....	231
Defining and Designing Reports.....	233
The Big Picture Of Reports.....	233
Integration with BI Publisher and Business Objects Enterprise.....	233
Reports Must Be Multi-Language.....	233
Requesting Reports from The System.....	234
Overview of the Data - BI Publisher.....	234
Overview of the Data - Business Objects Enterprise.....	235
How To Request Reports.....	235
Viewing Reports.....	236
Configuring The System To Enable Reports.....	236
Configuring BI Publisher Reports.....	236
Configure the System to Invoke BI Publisher Real-time.....	236
Batch Scheduling in BI Publisher.....	236
Configuring Business Objects Enterprise Reports.....	236
Configure the System to Invoke Business Objects Enterprise Real-time.....	237
Batch Scheduling in Business Objects Enterprise.....	237
Defining Reporting Options.....	237
Defining Report Definitions.....	238
Report Definition - Main.....	238
Report Definition - Labels.....	238
Report Definition - Parameters.....	239
Sample Reports Supplied with the Product.....	239
How to Use a Sample Report Provided with the System.....	240
Steps Performed at Installation Time.....	240
How To Copy A Report Definition From The Demonstration Database.....	240
If You Work In A Non-English Language.....	240
One Time Only - Set Up A DB Process To Copy Reports.....	240
Run The Copy Reports DB Process.....	241
Securing Your Reports.....	242
Subreports Used with Crystal Reports.....	242
Display Company Logo and Title.....	242
Format Report Information.....	242
Labels.....	243
How To Define A New Report.....	243
Use a Sample Report as a Starting Point.....	243
Publishing Reports in BI Publisher.....	244
BI Publisher Database Access.....	244
Verify BI Publisher User Access Rights.....	244
Publishing Reports in Business Objects Enterprise.....	244
Business Objects Enterprise Database Access.....	244
Verify Parameter Definition.....	244
Verify Business Objects Enterprise User Access Rights.....	245
Designing Your Report Definition.....	245
Designing Main Report Definition Values.....	245
Designing Characteristic Types.....	245

Designing Parameters.....	246
Designing Validation Algorithms.....	246
Designing Application Services.....	247
Designing Labels.....	247
External Application Integration.....	248
Web Service Integration.....	248
Understanding Web Service Adapters.....	248
Setting Up Web Service Adapters.....	250
Web Service Adapter Query.....	250
Web Service Adapter Portal.....	250
Web Service Adapter - Main.....	250
Web Service Adapter - Log.....	250
XML Application Integration.....	251
The Big Picture of XAI.....	251
XAI Architecture.....	251
The Core Server Component.....	251
The Multi Purpose Listener (MPL).....	252
Using Oracle Service Bus (OSB) as a Replacement for MPL.....	254
The XAI Client Component.....	257
XML Background Topics.....	257
XAI Schemas.....	257
XSL Transformations.....	258
SOAP.....	259
XPath.....	259
Server Security.....	260
Inbound Messages.....	261
Synchronous Messages.....	261
Asynchronous Messages.....	262
Inbound Message Error Handling.....	267
Integration Scenarios.....	268
WSDL Catalog.....	270
Outgoing Messages.....	270
Near Real Time Messages.....	270
Real Time Messages.....	273
Designing Your XAI Environment.....	274
Installation.....	274
The XAI Source Section.....	274
The MPL Source Section.....	274
The Parameter Variables Section.....	275
The AdHoc Parameters Section.....	275
Designing XAI Inbound Services.....	276
Designing XML Schemas.....	276
Designing XSL Transformations.....	277
Designing Your Registry Options.....	277
Designing XAI JNDI Servers.....	277
Designing XAI JDBC Connections.....	278
Designing XAI JMS Connections.....	278
Designing XAI JMS Queues.....	278
Designing XAI JMS Topics.....	278
Designing XAI Formats.....	278
Designing XAI Adapters.....	280
Designing XAI Executors.....	280
Designing XAI Senders.....	281
Designing XAI Groups.....	284

Designing XAI Receivers.....	285
How To Design Outgoing Messages.....	287
Configuring the System for Outbound Messages.....	287
Configuring the System for NDS Messages.....	288
Schema Editor.....	288
Opening the Schema Editor.....	288
Schema Editor Window.....	288
Validating a Schema.....	291
Schema Validation Errors.....	291
Registering a Service.....	292
Testing a Schema.....	292
System Wide Functions for Schema Editor.....	292
Application Standards.....	292
The File Menu.....	292
The View Menu.....	293
The Schemas Menu.....	293
The Export Menu.....	293
The Options Menu.....	294
The Tools Menu.....	294
Setting Up Your XAI Environment.....	295
XAI Class.....	295
XAI Envelope Handler.....	295
Setting Up Your Registry.....	296
XAI Option.....	296
XAI JNDI Server.....	299
XAI JDBC Connection.....	299
XAI JMS Connection.....	300
XAI JMS Queue.....	300
XAI JMS Topic.....	300
XAI Format.....	301
XAI Adapter.....	301
XAI Executer.....	302
XAI Sender.....	302
XAI Group.....	303
XAI Receivers.....	304
Service Program.....	306
XAI Inbound Services.....	307
XAI Route Type.....	309
Defining Outbound Message Types.....	309
External Systems.....	310
External System - Main.....	310
External System - Template Use.....	311
Maintaining Your XAI Environment.....	311
XAI Submission.....	311
XAI Submission - Main.....	311
XAI Submission - Response.....	311
XAI Dynamic Submission.....	312
XAI Dynamic Submission - Main.....	312
XAI Dynamic Submission - Response.....	312
Additional XAI Tools.....	313
XAI Service Export.....	313
XAI Service Import.....	313
XAI Command.....	313
MPL Exception.....	315

Server Trace.....	315
Starting the Trace.....	315
Stopping the Trace.....	315
Trace Viewer.....	315
How To.....	316
How to Build the XML Request Document.....	316
SOAP Envelope.....	317
Document Body.....	318
Constructing Requests to Access Your Product.....	320
Structure of an XML Response Document.....	322
Normal Response.....	322
Fault Response.....	323
How To Create XML Schemas.....	323
Creating a Schema for a System Service.....	323
Creating a Schema From an XML Instance Document.....	323
Creating an XML Schema for a Sequential Input File.....	324
Creating a Schema for a Database Extract.....	325
How to Publish an XAI Service.....	326
Select the Business Object.....	327
Define the Request/Response Schemas.....	327
Register the Service.....	328
Testing a Schema Using the Schema Editor.....	328
How To Create Code Description Attribute.....	329
How To Create a Private Attribute.....	329
How To Create an XSL Transformation.....	329
XSL Transformation with W3C.....	330
Substitution Parameters For NDS Messages.....	330
How an Email Message is Constructed.....	331
How to Refresh the Runtime Copy of the Registry.....	332
Siebel Integration.....	333
Creating a Siebel VBC Definition based on a Schema.....	333
Creating a Siebel Integration Object based on a Schema.....	333
Importing Users and Groups.....	335
How Does LDAP Import Work?.....	335
Invoking The Import Process.....	335
Processing LDAP Import Requests.....	336
Setting Up Your System For LDAP Import.....	336
Defining a JNDI Server That Points to the LDAP Server.....	337
Mapping Between LDAP Objects And Base Security Objects.....	337
Mapping an LDAP Entry to a Base Object.....	337
Mapping LDAP Entry Attributes to Base Object Attributes.....	338
Describing Linked Objects.....	338
Example XML Mapping.....	339
Including Your LDAP Import Mapping in the Parameter Information Files.....	340
LDAP Import.....	340
Configuration Migration Assistant (CMA).....	342
Understanding CMA.....	342
The CMA Process Flow.....	344
Migration Assumptions, Restrictions, and Recommendations.....	345
Moving from ConfigLab to CMA.....	346
Migration Prerequisites.....	346
Migration Assistant Configuration.....	346
Preparing a Threadpool.....	347
CMA Configuration: Plans and Requests.....	347

Defining a Migration Plan.....	347
Migration Plans for Objects with CLOB-Embedded Links.....	349
Wholesale and Piecemeal Migrations.....	349
Wholesale Migrations.....	349
Piecemeal Migrations.....	350
Understanding the CMA BO Filtering Process.....	350
Defining a Migration Request.....	351
The CMA Execution Process.....	352
Exporting a Migration.....	352
Preparing an Export Data Set.....	353
Monitoring the Process.....	353
Running CMA Batch Jobs.....	354
Importing and Applying a Migration.....	356
Preparing an Import Data Set.....	357
Import Status Transition Flow.....	358
Applying Migration Changes.....	359
CMA Reference.....	359
Framework-Provided Migration Objects.....	359
CMA FAQ.....	365
Configuration Lab (ConfigLab).....	367
The Big Picture of ConfigLab.....	368
Same Word, Two Meanings.....	368
Pushing and Pulling Data Is Implemented Via Comparing.....	368
The Compare Process Is Controlled By Metadata.....	369
Maintenance Objects Are Composed of Tables.....	369
Database Processes Define The Maintenance Objects To Compare.....	369
DB Process Instructions Limit Which Objects Are Compared.....	370
Table Rules Define Which Objects Will Be Compared.....	371
Criteria Algorithms Also Define Which Objects To Compare.....	371
Processing Algorithms Perform Extra Processing.....	371
A Batch Control Must Exist.....	372
The Comparison Process Creates Root Objects.....	372
Applying Approved Changes To The Target Environment.....	373
How To Compare Objects In Two Databases.....	373
How To Copy Sample DB Processes From The Demonstration Database.....	374
If You Work In A Non-English Language.....	374
Setup A DB Process To Perform The Copy.....	374
Run CL-COPDB and CL-APPCH.....	374
Environment Management.....	375
Two Types Of Environments.....	375
Registering Environments.....	375
Deregistering ConfigLab Environments.....	376
Reregistering ConfigLab Environments.....	376
Database Users.....	376
Database Relationships.....	377
ConfigLab Database Relationships.....	377
From The Target To The ConfigLab.....	378
From The ConfigLab To The Target.....	378
Compare Target Database Relationships.....	378
How To Register a ConfigLab Environment.....	379
Oracle (EnvSetup).....	379
DB2 (EnvSetup).....	381
MS SQL Server (EnvSetup).....	382
Difference Query.....	384

Difference Query - Main.....	384
Difference Query - Difference Query.....	385
Root Object.....	386
Root Object - Main.....	386
Root Object - Data Differences.....	387
Root Object - Root Object Tree.....	387
Root Object Exception.....	388
Archiving and Purging.....	389
The Big Picture of Archiving and Purging.....	389
Storing Archived Data.....	390
How To Run ArcSetup Utility.....	390
Multi-Environment Application.....	390
Environment Roles.....	390
Archive Environment Registration.....	391
Deregistering an Environment.....	392
Reregistering an Environment.....	392
Database Users and Database Relationships.....	392
Maintaining Data Integrity.....	393
Identifying Relationships.....	394
Non-Identifying Relationships.....	394
Inter-Database Foreign Key References.....	395
Archive Process Order.....	395
Maintaining Normal System Operation.....	396
Age of Data.....	397
Status Of Data.....	397
Keys and Relationships.....	397
Aggregate Summaries.....	397
Metadata and Archive/Purge Procedures.....	398
Table Constraints Define Relationships.....	398
Maintenance Objects Group Tables.....	398
Database Processes Group Maintenance Objects For A Purpose.....	399
DB Process Instructions Drive The Process.....	400
Criteria Algorithms Exclude Records.....	401
Table Rules Also Exclude Records.....	402
Processing Algorithms Perform Extra Processing.....	402
Archive Engine.....	402
Archive and Purge Procedures.....	403
ArcSetup Preprocessing.....	403
Step 1 - Create Primary Archive Root Objects.....	403
Step 2 - Build Child Archive Root Objects for Primary Archive Root Objects.....	404
Step 3 - Recursive Integrity Check.....	405
Step 4 - Move or Delete Production Data.....	406
Archiving Data Directly to a Target Environment or Purging	406
Archiving Data to Flat Files.....	407
ArcSetup Post Processing.....	407
Lifecycle of an Archive Root Object.....	407
Developing Archive and Purge Procedures.....	408
Configure Metadata.....	408
Design and Develop Criteria Algorithms and Table Rules.....	408
Design and Develop Processing Algorithms.....	409
Design and Develop Archive Copy Processing Algorithms.....	409
Sample Archive and Purge DB Processes.....	409
How To Register an Archive Environment.....	409
EnvSetup Registration Script.....	409

Production and Archive Environments on Separate Oracle Instances.....	410
Production and Archive on the same Oracle Instance.....	410
ArcSetup.....	412
Pre-Archive Tasks.....	412
Post-Archive Tasks.....	412
Executing ArcSetup.....	412
Performance Tuning Tips For Archive.....	413
How To Copy Samples From The Demonstration Database.....	413
If You Work In A Non-English Language.....	414
Set Up A DB Process To Perform The Copy.....	414
Run The Background Processes.....	414
Set Up Archive Adjustment Type.....	415
Managing Archive Environments.....	415
Configuration Tools.....	417
Business Objects.....	417
The Big Picture of Business Objects.....	417
What Is A Business Object?.....	417
A Business Object Has Properties.....	418
A Business Object May Define Business Rules.....	419
Business Object Inheritance.....	420
Each Business Object Can Have A Different Lifecycle.....	421
Valid States versus State Transition Rules.....	421
One Initial State and Multiple Final States.....	421
State-Specific Business Rules.....	422
Inheriting Lifecycle.....	422
Auto-Transition.....	423
Keeping An Entity In Its Last Successful State.....	423
Monitoring Batch Processes.....	424
Transitory States.....	424
State Transitions Are Audited.....	424
Required Elements Before Entering A State.....	425
Defining Reasons for Entering a State.....	425
Granting Access To Business Objects.....	425
Defining Business Objects.....	426
Business Object - Main.....	426
Business Object - Schema.....	426
Business Object - Algorithms.....	427
Business Object - Lifecycle.....	428
Business Object - Summary.....	431
Maintaining Status Reasons.....	431
Business Objects with Status Reason List	431
Status Reasons	431
Business Services.....	432
Defining Business Services.....	434
Business Service - Main.....	434
Business Service - Schema.....	435
User Interface (UI) Maps.....	435
Defining UI Maps.....	437
UI Map - Main.....	437
UI Map - Schema.....	438
UI Hints.....	438
Ensuring Unique Element IDs for UI Maps.....	439
Maintaining Managed Content.....	439
Managed Content - Main.....	440

Managed Content - Schema.....	440
Data Areas.....	440
Defining Data Areas.....	440
Data Area - Main.....	441
Data Area - Schema.....	441
Schema Designer.....	441
Schema Viewer.....	442
Business Event Log.....	442
Configuring Facts.....	444
Fact Is A Generic Entity.....	444
Fact's Business Object Controls Everything.....	444
Fact Supports A Log.....	445

Chapter 1

Overview

The Administration Guide describes how to implement and configure the Oracle Utilities Application Framework. This includes:

Defining General Options on page 20

Access Groups, Data Access Roles and Users on page 55

User Interface Tools on page 62

Database Tools on page 91

To Do Lists on page 120

Defining Background Processes on page 136

Defining Algorithms on page 149

Defining Script Options on page 153

Application Viewer on page 217

Defining and Designing Reports on page 233

External Application Integration on page 248

Importing Users and Groups on page 335

Configuration Lab (ConfigLab) on page 367

Archiving and Purging on page 389

Configuration Tools on page 417

Configuring Facts on page 444

This guide contains the same content as the Framework Administration section of the online help.

Chapter 2

Defining General Options

This section describes control tables that are used throughout your product.

Defining Installation Options

The topics in this section describe the various installation options that control various aspects of the system.

Installation Options - Main

Select **Admin Menu > Installation Options - Framework** to define system wide installation options.

Description of Page

The **Environment ID** is a unique universal identifier of this instance of the system. When the system is installed, the environment id is populated with a six digit random number. While it is highly unlikely that multiple installs of the system at a given implementation would have the same environment ID, it is the obligation of the implementers to ensure that the environment ID is unique across all installed product environments.

System Owner will be **Customer Modification**.

The **Admin Menu Order** controls how the various control tables are grouped on the Admin Menu.

- If you choose **Alphabetical**, each control table appears under a menu item that corresponds with its first letter. For example, the Language control table will appear under the L menu item entry.
- If you choose **Functional**, each control table appears under a menu item that corresponds with its functional area. For example, the Language control table will appear under the General menu item entry. Note, the menu that is used when this option is chosen is the sole *menu* identified with a menu type of **Admin**.

Caution: In order to improve response times, installation options are cached the first time they are used after a web server is started. If you change the Admin Menu Order and you don't want to wait for the cache to rebuild, you must clear the cached information so it will be immediately rebuilt using current information. Refer to [Caching Overview](#) for information on how to clear the system login cache (this is the cache in which installation options are stored).

The **Language** should be set to the language in which you work.

The **Currency Code** is the default currency code for transactions in the product.

If your product supports characteristics on its objects, define the date to be used as the **Characteristic Default Date** on objects without an implicit start date. The date you enter in this field will default when new characteristics are added to these objects (and the default date can be overridden by the user).

Active Owner displays the owner of newly added system data (system data is data like algorithm types, zone types, To Do types, etc.). This will be **Customer Modification** unless you are working within a development region.

Country and **Time Zone** represent the default country and time zone that should be used throughout the application.

Turn on **Seasonal Time Shift** if your company requires seasonal time shift information to be defined.

Installation Options - Messages

Select **Admin Menu > Installation Options - Framework** and the **Messages** tab to review or enter messages that will appear throughout the application when a given event occurs.

The **Message** collection contains messages that are used in various parts of the system. For each message, define the **Installation Message Type** and **Installation Message Text**. The following table describes how the various **Message Types** are used in the system.

Message Type	How The Message Is Used
Company Title for Reports	This message appears as a title line on the sample reports provided with the system. Generally it is your company name. It is only used if you have installed reporting functionality and are using the sample reports (or have designed your reports to use this message).

Installation Options - Algorithms

Select **Admin Menu > Installation Options - Framework** and the **Algorithms** tab to review or enter the algorithms that should be evoked when a given event occurs.

The grid contains **Algorithms** that control important functions in the system. You must define the following for each algorithm:

- Specify the **System Event** with which the algorithm is associated (see the table that follows for a description of all possible events).
- Specify the **Sequence Number** and **Algorithm** for each system event. You can set the **Sequence Number** to 10 unless you have a **System Event** that has multiple **Algorithms**. In this case, you need to tell the system the **Sequence** in which they should execute.

Caution: These algorithms are typically significant processes. The absence of an algorithm might prevent the system from operating correctly.

The following table describes each **System Event**.

System Event	Optional / Required	Description
Email Service – Validate Attachments	Optional	Algorithms of this type are used to validate the attachments for size and total count while sending attachments using Email Service. Click here to see the algorithm types available for this system event.
Geocoding Service	Optional	Algorithms of this type use Oracle Locator to retrieve latitude and longitude coordinates using address information.

		Click here to see the algorithm types available for this system event.
Global Context	Optional	<p>Algorithms of this type are called whenever the value of one of the global context fields is changed. Algorithms of this type are responsible for populating other global context values based on the new value of the field that was changed.</p> <p>Refer to Global Context Overview for more information.</p> <p>Click here to see the algorithm types available for this system event.</p>
Ldap Import	Optional	<p>Algorithms of this type are called for operations on users, groups, and group memberships after they have been processed.</p> <p>Click here to see the algorithm types available for this system event.</p>
Ldap Import Preprocess	Optional	<p>Algorithms of this type are called to preprocess data retrieved from LDAP.</p> <p>Click here to see the algorithm types available for this system event.</p>
Next To Do Assignment	Optional	<p>This type of algorithm is used to find the next To Do entry a user should work on. It is called from the Current To Do dashboard zone when the user ask for the next assignment.</p> <p>Click here to see the algorithm types available for this system event.</p>
Reporting Tool	Optional	<p>If your installation has integrated with a third party reporting tool, you may wish to allow your users to submit reports on-line using report submission or to review report history online. This algorithm is used by the two on-line reporting pages to properly invoke the reporting tool from within the system.</p> <p>Click here to see the algorithm types available for this system event.</p>
SMS Receive Service	Optional	<p>This type of algorithm is used to provide SMS receive service. Only one algorithm of this type should be plugged in.</p> <p>Click here to see the algorithm types available for this system event.</p>
SMS Send Service	Optional	<p>This type of algorithm is used to provide SMS send service. If your installation uses the base algorithm that uses BPEL, you will need to create a feature configuration with the SMS Send Configuration feature type to define your Oracle BPEL server and service call details. If your installation has integrated with a third-party SMS service, you may want to override this algorithm type with your own implementation. Only one algorithm of this type should be plugged in.</p> <p>Click here to see the algorithm types available for this system event.</p>
To Do Information	Optional	<p>We use the term To Do information to describe the basic information that appears throughout the system to describe a To Do entry.</p> <p>Plug an algorithm into this spot to override the system default "To Do information".</p> <p>Click here to see the algorithm types available for this system event.</p>

Installation Options - Accessible Modules

Select **Admin Menu > Installation Options - Framework** and the **Accessible Modules** tab to view the list of accessible modules.

Description of Page

This page displays the full list of the application's function modules. A **Turned Off** indication appears adjacent to a module that is not accessible based on your system's module configuration setup.

Fastpath: Refer to [Module Configuration](#) for more information on function modules and how to turn off modules that are not applicable to your organization.

Installation Options - Installed Products

Select **Admin Menu > Installation Options - Framework** and the **Installed Products** tab to view a read only summary of the products that are installed in the application version that you are logged into.

Description of Page

The **Product Name** indicates the name of the "products" that are installed. The collection should include **Framework**, an entry for your specific product and an entry for **Customer Release**.

Release ID shows the current release of the application that is installed. This field is used by the system to ensure that the software that executes on your application server is consistent with the release level of the database. If your implementation of the product has developed implementation-specific transactions, you can populate the Release Id for the **Customer Release** entry to define the latest release of implementation-specific logic that has been applied to this environment. In order for this to work, your implementation team should populate this field as part of their upgrade scripts.

The **Release ID Suffix**, **Build Number** and **Patch Number** further describe the details of your specific product release.

The **Display** column indicates the product whose name and release information should be displayed in the title bar. Only one product sets this value to **Yes**.

Owner indicates if this entry is owned by the base package or by your implementation (**Customer Modification**).

Product Type indicates if the product is a Parallel Application. A parallel application is one that is independent of, and does not conflict with, other parallel applications. Multiple parallel applications can be installed in the same database and application server.

Note: About Information. The information on this tab is used to populate the information displayed in the [About](#) information for your product.

Support For Different Languages

User Language

The system provides support for multiple languages in a single environment. System users can use the system in their preferred language, as long as a translation into that language has been provided. By default, a user sees the system in their default language (which is defined on their *user record*). Also note, if enabled, users can use the *Switch Language Zone* to switch to another supported language real time.

Note: Normally, setting up the system for another language is an implementation issue, not an administrative set-up issue. However, there are several on-line administrative features that are used to set up a new language, and these are described here.

The following steps are required to support a new language.

- Define a language code. Refer to *Defining Languages* for more information.
- Copy descriptions of all language enabled tables from an existing translation. For example, you might copy existing English language translations. These copied values are not meant to be used by system users, but act merely as "placeholders" while they are being translated into the new language. It is necessary to do this as a first step in order to create records using the new language code created in the previous step.

Language based descriptions can be copied using a supplied batch process, *NEWLANG*.

- Assign the new language code to your User ID, sign out, and sign back in again. Any on-line functions that you access will use your new language code. (You can change the language code for all users who plan to use/modify the new language).
- Begin translations. You might start with screen labels, menus, look-up values, and error messages. On-line utilities have been provided to give you access to this system data. Refer to *User Interface Tools* and *Database Tools* for more information. All administrative control tables are language enabled as well. The descriptions (short descriptions, long descriptions, etc.) are all translatable.

Additional Topics

Your product may support additional uses for language. For example, in Oracle Utilities Customer Care and Billing, you can define each customer's language. This allows you to send bills and other correspondence in each customer's preferred language. For more information, navigate to the index entry **Languages, Customer Language**.

Defining Languages

A language code exists for every language spoken by your users. The system uses this code to supply information to users in their respective language. Select **Admin Menu > Language** to define a language.

Description of Page

Enter a unique **Language Code** and **Description** for the language.

Turn on **Language Enable** if the system should add a row for this language whenever a row is added in another language. For example, if you add a new currency code, the system will create language specific record for each language that has been enabled. You would only enable multiple languages if you have users who work in multiple languages.

The following two fields control how the contents of grids and search results are sorted by the Java virtual machine (JVM) on your web server:

- The **Locale** is a string containing three portions:
 - ISO language code (lower case, required)

- ISO country code (upper case, optional)
- Variant (optional).
- Underscores separate the various portions, and the variant can include further underscores to designate multiple variants. The specific JVM in use by your particular hardware/OS configuration constrains the available **Locales**. Validating the **Locale** against the JVM is outside the scope of this transaction. This means you are responsible for choosing valid **Locales**.

The following are examples of valid locales:

- en_US (this is for American English)
- en_AU (this is for Australian English)
- pt_BR (this is for Brazilian Portuguese)
- fr_FR_EURO (this is for European French)
- ja_JP (this if for Japanese)

In addition, the Java collation API can take a **Collator Strength** parameter. This parameter controls whether, for example, upper and lower-case characters are considered equivalent, or how accented characters are sorted. Valid values for collator strength are **PRIMARY**, **SECONDARY**, **TERTIARY**, and **IDENTICAL**. If you leave this field blank, Java will use its default value for the language. We'd like to stress that the impact of each value depends on the language.

Please see <http://java.sun.com/j2se/1.3/docs/guide/intl/locale.doc.html> for more information about the collator strength for your language.

Display Order indicates if this language is written **Left to Right** or **Right to Left**.

Owner indicates if this language is owned by the base package or by your implementation (**Customer Modification**). The system sets the owner to **Customer Modification** when you add a language. This information is display-only.

Where Used

Follow this link to open the data dictionary where you can view the tables that reference [CI_LANGUAGE](#).

Note that all administrative control tables and system metadata that contain language-specific columns (e.g., a description) reference a language code.

In addition, other tables may reference the language as a specific column. For example, on the User record you indicate the preferred language of the user.

Defining Countries

The topics in this section describe how to maintain countries.

Country - Main

To add or review Country definitions choose **Admin Menu > Country** .

The **Main** page is used to customize the fields and field descriptions that will be displayed everywhere addresses are used in the system. This ensures that the all addresses conform to the customary address format and conventions of the particular country you have defined.

Description of Page

Enter a unique **Country** and **Description** for the country.

The address fields that appear in the **Main** page are localization options that are used to customize address formats so that they conform to address requirements around the world. By turning on an address field, you make that field available

everywhere addresses for this country are used in the system. You can enter your own descriptions for the labels that suffix each switch; these labels will appear wherever addresses are maintained in the system.

Note: For any country where the **State** switch is checked, the valid states for the country must be entered on the **Country - State** tab. When entering address constituents on a record that captures this detail, the value for State is verified against the data in the State table. For any country where there is a component of the address that represents a "state" but your implementation does not want to populate the valid states for that country, choose a different field such as County for this constituent (and define an appropriate label). When entering address constituents on a record that captures this detail, no validation is done for the County column.

Where Used

Follow this link to open the data dictionary where you can view the tables that reference [CI_COUNTRY](#).

Country - States

To maintain the states located in a country, choose **Admin Menu > Country** and navigate to the **State** page.

Description of Page

For any country where you have enabled the State switch, use the **State** collection to define the valid states in the **Country**.

- Enter the standard postal abbreviation for the **State** or province.
- Enter a **Description** for this state or province.

Defining Currency Codes

The currency page allows you to define display options related to currency codes that are used by your system. Use **Admin Menu > Currency Code** to define the currency codes in which financial information is denominated.

Description of Page

Enter a unique **Currency** and **Description** for the currency.

Use Currency **Symbol** to define the character that prefixes currency amounts in the system (e.g., \$ for U.S. dollars).

Enter the number of **Decimals** that will appear in the notation for the currency. For example, there are two decimal positions for Australian dollars (\$5.00), but no decimal positions in the Italian lira (500 L).

The **Currency Position** indicates whether the currency symbol should be displayed as a **Prefix** or a **Suffix** to the currency amount. For example, the US Dollar symbol is a prefix before the amount (\$5.00) and the French franc symbol is a suffix after the amount (200.00FF).

Where Used

Follow this link to open the data dictionary where you can view the tables that reference [CI_CURRENCY_CD](#).

Defining Time Zones

The following topics describe how to design and set up time zones.

Designing Time Zones

Note: Customer Care and Billing - Interval Billing applications customers should consult the topic *Designing Time Zones* (search the CCB Help index for "time options") for specific information relating to CCB functionality.

It is recommended that all time sensitive data is stored in the time of the base time zone as defined on the installation options. This will prevent any confusion when analyzing data and will ensure that your algorithms do not have to perform any shifting of data that may be stored in different time zones.

The Time Zone entity is used to define all the time zones where your customers may operate. It is used by interfaces to help ensure data is stored correctly in the base time zone.

When designing your time zones, the first thing to determine is the base time zone. For an example, let's assume that your company's main office is in the US Central time zone. First, you need to define this time zone and define the seasonal time shift whose schedule it follows.

When designing your time zones, the first thing to determine is the base time zone. If, for example, your company's main office and all customers are located in the US Central time zone, you would first you need to define this time zone as well as the labels for standard time (default) and daylight savings time (shifted). Because (in this example) all business occurs in the US Central time zone, no other time zone entries are required:

Time Zone	Time Zone Name	Default Label	Shifted Label
USCentral	US/Central	CST	CDT

Once this is done you can link the time zone code to the installation option as the base time zone. Refer to [Installation Options - Main](#) for more information.

If your company does business beyond your local time zone, then you can define the other time zones where you may have customers or other systems with which you exchange data. Let's use the US time zones as an example. We'll define time zones for Eastern, Mountain, Pacific, and one for Arizona (which doesn't observe daylight savings time):

Time Zone	Time Zone Name	Default Label	Shifted Label
USCentral	US/Central	CST	CDT
USEastern	US/Eastern	EST	EDT
USMountain	US/Mountain	MST	MDT
USArizona	US/Arizona	AST	
USPacific	US/Pacific	PST	PDT

Setting Up Time Zones

All time sensitive data will be stored according to the base Time Zone defined on the installation record. The time zone table is used to define other time zones necessary for the application. When data being entered into the system is related to a time zone other than that defined on the installation record, the time zone information may be used by integration/interface logic to convert the data into the base time zone for storage on the database.

Open **Admin Menu > Time Zone** to define the time zones and their relation to the base time.

Description of Page

Enter a unique **Time Zone** and **Description** for the time zone.

Select the **Time Zone Name** from the list of Olson time zone values.

Indicate the **Shift in Minutes** that this time zone differs from the base time zone defined on the Installation Options (for *Customer Care and Billing - Interval Billing* applications only).

Indicate the **Seasonal Time Shift** applicable for this time zone (for *Customer Care and Billing - Interval Billing* applications only).

Default Time Zone Label is used to identify displayed and input times for non-shifted time. For example, the US/Central label would be **CST**. If specified, this label must be different from the Default Time Zone Label.

Shifted Time Zone Label is used to identify displayed and input times when time is shifted (typically by daylight savings time). For example, the US/Central label would be **CDT**.

Note: **Default Time Zone Label** and **Shifted Time Zone Label** are used when you need to specify if a time is shifted. For example, on a day when clocks are turned back one hour, a time entry of 1:30 a.m. needs to be labeled as either 1:30 a.m. standard time or 1:30 a.m. daylight savings time. In the US/Central time zone this would look like **13:30 CST** or **13:30 CDT**.

Where Used

Follow this link to open the data dictionary where you can view the tables that reference [CI_TIME_ZONE](#).

Setting Up Seasonal Time Shift

Note: The information in this topic applies only to Customer Care and Billing - Interval Billing applications.

Open **Admin Menu > Seasonal Time Shift** to define the seasonal time shift schedule.

Description of Page

Enter a unique **Seasonal Time Shift** code and **Description** for the seasonal time shift.

The Collection defines the **Effective Date/Time** (in standard time) that a time zone may shift in and out of standard time. If time is changed from standard time on the effective date/time, enter the **Shift in Minutes** that the time changes from standard time (usually **60**). If the time is changed back to standard time on the effective date/time, enter a **Shift in Minutes** of **0**.

Where Used

Follow this link to open the data dictionary where you can view the tables that reference [CI_SEAS_TM_SHIFT](#).

Defining Geographic Types

If your company uses geographic coordinates for dispatching or geographic information system integration, you need to setup a geographic (coordinate) type for each type of geographic coordinate you capture on your premises and/or service points (geographic coordinates can be defined on both premises and service points).

To define geographic types, open **Admin Menu > Geographic Type** .

Note: **Find a customer / premise using a geographic coordinate.** In Oracle Utilities Customer Care and Billing there are several queries that allow you to search for customers and premises by geographic type. For example, Control Central and Meter Search allow you to search using the premise or service point geographic type. Refer to the product documentation for more information.

Description of Page

Enter an easily recognizable **Geographic Type** code and **Description**.

Define the algorithm used to validate the **Validation Format Algorithm**. If an algorithm is specified, the system will validate that the geographic location entered on the premise and/or service point for the geographic type is in the format as defined in the algorithm. If you require validation, you must set up this [algorithm](#) in the system.

Click [here](#) to see the algorithm types available for this plug-in spot.

Where Used

Follow this link to open the data dictionary where you can view the tables that reference [CI_GEO_TYPE](#).

Defining Work Calendar

Workday calendars are used to ensure system-calculated dates fall on a workday. Select **Admin Menu > Work Calendar** to define a workday calendar.

Description of Page

The information on this transaction is used to define the days of the week on which your organization works.

Enter a unique **Work Calendar** and **Description**.

Turn on (check) the days of the week that are considered normal business days for your organization.

Use the collection to define the **Holiday Date**, **Holiday Start Date**, **Holiday End Date**, and **Holiday Name** for each company holiday. Holiday Start Date and Holiday End Date define the date and time that the holiday begins and ends. For example, your organization might begin a holiday at 5:00 p.m. on the day before the actual holiday.

Where Used

Follow this link to open the data dictionary where you can view the tables that reference [CI_CAL_WORK](#).

Defining Display Profiles

When you set up your [users](#), you reference a display profile. A user's display profile controls how dates, times, and numbers displayed. Choose **Admin Menu > Display Profile** to maintain display profiles.

Description of Page

Enter a unique **Display Profile ID** and **Description** to identify the profile.

Enter a **Date Format**. This affects how users view dates and how entered dates are parsed. This is a "free format" field with some rules.

- **dd** or **d** is interpreted as the day of the month. The **d** option suppresses a leading 0.
- **MM** or **M** is interpreted as the month number. The **M** option suppresses a leading 0.
- **yyyy**, **yy**, or **y** is interpreted as the year. The year can be 4 or 2 digits. The **y** option allows entry in either 2 or 4-digit form and is displayed in 2-digit form.

Note: For centuries, the default pivot for 2-digit years is **80**. Entry of a 2-digit year greater than or equal to **80** results in the year being interpreted as 19xx. Entry of a 2-digit year less than **80** results in the year being interpreted as 20xx.

- **iiii** is interpreted as a year entered and displayed in Hijri format, though the full date is still stored in the database in Gregorian format. For example, if a user enters 1435/07/30 using the default **iiii/MM/dd** Hijri date format, the date is stored in the database as 05-30-2014. If a date is stored as 06-01-2014 in the database, it is displayed to the user as 1435/08/02. Note that this functionality relies on date mapping to be defined in the Hijri to Gregorian Date Mapping [master configuration](#) entry.
- **tttt** is interpreted as a year entered and displayed in Taiwanese format where year 1911 is considered year 0000. Note that the year is still stored in the database in Gregorian format. For example, if a date in the database is 01-01-2005, it is displayed as 01-01-0094. If a user enters the date 02-02-0095, it is stored in the database as 02-02-2006. Note that this functionality relies on date mapping to be defined in the Taiwanese to Gregorian Date Mapping [master configuration](#) entry.

- Other characters are displayed as entered. Typically, these other characters should be separators, such as "-", ".", or "/". Separators are optional; a blank space cannot be used.

Here are some examples of date formats.

Format	Displayed/entered as
MM-dd-yyyy	04-09-2001
d/M/yyyy	9/4/2001
yy.MM.dd	01.04.09
MM-dd-y	04-09-01 - in this case you could also enter the date as 04-09-2001

Enter a **Time Format**. This is a "free format" display with some rules.

- **hh** or **h** is interpreted as the hour, 1-12; **KK** or **K** is interpreted as the hour, 0-11; **HH** or **H** is interpreted as the hour, 0-23; **kk** or **k** is interpreted as the hour, 1-24. The **h**, **K**, **H**, and **k** options suppress a leading 0.
- **mm** or **m** is interpreted as the minutes. The **m** option suppresses a leading 0.
- **ss** or **s** is interpreted as the seconds. The **s** option suppresses a leading 0.
- **a** is interpreted to mean display **am** or **pm** (only needed when the hour is entered in **hh**, **h**, **KK** or **K** formats). If an **am** or **pm** is not entered, it defaults to **am**.

Here are some examples of time formats.

Format	Displayed / entered as
hh:mma	09:34PM (can be entered as 09:34p)
hh:mm:ss	21:34:00
h:m:s	9:34:0

There are several options for displaying Numbers. Select the character you use as the Decimal Symbol ("." or ","), the symbol that separates the integer and decimal parts of a number. Select the character you use as the **Group Symbol** ("", ".", **None** or **Space**), i.e., the symbol used to separate 1000s. Select an option for the **Negative Format**, which dictates how negative values are displayed: -9.9, (9.9), or 9.9-.

Currency values can have a different **Negative Format** from other numbers: -s9.9, (s9.9), or s9.9-, where the "s" represents the currency symbol.

Where Used

Follow this link to open the data dictionary where you can view the tables that reference [CI_DISP_PROF](#).

For additional information, see [Defining Master Configurations](#).

Defining Phone Types

Phone types define the format for entering and displaying phone numbers.

To add or review phone types, choose **Admin Menu > Phone Type**.

Description of Page

Enter a unique **Phone Type** and **Description** for each type of phone number you support.

Select an appropriate **Phone Number Format Algorithm** for each **Phone Type**. This algorithm controls the format for entry and display of phone numbers. Click [here](#) to see the algorithm types available for this plug-in spot.

Use **Phone Type Flag** to define if this type of phone number is a **Fax** number. Defining which phone type is used for facsimile transmittal is only pertinent if your product supports routing of information via fax. For example, in Oracle Utilities Customer Care and Billing, the system may be configured to fax a bill to a customer.

Where Used

Follow this link to open the data dictionary where you can view the tables that reference [CI_PHONE_TYPE](#).

Setting Up Characteristic Types & Values

If you need to introduce additional fields to objects that were delivered with minimal fields, you can add a characteristic type for each field you want to capture. Using the characteristic type approach allows you to add new fields to objects without changing the database. There are some pages in the system that support a generic list of characteristics. For those pages, no changes are required for users to view and maintain characteristics. Other pages are business object oriented pages and their maintenance and display are controlled by the UI maps defined for the business objects. In those pages the display / maintenance of the characteristics are driven by the design of the business object and its maps.

The topics in this section describe how to setup a characteristic type.

There Are Four Types Of Characteristics

Every characteristic referenced on an object references a characteristic type. The characteristic type controls the validity of the information entered by a user when they enter the characteristic's values. For example, if you have a characteristic type on user called "skills", the information you setup on this characteristic type controls the valid values that may be specified by a user when defining another user's skills.

When you setup a characteristic type, you must classify it as one of the following categories:

- **Predefined value.** When you setup a characteristic of this type, you define the individual valid values that may be entered by a user. A good example of such a characteristic type would be one on User to define one or more predefined skills for that user. The valid values for this characteristic type would be defined in a discreet list.
- **Ad hoc value.** Characteristics of this type do not have their valid values defined in a discreet list because the possible values are infinite. Good examples of such a characteristic type would be ones used to define a user's birth date or their mother's maiden name. Optionally, you can plug-in an algorithm on such a characteristic type to validate the value entered by the user. For example, you can plug-in an algorithm on a characteristic type to ensure the value entered is a date.
- **Foreign key value.** Characteristics of this type have their valid values defined in another table. For example perhaps you want to link a user to a table where User is not already a foreign key. Valid values for this type of characteristic would be defined on the user table. Please be aware of the following in respect of characteristics of this type:
 - Before you can create a characteristic of this type, information about the table that contains the valid values must be defined on the [foreign key reference table](#).
 - The referenced table does not have to be a table within the system.
 - Not all entities that support characteristics support foreign key characteristics. Refer to the data dictionary to identify the entities that include the foreign key characteristic columns.
- **File Location.** Characteristics of this type contain a URL. The URL can point to a file or any web site. Characteristics of this type might be useful to hold references to documentation / images associated with a given entity. For example, the image of a letter sent to you by one of your customers could be referenced as a file location characteristic on a customer contact entry. When such a characteristic is defined on an entity, a button can be used to open the URL in a separate browser window.

Searching By Characteristic Values

For certain entities in the system that have characteristics, you may search for a record linked to a given characteristic value. The search may be done in one of the following ways:

- Some base searches provide an option to search for an object by entering Characteristic Type and Characteristic Value.
- Your implementation may define a customized search for an entity by a characteristic value for a specific characteristic type using a query data explorer.
- Your implementation may require a business service to find a record via a given characteristic value. For example, maybe an upload of user information attempts to find the user via an Employee ID, defined as a characteristic.

Not all entities that support characteristics support searching by characteristics. Refer to the data dictionary to identify the characteristic collections that include the search characteristic column.

Caution: For ad-hoc characteristics, only the first 50 bytes are searchable. For foreign key characteristics, the search value is populated by concatenating the values of each foreign key column to a maximum of 50 bytes .

For the base searches that provide a generic option to search by characteristic type and value, you can restrict the characteristic types that can be used to search for an entity. For example, imagine you use a characteristic to define a "jurisdiction" associated with a To Do for reporting purposes. If your company operates within a very small number of jurisdictions, you wouldn't want to allow searching for a To Do by jurisdiction, as a large number of To Do entries would be returned.

A flag on the [characteristic type](#) allows an administrator to indicate if searching by this characteristic type is **allowed** or **not allowed**.

Characteristic Type - Main

To define a characteristic type, open **Admin Menu > Characteristic Type** .

Description of Page

Enter an easily recognizable **Characteristic Type** and **Description** for the characteristic type. **Owner** indicates if this characteristic type is owned by the base package or by your implementation (**Customer Modification**).

Caution: Important! If you introduce a new characteristic type, carefully consider its naming convention. Refer to [System Data Naming Convention](#) for more information.

Use **Type of Char Value** to classify this characteristic type using one of the following options (refer to [There Are Four Types Of Characteristics](#) for more information):

- **Predefined value.** Characteristics of this type have their valid values defined in the **Characteristic Value** scroll, below. For each valid value, enter an easily recognizable **Characteristic Value** and **Description**. For example, if you introduce a characteristic type to record the number of volts that are measured by a meter, you would add values for all voltage levels measured by the meters utilized by your organization.
- **Ad hoc value.** Characteristics of this type have an unlimited number of valid values. For example, if you use a characteristic to define the date a meter was ordered, you'd use this classification because you can't define every possible order date. If you use this option, you can optionally define the **Validation Rule** used to validate the user-entered characteristic value. For example, if we carry on with our example, you'd use a validation rule to make sure that what the user entered was actually a date. Click [here](#) to see the algorithm types available for this plug-in spot.
- **File location value.** Characteristics of this type contain a URL. The URL can point to a file or any web site. Characteristics of this type might be useful to hold documentation/images associated with a given entity. For example, the image of the formal contract signed by a customer could be referenced as a file location characteristic on a service agreement. When such a characteristic value is defined on an entity, the value is suffixed with a button that can be used to display the URL in a separate browser window.

File location characteristic values must be entered in a "non-relative" format. For example, if you want to define a characteristic value of *www.msn.com*, enter the characteristic value as `http://www.msn.com`. If you omit the `http://` prefix, the system will suffix the characteristic value to the current URL in your browser and attempt to navigate to this location when the launch button is pressed. This may or may not be the desired result.

Note:

Due to browser security restrictions, opening URLs using the file protocol ("file:///") from pages retrieved using http does not work for Internet Explorer version 7 or later, or in Firefox. If the file protocol is used, the browser either does not return properly or an error is thrown (e.g., "Access Denied", which usually results from cross site scripting features added for security reasons).

This issue has no known workaround. To comply with browser security standards, the recommendation is to move the target files to an FTP or HTTP server location to avoid protocols that are subject to browser security restrictions.

- **Foreign key reference.** Characteristics of this type have their valid values defined in another table. A good example of such a characteristic type would be one used on a premise to define the premise's building manager. Valid values for this type of characteristic would be defined on the person table (as you'd set up a person for the building manager and then reference this person on the premise characteristic). If you choose this option, you must use **FK Reference** to define the table that controls the valid values of this characteristic type. Refer to [Setting Up Foreign Key References](#) for more information.

Use the **Allow Search by Char Val** to indicate if searching for an entity by this characteristic type is **Allowed** or **Not Allowed**. Refer to [Searching by Characteristic Values](#) for more information.

Where Used

Use the [Data Dictionary](#) to view the tables that reference **CI_CHAR_TYPE**.

Characteristic Type - Characteristic Entities

To define the entities (objects) on which a given characteristic type can be defined, open **Admin Menu > Characteristic Type** and navigate to the **Characteristic Entities** tab.

Description of Page

Use the **Characteristic Entity** collection to define the entities on which the characteristic type can be used. **Owner** indicates if this is owned by the base package or by your implementation (**Customer Modification**).

Note: The values for this field are customizable using the Lookup table. This field name is **CHAR_ENTITY_FLG**.

Note: Heads up. For many entities in the system, the valid characteristics for a record are defined on a related "type" entity. For example, in Oracle Utilities Customer Care and Billing the meter type defines valid characteristics for meters of that type. When configuring your system, in addition to defining the appropriate entity for a characteristic type, you may also need to link the characteristic type to an appropriate entity "type".

Setting Up Foreign Key Reference Information

A Foreign Key Reference defines the necessary information needed to reference an entity in certain table.

You need to set up this control table if you need to validate a foreign key value against a corresponding table. For example, if a schema element is associated with an FK Reference the system validates the element's value against the corresponding table. Refer to [Configuration Tools](#) to learn more about schema-based objects. Another example is characteristics whose valid values are defined in another table (i.e., you use "foreign key reference" characteristic types). Refer to [There Are Four Types Of Characteristics](#) for a description of characteristics of this type.

A FK Reference is used not just for validation purposes. It also used to display the standard information description of the reference entity as well as provide navigation information to its maintenance transaction. Info descriptions appear throughout the UI, for example, whenever an account is displayed on a page, a description of the account appears. The

product provides base product FK references for many of its entities as they are used for validation and display of elements in both fixed page user interfaces as well as portal based user interfaces.

An implementation may also see the need to define a foreign key reference. The following points describe what you should know before you can setup a foreign key reference for a table.

- The physical name of the table. Typically this is the primary table of a maintenance object.
- The program used by default to construct the referenced entity's info description. Refer to [Information Description Is Dynamically Derived](#) for more information on how this is used.
- The transaction used to maintain the referenced entity. This is where the user navigates to when using the "go to" button or hyperlink associated with the entity. Refer to [Navigation Information Is Dynamically Derived](#) for more information on how this is used.
- The name of the search page used to look for a valid entity. Refer to [Search Options](#) for more information.

Information Description Is Dynamically Derived

Typically a FK Reference is defined for a maintenance object's primary table. In this case the system dynamically derives the standard information associated with a specific referenced entity as follows:

- Attempt to determine the business object associated with the referenced entity. Refer to the [Determine BO](#) maintenance object algorithm system event for more information. If a business object has been determined, the system lets the business object's [Information](#) plug-in, if any, format the description.
- If a business object has not been determined or the business object has no such plug-in, the system lets the maintenance object's [information](#) plug-in, if any, format the description.
- If the maintenance object has no such plug-in, the system uses the info program specified on the FK Reference to format the description.

Note: Technical note. For both Java and COBOL, the class / program that returns the information displayed adjacent to the referenced entity is generated specifically for use as an info routine. Please speak to your support group if you need to generate such a class / program.

Note: Generic routine. The system provides a generic information routine that returns the description of control table objects from its associated language table. By "control table" we mean a table with an associated language table that contains a **DESCR** field. Refer to [Defining Table Options](#) for more information on tables and fields. For COBOL, the name of the generic routine is **Get Description Info**. For Java, the java class is **com.splwg.base.domain.common.foreignKeyReference.DescriptionRetriever**.

Navigation Information Is Dynamically Derived

Typically a FK Reference is defined for a maintenance object's primary table. In this case the system dynamically derives the actual transaction to navigate to for a given referenced entity as follows:

- Attempt to determine the business object associated with the referenced entity. Refer to the [Determine BO](#) maintenance object algorithm system event for more information. If a business object has been determined, use the maintenance portal defined as its **Portal Navigation Option** business object option.
- If a business object has not been determined or the business object defines no such option, the system uses the transaction specified on the FK Reference.

Search Options

The product provides two main metaphors for implementing a user interface. For input fields that are foreign keys, search options are dependent on the metaphor used by the page in question.

- A *fixed maintenance page* user interface is a page supplied by the base product where only minor enhancements, if any, can be introduced by implementations. The foreign key reference may be used in one of two ways.
 - The based product may use an FK reference to define a base element on one of these pages. If a search is available for such elements, the FK reference's Search Navigation Key is used to implement the search.
 - Entities that support characteristics typically include a generic characteristic collection UI metaphor on these types of pages. In this metaphor, a foreign key characteristic displays a search icon if the FK Reference has configured a Search Navigation Key.
- A *portal based* user interface is a more flexible user interface where an implementation has more options for customizing the look and feel. The base product uses UI maps or automatic UI rendering to display input fields. Elements that are foreign keys may display a search icon if the FK reference defines a Search Zone.

Note: Defining search zones directly. It's possible for elements on a UI map to define a specific search zone directly in the HTML, rather than using the search zone defined on an FK reference. Refer to the UI map tips for more information on implementing searches using zones.

Foreign Key Reference - Main

To setup a foreign key reference, open **Admin > Foreign Key Reference** .

Caution: Important! If you introduce a new foreign key reference, carefully consider its naming convention. Refer to [System Data Naming Convention](#) for more information.

Description of Page

Enter an easily recognizable **FK** (foreign key) **Reference** code and **Description** for the table.

Enter the name of the **Table** whose primary key is referenced. After selecting a **Table**, the columns in the table's primary key are displayed adjacent to **Table PK Sequence**.

Use **Navigation Option** to define the page to which the user will be transferred when they press the go to button or hyperlink associated with the referenced entity. Refer to [Navigation Information Is Dynamically Derived](#) for more information on how this is used.

The **Info Program Type** indicates whether the default program that returns the standard information description is written in **COBOL** or **Java**.

- If the Program Type is **COBOL**, use **Info Program Name** to enter the name of the COBOL program.
- If the Program Type is **Java**, use **Info Program Name** to enter the Java class name.

Refer to [Information Description Is Dynamically Derived](#) for more information on the info program is used.

Note: COBOL Programs. COBOL programs are not supported by all products.

Note: View the source. If the program is shipped with the base package, you can use the adjacent button to display the source code of this program in the [source viewer](#) or [Java docs viewer](#).

Use **Context Menu Name** to specify the context menu that appears to the left of the value.

Note: Context Menu Name is not applicable to user interface elements displaying a generic collection using a foreign key characteristic type. It is only applicable for pages utilizing the foreign key compound element type for fixed page

user interface and for data displayed in a portal based user interface where the foreign key reference is defined as an attribute for an element. Report parameters that reference foreign key characteristics are an example of a user interface where a context menu is not displayed even if the foreign key reference defines one.

Use **Search Navigation Key** to define the search page that will be opened when a user searches for valid values on a user interface that is a fixed page. Refer to *Search Options* for more information.

Use **Search Type** to define the default set of search criteria used by the **Search Navigation Key**'s search page.

Use **Search Zone** to define the search zone that opens when a user searches for valid values when the foreign key reference is configured as an input field on a portal based page. Refer to *Search Options* for more information.

Use **Search Tooltip** to define a label that describes the **Search Navigation Key**'s search page.

Note: Search Type and Search Tooltip. These attributes are only applicable to user interface elements utilizing the foreign key compound element type on fixed page user interfaces. Report parameters that reference foreign key characteristics are an example of a user interface where this information is not used even if the foreign key reference defines them.

Where Used

Follow this link to open the data dictionary where you can view the tables that reference [CI_FK_REF](#).

Defining Feature Configurations

A limited number of the system's features are configured by populating options on a "feature configuration". For example, if your implementation uses Oracle Utilities Customer Care and Billing's batch scheduler, you must populate a variety of options on the batch scheduler's feature configuration.

The administration documentation for each feature defines the impact of each option. The topics below simply describe how to use this transaction in a generic way.

You can create features to control features that you develop for your implementation. To do this:

- Define the new feature. You do this by adding a new lookup value to the **EXT_SYS_TYP_FLG** lookup field.
- Define the feature's options. You do this by creating a new lookup field. The field must be in the format **xxxx_OPT_TYP_FLG** where **xxxx** is the identifier of the **EXT_SYS_TYP_FLG** added above.
- Flush all caches.

Feature Configuration - Main

To define your feature configuration, open **Admin Menu > Feature Configuration** .

Description of Page

Enter an easily recognizable **Feature Name** code.

Indicate the **Feature Type** for this configuration. For example, if you were setting up the options for the batch scheduler, you'd select **Batch Scheduler**.

Note: You can add new Feature Types. Refer to the description of the page above for how you can add Feature Types to control features developed for your implementation.

Note: Multiple Feature Configurations for a Feature Type. Some Feature Types allow multiple feature configurations. The administration documentation for each feature will tell you when this is possible.

The **Options** grid allows you to configure the feature. To do this, select the **Option Type** and define its **Value**. Set the **Sequence** to **1** unless the option may have more than value. **Detailed Description** may display additional information on the option type.

Note: Each option is documented elsewhere. The administration documentation for each feature describes its options and whether an option supports multiple values.

Note: You can add new options to base-package features. Your implementation may want to add additional options to one of the base-package's feature types. For example, your implementation may have plug-in driven logic that would benefit from a new option. To do this, display the lookup field that holds the desired feature's options. The lookup field's name is **xxxx_OPT_TYP_FLG** where **xxxx** is the identifier of the feature on the **EXT_SYS_TYP_FLG** lookup value. For example, to add new batch scheduler options, display the lookup field **BS_OPT_TYP_FLG**.

Feature Configuration - Messages

If the feature exists to interface with an external system, you can use this page to define the mapping between error and warning codes in the external system and our system.

Open this page using **Admin Menu > Feature Configuration** and navigate to the **Messages** tab.

Description of Page

For each message that may be received from an external system, define the **Feature Message Category** and **Feature Message Code** to identify the message.

A corresponding message must be defined in the *system message* tables. For each message identify the **Message Category** and **Message Number**. For each new message, the Message Category defaults to **90000** (because an implementation's messages should be added into this category or greater so as to avoid collisions during upgrades).

Defining Master Configurations

A master configuration enables an implementation to capture various types of information in the system.

For example, a master configuration exists in the base product that captures the mapping between Hijri and Gregorian dates. Given this, users are able to switch between Gregorian and Hijri date formats by changing the display profile on their user record.

Master Configurations can be bundled for export to other environments.

Setting Up Master Configurations

To set up a master configuration, open **Admin Menu > Master Configuration**.

The topics in this section describe the base-package zones that appear on the Master Configuration portal.

Master Configuration

The Master Configuration List zone lists every category of master configuration.

The following functions are available:

- Click a broadcast button to open other zones that contain more information about the adjacent master configuration.
- Click the **Add/Edit** button to start a business process that updates the master configuration.

Master Configuration Details

The Master Configuration Details zone contains display-only information about a master configuration.

This zone appears when a master configuration has been broadcast from the Master Configuration zone.

Please see the zone's help text for information about this zone's fields.

Miscellaneous Topics

The following sections describe miscellaneous system wide topics.

Attachments

Some implementations may require that attachments be available from the application. These attachments can be stored in the Attachment table (F1_ATTACHMENT) and then linked to other objects by foreign keys. If the attachment is a binary file, the file is converted to text before being stored in the table. When the attachment is retrieved it is converted back to its original format.

A list of attachment IDs can also be used as an input parameter on the business service F1-EmailService. Implementers can create an installation algorithm for the **Email Service – Validate Attachments** system event to validate the size and total count for the emails.

Attachments can be either an owned attachment or a common attachment. An owned attachment is linked to a single object and is usually maintained on the owning objects portal. Common attachments can be linked to multiple objects and are maintained on the Attachment Information portal.

Attachment Information — Main

Open this page using **Admin > Attachments** .

Description of Page

In the Attachments Search zone you can search for attachments by the Attachment Name, File Type BO, or ID. Click **Refresh** to view the search results. In the search results, select the Attachment Info link to go to the Attachment Information zone for that record. In the Attachment Information zone the following actions are available:

- Click **Go To Search** in the zone's title bar to go back to the Attachments Search zone.
- Click **Edit** to update the name of the attachment.
- Click **Delete** to delete the attachment.
- Click **View** to open the attachment.
- Click **Upload** to upload a new attachment.

Creating an Attachment Business Object

The application contains business objects to manage many of the standard content types, such as text documents, Jpeg images, and PDFs. These business objects reference the Attachment Maintenance Object (F1-ATCHMT). If you need to

define an attachment for a new content type, copy the configuration of an existing attachment business object for the new content type and then configure the following option types for the BO:

- **Binary** indicates whether the attachment data must be converted from binary format. Binary attachments are stored in the database as text, and are then converted back to the original format when retrieved.
- **Content Type** represents the browser's mime type of the attachment.
- **Supported File Extension** specifies the valid file extensions for the content type.

Module Configuration

The system provides the ability to simplify the user interface based on functionality areas practiced by your organization.

Menu items and other user interface elements are associated with function modules. By default, all function modules are accessible. If a function module is not applicable to your business you may turn it off. Refer to [Turn Off A Function Module](#) for more information on how to turn off a module.

If a function module is made non-accessible, i.e. turned off, its related elements are suppressed from the user interface. In addition the system may validate that related functionality is not accessed. This also means that turning off the wrong module may cause any of the following to occur:

- Menu items may not appear. Refer to [Menu Item Suppression](#) to better understand how menu item suppression works.
- Entire menus may not appear. Refer to [Menu Suppression](#) to better understand how menu suppression works.
- Tabs on pages may not appear.
- Fields may not appear.
- The system may return an error message when you attempt to use a function (indicating the function is turned off).

To correct the above situation, simply remove the module from the turned off list thus making it accessible again.

Your module configuration setup is displayed on the [installations](#) record.

Menu Item Suppression

The following points describe how your module configuration can suppress [menu items](#).

- Menu items that are owned by the base product (as opposed to those your implementation adds) are associated with one or more function modules. If your module configuration has turned off all of the menu item's modules, the menu item is suppressed. If at least one of the modules is accessible, i.e. turned on, the menu item is not suppressed.
- If a menu line doesn't contain any accessible items, the menu line is suppressed.
- If all lines on a menu are suppressed, the menu is suppressed when the [menu button](#) is clicked.

Menu Suppression

In addition to the above Menu Item Suppression logic, the following points describe how your module configuration can suppress an entire menu.

- Menus that are owned by the base product (as opposed to those your implementation adds) are associated with one or more function modules.
- If your module configuration has turned off all of the menu's modules, the entire menu is suppressed. If at least one of the modules is accessible, i.e. turned on, the menu is not suppressed.

Turn Off A Function Module

The base package is provided with a **Module Configuration** *Feature Configuration* that allows your organization to turn off base package function modules.

To turn off any of the base package function modules add a **Turned Off** option to this feature configuration referencing that module. Refer to the **MODULE_FLG** lookup field for the complete list of the application's function modules.

Any module not referenced on this feature configuration is considered turned on, i.e. accessible. To turn on a module, simply remove its corresponding **Turned Off** option from this feature configuration.

You may view your module configuration setup on the *installation options* page.

Note: Only one. The system expects only one **Module Configuration** feature configuration to be defined.

Global Context Overview

The framework web application provides each product the ability to nominate certain fields to act as a "global context" within the web application. These fields are known as global context fields. For example, in Oracle Utilities Customer Care and Billing, the global context fields are typically Account ID, Person ID and Premise ID. The values of these fields may be populated as a result of searching or displaying objects that use these fields in their keys. If you navigate to the Bill page and display a bill, the global context is refreshed with the Account ID associated with that bill. The global context for Person ID and Premise ID are refreshed with data associated with that account.

Changing the values of the global context typically cause data displayed in zones on the dashboard to be refreshed to show information relevant to the current values of these global context fields.

When the value of one of the global context fields changes, an algorithm plugged into the *installation record* is responsible for populating the remaining global context values accordingly. Refer to your specific product for more information about the base algorithm that is provided for that product.

Note: Customer modification. If the global context values provided by your product do not satisfy your implementation's business requirements, contact customer support for information on how to customize the global context information.

System Data Naming Convention

There are several maintenance objects in the system that include owner flag in one or more of its tables. We refer to the data in these tables as "system data". Some examples of system data tables include Algorithm Type, Batch Control, Business Object and Script. Implementations may introduce records to the same tables. The owner flag for records created by an implementation is set to **CM** (for customer modification), however the owner flag is not part of the primary key for any of the system data tables. As a result, the base product provides the following guidelines for defining the primary key in system data tables to avoid any naming conflict.

Base Product System Data

For any table that includes the owner flag, the base product will follow a naming convention for any new data that is owned by the base product. The primary key for records introduced by the product is prefixed with **x1-** where **x1** is the value of the owner flag. For example, if a new background process is introduced to the framework product, the batch code name is prefixed with **F1-**.

Note: There are some cases where the hyphen is not included. For example, portal codes omit the hyphen.

For most system data, the remainder of the primary key is all in capital case. An exception is schema oriented records. For business objects, business services, scripts, data areas and UI maps, the product follows the general rule of using CapitalCase after the product owner prefix. For example, **F1-AddToDoEntry** is the name of a base product business service.

Note: Data Explorer Business Services. For business services used to invoke a data explorer Zone, it is recommended to name the Business Service the same name as the related Zone rather than defining a different CapitalCase name for the business service.

Please note that this standard is followed for all new records introduced by the base product. However, there are base product entries in many of these system data tables that were introduced before the naming convention was adopted. That data does not follow the naming convention described above.

Note: Schema naming conventions. A context sensitive "Schema Tips" zone is associated with any page where a schema may be defined. The zone provides recommended naming conventions for elements within a schema along with a complete list of the XML nodes and attributes available to you when you construct a schema.

Implementation System Data

When new system data is introduced for your implementation you must consider the naming convention for the primary key. The product recommends prefixing records with **CM**, which is the value of the owner flag in your environment. This is consistent with the base product naming convention. This convention allows your implementation to use the CM packaging tool in the Software Development Kit as delivered. The extract file provided with the tool selects system data records with an owner flag of **CM AND** with a **CM** prefix.

Note: If you choose not to follow the CM naming convention for your records and you want to use the CM packaging tool, your implementation must customize the extract file to define the appropriate selection criteria for the records to be included in the package. Refer to the Software Development Kit documentation for more information.

Also note that owner flag may be introduced to an existing table in a new release. When this happens, the CM packaging tool is also updated to include these new system data tables. Your implementation will have existing records in those tables that probably do not follow any naming convention. After an upgrade to such a release, if you want to include this data in the CM packaging tool, you must customize the extract file for the tables in question.

Caching Overview

A great deal of information in the system changes infrequently. In order to avoid accessing the database every time this type of information is required by an end-user, the system maintains a cache of static information on the web server. In addition to the web server's cache, information is also cached on each user's browser.

Server Cache

The cache is populated the first time any user accesses a page that contains cached information. For example, consider a control table whose contents appear in a dropdown on various pages. When a user opens one of these pages, the system verifies that the list of records exists in the cache. If so, it uses the values in the cache. If not, it accesses the database to retrieve the records and saves them in the cache. In other words, the records for this control table are put into the cache the first time they are used by any user. The next user who opens one of these pages will have the records for this control table retrieved from the cache (thus obviating the database access).

The following points describe the type of data that is cached on the web server:

- **Field labels.** This portion of the cache contains the labels that prefix fields on the various pages in the system.
- **System information.** This portion of the cache contains installation and basic information about the various application services (e.g., the URL's that are associated with the various pages).
- **Menu items.** This portion of the cache contains the menu items.
- **Dropdown contents.** This portion of the cache contains the contents of the various dropdowns that appear throughout the system.
- **XSL documents.** This portion of the cache contains each page's static HTML.
- **Portal information.** This portion of the cache contains information about which zones are shown on the various pages.

The contents of the cache are cleared whenever the web server is "bounced". This means that fresh values are retrieved from the database after the application server software is restarted.

If you change the database after the cache is built and the information you changed is kept in the cache, users may continue to see the old values. If you don't want to bounce your web server, you can issue one of the following commands in your browser's URL to immediately clear the contents of the cache (a separate command exists for each type of data that is held in the cache):

- **flushAll.jsp?language=<language code>.** This command flushes every cache described below.
- **flushMessageCatalog.jsp.** This command flushes the field labels. Use this whenever you add or change any labels (this is typically only done by implementers who have rights to introduce new pages).
- **flushSystemLoginInfo.jsp.** This command flushes the system information cache. Use this whenever you change navigation options, cached information from the installation record, or if you change an application service's URL.
- **flushMenu.jsp.** This command flushes the menu cache. Use this command if you change menu data.
- **flushDropdownCache.jsp?language=<language code>.** This command flushes ALL objects in the dropdown contents associated with a given language (note, the **language code** is defined on the [Language](#) control table). Use this whenever you change, add or delete values to/from control tables that appear in dropdowns. Unlike the above caches, the objects in the dropdown cache are flushed automatically every 30 minutes from the time they are first built.
- **flushDropDnField.jsp?language=<language code>&key=<field>** If you want to flush the values in a specific dropdown field in the cache, specify the *<field>* using this command.
- **flushUI_XSLs.jsp.** This command flushes the XSL document cache. Use this command if you change user interface meta-data. Also use this command whenever you change or introduce new zones.
- **flushXMLMetaInfo.jsp.** This command flushes the XML repository of the XML Application Interface. Use this command when your site's XAI configuration data needs to be updated, which should be a very rare occurrence.
- **flushPortalMetaInfo.jsp.** This command flushes the portal information cache. Use this command whenever you change any portal zone meta-data.

For example, assume the following:

- the web server and port on which you work is called **CD-Production:7500**
- you add a new record to a control table and you want it to be available on the appropriate transactions immediately (i.e., you cannot wait for 30 minutes)

You would issue the following command in your browser's address bar: **http://CD-Production:7500/flushDropdownCache.jsp?language=ENG**. Notice that the command replaces the typical `cis.jsp` that appears after the port number (this is because these commands are simply different JSP pages that are being executed on the web server).

Client Cache

In addition to the web server's cache, information is also cached on each user's browser. After clearing the cache that's maintained on the web server, you must also clear the cache that's maintained on your client's browser. To do this, follow the following steps:

- Select **Tools** on your browser's menu bar
- Select **Internet Options...** on the menu that appears.
- Click the **Delete Files** button on the pop-up that appears.
- Turn on **Delete all offline content** on the subsequent pop-up that appears and then click **OK**.
- And then enter the standard URL to re-invoke the system.

Note: Automatic refresh of the browser's cache. Each user's cache is automatically refreshed based on the **maxAge** parameter defined in the web.xml document on your webserver. We recommend that you set this parameter to **1** second on development / test environments and **28800** seconds (8 hours) on production environments. Please speak to system support if you need to change this value.

Debug Mode

Your implementation team can execute the system using a special mode when they are configuring the application. To enable this mode, enter **?debug=true** at the end of the URL that you use to access the application. For example, if the standard URL was **http://CD-Production:7500/cis.jsp**, you'd enter **http://CD-Production:7500/cis.jsp?debug=true** to enable configuration mode.

When in this mode certain debugging oriented tools become available right below the main tool bar.

- **Start Debug** starts a logging session. During this session the processing steps that you perform are logged. For example, the log will show the data areas that are passed in at each step and the data areas returned after the step is processed.
- **Stop Debug** stops the logging session.
- **Show Trace** opens a window that contains the logging session. All of the steps are initially collapsed.
- **Clear Trace** clears your log file.
- **Show User Log** allows you to view your own log entries. The number of "tail" entries to view may be specified in the adjacent **Log Entries** field before clicking the button. Limiting the number of entries to view allows the user to quickly and easily see only the latest log entries without having to manually scroll to the end of the log.
- Checking the **Global Debug** indication starts various tracing options.

Other parts of the system may show additional configuration oriented icons when in this mode. For example, explorer zones may provide additional tools to assist in debugging zone configuration. These icons are described in the context of where they appear.

Also, in debug mode drop down lists in data explorer and UI map zones will contain the code for each item in addition to the item's display string.

Note: Show User Log button is secured. An application service **F1USERLOG** has been provided for this functionality to allow implementations to restrict user access to this button. Such restriction may be called for in production environments.

System Override Date

The system provides a way to override the system date used for online operations. This feature is available if the server administrator has enabled it in the environment properties. For instructions on configuring environment properties see the *Server Administration Guide*. The system date override feature is not recommended for production environments.

Under the **General System Configuration** *Feature Configuration*, the **System Override Date Option Type** holds the date the application will use as the global system date instead of retrieving the same from the database. This feature can be especially useful in running tests that require the system date to be progressed over a period of time.

The system override date feature is also available at the user level. This is useful when a user wants override the system date to run tests without affecting the system date for other users in the environment. In order to override the system date for the user, open the **Admin > User** , page. On the **Characteristics** tab, add the **System Override Date** characteristic type with a characteristic value set to the desired date in the YYYY-MM-DD format.

If system override dates are defined at both the feature configuration level and the user level, the date set at the user level will take precedence.

Advanced Search Options

The product supports fuzzy searching in explorer zone types using the Oracle Text CONTAINS operator.

Refer to the DBA guide for details on setting up the database to support fuzzy searching. Note that there are some implementations where fuzzy searching will not be possible. For example, it's only available for implementations using the Oracle database. Additionally, not all languages are supported. Refer to the Oracle Database documentation for more information about fuzzy searching.

For information about the particular syntax to use in the explorer zones, refer to the Zone Tips context zone available in the Dashboard on the Zone portal.

Chapter 3

Defining Security & User Options

The contents of this section describe how to maintain a user's access rights.

The Big Picture of Application Security

The contents of this section provide background information about application security.

Application Security

The system restricts access to its transactions as follows:

- An *application service* may be associated with every securable function in the system.
 - All maintenance objects define an application service that includes the basic actions available, typically **Add**, **Change**, **Delete** and **Inquire**. The base product supplies an application service for every maintenance object.
 - For maintenance objects whose user interface page is not portal-based, the application service also controls whether the menu entry appears. If a user doesn't have access to the maintenance object's application service, the menu item that corresponds with the application service will not be visible.
 - For portal based user interfaces, each main portal defines an explicit application service with the access mode **Inquire**, allowing the user interface to be secured independently of the underlying object security. If a user doesn't have access to the portal's application service, the menu item that corresponds with the application service will not be visible. The base product supplies an application service for every portal that is accessible from the menu.
 - Menu items may define an application service. Use this technique for the following scenarios:
 - Suppress a menu item if the underlying application security for the transaction does not provide enough fine grained control. For example, imagine your implementation creates a special BPA script to add a To Do Entry and would like users to use the special BPA rather than the base supplied Add dialogue for To Do Entry. The underlying security settings for To Do Entry should grant Add access to these users given that the special BPA will still add a record. To suppress the base Add dialogue, link a special application service and access mode for the base supplied menu item for To Do Entry Add. Then define a menu entry for the new special BPA for adding.

- Suppress the "+" icon if a user does not have add security for the object. By default the product does not suppress the "+" icon if a user does not have add access to the object. Rather, the user is prevented from adding the record at the back-end. If your implementation would like to suppress the icon, link the object's application service and the Add access mode to the Add menu item.
- Zones define an application service
 - For zones linked to a portal, if a user doesn't have access to the zone's application service, the zone will not be visible on the portal. In most cases the zone defines the same application service as its portal. In special cases, such as the zones on the Dashboard, the product supplies separate application services for each zone allowing implementations to determine at a more granular level which users should have access to which zones.
 - For query zones that are configured on a multi-query zone, if a user doesn't have access to the zone's application service, the zone will not be visible in the dropdown on the multi-query zone. In most cases all zones in a multi-query zone define the same application service as the multi-query zone. The product may supply a special application service for one or more zones in a multi-query zone if the functionality is special to certain markets or jurisdictions and not applicable to all implementations.
 - For zones that are used by business services to perform SQL queries, the product supplies a default application service. Security for these zones is not checked by the product as they are used for internal purposes.
- Business objects define an application service. If the business object defines a lifecycle, the application service must include access modes that correspond to each state. In addition, the standard maintenance object access modes of **Add**, **Change**, **Delete** and **Inquire** are included. The base product business objects are supplied with appropriate application services.
- Other configuration tool objects are securable but the base product typically does not supply special application services for each object. An implementation may supply custom application services and link them to the appropriate record:
 - BPA scripts that are accessible via a menu define an application service with the access mode **Execute**. The base BPA scripts are typically configured with a default application service, which may be overridden by an implementation.
 - Business Services define an application service with the access mode **Execute**. This is needed for business services that may be executed from an external system, for example via XAI. Base business services are configured with a default application service, which may be overridden by an implementation.
- Users are granted access to application services via *user groups*. For example, you may create a user group called Senior Management and give it access to senior manager-oriented pages and portals.
 - When you grant a user group access to an application service with multiple access modes, you must also define the access modes that are allowed. Often the access modes correspond to an action on a user interface. For example, you may indicate a given user group has **inquire**-only access to an application service, whereas another user group has **add**, **change**, **cancel** and **complete** access to the same service. Refer to *action level security* for more information.
 - If the application service has *field level security* enabled, you must also define the user group's security level for each secured field on the transaction.
 - And finally, you link individual *users* to the user groups to which they belong. When you link a user to a user group, this user inherits all of the user group's access rights.

Caution: Menus may be suppressed! If all menu items on a menu are suppressed, the menu is suppressed.

Importing LDAP Users and User Groups

If your organization uses Lightweight Directory Access Protocol (LDAP), you can import your existing LDAP users and groups into the system. Once imported, all user and group functions are available. You can import all users, a group of users, or a single user. You can resynchronize your LDAP users and groups at any time.

For information on how to set up your system to import users and groups from an LDAP store as well as how to do the import, refer to [Importing Users and Groups](#).

Action Level Security

When you grant a user group access to an [application service](#), you must indicate the actions to which they have access.

- For application services that only query the database, there is a single action to which you must provide access - this is called **Inquire**.
- For application services that can modify the database, you must define the actions that the user may perform. At a minimum, most maintenance transactions support **Add**, **Change**, and **Inquire** actions. Additional actions are available depending on the application service's functions.

Caution: Important! If an application service supports actions that modify the database other than **Add**, **Change**, and **Delete**; you must provide the user with **Change** access in addition to the other access rights. Consider a transaction that supports special actions in addition to **Add**, **Change**, and **Inquire** (e.g., **Freeze**, **Complete**, **Cancel**). If you want to give a user access to any of these special actions, you must also give the user access to the **Inquire** and **Change** actions.

Field Level Security

Sometimes transaction and action security is not sufficient. There are situations where you may need to restrict access based on the values of data. For example, in Oracle Utilities Customer Care and Billing you might want to prevent certain users from completing a bill for more than \$10,000. This is referred to as "field level security".

Field level security can be complex and idiosyncratic. Implementing field level security always requires some programming by your implementation group. This programming involves the introduction of the specific field-level logic into the respective application service(s).

Note: **Field level security logic is added to user exits.** Refer to the Public API chapter of the Software Development Kit Developer Guide for more information on how to introduce field-level security logic into an application service's user exits.

Even though the validation of a user's field-level security rights requires programming, the definition of a user's access rights is performed using the same transactions used to define transaction / action level security. This is achieved as follows:

- Create a [security type](#) for each type of field-level security.
- Define the various access levels for each security type. For example, assume you have some users who can complete bills for less than \$300, and other users who can complete bills for less than \$1,000, and still other users who can complete bills for any value. In this scenario, you'd need 3 access levels on this security type:
 - Level 1 (lowest): May authorize bills \leq \$300
 - Level 2 (medium): May authorize bills \leq \$1,000
 - Level 3 (highest): May authorize all bills
- Link this security type to each [application service](#) where this type of field level security is implemented. This linkage is performed on the [security type](#) transaction.
- Defining each [user group's](#) access level for each security type (this is done for each application service on which the security type is applicable).

Note:

Highest value grants highest security. The system expects the highest authorization level value to represent highest security level. Moreover, authorization level is an alphanumeric field so care should be taken to ensure that it's set up correctly.

Encryption and Masking

"Encryption" refers to encrypting data stored in a database using an encryption key.

Only users whose database access user ID has the appropriate encryption key can retrieve decrypted information. Please refer to your database's encryption guidelines for how to encrypt data.

"Masking" refers to overwriting all or part of a decrypted field value with a masking character before it is presented to a user (or an external system) without the appropriate security access. For example, an implementation can mask the first 12 digits of a credit card number with an asterisk for users who do not have security rights to see credit card numbers.

Multiple masking rules. The system allows different masking rules to be applied to different fields. For example, a credit card number can be masked differently than a social security number. In addition, some user groups may be allowed to see certain fields unmasked.

Masking happens after decryption. It is obvious, but worth emphasizing, that only decrypted data can be masked. This means that if a user does not have authority to retrieve decrypted data then masking is not relevant because the data to be masked would be encrypted.

The topics in this section describe how to mask field values.

Identify the Fields to Be Masked

Your implementation should list every field on every page and XAI service request that requires masking

Classify each field into one of the following categories:

- An element that is retrieved by invoking a business object, a business service, or a service script
- A field that is retrieved by invoking a page service
- A field that is retrieved by invoking a search service
- An ad hoc characteristic type's value

Primary keys cannot be masked. A field defined as a unique identifier of a row cannot be configured for masking. Masking a field that is part of the primary key causes a problem when attempting to update the record. This restriction also applies to elements that are part of a "list" in a CLOB on a maintenance object. One or more elements in the list must be defined as a primary identifier of the list. Be sure that primary key elements in the list are not ones that require masking.

Masking applies to strings. Only fields with a data type of String can be masked.

List members that contain different "types". Consider a page with a list that contains a person's phone numbers. You can set up the system so that a person's home phone has different masking rules than their work number. If your implementation has this type of requirement, the list of masked fields should contain an entry for each masking rule.

Create a Security Type For Each Logical Field

Examine the list of masked fields and look for "logical fields".

For example, assume your list contains the following masked fields:

- The Person - Main page retrieves information using the person page service. This page contains a grid that contains the various forms of ID associated with the person. Entries in the grid with an ID Type of "Social Security Number" are subject to masking.
- The Control Central - Main page retrieves data by invoking a search service. This service shows a person's primary form of ID in the search results. If a person's primary ID is their social security number then it is subject to masking.
- The Control Central - Account Information page contains a map zone that retrieves data by invoking a service script. One of the elements in this script's schema holds the person's social security number and it is subject to masking.

In the above example, there is a single "logical field" associated with the three secured elements: the social security number. Examine your list and define the distinct logical fields. For each one, create a security type with two authorization levels:

- **1** - Can only see the element masked
- **2** - Can only see the element unmasked

You should link all of the security types to an application service of your choosing. We recommend linking every masking-oriented security type to a single application service (e.g., **CM_MASK**) as it makes granting access easier.

Create An Algorithm For Each Security Type

A masking algorithm must be created for each security type.

These algorithms determine if a user has the rights to view a given field unmasked, and, if not, how the field should be masked.

The base package provides the algorithm type *FI-MASK* whose parameters are designed to handle most masking needs. This algorithm type's parameters are described below to provide the complete picture of how to control how a field is masked and who can see it unmasked:

- **Masking Character:** Enter the character used to overwrite a field's value for users who can only see masked values.
- **Number of Unmasked Characters:** If some of the field value should remain unmasked at the end of the string, enter the number of unmasked characters.
- **Unmasked Characters:** If some characters in a field value should never be masked, enter them. For example, if a phone number can contain dashes and parenthesis and you don't want these characters masked, you would enter - () . .
- **Application Service:** Enter the application service that you created above.
- **Security Type:** Enter the security type that you created above.
- **Authorization Level:** Enter the authorization level that a user must have to see this field unmasked. If you followed the recommendations above, this will be **2**.

Create A Feature Configuration For Each Secured Element

Create a feature configuration with a Feature Type of **Data Masking**.

Add an option for every field that you defined in *Identify The Fields To Be Masked*.

Each field's option value will have an **Option Type** of **Field Masking** and a **Value** that references the respective algorithm defined above. In addition, the Value will contain mnemonics that differ depending on how the field is retrieved.

Note: Only fields defined as strings are supported.

Schema Based Object Field Masking

For data that is accessed via a schema-based object call and displayed in a UI map, the field to be masked must reference a meta-data field name in its schema definition: **field="fld_name", alg="algorithm name"**

If the element references an mdField in the schema, that is the field used to identify the masking rule. If there is no mdField reference but only a mapField reference, that is the field used to identify the masking rule. For example, if you want to mask a credit card number, let's assume that field is defined in the schema is the following:

```
<creditCard mdField="CCNBR" mapField="EXT_ACCT_ID" />
```

In this case, the option value should be **field="CCNBR", alg="algorithm name"**. An option value of **field="EXT_ACCT_ID", alg="algorithm name"** would not result in masking.

A "where" clause may also be specified. This is useful for data that resides in a list where only data of a certain type needs to be masked: **field="fld_name", alg="algorithm name", where="fld_name='value'"**

For example, person can have a collection of IDs and only IDs of type 'SSN' (social security number) should be masked. If the person data including its collection of person IDs is displayed on a UI map via a business object call, let's assume the collection is defined in the following way:

```
<personIDs type="list" mapChild=CI_PER_ID">  
<isPrimaryId mapField="PRIM_SW" />  
<idType mapField="ID_TYPE_CD" />  
<personIdNumber mapField="PER_ID_NBR" />  
</personIDs>
```

The option value may look like this: **field="PER_ID_NBR", alg="algorithm name", where="ID_TYPE_CD='SSN'"**

Please note the following important points for schema based masking:

- **Limitation of 'where' field** Although the main use of a 'where' clause for schema oriented elements is to mask certain elements in a list based on a 'type', it is also possible to mask a single field in the schema based on the value of another field. For example, imagine that a customer submits a registration form that defines an ID type and ID value. Although this data is not in a list, the implementation may still want to only mask the ID value if the ID type is "SSN". The framework is only able to mask an element in the schema based on a 'where' clause if the element in the 'where' clause is a "sibling" in the schema.
 - If the element to be masked is in a list, the element in the 'where' clause must be in the same list.
 - If an element to be masked maps to a real column in a table, the element in the 'where' clause must also map to a real column in the table.
 - If an element to be masked maps to the CLOB of a table as a single element, the element in the 'where' clause must map to the same CLOB as a single element.
- **Multiple feature option entries for the same field.** It's possible that different schemas in the system have a similar type of data that may be masked based on different conditions. For example, imagine that an implementation has different schemas that captured or referenced person identifiers in different ways:

- One schema captures a single person ID without any corresponding "type" record and it should always be masked using Algorithm CM_SSN_MASK:

```
<personSSN mapXML=BO_DATA_AREA mdField=PER_ID_NBR/>
```

- One schema captures a person ID and a corresponding ID Type and it should be masked with Algorithm CM_SSN_MASK if the type is "SSN" and masked with algorithm CM_FEIN_MASK if the type is "FEIN".

```
<personIdType mapXML=BO_DATA_AREA mdField=ID_TYPE_CD/>  
<personId mapXML=BO_DATA_AREA mdField=PER_ID_NBR/>
```

- One schema captures a person ID and a corresponding ID Type and it has the same masking rules as the previous schema, but a different field name is used for the ID Type code. (This scenario could happen if for example a different label is desired for ID Type on the user interface for this schema.)

```
<personIdType mapXML=BO_DATA_AREA mdField=CM_ID_TYPE/>
```

```
<personId mapXML=BO_DATA_AREA mdField=PER_ID_NBR/>
```

For this scenario, the feature options may look like this:

1. **field="PER_ID_NBR", alg="CM_SSN_MASK"**
2. **field="PER_ID_NBR", alg="CM_SSN_MASK", where="ID_TYPE_CD='SSN'"**
3. **field="PER_ID_NBR", alg="CM_FEIN_MASK", where="ID_TYPE_CD='FEIN'"**
4. **field="PER_ID_NBR", alg="CM_SSN_MASK", where="CM_ID_TYPE='SSN'"**
5. **field="PER_ID_NBR", alg="CM_FEIN_MASK", where="CM_ID_TYPE='FEIN'"**

For each schema, the system will first find whether the element applies to any masking option. It will find 5 masking options for the field PER_ID_NBR. Then it will determine if any sibling elements match the 'where' clause.

- If more than one sibling element matches a 'where' clause, a runtime error is issued. For example if a schema has an element that references "mdField=ID_TYPE_CD" and an element that references "mdField=CM_ID_TYPE", this is an error. Additionally, if multiple elements reference mdField=ID_TYPE_CD, this is an error.
- If one and only one sibling element matches a 'where' clause, the value of the element is compared to the values defined in the 'where' clause. If it finds a match on the value, the appropriate masking algorithm is applied. If no match is found (for example, the Person ID Type is "LICENSE") the element is displayed as is.
- If no sibling element matches a 'where' clause and a feature option exists with no 'where' clause (option 1 above), then the masking algorithm of the option with no 'where' clause is applied.
- **Changing the value in the 'where' clause.** If your implementation has some users that are allowed to change records where some data is masked based on a condition, it is recommended to design the user interface to reset the masked value when the value in the 'where' clause changes. For example, if a user is prevented from viewing a person's social security number, but the user is allowed to make updates to the person's record, changing the value of the Person ID Type should reset the Person ID Number. This would ensure that the user does not 'unmask' the social security number by simply changing the ID Type.

Records Maintained Using Page Maintenance

For data that is accessed via a page maintenance service call, indicate the table name and the field name where the data resides: **table="table_name", field="fld_name", alg="algorithm name"**

For example if the Person record and its collection of identifiers are displayed and maintained using page maintenance, the option value should be **table="CI_PER_ID", field="PER_ID_NBR", alg="algorithm name"**

A "where" clause may also be specified: **table="table_name", field="fld_name", where="fld_name='value'", alg="algorithm name"**

This is useful for data that resides in a child table where only data of a certain type needs to be masked. For the person ID example, **table="CI_PER_ID", field="PER_ID_NBR", alg="algorithm name", where="ID_TYPE_CD='SSN'"**

Characteristic Data

For data that is stored as a characteristic, simply indicate the characteristic type: **CHAR_TYPE_CD='char type', alg="algorithm name"**

This needs to be defined only once regardless of which characteristic entity the char type may reside on. Note that only ad-hoc characteristics are supported.

Masking Fields in Explorer Zones or Info Strings

In explorer zones data is often retrieved using SQL directly from the database. No masking is applied automatically in this case. If there is data in the explorer zone results that should be masked, the masking must be applied by calling a business service.

Similarly, an MO Info algorithm may not use BO interaction to get data. It may access data using SQL for efficiency purposes. No masking is applied when retrieving data via SQL. To apply masking to a string prior to including it in an info string, the masking must be applied by calling a business service.

The system supplies two business services to be called to determine if masking rules apply for a specific field.

- **F1-TableFieldMask** - Mask a Table field. This business service receives a table name, field name and one or more field values. If masking applies it returns the masked value.
- **F1-SchemaFieldMask** - Mask a Schema field. This business service receives a schema name and type, XPath and field value. If masking applies it returns the masked value.

Search Service Results

For data that is displayed via a search service call, indicate the search name and the appropriate field to mask along with the masking algorithm. For example: `search="SearchServiceName", field="PER_ID_NBR", where="ID_TYPE_CD='SSN'", alg="algorithm name"`

To find the name of the search service, launch the search in question, right click in the filter area and choose View Source. Search for ServiceName. The service name is listed there. To find the field name to mask, go back to the search window and right click on the results area and choose View Source. Look for the Widget Info section and find the field name in the SEARCH RESULTS (do not include the \$). Note, the "where" statement can only apply to fields that are also part of the search results.

Grant Access Rights To The User Groups

For each security type, identify which users can see its data unmasked and which users can only see its data masked.

If the masked and unmasked users fit into existing user groups, no additional user groups are necessary. Otherwise, create new user groups for the masked and unmasked users.

After the user groups for each security type are defined, link each user group to the application service defined above. When a user group is linked to the application service, you will define the authorization level for each security type linked to the application service. If a user group's users should see the security type's field values unmasked, set the authorization level to 2; otherwise set it to 1. Refer to *User Group - Application Services* for the transaction used to link a user group to an application service.

Note: Flush the cache. Remember that any time you change access rights you should flush the security cache (by entering flushAll.jsp on the URL of the application) if you want the change to take affect immediately.

Additional Masking Information

The following points provide additional information to assist in your masking configuration:

- If the demonstration database includes a **Data Masking** feature configuration, review the settings because it will probably contain masking rules that will match your own.
- On data input pages, a user might be able to enter or change masked data, such as a bank account number, but not be able to subsequently see what they added or changed.
- External systems can request information by performing a service call via XAI. Please keep in mind that some XAI requests require data to be masked and some do not. For example, a request from an external system to synchronize person information needs the person's social security number unmasked; whereas a request from a web self service application to retrieve the same person information for display purposes needs the person's social security number masked. To implement this type of requirement, different users must be associated with each of the requests and these users must belong to separate user groups with different access rights.

- If a maintenance object (MO) contains a CLOB field that holds an XML document and a service call invokes the MO's service program directly, the system will mask individual XML elements in the CLOB if a **Determine BO** algorithm has been plugged into the *maintenance object* and the element(s) in the respective BO schema have been secured as described above.

The Base Package Controls One User, One User Group, And Many Application Services

When the system is initially installed, the following information is delivered:

- Application services for all secured transactions, business objects and zones in the base package.
- A user identified by the user id **SYSUSER**.
- A user group identified by the user group code **ALL_SERVICES**. This user group is associated with all supported application services accessible delivered with the base product. This user group is given access to all access modes for all application services (i.e., all actions on all transactions).
- The user **SYSUSER** is linked to the **ALL_SERVICES** user group. This means that this user has access to all transactions and all actions.

When you receive an upgrade:

- New application services are delivered for the new transactions, business objects, zones introduced in the release.
- Existing application services are updated with changes in their access modes (e.g., if a new action is added to a transaction, its application service is updated accordingly).
- The **ALL_SERVICES** user group is updated so it can access the new / changed application services.

Caution: Important! You cannot change or remove the information delivered for **ALL_SERVICES**. This information is owned by the base package. It is provided so that an "initial user" has access to the entire system and can setup user groups and users as per your organization's business requirements. It is not recommended to provide your own users with access to the **ALL_SERVICES** user group. Rather, create appropriate user groups that are appropriate for organization's business requirements and define user access to these user groups. If you introduce new transactions, configure them for the appropriate custom user groups.

How To Copy User Groups From The Demonstration Database

Caution: If you are not familiar with the concepts described in the *ConfigLab* chapter, this section will be difficult to understand. Specifically, you need to understand how a **Compare** database process is used to copy objects between two databases. Please take the time to familiarize yourself with this concept before attempting to copy a user group from the demonstration database.

Your product's demonstration database may contain sample user groups. These user groups reference logical groups of application services. For example, the "case management user group" references the "case management" application services.

You may find that these sample user groups closely match the user groups needed by your implementation. If this proves true, you should copy these user groups from the demonstration database. This will save you time as you won't have to set up the each such group's application services (but you'll still need to link your users to the appropriate user groups). The topics in this section describe how to copy user groups from the demonstration database.

If You Work In A Non-English Language

The demonstration database is installed in English only. If you work in a non-English language, you must execute the **NEWLANG** background process on the demonstration database before using it as a **Compare Source** supporting environment. If you work in a supported language, you should apply the language package to the demonstration database as well.

If you don't execute **NEWLANG** on the demonstration database, any objects copied from the demonstration database will not have language rows for the language in which you work and therefore you won't be able to see the information in the target environment.

One Time Only - Set Up A DB Process To Copy User Groups

You need a "copy user group" *database process* (DB process) setup in the target database (e.g., your implementation's database). This DB process has a single instruction that references the user group *maintenance object* (MO). This instruction should have a table rule with an override condition that selects the user groups in question. For example, the override condition `#SC_USER_GROUP.USR_GRP_ID LIKE 'CI_%'` is used on the DB process that copies user groups prefixed with **CI_**. The demonstration database contains such a DB process; it's called **CI_COPUG**. In order to copy user groups from the demonstration database, you must first copy this DB process from the demonstration database.

Caution: The remainder of this section is confusing as it describes a DB process that copies another DB process. Fortunately, you will only have to do the following once. This is because after you have a "copy user groups" DB process in your target database, you can use it repeatedly to copy user groups from the demonstration database.

You can copy the **CI_COPUG** DB process from the demonstration database by submitting the **CL-COPDB** *background process* in your target database. When you submit this process, you must supply it with an *environment reference* that points to the demonstration database. If you don't have an environment reference configured in your target database that references the demonstration database, you must have your technical staff execute a registration script that sets up this environment reference. Refer to *Registering ConfigLab Environments* for more information.

CL-COPDB is initially delivered ready to copy *every* DB process that is prefixed with **CI_** from the source database (there are numerous sample DB processes in the demonstration database and this process copies them all). If you only want to copy the **CI_COPUG** DB process, add a *table rule* to the primary instruction of the **CL-COPDB** *database process* to only copy the **CI_COPUG** DB process. The remainder of this section assumes you have added this table rule.

When the **CL-COPDB** process runs, it highlights differences between the "copy user groups" DB process in your source database and the target database. The first time you run this process, it creates a root object in the target database to indicate the **CI_COPUG** DB process will be added to your target database. You can use the *Difference Query* to review these root objects and **approve** or **reject** them.

After you've approved the root object(s), submit the **CL-APPCH** batch process to change your target database. You must supply the **CL-APPCH** process with two parameters:

- The DB Process used to create the root objects (**CL-COPDB**)
- The environment reference that identifies the source database (e.g., the demonstration database)

Run The Copy User Groups DB Process

After you have populated the "copy user groups" DB process in your target database, you can override its *table rule* to edit the list of user groups that will be copied. You need only do this if you don't need all of the user groups that are defined in these DB processes (but it never hurts to have too many user groups as they won't be used unless you link users to them).

At this point, you're ready to submit the background process identified on your "copy user group" DB processes. This background process highlights the differences between the user groups in the demonstration database and the target database (the target database is the environment in which you submit the background process).

Note: The background process you submit is typically named the same as the DB process that contains the rules. If you used the *CL-COPDB* background process to transfer the "copy user group" DB processes from the demo database, it will have also setup these batch controls and linked to each the appropriate "copy user groups" DB process. These batch controls have the same name as their related DB process (this is just a naming convention, it's not a rule). This means, for example, that you'd submit a batch control called **CI_COPUG** in order to execute the **CI_COPUG** DB process.

When you submit one of the DB processes defined above, you must supply it with an *environment reference* that points to the source database (i.e., the demonstration database).

When the process runs, it simply highlights differences between the user groups in the source database and the target database. It creates a root object in the target database for every user group that is not the same in the two environments (actually, it only concerns itself with user group that match the criteria on the DB process's table rule described above). You can use the *Difference Query* to review these root objects and **approve** or **reject** them.

Note: Auto approval. When you submit the process, you can indicate that all root objects should be marked as **approved** (thus saving yourself the step of manually approving them).

After you've approved the root object(s) associated with the user groups that you want copied, submit the *CL-APPCH* batch process to cause your target database to be changed. You must supply the **CL-APPCH** process with two parameters:

- The DB process of the "copy user groups" DB process (e.g., **CI_COPUG**)
- The environment reference that identifies the source database (i.e., the demonstration database)

The Big Picture of Row Security

Some products allow you to limit a user's access to specific rows. For example, in Oracle Utilities Customer Care and Billing, row level security prevents users without appropriate rights from accessing specific accounts.

By granting a user access rights to an account, you are actually granting the user access rights to the account's bills, payment, adjustments, orders, etc.

The topics in this section describe basic row level security objects.

Fastpath: For a more detailed description of how row level security has been implemented in Oracle Utilities Customer Care and Billing, refer to **Administration Guide - Implementing Account Security** in the Customer Care and Billing documentation.

Access Groups, Data Access Roles and Users

We'll use an example from Oracle Utilities Customer Care and Billing to describe how access groups and roles are used to restrict access to accounts. The following diagram illustrates the objects involved with account security:

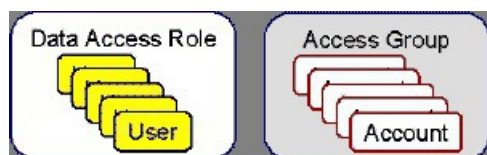

An **Access Group** defines a group of **Accounts** that have the same type of security restrictions. A **Data Access Role** defines a group of **Users** that have the same access rights (in respect of access to accounts). When you grant a data access role rights to an access group, you are giving all users in the data access role rights to all accounts in the access group.

The following points summarize the data relationships involved with account security:

- An account references a single **access group**. An **access group** may be linked to an unlimited number of **accounts**.
- A **data access role** has one or more **users** associated with it. A **user** may belong to many **data access roles**.
- A **data access role** may be linked to one or more **access group**. An **access group** may be linked to one or more **data access roles**.

If you use row level security, setting up your access roles and groups can be easy or challenging - it all depends on your organization's requirements. Refer to the product's **Administration Guide - Implementing Account Security** for several case studies. These case studies provide examples of how different requirements can be implemented using these concepts.

Defining Application Services

An application service exists for every transaction in the system. Please refer to [Application Security](#) for a description of how application services are used when you grant user groups access rights transactions.

Note: Maintenance of this information is rare. The system is supplied with an application service for every transaction in the system. You will only add application services if you introduce new transactions.

Caution: Important! If you introduce a new application service, carefully consider its naming convention. Refer to [System Data Naming Convention](#) for more information.

Application Service - Main

Select **Admin Menu > Application Service** to define an application service.

Description of Page

Enter a unique **Application Service** code and **Description** for the application service.

Indicate the application service's various **Access Modes** (i.e., actions). Refer to [Action Level Security](#) for more information about the significance of these fields.

Where Used

Follow this link to open the data dictionary where you can view the tables that reference [SC_APP_SERVICE](#).

Application Service - Application Security

Use the Application Security portal to set up security for an application service.

Open this page using **Admin Menu > Application Service**, and then navigate to the **Application Security** tab.

This section describes the available zones on this page.

Application Service Details zone. The Application Service Details zone contains display-only information about the selected application service, including the Access Modes for the application service and its security type.

User Groups with Access zone. The User Groups with Access zone lists the user groups that have access to the application service. The following actions are available:

- Click the **Description** link to navigate to the User Group - Users page for the adjacent user group.

- Click **Deny Access** to remove the user group's access rights from the selected Application Service.
- Use the search filters to display the user groups that contain a specific user.

User Groups without Access zone. The User Group without Access zone lists the user groups that do not have access to the application service. The following actions are available:

- Click the **Description** link to navigate to the User Group - Users page for the user group.
- Click **Grant Access** to navigate to the User Group - Application Services page for the user group. The page is automatically positioned at the selected application service.
- Use the search filters to display the user groups that contain a specific user.

Defining Security Types

Security types are used to define the types of *field level security*.

Note: Programming is required. You cannot have field level security without introducing logic to user exits. Refer to *Field Level Security* for more information on how security types are used to define field level security.

Security Type - Main

Select **Admin Menu > Security Type** to define your security types.

Description of Page

Enter a unique **Security Type** and **Description**.

Use the **Authorization Level** grid to define the different authorization levels recognized for this security type. Enter an **Authorization Level Number** and its **Description**.

Note: Programming is required. Note that the values that you enter are not interpreted by the system itself, but by the user exit code used to implement the special security. Check with the developer of the user exit logic for the correct values. Refer to *Field Level Security* for more information on how security types are used to define field level security.

Use the **Application Services** grid to define the application service(s) to which this security type is applicable. If this application service is already associated with user groups, you must update each user group to define their respective security level. This is performed using *User Group - Application Service*.

Where Used

Follow this link to open the data dictionary where you can view the tables that reference *CI_SC_TYPE*.

Defining User Groups

A user group is a group of users who have the same degree of security access. Think of a user group as a "role"; associated with a role are:

- The users who play this role
- The application services to which the role's users have access (along with the actions they can execute for each service and their field level security authorization levels).

User Group - Main

Select **Admin Menu > User Group** to view the application services to which a user has access.

Caution: Application services may not be changed or removed from the **ALL_SERVICES** user group. Refer to [The Base Package Controls One User, One User Group, And Many Application Services](#) for an explanation.

Description of Page

Enter a unique **User Group** code and **Description** for the user group.

Owner indicates if this user group is owned by the base package or by your implementation (**Customer Modification**). The system sets the owner to **Customer Modification** when you add a user group. This information is display-only.

The **Application Services** grid displays the various application services to which users in this group have access. Please note the following in respect of this grid:

- Use the **Application Service** search to restrict the application services displayed in the grid. For example, if you only want to see application services that start with the word "field", you can enter this word and press enter.
- To add additional application services to this user group, navigate to the [User Group - Application Services](#) page and click the + icon.
- To remove or change this user group's access to an application service, click the go to button adjacent to the respective application service. This will cause you to be transferred to the [User Group - Application Services](#) tab where you should click the - icon to remove the application service from the user group.
- Note, **Owner** indicates if this user group / application service relationship is owned by the base package or by your implementation (**Customer Modification**). The system sets the owner to **Customer Modification** when you add an application service to the user group. This information is display-only.

Where Used

Follow this link to open the data dictionary where you can view the tables that reference [SC_USER_GROUP](#).

User Group - Application Services

Select **Admin Menu > User Group** and navigate to the **Application Services** tab to maintain a user group's access rights to an application service.

Note: Important! When you grant a user group access rights to an application service, you are actually granting all users in the user group access rights to the application service.

Description of Page

The **Application Service** scroll contains the application services to which the **User Group** has access.

Note: Note. You can also use Main page to select the application service for which you wish to change the access privileges. To do this, simply click the go to button adjacent to the respective application service.

To add additional application services to this user group, click the + icon and specify the following:

- Enter the **Application Service ID** to which the group has access.
- Define the **Expiration Date** when the group's access to the application service expires.

Define the **Access Modes** that users in this group have to the **Application Service**. When a new application service is added, the system will default all potential **Access Modes** associate with the **Application Service**. You need only remove those modes that are not relevant for the **User Group**. Refer to [Action Level Security](#) for more information about access modes.

Caution: Important! If an application service supports actions that modify the database other than **Add**, **Change**, and **Delete**; you must provide the user with **Change** access in addition to the other access rights. Consider a transaction that supports actions in addition to **Add**, **Change**, and **Inquire** (e.g., **Freeze**, **Complete**, **Cancel**). If you want to give a user access to any of these additional actions, you must also give the user access to the **Inquire** and **Change** actions.

If you require additional security options, often referred to as "field level" security, then you use **Security Type Code** and assign an **Authorization Level** to each. When a new application service is added, the system will display a message indicating how many security types are associated with this application service. Use the search to define each Security Type Code and indicate the appropriate Authorization Level for this user group. Refer to [Field Level Security](#) for more information about security types.

User Group - Users

Select **Admin Menu > User Group** and navigate to the **Users** tab to maintain the users in a user group.

Description of Page

The scroll area contains the users who are part of this user group.

Note: Keep in mind that when you add a **User** to a **User Group**, you are granting this user access to all of the application services defined on the **Application Services** tab.

The following fields are included for each user:

- Enter the **User ID** of the user.
- Use **Expiration Date** to define when the user's membership in the group expires.
- **Owner** will be **Customer Modification**.

Note: **Note.** You can also add a user to a user group using [User - Main](#).

Defining Access Groups

Fastpath: Refer to [The Big Picture of Row Security](#) for a description of how access groups are used to restrict access to specific objects.

Access groups control which groups of users (referred to as Data Access Roles) have rights to accounts (or other objects) associated with the access group. Select **Admin Menu > Access Group** to define your access groups.

Description of Page

Enter a unique **Access Group** code and **Description** for the data access group.

Use the **Data Access Role** collection to define the data access roles whose users have access to the access group's accounts (or other objects). Keep in mind that when you add a **Data Access Role** to an **Access Group**, you are granting all users who belong to this role access to all of the accounts (or other objects) linked to the access groups. Refer to [Access Groups, Data Access Roles and Users](#) for more information.

Note: You can also use [Data Access Role - Access Group](#) to maintain a data access role's access groups.

Where Used

Follow this link to open the data dictionary where you can view the tables that reference [CI_ACC_GRP](#).

Defining Data Access Roles

Fastpath: Refer to [The Big Picture of Row Security](#) for a description of how access groups are used to restrict access to specific objects.

The data access role transaction is used to define two things:

- The users who belong to the data access role.
- The access groups whose accounts (or other objects) may be accessed by these users.

Data Access Role - Main

Select **Admin Menu > Data Access Role** to define the users who belong to a data access role.

Description of Page

Enter a unique **Data Access Role** code and **Description** for the data access role.

The scroll area contains the **Users** who belong to this role. A user's data access roles play a part in determining the accounts (or other objects) whose data they can access. Refer to [Access Groups, Data Access Roles and Users](#) for more information.

To add additional users to this data access role, press the + button and specify the following:

- Enter the **User ID**. Keep in mind that when you add a **User** to a **Data Access Role**, you are granting this user access to all of the accounts (or other objects) linked to the data access role's access groups.
- Use **Expiration Date** to define when the user's membership in this data access role expires.

Note: Also maintained on the user page. You can also use [User - Access Security](#) to maintain a user's membership in data access roles.

Where Used

Follow this link to open the data dictionary where you can view the tables that reference [CI_DAR](#).

Data Access Role - Access Group

Select **Admin Menu > Data Access Role** and navigate to the **Access Groups** tab to define the access groups whose accounts (or other objects) may be accessed by the users in this data access role.

Description of Page

Use the **Access Group** collection to define the access groups whose objects can be accessed by this role's users. Keep in mind that when you add an **Access Group** to a **Data Access Role**, you are granting all users who belong to this role access to all of the accounts (or other objects) linked to the access groups. Refer to [Access Groups, Data Access Roles and Users](#) for more information.

Note: You can also use [Access Group - Main](#) to maintain an access group's data access roles.

Defining Users

The user maintenance transaction is used to define a user's user groups, data access roles, portal preferences, default values, and To Do roles. To access the user maintenance transaction, select **Admin Menu > User** .

The user maintenance transaction is the same transaction invoked when the user clicks on the [preferences button](#); the only difference is that when the user transaction is invoked from the Administration menu, all input fields are updatable. When the transaction is invoked from the My Preferences Button, many fields are protected to prevent end-users from changing important profile information. Please see the [User Preferences](#) page for a description of this transaction.

Where Used

Follow this link to open the data dictionary where you can view the tables that reference [SC_USER](#).

Chapter 4

User Interface Tools

This section describes tools that impact many aspects of the user interface.

Defining Menu Options

The contents of this section describe how you can add and change menus and *Context Menus*.

Caution: Updating menus requires technical knowledge of the system. This is an implementation and delivery issue and should not be attempted if you do not have previous experience with menus.

Note: Security and menus. Refer to *Application Security* for a discussion of how application security can prevent menu items (or an entire menu) from appearing.

Note: Module configuration and menus. Your *module configuration* can prevent menu items (or an entire menu) from appearing.

Menu - Main

This transaction is used to define / change any menu in the system. Navigate to this page using **Admin Menu > Menu** .

Description of Page

Enter a meaningful, unique **Menu Name**.

Owner indicates if this menu line is owned by the base package or by your implementation (**Customer Modification**). The system sets the owner to **Customer Modification** when you add a menu line. This information is display-only.

The **Flush Menu** button is used to flush the cached menu items so you can see any modified or newly created menus. Refer to *Caching Overview* for more information.

Menu Type defines how the menu is used. You have the following options:

- Enter **Admin** for the administration menu. The Admin menu is a special type of Main menu as admin menu items can be grouped alphabetically or by functional group. Refer to the description of Admin Menu Order on [Installation Options - Base](#) for more information about admin menu options.
- Enter **Context** to define a context menu
- Enter **Main** to define a menu that appears on the menu bar.
- Enter **Submenu** to define a menu that appears when a menu item is selected. For example, the Main menu contains numerous submenus. Each submenu contains the navigation options used to open a page.

Long Label is only enabled for **Admin** and **Main** menus. It contains the text displayed to identify the menu when the [menu button](#) is clicked.

Menu Bar Description is only enabled for **Admin** and **Main** menus. It contains the text displayed to identify the menu in the menu bar.

Sequence is only enabled for **Admin** and **Main** menus. It controls the order of the menu in the list of menus that appears when the [menu button](#) is clicked.

The grid contains a summary of the menu's lines. Refer to the description of [Menu Items](#) for how to add items to a menu line.

- **Menu Line ID** is the unique identifier of the line on the menu. This information is display-only.
- **Sequence** is the relative position of the line on the menu. Note, if two lines have the same **Sequence**, the system organizes the lines alphabetically (based on the **Long Label**, which is defined on the next tab).
- **Navigation Option / Submenu** contains information about the line's items. If the line's item invokes a submenu, the submenu's unique identifier is displayed. If the line's item(s) invoke a transaction, the description of the first item's [navigation option](#) is displayed.
- **Long Label** is the verbiage that appears on the menu line.
- **Item Count** is the number of menu items on the line.
- **Owner** indicates if this menu line is owned by the base package or by your implementation (**Customer Modification**). The system sets the owner to **Customer Modification** when you add a menu line. This information is display-only.

Menu - Menu Items

After a menu has lines (these are maintained on the main tab), you use this page to maintain a menu line's items.

Each menu line can contain one or two menu items. The line's items control what happens when a user selects an option on the menu.

There are two types of menu items: one type causes a transaction to be invoked when it's selected; the other type causes a submenu to appear. For example,

- The following is an example of a menu line with two items: one opens the account transaction in update mode, the other (the + icon) opens the account transaction in add mode:

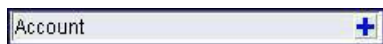

- The following is an example of a menu line with a single item that opens a submenu:

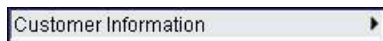

If you want to display an existing menu line's items:

- Navigate to **Admin Menu > Menu** and display the menu in question.
- Click the go to button on the line whose menu items should be displayed on this tab.

If you want to add a new line to an existing menu line:

- Navigate to **Admin Menu > Menu** and display the menu in question.
- Click the + button to add a new line to the grid.
- Use **Sequence** to specify the relative position of the line on the menu. Note, if two lines have the same **Sequence**, the system organizes the lines alphabetically (based on the **Long Label**, which is defined on the next tab).
- Save the new line.
- Click the go to button on the new line.

Description of Page

Menu Name is the name of the menu on which the line appears. **Menu Line ID** is the unique identifier of the line on the menu. **Owner** indicates if this menu is owned by the base package or by your implementation (**Customer Modification**). This information is display-only.

The **Menu Line Items** scroll contains the line's menu items. The following points describe how to maintain a line's items:

- **Menu Item ID** is the unique identifier of the item.
- **Owner** indicates if this item is owned by the base package or by your implementation (**Customer Modification**).
- If the menu item should invoke a submenu (as opposed to a transaction):
 - Use **Sub-menu Name** to identify the menu that should appear when the line is selected
 - Use **Long Label** to define the verbiage that should appear on the menu line
- If the item should invoke a transaction (as opposed to a submenu):
 - Use **Sequence** to define the order the item should appear in the menu line (we recommend this be set to **1** or **2** as a menu line can have a maximum of 2 menu items).
 - Use **Navigation Option** to define the transaction to open (and how it should be opened). Refer to [Defining Navigation Options](#) for more information.
 - If you want an icon to appear on the menu line (as opposed to text)
- Use **Image GIF Location and Name** to define the location in which the icon resides on the web server. For example, you could enter **/images/contextAdd.gif** if you want the classic "+" icon to appear. Your icons can be located on the product's web server or on an external web server. To add a new icon to the product web server, place it under the **/cm/images** directory under the **DefaultWebApp**. Then, in the **URL** field, specify the relative address of the icon. For example, if the icon's file name is **myIcon.gif**, the **URL** would be **/cm/images/myIcon.gif**. If the icon resides on an external web server, the **URL** must be fully qualified (for example, **http://myWebServer/images/myIcon.gif**).
- Use **Image Height** and **Image Width** to define the size of the icon.
- Use **Balloon Description** if you want a tool tip to appear when the cursor hovers over the icon.
- Use **Long Label** to describe what this menu item does (note, this won't appear on the menu because you are specifying an icon; it's just good practice).
- If you want text to appear on the menu line (as opposed to an icon), use **Long Label** to define the text.
- The **Override Label** is provided in case you want to override the base-package's label.
- Use **Application Service** and **Access Mode** to easily suppress a menu item for one or more users. Refer to [Application Security](#) for more information.

Note: **Owner** indicates if this menu line is owned by the base package or by your implementation (**Customer Modification**). The system sets the owner to **Customer Modification** when you add a menu line. This information is display-only.

The Big Picture of System Messages

All error, warning and informational messages that are displayed in the system are maintained on the message table. Every message is identified by a combination of two fields:

- **Message category number.** Think of a message category as a library of messages related to a given functional area. For example, there is a message category for billing messages and another one for payment messages.
- **Message number.** A unique number identifies each message within a category.

Every message has two components: a brief text message and a long description. On the **Main** tab, you can only maintain the brief message. If you need to update a message's long description, you must display the message on the **Details** tab.

Note: You cannot change the base package's text. If the message is "owned" by the base package, you cannot change the base package's message or long description (if you could, your changes would be overwritten during an upgrade). If you want your users to see a different message or long description other than that supplied by the base package, display the message on the **Details** tab and enter your desired verbiage in the "customer specific" fields (and flush the cache).

Defining System Messages

The contents of this section describe how to maintain messages that appear throughout the system.

Message - Main

Select **Admin Menu > Message** to maintain a message category and its messages.

Description of Page

To add a new message category, enter a **Message Category** number and **Description**.

Note: Note. **Owner** indicates if this message category is owned by the base package or by your implementation (**Customer Modification**). The system sets the owner to **Customer Modification** when you add a category. This information is display-only.

Caution: Message category 90000 or greater must be used to define new messages introduced for a specific implementation of the system. Changes to other Message Text will be overwritten when you next upgrade. If you want to make a change to a Message, drill down on the message and specify Customer Specific Message Text. Note that even for message categories 90000 and higher, message numbers lower than 1000 are reserved for common base product messages.

To update a message, you must first display its **Message Category**. You can optionally start the message grid at a **Starting Message Number**.

To override the message text or long description of messages owned by the base package, click on the message's go to button. When clicked, the system takes you to the **Details** tab on which you can enter your implementation's override text.

The following points describe how to maintain messages owned by your implementation:

- Click the - button to delete a message.
- Click the + button to add a new message. After clicking this button, enter the following fields:
- Use **Message Number** to define the unique identifier of the message within the category.

- Use **Message Text** to define a basic message. You can use the %n notation within the message text to cause field values to be substituted into a message. For example, the message text **The %1 non-cash deposit for %2 expires on %3** will have the values of 3 fields merged into it before it is displayed to the user (%1 is the type of non-cash deposit, %2 is the name of the customer, and %3 is the expiration date of the non-cash deposit).

Please note - the system merges whatever values are supplied to it. Therefore, if a programmer supplies a premise address as the second merge parameter in the above message, this address is merged into the message (rather than the customer's name).

- **Owner** indicates if this message category is owned by the base package or by your implementation (**Customer Modification**). The system sets the owner to **Customer Modification** when you add a category. This information is display-only.
- Click the go to button to enter a longer explanation of the message. Clicking this button transfers you to the **Details** tab.
- To change a message, simply overwrite its **Message Text** and save the category. Note, you must transfer to the Details tab if you want to update a messages Description.

Where Used

Follow this link to open the data dictionary where you can view the tables that reference [CI_MSG](#).

Message - Details

Select **Admin Menu > Message** and navigate to the **Details** tab to define detailed information about a message.

Note: You don't have to use the scroll. Rather than scrolling through the messages, you can display a message by clicking the respective go to button in the grid on the main tab.

Description of Page

The **Message Collection** scroll contains an entry for every message in the grid on the Main tab. It's helpful to categorize messages into two categories when describing the fields on this page:

- Base-package messages
- Implementation-specific messages (i.e., a message added to **Message Category** 90000 or greater)

For base-package messages, you can use this page as follows:

- If you want to override a message, specify **Customer Specific Message Text**.
- You are limited to the same substitution values used in the original **Message Text**. For example, if the original **Message Text** is **The %1 non-cash deposit for %2 expires on %3** and %1 is the type of non-cash deposit, %2 is the name of the customer, and %3 is the expiration date of the non-cash deposit; your **Customer Specific Message Text** is limited to the same three substitution variables. However, you don't have to use any substitution variable in your message and you can use the substitution variables in whatever order you please (e.g., %3 can be referenced before %1, and %2 can be left out altogether).
- If you want to override the long description of an error message, specify **Customer Specific Description**. Note that the system does not present long descriptions when warnings are shown to users. Therefore, it doesn't make sense to enter this information for a warning message.

For implementation-specific messages, you can use this page as follows:

- Use **Message Text** to define the message.

You can use the % n notation within the message text to cause field values to be substituted into a message. For example, the message text **The %1 non-cash deposit for %2 expires on %3** will have the values of three fields merged into it before it is displayed to the user (%1 is the type of non-cash deposit, %2 is the name of the customer, and %3 is the expiration date of the non-cash deposit).

Caution: If both **Message Text** and **Customer Specific Message Text** are specified, the system will only display the **Customer Specific Message Text** in the dialog presented to the user.

- Use **Description** to define additional information about an error message. Note that the system does not present long descriptions when warnings are shown to users. Therefore, it doesn't make sense to enter this information for a warning message.

Caution: If both **Description** and **Customer Specific Description** are specified, the system will only display the **Customer Specific Description** in the dialog presented to the user.

The Big Picture of Portals and Zones

A portal is a page that is comprised of one or more information zones. Good examples of portals are those used by most of us when we setup Yahoo, MSNBC, etc. for our own personal use. For example, in Yahoo, we can indicate we want our portal to show zones containing our stock portfolio, the news headlines, and the local weather.

In your application, there are several pages that are made up of information zones. And, just like in Yahoo, users can indicate which of these zones they want to see on each of the portal pages (and the order in which they appear).

The contents of this section describe how portals have been implemented in the system. Please see the specific product documentation for information describing specific portals.

Portals Are Made Up of Zones

A "portal" is a page that contains one or more "zones" where each zone contains data of some sort. You define the number and type of zones that can appear on a portal to match your implementation's requirements.

Note that not all zones must belong to a portal. Some zones exist that are used solely for internal processing by the application. Also, zones used for pop-up help may not be linked to a portal.

Zones May Appear Collapsed When a Page Opens

When a portal opens, some or all of its zones may be collapsed (e.g., minimized) or open (e.g., the zone's content is visible).

To view the information in a collapsed zone, click the zone button .

Fastpath: Refer to [Allowing Users To Change Their Portal Preferences](#) for important information describing how users configure their zones.

Caution: Recommendation. We strongly recommend that user preferences be set up to collapse zones that aren't needed every time a portal is displayed. Why? Because the system does not perform processing until the zone is expanded. In other words, indicating a zone is collapsed improves response times.

Changing Portal Preferences

Many portals supplied by the base product define several zone-oriented functions on the portal page and may not be changed by an individual user. However, some portals are configured to allow users to define their preferences. A user's [Portal Preferences](#) control several zone-oriented functions:

- Which zones appear on their portal pages

- The order in which the zones appear
- Whether the zones should be "collapsed" (i.e., minimized) when the portal page opens

You can optionally configure the system to define portal preferences on one or more "template" users. If you link a template user to a "real" user, the real user's preferences are inherited from the "template" user and the "real" user cannot change their preferences. Some implementations opt to work this way to enforce a standard look and feel throughout a user community.

If you don't do this, each user can change how their portals are organized and this may be exactly how you want to work.

Zones Appear By Default

When you add a zone to a portal, and the portal has been configured to show on portal preferences, the system assumes all users with [access rights](#) to the zone's application service should see it. This means that users don't have to change their [portal preferences](#) in order to see newly added zones. If a user wants to suppress or reposition a zone, they must change their portal preferences (if their portal preferences are not defined on a "template" user).

Note: Adding a zone to a portal. You can add a zone to a portal using either [Zone - Portal](#) or [Portal - Main](#).

Note: Positioned at the bottom of the portal. If a user does not indicate where they want to see a zone (using their portal preferences), the system positions it at the bottom of the portal. This means that if you add a zone to a portal, it will appear at the bottom of the portal by default.

Granting Access to Zones

An [application service](#) is associated with each zone. A user must be granted access rights to the respective application service in order to see a zone on a portal page.

Fastpath: Refer to [The Big Picture Of Application Security](#) for information about granting users access rights to an application service.

Please note the following in respect of how application security impacts a user's zones:

- A user's [Portal Preferences](#) page contains a row for a zone regardless of whether the user has access rights to the zone. Because of this, the system displays an indication of the user's access rights to each zone.
- If a user's access rights to a zone are revoked, the zone will be suppressed when the user navigates to the respective portal page.
- Revoking a user's access rights does not change the user's [portal preferences](#) (i.e., a user can indicate they want to see a zone even if they don't have access to the zone - such a zone just won't appear when the respective portal page appears).

Note: If you don't need to use zone security. If your implementation gives all users access to all zones, simply set up a single "dummy" application service and define it on all of your zones. This way, you only have to grant security rights to this single application service to your user groups.

Zone Type vs. Zone

There are two meta-data objects that control how a zone is built: Zone Type and Zone (where a zone type can have one or more zones):

- The **Zone Type** defines:
- The **java class** used to render its zones.

- The **parameters** whose values are configured on each of its zones. For example, a zone type that renders a graph has parameters that control the type of data that appears in the graph, if the graph is animated, if the graph is rendered using bars or lines, etc. Whenever you set up a zone of this type, you define the value of each of these parameters. This means that you can have many graph zones that all reference the same zone type (where each zone defines the type of data, if it is animated, etc.).
- Optionally, **parameter values** used by the **java class** that are the same for all zones of a given type (this feature simply saves the repetitive definition of these values on the zone types zones). A graph zone and a pie chart zone are rendered using the same java class, however each zone uses a different XSL template (because pie charts look very different from graphs). Rather than defining the XSL template on every graph zone, the graph zone type holds a parameter value that defines the appropriate graph XSL template. The pie chart zone type holds a similar parameter but its value references the XSL template used to build pie charts.
- Every **Zone** references a **Zone Type**. The **Zone** simply defines the parameter values for its zone type. For example, you might have two graph zones - one graph shows expenses while the other shows revenue. Each of these zones will reference the same zone type (the one that renders graphs) and unique parameter values to control the type of data that it retrieves (one will indicate that revenue is retrieved, while the other indicates expenses are retrieved).

Fixed Zones versus Configurable Zones

Some zone types are shipped with pre-configured zones that are linked to base-package portals. For example, the base package is shipped with a **Favorite Links** zone that is linked to the **Dashboard** portal. For these zones, your implementation simply needs to define your users' [portal preferences](#) and [security rights](#). Please note, you cannot change how these zones behave because their zone parameter values are owned by the base-package.

Other zone types have been designed to allow your implementation to control how their zones look and behave. For example, the Timeline zone type allows your implementation to set up one or more timeline zones where each zone is configured to show specific events. Follow these steps to introduce a configurable zone:

- Add the zone and configure its parameters as desired.
- Link the zone to the appropriate portal(s).
- Define your users' [portal preferences](#) and [security rights](#) in respect of the zone.

Please note that virtually every zone type supports implementation-specific zones.

Note: "How to" hints. Each product-specific Administration Guide has a chapter that provides "tips and techniques" on how the configurable zones can be used. Open the help and navigate to the index entry labeled **Configuring Zones**.

There Are Three Types of Portals

There are three broad classes of portals:

- **Standalone Portal.** Standalone portals are separate pages. These pages are opened using any of the standard methods (e.g., by selecting a menu item, by selecting a favorite link, etc.). Your implementation will add this type of portal when necessitated by your users. For example, if you are implementing Oracle Utilities Business Intelligence, you will set up portals as per the analytic requirements of your users (e.g., you might have one portal that contains zones showing revenue analytics, and another portal contains expense analytics). It should be noted that no stand-alone portals are delivered with the base-package (your implementation must add these types of portals).
- **Dashboard Portal.** The dashboard portal is a portal that appears in the [Dashboard Area](#) on the users desktop. Its zones contain tools and information that exist on the user's desktop regardless of the transaction. A good example of a zone for this type of portal is one containing hyperlinks to the user's favorite transactions.

There is only one dashboard portal. This portal and several zones are delivered as part of the base-package. Your implementation can add additional zones to this portal. Please contact customer support if you need to add zones to the dashboard portal.

- **Tab Page Portals.** You can add portals to base-package transactions. You would do this if you need to customize how a transaction looks depending on the type of user. Please contact customer support if you need to add portals to existing transactions.

Common Characteristics of Stand-Alone Portals

The topics that follow describe common characteristics of *stand-alone portals*. If you require information about adding or changing Dashboard or Tab Page portals, please contact customer support.

Putting Portals on Menus

A stand-alone portal should appear as a menu item on one of your menus. The following points provide how to do this:

- Every stand-alone portal has an associated navigation option. You can see a portal's navigation option on the *Portal - Main* page.
- To add a portal to a menu, you must add a *menu item* to the desired menu. This menu item must reference the portal's navigation option. There are two ways to add a menu item:
- If the portal's navigation option doesn't currently exist on a menu, you can press the **Add To Menu** button on the *Portal - Main* page. When you press this button, you will be prompted for the menu. The system will then create a menu item on this menu that references the portal's navigation option.
- You can always use the *Menu* page to add, change and delete menu items.

Note: No limit. A portal's navigation option can appear on any number of menu items (i.e., you can create several menu items that reference the same portal).

Note: Favorite links. Your users can set up their preferences to include the portal's navigation option on their *Favorite Links*. This way, they can easily navigate to the portal without going through menus.

Granting Access to A Portal

An *application service* is associated with each *stand-alone portal*. A user must be granted access rights to the respective application service in order to see a portal.

Fastpath: Refer to *The Big Picture Of Application Security* for information about granting users access rights to an application service.

Note: Automatically created. When you add a new stand-alone portal, the system automatically creates an application service behind the scenes. You'll need to know the name of this application service as this is what you use to grant access to the portal. The name of each stand-alone portal's application service is shown on the portal transaction.

Please note the following in respect of how application security impacts a user's zones:

- A user's *Portal Preferences* page only shows the portals configured to show on user preferences and where they have security access.
- The system's menus only show portals to which a user has security access.

- Users can set up favorite links to all portals, but they must have security rights to the portal's application service in order to invoke the favorite link.

Portal Hierarchies

It is possible to create hierarchies of *stand-alone portals*. The following illustration shows three very simple Oracle Utilities Business Intelligence stand-alone portals:



While each of the portals shown above can be opened independently, the sample zones shown on the High-level Portal have been set up to have hyperlinks. When these hyperlinks are clicked, different portals are opened. The destination portals have been configured to have zones that show more detailed information about the data shown on the high-level objects. For example:

- The **Average Complaint Duration Traffic Light** zone has been configured to have a hyperlink to the **Complaints Portal** (which has zones that show many different analytics related to complaints).
- The **Total Revenue Traffic Light** zone has been configured to have a hyperlink to the **Revenue Portal** (which has zones that show many different analytics related to revenue).

There is no limit to the number of levels of portals you can have.

Custom Look and Feel Options

The default look and feel of the application can be customized via feature configuration and cascading style sheets. The base package is provided with a **Custom Look And Feel** *Feature Configuration* type. You may want to set up a feature configuration of this type to define style sheet and UI Map help options.

User Interface

The base package allows for the conditional inclusion of customer styles into the system style set. The custom style may override any style provided by the base package. The style sheet may also include new styles for use in customer zone definitions. Use the **Style Sheet** option on the **Custom Look And Feel** Feature Configuration to define your custom style sheet.

Note: Note. Some styles cannot change if they are part of the HTML code.

Caution: Implementers must ensure that the customized user interface is stable and scalable. Changing font, alignment padding, border size, and other user interface parameters may cause presentation problems, like scrollbars appearing or disappearing, cursors not working as expected, and unanticipated look and feel alterations of some layouts.

UI Map Help

A *tool tip* can be used to display additional help information to the user. This applies to section elements as well as individual elements on a map zone or UI Map. Refer to the tips context sensitive zone associated with the UI Map page for more information. The **Custom Look And Feel** Feature Configuration provides options to control the following:

- Whether UI Map Help functionality is turned on or off. By default it is turned on.
- Override the default help image with a custom image
- The location of the help image, either before or after the element.

Fastpath: Refer to the feature configuration for a detailed description of each option.

Setting Up Portals and Zones

The topics in this section describe how to set up portals and zones. Please refer to the [The Big Picture of Portals and Zones](#) for background information.

Defining Zone Types

Select **Admin Menu > Zone Type** to maintain zone types.

Two types of parameters are specified when defining a zone type:

- Parameter values that have a **Usage of Zone** are defined on the zones and control the functionality of each zone governed by the zone type. A **Usage** value of **Zone - Override Allowed** indicates that override parameters for a zone can be entered.
- Parameter values that have a **Usage of Zone Type** are defined directly on the zone type and control how the zone type operates (e.g., the name of the XSL template, the name of the application service). A **Usage** value of **Zone Type - Override Allowed** indicates that override parameters for a zone can be entered.

Caution: Do not remove or modify zone types provided with the base package, as base product zones will no longer function. Additionally, this may introduce system instability.

Description of Page

Specify an easily recognizable **Zone Type** code and **Description**. Use the **Long Description** to describe in detail what the zone type does.

Caution: When adding new zone types, carefully consider its naming convention. Refer to [System Data Naming Convention](#) for more information.

Owner indicates if this zone type is owned by the base package or by your implementation (**Customer Modification**). The system sets the owner to **Customer Modification** when you add a zone type. This information is display-only.

Java Class Name is the Java class responsible for building the zone using the parameters defined below. The following points describe the fields that are defined for each parameter:

- **Sequence** defines the relative position of the parameter.
- **Parameter Name** is the name of the parameter.
- **Description** is a short description that allows you to easily identify the purpose of the parameter.
- **Comments** contain information that you must know about the parameter or its implementation.
- **Usage** indicates whether the parameter refers to a **Zone** or a **Zone Type**. **Zone - Override Allowed** and **Zone Type - Override Allowed** indicate that override parameters for a zone can be entered.
- **Required** is checked to indicate that a zone must define a value for the parameter. It is not checked if a value for the parameter is optional. This field is protected if the **Usage** is **Zone Type**.
- **Parameter Value** is used to define the value of zone type parameters. This field is protected if the **Usage** is **Zone**.

Note: Note. **Owner** indicates if this parameter is owned by the base package or by your implementation (**Customer Modification**). The system sets the owner to **Customer Modification** when you add a parameter. This information is display-only.

Where Used

Follow this link to open the data dictionary where you can view the tables that reference [CI_ZONE_HDL](#).

Framework-owned Zone Type Parameter Comments

The following Zone Type Parameter Comment strings are offered here because they exceed 1,500 characters and may cause localization issues when translated to some languages within the Framework UI.

Zone Type Parameter: F1 or F1_<n>

The following Comment applies to the F1 or F1_<n> parameter in the following Framework-owned Zone Types: F1-DE, F1-DE-QUERY, and F1-DE-SINGLE.

A user filter is a field that a user enters to restrict the zone's rows and / or columns. For example, if a user can restrict the information that appears based on the customer's name and address, the zone would have at least 2 user filters.

A user filter is defined using the following mnemonics:

type=. This mnemonic defines the visual metaphor used to capture the filter values. The following values are supported:

- DATE. Filters of this type capture a date.
- DATE/TIME. Filters of this type capture a date and time.
- STRING. Filters of this type capture a string.
- MONEY. Filters of this type capture a monetary field. Filters of this type must also reference the cur mnemonic.
- NUMBER. Filters of this type capture a numeric field. Filters of this type may also reference the decimals mnemonic.
- LOOKUP. Filters of this type capture a lookup value. Filters of this type must also reference the lookup mnemonic.
- TABLE. Filters of this type capture an admin tables' records (code and description). Filters of this type must also reference the table mnemonic.
- CHARTYPE. Filters of this type capture predefined characteristic values for a characteristic type (code and description). Filters of this type must also reference the chartype mnemonic.
- ASIS. Filters of this type capture a list of values to be referenced within an 'IN' clause within the SQL statement.

label=. This mnemonic defines a filter's label (the label appears in the zone's description bar and in the input area). There are two ways to define an override label:

- You can reference a field name whose label should be used.
- You can simply enter a text string in single quotes. Please be aware that using this method means the zone will not be "multi-lingual".

cur=. This mnemonic defines the currency code applied when type=MONEY. For example, entering cur=USD will apply the currency formatting of the USD currency code.

The following Comment applies to the F1 or F1_<n> parameter in the following Framework-owned Zone Types: F1-DE, F1-DE-QUERY, and F1-DE-SINGLE.

decimals=. This mnemonic defines the number of decimal places when type=NUMBER field. It is optional and, if not provided, will default to the number of decimal places defined on the currency code specified on the installation record.

lookup=. This mnemonic defines the lookup flag whose values appear when type=LOOKUP.

table=. This mnemonic defines the admin table whose values appear when type=TABLE.

chartype=. This mnemonic defines the characteristic type code whose values appear when type=CHARTYPE.

xpath=. This mnemonic is used in conjunction with a Filter Area UI Map. For each filter, you must specify the xpath to the corresponding UI map schema element. For example, xpath=nameFromUIMap. Note that the type= mnemonic must also be appropriate for the map's input field, otherwise the query's SQL could fail.

likeable=. This mnemonic defines if a likeable search is performed on the entered value when type=STRING. The following values are supported:

- S (suffix % to the filter value)
- P (prefix % to the filter value)
- PS (prefix AND suffix % to the filter value)

divide=. The mnemonic controls if a divider line appears above and/or below the filter. The following values are supported:

- above (places a divider line above the filter)
- below (places a divider line below the filter)

Note, you can specify this parameter twice if you want divider lines placed above and below a filter, e.g., divide=above divide=below.

searchField=. This mnemonic controls the initial population of the filter when the zone is launched as a search from a ui map. The value should exactly match the searchField name specified in the oraSearchField html element.

Zone Type Parameter: H1 or H1_<n>

The following Comment applies to the H1 or H1_<n> parameter in the following Framework-owned Zone Types: F1-DE, F1-DE-QUERY, and F1-DE-SINGLE.

A hidden filter is a field that restricts the rows and columns that appears in a zone. The following are the potential sources of a hidden filter's value:

- The global area contains the fields whose values are maintained in globals (think of globals as the fields whose value appear in the dashboard's Context Zone). For example, in CC&B, the global context fields are the person ID, account ID and premise ID of the customer in context. You can use these fields as hidden filters to restrict the zone's rows and / or columns. For example, you might have a zone on Control Central that should only be populated when an account ID is populated.

- The portal area fields contain the fields describing the object currently displayed in a portal. For example, if you're on the service point portal, the service point's ID is held in the portal area. You can use the portal fields as hidden filters to restrict the zone's rows and / or columns.

Also note, other zones on a portal can populate the portal area with fields and values. For example, you might have a portal with a zone containing an account's service agreements. When a user clicks on a line in the zone (i.e., when they broadcast the line's SA ID into the portal area), zones with a hidden filter called "SA ID" will be populated. Prior to being broadcast the filter value, the zone will either be empty or contain a message describing why they are empty (you can define the message in another parameter).

A hidden filter is defined using the following mnemonics:

name=. This mnemonic defines the name of the field that needs to be broadcast from other zones or populated in the portal context

type=. This mnemonic defines the visual metaphor used to capture the filter values. The following values are supported:

- STRING. Filters of this type capture a string.
- DATE. Filters of this type capture a date.
- DATE/TIME. Filters of this type capture a date and time.
- ASIS. Filters of this type capture a list of values to be referenced within an 'IN' clause within the SQL statement.

poprule=. This mnemonic controls what happens if the hidden filter is not present:

The following Comment applies to the H1 or H1_<n> parameter in the following Framework-owned Zone Types: F1-DE, F1-DE-QUERY, and F1-DE-SINGLE.

- If this mnemonic is set to R (required), the zone will be set to the "empty state" (i.e., the "please broadcast" message will appear in the zone). This is the default value.

- If this mnemonic is set to O (optional), the zone will be built and this filter will be ignored.

label=. This mnemonic defines the filter's label (the filter's label appears in the zone's description bar). There are two ways to define an override label:

- You can reference a field name whose label should be used.

- You can simply enter a text string in single quotes. Please be aware that using this method means the zone will not be "multi-lingual".

datasource=. This mnemonic defines the source of the hidden filter's value:

- If this parameter is set to G, the filter's value is broadcast from the "global" context.

- If this mnemonic is set to P, the filter's value is retrieved from the "portal" context.

- If this parameter is set to D, the filter's value is retrieved from the "page data model".

If this mnemonic is left blank, the default behavior is as follows:

- If the field has been broadcast from another zone, the broadcast value is used.

- If no value is broadcast, the portal context is checked to determine if this field exists (if so, its value is taken).

- If still no value, the global context is checked.

- If still no value, the zone appears as per the poprule mnemonic.

searchField=. This mnemonic controls the initial population of the filter when the zone is launched as a search from a ui map. The value should exactly match the searchField name specified in the oraSearchField html element.

Zone Type Parameter: IMPLEMENTOR_ACTION_<n>

The following Comment applies to the IMPLEMENTOR_ACTION_<n> parameter in all Framework-owned Zone Types except SERVICE and SIMPLE.

You can define up to 5 actions that will appear in the zone header. The actions can appear as a hyperlink, icon or button. The action can also be provided as an HTML string.

Actions are defined using the following mnemonics:

type=. This mnemonic defines the appearance of the action in the zone header. The valid values are:

-LINK Produce the action as a textual hyperlink.

-ICON Produce the action as a graphical icon.

-BUTTON Produce the action as an HTML button.

-ASIS The parameter will provide the HTML to be used for the action.

action=. This mnemonic defines the action to take when the link/icon/button is clicked. This is ignored when the type=ASIS. Valid values are:

-NAVIGATION This indicates the action is a simple navigation to a tab page.

-SCRIPT This indicates the action is to run a BPA script.

navopt='NAV_OPT_CD'. This defines the navigation option to use when the action=NAVIGATION.

bpa='SCR_CD'. This defines the script to run when the action=SCRIPT.

icon= This is required when the type=ICON. It defines the icon to use.

-DISP_ICON_CD is a reference to an icon defined as a display icon.

-path' Defines an explicit path to the icon (i.e. 'images/gotoZone.gif')

asis='[HTML]'. This is required when the type=ASIS. This provides the ability to precisely define the HTML you wish to have included in the header. All valid HTML is permitted including the use of "ora" css classes and javascript functions.

The following Comment applies to the IMPLEMENTOR_ACTION_<n> parameter in all Framework-owned Zone Types except SERVICE and SIMPLE.

label=. By default, the label or tooltip will come from the navigation option or BPA script description. This may be overridden if desired. Valid values are:

-FLD_NAME is a reference to a field definition.

-'text' is when the text is directly specified. Note: this is not language sensitive.

When navigating to a page or when executing a BPA script, context information is often needed. This is defined by use of the context mnemonic:

context=[NAME=FLD_NAME]

context=[NAME=xpath]

The "NAME" is the name of the context field or BPA script variable (the destination). The FLD_NAME is the name of the field to obtain from portal context, global context or the page data model. The xpath can be used when the zone is displaying a UI Map. The xpath reference will retrieve a value from the UI Map schema using the reference provided. Many name/value pairs may be defined.

sourceLoc=. This mnemonic defines the source of the FLD_NAME's value:

- If this parameter is set to G, the field's value is retrieved from the "global" context.

- If this parameter is set to P, the field's value is retrieved from the "portal" context.

- If this parameter is set to D, the field's value is retrieved from the "page data model".

If this mnemonic is left blank, the default behavior is as follows:

1) The portal context is checked.

2) If no portal context value found, the global context is checked.

3) If neither value is available, the field is ignored.

The link/icon/button actions will all have a standard look and feel. These may be overridden if desired.

class='className ... '. This will provide a class name to the action and this may be used to apply css styles. Multiple class names may be provided.

style='...; ...; ...;'. This will apply the defined style to the action element. It is in the standard style= format and all allowed css style definitions may be used.

Examples:

```
type=BUTTON action=SCRIPT bpa='F1-SET-USER' context=[USER_ID=USER_ID] label="Update"
```

```
type=LINK action=NAVIGATION navopt='gotoUser' context=[USER_ID=path(schema/userId)]
```

```
type=ASIS asis=['<A class="oraLink" href="www.google.com">Search</a>']
```

Zone Type Parameter: MULTI_SEL_ACTION_<n>

The following Comment applies to the MULTI_SEL_ACTION_<n> parameter in the following Framework-owned Zone Types: F1-DE, F1-DE-QUERY, and F1-DE-SINGLE.

This defines an action to be included in the action area for multi-selection processing. Note that a multi-selection action can only be used if the Multi Select parameter has been set to YES, which causes a checkbox to appear on each row displayed. The action defined here will trigger against all rows selected by the user via the checkbox. A multi select action has the following mnemonics:

script=xxxx. This is a reference to a script (BPA or SERVICE). This is required.

type=xxxx. Valid values are BUTTON (an HTML button), LINK (clickable text) or ICON (a graphic). BUTTON is default.

icon='xxxx'. A reference a Display Icon code. Required when type=ICON; otherwise not allowed.

refresh=OPTION. The refresh performed on completion of the script

- NO. No refresh will be performed, this is the default.

- ZONE. A refresh of the zone.

- PORTAL. A refresh of the entire portal.

The following Comment applies to the MULTI_SEL_ACTION_<n> parameter in the following Framework-owned Zone Types: F1-DE, F1-DE-QUERY, and F1-DE-SINGLE.

By default, the button label, link text, or icon tooltip will come from the script description. This may be overridden as follows:

label=MD_FIELD. A meta data field

label='xxxx'. A hard coded label (not language independent).

When executing the script, the framework will build an XML list containing information from each row selected. This list must be defined in the script's schema. Population of the list elements is described below:

list=xxxx. The list element name within the script's schema.

context=[XML_NAME=ELEMENT_REF XML_NAME=ELEMENT_REF]

XML_NAME is the name of the XML field to populate in the list.

ELEMENT_REF may reference any of the following:

- Cx. A reference to a column parameter.
- Px. A reference to a post processing parameter.
- COLUMN_NAME. A column name referenced in the SQL statement.
- 'any value'. Any value between single quotes.

Multiple context pairs may be defined for the list elements (separated by spaces). For example:

```
- <schema>
- <accountInfo type="list">
- <accountId/>
- <name/>
- <amount/>
- <process/>
- </accountInfo>
- </schema>
- list=accountInfo
- context=[accountId=ACCT_ID name=C2 amount=P3 process='O']
```

The action look and feel can be overridden by using the following mnemonics (both optional):

class="xxxx xxxx". All classes defined here will be APPENDED to the standard class(es). Multiple classes may be defined in this mnemonic (separated by a space).

style="xxxx". Any css definition desired may be added.

Zone Type Parameter: OVRD_IMPL_ACTION_<n>

The following Comment applies to the OVRD_IMPL_ACTION_<n> parameter in all Framework-owned Zone Types except FAVORITES, SERVICE, and SIMPLE.

You can define up to 5 actions to appear in the zone header. The actions can appear as a hyperlink, icon or button. The action can also be provided as an HTML string. The actions defined here will override any actions defined on the zone type (if present).

Actions are defined using the following mnemonics:

type=. This mnemonic defines the appearance of the action in the zone header. The valid values are:

- LINK Produce the action as a textual hyperlink.
- ICON Produce the action as a graphical icon.
- BUTTON Produce the action as an HTML button.

The following Comment applies to the OVRD_IMPL_ACTION_<n> parameter in all Framework-owned Zone Types except FAVORITES, SERVICE, and SIMPLE.

-ASIS The parameter will provide the HTML to be used for the action.

action=. This mnemonic defines the action to take when the link/icon/button is clicked. This is ignored when the type=ASIS. Valid values are:

-NAVIGATION This indicates the action is a simple navigation to a tab page.

-SCRIPT This indicates the action is to run a BPA script.

navopt='NAV_OPT_CD'. This defines the navigation option to use when the action=NAVIGATION.

bpa='SCR_CD'. This defines the script to run when the action=SCRIPT.

icon= This is required when the type=ICON. It defines the icon to use.

-DISP_ICON_CD is a reference to an icon defined as a display icon.

-path' Defines an explicit path to the icon (i.e. 'images/gotoZone.gif')

asis=['HTML']. This is required when the type=ASIS. This provides the ability to precisely define the HTML you wish to have included in the header. All valid HTML is permitted including the use of "ora" css classes and javascript functions.

label=. By default, the label or tooltip will come from the navigation option or BPA script description. This may be overridden if desired. Valid values are:

-FLD_NAME is a reference to a field definition.

-text' is when the text is directly specified. Note: this is not language sensitive.

When navigating to a page or when executing a BPA script, context information is often needed. This is defined by use of the context mnemonic:

context=[NAME=FLD_NAME]

context=[NAME=xpath]

The "NAME" is the name of the context field or BPA script variable (the destination). The FLD_NAME is the name of the field to obtain from portal context, global context or the page data model. The xpath can be used when the zone is displaying a UI Map. The xpath reference will retrieve a value from the UI Map schema using the reference provided. Many name/value pairs may be defined.

sourceLoc=. This mnemonic defines the source of the FLD_NAME's value:

- If this parameter is set to G, the field's value is retrieved from the "global" context.

- If this parameter is set to P, the field's value is retrieved from the "portal" context.

- If this parameter is set to D, the field's value is retrieved from the "page data model".

If this mnemonic is left blank, the default behavior is as follows:

1) The portal context is checked.

2) If no portal context value found, the global context is checked.

3) If neither value is available, the field is ignored.

The link/icon/button actions will all have a standard look and feel. These may be overridden if desired.

class='className'. This will provide a class name to the action and this may be used to apply css styles. Multiple class names may be provided.

style='!...; ...; ...;'. This will apply the defined style to the action element. It is in the standard style= format and all allowed css style definitions may be used.

Examples:

type=BUTTON action=SCRIPT bpa='F1-SET-USER' context=[USER_ID=USER_ID] label="Update"

type=LINK action=NAVIGATION navopt='gotoUser' context=[USER_ID=path(schema/userId)]

type=ASIS asis=['Search']

Note: If there is a desire to simply remove the actions defined on the zone type, the following value can be used:

type=ASIS asis=[]

Defining Zones

The contents of this section describe how to maintain zones.

Zone - Main

Select **Admin Menu > Zone** to maintain a zone.

Caution: Do not remove or modify zones provided with the base package, as this may produce indeterminate results and may cause system instability.

Description of Page

Specify an easily recognizable **Zone** identifier and **Description**.

Caution: Important! When introducing a new zone, carefully consider its naming convention. Refer to [System Data Naming Convention](#) for more information.

Owner indicates if this zone is owned by the base package or by your implementation (**Customer Modification**). The system sets the owner to **Customer Modification** when you add a zone. This information is display-only.

Zone Type identifies the zone type that defines how the zone functions. The zone type's **Long Description** is displayed below.

Application Service is the application service that is used to provide security for the zone. Refer to [Granting Access To Zones](#) for more information.

The **Width** defines if the zone occupies the **Full** width of the portal or only **Half**.

Note: Zones on the [dashboard portal](#) are always the width of the dashboard.

If the zone type supports help text, you can use **Zone Help Text** to describe the zone to the end-users. For example, all Oracle Utilities Business Intelligence zone types can display help text when the zone's help button is clicked. However help text cannot be displayed on Dashboard zones. Please refer to the section on [zone help text](#) for more information on how you can use HTML and cascading style sheets to format the help text.

Use **Override Zone Help Text** to override the existing embedded help text for this zone.

Note: Viewing Your Text. You can press the **Test** button to see how the help text will look when it's displayed in the zone.

The grid contains the zone's parameter values. The Zone Type controls the list of parameters. The grid contains the following fields:

- **Description** describes the parameter. This is display-only. Note that if there is a detailed description on the zone type parameter, a question mark icon appears next to the parameter's description. Click the icon to see details related to the parameter, including tips on how to populate the parameter value.
- **Parameter Value** is the value for the parameter.
- Use **Override Parameter Value** to override the existing value for this parameter. This field is enabled when the related zone type parameter value is **Zone - Override Allowed**, and the zone is owned by the base product.
- **Owner** indicates if this parameter is owned by the base package or by your implementation (**Customer Modification**). This information is display-only.

Fastpath: Business Intelligence zones. If this is a zone from Oracle Utilities Business Intelligence, you can read about the various parameters and how they are used in the Configuring BI Zones chapter in that product's Administration Guide.

Where Used

Follow this link to open the data dictionary where you can view the tables that reference [CI_ZONE](#).

Zone - Portal

Select **Admin Menu > Zone** and navigate to the **Portal** tab to define the portals on which a zone appears.

Description of Page

The scroll area contains the portals on which the zone appears.

To add a zone to a portal, press the + button and specify the **Portal**. Refer to [Zones Appear By Default](#) for how newly added zones are shown to users.

Note: Note. Owner indicates if this portal / zone relationship is owned by the base package or by your implementation (**Customer Modification**). This information is display-only.

Note: You can also add a zone to a portal using [Portal - Main](#).

Zone How To Guide

The topics in this section provide tips and techniques to assist you in setting up your zones.

How to Add a New Zone

The steps necessary to add a new zone depend on the zone's zone type. For example, if you want to add a new zone that references one of the Oracle Utilities Business Intelligence zone types, no programming is necessary (you simply add a new zone using the above transaction the zone's parameters).

However, if you need to add a new zone with an idiosyncratic service or user interface, you must involve a programmer. Let's use an example to help clarify what you can do versus what a programmer must do. Assume that you want to add a new account characteristics zone to Oracle Utilities Customer Care and Billing. To do this you must:

- Create a new service that retrieves the data to appear in your zone.
- Create a new XSLT template file (or reuse an existing one) that formats the data.
- Set up the appropriate [zone type](#) meta-data. The zone type will reference a Java class that is responsible for taking the data from your service and applying an XSL template to generate the HTML fragment that displays in the zone.
- Create a [zone](#) called **Account Characteristics** (or something similar). On this zone, define the name of the service that you created above. You'd also define the various parameter values required by the zone type, such as the service name, XSLT template location, and key fields. If we assume that your account characteristics zone needs to know the account ID, you'd indicate ACCT_ID as one of your key parameter values.
- After creating the new zone, you can reference it on a [portal](#) or as a [context-sensitive zone](#) or both.

If you want to create more complex zones, you have two options:

- You can use the simple zone type that passes through any HTML fragment that you want to display. In your HTML fragment, you can use an iframe and/or JSP to do the complicated data processing and formatting.
- If the simple zone type will not work for your needs, you may need to create your own zone type.

Fastpath: For more information about developing services and zones, refer to the **Software Development Kit Developer Guide**.

Zone Help Text

Some zone types support a button that allows a user to see zone-specific help text. For example, many Oracle Utilities Business Intelligence zones support this functionality.

If your zone types support help text, you can define this text on the zone page.

You can use HTML tags in the zone help text. The following is an example of help text that contains a variety of HTML tags:

**This zone summarizes `revenue` in 4 periods:`
`**

The above would cause the word **revenue** to be bold and blue:

- `` and `` are the HTML tags used to indicate that the surrounded text should be bold
- `` and `` are the HTML tags used to indicate that the surrounded text should be blue.

The following are other useful HTML tags:

- `
` causes a line break in a text string. If you use `

` a blank line will appear.
- `<i>` causes the surrounded text to be italicized

Please refer to an HTML reference manual or website for more examples.

You can also use "spans" to customize the look of the contents of a text string. For example, your text string could be `revenue`. This would make the word "revenue" appear as large, bold, Courier text. Please refer to a Cascading Style Sheets (CSS) reference manual or website for more examples.

The following is an example of help text using a variety of HTML tags:

```
<font FACE="arial" size=2>
```

This zone summarizes `revenue` in 4 periods:`
`

- The `1st period` is under your control. You simply select the desired `Period`, above `<i>`(you may need to click the down arrow to expose the filter section)`</i>
`
- The `2nd period` is the period before the 1st period`
`
- The `3rd period` is the same as the 1st period, but in the previous year`
`
- The `4th period` is the period before the 3rd period`
`

```
<br>
```

The traffic light's color is determined as follows:`
`

- The ratio of the 1st and 3rd period is calculated`
`
- If this value is between 80 and 100, `yellow` is shown`
`
- If this value is < 80, `red` is shown`
`
- If this value is > 100, `green` is shown`
`
- If the value of the 3rd period is 0, no color is shown`
`

```
</font>
```

Note: It is possible to associate tool tip help with individual HTML and UI map elements. For more information, see [UI Map Help](#).

Maintaining Embedded Help

Embedded Help is the help text that is available to users on the fields of the application.

You can use the Embedded Help portal to create or override the help text that appears on the fields in a UI Map. Open this page using **Admin > Embedded Help**.

Description of Page

Use the UI Map Search zone to search for the UI Map. You can search by UI Map name, Description, Business Object name, or Business Object Description. The Business Object search filters will only display UI maps that are defined on a business object's options.

In the search results table the following actions are available:

- Click the **Description** link to go to the associated UI Map's maintenance page.
- Click **Edit** to open the Embedded Help Authoring page. The following actions are available on this page:
 - You can edit the **Label** and **Help Text** fields if the system owner is the same as the field owner.
Note: Do not edit the **Label** or **Help Text** fields for fields supplied in the base package.
 - You can edit the **Override Label** and **Override Help Text** fields if the system owner is not the same as the field owner. The values in these fields will override the existing label and help text.
 - All disabled fields will have their text prefixed with "(PROTECTED)."
 - Click **Save** to save your changes.
 - Click **Close** to close the page.
 - Click **Download to CSV File** to create a file that contains the fields and their values. You can use this file for authoring the embedded help.
 - Click **Browse** to locate a CSV file that you would like to upload.
 - Click **Upload** to upload a CSV file. When you upload the file your new label and help text values will be saved to the system.

Defining Context-Sensitive Zones

A context-sensitive zone allows you to associate a zone with a specific user-interface transaction. A context-sensitive zone appears at the top of the Dashboard when a user accesses a page for which the zone is specified as the context. For example, if you create an Account Characteristics zone and add it as a context-sensitive zone to the Account Maintenance page it appears in the Dashboard whenever a user accesses the Account Maintenance page.

Caution: Make sure that the zone is appropriate for the transaction on which you are specifying it. For example, if your zone requires an account ID as one of its keys, you would not display it on the Meter Read transaction.

Select **Admin Menu > Context Sensitive Zone** to maintain context-sensitive zones.

Description of Page

The **Navigation Key** is a unique identifier of a tab page within the system. **Owner** indicates if this navigation key is owned by the base package or by your implementation (**Customer Modification**).

Caution: Important! When introducing a new context sensitive zone, carefully consider its naming convention. Refer to [System Data Naming Convention](#) for more information.

The grid contains the list of context-sensitive zones and the sequence in which they appear in the dashboard for the selected navigation key. The grid contains the following fields:

- **Zone** is the name of the zone to display in the Dashboard.
- **Sequence** is the sequence in which the zone is displayed (if multiple context-sensitive zones are defined).
- **Owner** indicates if this context sensitive zone is owned by the base package or by your implementation (**Customer Modification**).

Where Used

A context-sensitive zone displays at the top of the Dashboard whenever a user accesses the transaction for with the zone is specified.

Defining Portals

This transaction is used to define / change portals. Navigate to this page using **Admin Menu > Portal** .

Description of Page

Enter a meaningful and unique **Portal** code and **Description**. Please be aware that for *stand-alone portals*, the Description is the portal page's title (i.e., the end-users will see this title whenever they open the portal).

Caution: Important! When introducing a new portal, carefully consider its naming convention. Refer to *System Data Naming Convention* for more information.

Owner indicates if this portal is owned by the base package or by your implementation (**Customer Modification**). The system sets the owner to **Customer Modification** when you add a portal. This information is display-only.

Type flag indicates whether the portal is a **Standalone Portal**, a **Tab Page Portal** or the **Dashboard**. Refer to *There Are Three Types of Portals* for more information.

The following fields are only enabled for **Standalone Portals**:

- **Navigation Option** defines the navigation option that is used to navigate to this portal from menus, scripts and your favorite links. The navigation option is automatically created when a **Standalone Portal** is added.
- You'll find an **Add To Menu** button adjacent. This field is only enabled if the navigation option is NOT referenced on a menu. When you click this button, a pop-up appears where you define a menu. If you subsequently press **OK**, a menu item is added to the selected menu. This menu item references the portal's navigation option. You can reposition the menu item on the menu by navigating to the *Menu page*.

Refer to *Putting Portals on Menus* for more information.

- **Application Services** defines the service used to secure this portal. The application service is automatically created when a **Standalone Portal** is added. Please note that only users with access to this application service will be able to view this portal and its zones. Refer to *Granting Access to A Portal* for more information.
- **Show on Portal Preferences** indicates if a user is allowed to have individual control of the zones on this portal. The portal will not appear in the accordion on the user's Portal Preferences page if this value is set to No.

The grid contains a list of zones that are available in the portal. Click + to add a new zone to the portal. Click - to remove a zone from the portal. The grid displays the following fields:

- **Zone** is the name of the zone as defined on the Portal Zone page.
- **Description** is a description of the zone as defined on the Portal Zone page.
- **Display** controls whether or not the zone is visible in the portal. For portals that are configured to Show on Portal Preferences, users may override this value for their view of the portal.
- **Initially Collapsed** controls whether or not the zone is initially collapsed in the portal. For portals that are configured to Show on Portal Preferences, users may override this value for their view of the portal.

- **Default Sequence** is the default sequence number for the zone within the portal. It does not need to be unique within the portal. Note that a sequence of zero will appear last, not first, in the portal. For portals that are configured to Show on Portal Preferences, users may override this value for their view of the portal.
- **Override Sequence** can be used by an implementation team to override the Default Sequence value that is set in the base package.
- **Refresh Seconds** defines in seconds how often the zone is automatically refreshed. The minimum valid value is 15. The maximum valid value is 3600 (1 hour). A value of 0 indicates no automatic refresh. Implementers can change this value as needed.
- **Owner** indicates if this portal / zone relationship is owned by the base package or by your implementation (**Customer Modification**). This information is display-only.

Note: Newly added zones. Refer to *Zones Appear By Default* for how newly added zones are shown to users for portals that are configured to Show on Portal Preferences.

Note: Removing zones from a portal. You cannot remove a zone if a user has enabled it on their Portal Preferences. To remove a zone from the portal list, first make sure that no user has it enabled in their portal preferences.

Where Used

Follow this link to open the data dictionary where you can view the tables that reference [CI_PORTAL](#).

Defining Display Icons

Icons are used to assist users in identifying different types of objects or instructions. A limited number of control tables allow administrative users to select an icon when they are configuring the system. Select **Admin Menu > Display Icon Reference** to maintain the population of icons available for selection.

Description of Page

Each icon requires the following information:

- **Display Icon** is a code that uniquely identifies the icon.
- **Icon Type** defines how big the icon is (in pixels). The permissible values are: **30 x 21**, **21 x 21**, and **20 x 14**. Note that only icons that are **20 x 14** can be used on base package instructions.
- **Description** contains a brief description of the icon.
- **URL** describes where the icon is located. Your icons can be located on the product's web server or on an external web server.
- To add a new icon to the product web server, place it under the **/cm/images** directory under the **DefaultWebApp**. Then, in the **URL** field, specify the relative address of the icon. For example, if the icon's file name is **myIcon.gif**, the **URL** would be **/cm/images/myIcon.gif**.
 - If the icon resides on an external web server, the **URL** must be fully qualified (for example, **http://myWebServer/images/myIcon.gif**).
 - **Owner** indicates if this icon is owned by the base package or by your implementation (**Customer Modification**). This information is display-only.

Where Used

Follow this link to open the data dictionary where you can view the tables that reference [CI_DISP_ICON](#).

Defining Navigation Keys

Each location to which a user can navigate (e.g., transactions, tab pages, tab menus, online help links, etc.) is identified by a navigation key. A navigation key is a logical identifier for a URL.

Navigation Key Types

There are two types of navigation keys:

- **System navigation keys** define locations where the URL is derived from other entities within the system. The items that are derived include the program location (i.e., physical location on the server), file name (i.e. program component name), and the file extension (e.g. COB). System navigation keys refer to program components, such as tab menus or tab pages.
- **External navigation keys** define locations simply as a URL. External URLs can be specified as relative to the product web server or fully qualified. External navigation keys always launch in a new instance of a browser window. Examples of external navigation keys include online help links and URLs to external systems.

Navigation Key vs. Navigation Option

The system has two entities that work in conjunction with each other to specify how navigation works:

- *Navigation Key* defines a unique location to which a user can navigate. For example, each page in the system has a unique navigation key. Navigation keys can also define locations that are "outside" of the system. For example, you can create a navigation key that references an external URL. Think of a navigation key as defining "where to go".
- *Navigation Option* defines how a page is opened when a user wants to navigate someplace. For example, you might have a navigation key that identifies a specific page. This navigation key can then be referenced on two navigation options; the first navigation option may allow users to navigate to the page in "add mode", while the second navigates to the page in "update mode".
- Please note that a wide variety of options can be defined on a navigation option. In addition to defining if a page is opened in add or update mode, you can define which tab is opened, which fields should be passed to the page, which search program is used, etc.

The Flexibility of Navigation Keys

Navigation keys provide a great deal of functionality to your users. Use navigation keys to:

- Allow users to navigate to new pages or search programs
- Allow users to transfer to an external system or web page. After setting up this data, your users may be able to access this external URL from a menu, a context menu, their favorite links, etc. [Refer to Linking to External Locations](#) for more information.

Refer to the Tool Suite Guide for more information on developing program components.

Note: Replacing Base-Package Pages or Searches. If your new page or search has been designed to replace a module in the base-package, the navigation key must indicate that it is [overriding an existing navigation key](#).

Linking to External Locations

If you want to include links to external systems or locations from within the system, you need to:

- Define a *navigation key* that specifies the URL of the location. For example, define an external navigation key that as a URL of <http://www.oracle.com/>.
- Define a *navigation option* that specifies from where in the system a user can go to your external location. For example, define a navigation option with a usage of **Favorites** or with a usage of **Menu**. Your navigation option points to the navigation key you defined above.
- Add your navigation option to the appropriate location within the system. For example, have users add the navigation option to their *Favorite Links* or add the navigation option as an item on a *menu*.

Overriding Navigation Keys

Your implementation may choose to design a program component (e.g., a maintenance transaction or search page) to replace a component provided by the system. When doing this, the new navigation key must indicate that it is overriding the system navigation key. As a result, any menu entry or navigation options that reference this overridden navigation key automatically navigates to the custom component.

For example, if you have a custom On-line Batch Submission page and would like users to use this page rather than the one provided by the system, setting up an override navigation key ensures that if a user chooses to navigate to the On-line Batch Submission from the main menu or from a context menu, the user is brought to the custom On-line Batch Submission page.

To create an override navigation key, you need to:

- Define a *navigation key* using an appropriate *naming convention*.
- If the URL Location of the navigation key being overridden is **External**, specify a URL Location of **Override (External)** and define the appropriate URL Override Location.
- If the URL Location of navigation key being overridden is **System**, specify a **URL Location of Override (System)** and populate the Program Component ID with your custom program component ID.
- Specify the navigation key that you are overriding in the **Overridden Navigation Key** field.

Refer to the Tool Suite Guide for more information about developing your own program components.

Maintaining Navigation Key

Select **Admin Menu > Navigation Key** to maintain navigation keys.

Caution: Important! When introducing a new navigation key, carefully consider its naming convention. Refer to [System Data Naming Convention](#) for more information.

Description of Page

The **Navigation Key** is a unique name of the navigation key for internal use. Try to use a name that is easily recognizable.

Owner indicates if this navigation key is owned by the base package or by your implementation (**Customer Modification**). This information is display-only.

For **URL Location**, you can select from the following options:

- Use **External** to create a navigation key where the location is specified in the **URL Override** field.

- Use **Override (External)** to create a navigation key that overrides another external navigation key. If you use this option, you specify the name of the navigation key you are overriding in the **Overridden Navigation Key** field.
- Use **Override (System)** to point a system navigation key to a different location. If you use this option, you specify the name of the navigation key you are overriding in the **Overridden Navigation Key** field.
- Use **System** to create a navigation key for a custom program component developed for your implementation.

Fastpath: Refer to [Navigation Key Types](#) for more information about system and external navigation keys.

Fastpath: Refer to [Overriding Navigation Keys](#) for more information about settings required to override a system navigation key.

Program Component ID is the name of the program component identified by the key (for system navigation keys). The program component ID can also be used to specify the transaction with which an online help link is associated.

Overridden Navigation Key is the name of the navigation key that the current navigation key is overriding (if **Override (External)** or **Override (System)** is selected for the **URL Location**). Refer to [Overriding Navigation Keys](#) for more information.

URL Override is the specific URL for the navigation key (external navigation keys only). The URL can be relative to the product web server or fully qualified.

Open Window Options allows you to specify options (e.g., width and height) for opening a browser window for an external navigation key. (External navigation keys always launch in a new browser window.) You can use any valid features available in the `Window.open()` JavaScript method. The string should be formatted the same way that it would be for the features argument (e.g., **height=600,width=800,resizable=yes,scrollbars=yes,toolbar=no**). Refer to a JavaScript reference book for a complete list of available features.

Application Service is the application service that is used to secure access to transactions associated with **External** navigation keys. If a user has access to the specified application service, the user can navigate to the URL defined on the navigation key. Refer to [The Big Picture of Application Security](#) for more information.

The grid displays menu items that reference the navigation key (actually, it shows menu items that reference navigation options that, in turn, reference the navigation key).

Where Used

Follow this link to open the data dictionary where you can view the tables that reference [CI_MD_NAV](#).

Defining Navigation Options

Every time a user navigates to a transaction, the system retrieves a navigation option to determine which transaction should open. For example,

- A navigation option is associated with every menu item. When a user selects a menu item, the system retrieves the related navigation option to determine which transaction to open.
- A navigation option is associated with every [favorite link](#). When a user selects a favorite link, the system retrieves the related navigation option to determine which transaction to open.
- A navigation option is associated with every node in the various trees. When a user clicks a node in a tree, the system retrieves the related navigation option to determine which transaction to open.
- Etc.

Many navigation options are shipped with the base package and cannot be modified as these options support core functionality. As part of your implementation, you will probably add additional navigation options to support your specific business processes. For example,

- A user can define their home page on their [user preferences](#). They do this by selecting a navigation option.

- Etc.

The topics in this section describe how to maintain navigation options.

Caution: In order to improve response times, navigation options are cached the first time they are used after a web server is started. If you change a navigation option and you don't want to wait for the cache to rebuild, you must clear the cached information so it will be immediately rebuilt using current information. A special button has been provided on the Main tab of the navigation option transaction that performs this function. Please refer to [Caching Overview](#) for information on the various caches.

Navigation Option - Main

Select **Admin Menu > Navigation Option** to define a navigation option.

Description of Page

Enter a unique **Navigation Option** code and **Description**.

Caution: When introducing a new navigation option, carefully consider its naming convention. Refer to [System Data Naming Convention](#) for more information.

The **Flush System Login Info** button is used to flush the cached navigation options so you can use any modified navigation options. Refer to [Caching Overview](#) for more information.

Owner indicates if this navigation option is owned by the base package or by your implementation (**Customer Modification**). This field is display-only. The system sets the owner to **Customer Modification** when you add a navigation option.

Note: You may not change navigation options that are owned by the base package.

Use **Navigation Option Type** to define if the navigation option navigates to a **Transaction**, launches a BPA **Script** or opens an **Attachment**.

Note: The **Attachment** option type is only applicable to navigation options for the Attachment maintenance object.

For navigation option types of **Transaction** , enter the related information:

- **Navigation Mode** indicates if the **Target Transaction** should be opened in **Add Mode** or **Change Mode**. You may also specify a **Tab Page** if you want to open a tab other than the main tab (i.e., you can leave this field blank if you want the main tab to be displayed when the transaction opens).
- **Add Mode** should be used if the option is used to navigate to a transaction ready to add a new object. You can use the **Context Fields** at the bottom of the page if you want to transfer the contents of specific fields to the transaction when it opens.
- **Change Mode** should be used if the option is used to navigate to a transaction ready to update an object. You have two ways to define the object to be changed:
 - Define the name of the fields that make up the unique identifier of the object in the **Context Fields** (and make sure to turn on **Key Field** for each such field).
 - Define the **Search Transaction** if you want to open a search window to retrieve an object before the target transaction opens. Select the appropriate **Search Type** to define which search method should be used. The options in the drop down correspond with the sections in the search (where **Main** is the first section, **Alternate** is the 2nd section, **Alternate 2** is the 3rd section, etc.). You should execute the search window in order to determine what each section does.

When you select a **Search Type**, the system defaults the related fields in **Context Fields**. This means the system will try to pre-populate the search transaction with these field values when the search first opens. Keep in mind that if a search is populated with field values the search is automatically triggered and, if only one object is found that matches the search criteria, it is selected and the search window closes.

Note: Finding transaction navigation keys. When populating the **Target Transaction** and **Search Transaction** you are populating an appropriate navigation key. Because the system has a large number of transactions, we recommend using the "%" metaphor when you search for the transaction identifier. For example, if you want to find the currency maintenance transaction, enter "%currency" in the search criteria.

- **Search Group** is only visible if the **Development Tools** module is *not turned off*. It is used to define the correlation between fields on the search page and the tab page. You can view a tab page's **Search Groups** by viewing the HTML source and scanning for **allFieldPairs**.

For navigation option types of **script**, indicate the **Script** to launch. You can use the **Context Fields** at the bottom of the page if you want to transfer the contents of specific fields to temporary storage variables available to the script. The script engine creates temporary storage variables with names that match the Context Field names.

The **Go To Tooltip** is used to specify the label associated with the tool tip that appears when hovering over a **Go To** object. Refer to the **Usage** grid below.

The **Usage** grid defines the objects on which this navigation option is used:

- Choose **Favorites** if the navigation option can be used as a *favorite link*.
- Choose **Menus** if the navigation option can be used as a user's *home page* or as a menu or context menu item.
- Choose **Script** if the navigation option can be used in a *script*.
- Choose **Foreign Key** if the navigation option can be used as a *foreign key reference*.
- Choose **Go To** if the navigation option can be used as a "go to" destination ("go to" destinations are used on Go To buttons, tree nodes, algorithm parameters, and hyperlinks).
- If your product supports marketing campaigns, you can choose **Campaign** if the navigation option can be used as a "post completion" transaction on a campaign. For more information refer to that product's documentation for campaigns.

The **Context Fields** grid contains the names of the fields whose contents will be passed to the **Target Transaction** or **Script** or launch of the **Attachment**. The system retrieves the values of these fields from the "current" page and transfers them to the target transaction or to the script's temporary storage. Turn on **Key Field** for each context field that makes up the unique identifier when navigating to a transaction in **Change Mode**.

Note: For an **Attachment**, the grid should contain the ID field for the attachment that will be opened.

Note: No context from menu bar. The standard followed for the base **menu** navigation options is that navigation options launched from the menu bar are configured with no context; navigation options launched from context menus include context.

Where Used

Follow this link to open the data dictionary where you can view the tables that reference [CI_NAV_OPT](#).

Navigation Option - Tree

This page contains a tree that shows how a navigation option is used. Select **Admin Menu > Navigation Option** and navigate to the **Tree** tab to view this page.

Description of Page

The tree shows every menu item, favorite link, and tree node that references the navigation option. This information is provided to make you aware of the ramifications of changing a navigation option.

Defining COBOL Program Options

The topics in this section describe the transaction that allows you to define the metadata for COBOL programs within the current environment's database.

Caution: Updating COBOL Programs requires technical knowledge of the system. This is an implementation and delivery issue and should not be attempted if you do not have previous experience.

COBOL Program - Main

Note: Not available for all products. This page is only available for products that support COBOL.

Use this transaction to define COBOL program user exits for your system. Navigate to this page using **Admin Menu > COBOL Program** .

Description of Page

The following describes fields that are relevant to defining the user exit code that a COBOL Program should use:

Program Component ID represents the internal ID that is given to the COBOL program component.

Prog Com Name is the physical name of the COBOL program component.

Short Comments provides a short description of the COBOL program component.

Template is the template used to generate the COBOL program component.

Specify **User Exit Program** if you have written user exit code for this COBOL program component.

Chapter 5

Database Tools

This section describes a variety of database tools that are supplied with the your product.

Defining Environment Reference Options

An environment reference is used to track a supporting environment's purpose relative to the current environment within the application. An environment is an instance of your product database and runtime programs. Environment references specify roles that describe how the supporting environment is used.

Note: Registration Utility. The registration utility adds environment references for you. Refer to [Archiving and Purging](#) and [Configuration Lab](#) for more information on the functions of the registration utility and how to execute it.

Select **Admin Menu > Environment Reference** to view environments and their use within the application.

Description of Page

Some fields on this page are protected as only the registration utility may change them. The following describes fields you may change and fields that may be relevant to [Archiving](#) and [Configuration Lab](#):

Environment Reference is the name of the supporting environment reference.

Enter a **Description** and **Long Description** for the environment reference.

Use **Environment Role** to specify how the supporting environment that is represented by the environment reference is to be used. The valid values are:

- **Archive.** Specify if the environment reference represents a supporting environment used to house archived data moved from the current environment.
- **Compare Source.** Specify if the environment reference represents a supporting environment used as a source of control data from which the current environment may copy.
- **ConfigLab.** Specify if the environment reference represents an environment used as a configuration lab.
- **Sync Target.** Specify if the environment reference represents a supporting environment used as the target for a copy of a subset of data from the current environment.

Fastpath: For more information on specific uses of environment roles, refer to [Archiving and Purging](#) and [Configuration Lab](#).

The **Environment ID** associates the environment reference with its environment's universal identifier within the application. This universal identifier is on the [Installation Options](#) of the target environment.

Use **Name Prefix** to specify how the current environment accesses tables in the supporting environment described by the environment reference. The prefix replaces the **C** in the table name. For instance, assuming the current environment is production, the production environment accesses the **CI_ACCT** table in the ConfigLab as **ZI_ACCT**.

Defining Table Options

The topics in this section describe the transaction that allows you to define metadata for the application's tables.

Table - Main

Select **Admin Menu > Table** to view information about a table, define the fields whose changes should be audited, and to override a field's label on a specific table.

Description of Page

Note: Many fields cannot be changed. You cannot change most attributes on tables that are owned by the base-package (i.e., those whose **Owner** is not **Customer Modification**).

Description contains a brief description of the table.

System Table defines if the table holds rows that are owned by the base-package.

Enable Referential Integrity defines if the system performs referential integrity validation when rows in this table are deleted.

Data Group ID is used for internal purposes.

Table Usage defines how the table is used in the application. In the current release, only tables that are part of Oracle Utilities Business Intelligence make use of this field.

Table Type defines if the table is a **View** or a physical **Table**.

Date / Time Data Type defines if the system shows times on this table in Local Legal Time or in Standard Time (Local Legal Time is the time as adjusted for daylight savings).

Table Classification Type specifies the category of data the table will hold. This is for information purposes only and is not used by any system processing. Valid values are **Admin System Table**, **Admin Non System Table**, **Master Table**, and **Unclassified**.

Table Volume Type specifies the expected amount of data the table will hold. This is for information purposes only and is not used by any system processing. Base product values are **High Volume**, **Low Volume**, **Medium Volume**, and **Unclassified**. The volume of data in a particular table in the system may differ greatly from one implementation to another based on unique business requirements. The values populated for base product tables are set to volumes that are typical but may not be true for a given implementation. The value may be updated to reflect the situation for a given implementation.

Audit Table is the name of the table on which this table's audit logs are stored. Refer to [The Audit Trail File](#) for more information.

Use **Audit Program Type** to define if the audit program is written in **Java** or **COBOL**.

Note: COBOL Programs. COBOL is not supported for all products.

Audit Program is the name of the program that is executed to store an audit log. Refer to [Turn On Auditing For a Table](#) for more information.

- If the Program Type is **COBOL**, enter the name of the COBOL program.
- If the Program Type is **Java**, enter the Java class name.

Note: View the source. If the program is shipped with the base package, you can use the adjacent button to display the source code of this program in the [source viewer](#) or [Java docs viewer](#).

Upgrade controls what happens to the rows in this table when the system is upgraded to a new release:

- **Keep** means that the rows on this table are not touched during an upgrade
- **Merge** means that the rows on this table are merged with rows owned by the base package
- **Refresh** means that the rows on this table are deleted and refreshed with rows owned by the base package.

Data Conversion Role controls if / how the table is used by the conversion tool:

- **Convert (Retain PK)** means that the table's rows are populated from the conversion schema and the prime key in the conversion schema is used when the rows are converted. A new key is not assigned by the system.
- **Convert (New PK)** means that the table's rows are populated from the conversion schema and the prime key is reassigned by the system during conversion.
- **Not Converted** means that the table's rows are not managed by the conversion tool.
- **View of Production** means that the conversion tool uses a view of the table in production when accessing the rows in the table. For example, the customer class table would be set up using this value so that the conversion tool will use the customer classes in production when it needs to access customer class codes.

A **Language Table** is specified when fields containing descriptions are kept in a child table. The child table keeps a separate record for each language for which a description is translated.

Enable Data Dictionary defines if the table is to be included in the [Data Dictionary](#) application viewer.

A **Key Table** is specified when the prime-key is assigned by the system. This table holds the identity of the prime keys allocated to both live and archived rows.

Type of Key specifies how prime key values are generated when records are added to the table:

- **Other** means a foreign-system allocates the table's prime-key (e.g., the fact and dimension tables within Oracle Utilities Business Intelligence have their keys assigned by Oracle Warehouse Builder).
- **Sequential** means a sequence number is incremented whenever a record is added to the table. The next number in the sequence determines the key value.
- **System-generated** means a program generates a random key for the record when it is added. If the record's table is the child of another table, it may inherit a portion of the random number from its parent's key.
- **User-defined** means the user specifies the key when a record is added.

Inherited Key Prefix Length defines the number of most significant digits used from a parent record's primary key value to be used as the prefix for a child record's key value. This is only specified when the Type of Key is **System-generated** and the high-order values of the table's key is inherited from the parent table.

Java Table Name. This field is used to identify the entity/Java class name of the class that represents the table in the Java code. It should contain a short "camelCased" name to be used as the name of the entity within the system. It must also be a valid Java name, and must be unique across the system. This name is used as follows:

- As the short class name on all classes in the Java hierarchy for the class: the Impl class, the Gen, and the interface.
- In hql queries, it is used to identify the hibernate entity being selected.

Caching Regime determines if the table's values should be cached when they are accessed by a batch process. The default value is **Not Cached**. You should select **Cached for Batch** if you know the values in the table will not change during the course of a batch job. For example, currency codes will not change during a batch process. Caching a table's values will reduce unnecessary SQL calls and improve performance.

Key Validation determines if and when keys are checked for uniqueness. The default value is **Always Check Uniqueness**. Select **Check Uniqueness Online Only** when the database constructs the keys in the table, such as in log tables. Select **Never Perform Uniqueness Checking** when you know that the database constructs the keys in the table and that users cannot add rows directly to the table, such as in log parameter tables. This will reduce unnecessary SQL calls and improve performance.

Help URL is the link to the user documentation that describes this table.

Help Text contains additional information about the table.

The grid contains an entry for every field on the table. Drilling down on the field takes you to the [Table Field](#) tab where you may modify certain attributes. The following fields may also be modified from the grid: **Description**, **Override Label**, **Audit Delete**, **Audit Insert** and **Audit Update**. Refer to the Table Field tab for descriptions of these fields.

Table - Table Field

Select **Admin Menu > Table** and navigate to the **Table Field** tab to define the fields whose changes should be audited and to override a field's label on a specific table (note, you can also maintain a subset of this information in the grid on the Main tab).

Description of Page

Many fields on this page are protected as only the product development group may change them. The following describes fields you may change for records that are part of the base product. Fields containing information that may be of interest are also described.

Turn on **Audit Delete** if an audit record should be stored for this field when a row is deleted. Refer to [How To Enable Auditing](#) for more information.

Turn on **Audit Insert** if an audit record should be stored for this field when a row is added. Refer to [How To Enable Auditing](#) for more information.

Turn on **Audit Update** if an audit record should be stored for this field when it is changed. Refer to [How To Enable Auditing](#) for more information.

The **Label** column only contains a value if the base-product indicates a value other than the field's label should be shown on the various pages in the system. The field's label is shown above, adjacent to the field's code.

The **Override Label** is provided in case you want to override the base-package's label. If specified, it will be displayed throughout the application.

Note: **Note.** If you want the Override Label to be shown in the [data dictionary](#), you must regenerate the data dictionary.

Special Notes contains any notes or special information about the table.

Field Usage defines how the field is used in the application. In the current release, only tables that are part of Oracle Utilities Business Intelligence make use of this field.

Table - Constraints

Select **Admin Menu > Table** and navigate to the **Constraints** tab to view the constraints defined on the table.

Description of Page

The fields on this page are protected as only the product development group may change them.

This page represents a collection of constraints defined for the table. A constraint is a field (or set of fields) that represents the unique identifier of a given record stored in the table or a field (or set of fields) that represents a given record's relationship to another record in the system.

Constraint ID is a unique identifier of the constraint.

Owner indicates if this is owned by the base package or by your implementation (**Customer Modification**)

Constraint Type Flag defines how the constraint is used in the system:

- **Primary Key** represents the field or set of fields that represent the unique identifier of a record stored in a table.
- **Logical Key** represents an alternate unique identifier of a record based on a different set of fields than the Primary key.
- **Foreign Key** represents a field or set of fields that specifies identifying and non-identifying relationships to other tables in the application. A foreign key constraint references the primary key constraint of another table.
- **Conditional Foreign Key** represents rare relationships between tables where a single field (or set of fields) may reference multiple primary key constraints of other tables within the application as a foreign key.

When **Enable Referential Integrity** is checked, the system validates the integrity of the constraint when a row in the table is modified.

Referring Constraint Owner indicates if this is owned by the base package or by your implementation (**Customer Modification**).

Referring Constraint ID is the **Primary Key** constraint of another table whose records are referenced by records stored in this table.

Referring Constraint Table displays the table on which the Referring Constraint ID is defined. You can use the adjacent go-to button to open the table.

Additional Conditional SQL Text is only specified when the constraint is a **Conditional Foreign Key**. The SQL represents the condition under which the foreign key represents a relationship to the referring constraint table.

Note: Additional Conditional SQL Syntax. When specifying additional conditional SQL text, all table names are prefixed with a pound (#) sign.

The Constraint Field grid at the bottom of the page is for maintaining the field or set of fields that make up this constraint.

Field is the name of the table's field that is a component of the constraint.

Sequence The rank of the field as a component of the constraint.

The Referring Constraint Field grid at the bottom of the page displays the field or set of fields that make up the **Primary key** constraint of the referring constraint.

Field is the name of the table's field that is a component of the referring constraint.

Sequence is the rank of the field as a component of the referring constraint.

Table - Referred by Constraints

Select **Admin Menu > Table** and navigate to the **Referred By Constraints** tab to view the constraints defined on other tables that reference the **Primary Key** constraint of this table.

Description of Page

This page is used to display the collection of constraints defined on other tables that reference the table.

Referred By Constraint Id is the unique identifier of the constraint defined on another table.

Referred By Constraint Owner indicates if this constraint is owned by the base package or by your implementation (**Customer Modification**).

Prime Key Constraint Id is the **Primary Key** constraint of the current table.

Prime Key Owner indicates if this prime key is owned by the base package or by your implementation (**Customer Modification**).

Referred By Constraint Table is the table on which Referred By Constraint Ids is defined.

When **Enable Referential Integrity** is checked, the system validates the integrity of the constraint when a row in the table is modified.

The grid at the bottom of the page displays the **Field** and **Sequence** for the fields that make up the constraint defined on the other table.

Defining Field Options

The topics in this section describe the transaction that can be used to view information about a field and to change the name of a field on the various pages in the system.

Field - Main

Open this page using **Admin Menu > Field** .

Caution: If you change a field's label, the new label appears on ALL transactions on which the field exists.

Caution: A field's label can be overridden for a specific table. If this is the case and you change the field's name on this transaction, the change will have no effect when the field is displayed for that specific table. If you find this to be true, change the field's label on the respective table on which it was overridden. You do this using the [Table Maintenance](#) transaction.

Description of Page

Many fields on this page are protected as only the product development group may change them. The following describes fields you may change for records that are part of the base product. Fields containing information that may be of interest are also described.

Field Name uniquely identifies this field.

Caution: As described in [System Data Naming Convention](#) for most system data tables, the base product follows a specific naming convention. However, this is not true for the Field table. If you introduce new fields, you must prefix the field with **CM**. If you do not do this, there is a possibility that a future release of the application could introduce a new field with the name you allocated.

Owner indicates if this field is owned by the base package or by your implementation (**Customer Modification**). The system sets the owner to **Customer Modification** when you add a field.

This information is display-only.

Base Field

Data Type indicates if the field will hold **Character**, **Character Large Object**, **Date**, **DateTime**, **Number**, **Time**, **Varchar2** data, or **XML Type**.

Ext Data Type

Precision defines the length of the field. In the case of variable length fields, it is the maximum length possible.

Scale

Sign

Level 88 Cpybk

Description contains the label of the field. This is the label of the field that appears on the various pages on which the field is displayed. Note, the field's label can be overridden for a specific table (by specifying an Override Label on the [table / field](#) information).

Java Field Name

Override Label

Check **Work Field** if the field does not represent a database table column.

Help Text is used to provide field level embedded help to this field. If the field is displayed on a user interface that supports display of embedded help, this text may be displayed.

Use **Override Help Text** to override the existing embedded help text for this field.

Special Notes contains any notes or special information about the field.

Field - Tables Using Field

Select **Admin Menu > Field** and navigate to the **Tables Using Field** tab to view the tables that contain a field.

Description of Page

The grid on this page contains the **Tables** that reference the **Field**. You can use the adjacent go to button to open the [Table Maintenance](#) transaction.

Defining Maintenance Object Options

A maintenance object is a group of tables maintained together within the system.

Maintenance Object - Main

Select **Admin Menu > Maintenance Object** to view information about a maintenance object.

Description of Page

Most maintenance objects are provided with the base package. An implementation can introduce custom maintenance objects when needed. Most fields may not be changed if owned by the base package.

Enter a unique **Maintenance Object** name and **Description**. **Owner** indicates if this business object is owned by the base package or by your implementation (**Customer Modification**).

Caution: Important! If you introduce a new maintenance object, carefully consider its naming convention. Refer to [System Data Naming Convention](#) for more information.

Program Com ID is the name of the program used to call the maintenance object's page program for validating constraints when objects are archived, purged, or compared. Refer to [Archiving](#) and [ConfigLab](#) for more information.

Service Name is the name of the internal service associated with the maintenance object.

The grid displays the following for each table defined under the maintenance object:

Table	The name of a given table maintained as part of the maintenance object.
Table Role	The table's place in the maintenance object hierarchy. Only one Primary table may be specified within a maintenance object, but the maintenance object may contain many Child tables.
Parent Constraint ID	Specifies the constraint used to link the table to its parent table within the maintenance object table hierarchy.
Compare Method	Either Normal or Large Table ; specifies the comparison method used by the compare utility in the ConfigLab .
Owner	Indicates if this is owned by the base package or by your implementation (Customer Modification).

Click the **View XML** hyperlink to view the XML document associated with the maintenance object service in the [Service XML Viewer](#).

Maintenance Object - Options

Use this page to maintain a maintenance object's options. Open this page using **Admin Menu > Maintenance Object** and then navigate to the **Options** tab.

Description of Page

The optionsgrid allows you to configure the maintenance object to support extensible options. Select the **Option Type** drop-down to define its **Value**. **Detailed Description** may display additional information on the option type. Set the **Sequence** to **1** unless the option can have more than one value. **Owner** indicates if this is owned by the base package or by your implementation (**Customer Modification**).

You can add new option types. Your implementation may want to add additional maintenance option types. For example, your implementation may have plug-in driven logic that would benefit from a new option. To do that, add your new values to the customizable lookup field **MAINT_OBJ_OPT_FLG**.

Maintenance Object - Algorithms

Use this page to maintain a maintenance object's algorithms. Open this page using **Admin Menu > Maintenance Object** and then navigate to the **Algorithms** tab.

Description of Page

The **Algorithms** grid contains algorithms that control important functions for instances of this maintenance object. You must define the following for each algorithm:

- Specify the **System Event** with which the algorithm is associated (see the table that follows for a description of all possible events).
- Specify the **Sequence Number** and **Algorithm** for each system event. You can set the **Sequence Number** to 10 unless you have a **System Event** that has multiple **Algorithms**. In this case, you need to tell the system the **Sequence** in which they should execute.
- If the algorithm is implemented as a script, a link to the **Script** is provided. Refer to [Plug-in Scripts](#) for more information.
- **Owner** indicates if this is owned by the base package or by your implementation (**Customer Modification**).

The following table describes each **System Event**.

System Event	Optional / Required	Description
Audit	Optional	Algorithms of this type are called to notify of any changes to the maintenance object's set of tables. Click here to see the algorithm types available for this system event.
Determine BO	Optional	Algorithm of this type is used to determine the Business Object associated with an instance of the maintenance object. It is necessary to plug in such an algorithm on a Maintenance Object to enable the business object rules functionality. The system invokes a single algorithm of this type. If more than one algorithm is plugged-in the system invokes the one with the greatest sequence number.

Information	Optional	<p>Click here to see the algorithm types available for this system event.</p> <p>We use the term "Maintenance Object Information" to describe the basic information that appears throughout the system to describe an instance of the maintenance object. The data that appears in this information description is constructed using this algorithm.</p> <p>The system invokes a single algorithm of this type. If more than one algorithm is plugged-in the system invokes the one with the greatest sequence number.</p> <p>Click here to see the algorithm types available for this system event.</p>
Revision Control	Optional	<p>An algorithm of this type is used to enforce revision control rules when an object is added, changed or deleted. The maintenance object service calls the plug-in once before the object is processed and once more after applying all business object rules. This allows revision rules to take place in proper revision timings.</p> <p>Click here to see the algorithm types available for this system event.</p>
Transition	Optional	<p>The system calls algorithms of this type upon each successful state transition of a business object as well as when it is first created. These are typically used to record the transition on the maintenance object's log.</p> <p>Note that some base maintenance objects are already shipped with an automatic logging of state transitions. In this case you may use these algorithms to override the base logging functionality with your own.</p> <p>Click here to see the algorithm types available for this system event.</p>
Transition Error	Optional	<p>The system calls this type of algorithm when a state transition fails and the business object should be saved in its latest successful state. The algorithm is responsible for logging the transition error somewhere, typically on the maintenance object's log.</p> <p>Notice that in this case, the caller does NOT get an error back but rather the call ends successfully and the exception is recorded somewhere, as per the plug-in logic.</p> <p>The system invokes a single algorithm of this type. If more than one algorithm is plugged-in the system invokes the one with the greatest sequence number.</p> <p>Click here to see the algorithm types available for this system event.</p>

Note: You can inactivate algorithms on Maintenance Objects. Your implementation may want to inactivate one or more algorithms plugged into the base maintenance object. To do that, go to the options grid on Maintenance Object - Options and add a new option, setting the option type to **Inactive Algorithm** and setting the option value to the algorithm code.

Maintenance Object - Maintenance Object Tree

You can navigate to the **Maintenance Object Tree** to see an overview of the tables and table relationships associated with the maintenance objects.

Description of Page

This page is dedicated to a *tree* that shows the maintenance object's tables as well as *business objects*, if you have defined any. You can use this tree to both view high-level information about these objects and to transfer to the respective page in which an object is maintained.

Defining Database Process Options

The topics in this section describe the transaction that can be used to maintain database processes used to perform *Archive Engine* operations such as archive and purge and *ConfigLab* operations like compare.

Database Process - Main

Select **Admin Menu > DB Process** to set up database processes used with *ConfigLab* and *ConfigLab* and *Archive Engine*.

Caution: Important! There are many sample database processes provided in the demonstration database. For information on how to copy a database process from the demonstration database, refer to [How To Copy Samples From The Demonstration Database](#).

Use **DB Process** to specify the name of the database process.

Description and **Long Description** contain descriptions of the database process.

Use **Status** to specify if the database process is **Active** or **Inactive**.

Use **DB Process Type** to specify if the DB process is used for **Archive**, **Compare**, or **Purge**.

Use **Batch Control** to specify the batch control associated with the DB process.

The grid at the bottom shows all of the DB process instructions for the DB process. Note that each DB process instruction is linked to a maintenance object.

To the left of the Seq column information about the instruction is displayed as hypertext. Clicking on the hypertext brings you to the DB instruction. The following grid describes the text that may appear:

Text	When Text Appears
Rule(s) & Algorithm(s)	Displays when the instruction has at least one rule and at least one algorithm.
Rule(s)	Displays when the instruction has at least one rule and no algorithms.
Algorithm(s)	Displays when the instruction has at least one algorithm and no rules.
Instruction	Displays when the instruction has no rules or algorithms.

The following fields display for each instruction.

Seq	A unique identifier for the DB process instruction under the DB process.
Description	Enter a description of the DB process instruction.
Maintenance Object	Specify the maintenance object associated with the DB process instruction.
Role	Either Primary or Child . If Child is specified, specify parent process sequence and a linkage constraint referring to a table defined on the parent instruction's maintenance object.
Parent Seq	Specify the process sequence of the parent DB process instruction on which the DB process instruction is dependent.
Linkage Constraint ID	Specify how maintenance objects of the DB process instruction and its parent are linked. This is a constraint on a table defined under the DB process instruction's maintenance object. This constraint references a table defined under the maintenance object that belongs to the DB process instruction specified by parent process sequence.

Database Process - DB Process Tree

You can navigate to the **DB Process Tree** to see an overview of the database process, associated maintenance objects, and instruction algorithms.

Description of Page

This page is dedicated to a *tree* that shows the DB process instructions and instruction algorithms associated with the database process. You can use this tree to both view high-level information about these objects and to transfer to the respective page in which an object is maintained.

Defining Database Process Instruction Options

A DB process instruction represents a single maintenance object as part of a DB process.

Database Process Instruction - Main

Select **Admin Menu > DB Instruction** to define DB process instructions for a given DB process.

Description of Page

DB Process Instruction contains a concatenation of basic information about the DB Process instruction. This information only appears after the DB process instruction has been added to the database. The adjacent up and down arrows cause the DB process instruction immediately before or after this DB process instruction to be displayed.

DB Process specifies the name of the database process to which this DB process instruction belongs.

Click **View SQL** to display the resulting select statement used as the basis for building root objects or archive root objects when the DB process is executed.

Process Sequence is a unique identifier for the DB process instruction under the DB process.

Enter a **Description** of the DB process instruction.

Note: Skipping an Instruction. If you would like a DB process to skip a DB process instruction during a given batch run, you can temporarily add two forward slashes ("/") to the description of the DB process instruction. For example, imagine you have defined a Copy Account DB Process that includes instructions to copy credit and collection information. Perhaps you would like to copy a set of accounts, but you do not need the C&C information. Rather than creating another DB process that does not include these instructions, you could add "/" to the instructions you want to skip during this batch run.

Maintenance Object specifies the maintenance object associated with the DB process instruction.

Instruction Role identifies the DB process instruction as **Primary** or **Child**. If **Child** is specified, specify parent process sequence and a linkage constraint referring to a table defined on the parent instruction's maintenance object.

Parent Seq is the process sequence of the parent DB process instruction on which the DB process instruction is dependent.

Linkage Constraint ID specifies how maintenance objects of the DB process instruction and its parent are linked. This is a constraint on a table defined under the DB process instruction's maintenance object. This constraint references a table defined under the maintenance object that belongs to the DB process instruction specified by parent process sequence. The **Constraint Owner** indicates whether the constraint is **Base Product** or a **Customer Modification**.

The **Instruction Algorithms** grid shows the algorithms associated with the DB process instruction. These algorithms are used as criteria for root object exclusion when a DB process is executed, or they may execute special processing required to maintain normal system operation after the DB process has been executed.

- Specify the order in which DB process instructions algorithms are executed by entering a **Sequence** number.

- Specify the algorithm's **System Event** (see the following table for a description of all possible events).
- Specify an **Algorithm** used to perform operations associated with the DB process instruction.

The following table describes each **System Event**.

System Event	Description
Apply Changes Processing	Click here to see the algorithm types available for this system event.
Archive Copy Data	For information about this system event refer to Archiving Data to Flat Files . Click here to see the algorithm types available for this system event.
Archive Criteria	For information about this system event refer to Criteria Algorithms Exclude Records . Click here to see the algorithm types available for this system event.
Archive Processing	For information about this system event refer to Processing Algorithms Perform Extra Processing . Click here to see the algorithm types available for this system event.
Compare Criteria	For information about this system event refer to Criteria Algorithms Also Define Which Objects To Compare . Click here to see the algorithm types available for this system event.
Purge Criteria	For information about this system event refer to Criteria Algorithms Exclude Records . Click here to see the algorithm types available for this system event.
Purge Processing	For information about this system event refer to Processing Algorithms Perform Extra Processing . Click here to see the algorithm types available for this system event.
Sync Criteria	For information about this system event refer to Criteria Algorithms Also Define Which Objects To Compare . Click here to see the algorithm types available for this system event.
Sync Processing	Click here to see the algorithm types available for this system event.

The **Table Rules** grid shows the table rules associated with the DB process instruction. Similar to criteria algorithms specified above, table rules can exclude a subset of records from being processed when the DB process is executed.

Table	Specify the table within the maintenance object hierarchy. Generally, this is the Primary table of the maintenance object associated with a Primary DB process instruction. When selecting records from tables during a DB process, it is assumed that all child records within the hierarchy are selected. Specifying a table rule for a child table is unusual.
Override Condition	The condition specified is incorporated into the WHERE clause of the dynamic SQL used to create root objects. Note: Override Condition Syntax. When specifying an override condition, you must prefix all table names with a pound (#) sign. For example, if a DB process' purpose was to archive bills, and you wanted to exclude the bills for account 3728474536 from being archived, you would specify CI_BILL as the table in the table rule, and the override condition would be #CI_BILL.ACCT_ID <> '3728474536' . Note that you do not include the word "WHERE" in the override condition text. Note also that SQL syntax for Oracle and DB2 may differ, and that DB2 is stricter with regard to data type comparisons than Oracle. You may alias table names in table rules that make use of sub-queries, but avoid prefixing aliases with "CHD" or "PRT" as they may conflict with internal aliases. Caution: Use table rules sparingly. Since table rules are incorporated into the WHERE clause when selecting records during DB process execution, override conditions that are not based on indexes can cause inefficient data access.

Database Process Instruction - DB Process Instruction Tree

You can navigate to the **DB Process Instruction Tree** to see an overview of the database process instruction, associated maintenance objects, instruction algorithms for the current DB process instruction and recursive child DB process instructions.

Description of Page

This page is dedicated to a *tree* that shows the database process instruction, associated maintenance objects, instruction algorithms for the current DB process instruction and recursive child DB process instructions. You can use this tree to both view high-level information about these objects and to transfer to the respective page in which an object is maintained.

Defining Look Up Options

Some special fields have values that are defined by the base-package development group. For example:

- The navigation option usage field has potential values of **Favorites**, **Go To** and **Menu**. On the database, these values are represented by the values of **FAV**, **GOTO** and **MENU**, respectively.
- The access mode (used by application security) defines the actions that are available on various application services, for example **Add**, **Change**, **Delete**, **Complete** and **Cancel**. On the database, these values are represented by the values of **A**, **C**, **D**, **CO**, and **CA** respectively

We call these types of fields "lookup fields" (because we have to "look up" the descriptions on the "look up" table when they are displayed on a transaction).

The two examples described above represent the two different types of lookup fields.

- The first example (navigation option usage) is a lookup field where you cannot add, remove or change the valid values.
- The second example (access mode) is a lookup field where you are allowed to add valid values.

We differentiate between these two types of lookups because the first type of lookup field (e.g., navigation usage option) controls logic in the system and if you change the valid values, the system will not work and if you add valid values, they will not be used by any system logic. For the second type of lookup field (e.g., access mode), your implementation may define additional values to be used by your customer modifications.

Caution: Important! If you introduce new lookup values, you must prefix the lookup value code with **X** or **Y**. If you do not do this, there is a possibility that a future release of the application could introduce a new lookup value with the name you allocated.

Lookup - Main

Select **Admin Menu > Look Up** to maintain lookup values.

Description of Page

Field Name is the name of the field whose lookup values are maintained in the grid. If you need to add a new lookup field, you must first add a *Field* with an extended data type of **Flag**.

Owner indicates if this lookup field is owned by the base package or by your implementation (**Customer Modification**). This information is display-only.

Custom switch is used to indicate whether you are allowed to add valid values for a lookup field whose owner is not **Customer Modification**.

- If this switch is turned on, you may add new values to the grid for system owned lookup fields.
- If this switch is turned off, you may not add, remove or change any of the values for system owned lookup fields, with the exception of the override description.

This field is always protected for system owned lookup fields because you may not change a field from customizable to non-customizable (or vice versa).

Java Field Name indicates the name of the field as it is referenced in Java code.

The grid contains the look up values for a specific field. The following fields may be modified:

Field Value is the unique identifier of the lookup value. If you add a new value, it must begin with an **X** or **Y** (in order to allow future upgrades to differentiate between your implementation-specific values and base-package values).

Description is the name of the lookup value that appears on the various transactions in the system

Java Value Name indicates the unique identifier of the lookup value as it is referenced in Java code.

Status indicates if the value is **Active** or **Inactive**. The system does not allow **Inactive** values to be used (the reason we allow **Inactive** values is to support historical data that references a value that is no longer valid).

Detailed Description is the detailed description for a lookup value, which is provided in certain cases.

Override Description is provided if your implementation wishes to override the description of the value provided by the product.

Note: If you wish the override descriptions of your lookup values to appear in the application viewer, you must *regenerate* the data dictionary application viewer background process.

Owner indicates if this lookup value is owned by the base package or by your implementation (**Customer Modification**). The system sets the owner to **Customer Modification** when you add lookup values to a field. This information is display-only.

Defining Extendable Lookups

The "lookup" table is a single table that holds valid values for many columns on many tables. Standard lookups are used when the element's valid values are limited to a predefined list. These work well when:

- The size of the valid values is 4 characters or shorter.
- The valid values are a simple code / description pair.

However, there can be situations when the valid values exceed 4 digits. For example, when the value is interfaced to another system and this system uses longer values (and you don't want to do a transformation in the interface).

There are also situations when more than just a description is needed for each valid value. For example, what if the value has both a description and a list containing different options based on existing conditions, such as the type of To Do to create based on an activity's service class?

In these situations, extendable lookups can be used to store these types of values. You use the Extendable Lookup portal to create and maintain extendable lookups.

Extendable Lookup - Main

Open this page using **Admin > Extendable Lookup** .

Description of Page

In the Extendable Lookup Search zone you can search for lookup values by either Business Object or Description. Click **Refresh** to view the search results.

In the search results, select the **Description** link to go to the Extendable Lookup Value List zone for that record. In the Extendable Lookup Value List zone the following actions are available:

- Click **Add** in the zone's title bar to add a new extendable lookup value.
- Click **Go To Search** in the zone's title bar to go back to the Extendable Lookup Search zone.
- Click the Broadcast icon to view the details for the extendable lookup value.
- Click **Edit** to edit the details for the extendable lookup value.
- Click **Delete** to delete the extendable lookup value.

The Big Picture Of Audit Trails

The topics in this section describe auditing, enabling auditing for fields, and auditing queries that you can use to view audit records.

Captured Information

When auditing is enabled for a field, the following information is recorded when the field is changed, added and/or deleted (depending on the actions that you are auditing for that field):

- User ID
- Date and time
- Table name
- Row's prime key value
- Field name
- Before image (blank when a row is added)
- After image (blank when a row is deleted)
- Row action (add, change, delete)

How Auditing Works

You enable auditing on a table in the table's meta-data by specifying the name of the table in which to insert the audit information (the audit table) and the name of the program responsible for inserting the data (the audit trail insert program). Then you define the fields you want to audit by turning on each field's audit switch in the table's field meta-data. You can audit fields for delete, insert and update actions.

Once auditing is enabled for fields in a table, the respective row maintenance program for the table assembles the list of changed fields and calls the audit trail insert program (**CIPZADTA** is supplied with the base package). If any of the changed fields are marked for audit, **CIPZADTA** inserts audit rows into the audit table (**CI_AUDIT** is the audit table supplied with the base package).

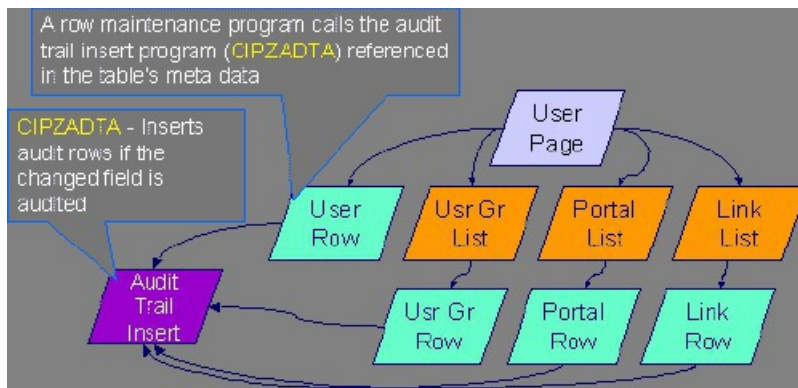

Note: Customizing Audit Information. You may want to maintain audit information other than what is described in *Captured Information* or you may want to maintain it in a different format. For example, you may want to maintain audit information for an entire row instead of a field. If so, your implementation team can use CIPZADTA and *CI_AUDIT* as examples when creating your own audit trail insert program and audit table structures.

The Audit Trail File

Audit log records are inserted in the audit tables you define. The base product contains a single such table (called *CI_AUDIT*). However, the audit insert program (CIPZADTA) is designed to allow you to use multiple audit tables.

If you want to segregate audit information into multiple tables, you must create these tables. Use the following guidelines when creating new audit tables (that use the CIPZADTA audit insert program):

- The new audit tables must look identical to the base table (*CI_AUDIT*).
- The new tables must be prefixed with CM (e.g., CM_AUDIT_A, CM_AUDIT_B, etc.).
- The name of the new table must be referenced on the various tables whose changes should be logged in the new table.

Note: Interesting fact. It's important to note if you use your own tables (as opposed to using the base package table called *CI_AUDIT*), the SQL used to insert and access audit trail records (in CIPZADTA) is dynamic. Otherwise, if the base package's table is used, the SQL is static.

How To Enable Auditing

Enabling audits is a two-step process:

- First, you must turn on auditing for a table by specifying an audit table and an audit trail insert program.
- Second, you must specify the fields and actions to be audited for the table.

The following topics describe this process.

Turn On Auditing For a Table

In order to tell the system which fields to audit, you must know the name of the table on which the field is located. You must specify the audit table and the audit trail insert program for a table in the table's meta-data.

Note: Most of the system's table names are fairly intuitive. For example, the user table is called *SC_USER*, the navigation option table is called *CI_NAV_OPT*, etc. If you cannot find the table using the search facility on the *Table*

[Maintenance](#) page, try using the [Data Dictionary](#). If you still cannot find the name of the table, please contact customer support.

To enable auditing for a table:

- Navigate to the [Table maintenance](#) page and find the table associated with the field(s) for which you want to capture audit information.
- Specify the name of the **Audit Table**.

Note: Specifying the Audit Table. You can use the audit table that comes supplied with the base package (**CI_AUDIT**) to audit multiple tables and fields. All the audit logs are combined in a single table (**CI_AUDIT**). However, you can also have a separate audit table for each audited table. Refer to [The Audit Trail File](#) for more information.

- Specify the name of the **Audit Program** (**CIPZADTA** is the default audit program supplied with the base package).

Caution: By default, none of a table's fields are marked for audit. Even though you have enabled auditing for a table, you must still specify the fields and actions on those fields to be audited (see below).

Specify The Fields and Actions To Be Audited

The system only audits actions (insert, update and delete) made to fields that you want audited.

To specify the fields and actions to be audited:

- Navigate to the [Table - Table Field maintenance](#) page for a table on which you have enabled auditing.
- For each field you want to audit, specify the actions you want to audit by turning on the **Audit Delete**, **Audit Insert** and **Audit Update** switches as appropriate.

Note: Note. You can also turn on the audit switches using the Field grid at the bottom of the [Table maintenance page](#).

Caution: Audit Program Caching! The audit program from the table meta-data is read into a program cache on the application server whenever the date changes or when the server starts. If you implement new auditing on a table, your audit trail does not become effective until this program cache is reloaded. In other words, new audits on tables where the audit program was not previously specified do not become effective until the next day (or the next restart of the application server). However, if you change the fields to be audited for a table where the audit program is already in the cache, your changes are effective immediately.

Audit Queries

There are two queries that can be used to access the audit information.

Audit Query by User

This transaction is used to view changes made by a user that are stored on a given [Audit Trail File](#).

Caution: The system only audits changes that you've told it to audit. Refer to [The Big Picture Of Audit Trails](#) for more information.

Navigate to this page by selecting **Admin Menu > Audit Query By User**.

Description of Page

To use this transaction:

- Enter the **User ID** of the user whose changes you wish to view.

- Enter the name of the table on which the audit trail information is stored in **Audit Table**. Refer to [The Audit Trail File](#) for more information about this field.

Note: Default Note. If only one audit table is used to store audit trail information, that table is defaulted.

- Specify a date and time range in **Created between** to restrict the records that result from the query.

Note: Default Note. The current date is defaulted.

- Click the search button to display all changes recorded on a specific audit table associated with a given user.

Information on this query is initially displayed in reverse chronological order.

The following information is displayed in the grid:

- **Row Creation Date** is the date and time that the change was made.
- **Audited Table Name** contains the name of the table whose contents were changed.
- **Primary Key** is the prime key of the row in the **Audited Table** whose contents were changed.
- **Audited Field Name** is the name of the field that was changed.
- **Audit Action** indicates whether the row action was **Add**, **Change** or **Delete**.
- **Field Value Before Update** contains the content of the field before the change. This column is blank if information was **Added**.
- **Field Value After Update** contains the content of the field after the change. This column is blank if information was **Deleted**.

Audit Query by Table / Field / Key

This transaction is used to view audited changes made to a given table.

Caution: The system only audits changes that you've told it to audit. Refer to [The Big Picture Of Audit Trails](#) for more information.

Note: Most of the system's table names are fairly intuitive. For example, the user table is called *SC_USER*, the navigation option table is called *CI_NAV_OPT*, etc. If you cannot find the table using the search facility on the [Table Maintenance](#) page, try using the [Data Dictionary](#). If you still cannot find the name of the table, please contact customer support.

This transaction can be used in several different ways:

- You can view all audited changes to a table. To do this, enter the **Audited Table Name** and leave the other input fields blank.
- You can view all audited changes to a given row in a table (e.g., all changes made to a given user). To do this, enter the **Audited Table Name** and row's prime key (the row's prime key is entered in the field(s) beneath **Audited Field Name**).
- You can view all audited changes to a given field in a table (e.g., all changes made to all customers' rates). To do this, enter the **Audited Table Name** and the **Audited Field Name**.
- You can view all audited changes to a given field on a specific row. To do this, enter the **Audited Table Name**, the **Audited Field Name**, and row's prime key (the row's prime key is entered in the field(s) beneath **Audited Field Name**).

Navigate to this page by selecting **Admin Menu > Audit Query By Table/Field/Key**

Description of Page

To use this transaction:

- Enter the name of the table whose changes you wish to view in **Audited Table Name**.

- If you wish to restrict the audit trail to changes made to a specific field, enter the **Audited Field Name**.
- If you wish to restrict the audit trail to changes made to a given row, enter the row's prime key (the row's prime key is entered in the field(s) beneath **Audited Field Name**). These fields are dynamic based on the **Audited Table Name**.
- Specify a date and time range in **Created between** to restrict the records that result from the query.

Note: The current date is defaulted.

- Click the search button to display all changes made to this data.

Information on this query is initially displayed in reverse chronological order by field.

The following information is displayed in the grid:

- **Create Date/Time** is the date / time that the change was made.
- **User Name** is the name of the person who changed the information.
- **Primary Key** is the prime key of the row in the **Audited Table** whose contents were changed.
- **Audited Field Name** is the name of the field that was changed.
- **Audit Action** indicates whether the row action was **Add**, **Change** or **Delete**.
- **Value Before Update** contains the content of the field before the change. This column is blank if information was **Added**.
- **Value After Update** contains the content of the field after the change. This column is blank if information was **Deleted**.

Bundling

The topics in this section describe the bundling features in the application.

About Bundling

Bundling is the process of grouping entities for export or import from one environment to another.

For example, you might export a set of business objects and service scripts from a development environment and import them into a QA environment for testing. The group of entities is referred to as a bundle. You create export bundles in the source environment; you create import bundles in the target environment.

Working with bundles involves the following tasks:

- Configuring entities for bundling if they are not preconfigured
- Creating an export bundle, which contains a list of entities to be exported from the source environment
- Creating an import bundle to import those entities to the target environment
- Applying the import bundle, which adds or updates the bundled entities to the target environment

Sequencing of Objects in a Bundle

Bundle entities are added or updated to the target environment in the sequence defined in the bundle

Typically, the sequence of entities does not matter. However, sequence is important in the following situations:

- Entities that are referenced as foreign keys should be at the top of the sequence, before the entities that reference them. Specify zones last, as they typically contain numerous foreign key references.

- When importing a business object, specify the business object first, then its plug-in scripts, then the algorithms that reference the scripts, and then the algorithm types that reference the algorithms.
- When importing a portal and its zones, specify the portal first and then its zones.
- When importing a multi-query zone, specify the referenced zones first and then the multi-query zone.
- Always specify algorithms types before algorithms.

You can specify the sequence when you define the export bundle or when you import the bundle to the target environment.

Recursive Key References

Recursive foreign keys result when one object has a foreign key reference to another object that in turn has a foreign key reference to the first object.

For example, a zone has foreign keys to its portals, which have foreign keys to their zones. If the objects you want to bundle have recursive relationships, you must create a 'bundling add' business object that has only the minimal number of elements needed to add the entity. A bundling add business object for a zone contains only the zone code and description, with no references to its portals. In the same way, a bundling add business object for a portal defines only its code and description.

When you apply the bundle, the system initially adds the maintenance object based on the elements defined in the bundling add business object. Before committing the bundle, the system updates the maintenance object with the complete set of elements based on its physical business object.

Owner Flags on Bundled Entities

The owner flag of the entities in an import bundle must match the owner flag of the target environment.

If you need to import objects that your source environment does not own, you must replace the owner flag in the import bundle with the owner flag of the target environment.

Configuring Maintenance Objects for Bundling

All base package meta-data objects are pre-configured to support bundling. All other objects must be manually configured.

If a base package maintenance object is pre-configured for bundling, the **Eligible For Bundling** option will be set to "Y" on the Options tab for the maintenance object.

To configure other objects for bundling, review the configuration tasks below and complete all those that apply:

Complete this configuration task...	for...
Make maintenance objects eligible for bundling	All objects to be included in the bundle
Add a foreign key reference	All objects to be included in the bundle
Create a physical business object	All objects to be included in the bundle
Create a bundling add business object	Objects with recursive foreign key references
Add the Current Bundle zone	All objects, if you want the Current Bundle zone to appear on the maintenance object's dashboard. This is not required by the bundling process.
Create a custom Entity Search zone and add it to the Bundle Export portal	All objects, if you want them to be searchable in the Bundle Export portal. This is not required by the bundling process.

Making Maintenance Objects Eligible for Bundling

The "Eligible For Bundling" maintenance object option must be set to "Y" for all bundled objects.

To make maintenance objects eligible for bundling:

1. Select **Admin Menu > Maintenance Object** and search for the maintenance object.
2. On the Options tab, add a new option with the type **Eligible For Bundling**.
3. Set the value to "Y" and click **Save**.

Adding a Foreign Key Reference

Each maintenance object in a bundle must have a foreign key reference. Bundling zones use the foreign key reference to display the standard information string for the maintenance object.

To add a foreign key reference to the maintenance object:

1. Select **Admin Menu > FK Reference+** and set up a foreign key reference for the primary table of the maintenance object.
2. Select **Admin Menu > Maintenance Object** and search for the maintenance object.
3. On the **Option** tab, add a new option with the type **Foreign Key Reference**. The value is the name of the foreign key reference you just created.

Creating a Physical Business Object

Each maintenance object in a bundle must have a physical business object. The physical business object's schema represents the complete physical structure of the maintenance object, and includes elements for all fields in the maintenance object's tables. The bundling process uses this schema to generate the XML for the import bundle.

To create a physical business object for the maintenance object:

1. Select **Admin Menu > Business Object +** and specify the maintenance object.
2. Click **Generate** in the **BO Schema** dashboard zone to generate a schema that looks like the physical structure of the maintenance object.
3. Save the physical business object.
4. Select **Admin Menu > Maintenance Object** and search for the maintenance object.
5. On the **Option** tab, add a new option with the type **Physical Business Object**. The value is the name of the physical business you just created.

Creating a Bundling Add Business Object

If the objects to be bundled have recursive foreign key references, you must create a bundling add business object to avoid problems with referential integrity.

To create a bundling add business object:

1. Select **Admin Menu > Business Object +** and specify the maintenance object.

2. Click **Generate** in the **BO Schema** dashboard zone to generate a schema that looks like the physical structure of the maintenance object.
3. Remove all elements that are not essential. Typically, only a code and description are required.
4. Save the physical business object.
5. Select **Admin Menu > Maintenance Object** and search for the maintenance object you want to bundle.
6. On the **Option** tab, add a new option with the type **Bundling Add BO**. The value is the name of the bundling add business object you just created.

Adding the Current Bundle Zone

If you want the Current Bundle zone to appear on the maintenance object's dashboard, you must add the Current Bundle zone as a context-sensitive zone for the maintenance object.

To add the Current Bundle zone to the maintenance object:

1. Select **Admin Menu > Context Sensitive Zone** and search for the navigation key for the maintenance object.
2. Add the Current Bundle zone, F1-BNDLCTXT, to that navigation key.

Adding a Customized Entity Search Query Zone to the Bundle Export Portal

If you want the maintenance object to be searchable in the Bundle Export portal, you must first create an entity-specific query zone to search for the maintenance object. Then you must create a customized entity search zone that references this new query zone. Finally, you must add the customized entity search zone to the Bundle Export portal.

To make the maintenance object searchable:

1. Create an entity-specific query zone to search for the maintenance object:
 - a) Select **Admin Menu > Zone** and search for one of the base query zones, such as the Algorithm Search zone, F1-BNALGS.
 - b) Click the **Duplicate** button in the action bar.
 - c) Enter a name for the new zone.
 - d) Click **Save**.
 - e) Locate the **User Filter** parameter in the parameter list. Add SQL to search for the maintenance object(s) you want to appear in the zone.
 - f) Save the query zone.
2. Create a customized entity search zone:

This step only needs to be done once. If you already have a customized search zone in the Bundle Export portal go to step 3

 - a) Select **Admin Menu > Zone** and search for the F1-BNDLENTQ Entity Search zone.
 - b) Duplicate this zone (as described above).
 - c) Remove any references to base query zones.
3. Add the new entity-specific query zone to the customized entity search zone:
 - a) Locate the customized entity search zone for your Bundle Export portal. This is the zone created in Step 2.
 - b) Locate the Query Zone parameter in the parameter list. Add the name of the query zone you created in Step 1.

- c) Save the entity search zone.
4. Add the customized entity search zone to the Bundle Export portal:

This step needs to be done only once.

 - a) Select **Admin Menu > Portal** and search for the Bundle Export portal, F1BNDLEM.
 - b) In the zone list, add the entity search zone you created in Step 2. (Add the new zone after the base entity search zone).
 - c) Save the portal.

Working with Bundles

Use the Bundle Export portal to create an export bundle. The export bundle contains a list of entities to be exported from the source environment. When you are ready to import the objects, use the Bundle Import portal to import the objects to the target environment.

Creating Export Bundles

An export bundle contains a list of entities that can be imported into another environment.

To create an export bundle:

1. Log on to the source environment from which objects will be exported.
2. Select **Admin Menu > Bundle Export+** .
3. Complete the fields in the Main section to define the bundle's basic properties.

Note: You can use the Entities section to add bundle entities now, or save the bundle and then add entities as described in step 5.
4. Click **Save** to exit the Edit dialog. The export bundle status is set to Pending.
5. While an export bundle is in Pending state, use any of the following methods to add entities to the bundle:
 - a) Use the **Entity Search** zone on the Bundle Export portal to search for entities and add them to the bundle. If an entity is already in the bundle, you can remove it.
 - b) To import entities from a .CSV file, click **Edit** on the Bundle Export portal, and then click **CSV File to Upload**. Specify the file name and location of the .CSV file containing the list of entities. Click **Submit** to upload the file, and then click **Save** to save the changes.
 - c) Use the **Current Bundle** zone in the dashboard of the entity you want to add. (All entities that are configured to support bundling display a Current Bundle zone). This zone displays a list of all pending export bundles to which you can add the entity.
 - d) When you check an entity into revision control, specify the export bundle on the **Revision Info** dialog.
6. When you have added all entities, click **Bundle** in the Bundle Actions zone on the Bundle Export portal. The export bundle state is set to Bundled and the Bundle Details zone displays the XML representation of every entity in the bundle.

Note: The owner flags of the entities in the bundle must match the owner flag of the bundle itself. If the owner flags do not match, the system displays a warning message. Click **OK** to continue or **Cancel** to abort the bundle. If you click OK, you will need to resolve the owner flag discrepancy before you import the bundle to the target environment.

7. Copy the XML from the **Bundle Detail** zone to the clipboard (or to a text file). You can now create an import bundle and apply it to the target environment.

Note: If you need to make additional changes to the bundle, you must change the bundle state by selecting the **Back to Pending** button in the **Bundle Actions** zone.

Creating and Applying Import Bundles

Import bundles define a group of entities to be added or updated in the target environment.

Before you create an import bundle, you must have already created an export bundle, added entities, and set the bundle's state to **Bundled**.

To create an import bundle and apply it to the target environment:

1. If you have not already copied the XML from the export bundle, do so now:
 - a) Select **Admin Menu > Bundle Export** and search for the bundle.
 - a) Copy the XML from the **Bundle Detail** zone to the clipboard (or to a text file).
2. Log on to the target environment.
3. Select **Admin Menu > Bundle Import+**.
4. In the **Bundle Actions** zone, click **Edit XML**.
5. Paste the contents of the clipboard (or text file if you created one) into the **Bundle Detail** zone.
6. Make any necessary changes to the XML and click **Save**. The status of the import bundle is set to **Pending**.

Note: Use caution when editing the XML to avoid validation errors.

7. To remove entities from the import bundle or change their sequence, click **Edit**. Enter your changes and click **Save** to exit the Edit dialog.
8. When you are ready to apply the bundle, click **Apply**. The import bundle state is set to **Applied** and the entities are added or updated in the target environment.

Editing Export Bundles

You can add or remove entities from an export bundle when it is in **Pending** state. You can also change the sequence of entities.

To edit to an export bundle that has already been bundled, you must change the bundle state by selecting the **Back to Pending** button on the **Bundle Export** portal.

To edit a pending export bundle:

1. Open the bundle in edit mode.
2. Click **Edit** on the **Export Bundle** portal.
3. Make any necessary changes on the edit dialog and then click **Save**.

Editing Import Bundles

You can remove entities from an import when it is in **Pending** state. You can also change the sequence of entities and edit the generated XML.

To edit a pending import bundle:

1. Open the bundle in edit mode.
2. To edit the XML snapshot, click **Edit XML**. Edit the XML code as needed, then click **Save**.

Note: Use caution when editing the XML to avoid validation errors.

3. To remove entities or change their sequence, click **Edit**. Make any necessary changes and click **Save**.

Revision Control

The topics in this section describe the revision control features in the application.

About Revision Control

Revision control creates a history of a maintenance object as users make changes to it.

If revision control is enabled for an object you must check out the object to change it. While the object is checked out no one else can work on it. You can revert all changes made since checking out an object, reinstate an older version of an object, recover a deleted object, and force a check in of an object if someone else has it checked out.

Note: Revision control does not keep your work separate from the environment. Because the metadata for maintenance objects is in the central database, any changes you make to an object while it is checked out will be visible to others and may impact their work.

Many of the maintenance objects used as configuration tools are already configured for revision control, but it is turned off by default. For example, business objects, algorithms, data areas, UI maps, and scripts are pre-configured for revision control.

Turning On Revision Control

Revision control is turned off by default for maintenance objects that are configured for revision control.

To turn on revision control:

1. Add the base package **Checked Out** zone to the Dashboard portal.
 - a) Select **Admin Menu > Portal**.
 - b) Search for the portal **CI_DASHBOARD**.
 - c) In the zone list for the **Dashboard** portal, add the zone **F1-USRCHKOUT**.

2. Set up application security.

For users to have access to revision control, they must belong to a user group that has access to the application service **F1-OBJREVBOAS**.

3. Add the revision control algorithm to the maintenance object that you want to have revision control.

This step must be repeated for each maintenance object that you want to have revision control.

- a) Select **Admin Menu > Maintenance Object** and search for the maintenance object that you want to have revision control.
- b) On the **Algorithms** tab of the maintenance object, add the revision control algorithm **F1-REVCTL**.

Configuring Maintenance Objects for Revision Control

Most configuration tool maintenance objects are pre-configured for revision control. You can configure other maintenance objects for revision control, as well.

To configure other objects for revision control:

1. Create a physical business object for the maintenance object.

A physical business object is one that has a schema with elements for all of the fields for the tables in the maintenance object. Follow these steps to create a physical business object:

- a) Select **Admin Menu > Business Object +** and specify the maintenance object.
- b) Use the **BO Schema** dashboard zone to generate a schema that looks like the physical structure of the maintenance object.
- c) Save the physical business object.
- d) Select **Admin Menu > Maintenance Object** and search for the maintenance object for which you want to enable revision control.
- e) On the **Options** tab of the maintenance object add a new option with the type **Physical Business Object**. The value is the name of the physical business object that you just created.

2. Add a foreign key reference to the maintenance object.

The revision control zones will display the standard information string for the object based on the foreign key reference. Follow these steps to create a foreign key reference:

- a) Select **Admin Menu > FK Reference+** and set up a foreign key reference for the primary table of the maintenance object.
- b) Select **Admin Menu > Maintenance Object** and search for the maintenance object.
- c) On the **Options** tab of the maintenance object, add a new option with the type **Foreign Key Reference**. The value is the name of the foreign key reference that you just created.

3. Add the **Revision Control** zone to the maintenance object.

- a) Select **Admin Menu > Context Sensitive Zone** and search for the navigation key for the maintenance object.
- b) Add the Revision Control zone, F1-OBJREVCTL, to that navigation key.

4. Add the revision control algorithm to the maintenance object.

- a) Select **Admin Menu > Maintenance Object** and search for the maintenance object that you want to have revision control.
- b) On the **Algorithms** tab of the maintenance object, add the revision control algorithm F1-REVCTL.

Working with Revision Control

You use two zones in the dashboard to work with revision controlled objects when revision control is turned on .

The **Revision Control** zone gives you several options for managing the revision of the currently displayed object. This zone also shows when the object was last revised and by whom. This information is linked to the **Revision History** portal which lists all of the versions of the object.

Using the Revision Control zone you can:

- Check out an object in order to change it.

- Check in an object so others will be able to work on it.
- Revert the object back to where it was at the last checkout.
- Force a check in of an object that is checked out by someone else. You need special access rights to force a check in.
- Delete an object.

The **Checked Out** zone lists all of the objects that you currently have checked out. Clicking on an object listed in this zone will take you to the page for that object. The zone is collapsed if you have no objects checked out.

Checking Out an Object

You must check out a revision controlled object in order to change it.

An object must have revision control turned on before you can check it out.

Note: When you first create or update an object a dialog box informs you that the object is under revision control. You can select **OK** to check out the object and save your changes, or **Cancel** to stop the update.

1. Go to the object that you want to work on.
2. Select **Check Out** in the **Revision Control** dashboard zone.

Checking In an Object

You must check in a revision controlled object in order to create a new version of it. Checking in an object also allows others to check it out.

1. Select a link in the **Checked Out** dashboard zone to go to the object that you want to check in.
2. Select **Check In** in the **Revision Control** dashboard zone.
3. Provide details about the version:
 - In the **External References** field state the bug number, enhancement number, or a reason for the revision.
 - In the **Detailed Description** field provide additional details regarding the revision.
 - In the **Keep Checked Out** box specify if you want to keep the object checked out. If you keep the object checked out then your revision is a new version that you can restore later.
 - In the **Add To Bundle** box specify if the object belongs to a bundle.
4. Select **OK** to check in the object.

Reverting Changes

Reverting changes will undo any changes you made since you checked out an object.

To revert changes:

1. Go to the object that you want to revert.
2. Select **Revert** in the **Revision Control** dashboard zone.
3. In the confirmation dialog box select **OK** to confirm the action or **Cancel** to return to the object page.

Once reverted, the object can be checked out by another user.

Forcing a Check In or Restore

You can force a check in if an object is checked out by another user and that person is not available to check it in.

You must have proper access rights to force a check in or restore.

To force a check in or restore:

1. Go to the object that is checked out by another user.
2. Select **Force Check In** or **Force Restore** in the Revision Control zone.

The **Force Check In** option is the same as a regular check in. The **Force Restore** option checks in the object and restores it to the previously checked in version.

Deleting an Object

If revision control is turned on for an object, you must use the **Revision Control** zone to delete it.

The object must be checked in before it can be deleted.

To delete a revision controlled object:

1. Go to the object that you want to delete.
2. Select **Delete** in the **Revision Control** zone.
3. Provide details regarding the deletion.
4. Select **OK** to delete the object.

The system creates a revision record before the object is deleted so that the deleted object can be restored.

Restoring an Object

You can restore an older version of either a current object or a deleted object.

An object must be checked in before an older version can be restored.

To restore an object:

1. Go to the **Revision History** portal for the object.
If the object was deleted you must search for it by going to **Admin Menu > Revision History Search** .
2. Locate the row in the version history that has the version that you want to restore and click **Restore**.
3. In the confirmation dialog box select **OK** to confirm the action or **Cancel** to return to the object page.

Working with Revision History

The **Revision History** portal lists information about each version of a revision controlled object.

You can navigate to the **Revision History** portal from either a link in the **Revision Control** dashboard zone or by going to the **Revision History Search** portal on the **Admin Menu**. If you want to find the Revision History for a deleted object, you must search for the object using the **Revision History Search** portal.

You can restore a previous version of the object by clicking **Restore** in the row for the version that you want to restore.

You can see the details of each version by clicking the broadcast icon for that version.

Searching for Revision History

You can use the **Revision History Search** portal to find the revision records for an object.

To search for a revision record:

1. Select **Admin Menu > Revision History Search** to access the search portal.
2. Provide search criteria in the **Revision History Search** zone and click **Refresh**. You can search by:
3. In the list of search results, select the link in the **Details** column to go to the Revision History for that object.

Chapter 6

To Do Lists

Certain events that occur within the system will trigger messages describing work that requires attention. For example, if a bill segment has an error, the system generates a To Do message to alert the person responsible for correcting such errors.

Each type of message represents a To Do list. For example, there are To Do lists for bill segment errors, payment errors, accounts without bill cycles, etc.

We refer to each message as a **To Do Entry**. Each To Do entry is assigned a specific **To Do Role**. The role defines the users who may work on the entry. A To Do entry has a **To Do log** that maintains record of the progress on the To Do entry. For example, the To Do log indicates when the To Do entry was created, when it was assigned to a user and to whom it was assigned, and when and by whom it was completed.

Fastpath: Refer to [To Do Processing](#) for a description of end-user queries and tools assisting in reviewing, assigning and processing To Do entries.

The Big Picture of To Do Lists

The topics below provide more information about To Do configuration.

To Do Entries Reference A To Do Type

Every [To Do entry](#) references a To Do type. The To Do type controls the following functions:

- The To Do list on which the entry appears.
- The page into which a user is taken when they drill down on an entry.
- The message that appears in the user's To Do list. Note this message can be overridden for specific To Do messages by specifying a different message number in the process that creates the specific To Do entry. For example, the process that creates To Do entries associated with bill segments that are in error displays the error message rather than a generic "bill segment is in error" message.

- The To Do list's sort options. Sort options may be used on the To Do list page to sort the entries in a different order. For example, when a user looks at the bill segment error To Do list, they have the option of sorting it in error number order, account name order, or in customer class order. Note the default sort order is also defined on To Do type.
- Whether (and how) the To Do entry is downloaded to an external system (e.g., an email system).
- The roles to which an entry may be reassigned.
- The default priority of the To Do list in respect of other To Do lists.
- The To Do list's usage, which indicates whether a To Do of that type may be created manually by a user.
- The algorithms used to perform To Do list specific business rules.
- The characteristics applicable to the To Do list.

To Do Entries Reference A Role

Every *To Do entry* references a role. The role defines the users who may be assigned to **Open** entries.

The permissible roles that may be assigned to a To Do entry are defined on the entry's To Do type. After an entry is created, its role may be changed to any role defined as valid for the entry's To Do type.

An entry's initial role is assigned by the background process or algorithm that creates the entry. Because you can create your own processes and algorithms, there are an infinite number of ways to default an entry's role. However, the base package processes and algorithms use the following mechanisms to default an entry's role:

- The system checks if an entry's message category / number is suppressed (i.e., not created). If so, the entry is not created. Refer to *To Do Entries Can Be Rerouted Or Suppressed Based On Message Number* for more information.
- The system checks if an entry's message category / number is rerouted to a specific role. If so, it defaults this role. Refer to *To Do Entries Can Be Rerouted Or Suppressed Based On Message Number* for more information.
- Your specific product may introduce additional criteria for assigning a role (see To Do Lists and To Do Roles in the product help index).
- If a role wasn't retrieved in the previous step AND if the entry is created via an algorithm that has Role as a parameter, this role is assigned to the entry. Note: role is frequently an optional parameter of algorithms.
- If the entry does not have a role after the above takes place, the entry's To Do type's default role is assigned to the entry.

Note:

The system provides a default role assigned to the system To Do types when first installed called **F1_DFLT**. This may be replaced with business oriented To Do roles once they are defined.

Caution: Important! Most organizations have the notion of a supervisor who is responsible for all entries assigned to a given role. It's important for this user (or users) to be part of all such roles. Refer to *To Do Supervisor Functions* for information about transactions that can be used by supervisors to review and assign work to users.

To Do Entries Can Be Rerouted (Or Suppressed) Based On Message Number

Consider the To Do type used to highlight bill segments that are in error. To Do entries of this type reference the specific bill segment error number so that the error message can be shown when the Bill Segments in Error To Do list is displayed.

Note: Message Category / Message Number. Every error in the system has a unique message category / number combination. Refer to [The Big Picture of System Messages](#) for more information about message categories and numbers.

If you want specific types of errors to be routed to specific users, you can indicate such on the To Do type. For example, if certain bill segment errors are always resolved by a given rate specialist, you can indicate such on the To Do type. You do this by updating the [To Do type's message overrides](#). On this page you specify the message category / number of the error and indicate the To Do role of the user(s) who should work on such errors. Once the To Do type is updated, all new To Do entries of this type that reference the message number are routed to the desired role.

Note: Reroute versus suppression. Rather than reroute an entry to a specific role, you can indicate that an entry with a given message number should be suppressed (i.e., not created). You might want to do this if you have a large volume of certain types of errors and you don't want these to clutter your users' To Do lists.

Obviously, you would only reroute those To Do types that handle many different types of messages. In other words, if the To Do type already references a specific message category / number rerouting is not applicable.

We do not supply documentation of every possible message that can be handled by a given To Do type. The best way to build each To Do type's reroute list is during the pre-production period when you're testing the system. During this period, compile a list of the messages that should be routed to specific roles and add them to the To Do type.

Keep in mind that if a message number / category is not referenced on a To Do type's reroute information, the entry is routed as described under [To Do Entries Reference A Role](#).

Note: Manually created To Do entries cannot be rerouted or suppressed. The rerouting occurs as part of the batch process or algorithm processing when the To Do is created. The role or user to whom a manual To Do should be assigned is specified when the To Do is created online. A manually created To Do may also be forwarded to another user or role.

The Priority Of A To Do Entry

Some To Do entries may be more urgent to resolve than others. A To Do entry is associated with a priority level representing its relative processing order compared to other entries.

Priority level is initially assigned as follows:

- If a **Calculate Priority** plug-in is defined on the To Do entry's type, the system calls it to determine the entry's priority. You may want to use this method if an entry's priority is based on context or time-based factors. For example, when priority takes into consideration account specific attributes. When applicable, you may design a process that triggers priority recalculation of To Do entries "at will". For example, when priority is reassessed periodically based on factors external to the To Do entry's information. Refer to [To Do Type](#) for more information on priority calculation algorithms.
- If a priority value has not been determined by a plug-in, the system defaults a To Do entry's initial priority to the value specified on its type.

A user may manually override a To Do entry's priority at any time. Notice that once a To Do entry's priority is overridden, **Calculate Priority** plug-ins are no longer called so as to not override the value explicitly set by the user.

Note: The system does not use priority values to control order of assignment nor processing of To Do entries. Priority is available to assist your organization with supporting a business practice that ensures higher priority issues are worked on first.

Working On A To Do Entry

A user can drill down on a To Do entry. When a user drills down on an entry, the user is transferred to the transaction associated with the entry. For example, if a user drills down on a bill segment error entry, the user is taken to the Bill Segment - Main page. Obviously, the page to which the user is taken differs depending on the type of entry.

It is also possible to configure the To Do type to launch a [script](#) when a user drills down on an entry rather than taking the user to a transaction. The script would walk the user through the steps required to resolve the To Do entry. Refer to [Launching Scripts When A To Do Is Selected](#) for more information.

After finishing work on an entry, the user can mark it as **Complete**. Completed entries do not appear on the To Do list queries (but they are retained on the database for audit purposes). If the user cannot resolve the problem, the user can forward the To Do to another user.

Launching Scripts When A To Do Is Selected

Users can complete many To Do entries without assistance. However, you can set up the system to launch a [script](#) when a user selects a To Do entry. For example, consider a To Do entry that highlights a bill that's in error due to an invalid mailing address. You can set up the system to execute a script when this To Do entry is selected by a user. This script might prompt the user to first correct the customer's default mailing address and then re-complete the bill.

A script is linked to a To Do type based on its message number using the [To Do type's message overrides](#). Refer to [Executing A Script When A To Do Is Selected](#) for more information.

To Do Entries Have Logs

Each [To Do entry](#) has a To Do log that maintains a record of the To Do's progress in the system. For example, the To Do log indicates when the To Do entry was created, when it was assigned to a user and to whom it was assigned, and when and by whom it was completed. Users can view the log to see who assigned them a particular To Do and whether any work has already been done on the To Do.

A log entry is created for all actions that can be taken on a To Do entry. Log entries are created for the following events:

- A To Do entry is created (either by the system or by a user)
- A To Do entry is completed (either by the system or by a user)
- A user takes an open To Do entry
- A supervisor assigns a To Do entry
- A user forwards an entry to another user or role
- A user sends back a To Do to the user who forwarded it
- A user manually adds a log entry to record details about the To Do's progress
- A user manually overrides the To Do entry's priority

Fastpath: For information about the contents of log entries for each of the events, refer to [Log Entry Events](#).

How Are To Do Entries Created?

A To Do Entry may be created in the following ways:

- A *background process* can create To Do Entries.
- An *algorithm* can create entries of a given type. Because the use of algorithms is entirely dependent on how you configure the control tables, the number of types of such entries is indeterminate.
- A user can create entries of To Do types that have a **Manual** usage. Refer to *To Do Entries Created Manually* for information about setting up manual To Do types.
- An *XAI service* may create an entry of a given type.

For any base product process (background process, algorithm, XAI service, etc) that includes logic to create a To Do entry, the system supplies a sample To Do type that may be used. Although the To Do types provided by the product are system data, the following information related to each To Do type may be customized for an implementation and is not overwritten during an upgrade:

- The creation process. If the To Do is created by a background process where the background process is referenced on a To Do type. Refer to *To Do Entries Created By Background Processes* for more information.
- The routing process. Refer to *To Do Entries May Be Routed Out of the System* for more information.
- The priority. Refer to *To Do Type - Main* for more information.
- The *roles* that may be associated with the To Do type. Refer to *To Do Entries Reference a Role* for more information.
- The *message override* information. Refer to *To Do Entries Can Be Rerouted (Or Suppressed)* and *Launching Scripts When a To Do Is Selected* for more information.

To Do Entries Created By Background Processes

There are different types of To Do entries created by background processes:

- To Do entries created by dedicated To Do background processes
- To Do entries created for object-specific errors detected in certain background processes
- To Do entries created based on a specific condition

Dedicated To Do Background Processes

There are To Do entries that are created by system background processes whose main purpose is to create To Do entries based on a given condition. For these background processes, the To Do Type indicates the creation background process.

Note: If you don't schedule the background process, the entries will NOT be created! The To Do entries of this type will only be created if you have scheduled the associated background process. Therefore, if you want the system to produce a given entry, schedule the background process.

To Dos Created for Object-Specific Error Conditions

A system background process may create a To Do entry when an error is detected during object-specific processing and it is not possible to create an exception record. (I.e., either no exception record exists for the process or the error is not related to the entity reported in the exception record.)

For these background processes, the To Do Type must reference the creation background process. To have the system create To Do entries for some or all of the errors generated by one of these processes, you must do the following:

- If you want the system to generate To Do entries for errors detected by one of the background processes below, go to the appropriate To Do type and populate the creation background process.
- If you want the system to generate To Do entries for some errors for the process, but not for all errors, populate the creation background process and then proceed to the *message overrides* tab to *suppress* certain messages. To this by

indicating the message category and message number you want to suppress. Any error that is suppressed is written to the *batch run tree*.

If you do not populate the creation background process, the errors are written to the *batch run tree*.

Note: Errors received while creating a To Do entry. If the background process cannot successfully create a To Do entry to report an object-specific error, the error is written to the batch run tree along with the error encountered while attempting to create the To Do entry.

Note: System errors are not included. To Do entries are not created for a system error, for example an error related to validation of input parameter. These errors are written to the *batch run tree*. Refer to *Processing Errors* for more information.

To Dos Created by Background Processes for Specific Conditions

There are some system background processes that create a To Do entry when the process detects a specific condition that a user should investigate. For each background process, the To Do type is an input parameter to the process. The system provides To Do types for each base package background process that may create a To Do entry.

Note: No Creation Process. These To Do types do not need (and should not have) a **Creation Process** specified.

To Do Entries Created By Algorithms

There are To Do entries that are created by algorithm types supplied with the base package. The system supplies a To Do Type for each of these To Do entries that you may use.

If you want to take advantage of these types of entries for system algorithm types, you must do the following:

- Create an *algorithm*:
 - This algorithm must reference the appropriate Algorithm Type.
 - These algorithms have a parameter of the To Do Type to be created. You should specify the To Do Type indicated in the table.
- Plug the algorithm into the respective control table.

To Do Entries Created Via an XAI Service

There are some XAI services supplied with the base package that create To Do entries. The system provides a To Do type for each base package XAI service that may create a To Do entry.

XAI services do not have parameters where a To Do type can be plugged in. As a result, each service must be designed to determine the To Do type appropriately. You may choose to use a feature configuration option to define the To Do type. Refer to the documentation for the base package services that create a To Do entry to determine how the To Do type is determined.

To Do Entries Created Manually

You must set up manual To Do entry types if you want your users to be able to create To Do entries online. Users may create a manual To Do entry as a reminder to themselves to complete a task. Online To Do entries may also be used like electronic help tickets in the system. For example, if a user is having a problem starting service, the user can create a To Do

that describes the problem. The To Do can be assigned to a help resolution group that could either resolve the problem or send the To Do back to the initiating user with information describing how to resolve the problem.

If you want to take advantage of manual To Do entries, create a To Do type and specify the following information.

On the Main tab:

- Set the **To Do Type Usage** flag to **Manual**.
- Set the **Navigation Option** to **ToDoEntryMaint** (To Do entry maintenance).
- Set the **Message Category** and **Message Number** to the message you want to be used for To Do entries of this type. A generic base message is provided (category 15, message 1000) that can be used for manual To Dos. If you use this message, the To Do's subject appears as the message for the To Do.

On the Roles tab:

- Specify the *To Do roles* that may be assigned to To Do entries of this type.
- Indicate the To Do role that should be defaulted when you create To Do entries of this type.

On the Sort Keys tab:

When a user adds a manual To Do entry, the system creates an entry with three sort key values. (Sort keys may be used on the To Do list page to sort the entries in a different order.) The To Do type should be set up to reference the sort keys as follows:

Sequence	Description
1	Created by user ID
2	Created by user name
3	Subject

We recommend that the keys have an **Ascending** sort order and that the Subject is made the default sort key.

On the Drill Keys tab:

When a user adds a manual To Do entry, it is created with a drill key value equal to the To Do entry's ID. When the user clicks the Go To button next to the message in the To Do list, the system uses the drill down application service (defined on the main tab) and the drill key to display the associated To Do entry.

The To Do type should be set up with a drill key that reference the To Do entry table and the To Do entry ID:

Sequence	Table	Field
1	CI_TD_ENTRY	TD_ENTRY_ID

The Lifecycle Of A To Do Entry

The following state transition diagram will be useful in understanding the lifecycle of a To Do entry.

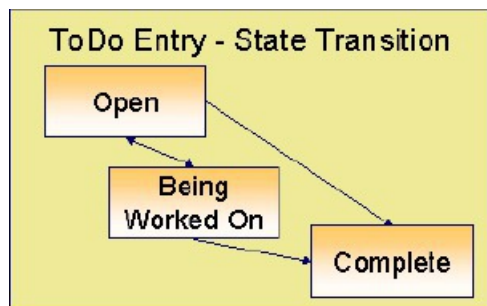

A To Do entry is typically created in the **Open** state. Entries of this type can be viewed by all users belonging to the entry's role. Refer to [How Are To Do Entries Created?](#) for information about how entries are created.

An **Open** entry becomes **Being Worked On** when it is assigned to a specific user or when a user proactively assumes responsibility for the entry. While an entry is **Being Worked On**, it is visible on the To Do Summary page only by the user who is assigned to it.

Note: To Do entries may be created in the **Being Worked On** state. Some To Do background processes may create To Do entries in the **Being Worked On** state. When a user adds a To Do entry online and assigns the To Do to a user (as opposed to a role), the To Do entry is also created in the **Being Worked On** state.

A **Being Worked On** entry may be forwarded to a different user or role. If the entry is forwarded to a role, it becomes **Open** again.

When an entry becomes **Complete**, it is no longer visible in the To Do list queries (but it remains on the database for audit purposes). There are two ways an entry can become **Complete**:

- A user can manually indicate it is **Complete** (there are several ways to do this).
- For To Do entries that are logically associated with the state of some object, the system automatically marks the entry **Complete** when the object is no longer in the respective state. For example, an entry that's created when an account doesn't have a bill cycle is completed when the account has a bill cycle.

Caution: Important! The automatic completion of To Do entries occurs when the background process responsible for creating entries of a given type is executed. Therefore, if you only run these processes once per day, these entries remain **Being Worked On** even if the object is no longer in the respective state.

Linking Additional Information To A To Do Entry

Additional information may be linked to a To Do entry using characteristics. For example, when creating a manual To Do entry, a user may define the account related to the To Do.

When creating an automatic To Do entry, the program that generates the To Do may link related data to the To Do using characteristics. Use system *algorithm* to link related entities. For manually created To Dos, the valid characteristic types that may be linked to the To Do entry must be defined on the *To Do type* for that To Do entry.

If your To Do entries reference characteristics that are related to your global context data, you may want to configure an *Alerts* on page 129 to display an alert if a related entry is **Open** or **Being Worked On**.

Implementing Additional To Do Entry Business Rules

If your business practice calls for additional validation rules or processing steps to take place after a To Do Entry is created or updated, you may want to take advantage of the **To Do Post Processing** plug-ins defined on *To Do type*.

For example, you may want to validate that To Do entries are only assigned to users with the proper skill levels needed to resolve them. Refer to *F1-VAL-SKILL* for a sample algorithm handling such validation.

To Do Entries May Be Routed Out Of The System

A To Do type can be configured so that its entries are interfaced to another system.

For example, a given To Do type can be configured to create an email message whenever a new To Do entry is created. The following points describe how to do this:

- Define the name of the background process responsible for interfacing the new To Do entries to another system on the respective To Do type. The base package contains a batch process called *FI-TDEER* that can be used for most situations. This batch process invokes the **External Routing algorithms** defined on each entry's To Do type.
- Plug in an appropriate **External Routing** algorithm on the respective To Do type. The logic in this type of algorithm performs the interface efforts for a specific To Do entry. For example, if an email message should be created for a To Do entry, the logic in the algorithm would compose and send the email message(s) for a specific To Do entry. While algorithms of this type can contain any type of logic, the following points highlight the configuration tasks that are necessary to create an email message in such an algorithm:
 - Create an **XAI Sender** as follows:
 - **Invocation Type:** MPL
 - **XAI Class:** Post Messages To Email
 - The **SMTP Host name** should be your implementation's email server.
 - Create an **Outbound Message Type** with a Business Object of **F1-EmailMessage**
 - Create an **External System** to represent the email system. It should have a single entry that references the **XAI Sender** and **Outbound Message Type** referenced above. This entry will have a **Processing Method** of XAI.
 - Create a To Do type **External Routing** algorithm that:
 - Formats the email message by populating elements in the business object referenced on the Outbound Message Type created above. Note: this email can contain hyperlinks to the source application as well as a summary of information about the To Do entry and its related objects.
 - Creates an outbound message by adding the business object formatted in the previous step.

Please note that most products contain example **External Routing** algorithm types that can be used as a basis for your own.

- Plug in the **External Routing algorithm** on the respective To Do type.

Click [here](#) to see the algorithm types available for this system event.

Periodically Purging To Do Entries

Note: This functionality is not available in every product.

Completed To Do entries should be periodically purged from the system by executing the *TD-PURGE* background process. This background process offers you the following choices:

- You can purge all To Do entries older than a given number of days.
- You can purge a specific To Do type's To Do Entries that are older than a given number of days.

We want to stress that there is no system constraint as to the number of **Completed** To Do entries that may exist. You can retain these entries for as long as you desire. However, you will eventually end up with a very large number of **Completed** entries and these entries will cause the various To Do background processes to degrade over time. Therefore, you should periodically purge **Completed** To Do entries as they exist only to satisfy auditing and reporting needs.

Note: **Different retention periods for different types of To Do entries.** Keep in mind that the purge program allows you to retain different types of entries for different periods of time. For example, you could keep bill segment errors for a short amount of time (as they tend to be voluminous), but keep disputed open item events for a longer period.

Setting Up To Do Options

The topics in this section describe how to set up To Do management options.

Installation Options

The following section describes configuration setup on the installation options.

To Do Information May Be Formatted By An Algorithm

A **To Do Information** algorithm may be plugged in on the [installation record](#) to format the standard To Do information that appears throughout the system. This algorithm may be further overridden by a corresponding plug-in on the [To Do Type](#).

Set Additional Information Before A To Do Is Created

A **To Do Pre-creation** algorithm may be plugged in on the [installation record](#) to set additional information for a To Do entry before it is created.

For example, Oracle Utilities Customer Care and Billing provides an algorithm that attempts to link (using characteristics) a related person, account, premise, service agreement or service point to a To Do entry based on its drill key value. Note, before you can set up this algorithm, you must define the characteristic types that you'll use to hold each of these entities.

Another example from Oracle Utilities Customer Care and Billing is that it provides an algorithm to determine a To Do role based on account management group and division information.

Alerts

If your To Do entries reference characteristics that related to your global context data and your product supports an alert algorithm plugged into the [installation options](#), you may want configure an algorithm to display an alert if the entry is **Open** or **Being Worked On**.

For example, Oracle Utilities Customer Care and Billing provides an alert algorithm that displays an alert when a To Do in this status exists for the account, person or premise displayed in the current context. Refer to [Linking Additional Information To A To Do Entry](#) for more information.

Next Assignment Algorithm

If your organization opts to use the next assignment feature supported by the Current To Do dashboard zone, you need to plug-in a **Next To Do Assignment** algorithm into the [installation options](#) to determine the next To Do entry the user should work on. Make sure you provide users with security access rights to the zone's next assignment action.

Fastpath: Refer to the [Current To Do](#) zone for more information.

Messages

You need only set up new messages if you use algorithms to create To Do entries or prefer different messages than those associated with the base package's To Do types.

Feature Configuration

The base package is provided with a generic **Activity Queue Management** *Feature Configuration* type. You may want to set up a feature configuration of this type to define any To Do management related options supporting business rules specific to your organization.

For example, the base package provides the following plug-ins to demonstrate a business practice where To Do entries are only assigned to users with the proper skill levels to work on them.

- The base **To Do Post Processing** To Do Type algorithm *F1-VAL-SKILL* validates that a user has the necessary skill levels required to work on a given To Do entry.
- The base **Next To Do Assignment** installation options algorithm *F1-NEXT-ASSG* only assigns To Do entries to users that have the proper skills to work on them. This plug-in is only applicable if your organization practices *work distribution* "on demand".

You must set up such an **Activity Queue Management** feature configuration if you want to use any of the above base package plug-ins.

The following points describe the various **Option Types** provided with the base package:

- **Skill.** This option provides a reference to a skill category. For example, if you were using characteristics to represent skill categories then you should reference each characteristic type using this option.
- **Override Skill.** This option provides an override skill information reference for a specific message. For example, if you were using a To Do Type characteristic to specify an override skill category and level for a specific message category / number then you would reference this characteristic type using this option.

Note: Skill Setup. Refer to the description of the above base package algorithms for further details on how to setup skill level information.

Note: More Options. Your implementation may define additional options types. You do this by add new lookup values to the lookup field **F1QM_OPT_TYP_FLG**.

Note: Only one. The system expects only one **Activity Queue Management** feature configuration to be defined.

Defining To Do Roles

This section describes the control table used to maintain To Do roles.

To Do Role - Main

The **Main** page is used to define basic information about a To Do role.

To maintain this information, select **Admin Menu > To Do Role** and navigate to the **Main** page.

Description of Page

Enter a unique **To Do Role** and **Description** for the To Do role.

The grid contains the ID of each **User** that may view and work on entries assigned to this role. The First Name and Last Name associated with the user is displayed adjacent.

Note: System Default Role. The system supplies a default role **F1_DFLT** linked to each system To Do type.

Where Used

Follow this link to view the tables that reference [CI_ROLE](#) in the data dictionary schema viewer.

In addition, a role may be defined as a parameter of an algorithm.

Fastpath: Refer to [To Do Entries Reference A Role](#) for more information about roles and To Do entries.

To Do Role - To Do Types

The **To Do Types** page defines the To Do types that may be viewed and worked on by users belonging to a given To Do role.

To maintain this information, select **Admin Menu > To Do Role** and navigate to the **To Do Types** page.

Description of Page

Enter the ID of each **To Do Type** whose entries may be viewed and worked on by the role.

Use As Default is a display-only field that indicates if the role is assigned to newly created entries of this type. You may define the default role for a given To Do type on the To Do Type maintenance page.

Caution: If you remove a To Do type where this role is the default, you must define a new role as the default for the To Do type. You do this on the To Do Type maintenance page.

Defining To Do Types

This section describes the control table used to maintain To Do types.

To Do Type - Main

The **Main** page is used to define basic information about a To Do type.

Fastpath: Refer to [The Big Picture Of To Do Lists](#) for more information about To Do types and To Do lists in general.

To maintain this information, select **Admin Menu > To Do Type** and navigate to the **Main** page.

Caution: Important! If you introduce a To Do type, carefully consider its naming convention. Refer to [System Data Naming Convention](#) for more information.

Description of Page

Enter a unique **To Do Type** and **Description** for the To Do type.

Owner indicates if this entry is owned by the base package or by your implementation (**Customer Modification**).

Use the **Detailed Description** to provide further details related to the To Do Type.

Enter the default **Priority** of To Do entries of this type in respect of other To Do types. Refer to [The Priority Of A To Do Entry](#) for more information.

For **To Do Type Usage**, select **Automatic** if To Dos of this type are created by the system (i.e., a background process or algorithm). Select **Manual** if a user can create a To Do of this type online.

Define the **Navigation Option** for the page into which the user is transferred when drilling down on a To Do entry of this type.

Use **Creation Process** to define the background process, if any, that is used to manage (i.e., create and perhaps complete) entries of this type. A **Creation Process** need only be specified for those To Do types whose entries are created by a background process. Refer to [To Do Entries Created By Background Processes](#) for more information.

Use **Routing Process** to define the background process that is used to download entries of a given type to an external system, if any. A **Routing Process** need only be specified for those To Do types whose entries are routed to an external system (e.g., an Email system or an auto-dialer). Refer to [To Do Entries May Be Routed Out Of The System](#) for more information.

Use **Message Category** and **Message Number** to define the message associated with this To Do type's entries. Note: this message will only be used if the process that creates the To Do entry does not supply a specific message number. For example, the process that creates To Do entries that highlight bill segments that are in error would not use this message; rather, the entries are marked with the message associated with the bill segment's error.

Use the characteristics collection to define a **Characteristic Type** and **Characteristic Value** common to all To Do entries of this type. You may enter more than one characteristic row for the same characteristic type, each associated with a unique **Sequence** number. If not specified, the system defaults it to the next sequence number for the characteristic type.

Where Used

Follow this link to view the tables that reference [CI_TD_TYPE](#) in the data dictionary schema viewer.

To Do Type - Roles

The **Roles** page defines the roles who may view and work on entries of a given To Do type.

To maintain this information, select **Admin Menu > To Do Type** and navigate to the **Roles** page.

Description of Page

Enter each **To Do Role** that may view and work on entries of a given type. Turn on **Use as Default** if the role should be assigned to newly created entries of this type. Only one role may be defined as the default per To Do type.

Fastpath: Refer to [To Do Entries Reference A Role](#) for more information about roles and To Do entries.

To Do Type - Sort Keys

The **Sort Keys** page defines the various ways a To Do list's entries may be sorted. For example, when you look at the bill segment error To Do List, you have the option of sorting the entries in error number order, account name order, or in customer class order.

To maintain this information, select **Admin Menu > To Do Type** and navigate to the **Sort Keys** page.

Caution: Do not change this information unless you are positive that the process / algorithm that creates entries of a given type stores this information on the entries.

Description of Page

The following fields display for each sort key.

Sequence is the unique ID of the sort key.

Description is the description of the sort key that appears on the To Do list.

Use as Default indicates the default sort key (the one that is initially used when a user opens a To Do list). Only one sort key may be defined as the default per To Do type.

Sort Order indicates whether the To Do entries should be sorted in **Ascending** or **Descending** order when this sort key is used.

Owner indicates if this entry is owned by the base package or by your implementation (**Customer Modification**).

To Do Type - Drill Keys

The **Drill Keys** page defines the keys passed to the application service (defined on the Main page) when you drill down on an entry of a given type.

To maintain this information, select **Admin Menu > To Do Type** and navigate to the **Drill Keys** page.

Caution: Do not change this information unless you are positive that the process / algorithm that creates entries of a given type stores this information on the entries.

Description of Page

Navigation Option shows the page into which the user is transferred when drilling down on a To Do entry of this type.

The following fields display for each drill key.

Sequence is the unique ID of the drill key.

Table and **Field** are passed to the application service when you drill down on an entry of a given type.

Owner indicates if this entry is owned by the base package or by your implementation (**Customer Modification**).

To Do Type - Message Overrides

The **Message Overrides** page is used if you want To Do entries that reference a given message category / number to be routed to a specific To Do role (or suppressed altogether) or if you want to associate a script to a given message category / number.

Fastpath: Refer to [To Do Entries Reference A Role](#) and [To Do Entries Can Be Rerouted Or Suppressed](#) for more information.

To maintain this information, select **Admin Menu > To Do Type** and navigate to the **Message Overrides** page.

Description of Page

The following fields display for each override.

Message Category and **Number** allow the message to be overridden.

Exclude To Do Entry indicates if a To Do entry of this type that references the adjacent **Message Category** and **Number** should NOT be created.

Override Role indicates the to do role to which a To Do entry of this type that references the adjacent **Message Category** and **Number** should be addressed. This field is protected if **Exclude To Do Entry** is on.

Script indicates the script that should execute when a user drills down on a To Do entry of this type that references the adjacent **Message Category** and **Number**. This field is protected if **Exclude To Do Entry** is on. Refer to [Working On A To Do Entry](#) for more information.

To Do Type - To Do Characteristics

The **To Do Characteristics** page defines characteristics that can be defined for To Do entries of this type.

To maintain this information, select **Admin Menu, To Do Type** and navigate to the **To Do Characteristics** page.

Turn on the **Required** switch if the **Characteristic Type** must be defined on To Do entries of this type.

Enter a **Characteristic Value** to use as the default for a given **Characteristic Type** when the **Default** switch is turned on. Use **Sequence** to control the order in which characteristics are defaulted.

To Do Type - Algorithms

The **To Do Algorithms** page defines the algorithms that should be executed for a given To Do type.

To maintain this information, select **Admin Menu, To Do Type** and navigate to the **Algorithms** page.

Description of Page

The grid contains **Algorithms** that control important To Do functions. If you haven't already done so, you must *set up the appropriate algorithms* in your system. You must define the following for each algorithm:

- Specify the **System Event** with which the algorithm is associated (see the table that follows for a description of all possible events).
- Specify the **Sequence Number** and **Algorithm** for each system event. You can set the **Sequence Number** to 10 unless you have a **System Event** that has multiple **Algorithms**. In this case, you need to tell the system the **Sequence** in which they should execute.

The following table describes each **System Event**.

System Event	Optional / Required	Description
Calculate Priority	Optional	<p>Algorithms of this type may be used to calculate a To Do entry's priority. They are called initially when a To Do entry is created and each time it gets updated so long as the To Do entry's priority has not been manually overridden. Once overridden, these algorithms are not called anymore.</p> <p>Note that it is not the responsibility of the algorithms to actually update the To Do entry with the calculated priority value but rather only return the calculated value. The system carries out the update as necessary.</p> <p>If more than one algorithm is plugged-in the system calls them one by one until the first to return a calculated priority.</p> <p>Click here to see the algorithm types available for this system event.</p>
External Routing	Optional	<p>Algorithms of this type may be used to route a To Do entry to an external system.</p> <p>The base package <i>F1-TDEER</i> background process invokes the algorithms for every To Do entry that its type references the process as the Routing Process and that the entry was not already routed. The background process marks an entry as routed by updating it with the batch control's current run number.</p> <p>If more than one algorithm is plugged-in the batch process calls them one by one until the first to indicate the To Do entry was routed.</p> <p>Click here to see the algorithm types available for this system event.</p>
To Do Information	Optional	<p>We use the term "To Do information" to describe the basic information that appears throughout the system to describe a To Do entry. The data that appears in "To Do information" is constructed using this algorithm.</p> <p>Plug an algorithm into this spot to override the "To Do information" algorithm on installation</p>

options or the system default "To Do information" if no such algorithm is defined on installation options.

Click [here](#) to see the algorithm types available for this system event.

To Do Post-Processing

Optional

Algorithms of this type may be used to validate and/or further process a To Do entry that has been added or updated.

Click [here](#) to see the algorithm types available for this system event.

List of System To Do Types

Note: List of To Do types. The To Do types available to use with the product may be viewed in the [application viewer's To Do type](#) viewer. In addition if your implementation adds To Do types, you may [regenerate](#) the application viewer to see your additions reflected there.

Implementing The To Do Entries

To enable the To Do entries listed above, you must configure the system as follows:

- Refer to [How Are To Do Entries Created?](#) for more information related to To Do entries created by background processes and algorithms.

Note: Refer to the description of a To Do type for additional configuration steps. For example, you may need to schedule a respective background process, update the To Do type with a corresponding creation process, etc.

- Define the To Do roles associated with each To Do type and link the appropriate users to them. Once you have defined the roles appropriate for your organization's To Do types, remove the reference to this system default role **F1_DFLT**. Refer to [To Do Entries Reference A Role](#) for more information.

Chapter 7

Defining Background Processes

This section describes how to set up the background processes that perform many important functions throughout your product such as:

- Processing To Do Entries
- Processes that purge data
- Processes that archive data
- And many more...

There are also batch processes that will apply to your specific source application. Please refer to the documentation section that applies to your source application for more information.

The Big Picture of Background Processes

The topics in this section provide background information about a variety of background process issues.

Background Processing Concepts

While the system uses a third-party scheduler to secure and execute its background processes, there are additional issues that you should be familiar with:

Note: All batch controls are delivered with the system.

- Batch control records are used for the following purposes:
 - For processes that extract information, the batch control record defines the next batch number to be assigned to new records that are eligible for extraction. For example, the batch control record associated with the process that extracts bill print information defines the next batch number to be assigned to recently completed bill routings. When this bill print extract process next runs, it extracts all bill routings marked with the current batch number (and increments the next batch number).

- The batch control record for each background process organizes audit information about the historical execution of the background process. The system uses this information to control the restart of failed processes. You can use this information to view error messages associated with failed runs.
- Many processes have been designed to run in parallel in order to speed execution. For example, the process that produces bills in Oracle Utilities Customer Care and Billing can be executed so that bills are produced in multiple "threads" (and multiple threads can execute at the same time). Batch control records associated with this type of process organize audit information about each thread in every execution. The system uses this information to control the restart of failed threads. Refer to [Parallel Background Processes](#) for more information.
- Some processes define extra parameters. These parameters are defined with the batch control and will be used when the *background process is submitted on-line*.

The following diagram illustrates the relationships that exist for batch control records.

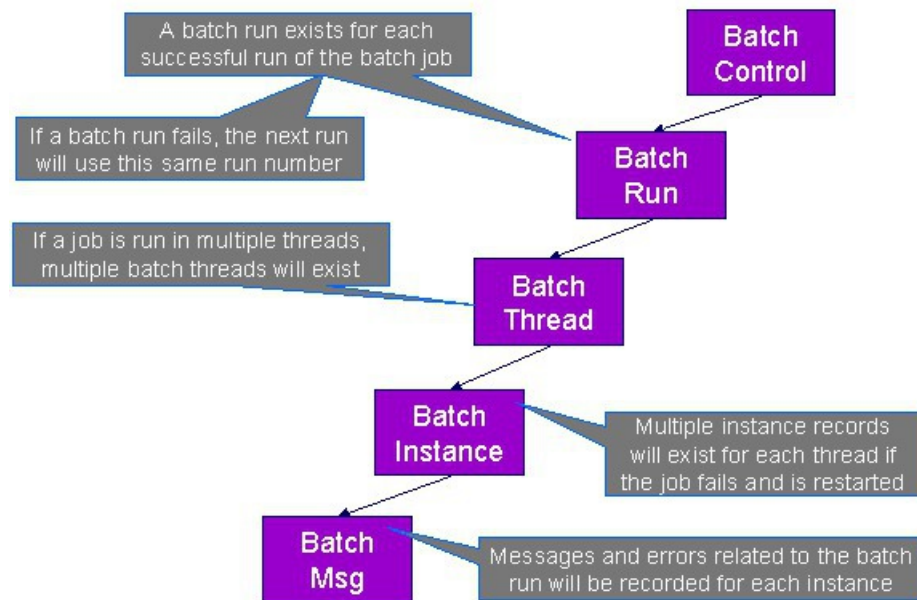

Results of each batch run can be viewed using the [Batch Run Tree](#) page.

Parameters Supplied To Background Processes

All background processes receive the following parameters.

- **Batch code.** Batch code is the unique identifier of the background process.
- **Batch thread number.** Thread number is only used for background processes that can be run in multiple parallel threads. It contains the relative thread number of the process. For example, if the billing process has been set up to run in 20 parallel threads, each of the 20 instances receives its relative thread number (1 through 20). Refer to [Optimal Thread Count for Parallel Background Processes](#) for more information.
- **Batch thread count.** Thread count is only used for background processes that can be run in multiple parallel threads. It contains the total number of parallel threads that have been scheduled. For example, if the billing process has been set up to run in 20 parallel threads, each of the 20 instances receives a thread count of 20. Refer to [Optimal Thread Count for Parallel Background Processes](#) for more information.
- **Batch rerun number.** Rerun number is only used for background processes that download information that belongs to given run number. It should only be supplied if you need to download an historical run (rather than the latest run).

- **Batch business date.** Business date is only used for background processes that use the current date in their processing. For example, billing using the business date to determine which bill cycles should be downloaded. If this parameter is left blank, the system date is used. If supplied, this date must be in the format YYYY-MM-DD. Note: this parameter is only used during QA to test how processes behave over time.
- **Override maximum records between commits.** This parameter is optional and overrides each background process's Standard Commit. You would reduce this value, for example, if you were submitting a job during the day and you wanted more frequent commits to release held resources. You might want to increase this value when a background process is executed at night (or weekends) and you have a lot of memory on your servers.
- **Override maximum minutes between cursor re-initiation.** This parameter is optional and overrides each background process's Standard Cursor Re-Initiation Minutes. You would reduce these values, for example, if you were submitting a job during the day and you wanted more frequent commits to release held resources (or more frequent cursor initiations). You might want to increase these values when a background process is executed at night (or weekends) and you have a lot of memory on your servers.

Note: The maximum minutes between cursor re-initiation is relevant for Oracle implementations only. Most of the system background processes contain an outermost loop / cursor. The cursor is opened at the beginning of the process and closed at the end. If Oracle feels that the cursor is open for too long, it may incorrectly interpret this as a problem and may issue an error that the snapshot is too old. The commit processing for the background processes is designed to refresh the cursor based on the minutes between cursor re-initiation in order to prevent this error.

- **User ID.** Please be aware of the following in respect of user ID:
 - The user ID is a user who should have access to all application services in the system. This is because some batch processes call application services to perform maintenance functions (e.g., when an account is updated, the batch process may call the account maintenance application service).
 - Some batch processes stamp a user ID on records they create / update. For example, the billing process stamps this user ID on financial transactions it creates.
 - This user ID's *display profile* controls how dates and currency values are formatted in messages and bill calculation lines.
- **Password.** Password is not currently used.
- **Language Code.** Language code is used to access language-specific control table values. For example, error messages are presented in this language code.
- **Trace program at start (Y/N), trace program exit (Y/N), trace SQL (Y/N) and output trace (Y/N).** These switches are only used during QA and benchmarking. If trace program start is set to Y, a message is displayed whenever a program is started. If trace program at exist is set to Y, a message is displayed whenever a program is exited. If trace SQL is set to Y, a message is displayed whenever an SQL statement is executed. If output trace is set to Y, special messages formatted by the background process are written.

Note: The information displayed when the output trace switch is turned on depends on each background process. It is possible that a background process displays no special information for this switch.

Override Maximum Errors in Batch Process Parameter

Each of the batch processes has, as part of its run parameters, a preset constant that determines how many errors that batch process may encounter before it is required to abort the run. A user can override this constant with an optional additional parameter (MAX-ERRORS). If a user chooses not to enter a value for the parameter, the process uses its own preset constant.

The input value must be an integer that is greater than or equal to zero. The maximum valid value for this parameter is 999,999,999,999,999.

The syntax for entering this additional parameter when submitting the batch process is "MAX-ERRORS=PARM VALUE", where the PARM VALUE is the desired value (e.g., **MAX-ERRORS=50**).

Extra Parameters

A limited number of background processes receive additional parameters. When a process receives additional parameters, they are documented adjacent to the respective batch process description in the following sections in the **Extra Parameters** column.

The syntax for entering these parameters when submitting the batch process is "PARAM-NAME=PARAM VALUE", where PARAM-NAME is the name of the parameter as it is documented below for each batch process and the PARAM VALUE is the desired value. For example, if the documentation indicates that the extra parameter for a particular batch process is **ADD-WORK-DAYS**, with possible values of **Y** and **N**, and you want to pass a value of **N**, enter the following when prompted: **ADD-WORK-DAYS=N**.

Indicating a File Path

Some of the system background processes use extra parameters to indicate a File Path and/or File Name for an input file or an output file. For example, most extract processes use File Path and File Name parameter to indicate where to place the output file.

When supplying a FILE-PATH variable, the directory specified in the FILE-PATH must already exist and must grant write access to the administrator account for the product. You may need to verify a proper location with your systems administrator.

The syntax of the FILE-PATH depends on the platform used for the product application server. Contact your system administrator for verification. For example, if the platform is UNIX, use forward slashes and be sure to put a trailing slash, for example **/spltemp/filepath/**.

Processing Errors

When a background process detects an error, the error may or may not be related to a specific object that is being processed. For example, if the program finds an error during batch parameter validation, this error is not object-specific. However, if the program finds an error while processing a specific bill, this error is object-specific. The system reports errors in one of the following ways:

- Errors that are not object-specific are written to the error message log in the *Batch Run Tree*.
- Some batch processes create entries in an "exception table" for certain object-specific errors. For example, an error detected in the creation of a bill in Oracle Utilities Customer Care and Billing may be written to the bill exception table. If an error is written to an exception table, it does not appear in the batch run tree. For each exception table, there is an associated to do entry process that creates a To Do Entry for each error to allow a user to correct the problem on-line.
- For some background processes, errors that do not result in the creation of an exception record may instead generate a To Do entry directly. For these processes, if you wish the system to directly create a To Do entry, you must configure the To Do type appropriately. Refer to *To Do entry for object-specific errors* for information about configuring the To Do type. If the background process detects an object specific error AND you have configured the system to create a To Do entry, the error is not written to the batch run tree. If you have configured your To Do type to not create To Do entries for certain errors, these errors are written to the *batch run tree*.

Note: Some processes create exceptions and To Do entries. It is possible for a background process to create entries in an exception table AND create To Do entries directly, depending on the error. Consider batch billing in Oracle Utilities Customer Care and Billing; any conditions that cause a bill or bill segment to be created in **error** status result in a record added to the bill exception table or the bill segment exception table. However, any object-specific error that

is not related to a specific bill or bill segment or any error that prevents a bill or bill segment from being created may result in a To Do entry for the object-specific error.

System Background Processes

Note: List of system background processes. The list of background processes provided in the base product may be viewed in the *application viewer's batch control* viewer. In addition if your implementation adds batch control records, you may *regenerate* the application viewer to see your additions reflected there.

Submitting Batch Jobs

Most batch jobs are submitted via a batch scheduler. Your organization may use a third party batch scheduler or may use the batch scheduling functionality provided with the system.

In addition, you can manually submit your adhoc background processes or submit a special run for one of your scheduled background processes using the online *batch job submission* page.

Technical Implementation Of Online Batch Submission

This section provides information about batch jobs are processed via the online batch submission.

A PERL Program Determines If There's Work To Do

A PERL program runs in the background looking for **Pending** batch jobs and then executes them. When a batch *job* is executed, a batch *run* is created. The batch *run* keeps track of the overall status of the various parallel threads and it manages restart logic should the run fail. The following flowchart provides a schematic of this logic:

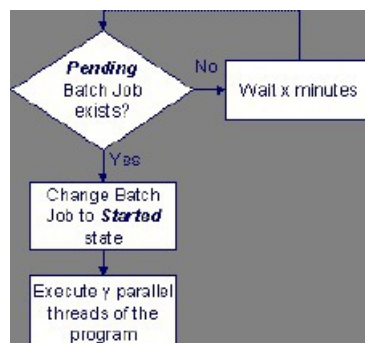

When a **Pending** batch job is detected by the PERL program, the following takes place:

- The batch job's status is changed to **Started**.
- *y* parallel threads of the corresponding batch program are executed. Refer to *Running Multi-threaded Processes* for more information.

When the batch program executes, its first thread has the responsibility of creating an **In Progress** batch *run* (assuming this is not a restarted run).

A Common Routine Is Invoked When Batch Programs Complete

When all threads of a batch program complete, a common routine is called. The following flowchart provides a schematic of this routine's logic:

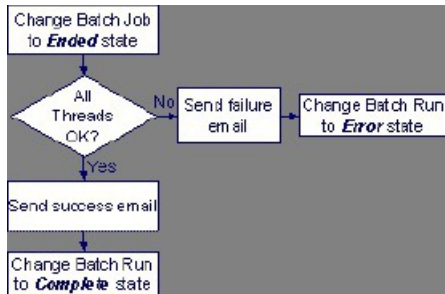

The following points summarize important concepts illustrated in the flowchart:

- The batch job's status is changed to **Ended**.
- The system checks if all threads were successful:
 - If at least one thread fails,
 - An email is sent (if an email address is defined on the batch job request).
 - The batch run's status is changed to **Error**.
 - If all threads are successful,
 - An email is sent (if an email address is defined on the batch job request).
 - The batch run's status is changed to **Complete**.

Polling Frequency

Usage of online batch submission requires that your system administrator create a job in the operating system to periodically execute the PERL program described above. The topics in this section describe how to do this for the Windows and Unix operating systems.

Windows Operating System

The configuration of the Periodic polling under Windows is documented in the Windows installation guide in the "Configuring Batch Submission to Run Via a Job Scheduler" section.

Unix Operating System

The configuration of the Periodic polling under UNIX is documented in the installation guide in the "Configuring cdxcronbatch.sh to Run Via a Job Scheduler" section.

Parallel Background Processes

Many processes have been designed to run in parallel in order to speed execution. For example, the billing process in Oracle Utilities Customer Care and Billing can be executed so that bills are produced in multiple "threads" (and multiple threads can execute at the same time).

Fastpath: The documentation for each background process provided with the system indicates if it may be run in parallel. Open the help index and navigate to the index entry labeled **background processes / system processes** to find the list of system processes for an indication of which processes can be run in parallel.

By default the system distributes the data for the multiple threads using the primary key of the main table of the process. For example, if you are running BILLING in Oracle Utilities Customer Care and Billing with multiple threads, the batch process distributes the accounts across the multiple threads. The Account ID is 10 digits long so if you run it with 4 threads, the records are processed as follows:

- Thread 1: Account IDs 0000000001 - 2500000000
- Thread 2: Account IDs 2500000001 - 5000000000
- Thread 3: Account IDs 5000000001 - 7500000000
- Thread 4: Account Ids 7500000001 - 9999999999

Note that the multi-threading logic relies on the fact that primary keys for master and transaction data are typically system generated random keys.

Note: Overriding the thread ranges. Your implementation has the ability to override the thread ranges if certain data in your system takes longer to process. For example, imagine you have a single account in Oracle Utilities Customer Care and Billing that has thousands of service agreements (maybe the account for a large corporation or a major city). You may want to set up the thread ranges to put this large account into its own thread and distribute the other accounts to the other threads. To do this, you should create the appropriate batch thread records ahead of time in a status of **Thread Ready (50)** with the key ranges pre-populated. Note that the base product does not provide the ability to add batch thread records online. If you are interested in more information about this technique, contact Customer Support.

Optimal Thread Count

Running a background process in multiple threads is almost always faster than running it in a single thread. The trick is determining the number of threads that is optimal for each process.

Note: A good rule of thumb is to have one thread for every 100 MHz of application server CPU available. For example if you have four 450 MHz processors available on your application server, you can start with 18 threads to begin your testing: $(450 * 4) / 100 = 18$.

This is a rule of thumb because each process is different and is dependent on the data in your database. Also, your hardware configuration (i.e., number of processors, speed of your disk drives, speed of the network between the database server and the application server) has an impact on the optimal number of threads. Please follow these guidelines to determine the optimal number of threads for each background process:

- Execute the background process using the number of threads dictated by the rule of thumb (described above). During this execution, monitor the utilization percentage of your application server, database server and network traffic.
- If you find that your database server has hit 100% utilization, but your application server hasn't one of the following is probably occurring:
 - There may be a problematic SQL statement executing during the process. You must capture a database trace to identify the problem SQL.

- It is also possible that your commit frequency may be too large. Commit frequency is a parameter supplied to every background process. If it is too large, the database's hold queues can start swapping. Refer to [Parameters Supplied to Background Processes](#) for more information about this parameter.
- It is normal if you find that your application server has hit 100% utilization but your database server has not. This is normal because, in general, all processes are CPU bound and not IO bound. At this point, you should decrease the number of threads until just under 100% of the application server utilization is achieved. And this will be the optimal number of threads required for this background process.
- If you find that your application server has NOT hit 100% utilization, you should increase the number of threads until you achieve just under 100% utilization on the application server. And remember, the application server should achieve 100% utilization before the database server reaches 100% utilization. If this proves not to be true, something is probably wrong with an SQL statement and you must capture an SQL trace to determine the culprit.

Another way to achieve similar results is to start out with a small number of threads and increase the number of threads until you have maximized throughput. The definition of "throughput" may differ for each process but can be generalized as a simple count of the records processed in the batch run tree. For example, in the Billing background process in Oracle Utilities Customer Care and Billing, throughput is the number of bills processed per minute. If you opt to use this method, we recommend you graph a curve of throughput vs. number of threads. The graph should display a curve that is steep at first but then flattens as more threads are added. Eventually adding more threads will cause the throughput to decline. Through this type of analysis you can determine the optimum number of threads to execute for any given process.

How to Re-extract Information

If you need to recreate the records associated with an historical execution of an extract process, you can - simply supply the desired batch number when you request the batch process.

How to Submit Batch Jobs

You can manually submit your adhoc background processes or submit a special run for one of your scheduled background processes.

Fastpath: For more information, refer to [Batch Job Submission](#).

How to Track Batch Jobs

You can track batch jobs using the batch process pages, which show the execution status of batch processes. For a specified batch control id and run id, the tree shows each thread, the run-instances of each thread, and any messages (informational, warnings, and errors) that might have occurred during the run.

Fastpath: For more information, refer to [Tracking Batch Processes](#).

How to Restart Failed Jobs and Processes

Every process in the system can be easily restarted if it fails (after fixing the cause of the failure). All you have to do is resubmit the failed job; the system handles the restart.

Caution: If a batch process terminated abnormally, you must run the batch process **UPDERR- Change Batch Process's Status to Error** before you resubmit the job. Refer to [Dealing with Abnormally Terminated Batch Processes](#) for more information.

Defining Batch Controls

The system is delivered with all necessary batch controls. If you introduce a new background process, open **Admin Menu > Batch Control** to define the related batch control record. Refer to [Background Processing Concepts](#) for more information.

Caution: Important! If you introduce a new batch process, carefully consider its naming convention. Refer to [System Data Naming Convention](#) for more information.

Description of Page

Enter an easily recognizable **Batch Process** and **Description** for each batch process.

Owner indicates if this batch control is owned by the base package or by your implementation (**Customer Modification**). The system sets the owner to **Customer Modification** when you add a batch control. This information is display-only.

Use the **Detailed Description** to describe the functionality of the batch process in detail.

Use **Batch Control Type** to define the batch process as either **Timed** or **Not Timed**. A Timed batch process will be automatically initialized on a regular basis. A Not Timed process needs to be run manually or through a scheduler.

Use **Batch Control Category** to categorize the process for documentation purposes.

If the batch process is Timed, then the following fields are available:

- **Timer Interval** is the number of seconds between batch process submissions.
- **User ID** is the ID under which the batch process will run.
- **Email Address** is the Email address to be used for notification if the batch process fails.
- **Timer Active** allows you to temporarily switch off the timer for development or testing purposes.
- **Batch Language** is the language associated with the batch process.

Use **Program Type** to define if the batch process program is written in **Java** or **COBOL**.

Note: COBOL Programs. COBOL is not supported for all products.

Use **Program Name** to define the program associated with your batch process:

- If the Program Type is COBOL, enter the name of the COBOL program.
- If the Program Type is **Java**, enter the Java class name.

Note: View the source. If the program is shipped with the base package, you can use the adjacent button to display the source code of this program in the [source viewer](#) or [Java docs viewer](#).

Level of Service indicates the operating condition of the batch control.

- **Disabled** indicates that the batch level of service algorithm is not enabled for the batch control.
- **Error** indicates that errors were detected in the last batch process, or that the amount of time between batch processes exceeded a specified period.
- **Normal** indicates that no errors were detected in the last batch process.

The **Last Update Timestamp**, **Last Update Instance** and **Next Batch Nbr** are used for audit purposes.

Turn on **Accumulate All Instances** to control how this batch control is displayed in the [Batch Run Tree](#). If checked, the run statistics (i.e., "Records Processed" and "Records in Error") for a thread are to be accumulated from all the instances

of the thread. This would include the original thread instance, as well as any restarted instances. If this is not turned on, only the ending (last) thread instance's statistics are used as the thread's statistics. This may be preferred for certain types of batch processes where the accumulation would create inaccurate thread statistics, such as those that process flat files and, therefore, always start at the beginning, even in the case of a restart.

The following fields are default values that are used when a batch job IS submitted for the batch control:

- Use **Thread Count** to control whether a background process is run single threaded or in multiple parallel threads. This value defines the total number of threads that have been scheduled.
- Select **Trace Program Start** if you want a message to be written whenever a program is started.
- Select **Trace SQL** if you want a message to be written whenever an SQL statement is executed.
- Use **Override Nbr Records to Commit** to define the default number of records to commit. This is used as the default value for timed jobs as well as online submission of jobs that are not timed.
- Select **Trace Program Exit** if you want a message to be written whenever a program is exited.
- Select **Trace Output** if you want a message to be displayed for special information logged by the background process.

For more information about these fields, see [Batch Job Submission - Main](#)

The parameter collection is used to define additional parameters required for a particular background process. The following fields should be defined for each parameter:

Sequence. Defines the relative position of the parameter.

Parameter Name. The name of the parameter as defined in [System Background Processes](#).

Description. A description of the parameter.

Detailed Description. A more detailed description of the parameter.

Required. Indicate whether or not this is a required parameter.

Parameter Value. Enter a default value, if applicable.

Owner Indicates if this batch process is owned by the base package or by your implementation (Customer Modification). The system sets the owner to **Customer Modification** when you add a batch process. This information is display-only.

Batch Control - Algorithms

Use this page to maintain a batch control's algorithms. Open this page using **Admin Menu > Batch Control** and then navigate to the **Algorithms** tab.

Description of Page

The **Algorithms** grid contains algorithms that control important functions for instances of this batch control. You must define the following for each algorithm:

- Specify the **System Event** with which the algorithm is associated (see the table that follows for a description of all possible events).
- Specify the **Sequence Number** and **Algorithm** for each system event. You can set the **Sequence Number** to 10 unless you have a **System Event** that has multiple **Algorithms**. In this case, you need to tell the system the **Sequence** in which they should execute.

The following table describes the **System Events**.

System Event	Optional / Required	Description
Batch Control — Level of Service	Optional	Algorithms of this type are called to determine the Level of Service provided by a batch control by analyzing the batch run tree. Click here to see the algorithm types available for this system event.

The Big Picture of Requests

Requests enable an implementer to design an ad-hoc batch process using the configuration tools.

An example of such a process might be to send an email to a group of users that summarizes the To Do entries that are assigned to them. This is just one example. The request enables many types of diverse processing.

Request Type Defines Parameters

For each type of process that your implementation wants, you must configure a request type to capture the appropriate parameters needed by the process.

Previewing and Submitting a Request

To submit a new request, go to **Main Menu > Batch, Request +** . You must select the appropriate request type and then enter the desired parameter values, if applicable.

After entering the parameters, the following actions are possible:

- Click **Save** to submit the request.
- Click **Cancel** to cancel the request.
- Click **Preview** to see a sample of records that satisfy the selection criteria for this request. This information is displayed in a separate map. In addition, the map displays the total number of records that will be processed when the request is submitted. From this map you can click **Save** to submit the request, **Back** to adjust the parameters, or **Cancel** to cancel the request.

When a request is saved, the job is not immediately submitted for real time processing. The record is saved with the status **Pending** and a monitor process for this record's business object is responsible for transitioning the record to **Complete**.

As long as the record is still **Pending**, it may be edited to adjust the parameters. The preview logic described above may be repeated when editing a record.

The actual work of the request, such as generating an email, is performed when transitioning to **Complete** (using an enter processing algorithm for the business object).

To Do Summary Email

The base product includes a sample request process that sends an email to users that have incomplete To Dos older than a specified number of days.

The following configuration tasks are required to use this process:

- Define an Outbound Message Type. The business object usually defined for the Outbound Message Type is **F1-EmailMessage**.
- Define an External System that contains the Outbound Message Type in one of its steps. In the External System step, you may want to define an XAI, batch, or real-time processing method when sending the email notification. For an XAI method you will need to create an XAI Sender in your email configuration. For a batch method a batch program will need to be defined. For a real-time method the response XSL should be properly defined.
- Create a Request Type that includes the Outbound Message Type and the corresponding External System.

- Create a Request for the created Request Type.

Exploring Request Data Relationships

Use the following links to open the application viewer where you can explore the physical tables and data relationships behind the request functionality:

- Click [F1-REQ-TYPE](#) to view the request type maintenance object's tables.
- Click [F1-REQ](#) to view the request maintenance object's tables.

Defining a New Request

To design a new ad-hoc batch job that users can submit via Request, first create a new Request Type business object. The base product BO for request type, **F1-TodoSumEmailTyp**, may be used as a sample.

The business object for the request includes the functionality for selecting the records to process, displaying a preview map for the user to review, and for performing the actual processing. The base product BO for request, **F1-TodoSumEmailReq**, may be used as a sample. The following points highlight the important configuration details for this business object:

- Special BO options are available for request BOs to support the Preview Request functionality.
 - **Request Preview Service Script**. This script retrieves the information that is displayed when a user asks for a preview of a request.
 - **Request Preview Map**. This map displays the preview of a request.
- The enter algorithm plugged into the Complete state is responsible for selecting the records that satisfy the criteria and processing the records accordingly.

Setting Up Request Types

Use the Request Type portal to define the parameters to capture when submitting a request. Open this page using **Admin Menu > Request Type** .

This topic describes the base-package zones that appear on the Request Type portal.

Request Type List . The Request Type List zone lists every request type. The following functions are available:

- Click a **broadcast** icon to open other zones that contain more information about the request type.
- Click **Add** in the zone's title bar to add a new request type.

Request Type. The Request Type zone contains display-only information about a request type. This zone appears when a request type has been broadcast from the Request Type List zone or if this portal is opened via a drill down from another page. The following functions are available:

- Click **Edit** to start a business process that updates the request type.
- Click **Delete** to start a business process that deletes the request type.
- Click **Deactivate** start a business process that deactivates the request type.
- Click **Duplicate** to start a business process that duplicates the request type.
- State transition buttons are available to transition the request type to an appropriate next state.

Please see the zone's help text for information about this zone's fields.

Maintaining Requests

Use the Request transaction to view and maintain pending or historic requests.

Open this page using **Main Menu > Batch > Request** . This topic describes the base-package portals and zones on this page.

Request Query. Use the query portal to search for an existing request. Once a request is selected, you are brought to the maintenance portal to view and maintain the selected record.

Request Portal. This portal appears when a request has been selected from the Request Query portal. The following base-package zones appear on this portal:

- **Actions.** This is a standard actions zone.
- **Request.** The Request zone contains display-only information about a request. Please see the zone's help text for information about this zone's fields.
- **Request Log.** This is a standard log zone.

Chapter 8

Defining Algorithms

In this section, we describe how to set up the user-defined algorithms that perform many important functions including:

- Validating the format of a phone number entered by a user.
- Validating the format of a latitude/longitude geographic code entered by a user.
- In products that support payment and billing:
 - Calculating late payment charges.
 - Calculating the recommended deposit amount.
 - Constructing your GL account during the interface of financial transactions to your GL
- And many other functions...

The Big Picture Of Algorithms

Many functions in the system are performed using a user-defined algorithm. For example, when a CSR requests a customer's recommended deposit amount, the system calls the deposit recommendation algorithm. This algorithm calculates the recommended deposit amount and returns it to the caller.

Note: Algorithm = Plug-in. We use the terms plug-in and algorithm interchangeably throughout this documentation.

So how does the system know which algorithm to call? When you set up the system's control tables, you define which algorithm to use for each component-driven function. You do this on the control table that governs each respective function. For example:

- You define the algorithm used to validate a phone number on your phone types.
- You define the algorithm in Oracle Utilities Customer Care and Billing used to calculate late payment charges on each Service Agreement Type that has late payment charges.
- The list goes on...

The topics in this section provide background information about a variety of algorithm issues.

Algorithm Type Versus Algorithm

You have to differentiate between the type of algorithm and the algorithm itself.

- An **Algorithm Type** defines the program that is called when an algorithm of this type is executed. It also defines the types of parameters that must be supplied to algorithms of this type.
- An **Algorithm** references an **Algorithm Type**. It also defines the value of each parameter. It is the algorithm that is referenced on the various control tables.

Fastpath: Refer to [How to Add A New Algorithm](#) for an example that will further clarify the difference between an algorithm and an algorithm type.

How To Add A New Algorithm

Before you can add a new algorithm, you must determine if you can use one of the sample algorithm types supplied with the system. Refer to [List of Algorithm Types](#) for a complete list of algorithm types.

If you can use one of the sample algorithm types, simply add the algorithm and then reference it on the respective control table. Refer to [Setting Up Algorithms](#) for how to do this.

If you have to add a new algorithm type, you may have to involve a programmer. Let's use an example to help clarify what you can do versus what a programmer must do. Assume that you require an additional geographic type validation algorithm. To create your own algorithm type you must:

- Write a new program to validate geographic type in the appropriate manner. Alternatively, you may configure a plug-in script to implement the validation rules. The advantage of the latter is that it does not require programming. Refer to [plug-in script](#) for more information.
- Create an Algorithm Type called **Our Geographic Format** (or something appropriate). On this algorithm type, you'd define the name of the program (or the plug-in script) that performs the function. You'd also define the various parameters required by this type of algorithm.
- After creating the new Algorithm Type, you can reference it on an Algorithm.
- And finally, you'd reference the new Algorithm on the Geographic Type that requires this validation.

Minimizing The Impact Of Future Upgrades

The system has been designed to use algorithms so an implementation can introduce their own logic in a way that's 100% upgradeable (without the need to retrofit logic). The following points describe strong recommendations about how to construct new algorithm type programs so that you won't have to make program changes during future upgrades:

- Do not alter an algorithm type's hard parameters. For example, you might be tempted to redefine or initialize parameters defined in an algorithm type's linkage section. Do not do this.
- Follow the naming conventions for the new algorithm type code and your source code, i.e., both the source code and the algorithm type should be prefixed with "CM". The reason for this naming convention is to make it impossible for a new, base-package algorithm type from overwriting your source code or algorithm type meta-data (we will never develop a program or introduce meta-data beginning with CM).
- Avoid using inline SQL to perform insert/update/delete. Rather, invoke the base-package's object routines or common routines.

- Avoid using base messages (outside of common messages, i.e., those with a message number < 1000) as we may deprecate or change these messages in future releases. The most common problem is caused when an implementation clones a base package algorithm type program because they need to change a few lines of logic. Technically, to be 100% upgradeable, you should add new messages in the "90000" or greater category (i.e., the category reserved for implementation-specific messages) for every message in your new program even though these messages may be duplicates of those in the base package.

Setting Up Algorithm Types

The system is supplied with samples of every type of algorithm used by the system. If you need to introduce a new type of algorithm, open **Admin Menu > Algorithm Type** .

Fastpath: Refer to [The Big Picture Of Algorithms](#) for more information.

Caution: Important! If you introduce a new algorithm type, carefully consider its naming convention. Refer to [System Data Naming Convention](#) for more information.

Description of Page

Enter an easily recognizable **Algorithm Type** and **Description**.

Owner indicates if this algorithm type is owned by the base package or by your implementation (**Customer Modification**). The system sets the owner to **Customer Modification** when you add an algorithm type. This information is display-only.

Enter a **Long Description** that describes, in detail, what algorithms of this type do.

Use **Algorithm Entity** to define where algorithms of this type can be "plugged in".

Note: The values for this field are customizable using the [lookup](#) table. This field name is ALG_ENTITY_FLG.

Use **Program Type** to define if the algorithm's program is written in **COBOL**, **Java** or **Plug-In Script**.

Note: COBOL Programs. COBOL programs are not supported in all products.

Note: Plug-In Scripts. Plug-in scripts are only supported for Java-enabled plug-in spots. Refer to the [Plug-In Scripts](#) section for more information.

Use **Program Name** to define the program to be invoked when algorithms of this type are executed:

- If the Program Type is **COBOL**, enter the name of the COBOL program.
- If the Program Type is **Java**, enter the Java class name.
- If the Program Type is **Plug-In Script**, enter the plug-in *script* name. Only plug-in scripts defined for the algorithm entity may be used.

Note: View the source. If the program is shipped with the base package, you can use the adjacent button to display the source code of this program in the [source viewer](#) or [Java docs viewer](#). Please note that plug-in scripts are developed by implementations (none are shipped with the base-package).

Use the **Parameter Types** grid to define the types of parameters that algorithms of this type use. The following fields should be defined for each parameter:

- Use **Sequence** to define the relative position of the **Parameter**.
- Use **Parameter** to describe the verbiage that appears adjacent to the parameter on the Algorithm page.
- Indicate whether the parameter is **Required**. This indicator is used when parameters are defined on algorithms that reference this algorithm type.

- **Owner** indicates if the parameter for this algorithm type is owned by the base package or by your implementation (**Customer Modification**). The system sets the owner to **Customer Modification** when you add an algorithm type with parameters. This information is display-only.

Where Used

An Algorithm references an Algorithm Type. Refer to [Setting Up Algorithms](#) for more information.

List of Algorithm Types

Note: List of available algorithms types. The algorithm types available to use with the product may be viewed in the [application viewer's algorithm](#) viewer. In addition if your implementation adds algorithm types or adds algorithms to reference existing algorithm types, you may [regenerate](#) the application viewer to see your additions reflected there.

Setting Up Algorithms

If you need to introduce a new algorithm, open **Admin Menu > Algorithm** . Refer to [The Big Picture Of Algorithms](#) for more information.

Description of Page

Enter an easily recognizable **Algorithm Code** and **Description** of the algorithm. **Owner** indicates if this algorithm is owned by the base package or by your implementation (**Customer Modification**).

Caution: Important! If you introduce a new algorithm, carefully consider its naming convention. Refer to [System Data Naming Convention](#) for more information.

Reference the **Algorithm Type** associated with this algorithm. This field is not modifiable if there are parameters linked to the algorithm (defined in the following collection).

Fastpath: Refer to [Algorithm Type Versus Algorithm for more information](#) about how an algorithm type controls the type of parameters associated with an algorithm.

Define the **Value** of each **Parameter** supplied to the algorithm in the **Effective-Dated** scroll. Note that the **Algorithm Type** controls the number and type of parameters.

Where Used

Every control table that controls component-driven functions references one or more algorithms. Refer to the description of Algorithm Entity under [Setting Up Algorithm Types](#) for a list of all such control tables.

Chapter 9

Defining Script Options

We use the term "script" to define processing rules that your implementation sets up to control both front-end and back-end processing:

- Rules that control front-end processing are defined using *Business Process Assistant* (BPA) scripts. For example, your implementation could set up a BPA script to guide a user through your organization's payment cancellation process.
- Rules that control back-end processing are defined using *Server-based* scripts. For example, your implementation could set up a server-based script to control the processing that executes whenever a given type of adjustment is canceled.

The topics in this section describe how to configure your scripts.

The Big Picture Of Scripts

This section describes features and functions that are shared by both BPA scripts and server-based scripts.

Scripts Are Business Process-Oriented

To create a script, you must analyze the steps used to implement a given business process. For example, you could create a "stop auto pay" BPA script that:

- Asks the user to select the customer / taxpayer using an appropriate search page
- Asks the user to define the date on which the person would like to stop making automatic payments
- Invokes a server-based script that populates the end-date on the account's latest automatic payment instructions.

After you understand the business process, you can set up a script to mimic these steps. If the business process is straightforward (e.g., users always perform the same steps), the script configuration will be straightforward. If the business process has several logic branches, the composition of the script may be more challenging.

Fastpath: Refer to *Examples of BPA Scripts* for examples.

A Script Is Composed Of Steps

A script contains one or more steps. For example, a "stop auto pay" BPA script might have three steps:

- Ask the user to select the customer / taxpayer using an appropriate search page
- Ask the customer the date on which they'd like to stop making automatic payments (and default the current date)
- Invoke a server-based script that, in turn, updates the account's auto pay options.

Each step references a step type. The step type controls what happens when a step executes. It might be helpful to think of a script as a macro and each step as a "line of code" in the macro. Each step's step type controls the function that is executed when the step is performed.

Fastpath: Refer to [How To Set Up Each Step Type](#) for a detailed description of all available step types and how to set them up.

Designing And Developing Scripts

Constructing a script is similar to writing a computer program. We recommend that you follow the approach outlined below when you construct scripts:

- Thoroughly understand the business process to be scripted
- Thoroughly understand how the transactions and services that your script uses work
- Design the steps for the script "on paper"
- Determine the most maintainable way to set up your scripts. Rather than creating complex, monolithic scripts, we recommend dividing scripts into smaller sections. For example:
 - For BPA scripts,
 - Determine if several scripts have similar steps. If so, set up a script that contains these common steps and invoke it from the main scripts. For example, if the main script were a BPA script, this would be invoked via a **Perform script** step.
 - Determine if a large script can be divided into logical sections. If so, set up a small script for each section and create a "master script" to invoke each. For example, if the main script were a BPA script, this would be invoked via a **Transfer control** step.
 - For server-based script, you can segregate reusable steps into "service scripts" and then use **Invoke service script** steps to execute the common logic.
- Add the script using [Script Maintenance](#)
- Thoroughly test the script

A Script May Declare Data Areas

Both BPA and server-based scripts may have one or more [data areas](#):

- If the script contains steps that exchange XML documents, you must declare a data area for each type of XML document. For example, if a BPA script has a step that invokes a service script, the BPA script must declare a data area that holds the XML document that is used to pass information to and from the service script.

- You can use a data area as a more definitive way to declare your temporary storage. For example, you can describe your script's temporary storage variables using a *stand-alone data area* schema and associate it with your script.

Various step types involve referencing the script's data areas as well as support the ability to compare and move data to and from field elements residing in the data areas.

An *Edit Data* step supports the syntax to dynamically declare data areas as part of the step itself. This technique eliminates the need to statically declare a data area. Refer to *Designing Generic Scripts* for an example of when this technique may be useful.

Designing Generic Scripts

Scripts may be designed to encapsulate an overall procedure common across different business objects.

For example, BPA scripts may implement a standard procedure to maintain business entities in which the first step obtains the entity's data, the second step presents its associated UI map to the user for update, and the last step updates the entity. Notice that in this case the only difference from one object to another is the data to capture. Rather than designing a dedicated BPA script with static data areas and invocation steps for each business object, you can design a single generic script that dynamically invokes a business object and its associated UI map.

This functionality is available only within an *Edit Data* step. With this technique, the name of the schema-based object is held in a variable or an XPath schema location and is used to both declare and invoke the object.

Note: Tips. Refer to the tips context zone associated with the script maintenance page for more information on edit data commands and examples.

Securing Script Execution

The system supports the ability to secure the execution of scripts by associating the script with an Application Service. Refer to *The Big Picture of Application Security* for more information. Application security is optional and applies to service scripts and user-invocable BPA scripts only. If a script is not associated with an application service, all users may execute the script. Otherwise, only users that have **Execute** access to the application service may execute the script.

You Can Import Sample Scripts From The Demonstration Database

Because each implementation has different business processes, each implementation will have different scripts. Sample scripts are supplied in the demonstration database that is delivered with your product. If you'd like to import any of these samples into your implementation refer to *How to Copy a Script from the Demonstration Database* for the details.

The Big Picture Of BPA Scripts

Fastpath: Refer to *The Big Picture Of Scripts* to better understand the basic concept of scripts.

Users may require instructions in order to perform certain tasks. The business process assistant allows you to set up scripts that step a user through your business processes. For example, you might want to create scripts to help users do the following:

- Add a new person to an existing account
- Set up a customer to pay automatically

- Modify a customer who no longer wants to receive marketing information
- Modify a customer's web password
- Record a trouble order
- Merge two accounts into one account
- Fix a bill with an invalid rate
- ... (the list is only limited by your time and imagination)

Users execute these scripts via the *business process assistant* (BPA). Users can also define their favorite BPA scripts in their *user preferences*. By doing this, a user can execute a script by pressing an accelerator key (`Ctrl + Shift + a` number).

Don't think of these scripts as merely a training tool. BPA scripts can also reduce the time it takes to perform common tasks. For example, you can write a script that reduces the "number of clicks" required to add a new person to an existing account.

Caution: Future upgrade issues. Although we make every effort not to remove fields or tab pages between releases, there may be times when changes made by the base-package will necessitate changes to your scripts. Please refer to the release notes for a list of any removed fields or tab pages.

Caution: Scripts are not a substitute for end-user training. Scripts minimize the steps required to perform common tasks. Unusual problems (e.g., a missing meter exchange) may be difficult to script as there are many different ways to resolve such a problem. However, scripts can point a user in the right direction and reduce the need to memorize obscure business processes.

The topics in this section describe background topics relevant to BPA scripts.

How To Invoke Scripts

Refer to *Initiating Scripts* for a description of how end-users initiate scripts.

Developing and Debugging Your BPA Scripts

You may find it helpful to categorize the step types into two groups: those that involve some type of activity in the *script area*, and those that don't. The following step types cause activity in the script area: **Height**, **Display text**, **Prompt user**, **Input data**, **Input Map**, **Set focus to a field**. The rest of the step types are procedural and involve no user interaction. For debugging purposes, you can instruct the system to display text in the script area for the latter step types. Also note, for debugging purposes, you can display an entire data area (or a portion thereof) in the script area by entering `%+...+%` where ... is the name of the node whose element(s) should be displayed.

Please see the *Examples of BPA Scripts* for ideas that you can use when you create your own BPA scripts.

Note: Time saver. When you develop a new BPA script, change your *user preferences* to include the script as your first "favorite". This way, you can press `Ctrl+Shift+1` to invoke the script (eliminating the need to select it from the *script menu*).

Launching A Script From A Menu

You can create menu items that launch BPA scripts rather than open a page. To do this, create a *navigation option* that references your script and then add a menu item that references the navigation option.

If the navigation option is referenced on a *context menu* and the navigation option has a "context field", a temporary storage variable will be created and populated with the unique identifier of the object in context. For example, if you add a "script"

navigation option to the bill context menu and this navigation option has a context field of `BILL_ID`, the system will create a temporary storage variable called `BILL_ID` and populate it with the respective bill id when the menu item is selected.

Launching A Script When Starting The System

You can set the system to launch a script upon startup.

For example, imagine that through an interactive voice response system, a customer has keyed in their account ID and has indicated that they would like to stop an automatic payment. At the point when the IVR system determines that the customer must speak to a user, the interface can be configured to launch the application. When launched it passes the script name and account ID. It can also pass a *navigation option* to automatically load the appropriate page (if this information is not part of the script).

To do this, parameters are appended to the standard system URL. The following parameters may be supplied:

- `script=<scriptname>`
- `ACCT_ID=<account id>`
- `location=<navigation option>`

Parameters are added to the standard system URL by appending a question mark (?) to the end and then adding the "key=value" pair. If you require more than one parameter, use an ampersand (&) to separate each key=value pair.

For example, the following URLs are possible ways to launch the **StopAutoPay** script at startup, assuming your standard URL for launching the system is `http://system-server:1234/cis.jsp`:

- `http://system-server:1234/cis.jsp?script=StopAutoPay`
- `http://system-server:1234/cis.jsp?script=StopAutoPay&ACCT_ID=1234512345`
- `http://system-server:1234/cis.jsp?script=StopAutoPay&ACCT_ID=1234512345&location=accountMaint`

It doesn't matter in which order the parameters are provided. The system processes them in the correct order. For example, the following examples are processed by the system in the same way:

- `http://system-server:1234/cis.jsp?ACCT_ID=1234512345&script=StopAutoPay&location=accountMaint`
- `http://system-server:1234/cis.jsp?ACCT_ID=1234512345&location=accountMaint&script=StopAutoPay`

These parameters are kept in a common area accessible by any script for the duration of the session. To use these parameters on a script you may reference the corresponding `%PARM-<name>` *global variables*. In this example, after the system is launched any script may have access to the above account ID parameter value by means of the `%PARM-ACCT_ID` global variable. Also note, these parameters are also loaded into temporary storage (to continue the example, there'd also be a temporary storage variable called `ACCT_ID` that holds the passed value).

Executing A Script When A To Do Entry Is Selected

The system creates *To Do entries* to highlight tasks that require attention (e.g., records in error). Users can complete many of these tasks without assistance. However, you can set up the system to automatically launch a script when a user selects a To Do entry. For example, consider a To Do entry that highlights a bill that's in error due to an invalid mailing address. You can set up the system to execute a script when this To Do entry is selected by a user. This script might prompt the user to first correct the customer's default mailing address and then re-complete the bill.

The following points provide background information to help you understand how to implement this functionality:

- Every To Do entry references a *To Do type* and a *message category and number*. The To Do type defines the category of the task (e.g., bill errors). The message number defines the specific issue (e.g., a valid address can't be found.). Refer to *The Big Picture of System Messages* for more information about message categories and numbers.

- When a user drills down on a To Do entry, either a script launches OR the user is transferred to the transaction associated with the entry's To Do type. You control what happens by configuring the To Do type accordingly:
 - If you want to launch a script when a user drills down on an entry, you link the script to the *To Do type and message number*. Keep in mind that you can define a different script for every message (and some To Do types have many different messages).
 - If the system doesn't find a script for an entry's To Do type and message number, it transfers the user to the To Do type's default transaction.

Note: How do you find the message numbers? We do not supply documentation of every To Do type's message numbers (this list would be impossible to maintain and therefore untrustworthy). The best way to determine which message numbers warrant a script is during pre-production when you're testing the system. During this period, To Do entries will be generated. For those entries that warrant a script, simply display the entry on *To Do maintenance*. On this page, you will find the entry's message number adjacent to the description.

- These types of scripts invariably need to access data that resides on the selected To Do entry. Refer to *How To Use To Do Fields* for the details.

The Big Picture Of Script Eligibility Rules

You can configure *eligibility criteria* on the scripts to limit the scripts that a user sees in the *script search*. For example, you could indicate a script should only appear on the script menu if the user belongs to the level 1 customer service representative group. You may also indicate that a script should only appear if the data a user is viewing has certain criteria. For example, if you are using Oracle Utilities Customer Care and Billing, you can indicate that a script should only appear if the current account's customer class is residential. By doing this, you avoid presenting the user with scripts that aren't applicable to the current data in context or the user's role.

The topics in this section describe eligibility rules.

Script Eligibility Rules Are Not Strictly Enforced

The *script search* gives a user a choice of seeing all scripts or only scripts that are eligible (given the current data in context and their user profile). This means that it's possible for a script that isn't eligible for the given context data / user to be executed via this search. In other words, the system does not strictly enforce a script's eligibility rules.

It might be more helpful to think of eligibility rules as "highlight conditions". These "highlight conditions" simply control whether the script appears in the *script search* when a user indicates they only want to see eligible scripts.

You Can Mark A Script As Always Eligible

If you don't want to configure eligibility rules, you don't have to. Simply indicate that the script is always eligible.

You Can Mark A Script As Never Eligible

If you have scripts that you do not want a user to select from the script menu, indicate that it is never eligible. An example of a script that you wouldn't want a user to select from the menu is one that is *launched when a To Do entry is selected*. These types of scripts most likely rely on data linked to the selected To Do entry. As a result, a user should only launch scripts of this type from the To Do entry and not from the script menu.

Criteria Groups versus Eligibility Criteria

Before we provide concrete examples of eligibility criteria, we need to explain two concepts: Criteria Groups and Eligibility Criteria. A script's criteria groups control whether a user is eligible to choose a script. At a high level, it works like this:

- A criteria group has one or more eligibility criteria. A group's criteria control whether the group is considered true or false.
- When you create a group, you define what should happen if the group is true or false. You have the following choices:
 - The user is eligible to choose the script
 - The user is not eligible to choose the script
 - The next group should be checked

We'll use the following example from Oracle Utilities Customer Care and Billing to help illustrate these points. Assume a script is only eligible if:

- The customer has electric service and the user belongs to user group A, B or C
- OR, the customer has gas service and the user belongs to user group X, Y or A

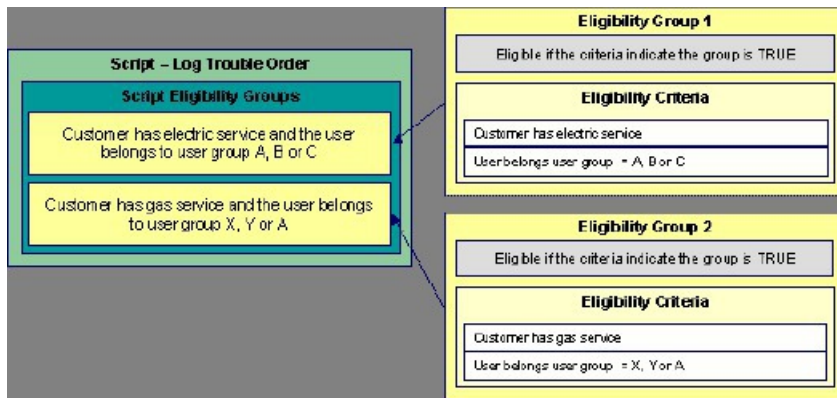

This script requires two eligibility groups because it has two distinct conditions:

- IF (Customer has electric service AND (User belongs to user group A, B or C))
- IF (Customer has gas service AND (User belongs to user group X, Y or A))

If either condition is true, the script is eligible.

You would need to set the following criteria groups in order to support this requirement:

Group No.	Group Description	If Group is True	If Group is False
1	Customer has electric service and the user belongs to user group A, B or C	Eligible	Check next group
2	Customer has gas service and the user belongs to user group X, Y or A	Eligible	Ineligible

The following criteria are required for each of the above groups:

Group 1: Customer has electric service and the user belongs to user group A, B or C				
Seq	Logical Criteria	If Eligibility Criteria is True	If Eligibility Criteria is False	If Insufficient Data
10	Customer has electric service	Check next condition	Group is false	Group is false

20	User belongs to user group A, B or C	Group is true	Group is false	Group is false
Group 2: Customer has gas service and the user belongs to user group X, Y or A				
Seq	Logical Criteria	If Eligibility Criteria is True	If Eligibility Criteria is False	If Insufficient Data
10	Customer has gas service	Check next condition	Group is false	Group is false
20	User belongs to user group X, Y or A	Group is true	Group is false	Group is false

The next section describes how you might configure the specific logical criteria in each of the groups.

Defining Logical Criteria

When you set up an eligibility criterion, you must define two things:

- The field to be compared
- The comparison method

You have the following choices in respect of identifying the *field to be compared* :

- You can execute an algorithm to retrieve a field value from somewhere else in the system.
- Some products may support choosing a characteristic linked to an appropriate object in the system (such as an account or person).

You have the following choices in respect of identifying the *comparison method*:

- You can choose an operator (e.g., >, <, =, BETWEEN, IN, etc.) and a comparison value.
- You can execute an algorithm that performs the comparison (and returns True, False or Insufficient Data). This is also a very powerful feature, but it's not terribly intuitive. We'll present a few examples later in this section to illustrate the power of this approach.

The [Examples Of Script Eligibility Rules](#) provide examples to help you understand this design.

Examples Of Script Eligibility Rules

The topics in this section provide examples about how to set up script eligibility rules.

A Script With A Time Span Comparison

A script that is only eligible for senior citizens has the following eligibility rules:

- Customer class = Residential
- Birth date equates to that of a senior citizen

These rules require only one eligibility group on the script. It would look as follows:

Group No.	Group Description	If Group is True	If Group is False
1	Residential and Senior Citizen	Eligible	Ineligible

The following criteria will be required for this group:

Group 1: Residential, Calif, Senior					
Seq	Field to Compare	Comparison Method	If True	If False	If Insufficient Data

10	Algorithm: retrieve account's customer class	= R	Check next condition	Group is false	Group is false
30	Person characteristic: Date of Birth	Algorithm: True if senior	Group is true	Group is false	Group is false

The first criterion is easy; it calls an algorithm that retrieves a field on the current account. This value, in turn, is compared to a given value. If the comparison results in a True value, the next condition is checked. If the comparison doesn't result in a True value, the **Group is false** (and, the group indicates that if the group is false, the script isn't eligible). Refer to SECF-ACCTFLD in the product documentation for an example of an algorithm type that retrieves a field value from an account.

The last criterion contains a time span comparison. Time span comparisons are used to compare a date to something. In our example, we have to determine the age of the customer based on their birth date. If the resultant age is > 65, they are considered a senior citizen. To pull this off, you can take advantage of a comparison algorithm supplied with the base script as described below.

- **Field to Compare.** The person characteristic in which the customer's birth date is held is selected.
- **Comparison Method.** We chose a comparison algorithm that returns a value of **True** if the related field value (the customer's date of birth) is greater than 65 years (refer to [SECC-TIMESPN](#) for an example of this type of algorithm).

You'll notice that if a value of **True** is returned by the **True if senior** algorithm, the group is true (and we've set up the group to indicate a true group means the script is eligible).

Note: The time span algorithm can be used to compare days, weeks, months, etc. Refer to [SECC-TIMESPN](#) for more information about this algorithm.

A Script With Service Type Comparison

Imagine a script that is only eligible if the current customer has gas service and the user belongs to user groups A, B or C. This script would need the following eligibility rules:

- Customer has gas service
- User belongs to user group A, B or C

These rules require only one eligibility group on the script. It would look as follows:

Group No.	Group Description	If Group is True	If Group is False
1	Has gas service and user is part of user group A, B or C	Eligible	Ineligible

The following criteria are required for this group:

Group 1: Has gas service and user is part of user group A, B or C					
Seq	Field to Compare	Comparison Method	If True	If False	If Insufficient Data
10	Algorithm: check if customer has gas service	= True	Check next condition	Group is false	Group is false
20	Algorithm: check if user belongs to user group A, B or C	= True	Group is true	Group is false	Group is false

Both criteria are similar - they call an algorithm that performs a logical comparison. These algorithms are a bit counter intuitive (but understanding them provides you with another way to implement complex eligibility criteria):

The first criterion works as follows:

- **Field to Compare.** We chose a "field to compare" algorithm that checks if the current account has service agreements that belong to a given set of service types. It returns a value of **True** if the customer has an active service agreement that matches one of the service types in the algorithm. In our example, the "check if customer has gas service" algorithm

returns a value of **True** if the customer has at least one active service agreement whose SA type references the gas service type. The "check if customer has electric service" algorithm is almost identical, only the service type differs.

- Comparison Method. We simply compare the value returned by the algorithm to True and indicate the appropriate response.

The second criterion works similarly:

- Field to Compare. We chose a "field to compare" algorithm that checks if the user belongs to any user group in a set of user groups. It returns a value of **True** if the user belongs to at least one user group defined in parameters of the algorithm. Refer to [SECF-USRNGRP](#) for an example of this type of algorithm.
- Comparison Method. We simply compare the value returned by the algorithm to True and indicate the appropriate response.

Note: Bottom line. The "field to compare" algorithm isn't actually returning a specific field's value. Rather, it's returning a value of **True** or **False**. This value is in turn, compared by the "comparison method" and the group is set to true, false or check next accordingly.

Examples of BPA Scripts

The topics that follow provide examples of BPA scripts related to several business processes. Use the information in this section to form an intuitive understanding of scripts. After attaining this understanding, you'll be ready to design your own scripts.

Note: Importing sample scripts. We have supplied sample scripts in the demonstration database that's shipped with the base product. You can import these samples into your implementation if necessary. Refer to [How to copy a script from the demonstration database](#) for the details.

Set Up/Change Customer Web Self-Service Password

The following is an example of the steps necessary to implement a script that transfers a user to the page on which they can set up / change a customer's web self-service password.

Step No.	Step Type	Text Displayed In Script Area	Additional Information On The Step
10	Perform script	Press OK after the dashboard contains the person in question	Subscript: CI_FINDCUST Note, this step performs a script that contains the steps that ask the user to find the customer on control central.
20	Move data		Source Field Type: Predefined Value Source Field Value: %CONTEXT-PERSONID (note, this is a global variable that contains the ID of the current person) Destination Field Type: Page Data Model Destination Field Name: PER_ID
30	Navigate to a page		Navigation Option: Person - Web Self Service (update)
40	Set focus to a field	Press continue after changing the customer's self service values and saving the changes	Destination Field Name: WEB_PASSWD
50	Perform script		Subscript: CI_SAVECHECK

Note, this step checks if the user remembered to save their changes

60

Display text

Script complete

Note the following about this script:

- Step 10 invokes a "subscript" that asks the user to let the script know when the dashboard contains the person in question.
- Step 20 and 30 are examples of steps step that navigate a user to a specific tab on the person transaction for the person currently displayed. This works because the system automatically passes the person ID from the current page to the destination page.
- Step 40 is an example of a step that moves the insertion point into a field on a page. It also asks the user to save the person. While it's possible to introduce a step that pushes the save button for the user, we recommend that you ask the user to do this. Why? Because validation logic occurs whenever you save an object and this could result in a pop-up if errors or warnings are issued. We feel that it's better for the user to understand why this window is popping up (because they pushed the save button) rather than have the pop-up appear out of thin air.
- Step 50 invokes a "subscript" that reminds the user to save their changes (in case they didn't do this).
- Step 60 is simply good practice. It lets the user know that the script is complete.

Create A Trouble Order Without An Account

The following is an example of the steps necessary to implement a script that creates a trouble order when the user does not know the customer. We have assumed the following about such trouble orders:

- Your organization does not integrate with the outage management integration module. That module describes a different mechanism for handling this logic.
- An **open** customer contact will be created for a "dummy" person that has been set up to record such problems.
- Characteristics on the customer contact will be used to record pertinent issues about the problem (e.g., weather condition, symptom, public danger exists, etc.). These characteristics and their values are defaulted from the customer contact type control table.
- This customer contact will have a log entry that triggers the creation of To Do entry for the central dispatching area. Note, it would be a good idea to schedule the background process that creates such To Do entries (**TD-CCCB**) to run fairly frequently as the trigger date on the customer contact is set to the current date (i.e., we'd like the To Do entry created the next time **TD-CCCB** runs).

Step No	Step Type	Text Displayed In Script Area	Additional Information On The Step
10	Navigate to a page		<p>Navigation Option: Customer Contact - Main (add)</p> <p>Note, we use characteristics to define the trouble order's symptom and danger level. Rather than hardcode these characteristic types and values in the script, we take advantage of the fact that a customer contact type can have default characteristics. These values default onto a customer contact when a customer contact type is populated. Defaulting only occurs when a User Interface Field is populated (as opposed to when a Page Data Model field is populated when no defaulting takes place). In order to populate</p>

a **User Interface Field**, the user must be positioned on the page on which the field is located. And this is why this script initially transfers the user to the Main tab on the customer contact page. If we didn't need to take advantage of defaulting, this script could have navigated to the Characteristics tab (the fields on the other tabs could have been populated even when the Characteristics tab is given focus by simply defining them as Page Data Model fields). We mention this as any page you can avoid navigating to will speed up the execution of the script.

20	Input data	Please describe the problem	Destination Field Type: User Interface Field Destination Field Name: DESCR254
30	Move data		Source Field Type: Predefined Value Source Field Value: 1234567890 (note, this is the ID of the "dummy" person under which this type of customer contact is stored) Destination Field Type: User Interface Field Destination Field Name: PER_ID
40	Move data		Source Field Type: Predefined Value Source Field Value: TRUE Destination Field Type: Page Data Model Destination Field Name: W_CC_STATUS_SW (Note, this is a switch on Customer Contact - Main that a user turns on if they want to indicate a customer contact is open). When you move TRUE to a switch, it turns it on. When you move FALSE to a switch, it turns it off.
50	Move data		Source Field Type: Predefined Value Source Field Value: TO (note, this is the customer class code for this customer contact) Destination Field Type: User Interface Field Destination Field Name: CC_CL_CD
60	Move data		Source Field Type: Predefined Value Source Field Value: NOACCT (note, this is the customer contact type for this customer contact) Destination Field Type: User Interface Field (note, it's important to use this field type rather the Page Data Model . This is because we want the

			characteristics associated with this customer contact type to default onto the Characteristics tab page and defaulting only happens when User Interface Fields are populated)
			Destination Field Name: CC_TYPE_CD
70	Move data		Source Field Type: Predefined Value Source Field Value: Generated by trouble order without account script Destination Field Type: User Interface Field Destination Field Name: CC_LOG:0\$CC_LOG_CONTENT
80	Move data		Source Field Type: Predefined Value Source Field Value: 20 (note, this is the flag value for Send to Role) Destination Field Type: User Interface Field Destination Field Name: CC_LOG:0\$CC_REMINDER_FLG
90	Move data		Source Field Type: Predefined Value Source Field Value: TOWOACCT (note, this is the To Do role that will receive the To Do entry informing them of this trouble order) Destination Field Type: User Interface Field Destination Field Name: CC_LOG:0\$ROLE_ID
100	Move data		Source Field Type: Predefined Value Source Field Value: %CURRENT-DATE Destination Field Type: User Interface Field Destination Field Name: CC_LOG:0\$TRIGGER_DT
110	Navigate to a page		Navigation Option: Customer Contact - Characteristics (update)
120	Set focus to a field	Press <i>Continue</i> after confirming the characteristic values and saving the customer contact	Destination Field Name: CC_CHAR:0\$CHAR_TYPE_CD
130	Move data		Source Field Type: Predefined Value Source Field Name: %SAVE-REQUIRED Destination Field Type: Temporary Storage Destination Field Name: SAVE_NEEDED
140	Conditional Branch		Compare Field Type: Temporary Storage

			Compare Field Name: SAVE_NEEDED Condition: = Comparison Field Type: Predefined Value Comparison Field Name: FALSE If TRUE, Go To Step: 160 If FALSE, Go To Step: 140
150	Set focus to a field	You have not saved this information! Press <i>Continue</i> after saving.	Destination Field Name: IM_SAVE (note, this positions the cursor on the save button)
160	Go to a step		Next step: 120
170	Display text	Script complete	
180	Height		Script Window Height: 0 Height Unit: Pixels

Note the following about this script:

- Step 10 navigates the user to the customer contact page in add mode.
- Step 20 causes a user to be prompted to enter a description of the problem. This description is stored in the customer contact's description field.
- Steps 30 through 50 populate fields on Customer Contact - Main with "hard-coded" values (thus saving the user the effort of entering this information). Take special note of step 50 - we are taking advantage of the fact that a customer contact type's default characteristics are copied to a customer contact when a user specifies a given contact type. It's important to note that defaulting only happens when you populate a **User Interface Field** (as opposed to a **Page Data Model** field).
- Steps 60 through 90 populate fields in the log grid on the same tab page.
- Steps 100 and 110 transfer users to Customer Contact - Characteristics where they are prompted to confirm the characteristics that were defaulted when the customer contact type was populated.
- Steps 120 through 160 are the same as the previous example.

Add A New Person To An Account

The following is an example of the steps necessary to implement a script that adds a new person to an existing account. This is a sophisticated script as it contains examples of populating scrolls and grids as well as using multiple transactions to implement a business process.

Step No	Step Type	Text Displayed In Script Area	Additional Information On The Step
5	Label		Identify the correct account
10	Prompt user	Is the existing account currently displayed in the dashboard?	Prompt Type: Button(s) First Prompt Value - Text: Yes , Next Step: 40 Second Prompt Value - Text: No , Next Step: 20
20	Navigate to a page		Navigation Option: Control Central - Main
30	Set focus to a field	Press <i>Continue</i> after you've selected the customer (note, see How To Use HTML Tags And Spans In Text for more information about the <i> notation)	Destination Field Name: ENTITY_NAME

40	Move data		Source Field Type: Predefined Value Source Field Value: %CONTEXT-ACCOUNTID (note, this is a <i>global variable</i> that contains the ID of the current account) Destination Field Type: Temporary Storage Destination Field Name: SAVED_ACCT_ID
50	Conditional Branch		Compare Field Type: Temporary Storage Compare Field Name: SAVED_ACCT_ID Condition: = Comparison Field Type: Predefined Value Comparison Field Name: %BLANK If TRUE, Go To Step: 60 If FALSE, Go To Step: 80
60	Display text	Please select a customer, the dashboard isn't populated with an account (note, see How To Use HTML Tags And Spans In Text for more information about the notation)	
70	Go to a step		Next step: 20
80	Display text	You will be adding a new customer to account %SAVED_ACCT_ID	
85	Label		Enter the Person's name and primary ID
90	Navigate to a page		Navigation Option: Person -Main (add)
100	Move data		Source Field Type: Predefined Value Source Field Value: FALSE Destination Field Type: Page Data Model Destination Field Name: ADD_ACCT_SW (Note, this is a switch on Person - Main that a user turns on if they want to both add a person AND an account when they save the new person - we don't want to add an account when we add the new person so we set it to FALSE (i.e., we turn the switch off.)
110	Input data	Enter the new person's name in the format "Last Name,First Name" (e.g., Smith,Patricia)	Destination Field Type: User Interface Field Destination Field Name: PER_NAME:0\$ENTITY_NAME
120	Input data	Enter the new person's Social Security Number in the format 999-99-9999	Destination Field Type: User Interface Field Destination Field Name: PER_IDENTIFIER:0\$PER_ID_NBR Note, this step works because the identifier type was defaulted

from the installation record and therefore this step only requires the user to enter the person's social security number. Also note, the user doesn't have to enter the SSN in the format shown because this step populates a **User Interface Field**, which automatically applies the formatting for the respective ID type.

125	Label		Enter one or more phone numbers
130	Prompt user	Would you like to define a phone number?	Prompt Type: Button(s) First Prompt Value - Text: Home Phone (default) Next Step: 140 Second Prompt Value - Text: Business Phone , Next Step: 180 Third Prompt Value - Text: Finished Entering Phone Numbers , Next Step: 220
140	Press a button		Button Name: PER_PHONE:0\$pPhones_ADD_BUTTON (note, this causes the add button to be pressed for the first row in the phone grid)
150	Move data		Source Field Type: Predefined Value Source Field Value: HOME Destination Field Type: User Interface Field (Note, we used this data type rather than Page Data Model because we want to trigger the defaulting that takes place when a phone type is selected on the user interface (i.e., the phone format is shown on the page)). Destination Field Name: PER_PHONE:x\$PHONE_TYPE_CD Note, the "x" notation indicates the current row in the array will be populated.
160	Input data	Enter the new person's home phone number in the format (415) 345-2392	Destination Field Type: User Interface Field Destination Field Name: PER_PHONE:x\$PHONE Note, because a User Interface Field is populated, the default logic associated with this field will be triggered. The default logic for this field formats the input phone number using the algorithm defined on the phone type. This means the user doesn't have to enter the phone number in the designated format, they could enter all numbers and let the system format it.
170	Go to a step		Next step: 130 (this loops to ask them if they want to add another phone number)
180	Press a button		Button Name: PER_PHONE:0\$pPhones_ADD_BUTTON (this causes the add

			button to be pressed for the first row in the phone grid)
190	Move data		Source Field Type: Predefined Value Source Field Name: not applicable Source Field Value: BUSN Destination Field Type: User Interface Field Destination Field Name: PER_PHONE:x\$PHONE_TYPE_CD (Note, the "x" notation indicates the current row in the array will be populated)
200	Input data	Enter the new person's business phone number in the format (415) 345-2392	Destination Field Type: User Interface Field Destination Field Name: PER_PHONE:x\$PHONE
210	Go to a step		Next step: 130 (this loops to ask them if they want to add another phone number)
220	Press a button		Button Name: PER_PHONE:0\$pPhones_DEL_BUTTON (Note, this removes the blank row from the person phone grid so we don't get a validation error)
225	Label		Enter the Person's correspondence info
230	Navigate to a page		Navigation Option: Person - Correspondence Info (update)
240	Set focus to a field	Press <i><i>Continue</i></i> after defining correspondence information for the new person (if any). Don't forget to SAVE the new person (note, see How To Use HTML Tags And Spans In Text for more information about the <i><i></i> and <i></i> notations)	Destination Field Name: OVRD_MAIL_NAME1
250	Conditional Branch		Compare Field Type: Page Data Model Compare Field Name: PER_ID Condition: = Comparison Field Type: Predefined Value Comparison Field Name: %BLANK If TRUE, Go To Step: 260 If FALSE, Go To Step: 280
260	Display text	 The new person hasn't been added, please press the save button to add the new person 	
270	Go to a step		Next step: 240
275	Label		Store person, navigate to account page and link to account
280	Move data		Source Field Type: Page Data Model Source Field Name: PER_ID

			Destination Field Type: Temporary Storage Destination Field Name: NEW_PERSON_ID Note, we are saving the person ID as we'll need to populate it on the account / person information later in the script.
290	Move data		Source Field Type: Temporary Storage Source Field Name: SAVED_ACCT_ID Destination Field Type: Page Data Model Destination Field Name: ACCT_ID Note, this step is done in anticipation of the following step that transfers the user to the account page. This step simply moves the account ID saved above to some place on the page. The name of the receiving field is important; it must be the same as one of the fields defined on the Navigation Option used to transfer to the destination transaction (this navigation option is defined on the next step). To find the appropriate field name for any transaction, display the navigation option in question.
300	Navigate to a page		Navigation Option: Account - Persons (update)
310	Press a button		Button Name: IM_Sect2_AddButton
320	Move data		Source Field Type: Temporary Storage Source Field Name: NEW_PERSON_ID Destination Field Type: User Interface Field Destination Field Name: ACCT_PER\$PER_ID
330	Set focus to a field	Press <i>Continue</i> after defining the new person's relationship type. Don't forget to SAVE the changes to the account	Destination Field Name: ACCT_PER\$ACCT_REL_TYPE_CD
340	Move data		Source Field Type: Predefined Value Source Field Name: %SAVE-REQUIRED Destination Field Type: Temporary Storage Destination Field Name: SAVE_NEEDED
350	Conditional Branch		Compare Field Type: Temporary Storage Compare Field Name: SAVE_NEEDED Condition: =

			Comparison Field Type: Predefined Value
			Comparison Field Name: FALSE
			If TRUE, Go To Step: 380
			If FALSE, Go To Step: 360
360	Set focus to a field	You have not saved this information! Press <i>Continue</i> after saving.	Destination Field Name: IM_SAVE (note, this positions the cursor on the save button)
370	Go to a step		Next step: 340
380	Display text	Script complete	
390	Height		Script Window Height: 0 Height Unit: Pixels

Note the following about this script:

- Steps 10 through 70 are a technique to make sure the user has selected an account.
- Step 80 is subjective (but it demonstrates [How To Substitute Variables In Text](#)).
- In step 90, we navigate to Person - Main in add mode.
- Steps 130 through 220 illustrate a technique that can be used to capture phone numbers. A much easier method would be to use a **Set focus** step and ask the user to fill in the applicable phone numbers.
- Steps 230 through 240 transfer the user to the next tab on the person page where they are prompted to enter additional correspondence information.
- Step 280 saves the new person ID in temporary storage. This is done so that we can populate it when we return to the account page. Refer to [How To Name Temporary Storage Fields](#) for more information.
- Step 290 and 300 illustrates the technique used to navigate to a page (see the note in the step for more information).
- Steps 310 and 320 populate the recently added person ID in the account - person scroll.
- Step 330 asks the user to define additional account / person information. You could use several steps to do this as you could walk the user through each field. See [Payment Extensions](#) for an example of a script that walks a user through the fields on a page.
- Steps 340 through 390 are classic end-of-script steps.

Reprint A Bill - Long Version

The following is an example of a script that causes a bill to be reprinted. This script prompts the user to select a bill and then sets up a new bill routing to cause it to be reprinted. This script contains examples of:

- Transferring to a page where the transfer may cause a search window to appear. In this example, we transfer the user to the bill page and if the account has multiple bills, the search page appears; if they have only one bill, the bill is automatically selected.
- Populating information that resides in a scroll (as opposed to a grid).
- Concatenating information into a message.

We have also supplied an alternate version of this script that has fewer steps (see [Reprint A Bill - Short Version](#)). Take the time to contrast these two versions before you decide how to construct your scripts.

Step No.	Step Type	Text Displayed In Script Area	Additional Information On The Step
5	Label		Identify the correct account
10	Prompt user	Is the customer associated with the bill currently displayed in the dashboard?	Prompt Type: Button(s)

			First Prompt Value - Text: Yes (default turned on), Next Step: 40 Second Prompt Value - Text: No , Next Step: 20
20	Navigate to a page		Navigation Option: Control Central - Main
30	Set focus to a field	Press <i>Continue</i> after you've selected the customer	Destination Field Name: ENTITY_NAME
40	Move data		Source Field Type: Predefined Value Source Field Value: %CONTEXT- ACCOUNTID (note, this is a <i>global variable</i> that contains the ID of the current account) Destination Field Type: Temporary Storage Destination Field Name: SAVED_ ID
50	Conditional Branch		Compare Field Type: Temporary Storage Compare Field Name: SAVED_ ID Condition: = Comparison Field Type: Predefined Value Comparison Field Name: %BLANK If TRUE, Go To Step: 60 If FALSE, Go To Step: 90
60	Display text	The dashboard isn't populated with an account.</ font> Please select a customer before continuing.	
70	Go to a step		Next step: 20
75	Label		Navigate to Bill Routing page and select desired bill
90	Move data		Source Field Type: Temporary Storage Source Field Name: SAVED_ID Destination Field Type: Page Data Model Destination Field Name: ACCT_ ID Note, this step is done in anticipation of a subsequent step that transfers the user to the bill page. This step simply moves the account ID saved above to some place on the page. The name of the receiving field is important; it must be the same as one of the fields defined on the Navigation Option used to transfer to the destination transaction (this navigation option is defined on the next step). To find the appropriate field name for any transaction, display the navigation option in question.
100	Navigate to a page		Navigation Option: Bill - Routing (update)

110	Prompt user	Press OK after a bill has been selected	Prompt Type: Button(s) First Prompt Value - Text: OK , Next Step: 120
115	Label		User should confirm the bill routing details and Save.
120	Move data		Source Field Type: Page Data Model Source Field Name: ENDING_BAL Destination Field Type: Temporary Storage Destination Field Name: ENDING_BALANCE
130	Move data		Source Field Type: Page Data Model Source Field Name: COMPLETE_DTTM Destination Field Type: Temporary Storage Destination Field Name: COMPLETION_DTTM
140	Press a button		Button Name: IM_ScrollCtrl_addBtn
150	Set focus to a field	This bill for %ENDING_BALANCE was completed on %COMPLETION_DTTM. Please confirm / change the name and address of the bill.	Destination Field Name: BILL_RTG\$ENTITY_NAME1
160	Set focus to a field	Press the Save button (Alt+S) to save the bill routing information	Destination Field Name: IM_SAVE
165	Label		Verify Save
170	Move data		Source Field Type: Predefined Value Source Field Name: %SAVE-REQUIRED Destination Field Type: Temporary Storage Destination Field Name: SAVE_NEEDED
180	Conditional Branch		Compare Field Type: Temporary Storage Compare Field Name: SAVE_NEEDED Condition: = Comparison Field Type: Predefined Value Comparison Field Name: FALSE If TRUE, Go To Step: 210 If FALSE, Go To Step: 190
190	Set focus to a field	You have not saved this information! Press <i>Continue</i> after saving.	Destination Field Name: IM_SAVE (note, this positions the cursor on the save button)
200	Go to a step		Next step: 170
205	Label		Display confirmation
210	Move data		Source Field Type: Page Data Model

Source Field Name: **BILL_RTG
\$BATCH_CD**
 Destination Field Type:
Temporary Storage
 Destination Field Name: **BATCH_
CODE**

220	Display text	Script complete. The bill will be sent to the recipient the next time the %BATCH_CODE process executes
-----	---------------------	--

Reprint A Bill - Short Version

The following is an example of a script that causes a bill to be reprinted. This script prompts the user to select a bill and then sets up a new bill routing to cause it to be reprinted. This script is an alternate version of [Reprint A Bill - Long Version](#). Take the time to contrast these two versions before you decide how to construct your scripts.

Step No	Step Type	Text Displayed In Script Area	Additional Information On The Step
5	Label		Prompt user for account whose bill should be reprinted.
10	Prompt user	Select an option and then press Continue	Prompt Type: Dropdown First Prompt Value - Text: View bills for the customer in the dashboard (default turned on), Next Step: 20 Second Prompt Value - Text: View bills for a different customer, Next Step: 40
20	Move data		Source Field Type: Predefined Value Source Field Value: %CONTEXT-ACCOUNTID (note, this is a <i>global variable</i> that contains the ID of the current account) Destination Field Type: Page Data Model Destination Field Name: ACCT_ID Note, this step is done in anticipation of step 50, which transfers the user to the bill page. This step simply moves the account ID saved above to some place on the page. The name of the destination field is important; it must be the same as one of the fields defined on the Navigation Option used to transfer to the destination transaction (this navigation option is defined on step 50). To find the appropriate field name for any transaction, display the navigation option in question.
30	Go to a step		Next step: 50
40	Move data		Source Field Type: Predefined Value Source Field Value: %BLANK (note, this is a <i>global variable</i> that contains the a blank value)

Destination Field Type: **Page Data Model**

Destination Field Name: **ACCT_ID**

Note, this step is done in anticipation of the following step that transfers the user to the bill page. This step simply resets the account ID that will be passed to the bill search page. The name of the destination field is important; it must be the same as one of the fields defined on the Navigation Option used to transfer to the destination transaction (this navigation option is defined on the next step). To find the appropriate field name for any transaction, display the navigation option in question.

45	Label		Navigate to Bill Routing page and select desired bill
50	Navigate to a page		Navigation Option: Bill - Routing (update)
60	Prompt user	Press OK after a bill has been selected	Prompt Type: Button(s) First Prompt Value - Text: OK , Next Step: 70
65	Label		User should confirm the bill routing details and Save.
70	Move data		Source Field Type: Page Data Model Source Field Name: ENDING_BAL Destination Field Type: Temporary Storage Destination Field Name: ENDING_BALANCE
80	Move data		Source Field Type: Page Data Model Source Field Name: COMPLETE_DTTM Destination Field Type: Temporary Storage Destination Field Name: COMPLETION_DTTM
90	Press a button		Button Name: IM_ScrollCtrl_addBtn
100	Set focus to a field	This bill for %ENDING_BALANCE was completed on %COMPLETION_DTTM . Please confirm / change the name and address of the bill.	Destination Field Name: BILL_RTGS\$ENTITY_NAME1
110	Set focus to a field	Press the Save button (Alt+S) to save the bill routing information	Destination Field Name: IM_SAVE
115	Label		Verify Save
120	Move data		Source Field Type: Predefined Value Source Field Name: %SAVE-REQUIRED Destination Field Type: Temporary Storage

			Destination Field Name: SAVE_NEEDED
130	Conditional Branch		Compare Field Type: Temporary Storage Compare Field Name: SAVE_NEEDED Condition: = Comparison Field Type: Predefined Value Comparison Field Name: FALSE If TRUE, Go To Step: 160 If FALSE, Go To Step: 140
140	Set focus to a field	You have not saved this information! Press <i>Continue</i> after saving.	Destination Field Name: IM_SAVE (note, this positions the cursor on the save button)
150	Go to a step		Next step: 120
205	Label		Display confirmation
160	Move data		Source Field Type: Page Data Model Source Field Name: BILL_RTG \$BATCH_CD Destination Field Type: Temporary Storage Destination Field Name: BATCH_CODE
170	Display text	Script complete. The bill will be sent to the recipient the next time the %BATCH_CODE process executes	

Payment Extensions

The following is an example of a script that guides a user through the payment plan options. This script executes the following rules:

- If the customer's customer class is R (residential)
 - If their credit rating is <= 600, they must pay immediately; no payment extensions are allowed
 - Else, the user is given the choice of setting up a payment arrangement or extending the customer's next credit review date (i.e., the date on which the account debt monitor will review the customer's debt)
- If the customer's customer class is not R (residential)
 - If their credit rating is <= 700, they must pay immediately; no payment extensions are allowed
 - Else, the user is given the choice of setting up a pay plan or extending the customer's next credit review date (i.e., the date on which the account debt monitor will review the customer's debt)

Step No	Step Type	Text Displayed In Script Area	Additional Information On The Step
10	Perform script		Subscript: CI_FINDCUST Note, this step performs a script that contains the steps that ask the user to find the customer on control central.

20	Invoke function	<p>Function: GETCCCR (retrieves an account's customer class and credit rating)</p> <p>If Successful, Go To Step: 40</p> <p>If Error, Go To Step: 30</p> <p>Send Field: Temporary Storage / SAVED_ACCT_ID</p> <p>Receive Field 1: Temporary Storage / CUST_CL_CD</p> <p>Receive Field 2: Temporary Storage / TOT_CR_RATING_PTS</p> <p>Note, this step invokes a function that returns the account's credit rating and customer class.</p>
30	Transfer control	<p>Subscript: CI_FUNCERR</p> <p>Note, this step transfers control to a script that displays the error information and stops.</p>
40	Mathematical operation	<p>Base Field Type: Temporary Storage ></p> <p>Base Field Name: TOT_CR_RATING_PTS</p> <p>Math Operation: +</p> <p>Math Field Type: Predefined Value</p> <p>Math Field Value: 0</p> <p>Note, this step converts the credit rating held in string into a number so that it can be used in later mathematical operations that compare the credit rating to threshold values.</p>
50	Conditional Branch	<p>Compare Field Type: Page Data Model</p> <p>Compare Field Name: CUST_CL_CD</p> <p>Condition: =</p> <p>Comparison Field Type: Predefined Value</p> <p>Comparison Field Name: R</p> <p>If TRUE, Go To Step: 60</p> <p>If FALSE, Go To Step: 250</p>
60	Conditional Branch	<p>Compare Field Type: Page Data Model</p> <p>Compare Field Name: TOT_CR_RATING_PTS</p> <p>Condition: <=</p> <p>Comparison Field Type: Predefined Value</p> <p>Comparison Field Name: 600</p> <p>If TRUE, Go To Step: 120</p> <p>If FALSE, Go To Step: 140</p>
70	Label	Residential Customer, Credit Rating <= 601
120	Display Text	This customer's credit rating is less than or equal to 600 and therefore payment

is due immediately (no payment extensions are possible)

130	Go to a step		Next step: 400
140	Prompt user	Choose between extending the date on which the system will examine this customer's debt OR adding a payment arrangement	Prompt Type: Button(s) First Prompt Value - Text: Extend collection date (default value), Next Step: 150 Second Prompt Value - Text: Setup a payment arrangement , Next Step: 180
145	Label		Postpone the credit review date
150	Navigate to a page		Navigation Option: Account - C&C (update)
151	Move data		Source Field Type: Predefined Value Source Field Value: %CURRENT-DATE Destination Field Type: User Interface Field Destination Field Name: POSTPONE_CR_RVW_DT Note, the next step will add 5 days to this field value (thus setting the review date to 5 days in the future).
152	Mathematical operation		Base Field Type: User Interface Field Base Field Name: POSTPONE_CR_RVW_DT Math Operation: + Math Field Type: Predefined Value Math Field Value: 5 days
160	Set focus to a field	Please review the new credit review date and then save the change	Destination Field Name: POSTPONE_CR_RVW_DT
170	Go to a step		Next step: 400
175	Label		Create payment arrangement.
180	Navigate to a page		Navigation Option: Payment Arrangement - Main (add)
190	Set focus to a field	Select the debt to be transferred to the payment arrangement. You do this by turning on the checkboxes adjacent to the Arrears Amounts FOR EACH CANDIDATE SA IN THE SCROLL	Destination Field Name: SA_ARREARS:x\$CHECKED_FOR_PA_SW
200	Set focus to a field	Press <i>Continue</i> after you've considered the debt on each service agreement in the scroll	Destination Field Name: IM_SectArrow_RtArrow
209	Move data		Source Field Type: Predefined Value Source Field Value: 6 Destination Field Type: User Interface Field Destination Field Name: INSTALLMENT

Note, this step defaults a value of **6** in the Installments field. Because we used the **User Interface Field** type, the payment amount is automatically calculated for the user as this is the default logic for this field on this page. If we'd used a field type of **Page Data Model**, the default logic would not execute.

210	Set focus to a field	Select the number of installments (a value of 6 was defaulted)	Destination Field Name: INSTALLMENT
220	Move data		Source Field Type: Predefined Value Source Field Value: CA Destination Field Type: User Interface Field Destination Field Name: CIS_DIVISION
225	Set focus to a field	Specify an SA Type for the payment arrangement	Destination Field Name: SA_TYPE_CD
230	Set focus to a field	Press the Create button to create a new payment arrangement service agreement and transfer the selected debt to it	Destination Field Name: CREATE_SW
240	Go to a step		Next step: 400
245	Label		Non-residential customer with credit rating less than or equal to 700 must pay now. If the CR is over 700, choose between extending date and creating a pay plan.
250	Conditional Branch		Compare Field Type: Page Data Model Compare Field Name: TOT_CR_RATING_PTS Condition: <= Comparison Field Type: Predefined Value Comparison Field Name: 700 If TRUE, Go To Step: 260 If FALSE, Go To Step: 280
260	Display Text	This customer's credit rating is less than or equal to 700 and therefore payment is due immediately (no pay plan is possible)	
270	Go to a step		Next step: 400
280	Prompt user	You can choose between extending the date on which the system will examine this customer's debt OR creating a pay plan	Prompt Type: Button(s) First Prompt Value - Text: Extend collection date , Next Step: 290 Second Prompt Value - Text: Setup a pay plan , Next Step: 320
285	Label		Postpone the credit review date
290	Navigate to a page		Navigation Option: Account - C&C (update)
300	Set focus to a field	Please enter the new credit review date (set it up to 5 days	Destination Field Name: POSTPONE_CR_RVW_DT

in the future) and then save the change

310	Go to a step		Next step: 400
315	Label		Add a payment plan
320	Navigate to a page		Navigation Option: Pay Plan - Main (add)
330	Set focus to a field	Select the Pay Plan Type	Destination Field Name: PP_TYPE_CD
340	Prompt User	Who is responsible for making these payments?	Prompt Type: Button(s) First Prompt Value - Text: Customer , Next Step: 370 Second Prompt Value - Text: Third party , Next Step: 350
350	Move data		Source Field Type: Predefined Value Source Field Value: TRUE (note, this is how you turn a checkbox on) Destination Field Type: User Interface Field Destination Field Name: THRD_PTY_SW
360	Set focus to a field	Select the Pay Plan Type	Destination Field Name: THRD_PTY_PAYOR_CD
370	Set focus to a field	Select a Pay Method	Destination Field Name: PAY_METH_CD
380	Set focus to a field	Enter one or more scheduled payments. The Total Amount of the scheduled payments should cover the customer's Delinquent Debt if you want the pay plan to protect the customer from additional credit and collection activity.	Destination Field Name: PPS:\$PP_SCHED_DT
390	Set focus to a field	Press the Save button (Alt+S) to save the pay plan	Destination Field Name: IM_SAVE
395	Label		Confirm save
400	Move data		Source Field Type: Predefined Value Source Field Name: %SAVE-REQUIRED Destination Field Type: Temporary Storage Destination Field Name: SAVE_NEEDED
410	Conditional Branch		Compare Field Type: Temporary Storage Compare Field Name: SAVE_NEEDED Condition: = Comparison Field Type: Predefined Value Comparison Field Name: FALSE If TRUE, Go To Step: 440 If FALSE, Go To Step: 420
420	Set focus to a field	You have not saved this information! Press Continue after saving.	Destination Field Name: IM_SAVE (note, this positions the cursor on the save button)

430	Go to a step	Next step: 400
440	Navigate to a page	Navigation Option: Control Central - Pay Pan (update)
450	Display text	Script complete, please confirm the customer's credit and collection's information

The Big Picture Of Server-Based Scripts

Fastpath: Refer to [The Big Picture Of Scripts](#) to better understand the basic concept of scripts.

Server-based scripts allow an implementation to configure backend business processes. The system supports two types of server-based scripts, **Plug-In** scripts and **Service** scripts.

- Plug-in scripts allow an implementation to develop routines that are executed from the system's various plug-in spots without coding. For example, an implementation could configure a plug-in script that is executed every time an adjustment of a given type is frozen.
- Service scripts allow an implementation to develop common routines that are invoked from both front-end and back-end services. For example, an implementation could create a service script that terminates an account's automatic payment preferences. This service script could be invoked from a BPA script initiated by an end-user when a customer asks to stop paying automatically, and it could also be executed from a plug-in script if a customer fails to pay their debt on time.

The topics in this section describe background topics relevant to server-based scripts.

Plug-In Scripts

Note: This section assumes you are familiar with the notion of plug-in spots (algorithm entities) and plug-ins. See [The Big Picture Of Algorithms](#) for more information.

Rather than write a java program for a plug-in spot, you can create a plug-in using the scripting "language". In essence, this is the only difference between a program-based plug-in and a script-based one. Obviously, this is a significant difference as it allows you to implement plug-ins without programming (and compilers).

The following topics describe basic concepts related to plug-in scripts.

A Plug-In Script's API

Like program-based plug-ins, plug-in scripts:

- Run on the application server
- Have their API (input / output interface) defined by the plug-in spot (i.e., plug-in scripts don't get to declare their own API)
- Can only be invoked by the "plug-in spot driver"

The best way to understand a plug-in script's API is to use the **View Plug-In Script Data Area** hyperlink on [Script - Data Area](#) to view its parameters data area schema.



Figure 1: Plug-In Data Area

Notice the two groups: soft and hard. If you are familiar with plug-in spots, you'll recognize these as the classic **soft** and **hard** parameters:

- The **soft** parameters are the values of the parameters defined on the algorithm. Notice they are not named - if you want to reference them in your plug-in script, you must do it by position (this is equivalent to what a Java programmer does for plug-ins written in Java).
- The **hard** parameters are controlled by the plug-in spot (i.e., the algorithm entity). Notice that this plug-in spot has a single input parameter called " **adjustment/id**". Also notice the **use=** attribute - this shows that this parameter is input-only (i.e., you can't change it in the plug-in script).

Note: XPath. You can click on an element name to see the XPath used to reference the element in your script.

Setting Up Plug-In Scripts

You can write plug-in scripts for all plug-in spots that have been Java-enabled. The following points describe how to implement a plug-in script:

- Compose your plug-in *script*, associating it with the appropriate algorithm entity (plug-in spot).
- Create a new algorithm type for the respective algorithm entity, referencing your plug-in script as the program to carry out the algorithm type's function. Only plug-in scripts associated with the algorithm entity may be referenced on the algorithm type.
- Set up an algorithm for the respective algorithm type and plug it in where applicable. Refer to [Setting Up Algorithm Types](#) for more information.

Note: No plug-in scripts are shipped with the base-package.

Service Scripts

BPA scripts run on the client's browser and guide the end-users through business processes. Service scripts run on the application server and perform server-based processing for *BPA scripts*, *zones* and more. You may want to think of a service script as a common routine that is set up via the scripting (rather than programming).

The following topics describe basic concepts related to service scripts.

A Service Script's API

As with any common routine, a service script must declare its input / output parameters (i.e., its API). A service script's API is defined on its [schema](#).

Note: Schema Definition Tips. A context sensitive "Script Tips" zone appears when you open the [Script](#) page to assist you with the schema definition syntax. The zone provides a complete list of the XML nodes and attributes available to you when you construct a schema.

Invoking Service Scripts

Any type of script may [invoke a service script](#):

- A BPA script may invoke a service script to perform server-based processing.
- Plug-in scripts may invoke a service script (like a "common routine").
- A service script may call another service script (like a "common routine").

Map zones may be configured to invoke service scripts to obtain the data to be displayed. Refer to [Map Zones](#) for more information.

[XAI incoming messages](#) support interaction with service scripts allowing the outside world to interact directly with a service script.

You can also invoke a service script from a Java class.

Debugging Server-Based Scripts

The server can create log entries to help you debug your server scripts. These logs are only created if you do the following:

- Start the system in **?debug=true** mode
- Turn on the **Global debug** checkbox in the upper corner of the browser. When you click this check box, a pop-up appears asking you what you want to trace - make sure to check box that causes script steps to be traced.

The logs contain a great deal of information including the contents of the referenced data area for **Move data**, **Invoke business object**, **Invoke business service** and **Invoke service script** steps.

You can view the contents of the logs by pressing the **Show User Log** button appears at the top of the browser.

Please note that all log entries for your user ID are shown (so don't share user id's!).

How To Copy A Script From The Demonstration Database

Caution: If you are not familiar with the concepts described in the [ConfigLab](#) chapter, this section will be difficult to understand. Specifically, you need to understand how a **Compare** database process is used to copy objects between two databases. Please take the time to familiarize yourself with this concept before attempting to copy a script from the demonstration database.

The demonstration database contains several sample scripts. The topics in this section describe how to copy any / all of the demonstration scripts to your implementation's database.

If You Work In A Non-English Language

The demonstration database is installed in English only. If you work in a non-English language, you must execute the **NEWLANG** background process on the demonstration database before using it as a **Compare Source** environment. If you work in a supported language, you should apply the language package to the demonstration database as well.

If you don't execute **NEWLANG** on the demonstration database, any objects copied from the demonstration database will not have language rows for the language in which you work and therefore you won't be able to see the information in the target environment.

One Time Only - Set Up A DB Process To Copy Scripts

You need a "copy scripts" *database process* (DB process) configured in the target database (e.g., your implementation's database). This DB process must have the following instructions:

- A primary instruction for the script *maintenance object* (MO)
- A child instruction for each MO referenced as a foreign key on a script (i.e., algorithm, navigation option, and icon reference)

The demonstration database contains such a DB process; it's called **CI_COPSC**. In order to copy scripts from the demonstration database, you must first copy this DB process from the demonstration database.

Caution: The remainder of this section is confusing as it describes a DB process that copies another DB process. Fortunately, you will only have to do the following once. This is because after you have a "copy scripts" DB process in your target database, you can use it repeatedly to copy scripts from the demonstration database.

You can copy the **CI_COPSC** DB process from the demonstration database by submitting the **CL-COPDB** *background process* in your target database. When you submit this process, you must supply it with an *environment reference* that points to the demonstration database. If you don't have an environment reference configured in your target database that references the demonstration database, you must have your technical staff execute a registration script that sets up this environment reference. Refer to *Registering ConfigLab Environments* for more information.

CL-COPDB is initially delivered ready to copy *every* DB process that is prefixed with **CI_** from the source database (there are numerous sample DB processes in the demonstration database and this process copies them all). If you only want to copy the **CI_COPSC** DB process, add a *table rule* to the primary instruction of the **CL-COPDB** *database process* to only copy the **CI_COPSC** DB process. The remainder of this section assumes you have added this table rule.

When the **CL-COPDB** process runs, it highlights differences between the "copy scripts" DB process in your source database and the target database. The first time you run this process, it creates a root object in the target database to indicate the **CI_COPSC** DB process will be added to your target database. You can use the *Difference Query* to review these root objects and **approve** or **reject** them.

Note: Automatic approval. When you submit **CL-COPDB**, you can indicate that all root objects should be marked as **approved** (thus saving yourself the step of manually approving them using *Difference Query*).

After you've approved the root object(s), submit the **CL-APPCH** batch process to change your target database. You must supply the **CL-APPCH** process with two parameters:

- The DB Process used to create the root objects (**CL-COPDB**)
- The environment reference that identifies the source database (e.g., the demonstration database)

Run The Copy Scripts DB Process

After you have a "copy scripts" DB process in the target database, you should add a *table rule* to its primary instruction to define which script(s) to copy from the demonstration database. For example, if you want to copy a single script called **CL_WSS**, you'd have a table rule that looks as follows

- Table: **CL_SCR**
- Override Condition: **#CL_SCR.SCR_CD='CL_WSS'**

If you do not introduce this table rule to the primary instruction of the DB process, ALL scripts in the demonstration database will be copied to the target database (and this may be exactly what you want to do).

Note: Tables rules are WHERE clauses. A table rule is simply the contents of a WHERE clause except the tables names are prefixed with #. This means that you can have table rules that contain LIKE conditions, subqueries, etc.

At this point, you're ready to submit the background process identified on your "copy scripts" DB process. This background process highlights the differences between the scripts in the demonstration database and the target database (the target database is the environment in which you submit the background process).

Note: The background process you submit is typically named the same as the DB process that contains the rules. If you used the **CL-COPDB** background process to transfer the "copy scripts" DB process from the demo database, it will have also configured a batch control and linked it to the "copy scripts" DB process. This batch control has the same name as its related DB process (this is just a naming convention, it's not a rule). This means that you'd submit a batch control called **CL_COPSC** in order to execute the **CL_COPSC** DB process.

When you submit the **CL_COPSC** background process, you must supply it with an *environment reference* that points to the source database (i.e., the demonstration database).

When the **CL_COPSC** process runs, it simply highlights differences between the scripts in your source database and the target database. It creates a root object in the target database for every script that is not the same in the two environments (actually, it only concerns itself with scripts that match the criteria on the table rule described above). You can use the *Difference Query* to review these root objects and **approve** or **reject** them.

Note: Auto approval. When you submit **CL_COPSC**, you can indicate that all root objects should be marked as **approved** (thus saving yourself the step of manually approving them).

After you've approved the root object(s) associated with the script(s) that you want copied, submit the **CL-APPCH** batch process to cause your target database to be changed. You must supply the **CL-APPCH** process with two parameters:

- The DB process of the "copy scripts" DB process (i.e., **CL_COPSC**)
- The environment reference that identifies the source database (i.e., the demonstration database)

Maintaining Scripts

The script maintenance transaction is used to maintain your scripts. The topics in this section describe how to use this transaction.

Fastpath: Refer to *The Big Picture Of Scripts* for more information about scripts.

Script - Main

Use this page to define basic information about a script. Open this page using **Admin Menu > Script** .

Note: Script Tips. A context sensitive "Script Tips" zone is associated with this page. The zone provides useful tips on various topics related to setting up scripts.

Description of Page

Enter a unique **Script** code and **Description** for the script. **Owner** indicates if the script is owned by the base package or by your implementation (**Customer Modification**).

Caution: Important! If you introduce a new script, carefully consider its naming convention. Refer to [System Data Naming Convention](#) for more information.

Script Type indicates if this is a **BPA Script**, **Plug-In Script** or **Service Script**. Refer to [The Big Picture Of BPA Scripts](#) and [The Big Picture Of Server Based Scripts](#) for more information.

Accessibility Option appears only for BPA scripts. Set this value to **Accessible from Script Menu** for any script that may be launched as a stand-alone script. Scripts with this configuration may be linked to a navigation option so that they may be invoked from a menu and may be configured by a user as a favorite script. Set this value to **Not Accessible from Script Menu** for any script that cannot be launched on its own. For example, any script that is invoked as a sub-script from another script should have this setting. In addition, any script that is designed to be launched from within a specific portal where certain data is provided to the script should include this setting.

Enter an **Application Service** if the execution of the script should be secured. Refer to [Securing Script Execution](#) for more information.

Algorithm Entity appears only for *plug-in scripts*. Use this field to define the *algorithm entity* into which this script can be plugged in.

Business Object appears only for business object related plug-in scripts. Enter the *Business Object* whose elements are to be referenced by the plug-in script.

Script Engine Version defines the version of the XML Path Language (XPath) to be used for the script. Script engine versions 2 and 3 use the XPath 2 engine supplied by the XQuery team. This is the same engine used inside the Oracle database. The current script engine version 3 is a modified version that offers performance improvements without impacting existing version 3 scripts. **Notes regarding Script engine version 1:** The XPath library used is Jaxen; for BPA scripts, use IE's built-in MSXML parser; Xpath 1 (and even JavaScript) uses floating point arithmetic, which means that adding a collection of numbers with two decimal places might end up with a value of 10779.079999999998 instead of 10779.08.

Click on the **View Script Schema** to view the *script's data areas* on the *schema viewer* window.

The *tree* summarizes the script's steps. You can use the hyperlink to transfer you to the **Step** tab with the corresponding step displayed.

Script - Step

Use this page to add or update a script's steps. Open this page using **Admin Menu > Script** and then navigate to the **Step** tab.

Note: Time saver. You can navigate to a step by clicking on the respective node in the tree on the Main tab.

Description of Page

The **Steps** accordion contains an entry for every step linked to the script. When a script is initially displayed, its steps are collapsed. To see a step's details, simply click on the step's summary bar. You can re-click the bar to collapse the step's details. Please see [accordions](#) for the details of other features you can use to save time.

Select the **Step Type** that corresponds with the step. Refer to [How To Set Up Each Step Type](#) for an overview of the step types.

Caution: The Step Type affects what you can enter on other parts of this page. The remainder of this section is devoted to those fields that can be entered regardless of Step Type. The subtopics that follow describe those fields whose entry is contingent on the Step Type.

Step Sequence defines the relative position of this step in respect of the other steps. The position is important because it defines the order in which the step is executed. You should only change a Step Sequence if you need to reposition this step. But take care; if you change the Step Sequence and the step is referenced on other steps, you'll have to change all of the referencing steps.

Note: Leave gaps in the sequence numbers. Make sure you leave space between sequence numbers so that you can add new steps between existing ones in the future. If you run out of space, you can use the **Renumber** button to renumber all of the steps. This will renumber the script's steps by 10 and change all related references accordingly.

Display Step is only enabled on BPA scripts for step types that typically don't cause information to be displayed in the *script area* (i.e., step types like **Conditional Branch**, **Go to a step**, **Height**, etc). If you turn on this switch, information about the step is displayed in the script area to help you debug the script.

Caution: Remember to turn this switch off when you're ready to let users use this script.

Note: If **Display Step** is turned on and the step has **Text**, this information will be displayed in the script area. If **Display Step** is turned on and the step does NOT have **Text**, a system-generated messages describing what the step does is displayed in the script area.

Display Icon controls the *icon* that prefixes the **Text** that's displayed in the script area. Using an icon on a step is optional. This field is only applicable to BPA scripts.

Text is the information that displays in the *script area* when the step executes. You need only define text for steps that cause something to display in the script area.

Fastpath: Refer to [How To Substitute Variables In Text](#) for a discussion about how to substitute variables in a text string.

Fastpath: Refer to [How To Use HTML Tags And Spans In Text](#) for a discussion about how to format (with colors and fonts) the text that appears in the script area.

The other fields on this page are dependent on the **Step Type**. The topics that follow briefly describe each step type's fields and provide additional information about steps.

Click on the **View Script Schema** hyperlink to view the script's data areas. Doing this opens the *schema viewer* window.

The **View Script As Text** hyperlink appears for server-based scripts only. Click on this link to view on a separate window the internal scripting commands underlying your script steps. The presented script syntax is completely valid within *edit data* steps.

How To Set Up Each Step Type

The contents of this section describe how to set up each type of step.

Common Step Types To All Script Types

The contents of this section describe common step types applicable to all script types.

How To Set Up Conditional Branch Steps

Conditional branch steps allow you to conditionally jump to a different step based on logical criteria. For example, you could jump to a different step in a script if the customer is residential as opposed to commercial. In addition, several fields are required for **Conditional Branch** steps:

Compare Field Type and **Compare Field Name** define the first operand in the comparison. The **Field Type** defines where the field is located. The **Field Name** defines the name of the field. The following points describe each field type:

- **Current To Do Information.** Use this field type when the field being compared resides on the current To Do entry. Refer to [How To Use To Do Fields](#) for instructions on how to define the appropriate **Field Name**.
- **Data Area.** Use this field type when the field being compared is one that you put into one of the scripts data areas in an earlier step. **Field Name** must reference both a data area structure name as well as the field, for example "parm/charType". Refer to [How To Reference Fields In Data Areas](#) for instructions on how to construct the appropriate **Field Name**.
- **Page Data Model.** Use this field type when the field being compared resides on one of the tab pages in the *object display area*. Refer to [How To Find The Name Of Page Data Model Fields](#) for instructions on how to find the appropriate **Field Name**.
- **Predefined Value.** Use this field type when the field being compared is a *global variable*.
- **Temporary Storage.** Use this field type when the field being compared is one that you put into temporary storage in an earlier step. The **Field Name** must be the same as defined in an earlier step.
- **User Interface Field.** Use this field type when the field being compared resides on the currently displayed tab page. Refer to [How To Find The Name Of User Interface Fields](#) for instructions on how to find the appropriate **Field Name**.

Condition defines the comparison criteria:

- Use >, <, =, >=, <=, <> (not equal) to compare the field using standard logical operators. Enter the comparison value using the following fields.
- Use **IN** to compare the first field to a list of values. Each value is separated by a comma. For example, if a field value must equal **1, 3** or **9**, you would enter a comparison value of **1,3,9**.
- Use **BETWEEN** to compare the field to a range of values. For example, if a field value must be between **1** and **9**, you would enter a comparison value of **1,9**. Note, the comparison is inclusive of the low and high values.

Comparison Field Type, **Comparison Field Name** and **Comparison Value** define what you're comparing the first operand to. The following points describe each field type:

- **Current To Do Information.** Use this field type when the comparison value resides on the current To Do entry. Refer to [How To Use To Do Fields](#) for instructions on how to define the appropriate **Field Name**.
- **Data Area.** Use this field type when the comparison value resides in one of the scripts data areas. **Field Name** must reference both a data area structure name as well as the field, for example "parm/charType". Refer to [How To Reference Fields In Data Areas](#) for instructions on how to construct the appropriate **Field Name**.
- **Page Data Model.** Use this field type when the comparison value resides on one of the tab pages in the *object display area*. Refer to [How To Find The Name Of Page Data Model Fields](#) for instructions on how to find the appropriate **Field Name**.
- **Predefined Value.** Use this field type when the field being compared is a constant value defined in the script. When this field type is used, use **Comparison Value** to define the constant value. Refer to [How To Use Constants In Scripts](#) for instructions on how to use constants.
- **Temporary Storage.** Use this field type when the comparison value is a field that you put into temporary storage in an earlier step. The **Field Name** must be the same as defined in an earlier step.
- **User Interface Field.** Use this field type when the comparison value resides on the currently displayed tab page. Refer to [How To Find The Name Of User Interface Fields](#) for instructions on how to find the appropriate **Field Name**.

Note: Conditional field types. The field types **Current To Do Information**, **Page Data Model** and **User Interface Field** are only applicable to BPA scripts.

The above fields allow you to perform a comparison that results in a value of **TRUE** or **FALSE**. The remaining fields control the step to which control is passed given the value:

- **If TRUE, Go to** defines the step that is executed if the comparison results in a **TRUE** value.

- **If FALSE, Go to** defines the step that is executed if the comparison results in a **FALSE** value.

Note: Numeric Comparison. Comparison of two values may be numeric or textual (left-to-right). Numeric comparison takes place only when values on both side of the comparison are recognized as numeric by the system. Otherwise, textual comparison is used. Fields for **Current To Do Information**, **Data Area**, **Page Data Model**, and **User Interface Field** types are explicitly associated with a data type and therefore can be recognized as numeric or not. This is not the case for fields residing in **Temporary Storage** or those set as **Predefined Values** . A **Temporary Storage** field is considered numeric if it either holds a numeric value moved to it from an explicitly defined numeric value (see above) or it is a resultant field of mathematical operation. A **Predefined Value** field is considered numeric if the other field it is compared to is numeric. For example, if a numeric field is compared to a **Predefined Value** the latter is considered numeric as well resulting in numeric value comparison. However, if the two fields are defined as **Predefined Values** the system assumes their values are text strings and therefore applies textual comparison.

How To Set Up Edit Data Steps

Edit data steps provide a free format region where you can specify commands to control your script processing.

In general, the syntax available within edit data mimics the commands available within the explicit step types. However, there are a few commands that are available only within edit data. For example, the two structured commands: **For**, and **If**.

For server-based scripts, you may find it useful to create a few explicit step types and then use the **View Script as Text** hyperlink on the [Script - Step](#) page to better understand the edit data syntax.

Note: Not all BPA step types are supported using the edit data syntax. **Tips.** Refer to the tips context zone associated with the script maintenance page for more information on edit data commands and examples.

Additional field required for **Edit data** steps:

Enter your scripting commands in the **Edit Data Text** field.

How To Set Up Go To Steps

Go to steps allow you to jump to a step other than the next step. Additional fields required for **Go To** steps:

Next Step defines the step to which the script should jump.

How To Set Up Invoke Business Object Steps

Invoke business object steps allow you to interact with a [business object](#) in order to obtain or maintain its information.

The following additional fields are required for **Invoke business object** steps:

Use **Warning Level** to indicate whether warnings should be suppressed and if not, how they should be presented to the user. By default, warnings are suppressed. If **Warn As Popup** is used, the warning is displayed using the standard popup dialog. If **Warn As Error** is used processing is directed to the **If Error, Go To** step. This field is only applicable to BPA scripts.

Group Name references the [data area](#) to be passed to and from the server when communicating with the **Business Object**. Indicate the **Action** to be performed on the object when invoked. Valid values are **Add**, **Delete**, **Fast Add (No Read)**, **Fast Update (No Read)**, **Read**, **Replace**, **Update**.

Note: Performance note. The actions **Fast Add** and **Fast Update** should be used when the business object's data area does not need to be re-read subsequent to the **Add** or **Update** action. In other words, the **Add** and **Update** actions are equivalent to **Fast Add + Read** and **Fast Update + Read** .

The business object call will either be successful or return an error. The next two fields only appear when the call is issued from a BPA script, to determine the step to which control is passed given the outcome of the call.

If Success, Go To defines the step that is executed if the call is successful. This field is only applicable to BPA scripts.

If Error, Go To defines the step that is executed if the call returns on error. Please note that the error information is held in *global variables*. This field is only applicable to BPA scripts.

Note: Error technique. Let's assume a scenario where a business object is invoked from a BPA script and the call returned an error. If the BPA script is configured to communicate with the user using a UI map, you may find it useful to invoke the map again to present the error to the user. Alternatively, you may invoke a step that transfers control to a script that displays the error message information and stops. The demonstration database contains samples of these techniques.

How To Set Up Invoke Business Service Steps

Invoke business service steps allow you to interact with a *business service*.

The following additional fields are required for **Invoke business service** steps:

Use **Warning Level** to indicate whether warnings should be suppressed and if not, how they should be presented to the user. By default, warnings are suppressed. If **Warn As Popup** is used, the warning is displayed using the standard popup dialog. If **Warn As Error** is used processing is directed to the **If Error, Go To** step. This field is only applicable to BPA scripts.

Group Name references the *data area* to be passed to and from the server when the **Business Service** is invoked.

The business service call will either be successful or return an error. The next two fields only appear when the call is issued from a BPA script, to determine the step to which control is passed given the outcome of the call.

If Success, Go To defines the step that is executed if the call is successful. This field is only applicable to BPA scripts.

If Error, Go To defines the step that is executed if the call returns on error. Please note that the error information is held in *global variables*. This field is only applicable to BPA scripts.

Note: Error technique. Let's assume a scenario where a business service is invoked from a BPA script and the call returned an error. If the BPA script is configured to communicate with the user using a UI map, you may find it useful to invoke the map again to present the error to the user. Alternatively, you may invoke a step that transfers control to a script that displays the error message information and stops. The demonstration database contains samples of these techniques.

How To Set Up Invoke Service Script Steps

Invoke service script steps allow you to execute a *service script*.

The following additional fields are required for **Invoke service script** steps:

Use **Warning Level** to indicate whether warnings should be suppressed and if not, how they should be presented to the user. By default, warnings are suppressed. If **Warn As Popup** is used, the warning is displayed using the standard popup dialog. If **Warn As Error** is used processing is directed to the **If Error, Go To** step. This field is only applicable to BPA scripts.

Group Name references the *data area* to be passed to and from the server when the **Service Script** is invoked.

The service script call will either be successful or return an error. The next two fields only appear when the call is issued from a BPA script to determine the step to which control is passed given the outcome of the call.

If Success, Go To defines the step that is executed if the call is successful. This field is only applicable to BPA scripts.

If Error, Go To defines the step that is executed if the call returns on error. Please note that the error information is held in *global variables*. This field is only applicable to BPA scripts.

Note: Error technique. Let's assume a scenario where a service script is invoked from a BPA script and the call returned an error. If the BPA script is configured to communicate with the user using a UI map, you may find it useful to invoke the map again to present the error to the user. Alternatively, you may invoke a step that transfers control to a script that displays the error message information and stops. The demonstration database contains samples of these techniques.

How To Set Up Label Steps

Label steps allow you to describe what the next step(s) are doing. Steps of this type are helpful to the script administrators when reviewing or modifying the steps in a script, especially when a script has many steps. When designing a script, the label steps enable you to provide a heading for common steps that belong together. The script tree displays steps of this type in a different color (green) so that they stand out from other steps.

There are no additional fields for **Label** steps.

How To Set Up Move Data Steps

Move data steps allow you to move data (from a source to a destination). The following additional fields are required for **Move data** steps:

Source Field Type, **Source Field Name** and **Source Field Value** define what you're moving. The following points describe each field type:

- **Context Variable.** Use this field type in a plug-in or service script if the source value is a variable initiated in a higher level script.
- **Current To Do Information.** Use this field type when the source value resides on the current To Do entry. Refer to [How To Use To Do Fields](#) for instructions on how to define the appropriate **Field Name**.
- **Data Area.** Use this field type when the field being compared is one that you put into one of the script's data areas in an earlier step. **Field Name** must reference both a data area structure name as well as the field, for example "parm/charType". Refer to [How To Reference Fields In Data Areas](#) for instructions on how to construct the appropriate **Field Name**.
- **Global Context.** Use this field type in a BPA script when the source value is a global variable.
- **Page Data Model.** Use this field type in a BPA script when the source value resides on any of the tab pages in the *object display area* (i.e., the source field doesn't have to reside on the currently displayed tab page, it just has to be part of the object that's currently displayed). Refer to [How To Find The Name Of Page Data Model Fields](#) for instructions on how to find the appropriate **Field Name**.
- **Portal Context.** Use this field type when the source value is a variable in the portal context.
- **Predefined Value.** Use this field type when the source value is a constant value defined in the script. When this field type is used, use **Source Field Value** to define the constant value. Refer to [How To Use Constants In Scripts](#) for instructions on how to use constants.

Note: Concatenating fields together. You can also use **Predefined Value** if you want to concatenate two fields together. For example, let's say you have a script that merges two persons into a single person. You might want this script to change the name of the person being merged out of existence to include the ID of the person remaining. In this example, you could enter a **Source Field Value** of **%ONAME merged into person %PERID** (where **ONAME** is a field in temporary storage that contains the name of the person being merged out of existence and **PERID** contains the ID of the person being kept). Refer to [How To Substitute Variables In Text](#) for a description of how you can substitute field values to compose the field value.

- **Temporary Storage.** Use this field type when the source value is a field that you put into temporary storage in an earlier step. The **Field Name** must be the same as defined in an earlier step.

- **User Interface Field.** Use this field type when the source value resides on the currently displayed tab page. Refer to [How To Find The Name Of User Interface Fields](#) for instructions on how to find the appropriate **Field Name**.

Destination Field Type and **Destination Field Name** define where the source field will be moved. The **Field Type** defines where the field is located. The **Field Name** defines the name of the field. The following points describe each field type:

- **Context Variable.** Use this field type in your plug-in or service script if you use a variable to communicate information to a lower level service script or schema.
- **Data Area.** Use this field type when the destination field resides on one of the scripts data areas. **Field Name** must reference both a data area structure name as well as the field, for example "parm/charType". Refer to [How To Reference Fields In Data Areas](#) for instructions on how to construct the appropriate **Field Name**.
- **Page Data Model.** Use this field type when the destination field resides on any of the tab pages in the [object display area](#) (i.e., the field populated doesn't have to reside on the currently displayed tab page, it just has to be part of the object that's currently displayed). Refer to [How To Find The Name Of Page Data Model Fields](#) for instructions on how to find the appropriate **Field Name**.
- **Portal Context.** Use this field type in a BPA script when the destination to be updated is in the current portal context.
- **Temporary Storage.** Use this field type when the destination field resides in temporary storage. Use **Field Name** to name the field in temporary storage. Use **Field Name** to name the field in temporary storage. Refer to [How To Name Temporary Storage Fields](#) for more information.
- **User Interface Field.** Use this field type when the destination field resides on the currently displayed tab page. Refer to [How To Find The Name Of User Interface Fields](#) for instructions on how to find the appropriate **Field Name**.

Note: Conditional field types. The field types **Current To Do Information**, **Page Data Model** and **User Interface Field** are only applicable to BPA scripts.

How To Set Up Terminate Steps

Terminate steps cause a server-based script to end processing successfully or issue an error.

The following additional fields are required for **Terminate** steps:

Error indicates whether an error should be thrown or not. If error, **Error Data Text** must be specified, indicating the error message and any message substitution parameters. Refer to the tips zone associated with the Script page for the actual syntax of initiating an error message.

Note: The ability to terminate a step in error is only supported for server-based scripts.

Step Types Applicable to BPA Scripts only

The contents of this section describe step types that are only applicable to BPA scripts.

How To Set Up Display Text Steps

Display text steps cause a text string to be displayed in the script area. Steps of this type can be used to provide the user with guidance when manual actions are necessary. In addition, they can be used to provide confirmation of the completion of tasks.

The information you enter in the **Text** field is displayed in the [script area](#) when the step is executed.

The text string can contain [substitution variables](#) and [HTML formatting commands](#). Also note that for debugging purposes, you can display an entire data area (or a portion thereof) by entering %+...+% where ... is the name of the node whose element(s) should be displayed.

Note: Conditional step type. This step type is only applicable to BPA scripts.

How To Set Up Height Steps

Height steps are used to change the height of the script area to be larger or smaller than the standard size.

The following additional fields are required for **Height** steps:

Script Window Height defines the number of **Pixels** or the **Percentage** (according to the **Height Unit**) that the script window height should be adjusted. The percentage indicates the percentage of the visible screen area that the script area uses. For example, a percentage value of **100** means that the script area will use the entire area.

Note: Standard Number of Pixels. The default number of pixels used by the script area is **75**.

Note: Adjust script height in the first step. If you want to adjust the height of the script area, it is recommendation to define the **height** step type as your first step. Otherwise, the script area will open using the standard height and then readjust, causing the screen to redisplay.

Note: Hide script area. You could use this type of step to set the height to **0** to hide the script area altogether. This is useful if the script does not require any prompting to the user. For example, perhaps you define a script to take a user to a page and with certain data pre-populated and that is all.

Note: Automatically close script area. If you want the script area to close when a script is completed, you could define the final step type with a height of 0.

Note: Conditional step type. This step type is only applicable to BPA scripts.

How To Set Up Input Data Steps

Input data steps cause the user to be prompted to populate an input field in the script area. The input value can be saved in a field on a page or in temporary storage. A **Continue** button always appears adjacent to the input field. You may configure steps of this type to display one or more buttons in addition to the **Continue** button. For example, you may want to provide the ability for the user to return to a previous step to fix incorrect information. The user may click on any of these buttons when ready for the script to continue.

The following additional fields are required for **Input Data** steps:

Destination Field Type and **Destination Field Name** define where the input field will be saved. The **Field Type** defines where the field is located. The **Field Name** defines the name of the field. The following points describe each field type:

- **Page Data Model.** Use this field type to put the input field into a field that resides on any of the tab pages in the *object display area* (i.e., the field populated doesn't have to reside on the currently displayed tab page, it just has to be part of the object that's currently displayed). Refer to [How To Find The Name Of Page Data Model Fields](#) for instructions on how to find the appropriate **Field Name**.
- **Temporary Storage.** Use this field type to put the input field into temporary storage. Use **Field Name** to name the field in temporary storage. Refer to [How To Name Temporary Storage Fields](#) for more information.
- **User Interface Field.** Use this field type to put the input field into a field that resides on the currently displayed tab page. Note, if you want to execute underlying default logic, you must populate a **User Interface Field**. Refer to [How To Find The Name Of User Interface Fields](#) for instructions on how to find the appropriate **Field Name**.

The **Prompt Values** grid may be used to define additional buttons. A separate button is displayed in the script area for each entry in this grid.

- **Prompt Text** is the verbiage to appear on the button. Refer to [How To Substitute Variables In Text](#) for a description of how you can substitute field values into the prompts.
- **Sequence** controls the order of the buttons.

- **Next Script Step** defines the step to execute if the user clicks the button.

Note: Conditional step type. This step type is only applicable to BPA scripts.

How To Set Up Invoke Function Steps

Invoke function steps are used to retrieve or update data independent of the page currently being displayed. For example, if you design a script that takes different paths based on the customer's customer class, you could invoke a function to retrieve the customer's customer class. Doing this is much more efficient than the alternative of transferring to the account page and retrieving the customer class from the Main page.

Fastpath: You must set up a function before it can be referenced in a script. Refer to [Maintaining Functions](#) for the details.

The following additional fields are required for **Invoke Function** steps:

Function defines the name of the function. The function's **Long Description** is displayed below.

When a function is invoked, it will either be successful or return an error. The next two fields control the step to which control is passed given the outcome of the function call:

- **If Success, Go to** defines the step that is executed if the function is successful.
- **If Error, Go to** defines the step that is executed if the function returns on error. Refer to [How To Use Constants In Scripts](#) for a list of the global variables that are populated when a function returns an error.

Note: Error technique. If a function returns an error, we recommend that you invoke a step that transfers control to a script that displays the error message information and stops (note, the error information is held in [global variables](#)). You would invoke this script via a **Transfer Control**. The demonstration database contains a sample of this type of script - see **CI_FUNCERR**.

The **Send Fields** grid defines the fields whose values are sent to the function and whose field value source is not **Defined On The Function**. For example, if the function receives an account ID, you must define the name of the field in the script that holds the account ID.

- **Field** contains a brief description of the field sent to the function.
- **Source Field Type** and **Mapped Field / Value** define the field sent to the function. Refer to the description of Source Field under [How To Set Up Move Data Steps](#) for a description of each field type.
- **Comments** contain information about the field (this is defined on the function).

The **Receive Fields** grid defines the fields that hold the values returned from the function. For example, if the function returns an account's customer class and credit rating, you must set up two fields in this grid.

- **Field** contains a brief description of the field returned from the function.
- **Destination Field Type** and **Mapped Field** define the field returned from the function. Refer to the description of Destination Field under [How To Set Up Move Data Steps](#) for a description of each field type.
- **Comments** contain information about how the field (this is defined on the function).

Note: Conditional step type. This step type is only applicable to BPA scripts.

How To Set Up Invoke Map Steps

Invoke map steps are used to invoke a [UI Map](#) to display, capture and update data using an HTML form. You may configure steps of this type to display one or more buttons in addition to the **Continue** button. For example, you may want to provide the ability for the user to return to a previous step to fix incorrect information. The user may click on any of these buttons when ready for the script to continue.

The following additional fields are required for **Invoke map** steps:

Group Name references the *data area* to be passed to and from the server when rendering the HTML form associated with the **Map**.

Use **Target Area** to designate where the map will be presented.

- Select **BPA Zone** if the map should be presented within the *script area*.
- Select **Page Area** if the map should be presented in the *object display area*, i.e. the frame typically used to house a maintenance page.
- Select **Pop-up Window** if the map should be launched in a separate window.

The **Returned Values** grid contains a row for every action button defined on the map.

- **Returned Value** is the value returned when the user clicks the button.
- **Use as Default** can only be turned on for one entry in the grid. If this is turned on, this value's Next Script Step will be executed if the returned value does not match any other entry in the grid. For example, if the user closes a pop-up (rather than clicking a button), the default value will be used.
- **Next Script Step** defines the step to execute if the user clicks the button.

Note: Conditional step type. This step type is only applicable to BPA scripts.

How To Set Up Mathematical Operation Steps

Mathematical operation steps allow you to perform arithmetic on fields. You can also use this type of step to add and subtract days from dates. For example, you could calculate a date 7 days in the future and then use this value as the customer's next credit review date. The following additional fields are required for **Mathematical Operation** steps:

Base Field Type and **Base Field Name** define the field on which the mathematical operation will be performed. The **Field Type** defines where the field is located. The **Field Name** defines the name of the field. The following points describe each field type:

- **Page Data Model.** Use this field type when the field resides on any of the tab pages in the *object display area*. Refer to [How To Find The Name Of Page Data Model Fields](#) for instructions on how to find the appropriate **Field Name**.
- **Temporary Storage.** Use this field type when the field resides in temporary storage. You must initialize the temporary storage field with a Move Data step before performing mathematical operations on the field. Refer to [How To Set Up Move Data Steps](#) for more information.
- **User Interface Field.** Use this field type when the field resides on the currently displayed tab page. Refer to [How To Find The Name Of User Interface Fields](#) for instructions on how to find the appropriate **Field Name**.

Math Operation controls the math function to be applied to the **Base Field**. You can specify +, -, /, and *. Note, if the base field is a date, you can only use + or -.

Math Field Type, **Math Field Name** and **Math Field Value** define the field that contains the value to be added, subtracted, divided, or multiplied. The following points describe each field type:

- **Current To Do Information.** Use this field type when the value resides on the current To Do entry. Refer to [How To Use To Do Fields](#) for instructions on how to define the appropriate **Field Name**.
- **Page Data Model.** Use this field type when the value resides on any of the tab pages in the *object display area*. Refer to [How To Find The Name Of Page Data Model Fields](#) for instructions on how to find the appropriate **Field Name**.
- **Predefined Value.** Use this field type when the value is a constant. When this field type is used, use **Source Field Value** to define the constant value. Refer to [How To Use Constants In Scripts](#) for more information. Note, if you are performing arithmetic on a date, the field value must contain the number and type of **days/ months/ years**. For example, if you want to add 2 years to a date, the source field value would be **2 years**.

- **Temporary Storage.** Use this field type when the value is a field that you put into temporary storage in an earlier step. The **Field Name** must be the same as defined in an earlier step.
- **User Interface Field.** Use this field type when the value resides in a field on the current tab page. Refer to [How To Find The Name Of User Interface Fields](#) for instructions on how to find the appropriate **Field Name**.

Note: Conditional step type. This step type is only applicable to BPA scripts.

How To Set Up Navigate To A Page Steps

Navigate to a page steps cause a new page (or tab within the existing page) to be displayed in the object display area. Steps of this type are a precursor to doing anything on the page. The following additional field is required for **Navigate to a page** steps:

Navigation Option defines the transaction, tab, access mode (add or change) and any context fields that are passed to the transaction in change mode. For example, if you want a script to navigate to Person - Characteristics for the current person being displayed in the dashboard, you must set up an appropriate navigation option. Refer to [Defining Navigation Options](#) for more information.

Note: Navigating to a page in update mode. Before you can navigate to a page in change mode, the page data model must contain the values to use for the navigation option's context fields. If necessary, you can move values into the page data model using a [Move Data step](#) first. For example, before you can navigate to a page in change mode with an account ID in context, you may need to move the desired account ID into the ACCT_ID field in the page data model. The actual field name(s) to use are listed as context fields on the [navigation option](#).

Note: Sample scripts. Refer to the scripts in the demonstration database for many examples of navigation options. Refer to [sample scripts](#) for examples of scripts and their use of navigation options. **Conditional step type.** This step type is only applicable to BPA scripts.

How To Set Up Perform Script Steps

Perform script steps cause another BPA script to be performed. After the performed script completes, control is returned to the next step in the original script. You might want to think of the scripts referred to on steps of this type as "subroutines". This functionality allows you to encapsulate common logic in reusable BPA scripts that can be called from other BPA scripts. This simplifies maintenance over the long term.

The following additional field is required for **Perform script** steps:

Subscript is the name of the script that is performed.

Note: Conditional step type. This step type is only applicable to BPA scripts.

How To Set Up Press A Button Steps

Press a button steps cause a button to be pressed in the [object display area](#) or in the [button bar](#). For example, you could use this type of step to add a new row to a person's characteristic (and then you could use a **Move Data** step to populate the newly added row with a given char type and value). The following additional fields are required for **Press a button** steps:

Button Name is the name of the button to be pressed. This button must reside on the currently displayed tab page (or in the action bar at the top of the page). Refer to [How To Find The Name Of A Button](#) for more information.

Note: Conditional step type. This step type is only applicable to BPA scripts.

How To Set Up Prompt User Steps

Prompt user steps cause the user to be presented with a menu of options. The options can be presented using either buttons or in the contents of a drop down. You can also use steps of this type to pause a script while the user checks something out (and when the user is ready to continue with the script, they are instructed to click a prompt button). The following additional fields are required for **Prompt User** steps:

Prompt Type controls if the prompt shown in the script area is in the form of **Button(s)** or a **Dropdown**. Note, if you use a **Dropdown**, a Continue button appears adjacent to the dropdown in the script area when the step executes. The user clicks the Continue button when they are ready for the script to continue.

The **Prompt Values** grid contains a row for every value that can be selected by a user. Note, if you use a **Prompt Type** of **Button(s)**, a separate button is displayed in the script area for each entry in this grid.

- **Prompt Text** is the verbiage to appear on the button or in the dropdown entry. Refer to [How To Substitute Variables In Text](#) for a description of how you can substitute field values into the prompts.
- **Sequence** controls the order of the buttons or dropdown entries.
- **Use As Default** can only be turned on for one entry in the grid. If this is turned on for a dropdown entry, this value is defaulted in the grid. If this is turned on for a button, this button becomes the default (and the user should just have to press **Enter** (or **space**) rather than click on it).
- **Next Script Step** defines the step to execute if the user clicks the button or selects the dropdown value.

Note: Conditional step type. This step type is only applicable to BPA scripts.

How To Set Up Set Focus To A Field Steps

Set focus to a field steps cause the cursor to be placed in a specific field on a page. A **Continue** button always appears in the script area when this type of step executes. The user may click the **Continue** button when they are ready for the script to continue. You may configure steps of this type to display one or more buttons in addition to the **Continue** button. For example, you may want to provide the ability for the user to return to a previous step to fix incorrect information. The user may click on any of these buttons when ready for the script to continue.

The following additional fields are required for **Set focus to a field** steps:

Destination Field Name defines the field on which focus should be placed. This field must reside on the currently displayed tab page. Refer to [How To Find The Name Of User Interface Fields](#) for instructions on how to find the appropriate **Field Name**.

The **Prompt Values** grid may be used to define additional buttons. A separate button is displayed in the script area for each entry in this grid.

- **Prompt Text** is the verbiage to appear on the button. Refer to [How To Substitute Variables In Text](#) for a description of how you can substitute field values into the prompts.
- **Sequence** controls the order of the buttons.
- **Next Script Step** defines the step to execute if the user clicks the button.

Note: Conditional step type. This step type is only applicable to BPA scripts.

How To Set Up Transfer Control Steps

Transfer control steps cause the current BPA script to terminate and the control to pass to another BPA script. You might want to construct a BPA script with steps of this type when the script has several potential logic paths and you want to segregate each logic path into a separate BPA script (for ease of maintenance).

The following additional fields are required for **Transfer control** steps:

Subscribe is the name of the script to which control is transferred.

Note: Conditional step type. This step type is only applicable to BPA scripts.

Additional Topics

The contents of this section provide additional information about steps.

How To Find The Name Of User Interface Fields

Follow these steps to find the name of a field that resides on a page:

- Navigate to the page in question.
- Right click in the body of the page (but not while the pointer is in an input field). Note, if the field in question resides in a grid, you must right click while the pointer is in the section that contains the grid (but not while the pointer is in an input field in the grid) - this is because there's a separate HTML document for each grid on a page.
- Select **View Source** from the pop-up menu to display the source HTML.
- Scroll to the Widget Info section (towards the top of the HTML document). It contains a list of all of the objects on a page. For example, the following is an example from the Account - Main page:

```
widget info:
widget_ID , Element Type - label info - label
ENTITY_NAME, IL - $ENTITY_NAME - Name
ACCT_ID, IT - $ACCT_ID - Account ID
ACCT_CHECK_DIGIT, IL - $ACCT_CHECK_DIGIT - Account Check Digit
IM_ACCT_ID, IM - $SEARCH_FOR_ACC_LBL - Search for Account
COLL_CL_CD, HD - $COLL_CL_CD - Collection Class
SETUP_DT, IT - $SETUP_DT - Set Up Date
CURRENCY_CD, IS - $CURRENCY_CD - Currency Code
CIS_DIVISION, IS - $CIS_DIVISION - CIS Division
PROTECT_DIV_SW, CB - $ACCT$PROTECT_DIV_SW - Protect CIS Division
CUST_CL_CD, IS - $CUST_CL_CD - Customer Class
ACCESS_GRP_CD, IT - $ACCESS_GRP_CD - Access Group
IM_ACCESS_GRP_CD, IM - $SRCH_ACC_GRP_CD - Search for Access Group
ACCESS_DESCR, IL - $DESCR - Description
ACCT_MGMT_GRP_CD, IT - $ACCT_MGMT_GRP_CD - Account Management Group
IM_ACCT_MGMT_GRP_CD, IM - $SEARCH_FOR_TDR_LBL - Search for To Do Role
MGMT_DESCR, IL
ALERT_INFO, IA - $ALERT_INFO - Alert Information
BILL_CYC_CD, IS - $BILL_CYC_CD - Bill Cycle
BILL_AFTER_DT, IT - $BILL_AFTER_DT - Bill After
PROTECT_CYC_SW, CB - $PROTECT_CYC_SW - Protect Bill Cycle
BILL_PRT_INTERCEPT, IT - $BILL_PRT_INTERCEPT - Bill Print Intercept
IM_BILL_PRT_INTERCEPT, IM - $FOR_BILL_PRINT_LBL - Search for User
MAILING_PREM_ID, IT - $MAILING_PREM_ID - Mailing Premise
IM_MAILING_PREM_ID, IM - $SEARCH_FOR_MAI_LBL - Search for Mailing Premise
PREM_INFO, IL
PROTECT_PREM_SW, CB - $PROTECT_PREM_SW - Protect Mailing Premise
dataframe, GD
```

The field names that you'll reference in your scripts are defined on the left side of the HTML (e.g., ENTITY_NAME, ACCT_ID, CUST_CL_CD, etc.).

The names of fields that reside in scrolls are in a slightly different format. The following is an example of the HTML for the persons scroll that appears on Account - Person. Notice that the fields in the scroll are prefixed with the name of the scroll plus a \$ sign. For example, the person's ID is called **ACCT_PER\$PER_ID**.

```

Widget Info:
widget_ID , Element Type - label info - label
ENTITY_NAME, IL - $ENTITY_NAME - Name
PREM_INFO, HD
ACCT_ID, IT - $ACCT_ID - Account ID
ACCT_CHECK_DIGIT, IL - $ACCT_CHECK_DIGIT - Account Check Digit
IM_ACCT_ID, IM - $SEARCH_FOR_ACC_LBL - Search for Account
ACCT_PER$recordCount, SH - $OF_LBL - of
ACCT_PER$PER_ID, IT - $PER_ID - Person ID
IM_ACCT_PER$PER_ID, IM - $FOR_PERSON_LBL - Search for Person
ACCT_PER$ENTITY_NAME, IL - $ENTITY_NAME - Name
ACCT_PER$MAIN_CUST_SW, CB - $MAIN_CUST_SW - Main Customer
ACCT_PER$FIN_RESP_SW, CB - $FIN_RESP_SW - Financially Responsible
ACCT_PER$THRD_PTY_SW, CB - $THRD_PTY_SW - Third Party Guarantor
ACCT_PER$ACCT_REL_TYPE_CD, IS - CI_ACCT_PER$ACCT_REL_TYPE_CD - Relationship Type
ACCT_PER$WEB_ACCESS_FLG, IS - $WEB_ACCESS_FLG - Web Self Service Access Flag
ACCT_PER$PFX_SFX_FLG, IS - $PFX_SFX_FLG - Prefix/Suffix
ACCT_PER$NAME_PFX_SFX, IT - $NAME_PFX_SFX - Pfx/Sfx Name
ACCT_PER$RECEIVE_COPY_SW, CB - $RECEIVE_COPY_SW - Receives Copy of Bill
ACCT_PER$BILL_RTE_TYPE_CD, IS - $BILL_RTE_TYPE_CD - Bill Route Type
ACCT_PER$BILL_RTE_TYPE_INFO, IL
ACCT_PER$BILL_RTG METH_FLG, HD
ACCT_PER$BILL_FORMAT_FLG, IS - $BILL_FORMAT_FLG - Bill Format

```

The names of fields that reside in grids are in a slightly different format. The following is an example of the HTML for the names grid that appears on Person - Main. Notice that the fields in the grid are prefixed with the name of the grid plus a :x\$. For example, the person's name is called **PER_NAME:x\$ENTITY_NAME**. When you reference such a field in your script, you have the following choices:

- Substitute **x** with the row in the grid (and keep in mind, the first row in a grid is row **0** (zero); this means the second row is row **1**).
- If you want to reference the "current row" (e.g., the row in which the cursor will be placed), you can keep the **x** notation (**x** means the "current row").

```

Widget Info:
widget_ID , Element Type - label info - label
PER_NAME:x$NAME_TYPE_FLG, IS - $NAME_TYPE_FLG - Name Type
PER_NAME:x$ENTITY_NAME, IT - CI_PER_NAME$ENTITY_NAME - Person Name

```

How To Find The Name Of Page Data Model Fields

You find the name of a **Page Data Model** field in the same way described under [How To Find The Name Of User Interface Fields](#). The only restriction is that you cannot refer to hidden / derived fields. However, you can refer to ANY of the object's fields regardless of the tab page on which they appear. For example, if you position the object display area to the Main tab of the Account transaction, you can reference fields that reside on all of the tab pages.

Caution: If you populate a **Page Data Model** field, none of the underlying default logic takes place. For example, if you populate a customer contact's contact type, none of the characteristics associated with the customer contact type are defaulted onto the customer contact. If you want the underlying defaulting to take place, you must populate a **User Interface Field**.

How To Find The Name Of A Button

If you want a **Press a button** step to press a button in the button bar, use one of the following names:

- IM_GOBACK
- IM_HISTORY
- IM_GOFORWARD
- IM_SAVE
- IM_REFRESH
- IM_CLEAR
- IM_COPY

- IM_DELETE
- IM_ScrollBack
- IM_ScrollForward
- IM_menuButton
- IM_CTRL_CENT
- IM_CTRL_CENTAI
- IM_USER_HOME
- IM_TO_DO
- IM_PrevTo Do
- IM_NextTo Do
- IM_CurrentTo Do
- IM_MY_PREF
- IM_helpButton
- IM_aboutButton
- IM_CTI
- IM_MINIMIZE_DASHBOARD. Pressing this will collapse the dashboard.
- IM_MAXIMIZE_DASHBOARD. Pressing this will expand the dashboard.

Note: Can't push the BPA button. You'll notice that the BPA Scripting button is missing. This is deliberate! Don't run a script from within a script!

Follow these steps to find the name of other buttons that reside in the object display area:

- Navigate to the page in question.
- Right click in the body of the page (but not while the pointer is in an input field). Note, if the field in question resides in a grid, you must right click while the pointer is in the section that contains the grid (but not while the pointer is in an input field in the grid) - this is because there's a separate HTML document for each grid on a page.
- Select **View Source** from the pop-up menu to display the source HTML.
- Scroll to the Widget Info section (towards the top of the HTML document). It contains a list of all of the objects on a page, including buttons.
- Iconized buttons (e.g., search buttons) are represented as HTML images and their field names are prefixed with **IM**. The following is an example of the HTML on the Bill - Main page (notice the **IM** fields for the iconized buttons).

```

widget info:
  widget_ID , Element Type - label info - label
  BILL_INFO, IL
  BILL_ID, IT - CI_BILL$BILL_ID - Bill ID
  IM_BILL_ID, IM - $SEARCH_FOR_A_B_LBL - Search for a Bill
  ACCT_ID, IT - $ACCT_ID - Account ID
  IM_ACCT_ID, IM - $FOR_AN_ACCOUNT_LBL - Search for Account
  ACCT_NAME, IL
  IM_BILLCTXT, IM
  CREDIT_NOTE_MSG, IL
  IM_GO_TO_CR_NOTE_FR_BILL, IM - $GO_TO_BILL_LBL - Go To Bill

```

- Transaction-specific actions buttons (e.g., the buttons use to generate and cancel a bill) are represented as switches. The following is an example of the HTML on the Bill - Main page (notice the **SW** fields for the action buttons). Note, if you want to **Set focus** to such a field, you would move a **Predefined Value** of **TRUE** to the switch.

```
TOT_AFT_COMPLETION, IL - $DERIVED_AMT - Payoff Balance
TOT_GEN_CHG, IL - $DERIVED_AMT - Payoff Balance
ACTION_GENERATE_SW, BU - $GENERATE_LBL - Generate
ACTION_FREEZE_SW, BU - $FREEZE_LBL - Freeze
ACTION_CAN_FRZN_SW, BU - $CANCEL_FROZEN_LBL - Cancel Frozen
ACTION_COMPLETE_SW, BU - $COMPLETE_LBL - Complete
ACTION_FRZ_CMPL_SW, BU - $SA_ID_SRH - SA ID
ACTION_DELETE_SW, BU - $DELETE_LBL - Delete
ACTION_REOPEN_SW, BU - $REOPEN_LBL - Reopen
ACTION_CR_NOTE_SW, BU - $CREDIT_NOTE_LBL - Credit Note
```

How To Substitute Variables In Text

You can substitute field values into a step's text string. You do this by prefixing the field name whose value should be substituted in the string with a `%`. For example, the message, "On `%COMPLETION_DTTM` this bill was completed, it's ending balance was `%ENDING_BALANCE`" contains two substitution variables (the bill's completion date / time and the bill's ending balance).

To substitute the value of an element from a data area you need to reference its XPath location as follows: `%=XPath=%`. If you want to substitute the whole XML node, not just the value, you need to reference it as follows `%+XPath+%`.

Only fields linked to the *current To Do* and fields that reside in *temporary storage* and *global variables* can be substituted into a text string.

Note: You can substitute fields that reside in the User Interface or Page Data Model by first moving them into temporary storage (using a **Move data** step).

You can also substitute field values into the verbiage displayed in *prompts* using the same technique.

How To Use HTML Tags And Spans In Text Strings and Prompts

You can use HTML tags in a step's text string. For example, the word "Continue" will be italicized in the following text string "Press `<i>Continue</i>` after you've selected the customer" (the `<i>` and `</i>` are the HTML tags used to indicate that the surrounded text should be italicized).

The following are other useful HTML tags:

- `
` causes a line break in a text string. If you use `

` a blank line will appear.
- `` text `` causes the surrounded text to be colored as specified (in this case, red). You can also use hex codes rather than the color name.

Please refer to an HTML reference manual or website for more examples.

You can also use "spans" to customize the look of the contents of a text string. For example, your text string could be "Press `Continue` after you've selected the customer". This would make the word "Continue" appear as large, bold, Courier text. Please refer to a Cascading Style Sheets (CSS) reference manual or website for more examples.

How To Use Constants In Scripts

Some steps can reference fields called **Predefined Values**. For example, if you want to compare an input value to the letter "Y", the letter **Y** would be defined as a Predefined Value's field value.

Special constants are used for fields defined as switches. When you move **TRUE** to a switch, it turns it on. When you move **FALSE** to a switch, it turns it off.

You can use a *global variable* as a Predefined Value. For example, if you wanted to move the current date to a field, you'd indicate you wanted to move a Predefined Value named `%CURRENT_DATE`.

How To Use Global Variables

As described above, some steps can reference fields called **Predefined Values**. In addition to referencing an ad hoc constant value (e.g., the letter **Y**), you can also reference a global variable in such a field value. A global variable is used when you want to reference system data. The following global variables exist:

- **%PARM-<name>** is the value of a parameter of that name passed in to the application when launched via the standard system URL. Refer to [Launching A Script When Starting the System](#) for more information on these parameters.
- **%PARM-NOT-SET** is to be used to compare against **%PARM-<name>** parameters to check if the parameter has been set or not when the application was launched. A parameter that has not been set would test as equal to this global variable. It is recommended to test parameters against this global variable before using them for the first time.
- **%CONTEXT-PERSONID** is a constant that contains the ID of the current person
- **%CONTEXT-ACCOUNTID** is a constant that contains the ID of the current account
- **%CONTEXT-PREMISEID** is a constant that contains the ID of the current premise
- **%BLANK** is a constant that contains a blank value, i.e. no value
- **%SPACE** is a constant that contains a single space value
- **%CURRENT-DATE** is the current date (as known by the browser, not the server)
- **%SAVE-REQUIRED** is a flag that contains an indication of whether the data on a page has been changed (and this requires saving). You may want to interrogate this flag to force a user to save their work before executing subsequent steps. This flag will have a value of **TRUE** or **FALSE**.
- **%NEWLINE** is a constant that contains a new line character (carriage return). Upon substitution, a line break is inserted in the resultant text.

Note: The constant **%NEWLINE** does not have the desired effect when the resultant text is HTML. For example, a step's text and prompt strings. This is because HTML ignores special characters such as new lines. Refer to [How To Use HTML Tags And Spans In Text](#) to learn how to cause a line break in an HTML text.

In addition, if an **Invoke Function** step returns an error, the following global variables contain information about the error:

- **%ERRMSG-CATEGORY** and **%ERRMSG-NUMBER** contain the unique identifier of the error message number.
- **%ERRMSG-TEXT** contains the brief description of the error.
- **%ERRMSG-LONG** contains the complete description of the error.

How To Name Temporary Storage Fields

Input Data and **Move Data** steps can create fields in temporary storage. You specify the name of the temporary storage field in the step's **Field Name**. The name of the field must NOT begin with % and must not be named the same as the *global variables*. Besides this restriction, you can use any **Field Name** that's acceptable to JavaScript (i.e., you can name a field in temporary storage almost anything). Keep in mind that field names are case-sensitive.

How To Work With Dates

Before we discuss how to work with dates in your scripts, we need to point out that there are two types of date fields: date-only and date-time. Date-only fields only contain a date. Date-time fields contain both a date and a time. The following topics describe how to work with dates on the various step types.

Note: If you're working with a field that resides on the database (as opposed to a temporary storage field), the database field name will tell you what type of date it is: date-only fields are suffixed with **DT**, and date-time fields are suffixed with **DTTM**.

Move Data

If you intend to use a **Move data** step to populate a *date-time* field, please be aware of the following:

- If the destination field resides in the *page data model*, the source field value must be in the format YYYY-MM-DD-HH.MM.SS or YYYY-MM-DD. If the field is in the format YYYY-MM-DD, the time of 12:00 am will be defaulted.
- If the destination field resides in the *user interface*, you must use two steps if you want to populate both date and time. To explain this, we'll assume the field you want to populate is called EXPIRE_DTTM:
 - First, you populate the date portion of the field. To do this, you'd move a date (this value can be in any valid date format that a user is allowed to enter) to a field called EXPIRE_DTTM_FWDDTM_P1. In other words, you suffix **_FWDDTM_P1** to the field name.
 - If you want to populate the time, you'd move the time (again, the field value can be in any format that a user could use to enter a time) to a field called EXPIRE_DTTM_FWDDTM_P2. In other words, you suffix **_FWDDTM_P2** to the field name.

If you intend to use a **Move data** step to populate a *date-only* field, please be aware of the following:

- If the destination field resides in the *page data model*, the source field value must be in the format YYYY-MM-DD.
- If the destination field resides in the *user interface*, the source field can be in any valid date format that a user is allowed to enter.

Note: **%CURRENT-DATE**. Keep in mind that the *global variable* **%CURRENT-DATE** contains the current date and you can move this to either a page data model, user interface, or temporary storage field. If you move **%CURRENT-DATE** to a temporary storage fields, it is held in the format YYYY-MM-DD.

Mathematical Operation

If you intend to use a **Mathematical operation** step to calculate a date, you can reference both date-only and date-time fields. This is because mathematical operations are only performed against the date portion of date-time fields.

Mathematical operations are limited to adding or subtracting days, months and years to / from a date.

Note: A useful technique to perform date arithmetic using the current date is to move the *global variable* **%CURRENT-DATE** to a temporary storage field and then perform the math on this field.

Input Data

If you intend to use an **Input data** step on a *date-time* field, please be aware of the following:

- If the field resides in the *page data model*, the user must enter a value in the format YYYY-MM-DD-HH.MM.SS (and therefore we do not recommend doing this).
- If the field resides in the *user interface*, you must use two steps if you want to populate both date and time. To explain this, we'll assume the field you want to populate is called EXPIRE_DTTM:
 - First, you populate the date portion of the field. To do this, you'd input the date (this value can be in any valid date format that a user is allowed to enter) in a field called EXPIRE_DTTM_FWDDTM_P1. In other words, you suffix **_FWDDTM_P1** to the field name.

- If you want to populate the time, you'd input the time (again, the field value can be in any format that a user could use to enter a time) in a field called EXPIRE_DTTM_FWDTTM_P2. In other words, you suffix **_FWDDTM_P2** to the field name.

If you intend to use an **Input data** step to populate a *date-only* field, please be aware of the following:

- If the field resides in the *page data model*, the user must enter a value in the format YYYY-MM-DD (and therefore we do not recommend doing this).
- If the field resides in the *user interface*, the user can enter any valid date format.

How To Use To Do Fields

As described under [Executing A Script When A To Do Entry Is Selected](#), you can set up the system to automatically launch a script when a user selects a To Do entry. These types of scripts invariably need to access data that resides on the selected To Do entry. The following points describe the type of information that resides on To Do entries:

- **Sort keys.** These values define the various ways a To Do list's entries may be sorted. For example, when you look at the bill segment error To Do List, you have the option of sorting the entries in error number order, account name order, or in customer class order. There is a sort key value for each of these options.
- **Message parameters.** These values are used when the system finds *%n* notation within the message text. The *%n* notation causes field values to be substituted into a message before it's displayed. For example, the message text **The %1 non-cash deposit for %2 expires on %3** will have the values of three fields merged into it before it is displayed to the user (%1 is the type of non-cash deposit, %2 is the name of the customer, and %3 is the expiration date of the non-cash deposit). Each of these three values is stored as a separate message parameter on the To Do entry.
- **Drill keys.** These values are the keys passed to the page if a user drilled down on the entry (and the system wasn't set up to launch a script). For example, a To Do entry that has been set up to display an account on the account maintenance page has a drill key of the respective account ID.
- **To Do ID.** Every To Do entry has a unique identifier referred to as its To Do ID.

You can access this information in the following types of steps:

- **Move Data** steps can move any of the above to any data area. For example, you might want to move a To Do entry's drill key to the page data model so it can be used to navigate to a specific page.
- **Conditional Branch** steps can perform conditional logic based on any of the above. For example, you can perform conditional logic based on a To Do entry's message number (note, message numbers are frequently held in sort keys).
- **Mathematical Operation** steps can use the above in mathematical operations.

A To Do entry's sort key values are accessed by using a **Field Type** of **Current To Do Information** and a **Field Name** of **SORTKEY[index]**. Note, you can find an entry's potential sort keys by displaying the entry's To Do type and navigating to the [Sort Keys](#) tab. If you want to reference the first sort key, use an index value of **1**. If you want to use the second sort key, use an index value of **2** (and so on).

A To Do entry's drill key values are accessed by using a **Field Type** of **Current To Do Information** and a **Field Name** of **DRILLKEY[index]**. Note, you can find an entry's potential drill keys by displaying the entry's To Do type and navigating to the [Drill Keys](#) tab. If you want to use the first drill key, use an index value of **1**. If you want to use the second drill key, use an index value of **2** (and so on).

A To Do entry's message parameters are accessed by using a **Field Type** of **Current To Do Information** and a **Field Value** of **MSGPARAM[index]**. Note, because a To Do type can have an unlimited number of messages and each message can have different parameters, finding an entry's message parameters requires some digging. The easiest way to determine these values is to display the To Do entry on [To Do maintenance](#). On this page, you will find the entry's message category/number adjacent to the description. Once you know these values, display the message category/number on [Message Maintenance](#). You'll find the message typically contains one or more *%n* notations (one for each message parameter). For example, the message text **The %1 non-cash deposit for %2 expires on %3** has three message parameters. You then need to deduce what each of the message parameters are. You do this by comparing the message on the To Do entry with the

base message (it should be fairly intuitive as to what each message parameter is). If we continue using our example, %1 is the non-cash deposit type, %2 is the account name, and %3 is the expiration date. You can access these in your scripts by using appropriate index value in **MSGPARAM[index]**.

A To Do entry's unique ID is accessed by using a **Field Type** of **Current To Do Information** and a **Field Value** of **TD_ENTRY_ID**.

In addition, any of the above fields can be *substituted into a text string or prompt*. Simply prefix the To Do field name with a % as you would fields in temporary storage. For example, assume you want your script to display the following text in the script area: "ABC Supply does not have a bill cycle" (where ABC Supply is the account's name). If the first sort key linked to the To Do entry contains the account's name, you'd enter a text string of **%SORTKEY[1] does not have a bill cycle**.

How To Reference Fields In Data Areas

Various step types involve referencing field elements residing in the *script's data areas*. To reference an element in a data area you need to provide its absolute XPath notation starting from the data area name. For example, use "CaseLogAdd/caseID" to reference a top-level "caseID" element in a script data area called "CaseLogAdd".

You don't have to type in long XPath notions. Use the **View Script Schema** hyperlink provided on the *Script - Step* tab page to launch the script's data areas schema.

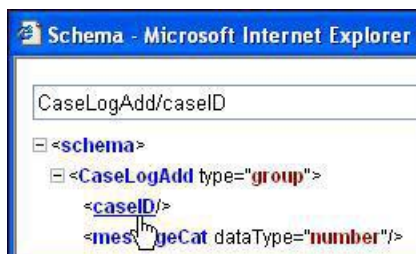

Figure 2: Schema Viewer

Doing this opens the *schema viewer* window where you can:

- Click on the field element you want to reference in your script step. The system automatically populates the text box on the top with the element's absolute XPath notation.
- Copy the element's XPath notation from the text box to your script.

You can also use the **View Data Area**, **View Service Script Data Area**, or **View Plug-In Script Data Area** links on *Script - Data Area* to the same effect. These open up the schema viewer for a specific data area respectively.

Script - Data Area

Use this page to define the data areas used to pass information to and from the server or any other data area describing your temporary storage. Open this page using **Admin Menu > Script** and then navigate to the **Data Area** tab.

Description of Page

The grid contains the script's data areas declaration. For steps that invoke an object that is associated with a schema, you must declare the associated schema as a data area for your script. In addition, if you have defined one or more data areas to describe the script's temporary storage, you need to declare them too. The following bullets provide a brief description of each field on a script data area:

- **Schema Type** defines the type of schema describing the data area's element structure.
- The data area's schema is the one associated with the referenced **Object**. Only objects of the specified Schema Type may be selected.

- **Data Area Name** uniquely identifies the data area for referencing purposes. By default, the system assigns a data area with the associated object name.
- Click on the **View Data Area** link to view the data area's schema in the *schema viewer* window.

The **View Service Script Data Area** link appears for service scripts only. Use this link to view the script's parameters data area schema in the *schema viewer* window.

The **View Plug-In Script Data Area** link appears for plug-in scripts only. Use this link to view the script's parameters data area schema in the *schema viewer* window.

Fastpath: Refer to *A Script May Declare Data Areas* for more information on data areas.

Script - Schema

Use this page to define the data elements passed to and from a service script. Open this page using **Admin Menu > Script** and then navigate to the **Schema** tab.

Note: Conditional tab page. This tab page only appears for *service scripts*.

Description of Page

The contents of this section describe the zones that are available on this portal page.

The **General Information** zone displays the script name and description.

The *Schema Designer* zone allows you to edit the service script's parameters schema. The purpose of the schema is to describe the input and output parameters used when invoking the script.

Note: Script Definition Tips. A context sensitive "Script Tips" zone is associated with this page. The zone provides a complete list of the XML nodes and attributes available to you when you construct a schema as well as other useful information assisting with setting up scripts.

The **Schema Usage Tree** zone summarizes all cross-references to this schema. These may be other schemas including this schema in their structure definition, scripts and XAI Inbound Services. For each type of referencing entity, the *tree* displays a summary node showing a total count of referencing items. The summary node appears if at least one referencing item exists. Expand the node to list the referencing items and use their description to navigate to their corresponding pages.

Script - Eligibility

Use this page to define a script's eligibility rules. Open this page using **Admin Menu > Script** and then navigate to the **Eligibility** tab.

Note: Conditional tab page. This tab page only appears for *BPA scripts*.

Description of Page

Use the **Eligibility Option** to indicate whether the script is **Always Eligible**, **Never Eligible** or to **Apply Eligibility Criteria**. The remaining fields on the page are only visible if the option is **Apply Eligibility Criteria**.

Caution: The following information is not intuitive; we strongly recommend that you follow the guidelines under *The Big Picture Of Script Eligibility* before attempting to define this information.

The **Eligibility Criteria Group** scroll contains one entry for each group of eligibility criteria. The following fields may be defined for each group:

- Use **Sort Sequence** to control the relative order in which the group is executed when the system determines if the script should appear in the *script search*.
- Use **Description** and **Long Description** to describe the criteria group.

- Use **If Group is True** to define what should happen if the eligibility criteria (defined in the following grid) return a value of **True**.
 - Choose **Eligible** if this script should appear.
 - Choose **Ineligible** if this script should not appear.
 - Choose **Check Next Group** if the next criteria group should be checked.
- Use **If Group is False** to define what should happen if the eligibility criteria (defined in the following grid) return a value of **False**.
 - Choose **Eligible** if this script should appear.
 - Choose **Ineligible** if this script should not appear.
 - Choose **Check Next Group** if the next criteria group should be checked.

The grid that follows contains the script's eligibility criteria. Think of each row as an "if statement" that can result in the related eligibility group being true or false. For example, you might have a row that indicates the script is eligible if the current account in context belongs to the residential customer class. The following bullets provide a brief description of each field on an eligibility criterion. Please refer to [Defining Logical Criteria](#) for several examples of how this information can be used.

- Use **Sort Sequence** to control the order in which the criteria are checked.
- Use **Criteria Field** to define the field to compare:
 - Choose **Algorithm** if you want to compare anything other than a characteristic. Push the adjacent search button to select the algorithm that is responsible for retrieving the comparison value. Click [here](#) to see the algorithm types available for this plug-in spot.
 - Some products may also include an option to choose **Characteristic**. Choosing this option displays adjacent fields to define the object on which the characteristic resides and the characteristic type. The objects whose characteristic values may be available to choose from depend on your product.
- Use **Criteria Comparison** to define the method of comparison:
 - Choose **Algorithm** if you want an algorithm to perform the comparison and return a value of True, False or Insufficient Data. Push the adjacent search button to select the algorithm that is responsible for performing the comparison. Click [here](#) to see the algorithm types available for this plug-in spot.
 - Choose any other option if you want to compare the **Criteria Field** using a logical operator. The following options are available:
- Use **>**, **<**, **=**, **>=**, **<=**, **<>** (not equal) to compare the **Criteria Field** using standard logical operators. Enter the comparison value in the adjacent field.
- Use **IN** to compare the **Criteria Field** to a list of values. Each value is separated by a comma. For example, if a field value must equal **1, 3 or 9**, you would enter a comparison value of **1,3,9**.
- Use **BETWEEN** to compare the **Criteria Field** to a range of values. For example, if a field value must be between **1 and 9**, you would enter a comparison value of **1,9**. Note, the comparison is inclusive of the low and high values.
- The next three fields control whether the related logical criteria cause the eligibility group to be considered true or false:
 - Use **If True** to control what happens if the related logical criterion returns a value of True. You have the options of **Group is true**, **Group is false**, or **Check next condition**. If you indicate **Group is true** or **Group is false**, the script is judged **Ineligible** or **Eligible** based on the values defined above in **If Group is False** and **If Group is True**.
 - Use **If False** to control what happens if the related logical criterion returns a value of False. You have the options of **Group is true**, **Group is false**, or **Check next condition**. If you indicate **Group is true** or **Group is false**, the script is judged **Ineligible** or **Eligible** based on the values defined above in **If Group is False** and **If Group is True**.
 - Use **If Insufficient Data** to control what happens if the related logical criterion returns a value of "Insufficient Data". You have the options of **Group is true**, **Group is false**, or **Check next condition**. If you indicate **Group is true** or

Group is false, the script is judged **Ineligible** or **Eligible** based on the values defined above in **If Group is False** and **If Group is True**.

Merging Scripts

Use the Script Merge page to modify an existing script by copying steps from other scripts. The following points summarize the many diverse functions available on the Script Merge transaction:

- You can use this transaction to renumber steps (assign them new sequence numbers).
- You can use this transaction to move a step to a different position within a script. When a step is moved, all references to the step are changed to reflect the new sequence number.
- You can use this transaction to delete a step.
- You can use this transaction to copy steps from other scripts. For example,
 - You may want to create a script that is similar to an existing script. Rather than copying all the information from the existing script and then removing the inapplicable steps, this page may be used to selectively copy steps from the existing script to the new script.
 - You may have scripts that are very similar, but still unique. You can use this transaction to build large scripts from smaller scripts. In this scenario, you may choose to create special 'mini' scripts, one for each of the various options that may make a script unique. Then, you could use the script merge page to select and merge the mini scripts that are applicable for a main script.

Note: The target script must exist prior to using this page. If you are creating a new script, you must first create the *Script* and then navigate to the merge page to copy step information.

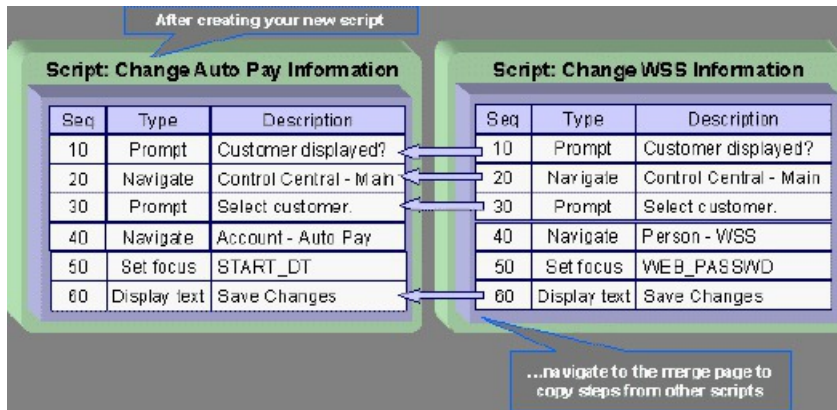

Note: Duplicate versus Merge. The *Script* page itself has *duplication* capability. You would duplicate a script if you want to a) create a new script AND b) populate it with *all* the steps from an existing script.

Script Merge

Open **Admin Menu > Script Merge** to open this page.

Description of Page

For **Original Script**, select the target script for merging steps.

For **Merge From Script**, select the template script from which to copy the steps.

Note: You may only copy steps from one Merge From script at a time. If you want to copy steps from more than one script, select the first Merge From script, copy the desired steps, save the original script, and then select the next Merge From script.

The left portion of the page displays any existing steps for the **Original Script**. The right portion of the page displays the existing steps for the **Merge From Script**.

You can use the **Copy All** button to copy all the steps from the **Merge From** script to the **Original** script. If you use **Copy All**, the steps are added to the end of the original script.

Each time you save the changes, the system rennumbers the steps in the original script using the **Start From Sequence Number** and **Increment By**.

Merge Type indicates **Original** for steps that have already been saved in the original script or **Merge** for steps that have been merged, but not yet saved. The **Sequence**, **Step Type** and **Description** for each step are displayed.

The topics that follow describe how to perform common maintenance tasks:

Resequencing Steps

If you need to resequence the steps:

- Use the up and down arrows in the Original Script grid to reorder the steps.
- Make any desired changes to the **Start From Sequence Number** or **Increment By**.
- Click Save.

The steps are given new sequence numbers according to their order in the grid.

Fastpath: Refer to *Editable Grid* in the system wide standards documentation for more information about adding records to a collection by selecting from a list and repositioning rows within a grid.

Removing a Step from Script

If you want to remove a record linked to the Original script, click the "-" button to the left of the record.

For example, to remove the **Navigate to a page** step, use the "-".

		Merge Type	Sequence	Step Type	Description
[-]	↑ ↓	Original	10	Prompt user	Prompt user
[-]	↑ ↓	Original	20	Navigate to a page	Navigate to
[-]	↑ ↓	Original	30	Display text	Display text

After removal, the grid displays:

		Merge Type	Sequence	Step Type	Description
[-]	↑ ↓	Original	10	Prompt user	Prompt user
[-]	↑ ↓	Original	30	Display text	Display text

Note: You cannot delete a step that is referenced by other steps unless you also delete the referencing steps, such as **Go to step** or **Prompt** type steps. The system informs you of any missing referenced steps when you attempt to save the original script.

Adding a Step to a Script

You can move any of the steps from the Merge From script to the original script by clicking the left arrow adjacent to the desired step. Once a record is moved it disappears from the Merge From information and appears in the Original information with the word **Merge** in the Merge Type column.

For example, to copy the **Prompt user** step, click the left arrow.



Merge Type	Sequence	Step Type	Description
	10	Prompt user	Prompt user - Does the dashboard con
	20	Navigate to a page	Navigate to a page - CI_CC_MAIN(ACI
	30	Set focus to a field	Set focus to a field - (ENTITY_NAME) P

The step is moved to the left portion of the page.

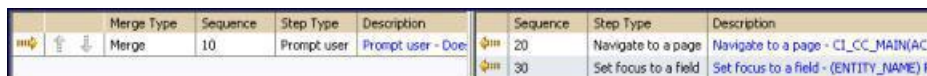

Merge Type	Sequence	Step Type	Description
Merge	10	Prompt user	Prompt user - Doe
	20	Navigate to a page	Navigate to a page - CI_CC_MAIN(ACI
	30	Set focus to a field	Set focus to a field - (ENTITY_NAME) P

Note: If you add a step, such as **Go to step** or **Prompt** type steps, that references other steps, you must also add the referenced steps. The step references are updated to use the new sequence numbers when you save the original script. The system informs you of any referenced steps that haven't been added when you attempt to save the original script.

Removing an Uncommitted Step from a Script

If you have moved a row to the original script by mistake, you can remove it by clicking the right arrow adjacent to the appropriate record.

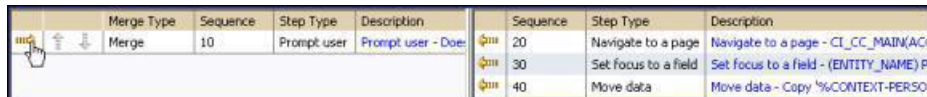

Merge Type	Sequence	Step Type	Description
Merge	10	Prompt user	Prompt user - Doe
	20	Navigate to a page	Navigate to a page - CI_CC_MAIN(ACI
	30	Set focus to a field	Set focus to a field - (ENTITY_NAME) P
	40	Move data	Move data - Copy %CONTEXT-PERSO

Maintaining Functions

Invoke function steps are used to retrieve or update data independent of the page currently being displayed. For example, if you design a script that takes different paths based on the customer's customer class, you could invoke a function to retrieve the customer's customer class. Doing this is much more efficient than the alternative of transferring to the account page and retrieving the customer class from the Main page.

An **Invoke function** step retrieves or updates the relevant data by executing a service (on the server). These types of steps do not refer to the service directly. Rather, they reference a "function" and the function, in turn, references the application service. This means that before your scripts can invoke application services, you must set up functions.

Note: Functions are abstractions of services. A function is nothing more than meta-data defining the name of a service and how to send data to it and retrieve data from it. Functions allow you to define a scriptwriter's interface to services. They also allow you to simplify a scriptwriter's set up burden as functions can handle the movement of data into and out of the service's XML document.

The topics in this section describe how to set up a function.

Note: You can retrieve data from all base-package objects. If you know the name of the base-package "page" application service used to inquire upon an object, you can retrieve the value of any of its fields for use in your scripts.

To do this, set up a function that sends the unique identifier of the object to the service and retrieves the desired fields from it.

Function - Main

Use this page to define basic information about a function. Open this page using **Admin Menu > Function** .

Description of Page

Enter a unique **Function** code and **Description** for the function.

Use the **Long Description** to describe, in detail, what the function does.

Define the **Internal Service** that the function invokes.

Note: In this release, only page services can be invoked.

Click the **View XML** hyperlink to view the XML document used to pass data to and from the service. Doing this causes the XML document to be displayed in the Application Viewer.

Note: XML document may not be viewable. If you create a new page service and do not regenerate the application viewer, you will not be able to view its XML document.

The tree summarizes the following:

- The fields sent to the application service. You can use the hyperlink to transfer to the **Send Fields** tab with the corresponding field displayed.
- The fields received from the application service. You can use the hyperlink to transfer to the **Receive Fields** tab with the corresponding field displayed.
- Scripts that reference the function. You can use the hyperlink to transfer to the script page.

Function - Send Fields

Use this page to add or update the fields sent to the service. Open this page using **Admin Menu > Function** and then navigate to the **Send Fields** tab.

Note: Displaying a specific field. Rather than scrolling through each field, you can navigate to a field by clicking on the respective node in the tree on the Main tab. Also note, you can use the Alt+right arrow and Alt+left arrow accelerator keys to quickly display the next and previous entry in the scroll.

Note: You're defining the application service's input fields. On this tab, you define which fields are populated in the XML document that is sent to the service. Essentially, these are the service's input fields.

Description of Page

Use **Sequence** to define the order of the **Send Fields**.

Enter a unique **Function Field Name** and **Description** for each field sent to the application service. Feel free to enter **Comments** to describe how the field is used by the service.

Use **Field Value Source** to define the source of the field value in the XML document sent to the service:

- If the field's value is the same every time the function is invoked, select **Defined On The Function**. Fields of this type typically are used to support "hard-coded" input values (so that the scriptwriter doesn't have to populate the field every time they invoke the function). Enter the "hard-coded" **Field Value** in the adjacent field.
- If the field's value is supplied by the script, select **Supplied By The Invoker**. For example, if the function retrieves an account's customer class, the script would need to supply the value of the account ID (because a different account ID is

passed each time the function is invoked). Turn on **Required** if the invoker must supply the field's value (it's possible to have optional input fields).

Regardless of the Field Value Source, use **XML Population Logic** to define the XPath expression used to populate the field's value in the XML document sent to the service.

Note: Usability suggestion. You populate a field's value in an XML document by specifying the appropriate XPath expression for each field. Rather than referring to an XPath manual, the system can create the XPath expression for you. To do this, click the adjacent **View XML** hyperlink. This will display the XML document used to communicate with the **Service** defined on the Main page. After the XML document is displayed, click the **XPath** hyperlink adjacent to the desired field to see how the XPath expression looks. You can then cut / paste this XPath expression into the **XML Population Logic Field**.

Function - Receive Fields

Use this page to add or update the fields received from the service. Open this page using **Admin Menu > Function** and then navigate to the **Receive Fields** tab.

Note: Displaying a specific field. Rather than scrolling through each field, you can navigate to a field by clicking on the respective node in the tree on the Main tab. Also note, you can use the Alt+right arrow and Alt+left arrow accelerator keys to quickly display the next and previous entry in the scroll.

Note: You're defining the application service's output fields. On this tab, you define which fields are populated in the XML document that is received from the service. Essentially, these are the service's output fields.

Description of Page

Use **Sequence** to define the order of the **Receive Fields**.

Enter a unique **Function Field Name** and **Description** for each field received from the service. Feel free to enter **Comments** to describe the potential values returned from the service.

Turn on **Required** if the invoker must use the field.

Regardless of the Field Value Source, use **XML Population Logic** to define the XPath expression used to retrieve the field's value from the XML document received from the service.

Note: Usability suggestion. You retrieve a field's value in an XML document by specifying the appropriate XPath expression for the field. Rather than referring to an XPath manual, the system can create the XPath expression for you. To do this, click the adjacent **View XML** hyperlink. This will display the XML document used to communicate with the **Service** defined on the Main page. After the XML document is displayed, click the **XPath** hyperlink adjacent to the desired field to see how the XPath expression looks. You can then copy / paste this XPath expression into the **XML Population Logic Field**.

Chapter 10

Data Synchronization

Note: The information in this section applies to the integration with Oracle Utilities Meter Data Management and/or Oracle Utilities Network Management System.

Defining Sync Requests

This section highlights functionality provided to help an implementation manage the communication of data to an external system.

The Big Picture of Sync Requests

Your implementation may need to communicate certain data to external systems. This may be part of a data warehousing requirement or an integration effort. The synchronization process has two main parts. First, the change to the data must be detected and captured. Once that is accomplished, the next step is to manage the communication of that change to the external systems involved. The changes must be captured in chronological order so as to avoid systems going out of sync.

Capturing the Change

The base product has provided the **Audit** plug-in spot on the MO to allow for processing to be called by the system upon detecting a change to an MO. The framework calls the algorithm defined on this plug-in spot in the event a change to the MO has been detected. The base product comes with a generic change data capture algorithm **F1-GCHG-CDCP** that makes use of this plug-in spot to create the sync request BOs. The **Sync Request BO** MO Option is used to define these sync request BOs. The generic algorithm loops through this list of BOs and instantiates them, if no instances of those BOs yet exist in the initial state. The MO and primary key used for these sync requests will be the MO being modified and its primary key.

Sometimes it is necessary to instantiate a sync request whose MO is different from the MO being modified. As an example, a change to the Person record may need to instantiate an SA sync request. In this case, your implementation will have to create your own Audit algorithm that captures this idiosyncratic logic. For examples on how this is done, please refer to the *Oracle Utilities CCB-MDM Integration Implementation Guide*.

Sync Request Maintenance Object

The sync request maintenance object (MO) is used to communicate data elements to an external system. It holds the data elements that are to be synchronized or extracted out of your system and also holds the MO and primary key constituents that drive the sync request. If your organization wishes to use this MO, you can either use the business object (BO) supplied in the base product or configure your own BO.

This MO provides the following functionality:

- A business object option **External System** is provided for business objects of this type. The value specified on this option is used by the base product to create an entry in the JMS Queue.
- A business object option **Outbound Message Type** is provided for business objects of this type. The value specified on this option is used by the base product to create an entry in the JMS Queue.
- An **Information** algorithm is provided (**F1-SYNC-INFO**).
- The standard **Determine BO** algorithm is provided.
- The standard logs are provided.
- The standard characteristics collection is provided.

Where Used

Follow this link to open the data dictionary where you can view the tables that reference F1-SYNC REQ.

For more information about this MO and to review the business objects defined for this MO, navigate to **Admin, Maintenance Object** and view the **MO F1-SYNC REQ**.

Sync Request Business Object

The sync request business object (BO) contains the rules that govern the processing of a sync request. The algorithms in this BO control what data elements are synchronized to an external system; how this data is to be communicated to the external system; and how the communication of this information is controlled chronologically to ensure that changes are processed in the right order. The base product provides the BO **F1-SyncRequest**, which contains the following life cycle.

- **Pending.** The initial state of the sync request BO. At this point, a pre-processing algorithm would have already taken a snapshot of what the relevant information looked like prior to the change. A deferred monitor algorithm is specified on this state so as to accumulate all changes prior to sending the sync request to the external system. Furthermore, in order to prevent the sync request from transitioning to the next state while another sync request may not have completed its processing yet, the base package provides the monitor algorithm **F1-WAITRELSR** that skips transitioning if it detects another instance of the same BO in a non-final state for the same MO and primary key combination.
- **Determine If Sync Needed.** This transitory state will contain the algorithm that takes the final snapshot of the relevant information so that it may be compared against the initial snapshot to see if the change affected any of the relevant data elements. The base product provides the algorithm **F1-COMPSNAPS** for this purpose. Your implementation may also add your own rules here to discard the sync request if certain criteria are met.
- **Discarded.** If the comparison of the initial and final snapshots yields no changes, or if it fails any other checks your implementation has introduced, the sync request is transitioned to this state. If any processes are dependent on the sync

request transitioning to a final state, your implementation may plug in an enter algorithm on this state to kick off the dependent process.

- **Send Request.** This transitory state is used to hold the algorithm that facilitates the sending of the sync request to the external system. The algorithm used here may write a message to a JMS Queue or write a record to the general process MO or perform any other task that is suited to how your implementation communicates the change.
- **Awaiting Acknowledgement.** This state can be used to hold the sync request from further state transitions until an acknowledgement is received from the external system. We strongly recommend designing some form of acknowledgement that the external system has processed the information as this helps control the chronological flow of information. The base package provides the business service **F1-UpdateSyncRequest** that transitions the sync request to either the next default state (in this case the Synchronized state) if a positive acknowledgement is received; or the state associated with the Rejection transition condition (in this case the Error state) if a negative acknowledgement is received.
- **Synchronized.** Once the information has been processed and acknowledged by the external system, the sync request is transitioned to this state. If any processes are dependent on the sync request processing successfully, your implementation may want to plug in an enter algorithm on this state to kick off the dependent process.
- **Error.** If a negative acknowledgement is received or if the acknowledgement is not received within the prescribed period of time, the sync request is transitioned to this state. Your implementation may wish to create a to do entry when the sync request transitions to this state. The base product provides the enter algorithm **F1-TDCREATE** for this purpose. The exit algorithm **F1-TODOCOMPL** has also been provided to complete any to do entries when leaving this state.
- **Canceled.** A user may transition the sync request to this state from either the **Awaiting Acknowledgement** state or the **Error** state if he wishes to discontinue processing of the sync request for any reason. Your implementation will have to configure your own cancel reasons to document the transition. If any processes need to be triggered when the sync request reaches this state, your implementation can plug in an enter algorithm containing such logic.

Designing Your Sync Requests

The starting point for designing sync requests is the analysis of the external system's data requirements. Your implementation will need to analyze the external system's data model and compare it against your system's data model. Where the relevant data reside in your system will need to be identified. If the data reside in more than one MO, a decision must be made to either combine the information in one sync request or to break up the sync request into several ones.

For each sync request identified, the driving MO must be determined. The BO for each sync request can then be created as a sub-class of the base BO **F1-SyncRequest**. For an example of how these BOs are configured, please refer to *Oracle Utilities CCB-MDM Integration Implementation Guide* or *Oracle Utilities CCB-NMS Integration Implementation Guide*.

Sync Requests

The Sync Request portal is used to view information about data synchronizations from Oracle Utilities Customer Care and Billing to Oracle Utilities Meter Data Management, or from Oracle Utilities Customer Care and Billing to Oracle Utilities Network Management System. Navigate to this portal by using **Main Menu, Customer Information, Sync Request Search**.

Sync Request Query

Use the [query portal](#) to search for an existing Sync Request. Once a Sync Request record is selected, you are brought to the maintenance portal to view and maintain the selected record.

Sync Request Portal

This portal appears when a sync request has been selected from the Sync Request Query portal.

The topics in this section describe the base-package zones that appear on this portal.

Sync Request Actions

This is a standard **actions zone**.

If the Sync Request is in a state that has valid next states, buttons to transition to each appropriate next state are displayed.

Related Sync Request

The Related Sync Request zone shows all related sync requests that are in a non-final state. Refer to the zone's help text for additional information about this zone's fields.

Sync Request

The Sync Request zone shows display-only information about the sync request. Refer to the zone's help text for additional information about this zone's fields.

Sync Request - Log

The sync request log page contains an entry for every recorded event during the lifecycle of the sync request. There are two general types of log entries:

- **Automatic entries.** The system automatically creates an entry in the log when usage is requested or there is a status change or when a related entity is created. This also includes any implementation-specific log entries. Users cannot modify or delete these log entries.
- **Manual entries.** Users can add manual entries to record significant events at their discretion.

Chapter 11

Application Viewer

The Application Viewer allows you to explore meta-data driven relationships and other deliverable files online.

Note: Running Stand-Alone. You can also launch the Application Viewer as a stand-alone application (i.e., you do not need to start it from within the system). Refer to [Application Viewer Stand-Alone Operation](#) for more information about running the Application Viewer as a stand-alone application.

To open the application viewer from within your application, navigate to **Admin Menu > Application Viewer** . The application viewer may also be launched from other locations for example when viewing a section of the online help files that contain hypertext for a table name, clicking on that hypertext brings you to the definition of that table in the data dictionary.

Application Viewer Toolbar

The Tool Bar provides the main controls for using the Application Viewer. Each button is described below.

Data Dictionary Button



The **Data Dictionary** button switches to the Data Dictionary application.

Physical and Logical Buttons



The **Physical** button changes the display in the List Panel from a logical name view to a physical name view. Note that the Tables are subsequently sorted by the physical name and therefore may not be in the same order as the logical name view. Once clicked, this button toggles to the Logical button.

The **Logical** button changes the display in the List Panel from a physical name view to a logical name view. Note that the Tables are subsequently sorted by the logical name and therefore may not be in the same order as the physical name view. Once clicked, this button toggles to the Physical button.

These buttons are only available in the Data Dictionary.

Collapse Button



The **Collapse** button closes any expanded components on the list panel so that the child items are no longer displayed.

This button is only available in the Data Dictionary viewer.

Attributes and Schema Button

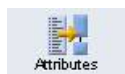

The **Attributes** button changes the display in the Detail Panel from a related tables view to an attribute view. Once clicked, this button toggles to the Schema button.



The **Schema** button changes the display in the Detail Panel from an attribute view to a related tables view. Once clicked, this button toggles to the Attributes button. Note that only tables have this view available. Columns are always displayed in an attribute view.

These buttons are only available in the Data Dictionary.

Maintenance Object Button



The **Maintenance Object** button switches to the Maintenance Object viewer application.

Group and Ungroup List Buttons

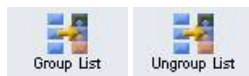

The **Group List** button groups the list of maintenance objects by the function modules they are associated with. A maintenance object may appear in multiple groups if it is part of more than one module. Once clicked, this button toggles to the Ungroup List button.

The **Ungroup List** lists the maintenance objects in alphabetical order. Once clicked, this button toggles to the Group List button.

These buttons are only available in the Maintenance Object viewer.

Algorithm Button



The **Algorithm** button switches to the Algorithm viewer application.

Batch Control Button

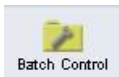

The **Batch Control** button switches to the Batch Control viewer application.

To Do Type Button



The **To Do Type** button switches to the To Do Type viewer application.

Description and Code Buttons



The **Description** button changes the display in the List Panel to Description (Code) from Code (Description). Note that the list is subsequently sorted by the description. Once clicked, this button toggles to the Code button.

The **Code** button changes the display in the List Panel to Code (Description) from Description (Code). Note that the list is subsequently sorted by the Code. Once clicked, this button toggles to the Description button.

These buttons are only available in the Batch Control and To Do Type viewers.

Cobol Source Button



Note: This functionality is not available in every product. This button only appears when you are using a product that supports COBOL.

The **Cobol Source** button switches to the Source Code viewer. This button is not available when you are already in the Source Code viewer.

You are prompted to enter the name of the source file you want to view. The name of the source code file should be entered without the extension.



A dialog box with a title bar. It contains a text input field labeled "Source File Name" and two buttons: "Load" and "Cancel".

Load Source Button



The **Load Source** button loads another source file that you specify. This button is only available in the Source Code viewer. You are prompted to enter the name of the source file you want to view. The name of the source code file should be entered without the extension.



A dialog box with a title bar. It contains a text input field labeled "Source File Name" and two buttons: "Load" and "Cancel".

Used By and Uses Buttons



The **Used By** switches the tree in the list panel to a child-parent view. The source file is used by the files listed in the tree. Once clicked, this button toggles to the Uses button.

The **Uses** button switches the tree in the list panel to a parent-child view. The source file uses the files listed in the tree. Once clicked, this button toggles to the Used By button.

These buttons are only available in the Source Code viewer.

Service XML Button



The **Service XML** button switches to the Service XML viewer. This button is not available when you are already in the Service XML viewer.

You are prompted to enter the name of the service XML file you want to view. The name of the service XML file should be entered without the extension.



A dialog box with a title bar. It contains a text input field labeled "Service XML Name" and two buttons: "Load" and "Cancel".

Select Service Button



The **Select Service** button loads another service XML file that you specify. This button is only available in the Service XML viewer.

You are prompted to enter the name of the service XML file you want to view. The name of the service XML file should be entered without the extension.

Java Docs Button



The **Java Docs** button switches to the Java Docs viewer.

Classic Button



This button is only available in the Java Docs viewer.

The **Classic** button launches the classic Javadocs viewer on a separate window. If you are more comfortable with that look you can use this viewer instead.

Preferences Button



The **Preferences** button allows you to set optional switches used by the Application Viewer. Refer to [Application Viewer Preferences](#) for more information.

Help Button



The **Help** button opens the Application Viewer help system. You used this button to access this information.

About Button

The **About** button opens a window that shows when was each Application Viewer data component recently built.

Data for all application viewer components may be regenerated to incorporate up-to-date implementation-specific information. Refer to [Application Viewer Generation](#) for further details.

Slider Icon



This "slider" icon allows you to resize the list panel and detail panel to your preferred proportions.

Data Dictionary

The data dictionary is an interactive tool that allows you to browse the database schema and to graphically view relationships between tables in the system.

To open the data dictionary, click the [Data Dictionary button](#). You can also open the data dictionary by clicking the name of a table in other parts of the application viewer or in the online help documentation.

Note: Data Is Generated. A background process generated the data dictionary information. Refer to [Application Viewer Generation](#) for further details.

Using the Data Dictionary List Panel

The list panel displays a list of tables and their columns. The list panel can list the table names by either their logical names or their physical names. Click the appropriate [button](#) on the tool bar to switch between the two views. The list is displayed in alphabetical order, so the order may not be the same in both views. Both views function in a similar manner.

In the list panel, you can navigate using the following options:

- Click the right arrow icon to expand a table to show its columns.
- Click the down arrow icon to collapse the column list for a table. Optionally, collapse all column lists by using the **Collapse** button.
- Click the column name to display information about the column in the detail panel.
- If the detail panel is in [related table](#) view, click the table name to view its related tables. If the detail panel is in [table detail](#) view, click the table name to display its information.

Primary And Foreign Keys

The columns in the list panel may display key information as well as the column name:

- A yellow key indicates that the column is a primary key for the table.
- A light blue key indicates that the column is a foreign key to another table. If you hover the cursor over the icon, the tool tip indicates the foreign table.

- A dark blue key indicates that the column is a conditional foreign key. A conditional foreign key represents rare relationships between tables where a single field (or set of fields) may reference multiple primary key constraints of other tables within the application as a foreign key.
- A red key indicates that the column is a logical key field. A logical key represents an alternate unique identifier of a record based on a different set of fields than the primary key.

If you hover your cursor over an icon, the tool tip indicates the key type.

Field Descriptions Shown

The language-specific, logical name of each field is shown adjacent to the physical column name in the data dictionary. You can enter an override label for a *table / field's* to be used throughout the system as the field's logical name. Here too it is the override label that is shown.

Note: Regenerate. You should regenerate the data dictionary after overriding labels. Refer to [Application Viewer Generation](#) for further details.

Using the Data Dictionary Detail Panel

The Data Dictionary detail panel displays the details of the selected item. There are three main displays for the Detail Panel:

- Related tables view
- Table detail view
- Column detail view

Related Tables View

The Related Tables view displays information about the table's parent tables and child tables. Click the [Schema](#) button in the tool bar to switch to related tables view.

In the related tables view, you can navigate using the following options:

- Click the left arrow and right arrow icons to view the related tables for that linked table. The List Panel is automatically positioned to the selected table.
- Click the maintenance object icon () to view the table's maintenance object.
- If you want to position the [List Panel](#) to view the columns for different table click the name of the table for which you want to view the columns.

Table Detail View

The table detail view displays information about the selected table. Click [Attributes](#) (in the toolbar) to switch to the table detail view.

In the table detail view, you can navigate using the following options:

- If user documentation is available for the table, click the View User Documentation link to read the user documentation that describes the table's maintenance object.
- If the table has an associated Language Table, click the link to view the Language Table details.

- If there is an associated Maintenance Program, click the link to view the source code for the maintenance program (you are transferred to the [Source Code Viewer](#)).
- If there is an associated Key Table, click the link to view the Key Table details.

Column Detail View

Click on a column name in the list panel to switch to the column detail view. The Column Detail view displays information about the selected column.

In the column detail view, you can navigate using the following options:

- If user documentation is available for the column, click the View User Documentation link to read about the column's related maintenance object.
- If the column is a foreign key, click the table name to switch to the Table Detail view for that table.
- If the column has a Field Validation Copybook available (normally only present for flag and switch fields), click the link to view the source code for the copybook (you are transferred to the [Source Code Viewer](#)).

Lookup Values

If the selected column is a lookup field its valid values are also listed. Notice that you can enter an override description for [lookup values](#). In this case the override description is shown.

Note: Regenerate. You should regenerate the data dictionary after overriding lookup value descriptions. Refer to [Application Viewer Generation](#) for further details.

Maintenance Object Viewer

The maintenance object viewer is an interactive tool that allows you to view a schematic diagram of a maintenance object. A maintenance object is a group of tables that are maintained as a unit.

To open the Maintenance Object Viewer, click the [Maint. Object](#) button in the application viewer or click a [maintenance object icon](#) in the Data Dictionary.

Note: Data Is Generated. A background process generated the maintenance object information. Refer to [Application Viewer Generation](#) for further details.

Using the Maintenance Object List Panel

The list panel displays a list of maintenance objects. The list panel can also group the maintenance objects by their function module. Click the appropriate [button](#) on the tool bar to switch between the grouped and ungrouped lists. The grouped list may include a maintenance object more than once (if it is included in more than one module).



In the list panel, you can navigate using the following options:

- If the list panel is grouped, click the right pointer ► icon to expand a module and view its maintenance objects.
- If the list panel is ungrouped, click the down pointer ▼ icon to collapse the list of maintenance objects for a module.
- Click the maintenance object name to display information about the maintenance object in the detail panel.

Using the Maintenance Object Detail Panel

The Maintenance Object detail panel displays a schematic of the selected maintenance object.

In the detail panel, you can navigate using the following options:

- Click a table name to transfer to the Data Dictionary *table detail view* for a table. (Click the *Maint. Object* button in the tool bar to return to the maintenance object.)
- Click the source code icon () to view the Service Program used to maintain the displayed object. (Click the *Main. Object* button in the tool bar to return to the maintenance object.)
- Click the service XML icon () to view the XML file of the Service Program used to maintain the displayed object. (Click the *Maintenance Object* button in the tool bar to return to the maintenance object.)

Algorithm Viewer

The algorithm viewer is an interactive tool that allows you to view algorithm types (grouped by their plug-in spot) and their related algorithms.



To open the Algorithm Viewer, click the *Algorithm* button in the application viewer. The Algorithm viewer may also be opened from certain locations in the online help documentation.

Note: Data Is Generated. A background process generates algorithm information. Refer to *Application Viewer Generation* for further details.

Using the Algorithm Viewer List Panel

The list panel displays a list of algorithm types and their related algorithms, grouped by their plug-in spot.

In the list panel, you can navigate using the following options:

- Click the algorithm plug-in spot description to display information about the plug-in spot in the detail panel.
- Click the right pointer  icon to expand a plug-in spot and view its algorithm types and their related algorithms.
- Click the down pointer  icon to collapse the list of algorithm types for a plug-in spot.
- Click the algorithm type name to display information about the algorithm type in the detail panel.
- Click the algorithm name to display information about the algorithm in the detail panel.

Using the Algorithm Plug-In Spot Detail Panel

The Algorithm plug-in spot detail panel displays further information about the selected plug-in spot.

Using the Algorithm Type Detail Panel

The Algorithm Type detail panel displays further information about the selected algorithm type.

In the Algorithm Type detail panel, you can navigate using the following options:

- Click on the program name to view its source in the source viewer or Java docs viewer.

Using the Algorithm Detail Panel

The Algorithm detail panel displays further information about the selected algorithm.

Batch Control Viewer

The batch control viewer is an interactive tool that allows you to view batch controls.

To open the Batch Control Viewer, click the [Batch Control](#) button in the application viewer. The Batch Control viewer may also be opened from certain locations in the online help documentation.

Note: Data Is Generated. A background process generates batch control information. Refer to [Application Viewer Generation](#) for further details.

Using the Batch Control Viewer List Panel

The list panel displays a list of batch controls. The list panel can display the list of batch controls sorted by their code or sorted by their description. Click the appropriate [button](#) on the tool bar to switch between sorting by the code and description.

In the list panel, you can click the batch control to display information about the batch control in the detail panel.

Note: Not All Batch Controls Included. Note that the insertion and key generation programs for conversion (CIPV*) are not included.

Using the Batch Control Detail Panel

The batch control detail panel displays further information about the selected batch control.

In the batch control detail panel, you can navigate using the following options:

- Click on the program name to view its source in the source viewer or the Java docs viewer.
- If a To Do type references this batch control as its creation or routing process, click on the To Do type to view its detail in the To Do type viewer.

To Do Type Viewer

The to do type viewer is an interactive tool that allows you to view to do types defined in the system.

To open the To Do Type Viewer, click the [To Do Type](#) button in the application viewer. The To Do Type viewer may also be opened from certain locations in the online help documentation.

Note: Data Is Generated. A background process generates To Do type information. Refer to [Application Viewer Generation](#) for further details.

Using the To Do Type Viewer List Panel

The list panel displays a list of To Do types. The list panel can display the list of To Do types sorted by their code or sorted by their description. Click the appropriate [button](#) on the tool bar to switch between sorting by the code and description.

In the list panel, you can click the To Do type to display information about the To Do type in the detail panel.

Using the To Do Type Detail Panel

The To Do type detail panel displays further information about the selected To Do type.

In the To Do type detail panel, you can navigate using the following options:

- If the To Do type references a creation process or a routing process, click on the batch process to view its detail in the batch control viewer.
- Click on the table listed in the drill key section to view its detail in the data dictionary.
- Click on the field(s) listed in the drill key section to view its detail in the data dictionary.

Source Code Viewer

The source code viewer is an interactive tool that allows you to browse the source code of modules that execute on the application server. It currently supports Cobol modules only.

Note: This functionality is not available in every product. The source code viewer currently supports COBOL modules only. It is available only as part of products that support COBOL.

Note: Proprietary modules. The source code of a small number of modules has been suppressed due to their proprietary nature.

There are many ways to access the source code viewer:

- The [data dictionary](#) allows you to view the source code of the program responsible for validating and updating information on a given table. This feature is implemented by viewing the table's attributes and then drilling down on the maintenance program's name.
- The maintenance object viewer allows you to view the source code of the maintenance object's service program. This feature is implemented by viewing the maintenance object and then clicking on the [source code icon](#).
- If you know the name of a program, you can navigate to the source code viewer and enter the program name. To open the source code viewer from within the application viewer, click the [COBOL Source button](#). When you are prompted to enter the program name, enter the name without the extension.

Using the Source Code Viewer List Panel

The list panel displays a tree of Program Sections, Copybooks, SQL Includes, Programs, and SQL statements that are used by the selected source file. You can change the listed items types using [Application Viewer Preferences](#).

The list panel can list the source code's children (source code that the file uses) or the parents (source code that uses the file). Click the appropriate [>button](#) on the tool bar to switch between the two views.



In the list panel, you can navigate using the following options:

- Click the "+" icon to expand an included source file to view its includes.
- Click the "-" icon to collapse the includes for a source file.
- Click the open folder icon to view the source of a file in the Application Viewer's **detail** panel. The list panel changes to display the source code tree for the file displayed in the detail panel.
- Click an item's name or description to position the detail panel to view that item.

Using the Source Code Viewer Detail Panel

The detail panel displays the source code of the selected file.

You can navigate using the following options:

- If another file is referenced in the code, click the link to view the code for the referenced file. The list panel changes to display the source code tree for the file displayed in the detail panel.
- If a perform statement is referenced in the code, click the link to go to the referenced section.
- When an SQL statement references a table name, click the link to view the table in the *Data Dictionary's related tables* view.
- The  back arrow becomes active once subsequent files of source code are viewed. The name of the source that is displays when the button is clicked appears to the right of the button.
- The  forward arrow becomes active once the back button (described above) is used. The name of the source that is displays when the button is clicked appears to the left of the button.

Service XML Viewer

The service XML viewer is an interactive tool that allows you to browse the XML files of service programs that execute on the application server.

You can access the service XML viewer as follows:

- The maintenance object viewer allows you to view the XML file of the maintenance object's service program. This feature is implemented by viewing the maintenance object and then clicking on the *Service XML icon*.
- When setting up a *Function*, you may want to view the XML document used to pass data to and from the service. Clicking the **View XML** hyperlink causes the XML document to be displayed in the Service XML Viewer.

Using the Service XML Viewer Overview Panel

The overview panel displays a high level nodes and list names structure of the XML document.

In the overview panel, you can click on any node item to position the detail panel to view that item.

Using the Service XML Viewer Detail Panel

The detail panel displays nodes and attributes of the selected XML file.

You can click on the **xpath** button to view the XML path that should be used to reference the selected node in the XML document. The box at the top of the overview panel changes to display this information.

Java Docs Viewer

The Java Docs viewer is an interactive tool that allows you to browse Java documentation files (Javadocs) for Java classes that execute on the application server.

Note: Proprietary Java Classes. A small number of Java classes have been suppressed due to their proprietary nature.

Note: **Classic view.** If you are more comfortable using the classic Javadocs viewer you may use the [Classic](#) button.

To open the Java Docs viewer from within the application viewer, click the [Java Docs button](#). Additionally, the [algorithm viewer](#) allows you to view the Javadocs of an algorithm program written in Java.

Using the Java Docs Viewer List Panel

The list panel displays a tree of Java packages where each package may be expanded to list the Java interfaces classes it includes.

In the list panel, you can navigate using the following options:

- Click the right arrow icon to expand a Java package to view the Java interfaces and classes it includes.
- Click the down arrow icon to collapse the list for a Java package. Optionally, collapse all lists by using the **Collapse** button.
- Click the Java interface or class name to display information about it in the detail panel.

The list details panel designates the interfaces and the classes as follows:

- A green dot indicates Java interfaces.
- A blue key indicates Java classes.

If you hover the cursor over the icon, the tool tip indicates whether it's an interface or a class.

Using the Java Package Detail Panel

The package detail panel displays a summary of the various Java classes that are included in the selected Java package.

Click the Java class name to display information about the Java class in the detail panel.

Using the Java Interface / Class Detail Panel

The detail panel displays Java documentation information about the selected Java interface or class.

You can navigate using hyperlinks to other locations in the current detail panel or to view the details of other Java interfaces / classes.

Application Viewer Preferences

This panel displays Optional Switches that can be used to affect the behavior of the Application Viewer.

When you are using a product that includes the source code viewer, the preferences panel includes Source Tree Icon Display options. These options are used to suppress the display of certain icons from the Source Tree. This is used to (for example) hide the copybooks from the display. Select the items that you want view in the source tree and click OK.

The Available Languages allows you to select the language in which the labels and buttons are displayed. Select your desired language and click OK.

Application Viewer Stand-Alone Operation

You can run the Application Viewer as a stand-alone application (i.e., you do not need to launch it from the online application environment). To run it as a stand-alone application, you should copy the Application Viewer files (all files in the appViewer directory) and the online help files (all files in the help directory) to the server on which you want to run the Application Viewer.

Note: Online Help. If you do not copy the online help files, online help will not be available for the Application Viewer, nor will you be able to view business descriptions of the tables' maintenance objects.

To start the application viewer in stand-alone mode, launch the appViewer.html file (located in the appViewer directory).

Stand-Alone Configuration Options

You can configure the Application Viewer for stand-alone operation by modifying options in a configuration file. The Application Viewer comes with a default configuration file called config_default.xml (located in the appViewer\config directory). Create a copy of the default configuration file and rename it to config.xml. Modify the options described in the following table to suit the needs of your installation.

Note: Default Configuration. If you do not create the config.xml file, the Application Viewer launches with its default (internal) configuration.

Option	Description
defaultLanguage	The default language used when the application viewer is started. Available values are those marked as language enabled on the language page.
defaultView	The default view then the application viewer is started. Available values include: - Data Dictionary - Source Viewer
dataDictionary	Whether the Data Dictionary is available or not: - Y - N
sourceCode	Whether the Source Code Viewer is available or not: - Y - N
baseHelpLocation	The location of the stand-alone online help in relation to the application viewer. Specify the directory structure relative to the location of the directory in which the Application Viewer files are located. Note that this is the directory in which the language subdirectories for the online help are located. The default location is: ../help
appViewerHelp	The default help topic that is launched when the Help button is clicked in the Application Viewer. Specify a help file and anchor that is under the appropriate language directory under the baseHelpLocation. The default is: Framework/Admin/91AppViewer.html#SPLINKApplication_Viewer

Example Application Viewer Configuration

The following excerpt shows an example Application Viewer configuration.

```
<?xml version="1.0" encoding="UTF-8" ?>
<configuration>
<option id="defaultLanguage">PTB</option>
<option id="defaultView">Data Dictionary</option>
<option id="dataDictionary">Y</option>
<option id="sourceCode">Y</option>
<option id="baseHelpLocation">../help</option>
<option id="appViewerHelp">Framework/Admin/91AppViewer.html#SPLINKApplication_Viewer</option>
</configuration>
```

Application Viewer Generation

The Application Viewer is initially delivered with COBOL source and service XML information only.

Note: COBOL source information is only available as part of products that support COBOL.

The other components of the application viewer are generated on site.

- Use the background process **F1-AVALG** to regenerate algorithm information
- Use the background process **F1-AVBT** to regenerate batch control information.
- Use the background process **F1-AVMO** to regenerate maintenance object information
- Use the background process **F1-AVTBL** to regenerate data dictionary information.
- Use the background process **F1-AVTD** to regenerate To Do type information.

These processes have been introduced so that you can more easily incorporate your implementation-specific information into the application viewer.

To keep the information shown in the application viewer current it is important to execute these background processes after you introduce changes to the corresponding system data.

Note: Data Generation Is Not Incremental. Each new execution of these processes first deletes existing data (if any) in the corresponding folder before it generates new data.

Note: Other Extensions. Cobol source and service XML may also be extended to include implementation-specific information. The base package is provided with special scripts that handle this type of extension. Refer to the Software Development Kit User Guide for further information on application viewer extensions.

Note: War File. If your application is installed in war file format, each generation of application viewer data rebuilds the corresponding war file. The web application server then needs to be "bounced" in order to make the newly generated data available to the application viewer. Please consult your system administrator for assistance.

Note: Certain Web Application Servers Are Special. WebSphere and Oracle Application web application servers require an additional step in order to make the newly generated data available to the application viewer. These web

application servers require a rebuild of the application ear file and its redeployment in the web application server. This step is described in the installation document. Please consult your system administrator for further details.

Chapter 12

Defining and Designing Reports

This section describes how to configure your third party reporting tool and how to define your reports in the system to enable users to submit reports online.

The Big Picture Of Reports

The topics in this section describe the approach for designing and defining your system reports.

Integration with BI Publisher and Business Objects Enterprise

Your DBMS, your product, and BI Publisher or Business Objects Enterprise / Crystal Reports can work together to produce reports. You may choose to use a different reporting tool, but this may not be a trivial effort. This section provides high-level information about some of the business requirements that are being solved with the reporting solution.

Reports Must Be Multi-Language

The system supports a multi-language implementation and the reporting solution for the system must also support a multi-language implementation.

- If a French-speaking user requests a given report, all labels, headings and messages are in French. If the same report is requested by an English-speaking user, all information is in English
- Different fonts may be necessary for a given report (the font for Chinese is rather different than the font for English)
- Dates and numbers must be formatted as per the user's profile in your product
- Currency must be formatted as per the currency definition in your product

In order to provide the above functionality, the third party reporting tool must do the following:

- Access the system's field and message metadata for labels, headings and messages (as different values can be defined for different languages in system's metadata)
- Retrieve the appropriate font, size, and layout based on the requested report and the user's language
- Use the currency code information in the system to format currency-oriented information
- Use the user's display profile to format date and number fields

Requesting Reports from The System

Although reports are rendered in your reporting tool, users must be able to request ad-hoc reports from within the system (assuming users have the appropriate security access).

- The prompts for the input parameters must be shown in the user's language
- Users should be able to use the standard search facilities to find parameter values
- Plug-ins can be optionally used to cross-validate input parameters
- Application security must authorize ad-hoc report requests

Overview of the Data - BI Publisher

The following diagram provides an overview of where data is stored for your reports for integration with BI Publisher.

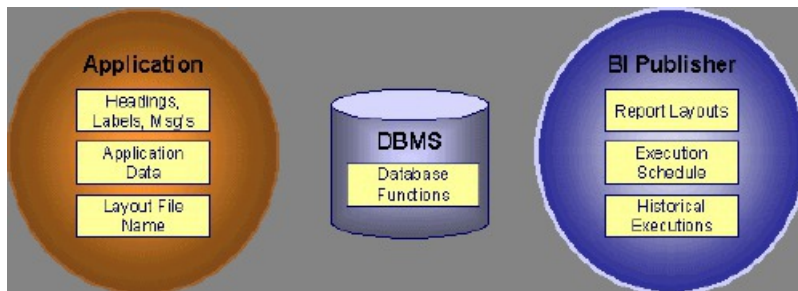

Figure 3: Application and BI Publisher

The application contains:

- The application data that appears on your reports.
- The language-specific headings, labels and messages on your reports.
- The layout file name to be used for the report.

BI Publisher contains:

- How your reports look.
- Information about scheduled reports and reports that have already run.

The DBMS contains the SQL used to retrieve the data on your reports (residing in database functions).

Note: BI Publisher can be configured to retrieve data via a service call. Because every business object can be read via a service call, elements that reside in a Character Large Object (CLOB) can be displayed on reports produced using BI Publisher. See your product's *Optional Products Installation Guide* for information on this configuration.

Overview of the Data - Business Objects Enterprise

The following diagram provides an overview of where data is stored for your reports for integration with Business Objects Enterprise.

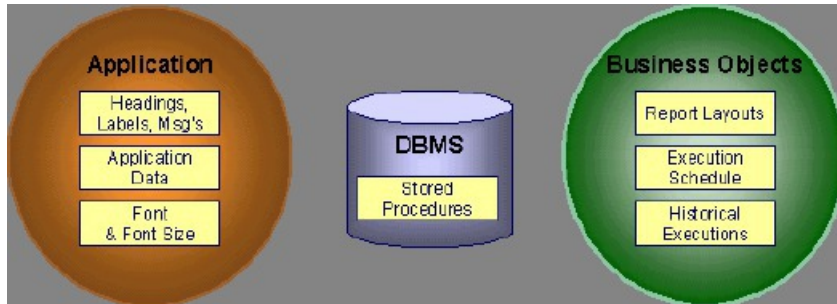

Figure 4: Application and Business Objects Enterprise

The application contains:

- The application data that appears on your reports.
- The language-specific headings, labels and messages on your reports.
- For Business Objects Enterprise, the font and size in which each report is rendered.

Business Objects Enterprise contains:

- How your reports look.
- When your reports are produced (the batch scheduler).
- Historical images of reports.

The DBMS contains the SQL used to retrieve the data on your reports (residing in stored procedures).

How To Request Reports

A user may request an ad hoc report from within your product:

- A [report submission](#) page enables a user to choose the desired report and enter the parameter values for the report
- The user must be granted security access to the report
- The request is passed to the reporting tool real time. Refer to [Configure The System to Invoke BI Publisher](#) or [Configure The System to Invoke Business Objects Enterprise](#) for more information.
- The reporting tool generates the report and displays it in a new browser window

The reporting tools' scheduler creates reports (as per your schedule)

- This function is entirely within the reporting tool. No scheduling functions reside within your product.

A user can request an ad-hoc report from within the reporting tool

- Note, the user's ID must be supplied as a parameter to the report in order for the user's profile to be used to format dates and numbers

Viewing Reports

As described above, ad-hoc reports requested from within your product are displayed immediately after they are generated in a new browser window

Crystal's report repository can be used to retrieve historical versions of a report. The [Report History](#) page allows users to open the Crystal's report execution history page and request a view of this report.

Note: The [Report History](#) page currently does not display historical reports for BI Publisher.

Configuring The System To Enable Reports

Configuring BI Publisher Reports

This section contains topics specific about configuring the product to interoperate with BI Publisher.

Configure the System to Invoke BI Publisher Real-time

The base product provides an [installation algorithm](#) plug-in spot called Reporting Tool. This plug-in spot should contain an algorithm that invokes the third party reporting tool real-time.

For BI Publisher, the system provides an algorithm type called [FI-BIPR-INV](#), which invokes BI Publisher.

These algorithms rely on information defined in the [Reporting Options](#) table: the reporting server, reporting folder and the user name and password for accessing the reporting tool. The values in the reporting options should have been set up when the system was installed. Contact your system administrator if there are any problems with the values defined on the reporting options.

To use the algorithm types to invoke BI Publisher, perform the following steps:

- Create an [algorithm](#) for the appropriate algorithm type.
- On the [installation options](#), add an entry to the algorithm collection with an algorithm entity of **Reporting Tool** and indicate the algorithm created in the previous step.

Batch Scheduling in BI Publisher

For many of your reports, you probably want the report to be produced on a regular basis according to a scheduler. The reporting solution relies on the BI Publisher software to provide the batch scheduler functionality. Refer to BI Publisher documentation for details about configuring the batch scheduler.

Note: The [report history](#) page currently does not display historical reports for BI Publisher.

Configuring Business Objects Enterprise Reports

This section contains topics specific about configuring the product to interoperate with Business Objects Enterprise.

Configure the System to Invoke Business Objects Enterprise Real-time

The base product provides an *installation algorithm* plug-in spot called Reporting Tool. This plug-in spot should contain an algorithm that invokes the third party reporting tool real-time.

For Business Objects Enterprise, the system provides an algorithm type called *RPTE-INV*, which invokes Business Objects Enterprise.

These algorithms rely on information defined in the *Reporting Options* table: the reporting server, reporting folder and the user name and password for accessing the reporting tool. The values in the reporting options should have been set up when the system was installed. Contact your system administrator if there are any problems with the values defined on the reporting options.

To use the algorithm types to invoke one of the reporting tools, perform the following steps:

- Create an *algorithm* for the appropriate algorithm type.
- On the *installation options*, add an entry to the algorithm collection with an algorithm entity of **Reporting Tool** and indicate the algorithm created in the previous step.

Batch Scheduling in Business Objects Enterprise

For many of your reports, you probably want the report to be produced on a regular basis according to a scheduler. The reporting solution relies on the Business Objects Enterprise software to provide the batch scheduler functionality. Refer to Business Objects Enterprise documentation for details about configuring the batch scheduler.

The product provides a *report history* page to display report instances that were produced via the batch scheduler and are stored in a repository. The report history page relies on the *reporting tool algorithm* to invoke Business Objects Enterprise and display the historic instances for the selected report.

Defining Reporting Options

The reporting options are provided as a mechanism for defining information needed by your reporting solution. The base product uses the reporting options to define information needed to access the reporting tool from within the system using the algorithm defined on the installation option.

Navigate to this page using **Admin Menu > Reporting Options** .

Description of page

The following information must be defined to interface with BI Publisher real-time. Contact your system administrator to report any problems with the settings defined here.

Reporting Folder Defines the shared folder where reports are stored.

For Business Objects Enterprise, defines the name of the virtual directory on the server where Java Service pages (JSP) are located. The reporting tool algorithm uses this information to construct the URL to launch the reporting tool. The reporting tool algorithm assumes that a JSP named "logon.jsp" is located there.

Reporting Server Defines the URL of the web application where the reporting tool is installed. For example, using BI Publisher, the format is: `http://<BI Publisher Server>:<port>`.

Reporting Tool User ID Not applicable when integrating with BI Publisher.

For Business Objects Enterprise, defines the user id to use when logging in.

Reporting Tool Password Not applicable when integrating with BI Publisher.

For Business Objects Enterprise, defines the password to use when logging in.

Note: Customize Options. The reporting options are customizable using the Lookup table. This field name is **RPT_OPT_FLG**. The reporting options provided with the system are needed to invoke the reporting tool. If your implementation requires other information to be defined as reporting options, use the lookup table to define additional values for the reporting option flag.

Where Used

This information is used by the reporting tool algorithm on the [installation option](#) to invoke the reporting tool software.

Implementations may use reporting options to record other information needed for their reporting tool.

Defining Report Definitions

For each report supplied by your installation, use the report definition page to define various attributes of the report.

Report Definition - Main

Navigate to this page using **Admin Menu > Report Definition**.

Caution: Important! If you introduce new report definitions, you must prefix the report code with **CM**. If you do not do this, there is a slight possibility that a future release of the application could introduce a new system report with the name you allocated.

Description of page

Enter an easily recognizable **Report Code** and **Description** for each report. Use the **External Reference ID** to define the identifier for this report in your external reporting tool.

Define an [application service](#) to enable users to request submission of this report online or to view report history for this report. Once you define an application service for each report, use [application security](#) to define which users may access this report.

Note: Access Mode. The access mode for application services related to reports must be set to **Submit/View Report**.

If you have more than one parameter defined for your report and you wish to perform cross-validation for more than one parameter, provide an appropriate **Validation Algorithm**. Click [here](#) to see the algorithm types available for this system event.

Enter a **Long Description** to more fully describe the functionality of this report. This information is displayed to the user when attempting to submit the report online or when viewing history for this report.

For BI Publisher, if you want to use one of the sample reports provided by the system, but with a different layout, indicate the layout to use for the report in the **Customer Specific Font/ Layout** field and BI Publisher uses this information instead. The name for base report layout is <report code>_Base. For example, a base layout for CI_VACANT is named CI_VACANT_Base.

For Business Objects Enterprise, the **Report Font** and **Report Font Size** are used to control the display of the report information. If you wish to use one of the sample reports provided by the system, but wish to use a different font and font size, indicate your **Customer Specific Font** in the **Customer Specific Font/ Layout** field and Business Objects Enterprise uses this information instead.

Report Definition - Labels

Navigate to this page using **Admin Menu > Report Definition** and go to the **Labels** tab.

Note: Company name and logo. Note the company name used as a title in the sample reports is defined as a message on the [installation options](#). For information about installing the company logo, refer to the *Reports Configuration* chapter of the *Installation Information*.

Description of Page

In order to provide multi-language capability for each report, the labels used for the report must support multiple language definitions. For each label used by your report, indicate a unique **Sequence** and the **Field** used to define the **Label**. The label defined here should be the same label that is defined in your report layout defined in the external reporting tool.

When rendering an image of the report, the external reporting tool retrieves the appropriate label based on the language used for the report.

Report Definition - Parameters

Navigate to this page using **Admin Menu > Report Definition** and go to the **Parameters** tab .

Description of Page

The **Parameters** scroll contains one entry for every parameter defined for the report. To modify a parameter, simply move to a field and change its value. To add another parameter, click + to insert a row and then fill in the information for each field. The following fields display:

Parameter Code The identifier of the parameter. This must correspond to the parameter definition in the reporting tool.

Required Turn on this switch if the user must supply a value for the parameter when submitting the report.

Sort Sequence Indicate the sort sequence for this parameter. This sequence must match the parameter order defined in the reporting tool's report. It is also used when displaying the list of parameters on the [report submission](#) page.

Characteristic Type Indicate the characteristic type used to define this parameter.

Default Value Use this field to define a default value for this parameter. Default values are displayed to the user when the report is chosen on the [report submission](#) page.

Description Define a brief description of the parameter. This description is used when displaying the parameter on the [report submission](#) page.

Long Description Define a detailed description of the parameter. This description is used on the [report submission](#) page when the user requests more information for a given parameter.

Sample Reports Supplied with the Product

The system provides several sample reports that may be used by your organization as they are or as a starting point for creating a [new report](#). The following sections provide an overview of the sample reports along with instructions on how to use one of the sample reports in your implementation environment.

Note: Additional sample reports. Your specific product may supply additional sample reports. Information about any additional reports, if applicable would be found in your specific product's documentation. Open the help index and navigate to the index entry labeled **reports / sample reports for < product >**.

How to Use a Sample Report Provided with the System

If you would like to use any of the sample reports, you need to perform some steps to be able to execute them in an implementation environment. This section walks you through the steps needed.

Steps Performed at Installation Time

The *Installation Guide* provides instructions for setting up and configuring your product and reporting tool to use the sample reports provided with the system. The following steps are described there.

- Setting up the stored procedures used by the sample reports.
- Defining the company title and logo used by the sample reports. Note the company name used as a title in the sample reports is defined as a message on the *installation options*. For information about installing the company logo, refer to the *Reports Configuration* chapter of the *Installation Information*.
- Defining a user for integration with your product.
- Publishing the sample reports in BI Publisher or Business Objects Enterprise.

Contact your system administrator to verify that the above steps have occurred.

How To Copy A Report Definition From The Demonstration Database

In order to use one of the sample reports in your product, you must define the metadata for each report. The demonstration database contains the report definition and all its related data for each sample report. The topics in this section describe how to copy any / all of the report definitions from the demonstration database to your implementation's database.

Caution: If you are not familiar with the concepts described in the *ConfigLab* chapter, this section will be difficult to understand. Specifically, you need to understand how a **Compare** database process is used to copy objects between two databases. Please take the time to familiarize yourself with this concept before attempting to copy a report from the demonstration database.

If You Work In A Non-English Language

The demonstration database is installed in English only. If you work in a non-English language, you must execute the NEWLANG background process on the demonstration database before using it as a **Compare Source** supporting environment. If you work in a supported language, you should apply the language package to the demonstration database as well.

If you don't execute **NEWLANG** on the demonstration database, any objects copied from the demonstration database will not have language rows for the language in which you work and therefore you won't be able to see the information in the target environment.

One Time Only - Set Up A DB Process To Copy Reports

You need a "copy reports" *database process* (DB process) setup in the target database (i.e., your implementation's database). This DB process must have the following instructions:

- A primary instruction for the report *maintenance object* (MO)
- A child instruction for each MO referenced as a foreign key on a report (i.e., validation algorithm, characteristics used for parameters and any algorithms used by the characteristics)

The demonstration database contains a DB process that performs these steps (it's called **CI_COPRP**). In order to copy reports from the demonstration database, you must first copy this DB process.

Caution: The remainder of this section is confusing as it describes a DB process that copies another DB process. You will only have to do the following once. This is because after you have a "copy reports" DB process in your target database, you can use it repeatedly to copy reports from the demonstration database.

You can copy the **CI_COPRP** DB process from the demonstration database by submitting the **CL-COPDB** *background* process in your target database. When you submit this process, you must supply it with an *environment reference* that points to the demonstration database. If you don't have an environment reference setup in your target database that references the demonstration database, you must have your technical staff execute a registration script that sets up this environment reference. Refer to *Registering ConfigLab Environments* for more information about this installation script.

CL-COPDB is initially delivered ready to copy *every* DB process that is prefixed with **CI_** from the source database (there are numerous sample DB processes in the demonstration database and this process copies them all). If you only want to copy the **CI_COPRP** DB process, add a table rule to the primary instruction of the **CL-COPDB** *database process* to only copy the **CI_COPRP** DB process. The remainder of this section assumes you have added this table rule.

When the **CL-COPDB** process runs, it highlights differences between the "copy reports" DB process in your source database and the target database. The first time you run this process, it creates a root object in the target database to indicate the **CI_COPRP** DB process will be added to your target database. You can use the *Difference Query* to review these root objects and **approve** or **reject** them.

Note: Automatic approval. When you submit **CL-COPDB**, you can indicate that all root objects should be marked as **approved** (thus saving yourself the step of manually approving them using *Difference Query*).

After you've approved the root object(s), submit the **CL-APPCH** batch process to change your target database. You must supply the **CL-APPCH** process with two parameters:

- The DB Process used to create the root objects (**CL-COPDB**)
- The environment reference that identifies the source database (i.e., the demonstration database)

Run The Copy Reports DB Process

After you have a "copy reports" DB process in the target database, you should add a *table rule* to its primary instruction to define which report(s) to copy from the demonstration database. For example, if you want to copy a single report called **CI_MTREAD**, you'd have a table rule that looks as follows:

- Table: **CI_MD_RPT**
- Override Condition: **#CI_MD_RPT.REPORT_CD='CI_MTREAD'**

If you do not introduce this table rule to the primary instruction of the DB process, **ALL** reports in the demonstration database will be copied to the target database (and this may be exactly what you want to do).

Note: Tables rules are WHERE clauses. A table rule is simply the contents of a WHERE clause except the tables names are prefixed with **#**. This means that you can have table rules that contain LIKE conditions, subqueries, etc.

At this point, you're ready to submit the background process identified on your "copy reports" DB process. This background process highlights the differences between the reports in the demonstration database and the target database (the target database is the environment in which you submit the background process).

Note: The background process you submit is typically named the same as the DB process that contains the rules. If you used the **CL-COPDB** background process to transfer the "copy reports" DB process from the demo database, it will have also setup a batch control and linked it to the "copy reports" DB process. This batch control has

the same name as its related DB process (this is just a naming convention, it's not a rule). This means that you'd submit a batch control called **CI_COPRP** in order to execute the **CI_COPRP** DB process.

When you submit the **CI_COPRP** background process, you must supply it with an *environment reference* that points to the source database (i.e., the demonstration database).

When the **CI_COPRP** process runs, it simply highlights differences between the reports in your source database and the target database. It creates a root object in the target database for every report that is not the same in the two environments (actually, it only concerns itself with reports that match the criteria on the table rule described above). You can use the *Difference Query* to review these root objects and **approve** or **reject** them.

Note: Auto approval. When you submit **CI_COPRP**, you can indicate that all root objects should be marked as **approved** (thus saving yourself the step of manually approving them).

After you've approved the root object(s) associated with the report(s) that you want copied, submit the **CL-APPCH** batch process to cause your target database to be changed. You must supply the **CL-APPCH** process with two parameters:

- The DB process of the "copy reports" DB process (i.e., **CI_COPRP**)
- The environment reference that identifies the source database (i.e., the demonstration database)

Securing Your Reports

In order for a user to submit a report using the online report submission or to view report history, the user must have access to the report through the application security. Reports that you have copied from the demonstration database reference an application service (whose name matches the report name). If you plan to use one of the reports in the demonstration database with no changes, you must configure your system to enable access to this application service for the appropriate user groups. The access mode must be defined as **Submit/View Report**.

Subreports Used with Crystal Reports

The sample reports supplied with the system use several common subreports. Subreports are used in Crystal Reports to retrieve common data such as, labels and your company title. They are shared for all reports and may be reused for customer reports. Implementers may also use these subreports when designing new reports.

Note: Specific Subreports. This section only includes common subreports that may be reused by new reports. You may notice that other subreports are supplied with the system. These subreports provide functionality for a specific sample reports and are not meant for reuse.

Display Company Logo and Title

The subreport **CIZCOMP** receives the user id as a parameter and calls the stored procedure **CIZCOMP** . It retrieves the company's title in the user's language from the appropriate *installation message* record.

Fastpath: Refer to the **Reports Configuration** chapter of the installation guide for more information about defining the location for the company logo.

Format Report Information

The subreport **CIZINST** defines shared variables that are used for formatting fields in the main report. It calls the stored procedure **CIZINST** . This subreport receives the user id and report code as parameters. It retrieves the font and font size from the *report definition* . It retrieves the format date/time and number format from the user's *display profile* . Finally,

it retrieves the currency from the *installation* record and retrieves the currency symbol and position from the currency's record.

Note: Multi-currency. All reports support multiple currencies. Currency information is returned for each row by the appropriate stored procedure. This subreport retrieves the currency code from the Installation Options and should only be used in a report if there is no other currency information available.

Labels

The subreport **CIZLABEL** keeps all labels used in the main report. It calls the stored procedure **CIZLBALL** with the user ID as a parameter. This stored procedure returns all labels defined for all reports. The subreport selects labels specified for the current report and sets shared variables L001...L100 to store the labels. If more than 100 labels are required for a new report, the version of the CIZLABEL subreport used for the new report should be changed to add additional shared variables.

How To Define A New Report

Use a Sample Report as a Starting Point

- Make a copy of the report and save it in an appropriate directory. Prefix the new report name with **CM**.
- Review the stored procedure(s) used for this report. Refer to the installation guide for information about where the stored procedures should be defined. If you want to change the data that is being accessed, copy the stored procedure, prefixing the new stored procedure with **CM**. Make the appropriate changes in the new version of the stored procedure. Contact your database administrator to find out the procedure for creating a new stored procedure.

Note: Performance considerations. When designing a stored procedure, you must consider the performance of the report when executed. Consult your database administrator when designing your database access to ensure that all issues are considered.

Note: Defining Messages. The stored procedures provided with the system use messages defined in message category 30. If your new stored procedures require new messages, use message category 90000 or greater, which are reserved for implementations.

- Review the parameters used by the report. Make appropriate changes to the parameters required by the report. This affects how you define your report. Refer to *Designing Parameters* for more information.
- Determine whether or not you require cross validation for your report parameters. If any cross validation is necessary, you should design an appropriate validation algorithm to be executed when requesting a report in your product. Refer to *Designing Validation Algorithms* for more information.

Note: Cross Validation for On-line Submission Only. The cross validation algorithm is only executed for ad-hoc report submissions via your product. If you submit this report through your reporting tool, this algorithm is not executed.

- Review the labels used by the report. Labels and other verbiage are implemented in the sample reports using a reference to the field table in the system. This enables the report to be rendered in the appropriate language for the user. For any new report label you require, you must define a new field entry. Refer to *Designing Labels* for more information.
- Review the layout of the report and make any desired changes based on your business needs.

When you have finished designing and coding your new report in your reporting tool, you must do the following in order for it to be usable:

- Publish the report in BI Publisher or Business Objects Enterprise. Refer to the documentation for these products for details about publishing a report. Refer to *Publishing Reports in BI Publisher* and *Publishing Reports in Business Objects Enterprise* for configuration information specific to publishing a report for integration with your product.
- Define the report. Refer to *Designing Your Report Definition* for more information.

Publishing Reports in BI Publisher

Please refer to the documentation for BI Publisher for more information about publishing a report in this system. The remaining topics in this section provide information about settings needed to ensure that the report is accessible using BI Publisher.

BI Publisher Database Access

When publishing a report in BI Publisher, you are asked for database logon information. The logon user name and password must be the user name and password that has access to the database functions related to this report in your database.

Verify BI Publisher User Access Rights

To verify the user's access rights to folders in BI Publisher:

- Open the BI Publisher Enterprise Security Center.
- Check that the role for the user has access to the appropriate report folders.

For more information, refer to the "Understanding Users and Roles" section in the Oracle Business Intelligence Publisher User's Guide.

Publishing Reports in Business Objects Enterprise

Please refer to the documentation for Business Objects Enterprise for more information about publishing a report in this system. The remaining topics in this section provide information about settings needed to ensure that the report is accessible using Business Objects Enterprise.

Business Objects Enterprise Database Access

When publishing a report in Business Objects Enterprise, you are asked for database logon information. The logon user name and password must be the user name and password that has access to the stored procedures related to this report in your database.

Verify Parameter Definition

This section describes how to verify parameter definitions in the Crystal Management Console (CMC).

- Once your report has been published, navigate to the CMC. This is the web-based administration component for Business Objects Enterprise and provides access to all administrative functions.

- To verify/change the settings of a report in the CMC go to the Objects management area and select the desired report by clicking its link located in the Object Title column.
- Once you have selected your report, click the **Parameters** tab to change the settings.
- If your report requires parameters to be provided by the user, you must configure the parameter settings in the CMC to ensure that parameter values are passed from the system when submitting the report via the [Report Submission](#) page. If you plan to submit reports from within your product, the **Prompt the user for new value(s) when viewing** check box should be checked.
- Click **OK** on this window and then click **Update**.

Note: Submitting Reports Through Business Objects Enterprise. If you plan to submit reports from Business Objects Enterprise, you must also define an appropriate initial value for each parameter, if applicable.

Note: User ID. The user id is defined as the first parameter in every sample report. This parameter is hidden when the report is submitted from within your product, but it must be defined in the Crystal report.

Verify Business Objects Enterprise User Access Rights

To verify the access rights for a user in CMC:

- Navigate to the **Rights** tab in the Objects management area of the CMC and check that the user has correct security level for the report.
- Integration with your product requires an access level of **View On Demand** for the user.

Designing Your Report Definition

When adding a new report, you must define it in the system to allow users to request ad-hoc reports from on-line and to take advantage of the multi-language provisions in the system. The following topics illustrate the steps to take to correctly configure your report definition.

Designing Main Report Definition Values

Refer to field description section of the [report definition](#) main page for information about defining general information about the report.

For the validation algorithm, preliminary steps are required. Refer to [Designing Validation Algorithms](#) for more information.

For the application service, preliminary steps are required. Refer to [Designing Application Services](#) for more information.

Designing Characteristic Types

The parameter tab on the report definition page uses [characteristic types](#) to define the report parameters. For each report parameter that you plan to use, you must define a characteristic type.

You do not need a unique characteristic type for each report parameter. For example, if Start Date and End Date are parameters your report, only one **Report Date** characteristic type needs to be defined. This characteristic type would be used on both date parameters.

Each characteristic type to be used as a report parameter must indicate a characteristic entity of **Report**.

To illustrate the characteristic type definitions, let's look at the sample report Tax Payables Analysis. It needs the following parameters: From Date, To Date, GL Account Type Characteristic Type and Account Type value.

Note: Account Type Parameters. The tax payables report must find general ledger entries that have posted to a certain distribution code. In order to find the appropriate distribution code, the report expects each distribution code to be defined with a characteristic indicating its GL account type (for example, **Revenue**, **Asset**, etc.) The report needs to know the characteristic type used to define this entry.

To support the required parameters, the following characteristic types are needed.

Char Type	Description	Type	Valid Values	Char Entities
CI_DATE	Date Parameter	Ad-hoc	(Uses validation algorithm to validate proper date entry)	Report
CI_CHTYP	Characteristic Type	FK Reference	CHAR_TYP	Report
CI_GLTYP	GL Account Type	Pre-defined	A- Asset, E- Expense, LM- Liability/miscellaneous, LT- Liability/taxes, R-Revenue	Distribution Code, Report

Highlights for some of the above settings:

- We have defined a characteristic type for defining a characteristic type. This is to allow the user to indicate which Char Type on the Distribution Code is used for the GL account type. This is an FK reference type of characteristic.
- The GL account type characteristic type is referenced on both the Distribution Code entity and the report entity.

Designing Parameters

Your report definition parameters collection must define a unique parameter entry for each parameter sent to the reporting tool. The sequence of your parameters must match the sequence defined in your reporting tool.

Continuing with the Tax Payables Analysis report as an example, let's look at the parameter definitions.

Parameter Code	Description	Char Type	Default Value
P_FROM_DT	From Date	CI_DATE	N/a
P_TO_DT	To Date	CI_DATE	N/a
P_CHAR_TYPE	Account Type Characteristic	CI_CHTYP	CI_GLTYP
P_TAX_ACCTY_CHAR	Account Type Char Value for Tax Related GL Account	CI_GLTYP	LT-Liability/taxes

Highlights for some of the above settings:

- The from date and to date parameters use the same characteristic type.
- The characteristic type parameter is defined with a default value pointing to the GL account type characteristic type.
- The GL account type parameter defines the liability/taxes account type as its default value.

Note: User Id. The sample reports provided by the system pass the user id as the first parameter passed to the reporting tool. It does not need to be defined in the parameter collection for the report.

Designing Validation Algorithms

When designing your report definition, determine if cross validation should occur for your collection of parameters. In the Tax Payables Analysis report, there are two date parameters. Each date parameter uses the characteristic type validation algorithm to ensure that a valid date is entered. However, perhaps additional validation is needed to ensure that the start date is prior to the end date. To do this, a validation algorithm must be designed and defined on the report definition.

The system provides a sample algorithm *RPTV-DT* that validates that two separate date parameters do not overlap. This algorithm should be used by the Tax Payables Analysis report.

If you identify additional validation algorithm, create a new *algorithm type*. Create an *algorithm* for that algorithm type with the appropriate parameter values. Plug in the new validation algorithm to the appropriate report definition.

Designing Application Services

Application services are required in order to allow a user to submit a report on-line or to view history for a report. Define an application service for each report and define the user groups that should have submit/view access to this report.

Update *report definition* to reference this application service.

Designing Labels

The system supports the rendering of a report in the language of the user. In order to support a report in multiple languages, the verbiage used in the report must be defined in a table that supports multiple languages. Some examples of verbiage in a report include the title, the labels and column headings and text such as "End of Report".

The system uses the *field* table to define its labels.

Note: Report Definition. This section assumes that your new report in the reporting tool has followed the standard followed in the sample reports and uses references to field names for all verbiage rather than hard-coding text in a single language.

For each label or other type of verbiage used by your report, define a field to store the text used for the verbiage.

- Navigate to the field table using **Admin Menu, Field**.
- Enter a unique **Field Name**. This must correspond to the field name used in your report definition in the reporting tool and it must be prefixed with **CM**.
- Define the **Owner** as **Customer Modification**.
- Define the **Data Type** as **Character**.
- **Precision** is a required field, but is not applicable for your report fields. Enter any value here.
- Use the **Description** to define the text that should appear on the report.
- Check the **Work Field** switch. This indicates to the system that the field does not represent a field in the database.

Update the *report definition* to define the fields applicable for this report in the **Labels** tab.

If your installation supports multiple languages, you must define the description applicable for each supported language.

Chapter 13

External Application Integration

This section describes mechanisms provided in the product that enable an implementation to configure the system to communicate with an external application.

Web Service Integration

The system provides tools to communicate with an external system using certain types of web services. The following topics describe the system functionality provided.

Understanding Web Service Adapters

The system provides tools to communicate with an external system using certain types of web services. The base product provides a configuration object called Web Service Adapter that provides the following functionality:

- WSDL import. An implementer can use the WSDL import functionality to read the WSDL details into the system
- Internal API generation. The system generates internal data areas that have 2 purposes: they provide the API for custom code to define the appropriate input and output data for the web service call using Oracle Utilities Application Framework schema language. In addition, the web service dispatcher uses element mapping defined in the data areas to transform the internal XML into the structure expected by the external system as described in the WSDL.
- Defines the URL needed to perform the web service call at runtime.

The following points highlight limitations associated with the types of web services that the system supports:

- It is possible for one WSDL document to contain definitions for several web services. The system currently supports only one port or service per WSDL document.
- It is possible for a WSDL to support multiple message patterns. The system currently supports only request / response.

The following topics describe the system functionality in more detail.

Importing a WSDL

The configuration of a Web Service Adapter starts by identifying the WSDL (the web service description language document used to define the interface) provided by the external system. The following steps describe the base product functionality provided to allow a user to import a WSDL.

- Navigate to the **Web Service Adapter** page in add mode and select the appropriate base business object.
- Enter a meaningful Web Service Name and appropriate descriptions.
- Provide the URL of the given WSDL.
- Click **Import** to retrieve the details of the WSDL. The system parses the WSDL details and populates the WSDL Service Name, WSDL Source, WSDL Port, URL and a list of Operations (methods) defined in the WSDL.
- Determine which Operations should be **active** based on the business requirements for invoking this web service. **Active** operations are those that the implementation is planning to invoke from the system. These require appropriate request and response data areas generated for them. The following section provides more information about that.
- Specify the appropriate Security Type to configure the type of security to use when invoking this web service.
- Save

At this point, a web service adapter record is created in pending status. The next step is to generate the request and response data areas for the operations configured as active.

Generating Request and Response Data Areas

Each **active** operation for the web service adapter requires a pair of data areas, request and response, that represent the request and response XML messages for the operation.

The base product provides steps to generate the data areas as follows:

- As described in the Importing a WSDL section above, the operations listed in the WSDL are generated for the web service adapter and the implementer should indicate which operation to activate.
- After saving the **pending** web service adapter, the display lists all the active operations and for each one includes a **Generate** button.
- After clicking **Generate** for an operation, a window appears where the names of the new Request and Response Data Areas may be defined. Click **Save** to generate the data areas.

The generated data areas provide the API for the implementer to use when implementing the web service call in an appropriate algorithm or service in the system. The data areas contain the appropriate mapping from the elements that the implementer works with in the code that invokes the web services and the WSDL definitions.

To facilitate the generation of the request and response data areas, the base product invokes a special business service used to create the appropriate mapping. The business service is defined as a BO option on the Web Service Adapter business object. This allows an implementation to provide a custom business service to further enhance the request and response mapping where appropriate.

Note:

Generated data areas. It is possible to edit and modify the generated data areas after they are created. An implementer can change element names or remove unneeded elements if desired. Manually changing the generated data areas must be done only when absolutely necessary. The system is not able to validate manual changes. Issues with the data areas would only be detected at run time.

Activating Web Service Adapters

The business objects provided by the base package for web service adapters include a simple lifecycle of pending and active. Configure the web service adapter and its data areas while in pending status and activate it when it is ready to be implemented in the appropriate system functionality.

Invoking Web Services

To make a call to a web service using a web service adapter, the system has provided a Web Service Dispatcher business service (**F1-InvokeWebService**) to submit a web service call. The calling program is responsible for retrieving all the information to correctly populate the request data required by the web service call before invoking the business service.

Note:

Refer to the detailed description of the business service for more information.

Setting Up Web Service Adapters

Use the Web Service Adapter portal to define the configuration needed to communicate with an external system using a web service call. Open this page using **Admin Menu > Web Service Adapter** .

This topic describes the base-package zones that appear on the Web Service Adapter portal.

Web Service Adapter Query

Use the query portal to search for an existing web service adapter. Once a web service adapter is selected, you are brought to the maintenance portal to view and maintain the selected record.

Web Service Adapter Portal

This page appears when viewing the detail of a specific web service adapter.

Web Service Adapter - Main

The Web Service Adapter main page contains a zone that includes display-only information about the web service along with the actions that are available for maintaining a web service adapter.

Please see the zone's help text for information about this zone's fields. Refer to [Understanding Web Service Adapters](#) for information about common web service adapter functionality.

Fastpath: Refer to [Understanding Web Service Adapters](#) for information about common web service adapter functionality.

Web Service Adapter - Log

This page contains a standard log zone.

XML Application Integration

This section describes the XML Application Integration (XAI) utility, which enables you to configure your system to receive information from and to send information to external applications using Extensible Markup Language (XML) documents.

The Big Picture of XAI

The XML Application Integration (XAI) module provides the tools and infrastructure that businesses require for integrating their applications with your product. The integration your product with other systems across organizational boundaries or business is made possible, regardless of the platforms or operating system used. XAI provides an integration platform that enables the following:

- Integrate with Customer Relationship Management (CRM) systems
- Provide information feeds for web based customer portals
- Fit seamlessly with web based applications
- Facilitate fast implementation of batch interfaces
- Integrate with other XML compliant enterprise applications

XAI exposes system business objects as a set of XML based web services. The service can be invoked via different methods, e.g., Hypertext Transfer Protocol (HTTP) or Java Message Service (JMS). Consequently, any application or tool that can send and receive XML documents can now access the rich set of system business objects. Business-to-Business (B2B) or Business-to-Consumer (B2C) integration with other enterprise applications as well as the setup of web portals is made very simple and straightforward.

XAI Architecture

The XAI architecture contains 3 major components:

- The Core Server Component
- The Multi Purpose Listener (MPL)
- The Client Component

The Core Server Component

The core server component is responsible for receiving XML requests, executing the service and returning the response to the requester.

The following diagram shows the XAI tool operating on a web server and providing integration between the system business objects and various external applications.

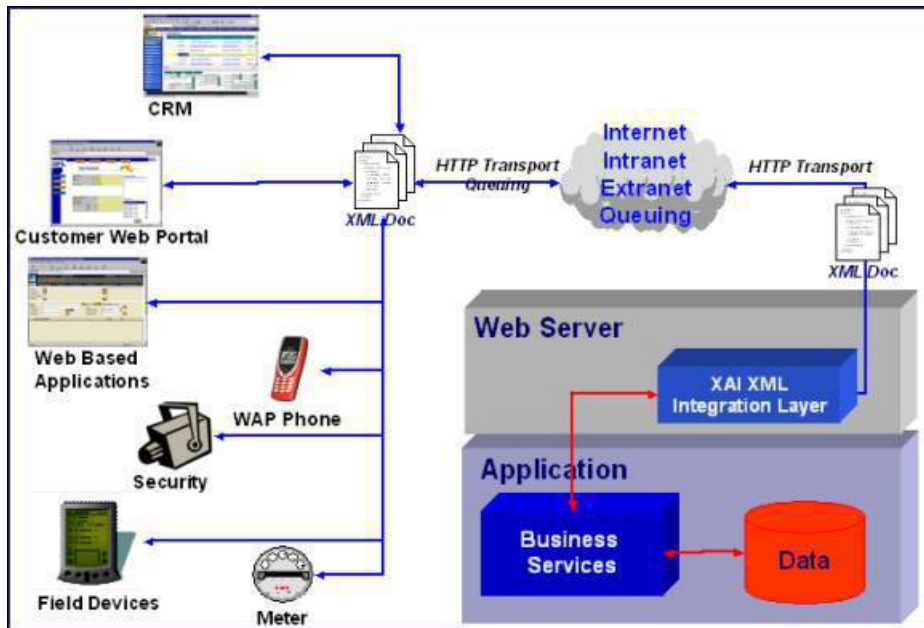

The core is built in Java, using a layered, scalable architecture. The basic transport protocol supported by the core is SOAP/HTTP.

Fastpath: Refer to [SOAP](#) for more information.

The XAI core server provides a Java servlet to process requests through HTTP. You may also use other messaging mechanisms such as message queuing, publish/subscribe or a staging table. The multi-purpose listener processes the messages.

The Multi Purpose Listener (MPL)

Note: Multi Purpose Listener functionality has been replaced with Oracle Service Bus (OSB). New implementations should use OSB for processing. Existing implementations with MPL configurations should migrate these to OSB. See [Using Oracle Service Bus \(OSB\) as a Replacement for MPL](#) for additional information.

The Multi Purpose Listener (MPL) is a multi-threaded Java server that constantly reads XML requests from various external and internal data sources, such as a Java Message Service (JMS) message queue, a JMS topic or system staging tables.

The MPL can be used to process inbound messages (those sent by an external application to invoke a system service), or outgoing messages (those sent by your product to external applications). The MPL uses different receivers to process messages from different data sources.

A receiver is implemented using 3 distinct layers:

- The Receiving Layer
- The Execution Layer
- The Response Layer

The Receiving Layer

This layer deals with polling various locations to determine if new records, files or incoming requests exist. The various locations include:

- Staging tables, including [XAI staging control](#), [XAI upload staging](#), notification download staging (certain products only), and [outbound message](#).

- An external directory that contains a file, for example a comma delimited file or an XML file.
- A JMS queue/topic.

A separate receiver is defined to read requests from each of these locations. When the MPL server starts, it looks for all defined active receivers in the *XAI Receiver* table, and for each receiver it starts a thread that constantly fetches messages from the message source.

Once a request message is read, it is passed to an execution thread that implements the execution layer. Each receiver references an *Executer* that is responsible for executing the request.

Configuring Multiple MPL Servers

A single MPL server may only run one of each of the above staging table receivers for a given JDBC connection. To enhance the performance of the processing of the staging tables, you may define multiple MPL servers where each one runs the active receivers defined in the receiver table.

To ensure that each staging table receiver processes its own set of records in the staging table, the receiver selects a set number of records (specified as *XAI option Number of Records an MPL Receiver Will Process At a Time*) and marks those records with the IP address and port number of the MPL.

The Execution Layer

The execution layer sends the XML request to the *XAI core server* and waits for a response.

Note: Currently the only type of *executer* supported is the XAI servlet running either on an XAI server or locally under the MPL. However the architecture allows for executing a request on other execution environments.

The executer is invoked and is passed in an *XAI Inbound Service* that specifies an XML request schema and an *adapter*. Adapters tell XAI what to do with a request. The adapters point to a specific Java class that renders a service.

For example you can configure an Adapter to invoke any published application object (by pointing it to the appropriate java class). This adapter accesses system objects through the page service. You can think of an adapter as a plug-in component.

Once the executer processes the request and a response is received, it is transferred to the next layer, the *response* layer.

The Response Layer

The response layer is responsible for "responding" to the execution. The responses are handled by invoking an appropriate *sender* defined on the receiver's response information. Each sender defined in the system knows how to process its response. For example:

- The JMS queue sender and the JMS topic sender post responses to the appropriate queue / topic.
- The *staging control sender* handles errors received during the execution of the staging control request.
- The *upload staging sender* updates the status of the upload staging record based on the success or failure of the staging upload request.
- The download staging sender is a bit unusual because it is helping to build the message being sent (Oracle Customer Care and Billing only).

Note: There are some cases where a response is not applicable. For example, the file scan receiver creates a staging control record to process a file that exists in a directory. There is no "response" applicable for executing this request.

Using Oracle Service Bus (OSB) as a Replacement for MPL

This section describes the installation and configuration of Oracle Service Bus (OSB) as a replacement for the Multi-Purpose Listener (MPL).

Oracle Utilities Application Framework (OUAF) has long utilized the MPL for integrating the product with a larger enterprise infrastructure. While it has served its purposes over the years, it has fallen behind accepted industry standards based on the Service Oriented Architecture (SOA). The majority of MPL functionality can be replaced with out of the box solutions provided by Oracle Service Bus (OSB). For the two exceptions, Outbound Message and Notification Download Staging (NDS), the framework includes resources for integrating these with OSB.

OSB is extensible by defining transports. A transport is a software entity whose sole purpose is to produce a message to be processed by OSB and consumes the result (normal or error) returned by OSB. By utilizing the two custom transports, OUAF Outbound Message and NDS, to define what messages to process, an implementation can fully utilize an OSB development environment to define how to process these messages.

Before developing OSB integrations for OUAF, the developer should be familiar with OSB development such as creating proxy services, business services, and message flow/routing. These terms are defined as follows:

Business Service: In OSB, a Business Service is an entity that receives a message from OSB and processes it. This should not be confused with the OUAF Business Service entities. In this section we use Business Service or OSB Business to refer to a business service in OSB. If we need to refer the business services in OUAF we will refer to them as OUAF Business Services.

Proxy Service: In OSB, a Proxy Service is the entity that receives a message from a source and routes it to a Business Service. These replace the MPL Senders and Receivers. An OSB replacement for an MPL Receiver will receive a message from an external source (such as a web service, email, or file) and deliver messages to OUAF via a Business Service created from an XAI Web Service or Inbound Service. An OSB replacement for an MPL Sender will receive a message from OUAF (Outbound Message, NDS) and deliver it to an external destination (web service, email, etc.).

Migrating MPL Integrations to OSB

OUAF installations with existing MPL based integrations should use OSB as a functional replacement. These are not drop in replacements. The existing MPL configuration is not utilized in any way by OSB:

- **File Import/Export** – should utilize OSB native file import/export adapter. This is much more powerful and user friendly than MPL. It will not utilize MPL configuration.
- **Email** – should utilize the Oracle Email adapter. It will not utilize MPL configuration.
- **JMS** – should utilize standard OSB JMS adapter. MPL configuration will not be used.
- **DBMS** – should utilize the OSB Database adapter. MPL configuration will not be used a migration best practice and sample JMS interface will be developed.
- **Outbound Message** – should utilize the OUAF Outbound Message (omsg) transport. Each proxy service will encapsulate information about which type of outbound messages to query, where to send the message, and how to process the response.
- **Notification Download Staging (NDS)** – should utilize the OUAF NDS (nds) transport. Each proxy service will encapsulate information about which NDS records to process, where to send the message, and how to process the response.

Installing the OSB Transports

Before you can develop OSB proxy services that use the OUAF omsg or nds transports, you must install the transports in the target OSB environment. The OSB transports are released as binary packages to be deployed into a WebLogic environment.

Follow these steps to deploy the transports:

1. Install WebLogic and OSB on the target system.
2. Extract the contents of the OUAF Transport distribution `osb_ouaf_transports.zip`
3. Extract `osb_osb_transports.zip`.
4. Run the `setDomainEnv.cmd/setDomainEnv.sh` from the OSB user domain to set up the OSB compliant environment.
5. Change to the `ouaf_osb_transports/osb` directory.
6. Edit `build.properties` to define the installation properties # Weblogic and the OSB installation directories:

```
mw.home=C:/oracle/Middleware
wl.home=${mw.home}/wlserver_10.3
osb.install.dir=${mw.home}/Oracle_OSb1

# Staging area to pick up deployable entities
ouaf.osb.dist=C:/ouaf_osb_transports ouaf.osb.dist.transport=${ouaf.osb.dist}/transport
ouaf.osb.dist.eclipse=${ouaf.osb.dist}/eclipse
ouaf.osb.dist.offline=${ouaf.osb.dist}/offline

### Weblogic Server information ###
wls.hostname=localhost
wls.port=7001
wls.username=weblogic
wls.password=weblogic1
wls.server.name=AdminServer
```

7. Deploy the transport by running `ant deploy`.

Note: The `build.xml` file requires `weblogic.jar` to be in the classpath as it contains the `wldeploy` ant action.

The easiest way to verify the installation was successful is to create a simple outbound message or nds based proxy service.

Configuring JDBC Data Sources

Outbound messages and NDS transports read their messages from the OUAF database. Both transports access the database via a WebLogic data source that is configured as follows:

1. Log in to the WebLogic console and click on **Data Sources** in the **Domain Configurations, Services** section of the page.
2. In the list of data sources, select **New > Generic Data Source** to create a new data source.
3. Specify a JNDI Name. This name is used to identify the data source connection in your OSB Proxy Services
4. In the Configuration, Connection Pool tab, assign the URL and credentials needed to connect to the database.
5. Save the database connection.

Developing an Outbound Message Transport Using OSB

Before developing an OSB outbound message proxy service, you should prevent any legacy MPL services from attempting to process that type of outbound message. This is accomplished by changing the processing method from MPL to SOA in the OUAF application.

Example

This example shows how to create an OSB integration to handle OUAF Outbound Messages. In OSB, this is accomplished by creating a proxy service that is configured to receive outbound messages. Once a proxy service receives a message it can optionally transform the message and then route it to an OSB Business Service which will usually be a web service created from a WSDL.

Specifically, this example creates a proxy service that receives ZZZKJHTYP outbound messages and sends them to a very simple HelloWorld web service that is described in the book *Definitive Guide to SOA*. In practice, any web service can be used.

To create the OSB Business for the Hello World web service, follow these steps:

1. Save a copy of the HelloWorld web service's WSDL to your local computer.
2. Log in to the OSB Service bus console (for example, <http://localhost:7001/sbconsole>).
3. Under **Change Center**, click **Edit** to create a new session.
4. Click **Project Explorer** to see all your OSB Projects.
5. Create a new project or click on an existing project (for example, OutboundMessage).
6. Click on the project name in the project list to go to the project editor.
7. In the project, select **WSDL** from the **Create Resource** menu to create a new WSDL.
8. In the WSDL details page, give your WSDL a name and either upload the WSDL file or cut and paste its contents into the text area.
9. Save the WSDL. this takes you back to the Project page.
10. Select **Business Service** from the **Create Resource** menu to create a new business service resource.
11. Give your business service a name and description.
 1. Select **WSDL Web Service** for the service type and then click **Browse** to select the WSDL that you just created.
 2. In the WSDL browser, select the WSDL and click on its port. This will enable the **Submit** button which will bring you back to the Business Service page
12. Click **Next** to set the configuration for the Business Service's transport. Click **Add** in the Endpoint URI. This will add the endpoint defined in the WSDL to the list of existing URI's. Use the garbage can icon to delete the URI **REPLACE_WITH_ACTUAL_URL**.
13. Click **Last** to verify the configuration and then click **Save**. Alternatively, click next to view the other configuration options that you don't need to modify.

To create an OSB Proxy Service using the OUAF transports, follow these steps. Steps 1-5 can be skipped if you're already in the Project Editor after creating the business service.

1. Log in to the OSB Service bus console (for example, <http://localhost:7001/sbconsole>).
2. Under **Change Center**, click **Edit** to create a new session.
3. Click **Project Explorer** to see all your OSB Projects.
4. Create a new project or click on an existing project (for example, OutboundMessage).
5. Click on the project name in the project list to go to the project editor.
6. In the project, select **Proxy Service** from the **Create Resource** menu to create a new proxy service.
7. Give the new proxy service a name (for example, OutboundMessageTest) and description.
8. For **Service Type**, select **Any XML Service**.
9. Click **Next** to go to the Transport Configuration page
10. For **Protocol**, select **omsg**.
11. In the Endpoint URI field, enter the ID of the type of outbound message that this proxy service should process (for example, ZZZKJHTYP).
12. **Get All Headers** should be set to **No** because there are not currently any headers defined

13. Click **Next** to go to the OMSG transport configuration page.
14. Specify the name of the JDBC Data Source that connects to the OUAF database (for example, FW420DEV)
15. Adjust the poll interval if you would like the outbound message table polled at a different frequency from the default of 60 seconds.
16. Leave the dispatch policy set to the default values.
17. Click **Next** to go to the Message Handling page.
18. Leave all default values on the Message Handling page.
19. Click **Next** to review your settings. Then click **Save** to save the proxy service
20. On the project page, click the message flow icon under **Actions** to define the processing of the message.
21. Define any transformations that are needed on the input and route the message to a previously defined business service set up for the endpoint for the remote system.
22. In the OSB Change Center, activate your changes to start the ProxyServices.

The XAI Client Component

The XAI Client component is the set of online control tables and tools used to manage your XAI environment.

The *Schema Editor* is a tool used to create and maintain XAI schemas.

Fastpath: Refer to *XAI Schema* for more information.

The **Registry** is a term used to refer to all the tables required to "register" a service in the system. It includes the *XAI Inbound Service* and a set of control tables defining various options.

The *Trace Viewer* is installed with your XAI client tools and is used to view traces created on the XAI server.

XML Background Topics

The following section introduces some background information related to XML.

XAI Schemas

Note: Business Adapter. The **BusinessAdapter** adapter supports communication to configuration tool objects: *business objects*, *business services* and *service scripts* through their own schema API. When communicating to these objects, it is not necessary to create XAI schemas for the schemas associated with the objects. As a result, there is no need to use the XAI schema editor when defining *XAI Inbound Services* for this adapter.

At the core of XAI are XML web services based on XML schemas. XML schemas define the structure of XML documents and are the infrastructure of e-business solutions. They are used to bridge business applications and enable transaction automation for e-commerce applications. Industry standard schemas document common vocabularies and grammars, enhancing collaboration and standardization. Validating XML processors utilize XML schemas to ensure that the right information is made available to the right user or application.

The system exposes its application objects as XML schemas that define the interface to system services. Every service (e.g., CreatePerson or AccountFinancialHistory) is defined using a pair of schemas: the Request Schema and the Response Schema. The request and response schema can be identical.

The *Request Schema* defines the XML document structure describing the "inputs" for a service.

The *Response Schema* defines the XML document structure describing the "outputs" of a service.

The Schema Editor

To facilitate the process of exposing business objects as XML schemas, we use the Schema Editor, a graphical tool to create, import and maintain schemas. The Schema Editor provides automated wizards to import schemas residing in existing data structures and documents. The Schema Editor can import schemas from the following sources: system business objects, ODBC data sources, sequential files.

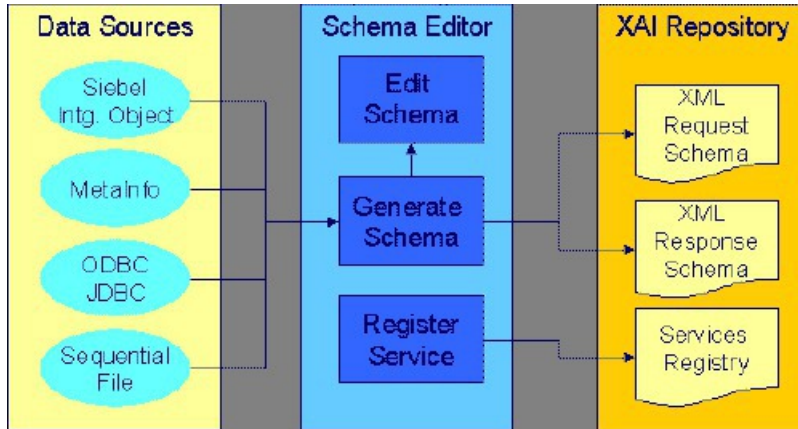

Before the XAI tool can use a service, it must be registered or published.

Fastpath: Refer to [Schema Editor](#) and [How to Publish an XAI Service](#) for more information.

XSL Transformations

XSL Transformations (XSLT) is a language used to transform an XML document into another XML document or another document format such as HTML. It is part of the Extensible Stylesheet Language (XSL) family of recommendations for defining XML document transformation and presentation. It is defined by the World Wide Web Consortium (W3C) and is widely accepted as the standard for XML transformations. Several tools are available on the market to generate XSLT scripts to transform an XML document defined by a source schema to an XML document defined by a target schema.

Fastpath: Refer to [How To Create an XSL Transformation](#) for more information.

In XAI you can use XSL to:

- Transform an inbound message into the structure required by the XAI request schema for that service.
- Transform the response to an inbound message into a format defined by a schema provided by the requesting application.

Fastpath: Refer to [XAI Inbound Service](#) for more information.

- Transform an outgoing message before it is sent out.

Fastpath: Refer to [XAI Route Type](#) for more information.

- Transform data from an external source before it is loaded into the staging upload table.

Fastpath: Refer to [XAI Inbound Service Staging](#) for more information.

SOAP

SOAP stands for Simple Object Access Protocol. The SOAP "Envelope" is the wrapping element of the whole request document that may be used by messages going through the XAI tool.

The following diagram shows a simple XML request using the SOAP standard.

```
<SOAP-ENV:Envelope>
  <SOAP-ENV:Header>
    <CorrelationID>1234</CorrelationID>
    <SOAPActionVersion>1.2</SOAPActionVersion>
  </SOAP-ENV:Header>
  <SOAP-ENV:Body>
    <CISAccount transactionType='Read'>
      <CISAccountService>
        <CISAccountHeader
          AccountID='1234'
        >
      </CISAccountService>
    </CISAccount>
  </SOAP-ENV:Body>
</SOAP-ENV:Envelope>
```

Fastpath: Refer to [How to Build the XML Request Document](#) for more information about building a request using the SOAP standard.

XPATH

The XML Path Language (XPath) is an expression language used by XSLT to access or refer to parts of an XML document. It is part of the XSL recommendations maintained by the W3C. XPath provides the syntax for performing basic queries upon your XML document data. It works by utilizing the ability to work with XML documents as hierarchically structured data sets.

In the following XML document, some examples of XPath references are:

- authors/author/name
- authors/*/name
- authors/author[nationality]/name
- authors/author[nationality='Russian']/name
- authors/author[@period="classical"]

```
<?xml version='1.0'?>
<authors>
  <author period="classical">
    <name>Sophocles</name>
    <nationality>Greek</nationality>
  </author>
  <author>
    <name>Leo Tolstoy</name>
    <nationality>Russian</nationality>
  </author>
  <author period="classical">
    <name>Plato</name>
    <nationality>Greek</nationality>
  </author>
</authors>
```

In the XAI tool, XPath is used to construct outgoing messages.

Server Security

XAI server security supports the basic HTTP authentication mechanism as well as web service security (WS-Security) to authenticate the user requesting service. When authenticating using WS-Security, the SOAP header contains the authenticating information.

The base package provides two XAI server URLs, one that uses basic HTTP authentication ('/classicxai') and another that supports both methods ('/xaiserver'). Regardless of which authentication method is practiced, it is the latter you should expose as your main XAI server. The main XAI servlet gathers authentication information from the incoming request (HTTP or SOAP header) and further calls the internal ("classic") servlet for processing.

The "classic" XAI server security uses the basic HTTP authentication mechanism to authenticate the user requesting service. It assumes the requester has been authenticated on the Web server running the XAI servlet using the standard HTTP (or HTTPS) basic authentication mechanism. The authenticated user-id is passed to the application server, which is responsible for enforcing application security. This requires the system administrator to enable basic authentication for the Web server running the XAI servlet. To enable HTTP basic authentication, the XAI server '/classicxai' should be defined as a url-pattern in the web resource collection in the web.xml file. When the XAI server is not enabled for basic authentication, it transfers the user-id specified on the **Default User** *XAI Option* to the application server.

By default, the system would always attempt to further authenticate using SOAP header information. This is true even if the request has already been authenticated via the Web server. Use the **Enforce SOAP Authentication** *XAI Option* to override this behavior so that a request that has been authenticated already by the Web server does not require further authentication by the system.

If SOAP authentication information is not provided, the system attempts to authenticate this time using information on the HTTP header. You can force the system to solely use SOAP authentication using the **Attempt Classic Authentication** *XAI Option*.

Currently the system only supports the standard *Username Token Profile* SOAP authentication method where "Username", "Password" and "Encoding" information is used to authenticate the sender's credentials. The following is an example of a *Username Token Profile* in a SOAP header:

```
<SOAP-ENV:Envelope xmlns:SOAP-ENV = "urn:schemas-xmlsoap-org:envelope">
<SOAP-ENV:Header xmlns:wsse="http://www.w3.org/2001/XMLSchema-instance">
<wsse:Security>
<wsse:UsernameToken>
<wsse:Username>MYUSERID</wsse:Username>
<wsse:Password Type="PasswordText">MYPASSWORD</wsse:Password>
</wsse:UsernameToken>
</wsse:Security>
<SOAPActionVersion>2.0.0</SOAPActionVersion>
</SOAP-ENV:Header>
<SOAP-ENV:Body>
...
</SOAP-ENV:Body>
</SOAP-ENV:Envelope>
```

By default both user and password are authenticated. You can use the **System Authentication Profile** *XAI Option* to change this.

Note: Custom authentication. You can override the base package user credentials authentication logic using the **System Authentication Class** *XAI Option*.

Inbound Messages

Inbound messages are XML messages sent by an external application to invoke a system service. Inbound messages can be sent one at a time or in batches of several messages in a file. Third party integration points can import web services for inbound service calls. The standard method of doing this is by publishing a WSDL (Web Service Definition Language) definition for each exposed service.

Synchronous Messages

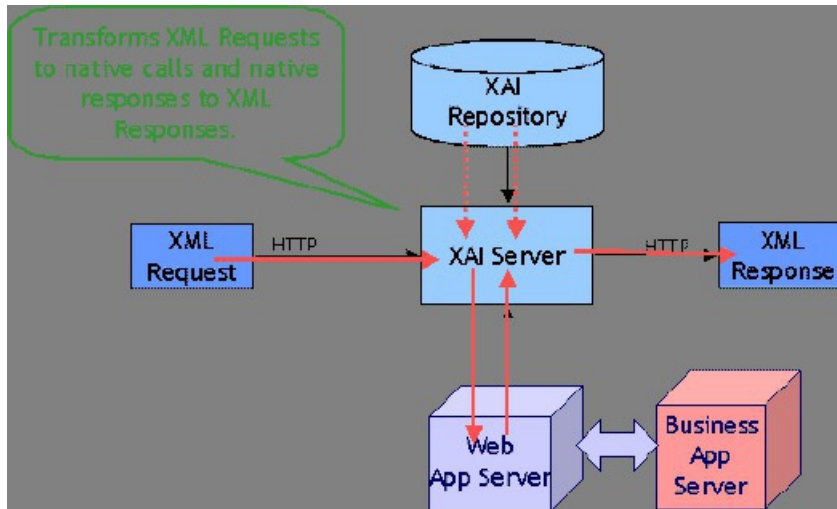

Synchronous service requests are sent using the HTTP protocol to the XAI servlet, which runs under a web application server such as WebLogic.

- The service request XML document must conform to the request schema that defines the service.
- The XAI servlet on the web server receives the service request XML document and based on the service name in the document identifies the appropriate XAI Inbound Service. Once the service is identified, the XAI servlet accesses the XAI Inbound Service record to find out the properties of the service.
- Based on the service properties, the XAI module loads the request and response schemas from the schemas repository (and caches them in memory).
- Based on the Adapter referenced by the service, it calls the appropriate adapter. The adapter performs most of the work to service the request.
 - The adapter connects to the application server, based on the connection information in the registry control tables.
 - It then parses the request document using the request schema.
 - Once the request document has been validated, the adapter converts the XML request document into a call to the application server.
- The response returned by the application server is then converted into a service response XML document, based on the response schema.
- The XML response document is shipped back to the caller over HTTP.

Using HTTP for Synchronous Service Execution

Invoking a service is not much different from sending a regular HTTP request. Here the HTTP request contains the XML as a parameter. The XAI server handling requests via the HTTP protocol is implemented using a Java servlet running on the web server.

Microsoft Visual Basic/C Example

Microsoft provides an easy way to send XML requests over HTTP. To send and receive XML data over HTTP, use the Microsoft XMLHTTP object

```
set xmlhttp = createObject("Microsoft.XMLHTTP")
xmlhttp.Open "POST", http://localhost:6000/xaiserver, false
xmlhttp.Send XMLRequest
XMLResponse = xmlhttp.ResponseText
```

Here **http://localhost:6000/xaiserver** is the URL of the XAI server. **XMLRequest** contains the XML request to be processed by XAI and **XMLResponse** contains the XML response document created by the XAI runtime.

Java Example

Java provides a very simple way to send a request over HTTP. The following example shows how a request can be sent to XAI from an application running under the same WebLogic server as the one XAI runs. In this example, we use the "dom4j" interface to parse the XML document.

```
import com.splwg.xai.external.*;
import org.dom4j.*;
String xml;
xml = "<XML request>";
XAIHTTPCallForWebLogic httpCall = new XAIHTTPCallForWebLogic();
String httpResponse = httpCall.callXAIServer(xml);
Document document = DocumentHelper.parseText(httpResponse);
```

Asynchronous Messages

Various types of *receivers* running under the MPL server (rather than the XAI server) handle asynchronous inbound messages from several sources.

Requests may be received via the following:

- MQSeries, TIBCO or any JMS compatible messaging system
- The XAI Upload Staging table

The response is returned to the JMS queue/topic or to the staging table.

Fastpath: Refer to *Designing XAI Receivers* for more information about the different receivers provided by the product for the different data sources.

The following diagram shows the flow for asynchronous inbound messages.

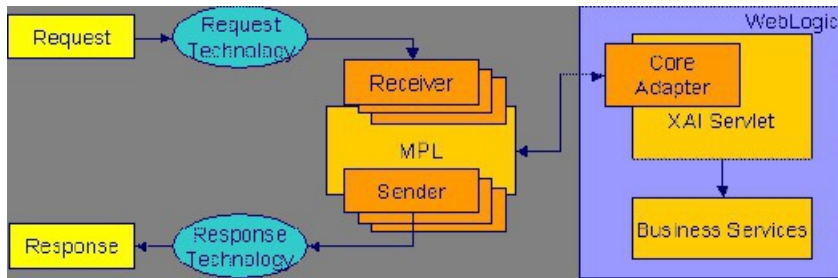

Using JMS

Java Message Services (JMS) is a standard Java 2 Platform, Enterprise Edition (J2EE) protocol to send/receive asynchronous messages using a queue or topic message protocol.

XML messages may be received and sent via JMS using either a JMS Queue or JMS Topic. In order to access a JMS provider such as MQSeries, TIBCO or WebLogic, the MPL must first connect to the appropriate server using a JMS Connection.

The following diagram depicts a message sent and received through a JMS Queue.

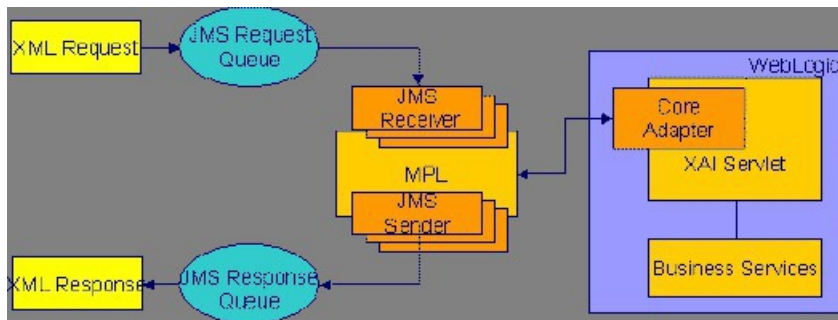

Using JMS Queues

JMS Queues are used to receive and send messages using the message queue protocol. Products that support this protocol include MQSeries.

The following describes events that take place when a JMS queue is used:

- The requester places the XML request message on a JMS queue. The request contains both the XML message and the name for the *reply queue*.
- The *JMS Queue Receiver* waits for messages on that queue. When the message arrives it is selected from the queue and executed using the adapter for the requested service.
- The XML response message is placed on the reply queue specified in the request. It is the requester's responsibility to fetch the response message from the queue.

The MPL uses a *JNDI server* to locate the queue resource.

Fastpath: Refer to *Designing XAI JMS Queues* for more information.

Using JMS Topics

JMS Topics are used to send and receive messages using the publish/subscribe messaging model. Products that support this protocol include TIBCO, MQSeries and WebLogic.

The MPL uses a *JNDI server* to locate the topic resource.

- Define a *JMS Topic receiver*, listening to a predefined JMS Topic.
- The other application builds an XML message based on the schema defined for that service.
- It sends the XML request to the predefined topic and specifies the reply topic name.
- The MPL reads the message from the Topic, executes the service and returns the response to the reply topic specified in the inbound message.

Fastpath: Refer to *Designing XAI JMS Topics* for more information.

Staging Upload

The system provides a staging table, where an interface can store XML requests to perform a service in the system.

Some external systems interfacing with the system are not able to produce XML request messages. Or you may have external systems that produce XML messages but the messages are sent in a batch rather than real time. The system provides the capability to read an external data source containing multiple records, map the data to an XML request and store the request on the *XAI upload staging* table. These records may be in XML requests, sequential input files or database tables.

The XAI upload staging table may be populated in one of the following ways:

- When a collection of messages in a file or database table must be uploaded, a *staging control* record should be created for each file/database table. The *Staging Control Receiver* processes each file or database table and creates records in the XAI upload staging table for each message.
- The *XML File Receiver* creates records directly in the XAI upload staging table. Note, in addition, the XML File Receiver creates a staging control record to group together these records.
- XAI creates records in the XAI upload staging table for *inbound messages in error* that are configured to post the error.
- It is possible that when a response to a notification download staging message is received (Oracle Customer Care and Billing only), the response requires some sort of action. If this is the case, the system creates an XAI upload staging record (and an XAI staging control record) for the response.

Staging Upload Receiver

Once the XML requests are in the staging table, the *Staging Upload Receiver* reads the requests from the XAI upload staging table and invokes the XAI server (via the executor) with the appropriate XAI inbound service. Inbound service records typically point to the core *adapter* used to invoke system services.

Staging Upload Sender

The staging upload *sender* handles "responses" to the execution of the message in XAI upload staging. If the execution is successful, the sender updates the status of the upload staging record to **complete**. If the execution is unsuccessful, the sender updates the status to **error** and creates a record in the *XAI upload exception* table.

Note: Configuration required. The above explanation assumes that you have correctly configured your upload staging receiver to reference the upload staging sender. Refer to *Designing Responses for a Receiver* for more information.

Staging Control

The *staging control* table is used to indicate to XAI that there is a file or table with a collection of records to be uploaded. The special *Staging Control Receiver* periodically reads the staging control table to process new records.

The XAI staging control table may be populated in one of the following ways:

- To process a specific sequential input file, manually create a staging control record and indicate the location and name of the file and the XAI inbound service to use for processing. Use this mechanism to process ad-hoc uploads of files.
- If a file is received periodically, you may define a *File Scan Receiver*, which periodically checks a given file directory for new files. The file scan receiver creates a new staging control record to process this file.
- The *XML File Receiver* processes a file containing a collection of XML messages to be uploaded. The XML file receiver creates a staging control record and creates records directly into the XML upload table. The staging control record is automatically set to a status of **Complete** and is used to group together the XML upload records. Refer to *Processing Staging Upload Records for a Staging Control* for more information.
- To upload records from a database, manually create a staging control record and indicate an appropriate XAI inbound service, which contains the information needed by the system to access the appropriate table. Use this mechanism to process ad-hoc uploads of files.

Note: To upload records from a database table, you must create a staging control record. There is no receiver that periodically looks for records in a database table.

- To upload records from a Lightweight Directory Access Protocol (LDAP) store, use the *LDAP Import* page to select users or groups to process. Uploading records from this page causes a staging control record to be created. In addition, you may manually create a staging control record to upload data from an LDAP store and indicate the appropriate file to import. Refer to *How Does LDAP Import Work* for more information.
- Whenever an *XAI upload staging* record is created, an XAI staging control record is created as well.

Fastpath: Refer to *Batch scenarios* for more information about configuring the system to populate the staging control with requests from external files.

Staging Control Receiver

The Staging Control *Receiver* processes staging control records and invokes XAI (via the executer) to execute the request. The executer uses the appropriate adapter to generate records in the *XAI Upload Staging* table - one for each record in the file or table.

The diagram below illustrates the information used by the staging control receiver to load data onto the staging table from a sequential input file.

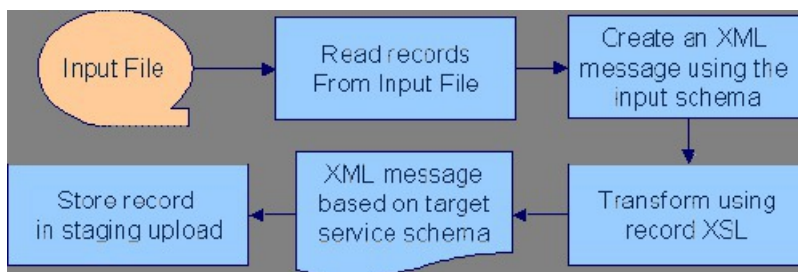

The staging control *adapter* does the actual work. It reads the individual records in the input file and applies the XSL transformation script indicated on the XAI inbound service record to the input data to produce an XML request in the XAI upload staging table.

Processing Staging Upload Records for a Staging Control

In some cases, a process may populate records directly into the XML staging upload table. An example of such a process is the *XML File Receiver*. In this case, a staging control record is also created and used to group together the staging upload records.

The staging control contains information needed to process a group of staging upload records:

- The user related to these records. This user is for application security purposes. The user indicated here must have the proper rights for the application service and transaction type to be executed by XML upload records processed for this staging control.
- An indication of whether or not the records should be processed *sequentially*.

Processing Staging Records in Sequential Order

In some cases, a collection of messages uploaded together in a file must be processed in the order the messages are received. For example, if messages to add a person and add an account for this person are received together, the message to add the person must be processed before the message to add the account.

If messages received in a file must be processed sequentially, turn on the Sequential Execution switch on the *staging control* record. When the staging control receiver creates records in the XML upload table, the identifier of each record is built as a concatenation of the staging control record and a sequential number. If your staging control record indicates that the XML upload records should be processed in sequential order, the records are processed in primary ID order.

Note: Non-sequential processing. If your staging control does not indicate that the related XML records should be processed in sequential order, the records are processed by the staging control receiver using a random, multi-threaded mechanism.

If you have defined a *receiver* to periodically search for files and populate records in the staging control table, you may turn on the Sequential Execution switch on the receiver. This ensures that records processed as a result of this receiver are executed in sequential order.

Staging Control Parameters

If your staging control accesses the data from a database table, you have the capability of defining the selection criteria. *XAI inbound services* that reference the **CISStagingUpload** adapter may contain a collection of fields that are used in an SQL WHERE clause. When adding a new *XAI Staging Control* record, you can define the values for the WHERE clause.

For example, imagine that you have a work management system where new premises are defined. Rather than waiting for this system to "push" new data to you, you design the interface to have the system "pull" the new data by looking directly at the "new property" database table.

The Request XML for your XAI service contains SQL statements used to access the data. You could define a Staging Control Parameter of "Add Date". When creating your staging control, you may enter a parameter value of today's date. When this record is processed, it only retrieves new properties from this work management table whose Add Date is today.

The following example shows part of the Request XML schema for an XAI Service that SELECTs premises based on postal code.

```

- <Schema xmlns="urn:schemas-microsoft-com:xml-data" xmlns:dt="urn:schemas-microsoft-com:datatypes" xmlns:d="urn:schemas-microsoft-com:datatypes" xmlns:b="urn:schemas-microsoft-com: BizTalkServer" b:root_reference="TestDuplicatePremise">
- <ElementType name="TestDuplicatePremise" content="eltOnly">
  <b:property name="adapter">CISStagingUpload</b:property>
  <b:property name="stagingUploadType">DB</b:property>
  <element type="Request" />
  <element type="Response" />
</ElementType>
- <ElementType name="Request" content="eltOnly">
  <AttributeType name="Postal" d:type="string" d:maxLength="12" />
  <b:RecordInfo />
  <attribute type="Postal" />
</ElementType>
- <ElementType name="Response" content="eltOnly">
  <b:RecordInfo />
  <element type="Premises" />
</ElementType>
- <ElementType name="Premises">
  <b:RecordInfo />
  <b:property name="SQL">SELECT PREM_TYPE_CD, KEY_SW, OK_TO_ENTER_SW,
TREND_AREA_CD, ADDRESS1, MAIL_ADDR_SW, POSTAL FROM CISADM.CI_PREM WHERE
POSTAL = @TestDuplicatePremise/Request/Postal</b:property>
  <b:property name="tableName">CISADM.CI_PREM</b:property>
- <AttributeType name="PREM_TYPE_CD" d:type="string" d:maxLength="008">
  <b:property name="dataType">string</b:property>
  <b:property name="uniqueId">PREM_TYPE_CD</b:property>
  <b:FieldInfo />
</AttributeType>
- <AttributeType name="KEY_SW" d:type="string" d:maxLength="001">
  <b:property name="dataType">string</b:property>
  <b:property name="uniqueId">KEY_SW</b:property>

```

The postal code value to substitute into the WHERE clause is defined on the individual XML Staging Control records.

Fastpath: Refer to [Creating a Schema for a Database Extract](#) and [XAI Staging Control](#) for more information.

Staging Control Sender

Before the staging control receiver invokes the executor, it changes its status to **complete**, assuming that there will be no problems. If the executor detects an error condition, the staging control sender updates the status of the staging control record to **error** and removes any XAI upload staging records that may have been created.

Note: Configuration required. The above explanation assumes that you have correctly configured your staging control receiver to reference the staging control sender. Refer to [Designing Responses for a Receiver](#) for more information.

Inbound Message Error Handling

For messages that are processed using the *staging upload* table, application errors that prevent XAI from successfully processing the message cause the staging record to be marked in error and highlighted via a To Do entry.

For messages that are not processed via staging upload, your implementation should consider what should happen to application errors. If the origin of the message is able to handle an immediate error returned by XAI, then no special configuration is needed. An example of this is an HTTP call to our system where the originator of the message is waiting for a real-time response.

Otherwise, for messages where errors should not be returned to the originator, but should be highlighted in this system for resolution, be sure to mark the **Post Error** switch on the *XAI inbound service*. When this switch is turned on and an application error is received by XAI when processing the message an *XAI upload staging* record is created (along with a staging control record) and marked in **error**.

For example, if a message is received via a JMS queue, application errors that prevent XAI from processing the message should not be returned to the queue because there is no logic to route the error to the sending system.

Integration Scenarios

Integration Using an EAI (or Hub)

It is possible for your various systems to be integrated with each other using a hub. The hub is implemented using an Enterprise Application Integration (EAI) tool provided by a third party vendor. Most hubs support HTTP and/or JMS and can work with XML schemas or document type definitions (DTDs).

- XAI services are presented to the EAI tool as schemas or as DTDs, immediately making the system callable from the hub.
- Integration scripts or workflow processes are defined in the EAI tools.
- At run time the hub uses HTTP or JMS to access the system using inbound messages.
- Outgoing messages are used to notify the hub about events occurring in the system. The messages are sent using HTTP or JMS.

Batch Scenarios

Messages may be sent in batch files, or may be retrieved from a database. In all cases, the system needs to be able to read the file and identify each individual message in order to create an XML request that can be processed by the XAI server. Once each individual message is identified, a request is stored on the XAI Staging Upload table for later execution.

XML Message File

It is possible for you to receive a file containing a collection of XML messages. The system identifies each separate message within the file and creates an entry for each message on the XAI upload staging table. It also creates a staging control record to group together each newly created XAI upload record. This staging control is created in **Complete** status and is not processed by the staging control receiver.

Since external applications may send messages in a format unknown to XAI, the system needs a mechanism for identifying the messages and mapping them to an XAI service.

XAI Groups

First the system associates the entire XML file with an XAI Group. You can think of the XAI Group as a categorization of the collection of messages. For example, you may have a separate XAI Group for each third party who sends you a collection of XML messages.

The system uses an *XPath* and XPath value to identify the correct XAI Group for the XML file.

Attachments and Rules

After identifying the appropriate group to which an XML file belongs, the system takes each message in the file and applies the appropriate XSL transformation to the message to produce a record on the upload staging table.

To process the messages in a file, the system needs to know how to identify each message in a file containing multiple messages. A file may use the same root element for each message or different root elements for different types of messages. For each XAI group, you must indicate the root element(s) that identifies a message by defining one or more attachments. Each attachment defines a root element, which tells the system when a new message begins.

Once the system has identified each separate message in the file, it must determine the correct XSL transformation script to apply. Once again the system uses an *XPath* and XPath value to identify the correct XSL to apply. For each XAI group, you define one XAI rule for every possible type of message you may receive in the file. Each XAI rule defines an XPath, XPath value and XSL transformation script.

Note you may assign a priority to each of your rules. The rules for more common messages may be assigned a higher priority. This enhances performance by ensuring that rules for more common messages are processed before rules for less common messages.

Note: Include parent elements. If the XML message includes parent elements (such as a transmission id or a date/time) that are needed for any of the separate child messages that are posted to the upload staging table, you can configure the appropriate attachment to include **parent** elements.

Fastpath: Refer to *Designing an XML File Receiver* for more information about defining receivers that process XML files.

Sequential Input File

You may receive messages in a sequential input file, such as a comma-delimited file.

Fastpath: Refer to *Creating an XML Schema for a Sequential Input File* for more information about creating schemas for this type of file.

The following steps should be performed when configuring the system to enable data to be uploaded from an input file into the staging upload table:

1. *Create an XML Schema* that describes the records in the sequential input file.
2. *Create the XSLT transformation* that maps a record in the input file to an XML service request in your product.
3. Create an *XAI service* representing the batch process that loads the input file into the staging table.
4. If desired, create a new file scan receiver, which waits for an input file to appear in a particular directory. (If you do not take this step, then you need to create a *staging control* when you want a file to be processed.)

Note: Character Encoding. If the file is encoded with a specific character encoding, you may indicate the encoding as part of the file name to be uploaded. If the file name ends with **?enc=?x**, where x is the file character encoding, the adapter processes the file accordingly. For example, the file name may be specified as **premiseUpload.csv?enc=?UTF-8**. If the encoding is not specified as part of the file name and the file is in UTF-16 or UTF-8 with byte order mark, then the adapter can recognize the encoding.

Database File

It is possible for you to define an interface where inbound messages are retrieved by reading records in a database table.

The following steps should be performed when configuring the system to enable data to be uploaded from a database table into the staging upload table:

- Create an *XML Schema* that describes the records in the database table.
- *Create the XSLT transformation* that maps a record in the database table to an XML service request in your product.
- Create an *XAI service* representing the process that loads the records from the database table into the staging table.

LDAP Import

Refer to *Importing Users and Groups* for information about using XAI to import user and user group definitions from a Lightweight Directory Access Protocol (LDAP) store.

WSDL Catalog

Web Service Definition Language (WSDL) is a language for describing how to interface with XML-based services. It acts as a "user's manual" for Web services, defining how service providers and requesters communicate with each other about Web services.

The base package provides the ability to publish a WSDL definition for each service exposed as an *XAI Inbound Service*. In addition, it is possible to request a catalog of all the XAI Inbound Services and a link to each WSDL. To view the catalog, launch a new browser session and enter the URL **http://\$host:\$port/XAIApp/xaiserver?WSDL** where \$host and \$port are replaced by the appropriate values for the current environment.

Outgoing Messages

"Outgoing messages" is the term used to describe messages that are initiated by our system and sent to an external system. Messages may be sent real time or near real time. The system provides two mechanisms for communicating messages to external systems.

- Outbound messages. This method allows implementers to use configurable business objects to define the message format and to use scripts to build the message. If sent near real-time the message is posted to the outbound message table waiting for MPL to poll the records, apply the XSL and route the message. If sent real time, the message dispatcher routes the message immediately.
- Notification download staging (NDS) messages. Using this method near real-time, a record is written to the NDS staging table referencing only key fields. MPL then polls the records, invokes a service to build the message, applies the XSL and routes the message. If sent real-time, no record is posted to the staging table but rather the message dispatcher routes the message immediately.

The following sections describe the outbound messages mechanism in more detail.

Fastpath: For NDS, refer to Oracle Customer Care and Billing help, Workflow and Notifications, Notification and XAI.

Near Real Time Messages

This section describes the capability to send outgoing messages from the system to another application in "near real time" using Outbound Messages and XAI. The process is referred to as "near real time" because an appropriate MPL receiver is continuously checking for new records in the outbound message table for processing.

For each outbound message that your implementation must initiate you define a *business object* for the outbound message maintenance object. Using the business object's schema definition, you define the fields that make up the XML source field. These are the fields that make up the basis for the XML message (prior to XSL transformation).

For each external system that may receive this message, you configure the appropriate message XSL and routing information.

Because the outbound message type is associated with a business object, your implementation can easily create outbound message records from a script using the **Invoke business object** *step type*. Such a script would

- Determine the appropriate *outbound message type* and *external system* based on business rules
- Access the data needed to populate the message detail
- Populate the fields in the schema and use the **Invoke business object** script step type for the outbound message type's business object to store the outbound message.

- The resulting outbound message ID is returned to the script and the scriptwriter may choose to design a subsequent step to store that ID as an audit on the record that initiated this message (for example store a case long entry or a field activity log entry)

The remaining points describe how the outbound message record is further processed.

Outbound Message Receiver

The outbound message *receiver* processes records in the outbound message table that have a processing method flag equal to **XAI** and a status of **pending** and changes the status to **in progress**. The receiver then retrieves the message XSL and the XAI sender defined for the external system / outbound message type.

Note: Template external system. If the outbound message's external system references a template external system, the outbound message type configuration for the template external system is used.

It applies the message XSL (if supplied). If the option to *validate outbound message schemas* is turned on, the schema validation is performed.

Refer to *Outbound Message Error Handling* for information about error handling.

If no errors are received, control is turned over to the *outbound message sender* for routing.

Note: Initialization of receiver. During the initialization of this receiver (for example if there is a problem with MPL and it is restarted) any records that are found to be **in progress** are changed to **pending** so that those messages are sent properly.

Lifecycle of Outbound Message

The outbound message receiver processes outbound message records based on their status. The following diagram describes the lifecycle of an **XAI** type outbound message.

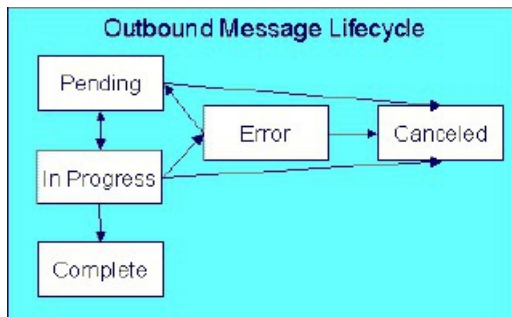

- Records are created in **pending** status.
- The outbound message receiver processes pending records and changes the status to **in progress**.
- If the message is sent successfully the system changes the status to **complete**.
- If there was a problem sending the message the system changes the status to **error**.
- When the user resolves the error they can change the status back to **pending**.
- A user can change the status of a **pending** or **error** record to **anceled**.
- For the rare cases where there is a problem with MPL and a message is left in the status **in progress**, users may manually change the status to **anceled**. In addition the outbound message receiver includes a step at startup to find **in progress** messages and change them to **pending**.

Outbound Message Sender

The outbound message sender is responsible for routing the message to the *XAI sender* determined by the receiver. If the routing is successful the outbound message status is marked **complete**. If the routing is unsuccessful, the status is marked in **error**.

Refer to [Outbound Message Error Handling](#) for information about error handling.

Note: Automatic Resend. If you have configured the system for *automatic resend* and the system detects that the error is due to the sender being unavailable, the message remains in **pending** status.

Note: Configuration required. The above explanation assumes that you have correctly configured your outbound message receiver to reference the outbound message sender. Refer to [Designing Responses for a Receiver](#) for more information.

Outbound Message Error Handling

If the outbound message receiver or the outbound message sender detects an error while attempting to process the outbound message, it marks the message in **error**, captures the error message and its parameter values and creates a To Do entry using the To Do type specified in the XAI option **To Do Type for Outbound Message Errors**.

A separate background process *F1-DTDOM* is responsible for completing To Do entries for outbound messages no longer in **Error**.

Batch Message Processing

Your implementation may be required to send messages to the same destination as a single XML file with multiple messages include. The following points describe this logic:

- The individual messages that should be grouped together must have a processing method of **batch** on the external system / outbound message type record. The appropriate batch code that is responsible for grouping the messages must also be provided.
- A separate "consolidated message" outbound message type should be configured for the external system with a processing method of **XAI** and an appropriate XAI sender.
- When outbound message records are created for the individual messages, the batch code and current batch run number are stamped on the record.
- When the batch process runs it is responsible for building the XML file that is a collection of the individual messages. This batch process should include the following steps:
 - Format appropriate header information for the collection of messages
 - Apply the individual message XSL to each message before including the message
 - Insert a new outbound message for the external system with the "consolidated message" outbound message type. This consolidated message is routed to the appropriate sender via XAI.

Note: No process provided. The system does not supply any sample batch job that does the above logic.

Outbound Message Schema Validation

The outbound messages that are generated by the system should be well formed and valid so that they do not cause any issues in the external system. To ensure this validity you may configure the system to validate messages before they are routed to their destination.

- Define a directory where the valid W3C schemas are located using the XAI option **Outbound Message Schema Location**
- Each *external system* message must indicate the appropriate W3C schema to validate against

You may turn on or off this validation checking using an XAI option **Schema Validation Flag**.

Automatic Resend

If a system error is received by the MPL when attempting to route the message to a sender, (using the outbound message method or the NDS message method), the system marks the appropriate table in **error**. This is true even if the reason for the error is that the connection to the sender is unavailable. When the connection is restored, a user must change the status of the appropriate record to **pending** (for outbound messages) or **retry** (for NDS messages) in order for the message to be resent.

Alternatively, you can configure your system to attempt to automatically resend the message. This section describes the logic available for auto resend. To enable automatic resend, you must set the flag **Automatically Attempt Resending to Unavailable Senders** on *XAI option* appropriately.

If an error is received by the MPL when it attempts to invoke a sender and the auto resend option is on, the system does not mark the record in **error**. It continues to attempt sending messages to the sender until the number of errors has reached a predefined maximum error number (defined as an *XAI option*). When the maximum is reached, the sender is marked as **unavailable** and an MPL log entry is created. The MPL ignores messages for **unavailable** senders.

The system tries to resend messages to this sender the moment the sender is reset to be **available**. The following points describe how a sender becomes **available**:

- MPL attempts to retry sending messages to unavailable senders every X minutes, where X is defined on *XAI option*.
- On MPL startup all senders are marked as **available**
- A user may navigate to the *XAI Command* page and issue a command **MPL Refresh Sender** to refresh the cached information for a particular sender

Real Time Messages

The system supports the ability to make web service calls, i.e. sending real time messages, to an external system. The configuration of real time messages is similar to the configuration of near real-time ones, with the following exceptions:

- The processing method defined for the outbound message type and an external system must be **Real-time**.
- The *XAI sender* defined for the outbound message type and an external system has to be set up with **Real-time** invocation type.

Just like near real-time messages, you can easily create outbound message records from a script. When a real time message is added, the system immediately routes it to the external system. If the external system provided a response message back, the system captures the response on the outbound message. If the outbound message type for the external system is associated with a response XSL it is applied to transform the response. In this case the system captures the raw response as well on the outbound message.

Any error (that can be trapped) causes the outbound message to be in a state of **Error**. It is the responsibility of the calling process to check upon the state of the outbound message and take a programmatic action. When the outbound message state is changed back to **Pending** the message will be retried.

The base package provides a business service called "Outbound Message Dispatcher (F1-OutmsgDispatcher)" that further facilitates making web service calls, allowing the calling script to configure the following behavior:

- Whether or not the sent message is captured as an actual outbound message record.
- Whether or not exceptions encountered while sending the message are trapped. Trapping errors allows the calling script to interrogate any errors encountered and take some other programmatic action.

Refer to the description of the business service for a better understanding on how it works.

Note: HTTP Sender. In the current release of the product, only senders that communicate via HTTP are supported.

Designing Your XAI Environment

This section guides you through the steps required to design the tables that control your XAI processing.

Installation

The XAI server is installed with default configuration. This section describes how you may customize the XAI server configuration.

Startup parameters are defined in two parameters files

- The XAIParameterInfo.xml file is used by the XAI HTTP server. This file is found within the XAI directory in the path (...\\splapp\\xai).
- The MPLParameterInfo.xml file is used by the MPL server. This file is found within the XAI directory in the path (...\\splapp\\mpl).

Both files store the parameters as XML files with the following elements (sections):

- Source
- ParameterVariables
- AdHocParameters

The XAI Source Section

The XAI tool accesses XAI *registry* information through the standard system programs. The <Source> section in the XAIParameterInfo.xml file tells XAI the user ID for accessing the registry information. It contains the following attributes:

Attribute Name	Description
Source Type	This should be set to CorDaptix , which tells XAI to access the registry through the standard access to system programs.
CorDaptixUser	The user ID to use when accessing the registry data.

The MPL Source Section

The <Source> section in the MPLParameterInfo.xml file defines the database connection information used to connect to the database storing the XAI table information. It contains the following attributes:

Attribute Name	Description
Source Type	Defines the source of the data, for example ORACLE or DB2 .
jdbcURL	The URL used to connect to the product database. For example: jdbc:oracle:thin:@//server-name:1234/DBNAME
databaseUser	The Oracle User Id used to connect to the database. For example: sysuser
databaseUserPassword	The Oracle password used to connect to the database. For example: sysuserpassword

The Parameter Variables Section

When defining values for fields in certain control tables in the registry, you may reference substitution variables that point to the <ParameterVariables> section of the installation files. Substitution variables provide for dynamic substitution of values based on parameters provided at server startup.

To specify a substitution parameter in a string value you enter the name of the substitution parameter enclosed with @.

For example if you have a field in the XAI control tables that should contain the URL for the XAI HTTP servlet, you could enter the value in the following way: **http://@HOST@:@PORT@/xaiserver**.

In the parameters section, define the appropriate values for these parameters, for example:

```
<ParameterVariables>
<ParameterVariable name="HOST" value="localhost" />
<ParameterVariable name="PORT" value="8001" />
</ParameterVariables>
```

At run time, the system builds the URL as `http://localhost:8001/xaiserver`.

Every substitution parameter is defined using an <ParameterVariable> element with the following attributes:

Attribute Name	Description
Name	The name of the substitution parameter
Value	The value to replace an occurrence of the substitution parameter in an XAI control table field

Note: Substitution parameters can only be used for string fields, and not for fields that are foreign keys to other objects.

The AdHoc Parameters Section

The <AdHocParameters> section is used to provide registry definitions that override the existing ones. Unlike the <ParameterVariables> section, a whole registry object definition can be specified in this section. When the XAI server starts, it first reads the registry definitions from the database and then it reads the <AdhocParameters> section. If it finds an object definition in this section, it uses it to replace the one read from the database.

Attribute Name	Description
Object Name	The object name may be one of the following objects: Option Receiver Sender
Object Attributes	The attributes of the object. Each object type has its own set of attributes:
'Option' object attributes	
name	The option flag. Must be defined in the OPTION_FLG table
value	The value for that option
'Receiver' object attributes	
name	The receiver ID
Class	The JMS provider. May be 'MQ'
TargetClient	The client type writing/reading to the JMS queue/topic. May be 'JMS' or 'MQ'. Only relevant for interfacing with MQSeries
JMSProvider	The JMS provider. May be 'MQ'
TargetClient	The client type writing/reading to the JMS queue/topic. May be 'JMS' or 'MQ'. Only relevant for interfacing with MQSeries

Executer	The XAI Executer ID for this receiver
'Sender' object attributes	
Class	The JMS provider. May be 'MQ'
JMSProvider	The JMS provider. May be 'MQ'
TargetClient	The client type writing/reading to the JMS queue/topic. May be 'JMS' or 'MQ'. Only relevant for interfacing with MQSeries

Note: LDAP Import Mapping. If your organization integrates with an LDAP store, you must define your LDAP import mapping and create a reference to this mapping in the ad-hoc parameters section. Refer to [Including Your LDAP Import Mapping in the XML Parameter Information File](#) for more information.

Designing XAI Inbound Services

When designing your XAI environment, you should first identify the services that you would like to perform. Determining your services facilitates your design for the other registry options.

To design your inbound services,

- Determine each service that needs to be performed
- Determine the correct *adapter* that is needed by your service.
- Determine the required layout of the request and response messages and specify the request *schema* and response *schema*.
- If a transformation of the data is required, you need to design the appropriate request XSL and response *XSL transformation* scripts.
- If the service references the staging upload adapter, determine the staging file type and design the record XSL transformation script. In addition, determine if you want to enter an input file name and interface name. Finally, determine whether or not you need to indicate a special *JDBC connection*.
- As new releases of the system are installed, it may be necessary to modify your service for the new release. If this is the case, you need to design separate versions of the inbound service.

Fastpath: Refer to [XAI Inbound Services](#) for more information.

Designing XML Schemas

You need XML schemas for the services you designed in [Designing XAI Inbound Services](#).

For each message, identify what service you need to invoke and what action you need to perform. If you have multiple actions that you may need to perform for the same service, you may choose to create a single generic XML schema or you may choose to create multiple schemas, which are more specific. For generic messages, the transaction type, indicating the action to perform would be passed in on the XML request document to indicate what must be done. For more specific messages, you may be able to indicate the transaction type directly on the schema and it would not need to be overwritten at run time.

You need to create a response schema for each request schema. It is possible for you to use the same schema for both functions.

Fastpath: Refer to [Schema Editor](#) and [How To Create XML Schemas](#) for more information.

Designing XSL Transformations

You need an XSL transformation script for each service you designed in [Designing XAI Inbound Services](#), where you determined a transformation is necessary. In addition, you need XSLT scripts for your outgoing messages. Each sender, which receives a message, probably requires a transformation of the message into a local format. Refer to [How To Design Outgoing Messages](#) for more information.

For each message requiring transformation, determine the format used by the external system. In most cases, it is not the same format recognized by the system. For each case, you must create an XSL transformation, which maps the message format from the external format to one expected by your product or from your product format to one expected by the external system.

When identifying the required XSL transformations, remember to take into consideration the data that is processed by the staging control table. This service reads data stored in a file or database table and uses the Record XSL to map the individual records to an individual service request.

Fastpath: Refer to [How To Create an XSL Transformation](#) and [XAI Inbound Service](#) for more information.

Designing Your Registry Options

The XAI registry is a set of control tables that is used to store service definitions as well as various system information required by the XAI and MPL servers. The following sections describe each table in the registry.

Designing XAI JNDI Servers

The XAI tool, including receivers and senders, uses a Java Name Directory Interface (JNDI) server to locate resources on the network. JDBC connections, JMS connections, JMS queues and JMS topics should be defined on the JNDI server. In addition, adapters that need to access your product information reference the JNDI server to determine where your product is running.

Design your JNDI server values as follows:

- Define a JNDI server that indicates where the system is running.
- If you are using JMS resources, such as JMS Queue or JMS Topic, and these are located in a server other than the one where the system is running, define the server where these resources are located.
- If you are using [LDAP Import](#), define a JNDI server that points to the LDAP server.
- If there are any other resources that may be needed by XAI, define a JNDI server to indicate where these are located.

The product is shipped with a JNDI server running under the same Weblogic server used for the system.

When defining the URL, you may use substitution parameters such as those shown in the example below. XAI uses the parameter variables section of your start up parameters to build the appropriate URL. Refer to [Installation](#) for more information

JNDI Server	Description	Provider URL
WLJNDI	Weblogic JNDI Server	t3://@WLHOST@:@WLPORT@
ACTDIR	Active Directory Server	ldap://@LDAPHOST@:@LDAPPORT@

Designing XAI JDBC Connections

If you need to access a database table to process your messages, XAI needs to know the location of the database and how to access it. If the tables are located in the same database used for the system (defined in your [Installation](#)), then you do not need to enter any extra JDBC Connections. If you need to access data that lives in another database, design the additional JDBC Connections and determine the type of connection and connection information.

Fastpath: Refer to [XAI JDBC Connections](#) for more information about defining XAI JDBC Connections.

Designing XAI JMS Connections

If you are using JMS to send and receive messages, then you must define a JMS Connection to indicate the JNDI server to use to locate these resources. For each JMS connection defined, the [MPL](#) server creates a pool of connections that are later shared by multiple threads.

Fastpath: Refer to [XAI JMS Connections](#) for more information about defining XAI JMS Connections.

Designing XAI JMS Queues

If your business uses JMS Queues to send and receive messages, then you need to add an entry on the [XAI JMS Queue](#) page, defining the JNDI server and Queue Name.

Designing XAI JMS Topics

If your business uses JMS Topics to send and receive messages, then you need to add an entry on the XAI JMS Topic page, defining the JNDI server and Topic Name.

Designing XAI Formats

The Formats section of the registry is used to define data formats. Data formats can be used in schema definitions to specify data transformations. To determine what data formats you need to define for your XAI environment, you must review the expected format of data that you will be exchanging and determine whether or not data transformation is required.

The following sections describe the four different types of formats and some guidelines in their use.

Date Formats

Date formats may be specified using any valid Java format supported by the `java.text.SimpleDateFormat` class.

To specify the time format use a time pattern string. For patterns, all ASCII letters are reserved. The following usage is defined:

Symbol	Meaning	Presentation	Example
G	era designator	Text	AD
y	year	Number	1996
M	month in year	Text & Number	July & 07
d	day in month	Number	10
h	hour in am/pm (1–12)	Number	12

H	hour in day (0~23)	Number	0
m	minute in hour	Number	30
s	second in minute	Number	55
S	millisecond	Number	978
E	day in week	Text	Tuesday
D	day in year	Number	189
F	day of week in month	Number	2 (2 nd Wed in July)
w	week in year	Number	27
W	week in month	Number	2
a	am/pm marker	Text	PM
k	hour in day (1~24)	Number	24
K	hour in am/pm (0~11)	Number	0
z	time zone	Text	Pacific Standard Time
'	escape for text	Delimiter	
"	single quote	Literal	'

Currency Formats

Currency formats are used to specify formatting for elements representing currencies. They may include the following:

Symbol	Meaning
#	number place holder
,	thousands separator
.	decimal point
\$	currency sign

For example to define the currency format for US dollar, indicate: \$#,#.00

Phone Formats

Phone formats can be used to specify formats for telephone numbers. The supported format specification is limited to the following format characters:

Symbol	Meaning
0	number place holder
\0	0

Any other character appearing in the formatting expression is a placeholder for that character. To specify the '0' character, use '\0'.

Phone Format Example: (000) 000-0000

Text Formats

Text formats are used to specify formats for character string attributes. The following expressions are supported:

Symbol	Meaning
\cUpperCase	Translate the string to upper case.
\cLowerCase	Translate the string to lower case.
\cProperCase	Translate the string to proper case. The first character of every word is translated to uppercase. The remaining characters are translated to lowercase.

Fastpath: Refer to [XAI Format](#) to define your XAI Formats.

Designing XAI Adapters

The product provides a set of adapters to process your XML requests. The adapters point to a specific Java class that renders a service. If you find that you need to use a protocol, which is not supported by the adapters provided, you will need to add a new XAI Class (which points to a Java class) and a new XAI Adapter. It is recommended that your implementers contact customer support. The following adapter classes are provided.

- **BASEADA:** This is the core adapter class that provides access to any published system service. This adapter accesses system objects through the page server. Services with this adapter need to indicate the object (application service), which should be invoked.
- **BUSINESSADA:** This is the core adapter class that provides access to schema-based objects. This adapter accesses [business objects](#), [business services](#) and [service scripts](#) through their schema API. Services with this adapter need to indicate the schema of the object, which should be invoked. When communicating to these objects, it is not necessary to create XAI schemas for the schemas associated with the objects. XAI is able to directly communicate with these objects using their existing schema definitions. As a result, there is no need to use the XAI schema editor when defining XAI Inbound Services for this new adapter.
- **STGUPADA:** This staging upload adapter class is used when an extra step is required prior to using a service with the core adapter. For example, perhaps you need to read a file, which is not in XML format, and convert it to an XML format recognized by the system. Services with this type of adapter do not need to indicate an application service but must indicate information about the file to be converted. Refer to [XAI Staging Control](#) for more information.
- **LDAPIMPRTADA:** This is a special adapter that is used when importing Lightweight Directory Access Protocol (LDAP) objects into the system. If your organization uses LDAP, you can import your existing LDAP users and groups into your product, so that you do not need to define them twice. The adaptor can process search, validate and import XML requests. Refer to [Importing Users and Groups](#) for more information.
- **XAICMNDADA:** This is an internal adapter. It is used to send commands to the XAI Server.
- **SIEBELADA:** This adapter acts as a gateway between Siebel Virtual Business Components (VBC) and the system XAI services. The adapter understands the Siebel XML Gateway Message format, translates the message into an XAI message, executes the request and translates the result into a message format expected by the Siebel XML Gateway.

Note: Due to the limitations of Siebel VBC, this adapter is more suited for accessing simple List and Search services, or the main row of a Page maintenance service. It cannot be used to access nested components in a system business service.

Note: The Siebel VBC structure must exactly match the elements in the corresponding XAI service. For more information about using an XAI service as a Siebel VBC, refer to [Creating a Siebel VBC Definition based on a schema](#).

Designing XAI Executors

The executor is responsible for executing messages received through a message receiver. The product provides an executor, which uses the XAI server; however the architecture allows for implementing additional execution classes. If you require a different executor and therefore a different execution class, it is recommended that your implementers contact customer support.

Fastpath: Refer to [XAI Executor](#) for more information.

Designing XAI Senders

XAI senders are responsible for define outgoing message destinations and for " *responding*" to the XAI executer.

- For NDS messages, the sender to use is defined on the *XAI route type* for the notification download profile.
- For outbound messages, the sender to use is defined on the *external system*/ outbound message type collection.
- For responding to the XAI executer, the sender to use is defined on the *receiver*.

For each sender, you must reference an appropriate XAI class. The information in this section describes the sender classes that are provided with the system.

You must create senders to "respond" to the various staging table receivers in the system.

- Create a sender to be used for "responses" to messages processed by the staging control receiver. You should create one sender, which points to the XAI Class **UPLDERRHANDLR**. Refer to *Staging Control Sender* for more information about this sender.
- Create a sender to be used for "responses" to messages processed by the upload staging receiver. You should create one sender, which points to the XAI Class **STGSENDER**. Refer to *Staging Upload Sender* for more information about this sender.
- Create a sender to be used for messages processed by the download staging receiver. You should create one sender, which points to the XAI Class **DWNSTGSNDR**. (DWNSTGSNDR is not available in all products.)
- Create a sender to be used for messages processed by the outbound message receiver. You should create one sender, which points to the XAI Class **OUTMSGSNDR**. Refer to *Outbound Message Sender* for more information about this sender.

Note: Sample Data for Initial Install. When first installing the system, sample XAI senders for each of the above "response" conditions are provided. Your implementation may use these records or remove them and create your own.

Next, design the senders for "responses" to other receivers, for example the JMS queue receiver or JMS topic receiver. The system provides XAI classes to use for these senders. Use the class **JMSENDER** for a JMS queue sender and **TPCSNDR** for a JMS topic sender.

Finally, review all your *outgoing messages* and determine the mechanism for communicating with the target system for each message.

- For all senders that are used for *real time messages*, define a context entry with a context type of **Response Time Out** to define the amount of time the system should wait for a real time response.

The topics below describe configuration required for senders that route a message via an HTTP sender, a flat file sender or an email sender.

Adding an HTTP Sender

An HTTP sender is one that sends messages to an HTTP server using the HTTP protocol. HTTP senders should reference an XAI Class of **HTTPSNDR**.

Various parameters are required to establish a session with the target HTTP server. You specify these parameters by defining a collection of context values for the sender. A set of context types related to HTTP variables is provided with the product. The following section describes the context types and where appropriate, indicates valid values.

Before defining the HTTP sender, you need to find out how the HTTP server on the other side expects to receive the request, and in particular, to answer the following questions:

- What is the address of the HTTP server?
- Is the HTTP server using a POST or GET HTTP method?

- If the server is using POST, how are message contents passed? Does it use an HTTP FORM or does it pass the data in the body of an XML message?

Context Type	Description	Values
HTTP URL1 - URL9	<p>Used to construct the URL of the target HTTP server.</p> <p>Since the URL may be long and complex, you can break it into smaller parts, each defined by a separate context record. The MPL server builds the full URL by concatenating the values in URL1 through URL9.</p> <p>You may use substitution variables when entering values for URL parts.</p>	
HTTP Method	The HTTP method used to send the message.	POST or GET
HTTP Proxy Host	If connecting to the remote system requires using an HTTP Proxy, then this context field can be used to configure the HTTP Proxy Host. If the Proxy Host is set, the Sender class must use the value specified to connect to the remote system via a proxy.	
HTTP Proxy Port	If connecting to the remote system requires using an HTTP Proxy, then this context field can be used to configure the HTTP Proxy Port. If the Proxy Port is set, the Sender class must use the value specified to connect to the remote system via a proxy. If the HTTP Proxy Host is not set, HTTP Proxy Port is ignored and the connection will be made directly to the remote system.	
HTTP Transport Method	Specifies the type of the message. You can either send the message or send and wait for a response.	Send or sendReceive
HTTP Form Data	<p>Used when the message is in the format of an HTML Form (<code>Content-Type: application/x-www-form-urlencoded</code>).</p> <p>This context specifies the form parameters (data) that should be passed in the HTTP message. Since a form may have multiple parameters, you should add a context record for each form parameter.</p> <p>The value of a form parameter takes the format of <code>x=y</code> where <code>x</code> is the form parameter name and <code>y</code> is its value.</p> <p>If <code>y</code> contains the string <code>@XMLMSG@</code> (case sensitive) then this string is replaced by the content of the service response XML message.</p> <p>If a context record of this type is defined for a sender, the sender uses the HTML Form message format to send the message even if <code>@XMLMSG@</code> is not specified in one of the context records.</p> <p>If a context record of this type is not defined for a sender, then the XML is sent with <code>Content-Type: text/plain</code>. When using POST it is put in the HTTP message body.</p> <p>Always required when using the GET method. If you are using the GET method and do not specify a Form Data context record, no message is transferred to the HTTP server.</p> <p>The MPL server builds <code>formData</code> by concatenating the individual parts.</p>	

You may use substitution variables when entering values for Form Data.

HTTP Login User	The HTTP server may require authentication. Add a context record of this type to specify the login user to use.
HTTP Login Password	The HTTP server may require authentication. Add a context record of this type to specify the login password to use.
HTTP Header	Sometimes the HTTP server on the other side may require the addition of HTTP headers to the message. For each HTTP header that has to be specified you should add a context record with a value having the following format <code>x:y</code> where <code>x</code> is the header name and <code>y</code> is the value for the header
Character Encoding	Indicates if the message should be encoded. UTF-8 or UTF-16 The sender will add to the HTTP's content type header the string <code>; charset=x</code> where <code>x</code> is the value of this context and when sending the message it will encode the data in that encoding.

Example 1

This is an example of an HTTP sender definition that connects to an external HTTP Inbound Server. The HTTP server on the other side expects a POST with some form parameters and the XML message specified in the SWEEExtData form parameter. Note that @XMLMSG@ is used for the SWEEExtData form parameter.

Context Type	Context Value
HTTP URL1	http://<Web Server>/esales/start.swe
HTTP Method	POST
HTTP Transport Method	sendReceive
HTTP Form Data	SWEEExtSource=<Source Name>
HTTP Form Data	SWEEExtCmd=<Execute>
HTTP Form Data	SWEEExtData=@XMLMSG@
HTTP Form Data	UserName=SADMIN
HTTP Form Data	Password=SADMIN

Example 2

This is an example of an HTTP sender definition that connects to a third party web service.

Context Type	Context Value
HTTP Header	Content-Type:text/xml
HTTP Header	SOAPAction:http://mwm.splwg.com/WebServices/Submit
HTTP Method	POST
HTTP Transport Method	sendReceive
HTTP URL1	http://10.10.17.138/SPLMWMSservice
HTTP URL2	/SPLMWMSservice.asmx

Adding a Flat File Sender

This sender is used when you want XML messages to be written to a flat file. For example, it can be used in the notification download process to write a response message to a flat file. Flat file senders should reference an XAI Class of **FLATFILESNDR**. In addition, the following context records should be defined for senders of this type.

Context Type	Description	Values
--------------	-------------	--------

Flat file output directory	Directory in the file system where to write the file	
Flat file filename pattern	The name of the output file. The file name may be a literal constant, or generated dynamically. To create a dynamic filename use <file name> \$\$ID, where \$\$ID is replaced at run time by the ID of the NDS message that triggered the response message. If no file name is defined for the sender, the XAI server generates a file name with the following format 'XAI\$\$ID.xai'.	
Append data to file	This parameter controls whether the content of the response message is appended to an existing file, or a new file is created (possibly replacing an existing one).	YES or NO
Character Encoding	Indicates if the message should be sent with character encoding. The sender will write the content of the file with encoding specified in the context value. If no value is specified, the sender uses the default Java system encoding, which is determined according to the operating system locale.	UTF-8 or UTF-16

Adding an Email Sender

The email sender allows for XML messages to be sent as email messages through an SMTP server. It can be used in notification download processes to send a response as an email message. The email sender supports standard email functionality such as "CCs" and attachments.

The content of the email message is controlled by the XSL script defined in the *XAI route type* of the NDS message. The XSL script has access to all context records of the NDS message as well as the input XAI message that was created by processing the NDS.

An email sender must point to the XAI Class **EMAILSENDER**. In addition, the following context records should be defined for senders of this type.

Context Type	Description	Values
SMTP Host name	The SMTP server host name.	
SMTP Username	The user ID used to access the SMTP server.	
SMTP Password	The password used to access the SMTP server.	

Fastpath: Refer to [How an Email Message is Constructed](#) for more information.

Designing XAI Groups

XAI groups are used by the system to process an XML file containing multiple messages to be uploaded into the system. One or more groups may be defined for an *XML file receiver*.

Fastpath: Refer to [XML Message File](#) for more information about how groups are used to process an XML file.

When setting up your XAI environment, identify the interfaces that require uploading an XML file containing multiple XML messages into the system through XAI.

First you need to categorize the XML files that you may receive. Define an XAI Group for each logical categorization. For example, you may want to define a separate XAI Group for each third party who may send you a collection of XML messages. Or, if all third party service providers send direct access messages in a standard format, you may want to define a single XAI Group for direct access messages.

For each group, you need to identify the root elements that indicate when a new message is starting. This collection of unique root elements for a group is called the attachments.

For each group, you must identify every possible message that may be sent. For every message, define an XAI Rule. The rule indicates the XSL transformation script to be executed along with the XPath and XPath value that the system uses to identify each message.

Fastpath: Refer to *XAI Group* to define groups, their attachments and their rules.

Designing XAI Receivers

Receivers define small pieces of code that wait for requests to be received through various sources. Each receiver references an XAI class where the small piece of code is defined. The following receiver classes are provided:

- **STGRCVR** The receiver that references this class polls the XAI upload staging table for new inbound requests.
- **STGCTLR**: The receiver that references this class polls the XAI staging control table for new upload processes.
- **DWNSTGRCVR** : The receiver that references this class polls the notification download staging table (NDS) for new messages. (Not available in all products).
- **OUTMSGRCVR** : The receiver that references this class polls the outbound message table for new messages.
- **JMSRCVR**: Receivers that reference this class receive requests through a message queue that supports the JMS Queue interface, such as IBM MQSeries.
- **TPCRCVR**: Receivers that reference this class receive requests through a publish/subscribe model, such as TIBCO, or any system supporting the JMS Topic interface.
- **FILESCANRCVR**: Receivers that reference this class poll a given directory for files with a given file name pattern.
- **XMLFILERCVR**: Receivers that reference this class poll a given directory for XML files with a given file name pattern.

Multiple receivers may be defined for these receiver classes. For example, the XML file receiver defines the scan directory. If you have multiple directories that contain files to be uploaded, define a receiver for each directory.

All types of receivers reference an XAI Class and XAI Executer. If you require a new XAI Class or Executer because you use a protocol that is not currently supported, it is recommended that your implementers contact customer support.

Designing Responses for a Receiver

Once a request has been sent for execution to the XAI server (via the executer), *the response layer* processes the response. For some receivers, a response may not be applicable. For example, a file scan receiver reads flat files in a given directory and posts records to the XAI staging control table. Responses are not applicable for this type of receiver.

The response may be conditional on the outcome of the request and may be sent to more than one destination (*sender*). To design your receiver responses, determine the conditions under which a response should be sent for each request processed by each receiver:

- Never send a response
- Send a response if the request was successful
- Send a response if the request was unsuccessful due to a system error
- Send a response if the request was unsuccessful due to an application error

Once you determine when to send a response, you must determine where to send the response. Responses for different conditions may be sent to different XAI Senders or to the same XAI Sender.

Designing Receivers that Poll Staging Tables

The following receivers are needed to poll the various system staging tables.

- Create a *staging upload receiver* that references the XAI Class **STGRCVR**. For responses, **All Events** should reference the *staging upload sender*.
- Create a *staging control receiver* that references the XAI Class **STGCTLRCVR**. For responses, **All Events** should reference the *staging control sender*.
- If your implementation uses the NDS message method of communicating outgoing messages, create a staging download receiver that references the XAI Class **DWNSTGRCVR**. For responses, **All Events** should reference the download staging sender. NDS messaging is not supported in all products.
- If your implementation uses the *outbound message* method of communicating outgoing messages, create an *outbound message receiver* that references the XAI Class **OUTMSGRCVR**. For responses, **All Events** should reference the *outbound message sender*.

For all the above receivers, if you need to access multiple environments, simply create receivers for each JDBC connection. Note that you should not add more than one of each of the above receivers pointing to the same JDBC connection. To improve performance for a single JDBC connection you may *configure multiple MPL servers*.

Note: Sample Data for Initial Install. When first installing the system, records for each of the above receivers are provided. Your implementation may use these records or remove them and create your own.

Designing a JMS Queue Receiver

If you need to receive messages through a JMS compatible queue, you need to define a JMS Queue receiver. When designing a JMS Queue receiver you first need to design a *JMS Connection* and a *JMS Queue*.

If you would like to post *responses* back to the JMS queue, you may create an *XAI sender* to send the response to the JMS queue.

Designing a JMS Topic Receiver

If you need to receive messages through a JMS Topic using the publish/subscribe model, you need to define a JMS Topic receiver, which receives messages published under a specific topic. When designing a JMS Topic receiver you first need to design a *JMS Connection* and a *JMS Topic*.

If you would like to post *responses* through a JMS Topic using the publish/subscribe model, you may create an *XAI sender* to send the response to the JMS topic.

Designing a File Scan Receiver

The file scan receiver constantly looks in a given directory for files with a given pattern. When it finds a matching file, it creates a record in the *staging control* table to upload the contents of the file into the *upload staging* table.

When setting up your XAI environment, identify the interfaces that require uploading a file from a directory into the system through XAI. For each unique file, define a file scan receiver. For each receiver record, indicate the Scan Directory, where new files will be placed, the Scan File, which is the naming pattern to look for and the XAI Inbound Service to use for mapping the data into a system service.

In addition, if you want to specify a character encoding, the following Context record should be defined.

Context Type	Description	Values
--------------	-------------	--------

Designing an XML File Receiver

The XML file receiver constantly looks in a given directory for XML files with a given pattern. When it finds a matching file, it goes through steps to identify each separate message in the file, determine the appropriate XSL transformation and create a record in the staging upload table.

Fastpath: Refer to [XML Message File](#) for more information.

When setting up your XAI environment, identify the interfaces, which require uploading an XML file containing multiple XML messages into the system through XAI. For each unique file, define an XML file receiver. For each receiver record, indicate the Scan Directory, where new files will be placed, the Scan File, which is the naming pattern to look for and the collection of XAI groups. XAI groups are used by the system to identify each separate message in the file and to determine the appropriate XSL transformation for each message.

Fastpath: Refer to [Designing XAI Groups](#) for more information.

How To Design Outgoing Messages

The following sections walk you through configuring your system to communicate messages to external systems based on how your implementation communicates.

Configuring the System for Outbound Messages

The following sections describe the setup required when using [outbound messages](#) to communicate with an external system. The configuration walks you through the steps to configure a single external system and all its messages.

Define the Outbound Message Type

For each outbound message that must be sent to an external system, create a [business object](#) for the outbound message maintenance object. Using the business object's schema definition, your implementation defines the fields that make up the XML source field. These are the fields that are the basis for the XML message. XSL transformations may be applied to this XML source to produce the XML message.

Once you have your business object and schema, define an [outbound message type](#) for each unique outbound message.

Define the XAI Sender

When messages are routed to an external system via XAI, each message must be associated with an [XAI Sender](#), which tells the system how to send the message.

Define the External System and Configure the Messages

Define an [external system](#) and configure the valid outgoing messages and their method of communication (**XAI, Batch, or Real Time**). Refer to [Batch Message Processing](#) for more information. Refer to [Real Time Messages](#) for more information.

Configuring the System for NDS Messages

Refer to the documentation for your product to find out if NDS messaging is supported.

Schema Editor

The Schema Editor is a Graphical User Interface (GUI) tool to create XML schemas. The tool provides wizards to generate schemas from various sources.

Opening the Schema Editor

After launching the schema editor, you are asked to connect to a database. On the Connect dialog:

- Select an ODBC data source pointing to the desired database.
- Enter the data source, user ID, password and database owner required to log on to that database.
- Click **Connect**.

After connecting, the schema editor appears.

Use the File/Open dialogue to select a schema from the schema directory. Refer to [The Options Menu](#) for information about setting the default schema directory.

Note: When opening a schema, the schema editor validates the schema and any errors are displayed. Refer to [Validating a schema](#) for more information.

Schema Editor Window

The schema editor allows you to modify individual elements and attributes of a given schema.

Description of Page

Refer to [System Wide Functions for Schema Editor](#) for information about the various menu options available for the schema editor.

Service Name Enter the name of the service to be created in the service name text box. This is the name of the first element under the Body element in the XML document.

Caution: Important! When adding new schemas, carefully consider the naming convention for the Service Name. Refer to [System Data Naming Convention](#) for more information.

Adapter The adapter used to process services using this schema.

Internal Service Name If the schema is for an adapter that should invoke a system service, this is the internal name of the service.

Transaction Type Select the transaction type performed by the service. The available values are **Read, Add, Change, Update, Delete, List** and **Search**.

Note: The difference between Change and Update is that for Change, all field values must be passed in with the request. Field values that are not passed in to the request are set to null. For Update, you need only pass the primary key field values and the values of the fields to be updated. All other fields retain their existing values.

Left Panel

The left panel of the schema editor displays a tree view of the hierarchical elements in the schema. The (+) expands a node, the (-) collapses a node.

Right Panel

The following attributes appear on the right panel of the Schema Editor. Some fields cannot be modified in the schema editor. The field description indicates when the field is protected.

Tag Name The XML element tag name. This field is protected, but you may modify this attribute to give the element a self-explanatory name by right-clicking on the element name in the left tree-view.

MetaInfo Name Maps the element to a fully qualified field name in the service, for example PER_ID. This field is protected.

Internal Type This property is populated automatically when you generate the schema from your product. The values further define elements and attributes. The values are **page**, **pageBody**, **list**, **listHeader**, **listBody**, **searchHeader**, **codeTableDesc**, **Private**. The values of **codeTableDesc** and **Private** are used to define special types of attributes. Refer to [How to Create Code Description Attribute](#) and [How to Create a Private Attribute](#) for more information.

Private attribute A field that does not exist on the server side, but one that you still want to have in the schema. Refer to [How to Create a Private Attribute](#) for more information.

Description A description of this field.

Content The element type. This field is only available for elements. Possible values are **eltOnly**- element may contain only other elements and no text, **TextOnly**- element may only contain text.

Search Type Services, which perform a Search, may allow searching based on different criteria. The values are taken from the system meta information when the schema is generated. The possible values are **Main**, **Alternate1**, **Alternate2**, **Alternate3**, **Alternate4**, **Alternate5** and **Alternate6**.

Note: You would not typically modify this value because it corresponds to a value in the meta information. However, the value is modifiable to accommodate the rare case in which a service may change in a new release. In this scenario, you may prefer to update the schema manually rather than regenerate a new schema for the new version.

Is Part of Primary Key Used to indicate to the XAI server whether or not this field makes up part of the primary key of the record. The values are taken from the metadata information when the schema is generated. Value may be **true** or **false**.

Note: Typically you would not modify this value because it corresponds to a value in the meta data information. However, the value is modifiable to accommodate the rare case where a service may change in a new release. In this scenario, you may prefer to update the schema manually rather than regenerate a new schema for the new version.

Min Occurs This field is available for elements only and is used for repeating elements. It defines the minimum number of occurrences for an element. Value may be 0 or 1.

Schema Max Occurs This field is available for elements only and is used for repeating elements. It defines the maximum number of occurrences for an element. Value may be 0, 1 or *.

Limit Number of occurrences This field is available for elements only and is used for repeating elements. If the **Schema Max Occurs** field has been set to '*', define the number of max occurrences here.

XML Data Type The data type for the attribute. Possible values are **number**, **string**, **decimal**, **date**, **dateTime**, and **boolean**.

Server Data Type Indicates the data type of this attribute on the server. This field is protected.

Server Format The format expected by the service. At runtime, XAI converts the Tag format to the Service Format before executing the request. Formats are defined in [XAI Format](#).

Tag Format The format used to format an element/attribute in the schemas. Formats are defined in [XAI Format](#).

Min Length Use this property to define the minimum length of the attribute, if applicable.

Max Length Use this property to define the maximum length of the attribute, if applicable.

Precision This is used for decimal attributes to define the maximum number of digits.

Scale This field is used for decimal attributes to define the number of digits at the right of the decimal point.

Required A value of **Y** indicates that the element must appear in XML document. A value of **N** indicates that the element is optional.

Default value Default value to be used for Request schema, when the element is not supplied as part of the XML request document.

Fixed Value Fixed value to be used for Request schema. This value is used regardless of the value supplied in the request document.

Code Table Field This property is used for attributes that are descriptions of a code table, where the description is not automatically returned by the system service. Use this property to indicate the code whose description should be retrieved by the XAI server. Refer to [How to Create Code Description Attribute](#) for more information.

Code Table Program This property is used for attributes that are descriptions of a code table, where the description is not automatically returned by the system service. Use this field to indicate the program that XAI should call to access the description for the **Code Table Field**. Refer to [How to Create Code Description Attribute](#) for more information.

Creating a Schema

Usually you do not create schemas from scratch; rather you use Schema Creation Wizards to import existing data structure definitions from a variety of data sources:

- System services
- Comma Delimited Files (CSV)
- Database Extract
- Any XML document
- Siebel Virtual Business Components
- Siebel Integration Objects

Fastpath: Refer to [How to Create XML Schemas](#) for detail about each creation wizard.

Once a schema is created based on the existing data structure, it is displayed in a TreeView on the left panel. Once the imported schema has been edited, it serves as the basis for creating the request and response schemas. When imported, the schema exposes all fields defined in the service. You may want to remove some attributes/elements from the request or response schema.

Note: Although the main purpose of the editing process in the creation of the request and response schemas is the elimination of elements, which makes the schema shorter and more understandable, it is not required for processing purposes. Therefore, if you don't mind that you have not used elements in your schemas, you could stay with one schema, which serves as both the request and response schema.

1. Save the Schema as a Request schema with an appropriate name, for example `PersonInfoRequestSchema.xml`
2. To create the Response schema, which is identical to the request schema, use the Save As Response menu option. This renames the top element of the schema to `ServiceNameResponse`, for example `PersonInfoResponse` and save the schema under a different name i.e. `PersonInfoResponseSchema.xml`. Note that if the request and response schemas are identical then one schema may be used for both and there is no need to create separate schemas.
3. Read in the Request Schema (File/Open) and modify its structure. Depending on the service type, you'll have to modify the contents of the Request Schema. This is usually required when the service is an "Info" service, which requires very few input elements. In such cases you'll delete most of the elements on the schema and only leave the necessary elements required to invoke the service. For example: in the `PersonInfo` request, you only need the `PersonId` and the `Company` elements in the request schema.
4. Read in the Response Schema (File/Open) and Modify its structure. Depending on the service type, you'll want to modify the contents of the Response Schema. This is usually required when the service is an "Add" or "Delete" service, which returns very few input elements. In such cases you'll delete most of the elements on the response schema and only leaves the necessary elements required by the requester of the service.

Adding an Element/Attribute

Usually, you won't have to add element or attributes to a schema. However if the schema already exists and you want to add an element/attribute, you can follow this procedure. Be aware that any element/attribute added here must also exist on the xml metainfo.

- Select the element's node on the TreeView.
- Right click on it and select the 'Add Element' or 'Add Attribute' option in the pop up menu
- Enter the element/attribute name in the prompt dialog box and click OK.

Removing Elements/Attributes

When generating a schema using one of the wizards, the generated schema may contain information that you do not want to publish as part of the service, or is not required for a particular service. You can remove elements/attributes from the schema, and though these elements/attributes may still exist on the service they are not seen by the XAI service using this schema. To remove an element or attribute:

- Select the node to be removed.
- Right click and select "Delete" from the popup menu.

Renaming an Element

To rename an element:

- Select the element's node on the TreeView.
- Right click it and select the Rename option in the pop up menu
- Enter the new name in the prompt dialog box and click OK.

Note: The information in this table is cached by the XAI server and by the MPL server. Changes to values in this table do not affect the runtime copy of these servers. Refer to [XAI Command](#) for information about refreshing a schema.

Validating a Schema

Although a schema is validated against the metainfo XML file when it is read into the editor or before it is saved, you can perform the validation at any time while the schema is being edited. To validate a schema, click on the toolbar "Validate" button . If the schema fails to validate the schema errors dialog is displayed.

Schema Validation Errors

When the editor fails to validate a schema against the xml metainfo file, it pops up a dialog that lists the errors found in the schema definition. These errors may be of two types:

- An element or attribute in the schema could not be found in the xml metainfo file. You can click **Remove** to remove the element from the schema.
- The data type of an attribute does not match the one defined in the metainfo file. You can click **Correct**, and the editor fixes the data type so it does match.

The **Correct All** button can be used to correct all fields that have data types that do not match the one in the XML metainfo file.

Note: Correcting errors does not save the schema definition into a file. You have to save it manually.

If you **Exit** without correcting the errors, the schema displays with the mismatch information highlighted in red.

Registering a Service

Before a service can be used it must be defined in the [XAI Inbound Service](#) table in the XAI registry. A service can be registered in the XAI registry directly from the schema editor. Go to the menu item 'Register Service' in the 'Schemas' menu. The Register service UI page appears. Fill in the required fields.

Note: The registry entry for the service can be later modified using the [XAI Inbound Service](#) page.

Testing a Schema

The schema editor provides a testing option. Refer to [Testing a Schema Using the Schema Editor](#) for more information.

Note: Testing in your product. You may also test your schemas and your services using either [XAI Submission](#) or [XAI Dynamic Submission](#).

System Wide Functions for Schema Editor

Because the schema editor is in an application outside of the standard products, this section introduces some general functions related to the application.

Application Standards

- The schema editor is a Multiple Document Interface (MDI) windows application. It may contain multiple active windows. You may jump from one window to the other using the Window menu option.
- The Editor window is always active. Closing the schema editor window quits the application.
- In the Editor window, a splitter bar is available to resize the schema tree view horizontally.
- Actions may be performed using menu items or by clicking on toolbar buttons.
- All messages are displayed on a status bar at the bottom of the screen. Some may also be displayed using message boxes.

The File Menu

Use the File menu to open existing schemas and to save a schema to a file.

Connect

Connects to the database.

Open - Loading an existing schema into the editor

You can read an existing schema into the editor.

1. Click on the Open toolbar button or select the File/Open menu option.
2. A file selection dialog is shown. Select the schema file name.
3. The editor first validates the schema against the xml metainfo file. If it fails to validate it shows the [Schema Validation Errors](#) dialog.

Save

Save the current schema to a file. Using the current file name.

To save a Schema, click on the Save tool bar button, or select the File/Save menu option. When you save a schema, the editor first attempts to validate the schema. If it fails to validate it against the XML Metainfo file, you are prompted to save it with inconsistency errors or to return to the editor.

Save As

Save the current schema to a file. Use a different file name.

Save As Response

Save a copy of the current schema to a file as a response schema. Use a different file name.

The View Menu

Use the view menu to perform actions on the Tree View nodes or to view errors. The following menu options are available:

Expand All

Expand all nodes in the Tree View

Collapse All

Collapse all nodes in the Tree View

Expand Branch

Expand the selected node and all the node's children

Search (Ctrl+F)

Find a node with a node name containing a given string

Search Again (F3)

Find the next node with containing the search string

View Schema Errors

Display the Schema Validation Errors dialog.

Web Browser

Display the current schema definition on a web browser page

The Schemas Menu

Use the Schemas menu to create, test, validate and register schemas.

- To *create schemas* from various sources use the **Create menu**.
- To *validate a schema* select the **Validate** option (Ctrl+V).
- To create a sample instance and *test the schema*, select the **Test** option (Ctrl+T).
- To create an entry in the service registry for a service represented by the current schema, select the **Register Service** option (Ctrl+R). Refer to *Registering a Service* for more information.

The Export Menu

Siebel Integration Object

Use this option when you are ready to export a *Siebel Integration Object definition created based on an XAI schema*.

Siebel VBC

Use this option when you are ready to export a *Siebel VBC definition created based on a schema*.

The Options Menu

Always Save As W3C

Turn on this option to save schemas in W3C format by default instead of XDR format.

Always Save As DTD

Turn on this option to save schemas in DTD format by default instead of XDR format.

Preferences

The following options may be set on the preferences dialog (Select Options and then Preferences):

- The Default Date Time Format - used for schema date fields
- The default Schema Directory - used to read/save schemas
- The default Metainfo Directory - used to create/validate schemas
- The XAI Servlet URL - used when executing requests from the test schema dialog.
- The Default Account Id - used when generating sample instances of a schema
- Language - used to access language specific data

The Tools Menu

Schemas tools can be invoked from the **Schema Editor Tools** menu.

Converting Schemas to a W3C compatible schema

Schemas generated in the Microsoft BizTalk-compatible format (XDR format) may be saved in a format compatible with the *October 2000, W3C XML* schema standard. To save a schema in a W3C format:

- Select **Convert to W3C** from the **Tools** menu. The **Convert to W3C** dialog box appears.
- Select the schema(s) to be converted. Multiple schemas may be converted in a single step.
- The name of the W3C schema is the same name as the schema but with an ".xsd" file extension, and is saved to the same directory as the original schema.
- Click **Convert**.

Converting Schemas to a DTD

Schemas generated in the Microsoft BizTalk-compatible format (XDR format) may be saved as a DTD.

- Select the **Convert to DTD** option from the **Tools** menu. The **convert DTD** dialog box appears.
- Select the schema(s) to be converted. Note that multiple schemas may be converted in a single step.
- The name of the W3C schema is the same name as the schema but with a ".dtd" file extension, and is saved to the same directory as the original schema.
- Click **Convert**.

Validating multiple schemas

The schema validation tool can be used to validate the correctness of an XAI schema when compared to the metainfo xml definition used to generate the schema. For each validated schema, the validation tool scans the list of elements/attributes and compares them with those defined in the XML metainfo file. Select **Validate Schemas** in the **Tools** menu.

- The **Validate Schema** dialog box appears.
- The left list box is used to select the directory where the schemas to be validated are stored. By default this is the **Schema Directory** as defined in the preferences.

- On the right, the list of schemas is displayed on a grid.
- Multiple schemas may be validated in a single step.
- To select a schema click on the left button (the first column in the row).
- To select multiple schemas, hold the `Ctrl` key and select the required schemas.
- Click `Validate Schemas`.
- The schema grid is updated. When an attribute defined in the schema is missing from the metainfo file or when the properties of the element do not match defined in the metainfo, a button is displayed at the right of the schema name. Clicking on the `edit` button loads the schema into the editor and displays the *Schema Validation Errors* dialog for that schema. You can correct the schema and save it.

Setting Up Your XAI Environment

This section describes the control tables available to administer your XAI environment.

XAI Class

The XAI Classes are references to actual Java classes. The XAI Class defines the Java class used to implement Receivers, Senders, Adapters and Executors. This information is provided with the system and does not need to be modified for a specific installation.

To view an XAI class, open **Admin Menu, XAI Class**.

Description of Page

The **XAI Class** and **Description** are unique identifiers of the XAI Class. The **Class Definition** indicates the Java class, implementing the adapter, receiver, sender or executor.

Owner indicates if this XAI class is owned by the base package or by your implementation (**Customer Modification**). The system sets the owner to **Customer Modification** when you add an XAI class. This information is display-only.

Where Used

Follow this link to open the data dictionary where you can view the tables that reference [CI_XAI_CLASS](#).

XAI Envelope Handler

To view your envelope handlers, open **Admin Menu, XAI Envelope Handler**. This information is provided with the system and does not need to be modified for a specific installation.

Description of Page

Enter a unique **XAI Envelope Handler ID** and **Description**.

Indicate whether the **Envelope Type** is **Default** (no SOAP environment) , **Siebel Integration Message**, **Siebel VBC** or **SOAP Envelope**.

When the envelope type is **SOAP Envelope**, indicate the **Envelope URI**.

Owner indicates if this XAI envelope handler is owned by the base package or by your implementation (**Customer Modification**). The system sets the owner to **Customer Modification** when you add an XAI envelope handler. This information is display-only.

Setting Up Your Registry

The following section describes the control tables that are logically considered part of the XAI Registry.

XAI Option

The XAI Options page defines various system settings used by the XAI and MPL servers. The settings here may be overridden by the *AdHoc Parameters section* of the XAIParameterInfo.xml or MPLParameterInfo.xml. To define options for your environment, open **Admin Menu, XAI Option**.

Description of Page

Define the following information for your XAI and MPL servers.

Option	Description	MPL / XAI Option Name
Automatically Attempt Resend to Unavailable Sender (Y/N)	Set to Y if you wish to enable <i>Automatic Resend</i> . Set to N if you wish to log errors when the system fails to send an outgoing message.	shouldAutoResend
Default Email Sender	This is the default XAI Sender used for sending e-mails when no explicit XAI Sender is specified.	defaultEmailSender
Default Response Character Encoding	Determines the character encoding to be used when a response is sent. For example, you may specify UTF-8 or UTF-16 . If no value is specified then the default is UTF-8 . If no special encoding should be done, then enter the value none .	defaultResponseEncoding
Default User	The default user is used by XAI to access your product when no other user is explicitly specified. Refer to <i>Server Security</i> for more information. Additionally, the Default User is used for MPL transactions where there is no facility to provide a User ID. For example, no facility exists to provide a user id when reading messages from a JMS Queue. In these messaging scenarios, the system will use the Default User for authorization purposes.	defaultUser
Email Attachment File Location	This is the default location of e-mail attachment files. If not specified, the e-mail service provided with the product assumes a full path is provided with each attachment file.	emailAttachmentFileLocation
Email XSL File Location	This is the default location of e-mail XSL files. If not specified, the e-mail service provided with the product assumes a full path is provided to an XSL file as part of an e-mail request.	emailXSLFileLocation
JDBC Connection Pool Max size	The MPL uses a pool of JDBC connections to connect to the database. This option determines the maximum number of JDBC connections that can be opened in the pool. The default value is 100.	JDBCConnPoolMaxSize
Maximum Errors for a Sender	This value is required if you have enabled <i>Automatic Resend</i> . It defines how many errors you receive from a sender when attempting to send an outgoing message before you mark the sender unavailable .	maxSendingErrors
Messages JDBC Connection	Specifies the JDBC connection that XAI uses to read the text for its messages.	messagesJDBCCConnection

Messages Language	The default language to use for the messages.	language
MPL Administrator Port	The port number to be used for receiving MPL operator commands.	adminPort
MPL HTTP Server Authentication Method	This setting, along with the MPL HTTP Server User and Password are used to secure commands received by your MPL (such as those issued via XAI Command) through HTTP. Currently only BASIC authentication is supported.	MPLHTTPAuthMethod
MPL HTTP Server Password	This setting, along with the MPL HTTP Server Authentication Method and User are used to secure commands received by your MPL (such as those issued via XAI Command) through HTTP. The password should be in encrypted form, using the same encryption that is used for the database password. .	MPLHTTPAuthPassword
MPL HTTP Server User	This setting, along with the MPL HTTP Server Authentication Method and Password are used to secure commands received by your MPL (such as those issued via XAI Command) through HTTP.	MPLHTTPAuthUser
MPL Log File	The MPL Log File setting is used to specify the name of the file where MPL log information is to be written. The log contains technical information about the operation of the MPL.	MPLLogFile
MPL Trace File	The MPL Trace File setting is used to specify the name of the file where MPL trace information is to be written.	MPLTraceFile
MPL Trace Type	The MPL Trace Type is used to enable or disable tracing of the MPL. The possible values are FULL - All trace messages are written to the log file and NOLOG - No information is written to the log file.	MPLTraceType
Outbound Message Schema Location	Enter the full path of the virtual directory where valid W3C schemas are stored if your implementation wants to validate outbound message schemas . For example: http://localhost/cisxai/schemas.	xaiOuboundSchemaLoc
Privileged Users	Comma separated list of users that are allowed to specify an effective User or effective User Id via framework custom SOAP Headers.	superUsers
Records MPL Receiver Will Process At a Time	If your implementation has configured multiple MPL servers , indicate the number of records that each MPL receiver should process.	Not currently used
Schema Directory	The full path of the virtual directory where XML schemas are stored. For example: http://localhost/cisxai/schemas. If this option is not specified, the XAI uses the current directory, from where it is being run, to locate schemas.	schemaDir
Schema Validation Flag	Enter Y to turn on schema validation for outbound messages . Enter N to turn this off.	xaiSchemaValidationCheck
Send SOAP Fault as HTTP 500	Enter Y to ensure that a SOAP error is reported as an HTTP 500 "internal server error".	sendErrorAsHttp500
Sender Retry Seconds	This value is required if you have enabled Automatic Resend . It defines how many seconds to wait after marking a sender unavailable before you mark the sender available again (and retry sending messages to it).	senderWaitTime

System Error JDBC Connection	When a request fails to execute due to a system error, the MPL retries its execution several times. The MPL registers the system error in a table and uses this table for the retries. This setting specifies the JDBC connection required to access this table. Only enter a value in this field if it is different from the database environment used to read the XAI registry.	systemErrorTableJDBCConnection
System Error Max Retry	When a request fails to execute due to a system error, the MPL retries its execution several times until a maximum number of retries is reached. This option specifies the maximum number of retries.	systemErrorMaxRetries
System Error Retry Interval	When a request fails to execute due to a system error, the MPL retries its execution several times. This option specifies the number of seconds the MPL server waits between retries.	systemErrorRetryInterval
Thread Pool Initial Size	The MPL uses a thread of pools to enhance performance. The MPL starts with a minimum number of threads and grows/shrinks the pool based on the MPL system load. This option specifies the initial number of threads in the thread pool. The minimum number of threads is 12.	threadPoolInitialSize
Thread Pool Max Size	This option specifies the maximum number of threads in the thread pool.	threadPoolMaxSize
Thread Pool Non Activity Time	This option specifies how long a thread in the pool may be inactive before it is timed out and released from the pool.	poolNoneActivityTime
To Do Type for Inbound JMS Message Errors	To Do type for inbound JMS message errors. The inbound message processor uses this To Do type when creating To Do entries for inbound JMS messages that cannot be successfully processed. The system provides the To Do type F1-INJMS that may be used here.	toDoTypeforInboundJMSMessageErrors
To Do Type for Outbound Message Errors	To Do type for outbound message errors. The outbound message receiver uses this To Do type when creating To Do entries for outbound messages that cannot be successfully processed. The system provides the To Do type F1-OUTMS that may be used here.	outboundErrorToDo
WSDL Service Address Location	Specifies the SOAP address location that XAI uses in creating a WSDL. If no value is present, the XAI's URL is used.	wsdlAddressLocation
XAI Authentication Password	The multi-purpose listener uses this field in combination with the XAI Authentication User when attempting to communicate with the XAI server over HTTP, which is running on a secured servlet and requires authentication.	HTTPBasicAuthPassword
XAI Authentication User	The multi-purpose listener uses this field in combination with the XAI Authentication Password when attempting to communicate with the XAI server over HTTP, which is running on a secured servlet and requires authentication.	HTTPBasicAuthUser
XAI Trace File	The full path name for the file, where the XML messages should be written. For example: c:\inetpub\wwwroot\cisxai\xai.log.	traceFile
XAI Trace Type	Use this option to specify the level of logging. The possible values are FULL - All XML messages are written to the log file and	traceType

NOLOG- No information is written to the log file.

Fastpath: Refer to [Server Trace](#) for more information about tracing.

XSL Directory	The full path of the virtual directory where XSL transformation scripts are located. XSL transformation scripts can be defined for each service. By default, this is the same directory as the schemas directory.	XSLDir
---------------	---	--------

Where Used

Used by the XAI tool to obtain various required settings and locations.

Note: The information in this table is cached by the XAI server and by the MPL server. Changes to values in this table do not affect the runtime copy of these servers. Refer to [How to Refresh the Runtime Copy of the Registry](#) for steps required to ensure that the servers use the most current data.

XAI JNDI Server

To define a new JNDI Server, open **Admin Menu, XAI JNDI Server**.

Description of Page

Enter a unique **XAI JNDI Server** and **Description**.

Indicate the Provider URL, which is the URL of the [JNDI server](#) .

Indicate the **Initial Context Factory**, which is a Java class name used by the [JNDI server](#) provider to create JNDI context objects.

Where Used

Follow this link to open the data dictionary where you can view the tables that reference [CI_XAI_JNDI_SVR](#).

Note: The information in this table is cached by the XAI server and by the MPL server. Changes to values in this table do not affect the runtime copy of these servers. Refer to [How to Refresh the Runtime Copy of the Registry](#) for steps required to ensure that the servers use the most current data.

XAI JDBC Connection

To enter or view an XAI JDBC Connection, open **Admin Menu, XAI JDBC Connection**.

Description of Page

Enter a unique **XAI JDBC Connection** and **Description**.

Use the **Connection Type** to indicate how the JDBC connects to a database. The following connection types are valid:

- **Oracle Defined Connection** indicates the connection is to an Oracle database through a JNDI entry.
- **DB2 Defined Connection** indicates the connection is to a DB2 database through a JNDI entry.
- **JNDI Defined Connection** indicates the connection is using the MQ series classes implementing JMS.
- **Determined by parameter file** indicates that the connection information should be determined by looking at the parameters defined at [Installation](#).

For connection types of **Oracle** or **DB2**, use the **JDBC URL** to indicate URL of the database connection to be initialized at XAI/MPL startup time. Indicate the **Database User** and **Database Password** required for accessing the database. The JDBC connection URL can either be a Type 2 or a Type 4. For example:

- Type 2: jdbc:oracle:oci8:@CD200ODV
- Type 4: jdbc:oracle:thin:@myhost:1521/ CD200ODV

For a connection type of **Determined by parameter file**, indicate the parameter substitutions, which should be accessed from the parameter file for the JDBC URL, database user and database password, for example, @JDBCURL@, @DBUSER@ and @DBENCPASS@.

When the connection type is **JNDI**, indicate the **XAI JNDI Server** and the **JNDI Data Source** name as defined in the JNDI.

Where Used

Follow this link to open the data dictionary where you can view the tables that reference [CI_XAI_JDBC_CON](#).

Note: The information in this table is cached by the XAI server and by the MPL server. Changes to values in this table do not affect the runtime copy of these servers. Refer to [How to Refresh the Runtime Copy of the Registry](#) for steps required to ensure that the servers use the most current data.

XAI JMS Connection

To define a JMS Connection, open **Admin Menu, XAI JMS Connection**.

Description of Page

Enter a unique **XAI JMS Connection** and **Description**.

Indicate the **XAI JNDI Server** to be used. Refer to [XAI JNDI Server](#) for more information.

Use the **JNDI Connection Factory** to indicate the lookup keyword in the JNDI server used to locate the JMS connection.

Where Used

Follow this link to open the data dictionary where you can view the tables that reference [CI_XAI_JMS_CON](#).

Note: The information in this table is cached by the XAI server and by the MPL server. Changes to values in this table do not affect the runtime copy of these servers. Refer to [How to Refresh the Runtime Copy of the Registry](#) for steps required to ensure that the servers use the most current data.

XAI JMS Queue

To define your JMS Queue values, open **Admin Menu, XAI JMS Queue**.

Description of Page

Enter a unique **XAI JMS Queue** and **Description**.

Enter the **Queue Name** as defined in the JNDI server. This is the JNDI lookup name identifying the queue.

Use the **Target Client Flag** to indicate whether or not the target client is **JMS** or **MQ**.

Select the **XAI JNDI Server** where the queue is defined. Refer to [XAI JNDI Server](#) for more information.

Where Used

Follow this link to open the data dictionary where you can view the tables that reference [CI_XAI_JMS_Q](#).

Note: The information in this table is cached by the XAI server and by the MPL server. Changes to values in this table do not affect the runtime copy of these servers. Refer to [How to Refresh the Runtime Copy of the Registry](#) for steps required to ensure that the servers use the most current data.

XAI JMS Topic

To define your JMS Topic values, open **Admin Menu, XAI JMS Topic**.



Figure 5: XAI JMS Topic - Main

Description of Page

Enter a unique **XAI JMS Topic** and **Description**.

Select the **XAI JNDI Server** where the topic is defined. Refer to [XAI JNDI Server](#) for more information.

Enter the **Topic Name** as defined in the JNDI server. This is the JNDI lookup name identifying the topic.

Where Used

Follow this link to open the data dictionary where you can view the tables that reference [CI_XAI_JMS_TPC](#).

Note: The information in this table is cached by the XAI server and by the MPL server. Changes to values in this table do not affect the runtime copy of these servers. Refer to [How to Refresh the Runtime Copy of the Registry](#) for steps required to ensure that the servers use the most current data.

XAI Format

Open **Admin Menu, XAI Format** to define the various formats.

Description of Page

For each new format, specify a unique **XAI Format** name and **Description**.

Indicate whether the Format Type is a **Currency formatting string**, a **Date/Time formatting string**, a **Phone formatting string** or a **Text formatting string**.

Finally, indicate the **Format Expression**, which defines the formatting pattern to be applied.

Owner indicates if this format is owned by the base package or by your implementation (**Customer Modification**). The system sets the owner to **Customer Modification** when you add an XAI format. This information is display-only.

Where Used

Follow this link to open the data dictionary where you can view the tables that reference [CI_XAI_FORMAT](#).

Note: The information in this table is cached by the XAI server and by the MPL server. Changes to values in this table do not affect the runtime copy of these servers. Refer to [How to Refresh the Runtime Copy of the Registry](#) for steps required to ensure that the servers use the most current data.

XAI Adapter

To define a new adapter, open **Admin Menu, XAI Adapter**.

Description of Page

Indicate a unique **Adapter Name** and **Description**.

Indicate the **XAI Class**, which is the name of the Java class, implementing the adapter. The class should be one that is defined for an adapter. The adapter classes provided with the product are **BASEADA**- Core Adapter, **BUSINESSADA**- Business Requests Adapter, **LDAPIMPRTADA**- LDAP Adapter, **SIEBELADA**- Siebel XML Gateway Adapter, **STGUPADA**- Staging Upload Adapter, **XAICMNDADA**- XAI Command Adapter.

Fastpath: Refer to [XAI Class](#) for more information.

The following fields are not applicable for the **BusinessAdapter** adapter.

Use the **XAI JNDI Server** to indicate the name of the WebLogic JNDI server running your product. Refer to [XAI JNDI Server](#) for more information.

Indicate the **Default User** to be passed to your product server when this adapter is executed.

Note: If the XML request is sent over an HTTP connection, which has been authenticated, the authenticated User Id is passed to your product.

The **Default Date** format and the **Default DTTM** (date / time) **Format** specify date and date/time *formats* to use when a schema does not explicitly indicate formats.

Owner indicates if this XAI adapter is owned by the base package or by your implementation (**Customer Modification**). The system sets the owner to **Customer Modification** when you add an XAI adapter. This information is display-only.

Where Used

Follow this link to open the data dictionary where you can view the tables that reference [CI_XAI_ADAPTER](#).

Note: The information in this table is cached by the XAI server and by the MPL server. Changes to values in this table do not affect the runtime copy of these servers. Refer to [How to Refresh the Runtime Copy of the Registry](#) for steps required to ensure that the servers use the most current data.

XAI Executer

To define a new Executer, open **Admin Menu, XAI Executer**.

Description of Page

Enter a unique **Executer ID** and **Description**.

Indicate the **XAI Class** for this executer. The class should be one that is defined for an executer. The executer class provided with the product is **XAIURLEXEC**- XAI Executer.

Indicate the appropriate **Executer URL**.

Owner indicates if this XAI executer is owned by the base package or by your implementation (**Customer Modification**). The system sets the owner to **Customer Modification** when you add an XAI executer. This information is display-only.

Where Used

Follow this link to open the data dictionary where you can view the tables that reference [CI_XAI_EXECUTER](#).

Note: The information in this table is cached by the XAI server and by the MPL server. Changes to values in this table do not affect the runtime copy of these servers. Refer to [How to Refresh the Runtime Copy of the Registry](#) for steps required to ensure that the servers use the most current data.

XAI Sender

XAI Sender - Main

To define a new sender, open **Admin Menu, XAI Sender**.

Description of Page

Enter a unique **XAI Sender** and **Description**.

Use **Invocation Type** to define whether the sender is a **Real-time** sender or called by **MPL** to route near real-time messages. The default is **MPL**.

Indicate the **XAI Class** for this sender. The class should be one that is defined for a sender. The sender classes are **DWNSTGSNDR**- Download Staging sender, **EMAILSENDER**- Email sender, **FLATFILESNDR**- Flat file sender, **HTTPSNDR**- HTTP sender, **JMSENDER**- JMS Queue sender, **STGSENDER**- Staging Upload sender, **TPCSNDR**- JMS Topic sender and **UPLDERRHANDLR**- Upload Error Handler.

Indicate whether or not this sender is currently **Active**.

Indicate whether the **MSG Encoding** is **ANSI message encoding** or **UTF-8 message encoding**.

If the XAI Class is **JMSENDER** or **TPCSNDR** indicate the appropriate **XAI JMS Connection**

Fastpath: Refer to [XAI JMS Connection](#) for more information.

If the XAI Class is **JMSENDER**, use the **XAI JMS Queue** to define where the response is to be sent.

Fastpath: Refer to [XAI JMS Queue](#) for more information.

If the XAI Class is **TPCSNDR**, use the **XAI JMS Topic** to define where the response is to be sent.

Fastpath: Refer to [XAI JMS Topic](#) for more information.

If the XAI class for this sender is **STGSENDER** indicate the **XAI JDBC Connection**.

Fastpath: Refer to [XAI JDBC Connection](#) for more information.

XAI Sender - Context

The sender may require context information to define additional information needed by XAI to successfully send outgoing messages. Open **Admin Menu**, **XAI Sender** and navigate to the **Context** tab.

Description of Page

Define the **Context Type** and **Context Value**, which contain parameters for senders when more information is required. For example, flat file senders need to indicate the file path and name. Email senders need to indicate a server, user name and password.

Fastpath: Refer to [Designing XAI Senders](#) for more information about the various senders that may require context information.

Note: The values for the Context Type field are customizable using the Lookup table. This field name is SENDER_CTXT_FLG.

Where Used

Follow this link to open the data dictionary where you can view the tables that reference [CI_XAI_SENDER](#).

Note: The information in this table is cached by the XAI server and by the MPL server. Changes to values in this table do not affect the runtime copy of these servers. Refer to [How to Refresh the Runtime Copy of the Registry](#) for steps required to ensure that the servers use the most current data.

XAI Group

XAI groups are used to process XML files, which contain a collection of [XML messages](#) to be uploaded in batch.

XAI Group - Main

To define your XAI groups, open **Admin Menu > XAI Group** .

Description of Page

Enter a unique **Group** and **Description** for the XAI Group.

Indicate the **Parser** used for this group. Possible values are **Dom Parser** and **StAX Parser**.

Note: **Dom Parser** reads the full XML document into memory and therefore is not ideal for larger XML documents. Indicate the **XPath** and **XPath Value**, which an XML file receiver uses to identify which group a given XML file belongs to.

- For **StAX Parsers** the XPath is limited to the root element.
- For **Dom Parsers**, the XPath supports defining elements at a lower level than the root element.

XAI Group - Attachments

Open **Admin Menu > XAI Group** and navigate to the **Attachments** tab to define attachments for your group.

Description of Page

For each entry in the attachments collection, indicate the **Sequence** and the **Root Element**. Use **Include Elements** to indicate if **Parent** elements should be included along with the current element when applying the XAI rules.

Fastpath: Refer to [XML Message File](#) for more information about how this is used.

XAI Group - Rules

Open **Admin Menu > XAI Group** and navigate to the **Rules** tab to define rules for your group.

Description of Page

For each entry in the rules collection, indicate the **Sequence**, the **Priority**, the **XPath** name and **XPath Value** and the **XSL File Name**.

Note: Include Parent. If your attachment indicates that **Parent** elements should be included, be sure that the parent element is included in the XPath defined here.

Fastpath: Refer to [XML Message File](#) for more information about how this is used.

Where Used

Follow this link to open the data dictionary where you can view the tables that reference [CI_XAI_RGRP](#).

XAI Receivers

XAI Receiver - Main

To define your XAI receivers, open **Admin Menu > XAI Receiver** .

Description of Page

Enter a unique **Receiver ID** and **Description** for the XAI Receiver.

Indicate the **XAI Class** for this receiver. The class should be one that is defined for a receiver. The receiver classes are **DWNSTGRCVR**- Download Staging receiver, **FILESCANRCVR**- Upload Files from a directory, **JMSRCVR**- JMS Queue receiver, **OUTMSGRCVR**- Outbound Message receiver, **STGCTLRRCVR**- Staging Control receiver, **STGRCVR**- Staging Upload Receiver and **TPCRCVR**- JMS Topic receiver, **XMLFILERCVR**- XML File receiver.

Fastpath: For more information, refer to [Designing XAI Receivers](#) about different types of receivers.

Indicate whether or not this receiver is currently **Active**.

Identify the **Executor ID**. Select the XAILOCAL executor if the XAI class for this receiver is STGCTLRVCVR. Select the BYPASSXAI executor if the XAI class for this receiver is OUTMSGRCVR. For all other receivers select the XAIURL executor. For more information, refer to [XAI Executor](#).

Indicate whether the **MSG Encoding** is **ANSI message encoding** or **UTF-8 message encoding**.

The **Read Interval** indicates the number of seconds between read cycles.

Start At Time and **Duration** are not currently in use.

If the XAI class for this receiver is **FILESCANRCVR**, **STGRCVR**, **STGCTLRVCVR** or **XMLFILERCVR**, indicate the **XAI JDBC Connection**.

Fastpath: Refer to [XAI JDBC Connection](#) for more information.

Turn on **Sequential Execution** if the received requests should be processed in [sequential order](#) (instead of multithreaded). If this value is turned on then XAI staging control records created by this receiver are marked for sequential execution.

JMS Information

The following information is only available if the XAI Class is **JMSRCVR** or **TPCRCVR**.

Indicate the appropriate **XAI JMS Connection**

Fastpath: Refer to [XAI JMS Connection](#) for more information.

Indicate the appropriate **XAI JMS Queue**.

Fastpath: Refer to [XAI JMS Queue](#) for more information.

Indicate the appropriate and **XAI JMS Topic**.

Fastpath: Refer to [XAI JMS Topic](#) for more information.

File Information

The following information is only available if the XAI Class is **FILESCANRCVR** or **XMLFILERCVR**.

Use the **Scan Directory** to indicate where to look for new files.

In **Scan File**, indicate the file pattern. All files with names matching the pattern are uploaded into the staging upload table. For each file found, a record in the staging control table is created.

Caution: WARNING. MPL expects all files conforming to the Scan File pattern to be complete. If a file is in the process of being copied into the scan directory and its name conforms to the naming pattern, MPL still attempts to process it and may issue an error for the incomplete file. It is suggested that files first be copied into the scan directory with a different name that does not conform to the naming pattern, for example filename.xml.inprocess. Once the file copy/transfer is complete, rename the file to one that conforms to the naming pattern, for example, filename.xml.

The following information is only available if the XAI Class is **FILESCANRCVR**.

Use the **XAI In Service Name** to indicate how the records in the file are mapped and how they are transformed to match a system service request structure.

XAI Receiver - Context

Open **Admin Menu** > **XAI Receiver** and navigate to the **Context** tab to define context for your receiver.

Description of Page

The Context collection enables you to define a collection of **Context Types** and **Context Values** defining. Use this collection when you need to store an attribute of a receiver that is not catered for in the current table.

Note: The values for the Context Type field are customizable using the Lookup table. This field name is RCVR_CTXT_FLG.

XAI Receiver - Response

Open **Admin Menu** > **XAI Receiver** and navigate to the **Response** tab to define where to send responses to requests made by this receiver. Refer to [Designing Responses for a Receiver](#) for more information.

Description of Page

The response collection enables you to define the destination (**XAI Sender**) where responses to a request may be sent under various circumstances (**Event**). The events currently defined with the product are **All events, Message executed OK, Application Error, System Error**.

Note: The values for this field are customizable using the Lookup table. This field name is ON_EVENT_FLG .

XAI Receiver - Groups

Open **Admin Menu** > **XAI Receiver** and navigate to the **Groups** tab to the valid XAI groups for an XML file receiver.

Description of Page

This collection is only available if the XAI Class is **XMLFILERCVR**.

For each entry in the Group collection, indicate the **Priority** and the **Group**. Refer to [XAI Groups](#) for more information about defining groups.

Where Used

Receivers are used by the XAI server and by the MPL server to process messages sent to the system from various sources.

Note: The information in this table is cached by the XAI server and by the MPL server. Changes to values in this table do not affect the runtime copy of these servers. Refer to [How to Refresh the Runtime Copy of the Registry](#) for steps required to ensure that the servers use the most current data.

Service Program

This transaction defines services available in the system. These include user interface services as well as stand-alone XAI services. A service may be invoked by XAI and as such may be referenced by an [XAI Inbound Service](#). Use this transaction to introduce a new stand-alone XAI service.

Select **Admin Menu** > **Service Program** to maintain service programs.

Description of Page

Define a **Service Name** for your new service.

Caution: Important! When adding new service programs, carefully consider its naming convention. Refer to [System Data Naming Convention](#) for more information.

Owner indicates if this service is owned by the base package or by your implementation (**Customer Modification**). The system sets the owner to **Customer Modification** when you add a service. This information is display-only.

Description describes the service.

Service Type indicates whether the service is a **Java Based Service** or a **Cobol Based Service**.

This **Program Component** grid shows the list of program user interface components associated with the service. For a stand-alone XAI service this list is optional.

Where Used

Follow this link to open the data dictionary where you can view the tables that reference [CI_MD_SVC](#).

XAI Inbound Services

The XAI Inbound Services section in the registry is the main section of the registry. It is used to define the service characteristics. Basically, a service is defined by an Adapter responsible for executing the service, a pair of XML schemas and connection attributes. The Adapter defines the interface with the target application server, while the schemas define the structure of the request XML document expected by the service and the structure of the response XML document generated by the service.

XAI Inbound Service - Main

To create or update an inbound service, open **Admin Menu > XAI Inbound Service** .

Caution: Important! When adding new inbound services, carefully consider the naming convention of the XAI In Service Name. Refer to [System Data Naming Convention](#) for more information.

Description of Page

Define a unique **XAI In Service Name**. This information is used in the system to identify the service. The service name is also the first XML element after the <Body> element in the XML request/response document. The system generates a unique **XAI Service ID**, which serves as the primary key.

Owner indicates if this XAI inbound service is owned by the base package or by your implementation (**Customer Modification**). The system sets the owner to **Customer Modification** when you add an XAI inbound service. This information is display-only.

Indicate the **Adapter**, which defines the interface with the target application server.

Fastpath: Refer to [XAI Adapter](#) for more information.

If adapter for this service should invoke a system service, then indicate the appropriate **Service Name**.

Fastpath: Refer to [Service Program](#) for more information about defining services.

If adapter is the base package **Business Adapter** then **Service Name** does not appear. Instead, use **Schema Type** to indicate the type of object this service invokes and **Schema Name** to reference the object to invoke. Using this adapter, you may set up service to invoke [business objects](#), [business services](#) and [service scripts](#).

Fastpath: Refer to [Designing XAI Adapters](#) for more information about the **Business Adapter**.

Use the **Description** and **Long Description** to describe the service.

Check the **Active** switch if this service is enabled and available for execution. If this switch is unchecked, then the service is defined in the registry, but not yet available for public use.

Check the **Post Error** switch to support [inbound message error handling](#) for messages that are not processed via the staging upload table.

Check the **Trace** switch if you would like the trace to be on for this particular service. If the general trace option is not activated, you can force a trace for a particular service.

Fastpath: Refer to [Server Trace](#) for more information about trace functionality.

When the **Debug** switch is checked, debug information is generated on the XAI console when this service is executed. The debug information can be useful to resolve problems.

Schema Definitions

Note: Request Schema and Response Schema are not applicable to services invoking schema-based objects. They do not appear when the **Business Adapter** is used.

The next two properties define the request and response XML schemas. The schemas were created using the [Schema Editor](#) and are SOAP compatible. The schema XML files are expected to be stored in the Schemas Directory on the Web server running the XAI server.

The **Request Schema** is the XML schema defining the service request. The request sent to the server must adhere to the schema definition.

The **Response Schema** is the XML schema defining the service response. The response generated by the XAI server corresponds to the response schema definition.

The same service may perform several actions on a business object. Use the **Transaction Type** to define the default action performed by a service. The transaction type can be provided when invoking a service, by dynamically specifying a transaction type attribute on the Service element of the XML request. This field may take the following values: **Read, Add, Change, Update, Delete, List** and **Search**.

Note: The difference between **Change** and **Update** is that for **Change**, all field values must be passed in with the request. Field values that are not passed in to the request are set to null. For **Update**, you need only pass the primary key field values and the values of the fields to be updated. All other fields retain their existing values.

Services, which perform a Search, may allow searching based on different criteria. When the Transaction Type value is **Search**, use the **Search Type** to define the default search criteria. The possible values are **Main, Alternate1, Alternate2, Alternate3, Alternate4, Alternate5** and **Alternate6**.

Note: This is a default definition only and it may be overridden at run time when the service is invoked. To override the search type at run time, you should specify the searchType attribute on the Service element of the XML request.

XSL Transformation Definitions

Sometimes, the XML request document does not conform to the request schema, or the response document expected by the service requestor is not the one generated by the adapter. In such cases the request and/or the response documents must be transformed. The XAI server supports transformation through XSL transformation scripts. Transformation scripts may be applied to the request before it is passed to the adapter or applied to the response document before it is sent to the service requestor.

The **Request XSL** is the name of the XSL transformation to be applied to the request document before processing it. The transformation is usually required when the incoming document does not correspond to the XAI service request schema therefore it has to be transformed before it can be processed by the adapter.

The **Response XSL** is the name of the XSL transformation to be applied to the response document when the requester of the service expects the response to have a different XML document structure than the one defined by the response schema for the service.

Click the **WSDL URL** hyperlink to launch a separate window that contains the WSDL definition for the inbound service. Note that the server name and port number for the URL are built using a setting in the common properties file using the XAI HTTP Caller URL setting.

Note: Refer to [WSDL Catalog](#) for information on how to obtain the WSDL catalog for all XAI Inbound Services.

XAI Inbound Service - Staging

The staging tab is used to define parameters for services that use the Staging Upload adapter.

Fastpath: Refer to [XAI Upload Staging](#) for more information.

Open **Admin Menu > XAI Inbound Service** and navigate to the **Staging** tab to define attributes for your upload staging adapters.

Description of Page

Indicate the **Staging File Type** to be processed by the staging upload service. Possible values are **Comma Delimited file**, **Database Extract** and **Sequential file**.

The format of the records in the input file are not in an XML format and do not correspond to an XAI service schema. As a result, the input record must be transformed into an XML message that conforms to an XAI service request schema. Enter the **Record XSL**, which indicates the XSL transformation script used to transform the input record into the appropriate XML message.

For **sequential files** and **Comma delimited files**, indicate the **Input File Name** to be processed.

Note: This parameter can be overridden in the **Staging Control** table when a request to execute such a service is made.

When the service takes its input from a **Database extract**, indicate the **JDBC Connection** used to connect to the database that contains the input data.

Note: If this value is not populated XAI uses the default JDBC connection, which is the current product database.

Fastpath: Refer to [XAI JDBC Connection](#) for more information about defining these values.

Use the **Interface Name** to provide a description of the interface being implemented through this service.

XAI Inbound Service - Parameters

This tab enables you to define parameters that are used as selection criteria by the DB Extract staging upload service.

Open **Admin Menu**, **XAI Inbound Service** and navigate to the **Parameters** tab.

Description of Page

The **Parameters** that were defined under the Request element in the schema are displayed here. They are used to drive the extraction process. This tab only displays the list of parameters. The values for these parameters can later be entered when the control record to invoke this service is created.

Fastpath: Refer to [Staging Control Parameters](#) for more information.

Owner indicates if this XAI inbound service is owned by the base package or by your implementation (**Customer Modification**). The system sets the owner to **Customer Modification** when you add an XAI inbound service. This information is display-only.

Where Used

Follow this link to open the data dictionary where you can view the tables that reference [CI_XAI_IN_SVC](#).

Note: The information in this table is cached by the XAI server and by the MPL server. Changes to values in this table do not affect the runtime copy of these servers. Refer to [XAI Command](#) for information about refreshing a service.

XAI Route Type

Refer to the documentation for your product to find out if XAI Route Type is supported.

Defining Outbound Message Types

Use this page to define basic information about an outbound message type. Open this page using **Admin Menu > Outbound Message Type**.

Note: This page is not available if the **Outbound Message** module is *turned off*.

Description of Page

Enter a unique **Outbound Message Type** and **Description**. Use the **Detailed Description** to describe the outbound message type in detail.

Indicate the Business Object that defines business rules and the schema for outbound messages of this type.

Indicate the relative **Priority** for processing outbound message records of this type with respect to other types.

This bottom of this page contains a *tree* that shows the various objects linked to the outbound message type. You can use this tree to both view high-level information about these objects and to transfer to the respective page in which an object is maintained.

Where Used

Follow this link to open the data dictionary where you can view the tables that reference [FI_OUTMSG_TYPE](#).

External Systems

Use this page to define an external system and define the configuration for communication between your system and the external system.

External System - Main

Open this page using **Admin Menu > External System**.

Note: This page is only available if either the **Outbound Message** or the **Open Market Interchange** module is not *turned off*.

Description of Page

Enter a unique **External System** and **Description**.

Use the field **Our Name In Their System** to specify the identity of your organization (i.e., your external system identifier) in the external system.

Note: The workflow process profile and notification download profile are only applicable to products that support workflow and notification. They are not visible in the product if the **Open Market Interchange** module is *turned off*.

If this external system sends inbound communications through notification upload staging, the type of workflow process that is created is controlled by the sender's **W/F (Workflow) Process Profile**.

If you send notifications to this external system, select a **Notification DL (download) Profile** that is used to define the configuration of the outgoing messages.

Note: The remaining fields are not visible if the **Outbound Message** module is *turned off*.

Set **Usage** to **Template External System** for external systems whose outbound message type configuration is inherited by other external systems.

If the outbound message type configuration should be inherited from a template external system, define the **Template External System**. If this field is specified, the outbound message type collection displays the data defined for the template system as display-only.

The **Outbound Message Type accordion** contains an entry for every type of outbound message defined for this external system. For each type of outbound message identify its **Outbound Message Type**.

Define the **Processing Method** for messages of this type. If the value is **XAI**, indicate the appropriate **XAI Sender**. If the value is **Batch**, indicate the appropriate **Batch Control**.

The **Message XSL** is the schema used to transform information from the format produced by the system to a format understood by the sender, who receives a message of this type.

Enter the file name of the appropriate **W3C Schema** if you want to validate the message built for outbound messages for this external system / outbound message type prior to being routed to their destination. Refer to [Outbound Message Schema Validation](#) for more information.

Response XSL will have the same search service as is used for the existing Message XSL field. This field will only be displayed when the processing method is **Real-time**. Refer to [Outgoing Messages](#) for more information on how it is used.

External System - Template Use

If you are viewing an external system whose usage is a **Template External System**, use this page to view the other external systems that reference this one. Open this page using **Admin Menu > External System** and then navigate to the **Template Use** tab.

Description of Page

The tree shows every external system that references this external system as its template.

Maintaining Your XAI Environment

This section describes various tools provided to enable your XAI administrators to more easily maintain your XAI environment.

XAI Submission

This page exists for testing purposes. It allows you to create an XML request document and submit it to the system, to ensure that the XML has been built correctly.

XAI Submission - Main

To submit an XML document for testing, navigate to **Admin Menu > XAI Submission** and navigate to the main tab.

Description of Page

This page is used to test XML schemas, which are defined for the XAI tool. Enter an appropriate XML document in the **XML Request** field. Typically, you define the XML schema using the schema editor in the XAI application. Then you would copy and paste the document here, then modify the schema to enter actual data for testing purposes.

When you have entered the document, choose Save to submit this document to the system. Note that this request information is not saved anywhere. It simply calls the system with the appropriate service name and executes the XML request.

Navigate to the Response tab to view the response.

XAI Submission - Response

To view the response to a XML document for testing, navigate to the response tab.

Description of Page

After choosing Save on the main tab to submit a test for an XML request, the response to your request is displayed in the **XML Response** text box.

XAI Dynamic Submission

This page exists for testing purposes. It is similar to the XML Submission page, but it dynamically builds your XML document based on a selected XAI service and data that you enter.

XAI Dynamic Submission - Main

To create and submit an XML document for testing, navigate to **Admin Menu > XAI Dynamic Submission** and navigate to the main tab.

Description of Page

Select the **XAI In Service Name**, which identifies the XAI Inbound Service called by the XAI tool to load/update the system data. After selecting, click **Load UI**. This button causes the system to read the XML schema associated with the service and build the screen with the associated prompts and fields, which enables a user to enter data.

Note: Testing schema. This page tests submitting the schema referenced on an XAI inbound service. If your service references an XSL transformation script, that information is ignored. This page tests post-XSL transformation.

Select the **Transaction Type** associated with this XML request. The valid values are **Add, Change, Delete, List, Read, Search** and **Update**. This information is built into the XML request document.

Set the **Trace** option to **yes** to request level tracing to be executed inside the XAI tool . This results in information written to a file, which may be useful in debugging.

The bottom portion of the screen contains field prompts and input fields for the data associated with the XML request linked to this service. The system dynamically builds this portion of the page by reading the XML Request associated with the service. You can enter data in the displayed fields.

Note: This page also generates other tabs dynamically for any collections that exist for the service being displayed. These tabs vary based on the service. The response tab is the only other tab that is always present.

Enter values in the appropriate fields. You need to have some knowledge of what information is needed based on the service and transaction type. For example, if your service is accessing the account record and you want to **read** the record, you only need to provide the account id. However, if your transaction type is **add**, you need to fill in all the fields necessary for adding an account. If you have not entered values correctly, you receive an error in the Response.

When finished entering values in the fields, click **Show XML** to see the XML request built based on the schema and the values of the fields entered.

If everything looks OK, click **Submit** to execute the XML request. Note that this request information is not saved anywhere. It simply calls the system with the appropriate service name and executes the XML request.

You are brought to the Response tab, where you may view the response.

XAI Dynamic Submission - Response

To view the response to the XML document submitted for testing, navigate to the response tab.

Description of Page

After choosing Submit on the main tab to submit a test for the XML request built dynamically, the response to your request is displayed in the **XML Response** text box.

Additional XAI Tools

This section introduces some additional tools to help you maintain your XAI environment.

XAI Service Export

The service export page allows you to export the definition of an XAI Inbound Service to a file. This function may be helpful if you need to copy the definition of this service to a separate environment. To export a service, open **Admin Menu, XAI Service Export**.

Description of Page

Upon entry into this page, you are provided with the current list of **XAI In bound Services** and their **Description**s. Use the **XAI In Service Name** search field to find the XAI service that you would like to export.

Use the **Export?** column to indicate which XAI service(s) you would like to export. Once you have selected your services, choose **Save**.

Note: If multiple services are selected, they are exported together into the same output file.

You are presented with the standard File Download dialogue where you can open or save the file.

XAI Service Import

The service import page allows you to import the definition of an XAI Inbound Service from a file into the XAI service table. This function may be helpful if you need to copy in the definition of this service from a separate environment. To import a service, open **Admin Menu, XAI Service Import**.

Description of Page

Upon initial entry into this page, you are provided with an input field, where you can enter the file name to import. Click **Browse** to search for the desired file in a directory.

Once the file is identified, click **Read File**, to read in the contents of the file.

Note: The format of the file must include tags indicating the column names for XAI Inbound Service table along with the values of the columns. For an example of how the format should be, simply go to the [XAI Service Export](#) page, export a Service and view the format of the resulting file.

Once the file has been read in, the list of XAI services found defined within the file is displayed in the Import grid, identified by their **XAI In Service Name** and **Description**. In the **Import?** column, indicate which services to import.

If a service with this service name already exists in the table, you must check the **Overwrite Existing** switch in order to indicate that the imported file information should replace the current service. An [XAI Inbound Service](#) that is provided as part of the system (i.e., with an owner of **Base Product**) may not be overwritten.

Click **Save** to proceed with the import. If any problems are found, information is displayed in the **Message Text** column.

XAI Command

Use the XAI Command page to send commands to the XAI and MPL server. To execute a command, open **Admin Menu, XAI Command**.

Description of Page

The following operator commands may be sent to the XAI server. For each of these commands, you may check **Also Sent to MPL URL**, in which case, the command is also sent to the MPL server. You need to indicate the URL of the MPL server.

Display Registry Use this command to display the current registry information that the XAI instance is running with.

Refresh Code and Description This is related to an attribute in the schema editor where you may indicate that the description of a control table code should be returned along with the code itself. This information is kept in cache memory in the server. As a result, changes made to descriptions have no effect on the runtime server. This command clears the cache of control table codes and descriptions accessed by the server. Refer to [How to Create Code Description Attribute](#) for more information.

Refresh Registry The registry contents are kept in cache memory in the server. As a result, making changes to the registry control tables has no effect on the runtime server. Use this command to refresh the contents of the registry cache with the new values in the registry control tables. The command reloads all registry control table data into the server.

Refresh Schema Schema definitions are stored in cache memory on the XAI server. As a result, modifying a schema definition has no effect on the runtime server. To refresh schema definitions, use the Refresh Schemas command.

Refresh Service Service definitions are stored in cache memory on the XAI server. As a result, modifying an XAI inbound service definition has no effect on the runtime server. To refresh service definitions, use the Refresh Service command. You are prompted to indicate which service to refresh.

Refresh XSL XSL Transformation script definitions are stored in cache memory on the XAI server. As a result, modifying an XSL transformation definition has no effect on the runtime server. To refresh XSL transformation definitions, use the Refresh XSL command.

Trace On Use this command to start the XAI server trace.

Trace Off Use this command to stop the XAI server trace.

XAI Trace Clear Use this command to clear the contents of the trace file.

XAI Trace Swap Use this command to rename the current trace file by appending the date and time to the end. A new trace file is then created with the name as defined in the [XAI option](#) page.

The following operator commands can be sent to the MPL server. You must set the URL of the MPL server first.

MPL Refresh Executer Executer definitions are stored in cache memory. As a result, adding or modifying executer definitions has no effect on the runtime server. Use this command to refresh executer definitions. You are prompted to indicate the executer to refresh.

MPL Refresh Receiver Receiver definitions are stored in cache memory. As a result, adding or modifying receiver definitions has no effect on the runtime server. Use this command to refresh receiver definitions. You are prompted to indicate the receiver to refresh.

MPL Refresh Sender Sender definitions are stored in cache memory. As a result, adding or modifying sender definitions has no effect on the runtime server. Use this command to refresh sender definitions. You are prompted to indicate the sender to refresh.

MPL Start Receiver Use this command to start a particular receiver. You are prompted to indicate the receiver to start.

MPL Stop Use this command to stop all MPL activity. It stops all receivers and waits for all executers and senders to complete.

MPL Stop Receiver Use this command to stop a particular receiver. You are prompted to indicate the receiver to stop.

MPL Trace On Use this command to start the MPL server trace.

MPL Trace Off Use this command to stop the MPL server trace.

When you have chosen the appropriate command and indicated any extra information, click **Send Command** to send the command to the server(s).

If you have sent a command to the XAI Server, then the bottom portion of the screen displays the response in the **XAI Response**. If you have sent a command to the MPL Server, then the bottom portion of the screen displays the response in the **MPL Response**. If you have sent a command to both servers, the bottom portion of the screen displays both responses.

MPL Exception

The MPL Exception table is used by the MPL to keep information about requests that resulted in a system error. These are errors that occurred inside the MPL. For example, if the MPL fails to send a request to XAI (maybe WebLogic is down), this is a system error, which would be logged in the MPL exception table.

There are errors that are defined recoverable. This means that the MPL will retry the action that failed, according to the parameters it received.

Server Trace

The XAI server traces every request and response. The requests/responses are written to a trace file on the server. The trace file may be viewed using the [Trace Viewer](#).

Starting the Trace

The log starts automatically based on definitions in the [XAI Options](#) in the traceType and traceFile options. To manually start the trace:

- Navigate to **Admin Menu, XAI Command**
- Select the **Start Trace** command from the command dropdown
- Click **Send Command**

Stopping the Trace

- Navigate to **Admin Menu, XAI Command**
- Select the **Stop Trace** command from the command dropdown
- Click **Send Command**

Trace Viewer

Use the Trace Viewer utility to view the log file. The Trace Viewer is installed when you install the XAI client tools. It can be found in the XAI program group under Start/Programs.

Main Page

When the Trace Viewer starts, select a trace file to view. A trace file may be opened in one of two ways:

- To open a trace file directly from its location on the web application server, use the **File, Open HTTP** menu item and provide the appropriate URL.
- To open a trace file on the local/network file system use the **File, Open** menu item

Description of Page

Once a trace file is opened, it displays a list of all the requests on the left side including the **Service Name**, the **Start Time** and the **End Time**.

To display the XML contained in the request and response entries for a displayed request, select a request entry.

Filtering Options

Since the trace file may contain a very large number of messages, the trace viewer limits the number of messages that can be displayed. It does that by displaying messages traced within the last x number of **Minutes**, **Hours** or **Days**.

Use the **Max Messages** to limit the number of messages displayed.

Note: Default Note. By default, the Trace viewer displays the first **200** messages in the trace file.

To view only errors in the trace, check the **Show only Errors** option.

Note: Refresh Display. After changing any of the above filtering options, click the refresh button  in order to redisplay the request entries based on the new options.

The **First Message Found** field indicates the date and time of the earliest entry in the trace file.

Viewing as Text

To view the trace file as text rather than viewing each entry in its XML format, use the **View, As Text** menu option. The contents of the trace file are displayed in text format in a separate window.

Statistics Page

Use the **View, Statistics** menu item to view the statistic page, which displays performance statistics about the XAI services that were executed in the XAI trace file.

For each type of XAI Service and transaction type, it displays the following information based on the requests traced in the XAI trace file:

- The **Service Name** with the transaction type in parentheses
- The **Number of calls** for this service in the listed trace records
- The **Average duration Time** (in seconds)
- The **Max imum duration Time** (in seconds)
- The **Min imum duration Time** (in seconds)

Note: Requests Included in Statistics. Only requests falling in the time selection criteria and listed on the main log viewer are processed for calculating the statistics.

To display a Duration Chart for a particular service, check the Service. A chart such as the one below is displayed.

How To

How to Build the XML Request Document

To execute a service, an application sends an XML request document over HTTP or to one of the XAI defined receivers. The request document must be built according to the request schema defined for that service. In addition, it is recommended that request documents adhere to the [SOAP](#) protocol. For these cases, a SOAP envelope must wrap the request document.

A request document contains the following elements:

SOAP-ENV:Envelope

SOAP-ENV:Body

Inbound Service Name

Service Element

[Service Header]

[Service Details]

The Service Header and the Service Details elements are optional (unless specified otherwise in the request schema) but at least one of the service header or details element must appear in the request. For retrieval service, usually the Header is enough, for maintenance service the Details element is enough. All other elements are mandatory.

The following XML document shows a simple request adhering to the SOAP standard.

```
<SOAP-ENV:Envelope xmlns:SOAP-ENV="urn:schemas-xmlsoap-org:envelope">
<SOAP-ENV:Header>
<Sender>
<Credential domain="NetworkUserId">
<Identity>admin@company.com</Identity>
<SharedSecret>welcome</SharedSecret>
</Credential>
</Sender>
</SOAP-ENV:Header>
<SOAP-ENV:Body>
<PersonInfo>
<PersonService>
<PersonHeader PersonID="0726118368"/>
</PersonService>
</PersonInfo>
</SOAP-ENV:Body>
</SOAP-ENV:Envelope>
```

SOAP Envelope

The soap envelope is the wrapping element of the whole request document.

The root of the request document is always the SOAP-ENV:Envelope element. The namespace attribute (xmlns=...) must be the same as the one defined in the SOAP Envelope Handler in the [XAI Envelope Handler](#) page.

Example for SOAP 1.0

```
<SOAP-ENV:Envelope xmlns:SOAP-ENV="urn:schemas-xmlsoap-org:envelope">
```

Example for SOAP 1.1

```
<SOAP-ENV:Envelope xmlns:SOAP-ENV="http://schemas.xmlsoap.org/soap/envelope/">
```

Note: If XAI cannot identify an appropriate envelope handler, it assumes that the root node is the service.

Header

The Envelope element may optionally be followed by the 'Header' element, which may contain the following optional elements:

The SoapActionVersion element

Multiple versions of a schema may exist for the same service. The SoapActionVersion element in the header defines which version of the schema is to be used for the service.

For example, if the service requires a request schema name AccountRequestSchema and the version element on the soap header is <SoapActionVersion>1.2</SoapActionVersion>, then the server attempts to use a schema with the name AccountRequestSchema.V1.2.xml.

When the version element is not present in the request, the server uses the default version as defined for that service in the [XAI Inbound Service](#) page.

The CorrelationId element

The CorrelationId element can be used by the sender to match an XML response to an XML request. When a CorrelationId is specified in the header of the request document, the XAI server copies this CorrelationId header element as is into the XML response document.

Document Body

The Body element (<SOAP-ENV:Body>) contains the Service information itself. The content of the Body element is an XML document based on the service request schema.

Service Name

The first element following the Body element must be the XAI service name. (i.e. CISPersonInfo). We refer to this element as the XAI Service Element. The XAI server uses the tag name to locate the service in the [XAI Inbound Service](#).

Transaction Type

The service element may contain the optional attribute **transactionType**. For services that represent page maintenance services in the system, the transaction type (Read, Add, Update, Change, Delete) is defined in the [XAI Inbound Service](#). An optional attribute may be specified in the first element to override the transaction type of the service. This allows using the same service definition to perform various transaction types.

Example 1. This service is used to perform an add of a record.

```
<SOAP-ENV:Envelope>
<SOAP-ENV:Body>
<Account transactionType='Add'>
.....
</Account>
</SOAP-ENV:Body>
</SOAP-ENV:Envelope>
```

Example 2. This service is used to perform an update to a record.

```
<SOAP-ENV:Envelope>
<SOAP-ENV:Body>
<Account transactionType='Update'>
.....
```

```
</Account>
</SOAP-ENV:Body>
</SOAP-ENV:Envelope>
```

Search Type

Search services may provide one or more type of searches, each using a different set of search fields. The default search type (MAIN, ALT, ALT1-ALT9) is defined in the *XAI Inbound Service*. However you may want to use various search types for the same service. To do so, you specify the **searchType** attribute on the service name element of the request.

For example the CDxAccountSearch service, provides the ability to search for accounts by AccountID (the MAIN search type) or to search accounts using an EntityName (the ALT searchType). The service is defined in the *XAI Inbound Service* as using the default searchType=MAIN.

Example. The following request searches by account ID

```
<SOAP-ENV:Envelope xmlns:SOAP-ENV="urn:schemas-xmlsoap-org:envelope">
<SOAP-ENV:Body>
<AccountSearch searchType="MAIN">
<Account>
<AccountHeader AccountID="0726118368"/>
</AccountHeader>
</Account>
</AccountSearch>
</SOAP-ENV:Body>
</SOAP-ENV:Envelope>
```

This one searches by EntityName.

```
<SOAP-ENV:Envelope xmlns:SOAP-ENV="urn:schemas-xmlsoap-org:envelope">
<SOAP-ENV:Body>
<AccountSearch searchType="ALT">
<Account>
<AccountHeader EntityName="Brazil"/>
</AccountHeader>
</Account>
</AccountSearch>
</SOAP-ENV:Body>
</SOAP-ENV:Envelope>
```

Trace

Traces are available at multiple levels in XAI.

System Level - All requests/responses are traced.

Service Level - All request/responses of a particular service type are traced.

Request Level - Trace only this request.

The **trace** attribute in the service element may be used to activate tracing for a particular request. This is useful if the XAI server trace option was not set and you want to trace a particular request without tracing all other requests. The trace attribute may take yes/no values.

Example:

```
<SOAP-ENV:Envelope>
<SOAP-ENV:Body>
<Account transactionType='UPDATE' trace='yes'>
.....
</Account>
</SOAP-ENV:Body>
</SOAP-ENV:Envelope>
```

Delete Unspecified Rows

The attribute **deleteUnspecifiedRows**, may be used on the list elements in request documents, to delete all rows in the list that were not referenced explicitly in the request. This attribute is applicable to services executed with `transactionType='UPDT'`. This is useful when one wants to replace all rows in a list with a new set of rows without having to explicitly reference all existing rows in the list. This attribute may take the following values:

- yes - All rows in the list are deleted prior to applying the rows specified in the request.
- no (default) - rows in the list are not deleted.

Following the Body element is the Main service element. This might be a page, list or search element.

For page services, following the main service element, there is one header element and one detail element. The header element only contains attributes. The details element may contain attributes and nested lists.

```
<SOAP-ENV:Body>
<Account>
<AccountHeader>
<AccountDetails>
<AccountPersons>
<AccountDebtClasses>
<AccountDetails>
</Account>
</SOAP-ENV:Body>
```

For list or search services, following the main service element, there is one header element and one row element. The header element only contains attributes. The row element may contain attributes and nested lists.

```
<SOAP-ENV:Body>
<AccountFinancialHistory>
<AccountFinancialHistoryHeader>
<AccountFinancialHistoryRow>
</AccountFinancialHistory>
</SOAP-ENV:Body>
```

Constructing Requests to Access Your Product

Constructing XML requests for the system is not different than doing it for other adapters, however the following guideline should be followed when constructing XML requests containing lists.

Page Services

Requests to access system Page services contain the following elements:

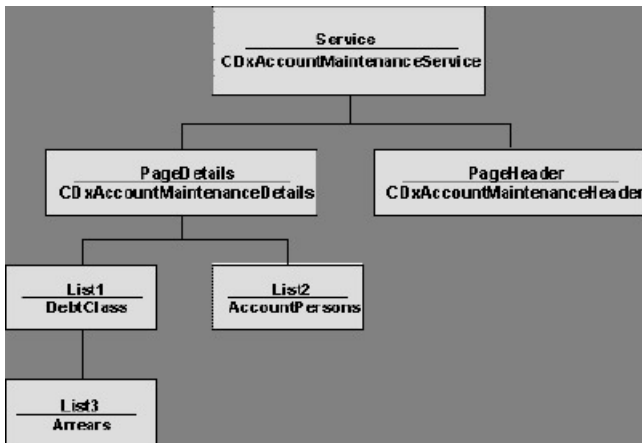

Page Read

To read a page, build a request that only contains the page header and use transactionType='READ'.

Note: Do not add the PageDetails element and underlying elements to the request. The request works but it adds unnecessary XML processing overhead on the server side.

Page Maintenance

To add or update a page service, the page details element is mandatory. Underlying elements may also be required depending on the service.

Performing Actions on Lists

Page services may contain Lists hanging off the service details element. I.e. the account maintenance service contains several lists under the service details element.

Performing an Action on a Specific Row

Some request schemas may contain lists. Actions such as Add, Delete, and Update may be performed on list items (rows). An action on a list item is specified using the "rowAction" attribute on a list item. The rowAction attribute may take the following values:

Row Action	Description
Add	Add the row to the list.
Change	Change the row. The row to be updated is identified using the attributes that have been defined in the schema as primary key fields.
UpAdd	The row to be updated is identified using the attributes that have been defined in the schema as primary key fields. If the row can be found then it is updated, if not it is added to the list.
Delete	Delete the row. The row to be deleted is identified using the attributes that have been defined in the schema as primary key fields.

Note: When the rowAction attribute is not provided for a list item, it defaults to the transaction type of the service. I.e. if the service is defined with transaction type="Add" then rowAction defaults to "Add".

Performing an Action on the Entire List

The following attributes can be specified in the List element:

getAllRows: By default XAI retrieves all rows that can fit in the buffer. However you may want to limit the number of rows that are returned.

To limit the number of rows specify: `getAllRows='false'` as an attribute in the List element.

DeleteUnspecifiedRows: Sometimes you want to replace all rows in a list with a new set of rows (not necessarily the same number of rows). Instead of having to read the list first, delete the unnecessary rows one by one and then add the new one, XAI provide an attribute that first deletes all rows in the list and then applies the rows that were explicitly specified in the list.

Performing an Action That Is Limited by Collection Size

In some cases you may want to add or update more elements than there are in the collection. For example, you may want to update fifteen characteristics in a service agreement when the collection size is only ten. To do this you can create two or more consecutive messages:

- The first message updates the service agreement with up to ten characteristics.
- If the first update was successful and there are more characteristics to update, then send a second message that includes the ID received from the previous message and additional characteristics. This step can be repeated until all elements are updated.

List Services

List services can only retrieve data and therefore are much simpler. To build a request for a list service, you only have to provide the list header (with the required attributes).

Note: Do not send the ListBody element in the request as it adds processing overhead on the server side.

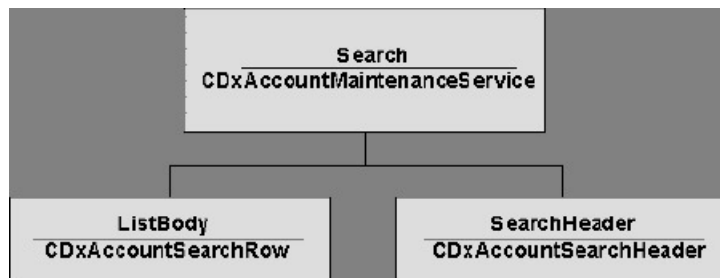

Search Services

Search services are very similar to list services, except that you can apply various search criteria using the searchType attribute on the service element.

Note: Do not send the ListBody element in the request as it adds processing overhead on the server side

Structure of an XML Response Document

Normal Response

When the service executes successfully, the SOAP envelope is returned as is. The response Body is built according to the response schema.

The XML document that is returned to the requester is as follows:

- SOAP Envelope
- Response Body

Fault Response

When an error occurs while executing a service, the XML document returned as the response is built according to the SOAP fault protocol. The first element following the Body element is the <Fault> element. The detail element contains detailed explanation of the error.

- ResponseStatus
- ResponseCode
- ResponseText

How To Create XML Schemas

This section explains how to create different types of schemas.

Creating a Schema for a System Service

This section explains how to create an XML schema for a system service.

In the Schema Editor, select the Schemas/Create/Service menu option. The 'Generate Schema for a Service' Dialog Box appears. Fill in the following fields:

Service Name Enter the name of the service to be created in the service name text box. This is the name of the first element under the Body element in the XML document. Clicking on the selection button at the right of this text box displays a selection list of available services in the system. The selection list is built out of the metadata tables in the system.

MetaInfo Directory/File The product uses XML MetaInfo files internally to describe a service. The Schema Editor uses this file to convert it to a valid XML Schema. Enter the name of the XML file defining the service. This file is used to generate the XML schema for the service.

Transaction Type Select the transaction type performed by the service. The available values are **Read, Add, Change, Update, Delete, List** and **Search**.

Note: The difference between Change and Update is that for Change, all field values must be passed in with the request. Field values that are not passed in to the request are set to null. For Update, you need only pass the primary key field values and the values of the fields to be updated. All other fields retain their existing values.

To generate the Schema, click **OK**.

Creating a Schema From an XML Instance Document

Often it is required to create an XSL transformation between two XML documents, one representing an XAI service and the other a document in another application. Although XSL scripts can be written manually (very tedious and erroneous process), we recommend using mapping tools such as the Microsoft BizTalk Mapper to create transformation scripts. The BizTalk Mapper requires XML schemas in order to graphically design the transformation. While schemas for system services are available, schemas might not be available for the other XML document. Provided that you have an instance of the other XML document, the Schema Editor can be used to generate a schema based on that instance.

To create a schema based on any XML document:

- Select Schemas/Create/XML Instance option from the menu.
- Enter the service name to be created in the Service name textbox.
- Enter the file name for the XML document to be imported.
- Click **Generate**.

Creating an XML Schema for a Sequential Input File

The input data file may be:

- A file where each record is described using a COBOL copybook.
- A comma delimited file (CSV).

Creating a Schema for a File Described by a COBOL Copybook

To create a schema for a file described by a COBOL Copybook, you use the Import COBOL copybook Wizard in the Schema Editor.

- Select Schemas/COBOL Copybook from the menu. The **Generate Schema for a Cobol CopyBook** dialog appears.
- Enter a unique **Service Name** and enter the name of the **COBOL Copybook**, for example: MtrUpld.cbl. (Clicking the ... button displays a file selection dialog box.)
- Click **Generate** to generate the XML schema.
- A schema is generated in the schema editor. You may now use the Schema Editor to edit the schema as with any other type of schema.
- Save the Schema with an appropriate name, e.g., CustomerContactsUploadSchema.xml

Example:

If the Cobol copybook looks like:

```
06 ACCT-ID PIC X(10)
```

```
06 MTR_ID PIC X(08)
```

```
06 MTR_READ PIC 9(10)
```

```
06 MTR_READ_DT PIC 9(8)
```

Then the generated Schema looks like this:



Creating a Schema for a Comma Delimited Input File

To create a schema for a comma-delimited file, use the Import CSV Wizard in the Schema Editor.

- Select Schemas/ CSV (Comma Delimited File) from the menu. The **Generate Schema for a CSV File** dialog appears.
- Enter a unique **Service Name** and the name of the **CSV File**. (Clicking the ... button displays a file selection dialog box.)

- If the sample CSV file contains field headers in the first row, check the **First Row contains column headers** check box. The field headers are used to create the attributes in the schema. Otherwise the attribute names are **FIELD1, FIELD2, etc..**
- Click **Generate**.
- A schema is generated in the schema editor. You may now use the Schema Editor to edit the schema as with any other type of schema.

Creating a Schema for a Database Extract

Use the DB extract, when the data to be loaded on the staging table resides on a relational database.

- A schema for a database extract describes how and what data is extracted from the database. An extract may extract data from several tables.
- Each table is represented by a node on the tree on the left hand side, under the 'Response' element.
- The first element under the response element is the driving table and for each row retrieved from that table a record is written to the staging table.
- Each response node may contain child nodes allowing a hierarchical extraction process. For example, we may want to extract accounts and their linked persons. For this case, we have an Account node and a child node under Account.
- A special node on the left hand side is the 'Request' node. The Request node does not represent any particular table. It contains a list of fields that are used as selection criteria, mainly used to extract data from the main table.

Consider the following example: You have account information on a legacy system and you want to migrate that data into the system. The legacy system has an ACCOUNTS tables and an ACCOUNT_PERSON table. You want to migrate all ACCOUNTS in the legacy system, which have a given Customer Class. You want to be able to upload data each time with various Customer Class values. Therefore the first SQL statement retrieves data from the ACCOUNTS table and uses external criteria for the customer class. The second SQL statement retrieves data from the ACCOUNT_PERSONS table and uses the ACCOUNT_ID from the main record set.

To create a schema for a database extract, use the Import Database extract Wizard in the Schema Editor.

- Select Schemas/Database Extract from the menu. The **Connection** dialog appears.
- Indicate the database, which contains the tables required for the extract. This might be the same database as your product or a different one. Click **Connect**.
- You are prompted to indicate whether to create a new schema or to open an existing one. When you create a new schema, the Editor starts a Wizard that guides you through the schema definition process.
- First, you're prompted to enter the service name for this schema. This is the root element name of the schema.
 - In our example, we will use **AccountsDBExtract**
- Next, you are prompted to enter the list of request attributes to be used by the main SQL. Each attribute has a name, a data type and a maximum length. On the right side you can see the list of defined request attributes. You use the left side to add or modify attributes. After you have entered the request attributes, click **OK**. We'll define **CustClass** as an example.
 - Name: **CustClass**
 - Data Type: **string**
 - Max Length: **8**
- Next you're prompted to enter the name of the root SQL element.
 - In our example, we will define **Accounts**
- The table selection list dialog appears. Select a table from the table list box. This table is used by the root SQL element.

- Once you select the table, the full screen appears. On the left side there is a tree representing the schema. On the right there is a tabbed dialog used to define the response elements. Each response node represents an SQL statement. Continuing with our example, on the Define Node tab, we enter the following:
 - Node Name: **Accounts**
 - Table Name: **<connection name>.CI_ACCT**
- Navigate to the **Select** tab to define the list of columns to be retrieved in this SQL. They are used to build the SELECT clause of the SQL statement. Each selected column is defined as an attribute of that response element in the schema. On the left you have the list of available columns. On the right you see the list of selected columns.
- Navigate to the **Where** tab to define the selection criteria for this SQL statement. Use the bottom frame to define criteria. Criteria are defined by a column, an operator and a value. The value may be a constant or a reference to an attribute in a parent element. In our example we'll use the request attribute **CustClass** as the value.
 - Criteria Column: **CUST_CL_CD**
 - Operator: **=**
 - Value: **@AccountsDBExtract/Request/CustClass**
- When you've completed the definition of a response element, click **OK**. This generates the SQL statement for that element and stores it on the schema.
- Now add another response element, called "AccountPersons". It is used to retrieve all persons linked to an account. Select the "Accounts" element on the left and click **Add** (located under the Tree View). Repeat steps described above for the new response element. Enter "AccountPersons" as the element name, select ACCT_PER as the table name and define the Select and Where clauses. This time use an attribute of the "Accounts" element to build the criteria for the "AccountPerson". This means that for each record returned by the root element, an SQL statement is generated to access the ACCT_PER table using the current ACCT_ID in Accounts.
- You have now completed the definition of the schema. Click on the toolbar "Test" button. When you test a DB extract schema, the editor prompts you for every attribute in the request element. It replaces every reference to a request attribute with the value you provide for the relevant SQL statement. In our example we only have one request attribute, the CustClass. Enter "I" for industrial customers.
- The response tab is now active and it shows the response document built as a result of executing the test. It should return all the elements of the Account table as defined in the response.

You can now save the schema by clicking **Save**.

How to Publish an XAI Service

The system is distributed with a limited number of XAI inbound services. However implementers may want to access system services that were not published with the base product. The following section provides a quick guide for publishing system business object as an XML based Web service.

- Select the system business object to be exposed
- Create the Request/Response XML schemas using the Schema Editor
- Register the service by creating an XAI Inbound Service record
- Test the Service

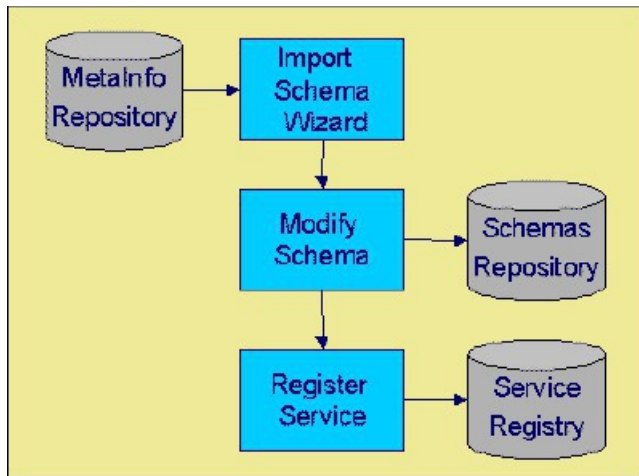

Select the Business Object

The first step is to select the system business object to be exposed as an XML based message. The following section describes how a business object is selected.

In your product, business objects are implemented as services. For each service, there exists a metadata definition of its input and output data called the "metainfo" file. While this metadata is most commonly used to construct the content of online pages, another use of this metadata is XAI, which can expose the same underlying service as an XML service. A tool exists that makes this possible. The Schema Editor reads the metainfo file corresponding to a service and generates an XML schema document describing the structure of the service when exposed as an XML service.

If the system does not provide a service that meets your needs, your implementation must define its own page service.

Define the Request/Response Schemas

Once the business object has been identified, we have to expose it as a pair of request/response XML schemas. The XML schemas are the foundation of the product APIs. They define both the structure of the documents that are exchanged between a service requester and the system and the internal mapping between the XML documents and the implementation of the business object in the system

Every service is defined by a pair of XML Schemas: the request and response schemas. The schemas contain additional information that maps the XML elements to the service. The request/response schemas are usually different, but in some cases may be the same schema.

The Request Schema

The request schema defines the XML document structure describing the "inputs" required by a service. Inputs may consist of a single element such as Person ID to implement the PersonInfo service or multiple elements that describe a Person to implement the PersonAdd service.

Fastpath: Refer to [How to Build the XML Request Document](#) for more information.

The Response Schema

The response schema defines the XML document structure describing the "outputs" of a service. The XML elements that are defined in the response schema are the ones that are returned to the service requester upon execution of the service.

Fastpath: Refer to *Structure of an XML Response Document* for more information.

Register the Service

For a service to be available, it must be registered by creating an XAI Inbound Service record. The XAI inbound service is used at run time to determine how a request is to be processed. The inbound service contains various parameters that control the execution of the service.

Fastpath: For more information, refer to *Registering a Service*.

Note: Test the Service. Once the schemas have been created and the service has been registered, you should *test* the schema and the service.

Testing a Schema Using the Schema Editor

The following section explains how to test a schema using the 'Test Schema' option in the schema editor Tools menu. Use this option when a schema is being edited.

Note: Before a schema can be tested, a service using this schema must have been *registered*.

You need to create an 'instance' XML document (a document with test data plugged in) based on the schema. The Test schema dialog provides the tools to create the instance, edit it, execute it and save it for future use.

Creating the request document

The first thing you have to do when you invoke the Test Schema Dialog is to create an initial instance of the request document, based on the schema currently being edited.

1. Select the transactionType: The transaction type combo displays a list of possible transactions for this service, depending on the service type (page, list or search).
2. When the transaction type is **SRCH** and more than one search type is available, the search type combo displays the list of available search types for this service, based on the schema definition. You must choose the search option. The combo on the right shows which fields are required by each search type.
3. Click **Create**. A tree representation of the request instance is displayed on the left TreeView.

Viewing/Editing the request instance

The tree view only displays elements of the request document. To display the list of attributes for an element, click that element. The attributes are displayed on the grid on the right. You may modify the value directly on the grid. If you need to enter a long textual value, click the button "..." at the right of the attribute.

By default the editor provides predefined values for 'commonly' used attributes such as AccountID, PersonID, PremiseID, BillID and SAID for an account shipped on the demo database. You may change them directly on the grid.

The request can be viewed on the tree or as text on a browser page. Use the toggle toolbar button to switch between modes.

Saving the request instance

To save a request instance, click **Save**. A save dialog box is displayed.

Executing the request

Once you've finished editing the request, you can execute it (send it using HTTP to the XAI servlet).

1. Enter the URL address of the XAI servlet. It appears at the right of the **Execute** button.
2. Click **Execute** to send the request.
3. The response is displayed on the **Response** tab.

Viewing the response

The response received as a result of executing the request, is displayed on the 'response' tab. It can be shown in a tree mode, similar to the request, or on a Web browser page. Use the toggle toolbar button to switch between modes.

Saving the response

You can save the response to an XML file.

1. Click **Save to File**.
2. Select a file name from the file dialog

How To Create Code Description Attribute

Many product tables contain fields that represent codes in a control table. Sometime the service contains the description for the code as well. This occurs if the user interface associated with the service uses a *go look button* to provide help in entering a valid value for that field. If the user interface associated with the service uses a dropdown list box as a mechanism for entering a valid value, then the description of the code is not included in the system service.

For the cases when the description of the code is not included in the system service, you may use special logic provided by the schema editor to include a description, if needed.

- Select the code attribute whose description should be included (for example, on the Meter schema, right click on the **MeterIdTypeCode** attribute). Right click on the attribute and select **Add Code Description Attribute** in the pop-up window.
- A dialogue box appears asking for the label to use for this new attribute. The label defaults to the label of the code with **Description** appended at the end (for example, **MeterIdTypeCodeDescription**). Choose an appropriate label and click **OK**.
- Next, you are asked for the Code table program to be used by XAI to retrieve the description of the code at runtime. (Continuing our example, this is **CIPTMITW**).
- After clicking OK, select the new attribute and view its properties.

How To Create a Private Attribute

Private attributes are attributes in your schema that do not correspond to any attributes in the system service. The schema editor ignores private attributes when validating a schema against a system service. The XAI server ignores private attributes when accessing system services.

To create a private attribute:

- Select any existing attribute and right click on the attribute. **Select Add Private Attribute** in the pop-up window.
- A dialogue box appears asking for the label to use for this new attribute. Enter an appropriate label and click **OK**.
- Your new attribute is created. Select the attribute and enter the other properties for this attribute.

How To Create an XSL Transformation

When the service data schema is different from an external data schema received from or being sent to an external system, we must map the data in the external schema to the service schema. To achieve this task we use a mapping tool.

In the following example, we are using the Microsoft BizTalk Mapper to create an *XSL Transformation* (XSLT) script that describes the transformation; however, other transformation tools available on the market can be used. This example assumes that there is a file with customer contact information to be uploaded into the Oracle Utilities Customer Care and

Billing customer contact table. It assumes that XML schemas for the input file and for the customer contact service already exist.

- Launch the Microsoft BizTalk Mapper.
- Enter the name of the input schema file as the source, e.g., CustomerContactsUploadSchema.xml.
- Enter the name of the service schema file as the target (e.g., CustomerContactAddRequestSchema.xml).
- BizTalk Mapper allows you to drag elements from the source XML to the target XML.
- When you are finished mapping elements, compile the transformation map.
- Save the transformation script with an appropriate name, e.g., CustomerContactsUpload.xsl.
- After saving the XSL script you need to edit it in Notepad and save it in ANSI encoding.

This XSL transformation script is now available for use as the Record XSL on the [XAI Inbound Service - Staging](#) page.

XSL Transformation with W3C

XAI W3C schemas (.xsd) use a namespace to qualify the elements in the schema. Each schema has a target namespace named after the service name. For example, if the service name is **CDxAccountMaintenance** then the target namespace for the schema would be: <http://splwg.com/CDxAccountMaintenance.xsd>.

When using an XSL transformation with system W3C schemas (.xsd), the XSL transformation needs to explicitly qualify the elements in the schema with the schema namespace. Following is an example:

```
<?xml version="1.0" encoding="UTF-8" ?>
<xsl:stylesheet xmlns:xsl="http://www.w3.org/1999/XSL/Transform" xmlns:msxsl="urn:schemas-microsoft-com:xslt"
  xmlns:var="urn:var" xmlns:user="urn:user" xmlns:kns="http://splwg.com/CDxAccountMaintenance.xsd" exclude-result-
  prefixes="msxsl var user" version="1.0">
  <xsl:output method="xml" omit-xml-declaration="yes" />
  <xsl:template match="/">
    <xsl:apply-templates select="kns:CDxAccountMaintenance" />
  </xsl:template>
  <xsl:template match="kns:CDxAccountMaintenance">
    <CDxAccountMaintenance>
      <!-- Connection from source node "transactionType" to destination node "transactionType" -->
      <xsl:attribute name="transactionType">
        <xsl:value-of select="@transactionType" />
      </xsl:attribute>
      <CDxAccountMaintenanceService>
        <CDxAccountMaintenanceHeader>
          <!-- Connection from source node "AccountID" to destination node "AccountID" -->
          <xsl:attribute name="AccountID">
            <xsl:value-of
              select="kns:CDxAccountMaintenanceService/kns:CDxAccountMaintenanceDetails/@AccountID" />
          </xsl:attribute>
          <CDxAccountMaintenanceHeader>
        </CDxAccountMaintenanceHeader>
      </CDxAccountMaintenanceService>
    </CDxAccountMaintenance>
  </xsl:template>
</xsl:stylesheet>
```

Substitution Parameters For NDS Messages

You may configure your system to use notification download tables to interface outgoing messages via XAI. When creating notification download staging records, you may use the context collection to define extra information about the NDS.

Context variables are exposed to the XSL transformation script as script parameters. Each context variable can be referred to using a parameter name having the same name as the context variable. The following XSL example shows how it is done for creating an email, but the same concept can be used for any XSL script used in a route type. In this example XPER and OHAD are context variables of the notification download record.

```
<xsl:stylesheet xmlns:xsl="http://www.w3.org/1999/XSL/Transform" xmlns:msxsl="urn:schemas-microsoft-com:xslt"
  xmlns:var="urn:var" xmlns:user="urn:user" exclude-result-prefixes="msxsl var user" version="1.0">
  <xsl:output method="xml" omit-xml-declaration="yes" />
  <xsl:param name="XPER"></xsl:param>
```

```

<xsl:param name="OHAD"></xsl:param>
<xsl:template match='/>
<xsl:apply-templates select='CDxPersonMaintenance'/>
</xsl:template>
<xsl:template match='CDxPersonMaintenance'>
<EmailMessage>
<To>
<InternetAddress address="ohad_anyone@splwg.com" personal="Ã ÃœÃ£ Ã¹Ã°Ã©" charset="Windows-1255" />
<InternetAddress1>
<!-- Connection from source node "EmailID" to destination node "address" -->
<xsl:attribute name='address'><xsl:value-of select='CDxPersonMaintenanceService/CDxPersonMaintenanceDetails/
@EmailID'/></xsl:attribute>
</InternetAddress1>
</To>
<BCC1><InternetAddress address="ohad_anyone@splwg.com" /></BCC1>
<Subject charset="Windows-1255">
<!-- Connection from source node "EntityName" to destination node "Subject" -->
<xsl:value-of select='CDxPersonMaintenanceService/CDxPersonMaintenanceDetails/@EntityName'/>
Mark Brazil
</Subject>
<MessageText charset="Windows-1255">
<!-- Connection from source node "Description" to destination node "MessageText" -->
<xsl:value-of select='CDxPersonMaintenanceService/CDxPersonMaintenanceDetails/@Description'/>
<xsl:value-of select="$XPER"/>
<xsl:value-of select="$OHAD"/>
This is text of the email message.
</MessageText>
<Attachment1 fileName="d:\cdx\test\test.pdf" contentId="fl3">
</Attachment1>
</EmailMessage>
</xsl:template>
</xsl:stylesheet>

```

How an Email Message is Constructed

You may define an email sender in order to send notification download staging (NDS) record information by email to a destination. This section describes how the email is constructed.

An Email may consist of the following parts:

- Address information (such as the From, To, CCs)

- Subject
- Message Text
- Attachments

The following diagram describes the method by which the system constructs an email message.

- To construct the Email message, the sender requires an XML file defined based on the following schema provided by the base product: **CDxEmailSchema.xml**.
- The XSL transformation linked to the XAI *route type* does the work of transforming the information retrieved by the XAI inbound service defined on the NDS Type and mapping it to the **CDxEmailSchema.xml** schema.
- The XSL script also receives all the Context records linked to the NDS record as parameters to the script when the script is invoked.
- The XSL script basically maps the Context fields and fields from the XAI service into the Email XML document. The XAI sender then uses the XML Email document (the result of the transformation) to actually build the Email to be sent.
- The resulting Email XML document should contain the elements as shown in the following image.

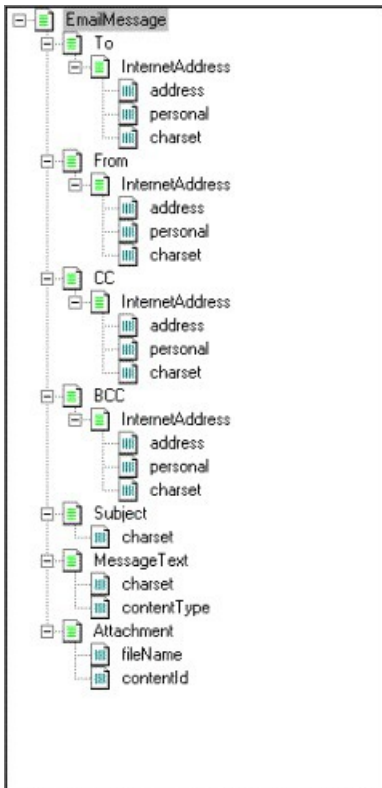

How to Refresh the Runtime Copy of the Registry

As explained above, the registry is read into cache memory when the XAI server starts. If the registry is modified and you want to immediately apply the changes on a running server, you have to manually refresh the registry.

To manually refresh the registry:

- Navigate to **Admin Menu, XAI Command**
- Select the **Refresh Registry** command from the command dropdown.

- If you want to also refresh the MPL server, check the **Also Send to MPL URL** check box.
- Click **Send Command**
- The refresh command is sent to the XAI server and the response is displayed in the response textbox.

Siebel Integration

The system offers an out of the box solution for integration with Siebel. In addition, XAI provides tools for an easy integration with Siebel EAI.

- XAI can process inbound messages coming from Siebel directly; in particular, it provides a special adapter that understands the Siebel Virtual Business Component (VBC) over the XMLGateway protocol.
- Automatic creation of Siebel integration objects and Siebel VBCs based on XAI schemas.

The *Schema Editor* provides several tools to facilitate the integration with Siebel. The following sections describe the available features.

Creating a Siebel VBC Definition based on a Schema

Siebel Virtual Business Components (VBC) can use the Siebel XML Gateway service to access objects in other applications. The XAI server provides a special adapter, that automatically maps Siebel XML Gateway messages to XAI messages and vice versa. The automatic mapping works, provided that the Siebel VBC is defined based on an XAI schema definition. To facilitate the definition of Siebel VBC and to minimize errors, the schema editor can be used to generate a VBC definition, which can be directly imported into the Siebel Repository. Once the VBC is defined in the Siebel repository, it can be used to build Siebel applets.

Note that VBC have some structural limitations and therefore cannot be used to represent all types of XAI services. VBC can only map a flat structure and therefore are a better fit for accessing search and list services. They are not very good for accessing complex hierarchical XAI services such as page maintenance services. In the case of page maintenance services, only the first level of the page details is accessible through the VBC; any lists underneath the first level are not accessible.

The process of creating a VBC, which maps an XAI service, is as follow:

- In the XAI schema editor, open the schema for the service you want to invoke from Siebel.
- Select Export/Siebel VBC from the menu. The Export Siebel VBC dialog appears.
- In the Siebel SIF file text box, enter the name of the file that should be generated. This file contains the VBC object definition.
- Click **Generate**.
- To import the VBC definition into Siebel, refer to the 'Siebel Tools Guide' in the Siebel documentation.

Creating a Siebel Integration Object based on a Schema

Siebel Integration Objects are used within the Siebel EAI to integrate Siebel with other applications. To facilitate the integration with Siebel, the *Schema Editor* can be used to create Siebel Integration Object definitions based on an XAI schema. This feature saves both time and errors.

The process of creating an Integration Object that maps an XAI service is as follow:

- Read a Schema into the Schema Editor
- Select Export/Siebel Integration from the menu. The Export Siebel Integration Object dialog appears.
- Enter the Siebel Project name in which the Integration object should be created.
- In the Siebel SIF file text box, enter the name of the file to be generated. This file contains the VBC object definition

- Click **Generate**
- To import the integration object definition into Siebel, refer to the 'Siebel Tools Guide' in the Siebel documentation.

Chapter 14

Importing Users and Groups

If your organization uses Lightweight Directory Access Protocol (LDAP), you can import your existing LDAP users and groups into Framework. Once imported, all user and group functions are available. You can resynchronize your LDAP users and groups at any time.

Note: Import only. The system currently supports importing LDAP information. Exporting users and groups from the system to LDAP is not provided.

This section describes how to set up your system to import users and groups from an LDAP store as well as how to do the import.

Note: XML Application Integration. The topics in this section are technical, and we assume that you are familiar with [XML Application Integration \(XAI\)](#).

How Does LDAP Import Work?

The LDAP import process uses a special XAI service (LDAP Import) that reads the information from the LDAP store and creates the appropriate security entries by calling standard [XAI services](#) to maintain users and groups. The entire import process may be more appropriately called synchronize because groups, users, and the connections between them are synchronized between the LDAP store and your product.

Invoking The Import Process

The [staging control receiver](#) invokes the LDAP Import service when it encounters a **pending** record on the [XAI staging control](#) table with a service ID of **LDAPImport**. To create a pending LDAP import staging control record, use the [LDAP Import](#) page to select the users or groups to be imported and click **Synchronize**. The LDAP Import page populates all necessary request parameters when creating the staging control record.

Processing LDAP Import Requests

The LDAP import service calls the *LDAP Import Adapter*, which performs the following actions:

- It reads the LDAP configuration information provided as XAI parameters to the request. Parameters include the Java Name Directory Interface (JNDI) server, user and password for the LDAP server, and the transaction type (e.g., *import*).
- It connects to the LDAP store using a *JNDI specification*.
- For each element (user or group) in the request, the LDAP is searched by applying the search filter (specified for the element) and the *searchParm* (specified in the request).
- The adapter goes through each entry found in the search and verifies whether or not there is already an entry in the system and whether a user belongs to a user group. From this information, it automatically determines the action to be taken:
 - Add
 - Update
 - Link user to group
 - Unlink user from group (by setting the expiration date)
- If the entry is a group, the adapter also imports all the users in LDAP that are linked to the group. If the entry is a user, the adapter imports the groups to which the user belongs in LDAP.
- For each imported entity, the adapter creates an appropriate XML request and adds it to the *XAI upload staging table*. If, for example, the action is to add a user, it creates an XML request corresponding to the *CDxXAIUserMaintenance* service; and if the action is to add a group, it creates an XML request corresponding to the *CDxXAIUserGroupMaintenance* service.

The *XML upload staging receiver* processes the upload records in sequential order (based on the upload staging ID).

Note: No Second Order Import. If a user is imported because the name belongs to an imported group, the adapter *does not* import all the other groups to which the user belongs. If a group is imported because the imported user belongs to it, the adapter *does not* import all the other users that belong to the group.

Note: Long User and Group Names. Users and groups whose names exceed the length limit in the system are not synchronized.

Setting Up Your System For LDAP Import

In order to set up your system for LDAP import, you must:

- Define a JNDI server that points to your LDAP server.
- Create an XML file that maps LDAP objects to Framework objects.
- Reference the LDAP mapping file in your XAI Parameter Information and MPL Parameter Information files.

The system is pre-configured for all other XAI components that are necessary for running LDAP Import, including:

- LDAP Import Adapter *XAI class*
- LDAP Import *XAI adapter*
- LDAP Import *XAI service*
- The necessary *XML request* and *XML response* schemas (LDAPImportRequest.xsd and LDAPImportResponse.xsd)

Defining a JNDI Server That Points to the LDAP Server

XAI uses Java Name Directory Interface (JNDI) servers to locate resources that are needed by XAI. To use LDAP Import, you must define a *JNDI server* that points to the LDAP server where the users and groups you want to import are located.

Note: JNDI Server Initial Context Factory. The JNDI server should have its Initial Context Factory field set to `com.sun.jndi.ldap.LdapCtxFactory`. This uses Sun's LDAP JNDI provider, which is provided with the application to access the LDAP store. If desired, you can use another JNDI LDAP provider by setting a different initial context factory and adding the classes of that provider to the classpath.

Fastpath: Refer to *Designing XAI JNDI Servers* for more information.

Mapping Between LDAP Objects And Base Security Objects

An LDAP store consists of multiple entries. Each entry represents an object in the directory that is identified by a Distinguished Name (DN) and may contain one or more attributes. In a typical LDAP store there is usually an entry for users and an entry for groups. The connection between users and groups may be implemented in two different ways:

- The users belonging to a group are defined in a special multiple-value attribute on the Group entry.
- The groups to which a user belongs are defined in a special multiple-value attribute on the User entry.

The mapping between LDAP security objects and base security objects is stored in an XML document that can be processed by the XAI service. As part of setting up your system for LDAP import, you need to define this mapping. The base package comes with a sample mapping file that can be used when your LDAP store is a Microsoft Active Directory Server (ADS). You can use this file as the basis for creating your own mapping file if you are using a different LDAP store (e.g., Novell Directory Server).

Attribute mappings are defined in the XML parameter information file under the LDAPImportAdapter section. Note that the mapping itself is in an external file that is included in the XML parameter information file.

The XML structure:

- Maps LDAP Entries to system objects
- Maps attributes in the LDAP entry to attributes in the system object
- Describes objects linked to the LDAP entry

Mapping an LDAP Entry to a Base Object

Each LDAP entry is mapped to a base product object (User or Group) using an `<LDAPEntry>` element that has the following attributes:

Attribute	Description
name	The name of the LDAP entry: - Group - User
baseDN	The base distinguished name in LDAP for this entry.

cdxEntity	The name of the base product entity to which the LDAP entry is mapped: - User - UserGroup
searchFilter	An LDAP search filter that is used to locate LDAP entries. A %searchParm% string in that filter is replaced by the value from the user or group search on the LDAP Import page.
Scope	Sets the scope of the search. Valid values are: - onelevel (the value normally used) - subtree

Mapping LDAP Entry Attributes to Base Object Attributes

Each attribute in the LDAP entry is mapped to attributes in the base object using an <LDAPCDXAttrMappings> section under the LDAP entry. Each <LDAPCDXAttrMapping> element has the following attributes:

Attribute	Description
ldapAttr	The name of the LDAP attribute to be mapped.
cdxName	The name of the base product attribute to be mapped. Note this is the name of the attribute in the XAI schema for the User or Group maintenance services.
javaClass	The name of a Java class to be called. To provide more flexibility in attribute mappings, especially when there is not a simple one to one attribute mapping, you can derive the value of a base product attribute by calling a method in a Java class. The Java class gets the LDAP entry as input and implement its own logic for computing the value of the attribute. The class should implement the ICDXValueObtainer interface whose source can be found in the cm_templates directory. The class should be available to both the defaultWebApplication and the XAIApp.
idParm	When the javaClass attribute is specified, the IdParm attribute contains a parameter value that is passed to the Java class method.
format	When the javaClass attribute is specified, the format attribute contains a parameter value that is passed to the Java class method.
default	The default value that will be assigned to the CDx attribute when one of the following occurs: - The LDAP attribute contains a null or empty value - The LDAP attribute does not exist or is not specified. - The Java class method returns a null or empty value. Default values are applied only when creating a new entity and are not applied to updated entities.

Describing Linked Objects

When mapping the user entity you need to describe how the groups the user belongs to are retrieved. When mapping the group entity you need to describe how the users contained in the group are retrieved. The link information is required when displaying the list of objects that is affected by the import.

Linked objects are described using the <LDAPEntryLinks> section under the LDAP entry. LDAP provides two methods to retrieve the linked objects:

- The linked objects are stored as multiple-value attributes on the entity (e.g., users contained in a group are stored as a multiple-value attribute on the Group entity).

- The linked objects are retrieved by applying a search filter on an LDAP entity (e.g., the groups to which a user belongs might be retrieved by applying a search filter to the Group entity).

Each <LDAPEntryLink> element has the following attributes:

Attribute	Description
linkedToLDAPEntity	The name of the linked entity (User or Group). Use User when describing the Group entity. Use Group when describing the User entity.
linkingLDAPAttr	The multiple-value attribute name on the LDAP entity that contains the linked entity.
linkingSearchFilter	The search filter to be applied to retrieve the list of linked objects, for example: (&!(objectClass=group)(memberOf=%attr%)) The search filter may contain the string % attr % that acts as a substitution string and is replaced at run time by the value of the attribute named "attr" of the imported entity. If the LDAP entry you are describing is a Group and the string is %name%, it is replaced by the value of the "name" attribute of the group you are importing. If the LDAP entry you are describing is a User and the string is %dn%, it is replaced by the "dn" attribute of the User you are importing.
linkingSearchScope	Sets the scope of the search. Valid values are: - onelevel (the value normally used) - subtree

Example XML Mapping

The following XML excerpt describes a mapping to the Microsoft ADS. The example makes the following assumptions:

- The base product attribute "DisplayProfileCode" is defaulted to "NORTHAM" when adding a new user.
- The LDAP Group entry contains the list of users belonging to the group in the **member** attribute.
- The groups to which a user belongs are retrieved by applying a search filter.

```
<LDAPEntries>
<LDAPEntry name=" User" baseDN=" CN=Users,DC=splwg,DC=com" cdxEntity=" user" searchFilter=" (&!(objectClass=user)(name=%searchParm%))">
<LDAPCDXAttrMappings>
<LDAPCDXAttrMapping ldapAttr=" name" cdxName=" User" />
<LDAPCDXAttrMapping cdxName=" LanguageCode" default=" ENG" />
<LDAPCDXAttrMapping cdxName=" FirstName" default=" fn1" />
<LDAPCDXAttrMapping cdxName=" LastName" default=" fn2" />
<LDAPCDXAttrMapping cdxName=" DisplayProfileCode" default=" NORTHAM" />
<LDAPCDXAttrMapping cdxName=" ToDoEntries" default=" 1" />
<LDAPCDXAttrMapping cdxName=" TD_ENTRY_AGE_DAYS2" default=" 12" />
</LDAPCDXAttrMappings>
<LDAPEntryLinks>
<LDAPEntryLink linkedToLDAPEntity=" Group" linkingLDAPAttr=" memberOf" />
</LDAPEntryLinks>
</LDAPEntry>
```

```

<LDAPEntry name=" Group" baseDN=" CN=Users,DC=splwg,DC=com" cdxEntity=" userGroup" searchFilter="
(&!(objectClass=group)(name=%searchParm%))">
<LDAPCDXAttrMappings>
<LDAPCDXAttrMapping ldapAttr=" name" cdxName=" UserGroup" />
<LDAPCDXAttrMapping ldapAttr=" description" cdxName=" Description" default=" Unknown" />
</LDAPCDXAttrMappings>
<LDAPEntryLinks>
<LDAPEntryLink linkedToLDAPEntity=" User" linkingSearchFilter=" (&!(objectClass=user)(memberOf=
%distinguishedName%))" linkingSearchScope=" onelevel" />
</LDAPEntryLinks>
</LDAPEntry>
</LDAPEntries>

```

Including Your LDAP Import Mapping in the Parameter Information Files

After you have defined your *LDAP mapping* in an XML file, you need to include it in the <AdHocParameters> sections of the XAI Parameter Information file (XAIParmameterInfo.xml) and the MPL Parameter Information (MPLParameterInfo.xml) file. The definitions are made to the LDAPImport adapter under an <Adapters> section that you add.

Note: Update Both Parameter Information Files. Make sure that you include the same update in both parameter information files (XAIParmameterInfo.xml and MPLParameterInfo.xml).

The following example shows an excerpt from the parameter information files:

```

<AdHocParameters>
<Adapters>
<Adapter name=" LDAPImport" maxReturnedResults=" 300">
<?XAI includeURL= file:///c:\Cdx\Product\Servers\MAIN_PROD_ORA\cisdomain\xai\ldapdef.xml?>
</Adapter>
</Adapters>
</AdHocParameters>

```

In the example above, the mapping file is called ldapdef.xml.

The maxReturnedResults attribute limits the number of LDAP entries the adapter returns for the search request. This limit is only applicable to the *LDAP Import* user interface. The import process itself is not affected by this parameter.

Fastpath: For more information about the XML Parameter Information file, refer to *XAI Installation*.

LDAP Import

Open **Admin Menu > LDAP Import** to import users and groups into the system.

Note: LDAP Import Setup. Your system must be appropriately configured for this page to operate correctly. Refer to [Setting Up Your System For LDAP Import](#) for more information.

Description of Page

Enter the **LDAP JNDI** server that should be used to connect to the LDAP server from which you want to import users or groups. Refer to [Defining a JNDI Server](#) for more information.

If the LDAP server from which you are importing users or groups requires authentication, specify an **LDAP User** and **LDAP Password** for the server.

Note: Username and password. Contact your LDAP system administrator for the format of the username and password to use.

From the **LDAP Entity** drop-down list, select either **User** or **User Group** depending on whether you want to import users or groups from the LDAP server.

Select the name of the **User** or **Group** that you want to import. (The label of this field changes depending on the **LDAP Entity** you selected.) You can use the search button to search for a list of users or groups that exist in the LDAP store.

After all fields have been specified, click the **Find** icon to return a list of all the objects contained in the selected user or group. If a user is specified, all the groups to which the user belongs are displayed in the grid. If a group is specified, all the users that belong to the group are displayed in the grid.

Click the **Synchronize** button to import the specified user or group and its linked objects (shown in the grid).

The LDAP Import service creates the configuration parameters on the XML staging control table and the [XAI Staging Control](#) page opens to let you view the status of your request.

Fastpath: For more information, refer to [How Does LDAP Import Work?](#)

Chapter 15

Configuration Migration Assistant (CMA)

This chapter describes the Configuration Migration Assistant (CMA), a facility to enable the export of customer-owned configuration data from one environment to another.

Caution: This chapter is intended for users responsible for testing configuration data and performing "what if" analysis in non-production databases.

Understanding CMA

The Configuration Migration Assistant (CMA) provides customers with a flexible, extensible facility for migrating configuration data from one environment to another (e.g., from a development environment to a production environment). Data is exported from the source system to a file. The file can then be checked in to a version control system for reuse, or can be immediately imported into the target system and applied.

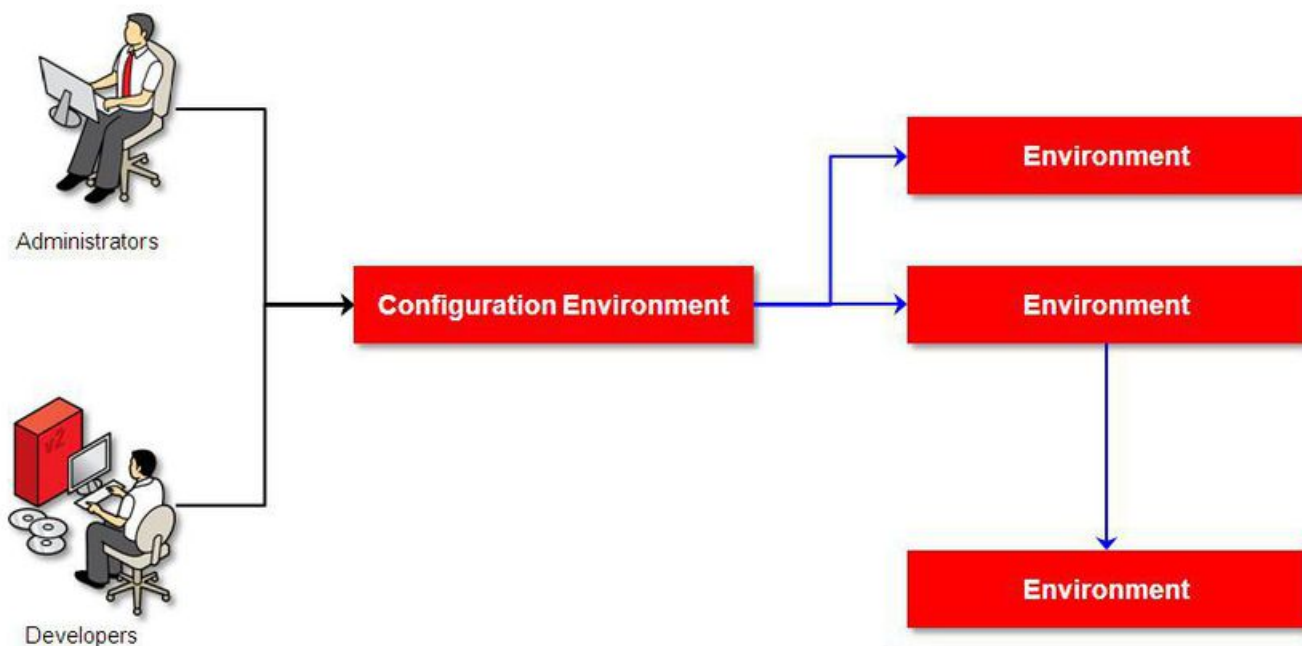

The following are typical uses for CMA.

Note: As used in this chapter, *source* systems are those on which export-related activities are conducted and *target* systems are those on which migration updates are to occur. The two system preparation tasks described in [Migration Assistant Configuration](#) must be performed on both source and target systems.

Wholesale Migrations: Bulk Migration of Configuration Data

The user can migrate all system configuration metadata from one environment to another. Related objects are processed together, and validated together, to ensure that the objects are logically consistent with system validation rules.

Examples of bulk migration:

- Migrate all BOs, algorithms, algorithm types, and scripts.
- Migrate all rates, rate components, units of measure, and other CM-owned, product-specific data.

Other common bulk migration operations include migrating all Framework configuration objects and migrating all configuration objects from Framework-based products.

For more on this type of migration, see [Wholesale Migrations](#)

Piecemeal Migrations: Migrating Related Data

Administrative users can specify how metadata is related, then request migration of an object according to a specified Migration Plan.

Examples of piecemeal migrations include:

- Migration of a new BO with its two UI maps (the Display map and the Update map).
- Migration of a new lifecycle plug-in algorithm plus all of the BOs using the algorithm.
- Migration of a new maintenance portal, its zones, and its app service.

For more on this type of migration, see [Piecemeal Migrations](#)

Repeatable Migrations of the Same Data

Migration requests can be defined at any time and modified or reused as needed.

The CMA Process Flow

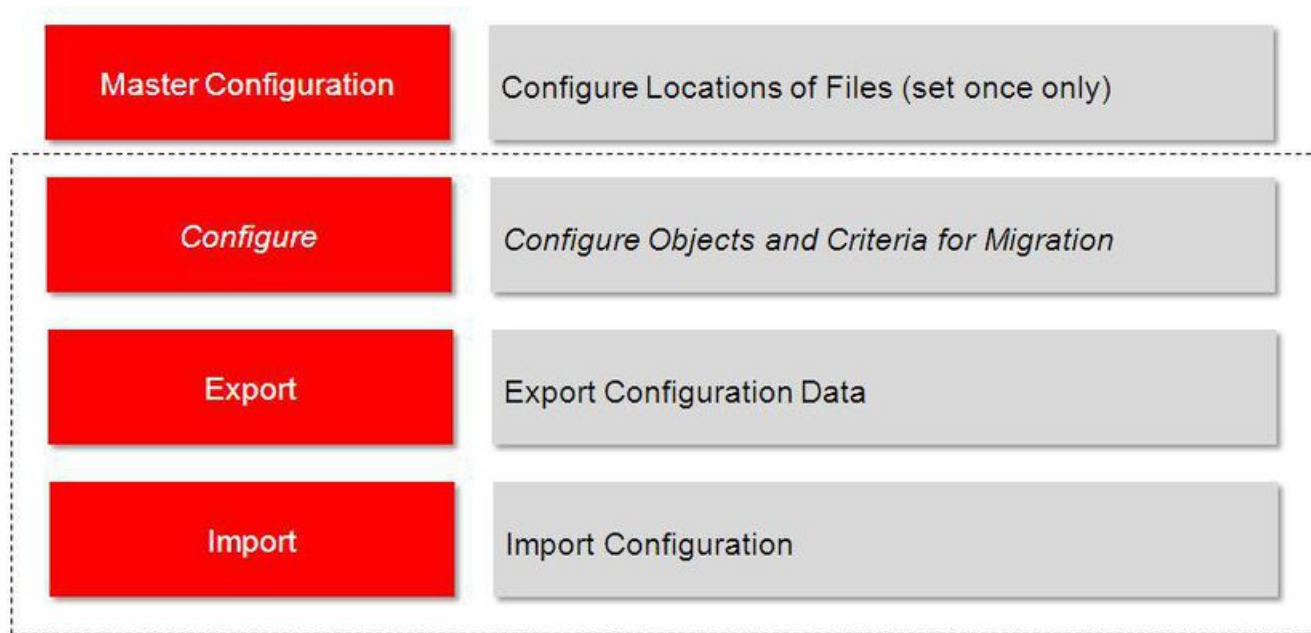

The high-level CMA process comprises the following tasks and flows. Each is described in more detail later in this section.

- **One-time tasks**, which must be applied on both source and target systems:
 - Specify the source and target paths and a file extension for import and export data files in the **Migration Assistant Configuration**.
 - Create a threadpool to assure migration of cached data.
- **Configuration** processes, which can be built on the source system at any time, and can be modified or reused any time:
 - Create a structured **Migration Plan** and specify business objects (one or more) to migrate. **Note:** If migrating data using a predefined plan or an existing custom plan, you can skip to the **Migration Request** and move to the execution stage.
 - Create a **Migration Request** to specify one or more Migration Plans for export and the specific objects to export using that plan.
- **Export** processes, performed on the source system to execute requests:
 - A **Migration Data Set Export** object is created to register the intent to export specified requests.
 - The **Migration Data Set Monitor** (the **CMA Batch Job Submission**) generates and monitors the lifecycle of the export data set.
- **Import** processes, performed on the target system to import and apply exported data:
 - A **Migration Data Set Import** object is created to register the intent to import completed exports.
 - The **Migration Data Set Monitor** reads the file, compares the objects in the file to the objects in the target system, and generates the instructions to make the target system objects match the objects that are in the file.

- Specific items may be reviewed and accepted or rejected.
- The **Migration Data Set Monitor** batch job is run again on the import side to apply and validate the approved changes.

Migration Assumptions, Restrictions, and Recommendations

CMA is designed to migrate configuration data only. Since base product data should be updated only through product patching mechanisms, CMA cannot currently be used to migrate master/transactional data that contains system-generated primary keys, such as customer account or billing information.

- CMA will only generate SQL statements on import for the following data:
 - Customer Modification (CM)-owned objects.
 - Non-owned objects.
 - CM-owned child rows of any object.
 - Customizable fields in objects owned by other owners.
- To simplify the model and avoid commonly-experienced issues regarding data deletion, CMA does not delete data in the target environment. CMA will only perform only **Add** or **Change** actions, and will not delete unnecessary objects (with the exception of CM-owned child collection rows inside an MO, where necessary). If data on the target system must be deleted, existing data modification facilities may be used.
- CMA supports moving large volumes of data. Multi-threading is used at the "data set" level only, with each data set using a single thread.
- Migration is based on dynamically-generated SQL statements rather than BO "replace" actions.
- CMA relies on the fact that database referential integrity constraints are not in place, and that the SQL statements can be run in any order within the transaction. Any archiving solution that requires referential integrity (such as ILM) would not be possible on this data. Given that CMA migrations comprise administrative data and not transactional data, this should be a reasonable exception.
- The validation that is performed is only via the **Page Validate** service. BO validation algorithms are not executed. Page validation does not currently include validation of the business object against the schema (for example, for required fields, field sizes, etc.).

Additional Note Regarding Imports

All migration requests can be exported at the same time. On the import side, however, you should consider importing, reviewing, and applying an entire file/data set before moving on to the next one. The reason is that if objects are included in more than one file, two sets of "inserts" will be generated, but only the first will succeed. The second will cause an insert error on the object, and the transaction would be marked with status "Applied With Errors". If instead you wait until the first file is applied before applying the second, the second dataset will not generate any SQL for the object, since it has already been inserted. It's a matter of efficiency: If you first import all files and then try to apply all, you'll have to identify the duplicated object as an error and then mark the object as rejected before applying the transaction.

Moving from ConfigLab to CMA

Note: For an overview of differences between CMA and ConfigLab, as well as other valuable information describing CMA features and functionality, see the "Configuration Migration Assistant Overview" whitepaper available from the [My Oracle Support \(MOS\)](#) Knowledge Base (search article 1506830.1). Sign-in is required.

Customers using Framework 4.2 and later are encouraged to move from the Configuration Lab (ConfigLab) facility to Configuration Migration Assistant for migration of configuration data as soon as possible and retain ConfigLab for migration of master and transaction data migration only.

Migration Plans and Migration Requests that cover many customer needs are provided with CMA and others are provided with Framework-based products that use Framework 4.2 or later. Developers and administrators may find that the provided object collection covers most, if not all, configuration migration needs.

Because the CMA and ConfigLab object models are different, however, no automated process is available to transfer defined code and objects from ConfigLab to support the extension of provided objects or the creation of new ones. Customers who made extensive use of ConfigLab can, however, manually transfer existing migration code components from ConfigLab to CMA and subsequently decommission ConfigLab in favor of CMA by following these general guidelines:

- Existing Primary DB Instructions defined in ConfigLab should be recreated as individual Migration Plans in CMA.
- The collection of Primary DB Instructions in ConfigLab should be defined in CMA as Migration Requests. The contents of a DB Process should be included in a Migration Request or split into multiple Migration Requests.
- SQL-based selection criteria should added to relevant Migration Requests.
- Algorithms used in ConfigLab can be copied to selection or input algorithms in CMA, keeping in mind that some algorithms may need to be recoded to conform to CMA's more efficient model for migration configuration data.
- When ConfigLab is to be decommissioned at your site, it's important that you deregister all environments using the ConfigLab utilities.

Migration Prerequisites

Migration Assistant Configuration

Before proceeding with your first migration, you must edit the **Migration Assistant Configuration** to register import and export paths as well as specify a file extension for the import and export files.

Note: As used in this chapter, *source* systems are those on which export-related activities are conducted and *target* systems are those on which migration updates are to occur. The preparation tasks described in this section must be performed on both source and target systems.

To edit a **Migration Assistant Configuration**, select the **Admin** menu, then choose **M > Master Configuration**. In the **Master Configuration** list, scroll to **Migration Assistant Configuration** and click the edit icon .

The **Migration Assistant Configuration** requires the following information:

- The **Export Directory** and **Import Directory** can point to different directories or can be used to save import and export files to the same directory. The directories can be on the machine on which exports are configured or can be on a remote server, but should be specified in accordance with the operating system directory naming protocols for the machine

or machines on which the files are to be written (e.g., C:\cmaoutput\datasets or /cmaoutput/datasets). Accessibility and authorization rules are:

- Both directories must be accessible to system batch jobs.
- The export directory must be writeable by the user exporting the data.
- The import directory must be readable by the user importing the data to the target environment.
- The **File Suffix** (extension) for data files is the same. Do not enter a period in the file extension field. The period is added when the file is created. The base name for data files is specified at execution time.

When your initial path and file extension information is complete, click **Save** to save the configuration.

Note: The **Migration Assistant Configuration** can be revisited at any time to change the directories and/or file extension information. The new configuration takes effect on all subsequent exports and imports. Keep in mind, however, that the file suffix will be added to any file name you type in. If you export a file with *.txt* and import successfully, and then you change the suffix to *.dat* in the configuration, the import process will not be able to find the file.

Preparing a Threadpool

Because CMA updates administrative data that is usually read from a cache, a threadpool with the L2 cache disabled is required during the execution stages of migration. The threadpool name must be entered in the **F1-MGDPR** batch control for all CMA processing.

To create a threadpool with L2 caching turned off, use the "-l2 OFF" parameter when creating the threadpool using either of the provided scripts (threadpoolworker.cmd|sh or starttpw.cmd|sh). Name the threadpool and use this name for the batch control parameter "DIST-THD-POOL".

CMA batch submission details are described later in this document in [Submitting a Batch Job](#).

For additional background and details on threadpools and threadpool management, see the "Designing Your Threadpools" section in the "Batch Best Practices" whitepaper available [My Oracle Support \(MOS\)](#) Knowledge Base (search article 836362.1). Sign-in is required. The *Batch Server Administration Guide* also contains information on preparing and implementing threadpools.

CMA Configuration: Plans and Requests

The CMA configuration process is initiated by defining **Migration Plans** and **Migration Requests** that cover your configuration migration needs.

Defining a Migration Plan

Migration Plans comprise a group or groups of objects to migrate as a set of related objects. Essentially a set of instructions describing how the data to be exported is structured, plans allow objects to be migrated together as a logical unit to ensure consistency and completeness.

To define a new plan, select the **Admin** menu, choose **M > Migration Plan**, then click the **Add** link in the **Migration Plan Query**.

Note: A **Migration Plan Query** can also be used to locate and modify a previously defined plan, or to view or duplicate any of the Framework-owned plans provided by CMA for use as the basis for a custom plan.

In the **Main** section of the **Migration Plan** screen, enter a name for the plan, and a description and a detailed description to serve as search aids.

In the **Instructions** section, enter an **Instruction Sequence** number for the first instruction (usually "10", to allow insertion of other instructions should the plan be revised or duplicated to create a new plan at a later time).

Select **Primary** for the first **Instruction Type**. All migration plans must contain one and only one primary instruction; this is the point at which the tree of the exported data structure starts. Also note that when the primary instruction is established, the **Parent Instruction Sequence** field is disabled.

Note: If the instruction to be entered is **Subordinate** to the primary instruction, the **Parent Instruction Sequence** must be entered. This number, used to maintain the defined relationships in the exported data, must match an instruction sequence number at a higher level in the hierarchy. If the primary instruction sequence number is "10", for example, the first subordinate sequence number is set to "20" (for maintenance reasons noted earlier) and the parent sequence of the subordinate would be "10".

The instruction **Description** can be used in plan searches.

Select a **Business Object** (BO) to define the type of object from which data will be derived.

Note: Though BOs are specified in each instruction, it's important to understand that each BO is used only for filtering purposes. The migrated data set comprises the complete contents of the *maintenance object* that the business object structure is defined against. For a more detailed explanation of this, see [Understanding the BO Filtering Process](#).

To select a business object, click the **Search** icon  to open the **Business Object Search** window. Enter the name (or partial name, e.g., "f1-bus") of the object in the **Business Object** search field, press **Enter** to list matching objects, then click your selection (e.g., "F1-BusinessObjectPhysicalBO") to close the dialog and populate the **Business Object** field.

Traversal Criteria provides three options to define how the child object is connected to the parent object so the system knows how to traverse from one object to another. **Traversal Criteria Type** options are:

- **Constraint**, which allows you to select a constraint that represents a given record's relationship to another record in the system via a foreign key reference. If **Constraint** is selected, the following additional fields are enabled:
 - **Constraint ID** is a unique identifier for the constraint (e.g., CI_C0049331). You can enter a known identifier, or click the **Search** icon  to locate one. Note that if the constraint is selected through a search, the **Constraint Owner** field is automatically populated.
 - **Constraint Owner** provides a selection list to indicate the owner of the constraint. If the field is not already populated through the selection of a Constraint ID, available options are **Base** (constraints owned and provided by a non-Framework base package), **Customer Modification** (for constraints created by you), or **Framework** (for constraints owned and provided by the Application Framework).
- The **SQL Statement** lets you specify SQL join criteria between objects using #THIS and #PARENT criteria, then specifying table and field names. For example, the statement #THIS.F1_MAP.MAP_CD = #PARENT.F1_BUS_OBJ_OPT.OPTION_VALUE AND BUS_OBJ_OPT.OPTION_FLG = 'F1DU' could be used to join a subordinate instruction's **F1-UIMapPhysicalBO** to a primary instruction's F1-BusinessObjectPhysicalBO object for the purpose of collecting all display UI Maps, and a third instruction could be added that also uses **F1-UIMapPhysicalBO** and also references the primary instruction as its parent, but collects all maintenance UI maps by copying the SQL statement and changing the option flag from **F1DU** to **F1MU**.
- The **XPath** option lets you apply similar simplified syntax but in an XPath-style expression. This allows you to use foreign key references that are mapped inside a CLOB to connect two objects. For example, the display map collection statement in the SQL example noted above would be written as follows in XPath: #this/F1_MAP.MAP_CD = #parent/l_BUS_OBJ_OPT.OPTION_VALUE and #this/BUS_OBJ_OPT.OPTION_FLG='F1DU'.

Note: Additional usage details and syntax examples for the SQL and XPath **Traversal Criteria Types** are available by clicking the embedded Help icon  on the criteria entry field.

Next Migration Plan is an optional instruction setting that harnesses CMA's flexibility and reusability strengths by providing an opportunity to insert the name of a previously-defined plan into any current instruction, including the primary instruction, so the data specified will be inserted into this plan's export file when the plan is executed.

Algorithms can also be stored and applied to the data after it is moved to the target system. If, for example, you are migrating a batch control where the next batch sequence number is part of the object but you don't want to change the value on the current system or you want to set it to some other value, you can apply an algorithm to the task. To apply an algorithm, first select the appropriate type from the **Algorithm Processing Type** drop-down, then set the **Processing Sequence** (the order in which this and any additional algorithms should be applied to this instruction). To select the algorithm, click the **Search** icon  to open the **Algorithm Search** window, enter the first few characters of the appropriate algorithm (e.g., "f1-"), and double-click your selection from the listed results. Additional algorithms can be applied to refine the exported data set by clicking the "+" icon and repeating this step.

You can also define **Migration Import** algorithms with custom logic that is invoked during the **Apply** process and is executed to maintain the object in a valid state when changes might be appropriate to the object once it is in the target system. [Click here](#) for a list of the algorithm types available for this plug-in spot.

When your plan is complete, click **Save** to make it available for further modification, inclusion in a **Migration Request**, or for use in defining other Migration Plans.

Migration Plans for Objects with CLOB-Embedded Links

Options for creating migration plans with CLOB-embedded links:

- When dealing with CLOB-embedded links using a Physical BO, which may not have the specific CLOB elements explicitly defined within its schema, raw SQLs in the Subordinate Instruction's Traversal Criteria can be used to establish relationships involving all CLOB elements (which are saved in the physical database record). However, a separate Subordinate Instruction will have to be created for each SQL corresponding to each element occurrences.
- An alternative approach to dealing with CLOB-embedded links is to not use the Physical BO. Instead, use the actual BO which explicitly defines the CLOB elements within its schema. In this case, XPATH Constraints can be used which cover all occurrences of the same element. Note, however, that when this approach is used, a separate Migration Plan must be created for each such BO. This can become cumbersome, depending on the number of BOs associated with any given MO, since each of these BOs may have its own set of CLOB elements.
- A third alternative is to create a migration plan that uses the Physical BO as the primary instruction, and then include a subordinate instruction for the real BO, using SQL Traversal to join the object to itself by its primary key. The BO will only be included once in the export file, but XPath notation can be used from the subordinate instruction to link to further subordinate objects.

Wholesale and Piecemeal Migrations

Configuration Migration Assistant uses two general types of migrations: wholesale and piecemeal.

Wholesale Migrations

Wholesale migrations are used when migrating all the configuration and/or admin data from one environment to another. For example, a wholesale migration might be used when migrating admin data from a development or test environment to a production environment.

Wholesale migration plans contain Primary Instruction as well as Subordinate Instructions that involve "CLOB-embedded links" (if any). Subordinate Instructions for "Standard Constraints" may be included but are deliberately omitted because they are extraneous, bulky, and redundant for wholesale migrations. Wholesale migration plans are included in the base package migration request and are provided for use with wholesale migrations.

Executing Wholesale Migrations

The high-level steps involved in executing a wholesale migration are:

1. Process the "F1-SchemaAdmin" (FW Foundation) migration request (This request contains migration plans for Field, Lookup, Char Type, Currency Code and FK Ref).
2. Process the base package migration request (e.g., "D1-AdminData" or "C1-AdminData"). This includes copies of Framework migration plans (including plans for Business Objects, Algorithms, and Extendable Lookups) from the "F1-FrameworkAdmin" migration request, as well as all of the base package-owned wholesale migration plans.
3. Process any of the other delivered Framework-based (F1-owned) migration requests as needed (except for the "F1-FrameworkAdmin" migration request, which is already incorporated in step 2).

Piecemeal Migrations

Piecemeal (or "non-wholesale") migrations are used when migrating a small portion (or piece) of configuration and/or admin data from one environment to another. For example, a piecemeal migration might be used when migrating groups and rules from a development or test environment to a production environment.

Piecemeal migration plans contain both Primary Instruction as well as all Subordinate Instructions. Subordinate Instructions include "CLOB-embedded links" (if any) as well as "Standard Constraints". Piecemeal migration plans are not included in the base package migration request used with wholesale migrations. Base package "non-wholesale" migration plans are provided as samples to help customers migrate data in "piecemeal" or non-wholesale scenarios.

Executing Piecemeal Migrations

The high-level steps involved in executing a piecemeal migration are:

1. Create one or more piecemeal migration plans as needed based on the specific configuration/admin data to be migrated. (the base package contains a number of sample "non-wholesale" migration plans that be used as examples for this).
2. Create a custom migration request that contains the migration plans created in step 1 and specifies the keys of the objects you wish to migrate. Keys can be specified using any of the selection types (SQL, algorithm, or specific key values). Be sure to include all primary key values for the objects.
3. Process the custom migration request (export/import).

Base Package Piecemeal Migration Plans

Base packages provide piecemeal (non-wholesale) migration plans as examples for customers when creating their own piecemeal migration plans.

Understanding the CMA BO Filtering Process

When you specify the business object in the migration plan instruction, you are stating that you only want to include the objects that are this type of Business Object. Framework-based products can have objects that have a single one underlying maintenance object and multiple different kinds of business objects that are of that maintenance object type. For example, Oracle Enterprise Taxation and Policy Management might have an MO for "form type", with one BO for "tax form" and

another for "registration form". If you are using business objects of this type, this can match anywhere in a business object's parentage hierarchy, allowing CMA to filter what is to be included and export only objects of a specified type.

Common practice is to use a *physical* business object in the migration plan instruction, matching any object of that maintenance object type. Once CMA identifies the objects that are to be included based on the select statement or the traversal criteria, it checks each object to verify that the object is of the specified business object type and includes the object if it either matches exactly, is part of the parentage hierarchy, or if it's the physical BO for the maintenance object that is indicated by this business object.

Since CMA handles the filtering, you can use any BO in your migration plan. If, to use the ETPM example, you build a migration plan that is to export only registration forms of a certain type, the business object might find 500 forms, but because the select statement or constraint specifies the exact form type of "registration form", CMA would include in the export only the three among the 500 that match the specification. If you wanted all forms of all types, you would simply use the physical BO for "form type".

Defining a Migration Request

Migration Requests are unordered lists of Migration Plans that are to be migrated together. Algorithms, SQL statements, or specific keys are used to specify the set of objects you want to export. When complete, the request describes the complete data set that is extracted to the migration export file when the request is executed.

To define a new request, select the **Admin** menu, choose **M > Migration Request**, then click the **Add** link in the **Migration Request Query**.

Note: A **Migration Request Query** can also be used to locate and modify a previously defined request, or to view or duplicate any of the Framework-owned requests provided by CMA for use as the basis for a custom plan.

In the **Main** section of the **Migration Request** screen, enter a name for the request, as well as a description and a detailed description to serve as additional search criteria.

Since everything in the transaction is grouped on export and there is no concept of a primary instruction as there is in a Migration Plan, the order of Migration Plans entered into the request is unimportant. To add the first plan, click the **Search** icon  next to the first **Migration Plan** field to open the **Migration Plan Search** dialog. Enter the name (or partial name) of the plan to include in the **Migration Plan** search field, press **Enter** to list matching objects, then double-click your selection. Note that if only one plan matches, the dialog closes immediately and populates the **Migration Plan** field in the request screen.

Three **Selection Type** options are available for each plan in the request. The choices are **Algorithm**, **SQL Statement**, and **Specific Key**.

An **Algorithm** can return the list of key values that will be migrated; for example, if you wanted to select all the primary keys from a certain maintenance object or all PKs that have a certain naming convention, you can use an algorithm to migrate the specified rows. The advantage to using an algorithm is that you can pick and choose primary keys to migrate.

You can use the algorithm plugin-spot on a **Migration Request** to define algorithms that, when invoked, return the list of entity IDs to be exported. [Click here](#) for a list of the algorithm types available for this plug-in spot.

To migrate all primary keys, a **SQL statement** is the most direct route. You'll note, for example, that in Framework-owned requests provided by CMA, the SQL statement "1=1" is used to migrate everything in the plan. Should you need to export only selected rows, of course, the statement can be modified by simply duplicating and customizing the prepackaged request.

The **Specific Key** option lets you enter keys individually to define the migration. Because of their dependency on the maintenance object, specific primary key values cannot be searched, however, and must be typed in. For example, to export the to-do type "CALLCUST" and all its roles, you need only specify the `F1-ToDoTypesAndRoles` migration plan, and use "CALLCUST" as Primary Key 1 under the Key Selection group. Keys for additional objects can be specified by clicking the plus sign to add more rows to the selection list.

When your request is defined, click **Save** to make the request available for further modification or available for execution.

The CMA Execution Process

The following diagram illustrates a high-level view of the Configuration Migration Assistant execution process. The subprocesses illustrated here are described in more detail in the following sections.

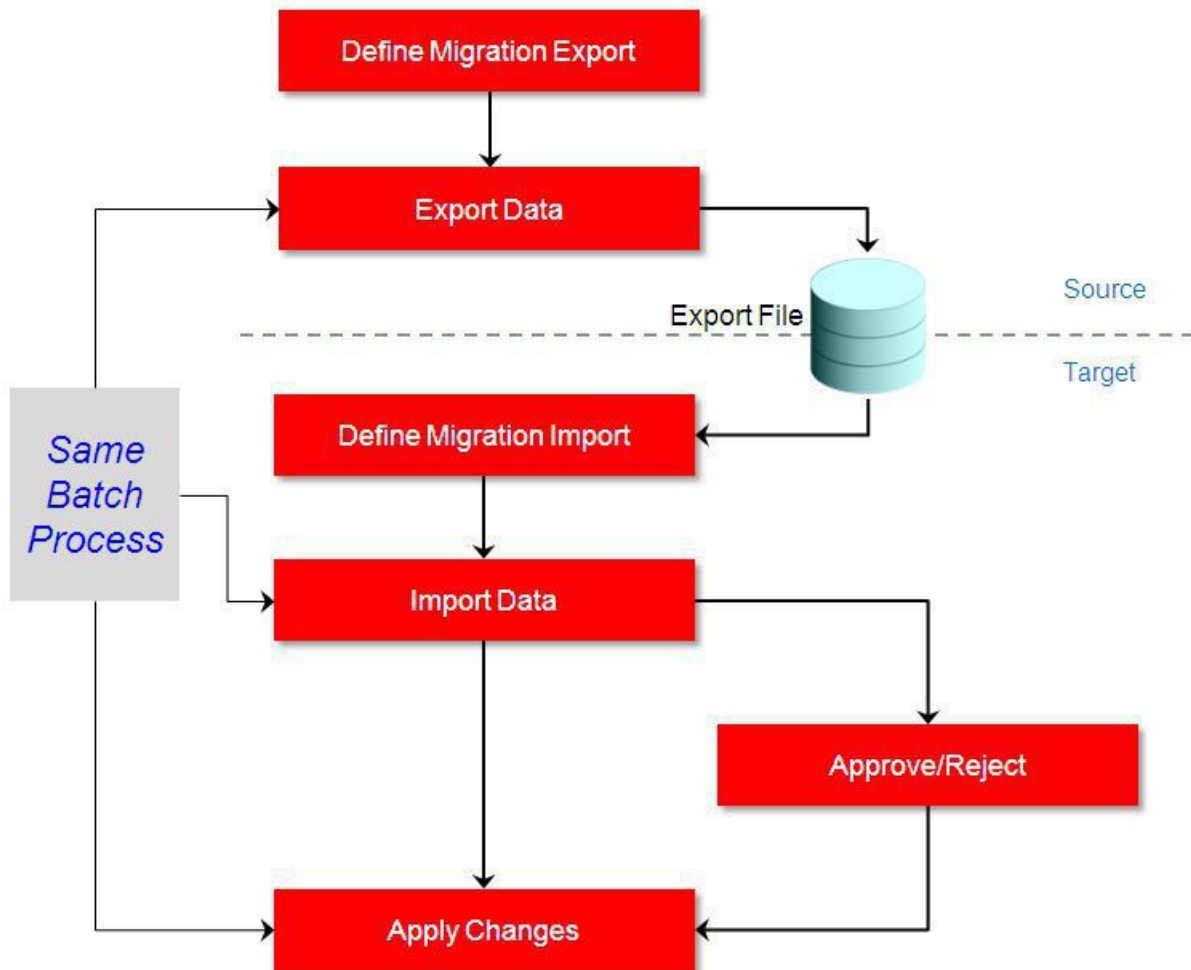

Exporting a Migration

The migration export process begins in the source environment by defining a migration data set, which specifies a defined **Migration Request** and provides a file name and description for the export file. After the data set is defined and saved, the **Migration Data Set Monitor** batch submission can be prepared and run to generate the export file.

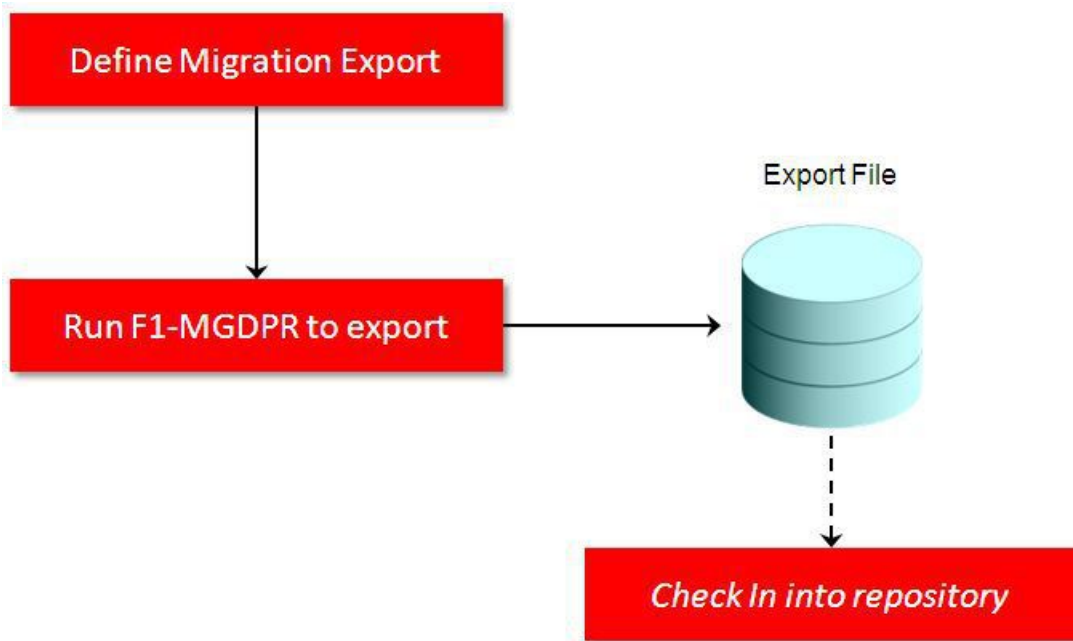

Preparing an Export Data Set

Execution of a defined **Migration Request** is initiated with the creation of a **Migration Data Set Export**. This establishes the export file name and registers the *intent* to export the data as defined in the request.

To define a new export data set, select the **Admin** menu, choose **M > Migration Data Set Export**, then click the **Add** link in the **Migration Data Set Export Query** page. You can also search for the migration Request and click the **Export** button.

The export requires the name of an existing **Migration Request**. You can manually enter a defined request or click the **Search** icon  to locate and load your selection.

Enter a unique **File Name** for the export. Do not use spaces in the name, and do not enter the file extension or a path. The output location and file extension of the intended export file, which should appear in the **Export Directory** and **File Suffix** labels, are established as part of the initial CMA setup. If they don't appear on the data set import screen, you'll need to **Cancel** the operation and return to the [Migration Assistant Configuration](#) screen to add the required global details.

Enter a **Description** of the data set.

The **Source Environment Reference** is populated by default with the URL of the source environment, but can be replaced with any descriptive tag that signals the source of the export (e.g., "Development").

When the data set is complete, click **Save** to reveal the **Migration Data Export Details** summary. The export data set is now registered for processing when the [Migration Data Set Monitor batch process](#) is next run. If for any reason you don't want this export data set included in the next batch submission, you can exclude it by clicking **Cancel** in the summary. The export data set can later be resubmitted for processing by searching on the file name or description in the **Migration Data Set Export Query** page.

Monitoring the Process

The **Migration Data Set Export Details** page lets you monitor the status of an export process.

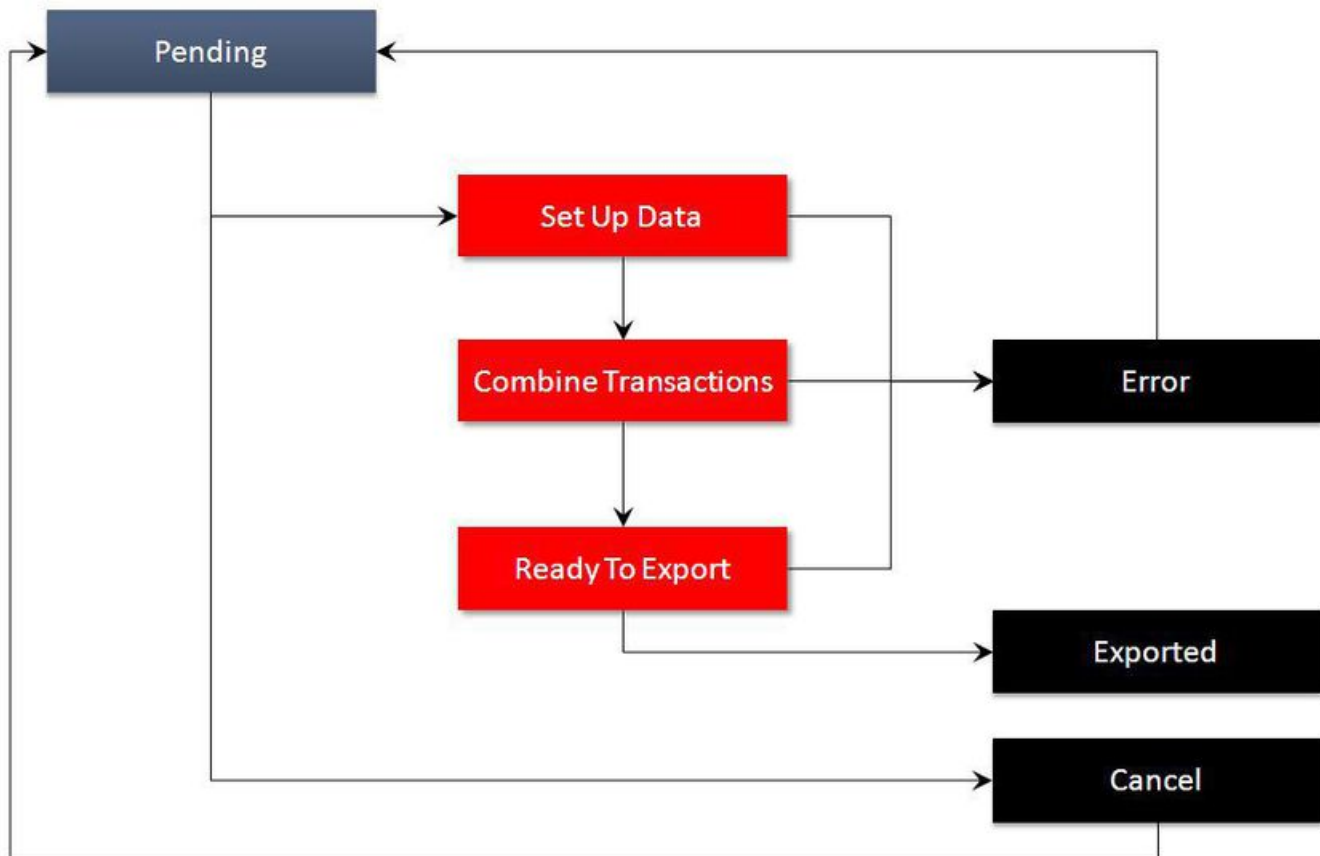

Immediately after a **Migration Data Set Export** is created, the export is marked as **Pending**.

When the data set submission is executed by the **Migration Data Set Monitor** batch process, the specified data is collected, and the objects are grouped together into related transactions so that each transaction can be committed as a set with no validation errors. If an error is detected, the process stops and the status remains at **Pending**; if no errors are detected, the status is set to **Ready to Export**. When the export file is written, the status is set to **Exported**.

To view the process's current state, click the **Refresh** link on the toolbar.

When the process is marked as **Exported**, the export file can be imported into the target system and/or checked in to your version control system for storage and possible future use.

Caution: Under no circumstances should exported data files be edited manually. Doing so could cause data corruption when the file is applied to the target environment.

Running CMA Batch Jobs

This section describes how to prepare and submit batch jobs that use the **Migration Data Set Monitor** process to create all export or import migration data sets that are currently registered for execution.

To open a **Batch Job Submission**, select the **Main** menu, then choose **B > Batch Job Submission**. To specify the **Migration Data Set Monitor** process on the **Batch Job Submission** page, enter F1-MGDPR in the **Batch Code** field, then press **Enter**.

Only two parameters are strictly required for **Migration Data Set Monitor** processing:

- **maintenanceObject**, the MO that is processed by the monitor is automatically entered when F1-MGDPR is loaded. For CMA, this value must remain at its loaded default, **F1-MIGRDS**.

- **DIST-THD-POOL.** This parameter specifies the threadpool that will be executed by the batch. Since the CMA process updates administrative data that is usually read from a cache during batch processing, the threadpool named here must be one with the L2 cache disabled. For instructions on setting up the threadpool, see [Preparing a Threadpool](#) in the "Preparing a Migration" section earlier in this document.

Optional process parameters are:

Parameter	Description
isRestrictedByBatchCode	Restrict to objects already in process by this batch code. Valid values are true and false . Defaults is false .
restrictToBusinessObject	This is an optional parameter to allow you to restrict the Migration Data Sets to a specific Business Object. Values can be F1-MigrDataSetExport (for export only) or F1-MigrDataSetImport (for import only). If left blank, the operation will perform both export and import.
restrictToBOSStatus	On the target platform it is possible to restrict the process to Import , Apply changes, or both. Valid values are: <ul style="list-style-type: none"> • Blank – Process the Migration Data Set Import items that are in Pending and Ready to Apply states. • PENDING - Process the Migration Data Set Exports or Imports that are in Pending state only. This exports or imports the data but does not apply them. • READY2APPLY – Process the Migration Data Set Imports that are in Ready to Apply state only.
maxErrors	This is an optional tolerance for errors. By default this is set to zero (0), which means that the job will not be marked in error unless all records processed have errors. This tolerance sets the number of records marked in error before the whole job is marked in error. In most cases, the default is sufficient. For an in-depth discussion of maxErrors , see the document, "Batch Best Practices for Oracle Utilities Application Framework-based Products" in the My Oracle Support (MOS) Knowledge Base (search article 836362.1). Sign-in is required.

Other Batch Job Submission Controls

Control	Description
Thread Number	Thread number is used to control whether a background processes is run single threaded or in multiple parallel threads. It contains the relative thread number of the process. For example, if the process has been set up to run in 20 parallel threads, each of the 20 instances receives its relative thread number (1 through 20). Refer to Running Multi-threaded Processes for more information about populating this field. <p>Note: Not all processes may be run multi-threaded. Refer to the description of a batch control to find out if it runs multi-threaded.</p>
Thread Count	Thread count is used to control whether a background processes is run single threaded or in multiple parallel threads. It contains the total number of threads that have been scheduled. For example, if the process has been set up to run in 20 parallel threads, each of the 20 instances receives a thread count of 20. Refer to Running Multi-threaded Processes for more information about populating this field.
Batch Rerun Number	Rerun number is only used for background processes that download information that belongs to given run number. It should only be supplied if you need to download an historical run (rather than the latest run).
Batch Business Date	Business date is only used for background processes that use a date in their processing. In Oracle Utilities Customer Care and Billing, for example, a billing

Control	Description
	process can use the business date to determine which bill cycles should be downloaded. If this parameter is left blank, the system date is used at the time the background process is executed.
Override Nbr Records to Commit and Override Max Timeout Minutes	<p>These parameters are optional and override each background process's Standard Commit Records and Standard Cursor Re-Initiation Minutes (each background process's Standard Commit Records/Standard Cursor Re-Initiation Minutes is documented in the list of system background processes). Note that Max Timeout Minutes corresponds to the Cursor Re-initiation Minutes.</p> <p>Fastpath: Refer to Parameters Supplied to Background Processes for more information.</p>
Language	Language code is used to access language-specific control table values. For example, error messages are presented in this language code.
Email Address	<p>If you wish the system to notify you when the batch job is complete, enter your email address here. Refer to Email Notification for more information.</p> <p>Note: This field defaults to the email address for the current user, if populated on the <i>user</i> record.</p>
Desired Execution Date/Time	Defaults to the current date and time. Override this information if you wish the background process to be executed at some future date and time. Refer to Submitting Jobs in the Future for more information.
Batch Job Status	Indicates the current status of the batch job. Refer to Lifecycle of a Batch Job Submission for more information.
Program Name	Name of the program associated with the batch control code is displayed.
Trace Parameters	<p>The following trace parameters may also be checked to be supplied to a background process and are only used during QA and benchmarking.</p> <ul style="list-style-type: none"> • Trace Program Start. Switch on if you wish a message to be written whenever a program is started. • Trace Program Exit. Switch on if you wish a message to be written whenever a program is exited. • Trace SQL. Switch on if you wish a message to be written whenever an SQL statement is executed. • Trace Output. Switch on if you wish a message to be displayed for special information (if any) logged by the background process.

Running the Process

When all required parameters are prepared, click the **Save** link on the banner bar to execute the batch.

Importing and Applying a Migration

The import process is initiated with the creation of a **Migration Data Set Import** to register the *intent* to import the data from an export file. After specifying and saving the data set, the **Migration Data Set Monitor** batch submission can be prepared and executed to create the import file.

The **Migration Data Set Import Details** page is then used to examine individual transactions, allowing rejection where appropriate. When the set is ready, the import is marked as **Ready to Apply** and is applied to the target environment using the **Migration Data Set Monitor** batch submission process to complete the cycle.

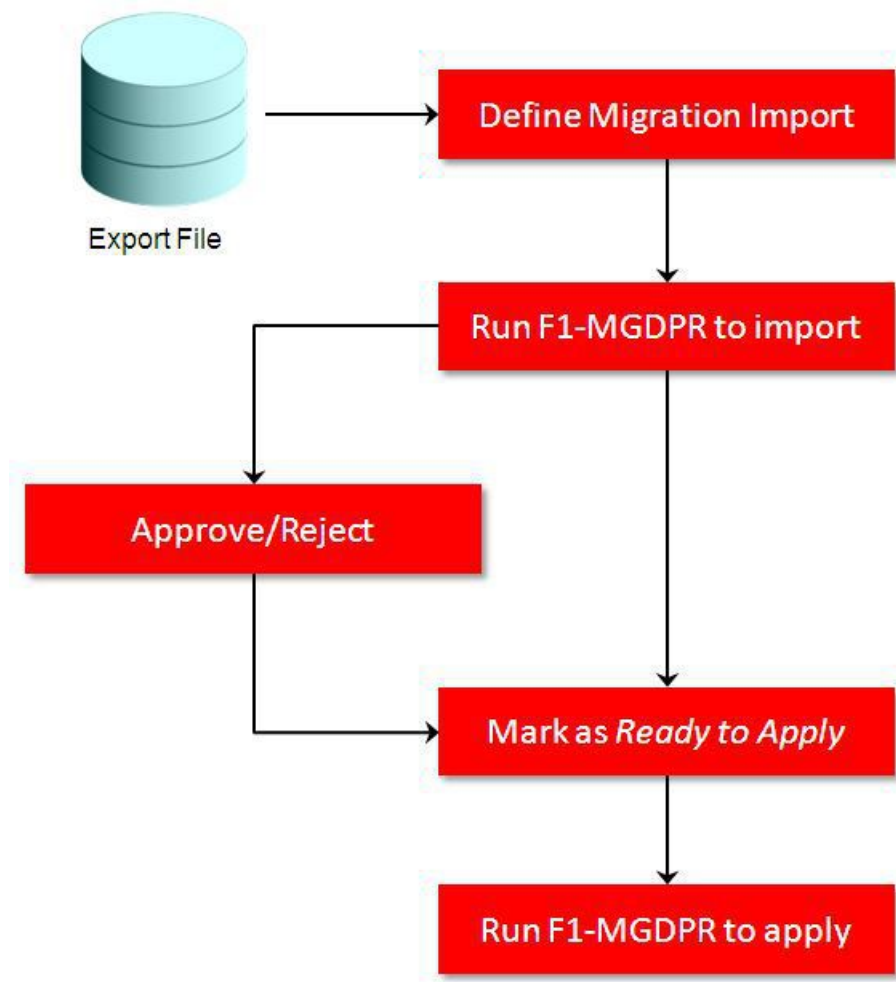

Preparing an Import Data Set

The import process starts with the creation of a **Migration Data Set Import** that registers the *intent* to import data from an existing export file.

To define a new import data set, select the **Admin** menu, choose **M > Migration Data Set Import**, then click the **Add** link in the **Migration Data Set Import Query** page.

The import process requires the name of an existing *export* file, which must be entered manually. Do not enter the file extension or a path. The output location and file extension, which should appear in the **Import Directory** and **File Suffix** labels, are established as part of the initial CMA setup, and will be used as the location for the import data set. If they don't appear on the data set import screen, you'll need to **Cancel** the operation and return to the [Migration Assistant Configuration](#) screen to add these required global details.

The **Default Status for Add** sets the default status for objects that are determined to be *new* during the import comparison process. The default is to automatically set new objects to **Approved** status. Other options are to set any new objects to **Rejected** or **Needs Review** status.

The **Default Status for Change** sets the default status for objects that are determined to be *changed* during the import comparison process. As with new objects, the default for changed objects is **Approved**, with **Rejected** or **Needs Review** options available.

Note: These default status settings can help you distinguish between new and changed objects after the data set is processed. Status for any individual object may be changed when the data set reaches the **Awaiting Approval** state and you perform your review/validation of the objects to be imported

When the data set is complete, click **Save** to reveal the **Migration Data Import Details** summary. The import data set is now registered for processing when the *Migration Data Set Monitor batch process* is next run. If for any reason you don't want this import data set included in the next batch submission, you can exclude it by clicking **Cancel** in the summary. The import data set can later be resubmitted for processing by searching on the file name or description in the **Migration Data Set Import Query** page.

Import Status Transition Flow

The **Migration Data Set Import Details** zone lets you monitor the status of an import process.

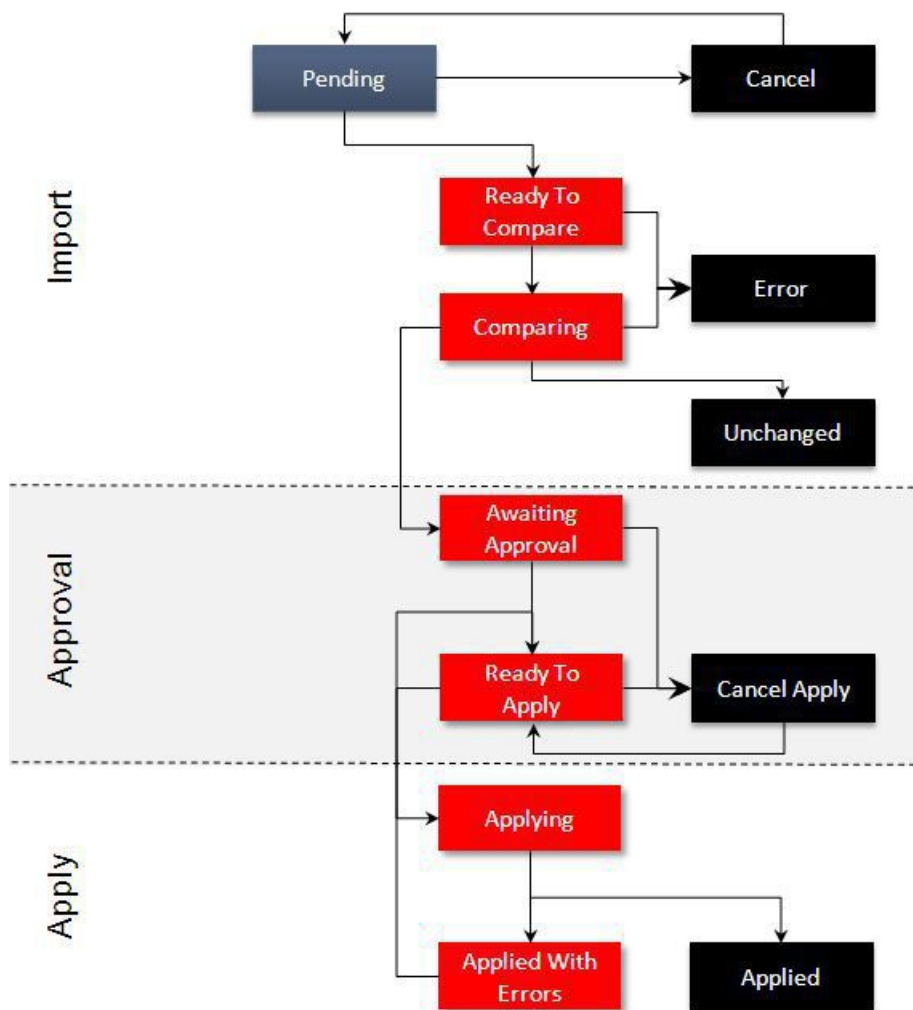

Immediately after a **Migration Data Set Import** is created, the import is marked as **Pending**.

When the data set submission is executed by the **Migration Data Set Monitor** batch process, the import process collects the specified data, runs comparisons, creates a list of instructions, and marks the set as **Awaiting Approval**. If no changes are detected, the data set will be in **Unchanged** status.

To view the process's current state, click the **Refresh** link on the toolbar.

Applying Migration Changes

As noted in the [Import Status Transition Flow](#), you can monitor the status of the import process by periodically refreshing the **Migration Data Set Import Details** page.

When the data set has reached the **Awaiting Approval** state, a list of all objects in the data set becomes available, along with the proposed change status for each. This allows you to review the migration in detail and, by drilling into any objects you select for a state change, transitioning objects to either **Approved** or **Rejected** status. All objects with status **Needs Review** must be transitioned to either **Approved** or **Rejected** status before any changes can be applied.

The page also presents a list of all objects in any transaction in the data set.

When you are satisfied that the import is complete, click the **Ready to Apply** button, then run the **Migration Data Set Monitor** batch process to apply the changes to the target environment.

The process then marks the data set as either **Applied**, which finalizes the import, or **Applied With Errors**.

If the data set status is **Applied With Errors**, you can revisit the **Migration Data Set Import** page to identify and resolve the issue or issues causing the error. To do that, you can use filters to find transactions that are in the **Applied With Errors** state, or sort transactions on the **Status** column (**Applied With Errors** will be near the top of the sorted list). You can also check the transaction's **Log** tab for messages. In most cases the error is either the result of a version number that was changed by another user during the apply process or a validation error. If a validation error is encountered, you can drill into objects to find the specific error.

After resolving any errors, you can reapply the import by clicking the **Ready to Apply** button to position the data set for processing on the next **Migration Data Set Monitor** batch submission.

Note: In some cases, validation errors (such as mnemonic reference validation errors described in "Object Usage Notes" in the [Migration Objects Provided with Framework 4.2.x](#) section) are dependent on the order in which CMA attempts to apply the transactions. When such cases are encountered, you can try reapplying each time the the number of **Applied With Errors** transactions decreases until the import is successfully **Applied**.

Caution: Under no circumstances should data files generated by the batch process be edited manually. Doing so could cause data corruption when the file is applied to the target environment.

CMA Reference

Framework-Provided Migration Objects

Usage Notes

This topic describes usage information relating to migration objects provided for use by CMA in Application Framework 4.2.0 and later. Additional objects are provided by Framework-based products that are CMA-enabled; usage notes for those objects is provided separately in each product's documentation.

You can see all currently available objects and their descriptions by performing a search in the **Migration Plan Query** or **Migration Request Query** pages. To locate Framework-provided PhysicalBO objects, for example, enter F1- in the **Migration Plan** (or **Migration Request**) field and press **Enter**. To locate all available Framework-provided **Primary Instruction BOs** for a Migration Plan, click the **Search** icon  next to that field and enter F1- in the **Business Object Search** window.

Supplementary Framework-provided object usage information is as follows:

- Fields and characteristic types are not migrated with the object unless specifically indicated. The App Service used by an object is migrated only if it is CM-owned. Data specified through alternate formats—such as through Edit Data steps in scripts, referenced in schemas for schema-based objects, or data from mnemonics in zone parameters, etc—are not migrated.
- The F1-Language migration plan should **never** be used in a migration request with other objects. Defined constraints will cause CMA to link all objects with a language table—which is almost all of the system admin data—into one large transaction. Attempting to update and commit all the changes for this one large transaction may cause performance issues and/or out of memory errors. For this reason, this MO has its own migration request, F1-Languages.
- The migration request F1-SchemaAdmin migrates low-level data that is commonly used in schema-based objects.
- The Batch Control object references a User. If this user does not exist on the target system, CMA cannot apply the requested changes.
- If you add new MO and BO option types that use foreign key references to refer to other objects, you must also create custom migration plans and requests to include these referenced objects in the migration plan. This assures inclusion of the referenced objects in the same transaction, and all changes are applied together by CMA. Migration Plans and Migration Requests can easily be duplicated.
- The migration plans provided by CMA migrate scripts, schema-based objects and zones, and, through constraints, some of the associated data associated with them. However, data specified through alternate formats (such as through Edit Data steps in scripts, referenced in schemas for schema-based objects, or data from mnemonics in zone parameters, etc.) are *not* identified and combined in the same transaction. It's important to note that this could cause validation errors during **Apply**, and may require retrying or migrating the additional data separately. See [Applying Migration Changes](#) for a description of how to reapply the import should an **Applied With Errors** result occur.
- There are two migration plans for **Scripts**. The migration plan F1-ScriptOnly migrates just the script and its App Service (provided the App Service is CM-owned). This is intended to be used in the F1-FrameworkAdmin migration request, which migrates all admin objects. The migration plan F1-Script is intended to be used as a Next Migration Plan where needed, and includes most related objects. It does not move FUNCTION objects (which have been deprecated).
- In some cases, only some of the data in a migration object is appropriate to move from one environment to another. For example, if an object includes log tables, the entries in the log should reflect the actions on the object in that system, and will be different between the source system and the target system. If you have a custom Maintenance Object that includes tables you don't wish to migrate (such as a log table), use the Non-Migrated Table option on the MO to specify this table. All child tables for this table will also be ignored during migration.
- Many of the XAI-related objects include references to environment-specific data, and data should be migrated with extreme care. Migration plans are not provided for MOs that contain mostly environment-specific data. Migration plans are provided for other objects, but these plans are not included in the F1-XAI-Admin migration request.
- If your migrateable object includes log tables, you must add your log entity to the characteristic type F1-MGO. You should also mark the log table as a "Non-Migrateable Table" in the Maintenance Object options.

Framework-Provided Migration Requests

Migration Request Name	Long Description
F1-SecurityConfig	This migration request includes all user groups, application services, <i>security types</i> , users, access groups, data access roles, and display profiles.

Migration Request Name	Long Description
F1-GeneralSystemOptions	This migration request includes Framework general system options and configurations.
F1-ToDoTypesAndRoles	This migration request exports all to-do types along with their roles. It does not include the users in those roles.
F1-UserGroups	This migration request exports all user groups (but not any associated security data <i>such as users</i>).
F1-Users	This migration request exports all users, including their user group references. It does not include the user groups.
F1-Languages	This migration request exports only the Language maintenance object. This object should always be migrated alone and not combined with other objects, so it has its own migration request.
F1-SchemaAdmin	This migration request exports the lower level basic objects used in building schemas and maintenance objects. It includes fields, lookups, characteristic types, currency codes, and foreign key references.
F1-FrameworkAdmin	This migration request exports all the major Framework control tables. It includes objects such as business objects, scripts, navigation keys, portals, etc.
F1-XAI-Admin	This migration request exports XAI-related objects. It does not include objects that are very environment-sensitive and may require you to separately create other objects such as JMS and JDBC settings.
F1-MigrationAdmin	This migration request exports migration plan and migration request objects.

Framework-Provided Migration Plans (with Associated Requests)

Migration Plan Name	Included Objects	Usage Notes	Migration Request
F1-Language	"LANGUAGE" MO only.	This MO must not be included in any other migration requests or plans, because it will have the effect of creating the whole export as one transaction with every object that has a language table reference. Since almost every admin object has a language table reference, including it could cause performance issues or out-of-memory errors. For this reason, the MO has its own F1-Languages migration request.	F1-Languages
F1-SecurityType	"SEC TYPE" MO only.	Add SEC TYPE to F1-AppService Migration Plan as well.	F1-SecurityConfig
F1-CharacteristicType	"CHAR TYPE" MO only.		F1-SchemaAdmin
F1-CurrencyCode	"FIELD" MO only.	Add existing migration plan to this migration request.	F1-SchemaAdmin
F1-Field	"FIELD" MO only.		F1-SchemaAdmin

Migration Plan Name	Included Objects	Usage Notes	Migration Request
F1-ForeignKeyRef	"FK REF", "NAV OPT", "NAV KEY" and "ZONE". Next Migration Plan refers to F1-NavigationOption, F1-NavigationKey and F1-ContentZone.	This object also refers to other objects that are not included, such as Fields (though they will be in the same migration request), as well as Tables and Menus (no migration plans for either of these).	F1-SchemaAdmin
F1-Lookup	"LOOKUP" plus a join to the "FIELD" MO based on name.		F1-SchemaAdmin
F1-AlgorithmOnly	"ALGORITHM" MO only.	Used to move algorithms only (not the alg type).	F1-FrameworkAdmin
F1-BatchCtrl	"BATCH CNTL" MO only.	Refers to USER; if this user is not defined on the target system it cannot be applied.	F1-FrameworkAdmin
F1-BusinessObject	"F1-BUS OBJ" MO, plus its App Service, if CM-owned, plus its algorithms, status algorithms, and BO status reasons, plus decoding the FW options to migrate other Framework admin objects, plus the extended lookups.	Does not migrate the maintenance object, and does not migrate the parent, child or lifecycle BO. Similar to maintenance objects, if edge products and/or clients add their own option types that are FK references, they will need to create their own migration plans and requests to include these additional options.	F1-FrameworkAdmin
F1-BusinessService	"F1-BUS SVC" plus its App Service, if CM-owned.		F1-FrameworkAdmin
F1-ContentZone	"CONTENT ZONE" MO plus its App Service, if CM-owned.		F1-FrameworkAdmin
F1-ContextZone	"F1-UI ZONE" MO only.	This is the "many to many" reference for context-sensitive zones. Having this as a separate Migration Plan means you can migrate the many-to-many relationship without necessarily moving the zones or the specific navigation keys.	F1-FrameworkAdmin
F1-Country		Add existing migration plan to this migration request.	F1-FrameworkAdmin
F1-DataArea	"F1-DATA AREA" plus the Extended Data Area that it references.		F1-FrameworkAdmin
F1-DisplayIconRef	"DISP ICON" MO only.		F1-FrameworkAdmin
F1-DisplayProfile		Add existing migration plan to this migration request.	F1-FrameworkAdmin
F1-EnvironmentRef	"ENV REF" MO only.		F1-FrameworkAdmin
F1-ExtendedLookup	"F1-EXT LKUP" MO only.		F1-FrameworkAdmin

Migration Plan Name	Included Objects	Usage Notes	Migration Request
F1-FeatureConfiguration		Add existing migration plan to this migration request.	F1-FrameworkAdmin
F1-GeographicType		Add existing migration plan to this migration request.	F1-FrameworkAdmin
F1-InstallationAlgorithm		Add existing migration plan to this migration request.	F1-FrameworkAdmin
F1-MaintObj	"MAIN OBJ" MO, plus its algorithms, plus the objects that each of its Framework options refer to, if they are FK references.	If edge products and/or clients add their own option types that are FK references, they will need to create their own migration plans and requests to include these additional options.	F1-FrameworkAdmin
F1-ManagedContent	"F1-MAN CONT" MO only.		F1-FrameworkAdmin
F1-MasterConfiguration		Add existing migration plan to this migration request.	F1-FrameworkAdmin
F1-MessageCategory	"MESSAGE"	This migrates a whole message category, not just a single message. Single messages can be included where necessary by using the MO "F1-MESSAGE" instead of "MESSAGE".	F1-FrameworkAdmin
F1-NavigationKey	"NAV KEY" MO plus its App Service, if CM-owned. Plus a join to the Portal table (with Next Migration Plan = F1-Portal).	Used by F1-ForeignKeyRef and F1-NavigationOption.	F1-FrameworkAdmin
F1-NavigationOption	"NAV OPT", plus its three nav keys, plus the script. Next Migration Plan refers to F1-NavigationKey and F1-Script.	Used by F1-ForeignKeyRef.	F1-FrameworkAdmin
F1-PhoneType		Add existing migration plan to this migration request.	F1-FrameworkAdmin
F1-Portal	"PORTAL" plus its content zones via F1-ContentZone, its "TAB-MENU" entry (no nested migration plan), and its service (no nested migration plan), along with its F1-NavigationKey, F1-NavigationOption, Field objects for portal title and tab page titles, and child portals along with the child portals' UI PAGE objects.		F1-FrameworkAdmin
F1-ReportDefinition	Update to include its App Service, if it is CM-owned.		F1-FrameworkAdmin
F1-RequestType	"F1-REQ-TYPE" MO only.	Contains log tables, which should not be migrated.	F1-FrameworkAdmin
F1-ScriptOnly	SCRIPT, plus its App Svc, if CM owned. No other referenced objects.		F1-FrameworkAdmin

Migration Plan Name	Included Objects	Usage Notes	Migration Request
F1-SeasonalTimeShift	"SEAS TM SHFT" MO only.		F1-FrameworkAdmin
F1-ServiceTaskType	"F1-STASKTYPE" MO only.	May refer to BOs that also need to be migrated.	F1-FrameworkAdmin
F1-StatusReason	"F1-STSREASON" MO only.		F1-FrameworkAdmin
F1-TimeZone		Add existing migration plan to this migration request.	F1-FrameworkAdmin
F1-ToDoTypeAndRole		Add existing migration plan to this migration request.	F1-FrameworkAdmin
F1-UIMap	"F1-UI MAP" MO only		F1-FrameworkAdmin
F1-WebService	"F1-WEBSVC" MO, plus its two data areas.	May refer to characteristic types that also need to be migrated. Contains log tables, which should not be migrated.	F1-FrameworkAdmin
F1-WorkCalendar		Add existing migration plan to this migration request.	F1-FrameworkAdmin
F1-ZoneType	"ZONE HDL" MO only.		F1-FrameworkAdmin
F1-JMS-Connection	"JMS CONNECT" MO only.	Refers to a JNDI server entry which must be created separately.	F1-XAI-Admin
F1-OutboundMsgType	"F1-OUTMSGTYP" MO only.		F1-XAI-Admin
F1-XAI-Adapter	"XAI ADAPTER" and its F1-XAI-Format,	Refers to USER, which must exist on the target system. Also refers to the JNDI server entry which must be created separately.	F1-XAI-Admin
F1-XAI-Format	"XAI FORMAT" MO only.		F1-XAI-Admin
F1-XAI-Rule	"XAI RULE" MO only.		F1-XAI-Admin
F1-MigrationPlan	"F1-MIGRPLAN" MO plus its algorithms.		F1-MigrationAdmin
F1-MigrationRequest	"F1-MIGRREQ" MO, plus its algorithms and its F1-MigrationPlans.		F1-MigrationAdmin
F1-ExternalSystem	"NT XID" MO and its F1-OutboundMsgType.	Because this includes things that are environment-specific, and things that are CCB only, it will not be added to any migration request.	N/A
F1-Script	SCRIPT, plus its App Svc, if CM owned, plus its F1-DisplayIconRef, F1-NavigationOption, F1-BusinessObject, and Eligibility Criteria algorithms, and the script to execute for the Perform Script and Transfer Control step types, plus referenced, schema-based objects.	Does not migrate FUNCTION objects. Does not migrate any objects referenced in the edit data area steps.	N/A

Migration Plan Name	Included Objects	Usage Notes	Migration Request
F1-XAI-Receiver	"XAI RECEIVER" MO only.	Because this object contains environment-specific data it will not be included in any migration requests. May require JMS and JDBC settings which must be set manually.	N/A
F1-XAI-RouteType	"XAI RT TYPE" MO only.	Because this object contains environment-specific data it will not be included in any migration requests. May require JMS and JDBC settings which must be set manually.	N/A
F1-XAI-Sender	"XAI SENDER" MO and its route type.	Because this object contains environment-specific data it will not be included in any migration requests. May require JMS and JDBC settings which must be set manually.	N/A

CMA FAQ

This topic answers some frequently asked questions about CMA.

Q.

How do I create a custom Migration Plan or Request from provided Framework-owned objects?

A.

To create a custom Migration Plan from provided Framework-owned plans, open a Migration Plan search (**Admin** menu, then choose **M > Migration Plan**), enter "F1-" into the **Migration Plan** field, and press **Enter**. The list of available plans appears. Choose a plan to define, click the **Duplicate** button, and define the plan per your requirements as described in [Defining a Migration Plan](#).

To create a custom Migration Request from provided Framework-owned requests, open a Migration Request search (**Admin** menu, then choose **M > Migration Request**), enter "F1-" into the Migration Request field, and press **Enter**. The list of available requests appears. Choose a request to define, click the **Duplicate** button, and define the request per your requirements as described in [Defining a Migration Request](#).

Q.

Why do provided Migration Plans use sequencing instructions in increments of 10?

A.

The sequencing numbers applied to plan instructions are used to provide clarity when organizing and viewing the plan's hierarchy. There can be only one primary instruction, and you can apply any sequence number to it, though if you designate it as "99", it will appear in the plan below any subordinates that have a lower sequence number. No matter what sequencing numbers or increments are used, the primary instruction will always be executed first, followed by its children, its children's children, and so on.

Q.

Why doesn't CMA do deletes?

A.

The user defines the migration in CMA, and CMA lets the user know what objects in that migration request are new, changed, or unchanged before the import is applied. To have it also look for objects that exist in the target environment but not in the import data set and mark those for deletion would impact performance—particularly for large data sets—and for relatively little gain, since deletions are not often required in this model and Framework has other functionality for manually deleting unneeded objects.

Chapter 16

Configuration Lab (ConfigLab)

Note: This functionality is not available to every Framework-based product. Oracle recommends that customers using Oracle Utilities Application Framework version 4.2 or later and currently using ConfigLab switch to Configuration Migration Assistant (CMA) for their configuration data migration needs and retain ConfigLab for migration of master and transaction data migration. For details on features and functionality for the new CMA facility, including tips and requirements for moving from ConfigLab to CMA for configuration data migrations, see the [Configuration Migration Assistant](#) section in this document.

Caution: This chapter is intended for users responsible for testing configuration data and performing "what if" analysis in non-production databases.

In order to implement new business practices, users change configuration data. The best way to confirm the system will work as desired is to test the changes using production data before the changes are promoted to production. The Configuration Lab (or ConfigLab) tools exist to support this methodology. Specifically, the ConfigLab tools allow you to:

- Copy data from production to a "test" environment.
- Change the configuration data as dictated by new / different business practices.
- Confirm the changes are correct by using the system's online and batch transactions.
- Approve or reject individual changes.
- Apply the approved changes to production.

The ConfigLab tools have many uses in addition to testing configuration data and promoting the changes to production. For example, the following points describe several ways users of Oracle Utilities Customer Care and Billing can use the ConfigLab tools:

- Problematic customers and bills can be transferred to a "playpen" environment where the system's transactions are used to experiment with potential corrections without affecting production.
- Historical bills are transferred to a "revenue analysis" environment where the revenue team can perform what-if analysis to determine the impact of rate changes on future revenue.
- Business process scripts developed in a "development" environment can be promoted to a "QA" environment where they can be tested thoroughly before being promoted to production.

In sum - the ConfigLab tools can be used to compare and promote data between any two databases.

The topics that follow describe how to use the ConfigLab.

The Big Picture of ConfigLab

The topics in this section describe major concepts that will facilitate your use of the ConfigLab.

Same Word, Two Meanings

We use the term Configuration Lab (or **ConfigLab**) to describe two different things:

- A ConfigLab is a test environment where your organization can experiment with changes to configuration data. For example, you can set up a ConfigLab environment to test changes to the algorithms used to calculate your customer's bills.
- We also use the term ConfigLab to describe the tools used to compare and promote data between databases. For example, you can use ConfigLab tools to promote changes to configuration data in a pre-production database to production.

Pushing and Pulling Data Is Implemented Via Comparing

The following points describe potential uses of the ConfigLab tools:

- You might want to "push" problematic bills to a "playpen" environment where you can experiment with different options to correct them.
- You might want to "push" existing rates from production into a "pre-production" environment where you can experiment with rate changes.
- After you've tested new rates in a "pre-production" environment you can pull them into production.

While the above tasks are very different, they are all implemented using the same philosophy. The following points describe this philosophy:

- In order to transfer data between two environments, you execute a background process to compare the data in a "target" environment with that in a "source" environment. For example, if you want to promote new / changed rates from a "pre-production" environment to production, the background process compares the rates in "pre-production" (the source) with the rates in "production" (the target).
- It should be noted that the comparison is always performed in the "target" environment. To continue with the previous example, you would execute the comparison process in production and you'd indicate you want to compare production with the "pre production" environment.
- The ConfigLab categorizes the comparison results as follows:
 - **Add.** If data exists in the source environment that is not in the target environment, the data is categorized as "add".
 - **Change.** If data exists in the source environment with the same prime key as data in the target environment but with different column values, the data is categorized as "change".
 - **Delete.** If data exists in the target environment that is not in the source environment, the data is categorized as "delete".
- You use the *Difference Query* to view the results of the comparison. This query also allows you to approve or reject the adds, changes and deletes.

- After confirming the results of the comparison are as desired, you run the **CL-APPCH** background process (apply changes) to apply the approved changes to the target environment. This background process is executed in the target environment (just as the comparison process was).

The Compare Process Is Controlled By Metadata

You do not write programs to *compare data in two databases*. Rather, you set up meta-data to define the objects you want to compare. After this set up is complete, you execute background processes to compare the desired object and, if desired, promote the differences.

The following topics describe the meta-data that you set up to define what to compare.

Maintenance Objects Are Composed of Tables

A *maintenance object* is meta-data that defines a group of tables that make up a logical entity. Maintenance object meta-data exists for every object in the system. For example, there is a maintenance object called **USER**. This maintenance object's tables hold the information about your users.

When you submit a background process to compare the tables in two databases, you don't tell the process about the individual tables. Rather, you define the maintenance objects that you want compared and the system uses the maintenance object meta-data to determine the physical tables to compare (note, this is not 100% true, please see *Database Processes Define The MOs To Compare* for the complete story).

Note: These tables comprise a logical transaction. It might be useful to think of a maintenance object as the tables that are committed in a logical transaction whenever the object is added, changed or deleted.

Please notice that the **USER** maintenance object has a single **Primary** table and multiple **Child** tables. This is true of virtually every maintenance object in the system (i.e., all MO's have a single **Primary** table and 0 to many **Child** tables). Each instance of a given maintenance object has a single row on the **Primary** table, and zero or more rows on each **Child** table.

The base package is shipped with all maintenance object and table meta-data populated. You will not have to change this meta-data unless your implementation has introduced new tables.

Database Processes Define The Maintenance Objects To Compare

A *database process* (DB process) is meta-data that defines the group of *maintenance objects* to compare. To be exact, a DB process defines the maintenance objects whose *tables are compared* by a *comparison background process*.

Note: Important! There are many sample DB processes provided in the demonstration database. For information on how to copy a database process from the demonstration database, refer to *How To Copy Samples From The Demonstration Database*.

A DB process has 1 or more maintenance objects; the number depends on what you want compared. For example:

- If you want to promote user information that was set up in a pre-production database to production, the related DB process requires a single maintenance object in it (i.e., **USER**).
- If you want to copy the contents of every object that holds configuration data from pre-production to production, the related DB process would have many maintenance objects (i.e., one for every object that holds configuration data).

When you link a maintenance object to a DB process, the system assumes that you want to compare EVERY row in every table defined on the maintenance object. If this is what you want to do, then you are finished with the DB process

configuration tasks. However, if you want to compare a subset of the rows on these tables, the next section describes additional configuration tasks that must be performed.

DB Process Instructions Limit Which Objects Are Compared

A maintenance object specified on a DB process is referred to as *DB process instruction* (because it contains "instructions" governing the tables AND rows to be compared).

When you create an instruction (i.e., when you link a maintenance object to a DB process), you must define the type of instruction:

- A **Primary** instruction defines a maintenance object that is independent of any other maintenance object on the DB process. A DB process can contain an unlimited number of **Primary** instructions.
- A **Child** instruction defines a maintenance object that is related to a **Primary** maintenance object in some way. A **Primary** maintenance object can reference an unlimited number of **Child** maintenance objects.

An example will help explain the difference. The following DB process is used to compare business process scripts. This DB process has a single **Primary** instruction (**SCRIPT**) and many **Child** instructions (one for each foreign key referenced on the script maintenance object).

	Seq	Description	Maintenance Object	Role	Parent Seq
Rule(s)	10	Script (see Table Rule)	SCRIPT Script, CI_SCR	Primary	0
Instruction	20	Display Icon	DISP ICON Display Icon, CI_DISP_ICON	Child	10 Script, CI_SCR
Instruction	30	Algorithm - Comparison	ALGORITHM Algorithm, CI_ALG	Child	10 Script, CI_SCR
Instruction	40	Algorithm - Retrieval	ALGORITHM Algorithm, CI_ALG	Child	10 Script, CI_SCR
Instruction	50	Navigation Option	NAV OPT Navigation Option, CI_NAV_OPT	Child	10 Script, CI_SCR
Instruction	60	Function	FUNCTION Function MO, CI_FUNC	Child	10 Script, CI_SCR

Figure 6: A DB Process With Six Instructions

Notice that each **Child** is linked to a **Primary** instruction. This means that when the system compares a script, it will also compare the child objects referenced on each script.

If you did not indicate these were **Child** instructions (i.e., they were marked as **Primary** instructions), the system would compare every **Display Icon** , **Algorithm** , **Navigation Option** and **Function** in the system; even those not referenced on a script. In other words, **Child** instructions limit the child object that are compared to those related to its **Primary** maintenance object.

The following topics describe advanced DB process instruction concepts.

Fastpath: Refer to *Defining Database Process Instruction Options* for more information on setting up DB process instructions.

Table Rules Define Which Objects Will Be Compared

If a DB process instruction has no table rules, every instance of the object will be compared when the compare process runs (and this might be exactly what you want to do). However, assume you only want to compare business process scripts whose prime key starts with **CI_**. To do this, you need a "table rule" on the DB process instruction associated with the **SCRIPT** maintenance object. Table rules contain SQL snippets that are incorporated into the WHERE clause into the SQL statement used to select objects. For example, the following table rule will limit the selection of scripts to that that start with **CI_**.

Table Rules	
Table	Override Condition
CI_SCR	#CI_SCR.SCR_CD LIKE 'CI_%'

Figure 7: DB Process Instruction Table Rule

Table rules may be specified on any DB process instruction for any table within the related maintenance object. However, most of the time, they are only specified on a **Primary** DB process instruction's **Primary** table.

Caution: Specifying additional WHERE clauses may introduce inefficient data access. If you are comparing large amounts of data, it's a good idea to compose table rules that are supported by an index.

Note: Inner Joins . If you specify a table rule on a **Child** table within the DB process instruction, that table is joined with its recursive parent tables in the resulting SQL. Use the SQL viewer (a push button on the DB process instruction page) to make sure that the resulting SQL is really what you want.

Fastpath: Refer to [Defining Database Process Instruction Options](#) for more information on setting up DB process instruction table rules.

Criteria Algorithms Also Define Which Objects To Compare

When the background process selects objects to compare, you can optionally have it call a plug-in to further restrict which objects are compared (table rules are the first level of restriction). We refer to these algorithms as "criteria algorithms".

Criteria algorithms are specified on DB process instructions (just as the table rules are). You'd only need a criteria algorithm if the criteria could not be composed using an SQL statement (if you could compose the criteria using an SQL statement, you'd put this SQL in a table rule).

The comparison process passes criteria algorithms the primary key value of the selected maintenance object. These algorithms simply return a **Yes** or **No** value depending on program logic that determines whether the object should be compared. These algorithms are usually defined on a **Primary** DB process instruction, but there is no restriction.

Fastpath: Refer to [Defining Database Process Instruction Options](#) for more information on setting up DB process instruction algorithms.

Processing Algorithms Perform Extra Processing

A DB Process instruction can have from 0 to many **Apply Changes Processing** algorithms. These algorithms perform extra processing when the approved differences are applied to the target database (by running the Apply Changes (**CL-APPCH**) background process). For example, if you were transferring Batch Control objects to production from a test environment, you could use an **Apply Changes Processing** algorithm to set each batch control's run number to the next available value in production (rather than use the last run number in the test environment). When the Apply Changes executes, it simply passes the primary key of each changed object to the algorithm(s). The algorithm can then update the object's data as desired and these changes are committed when the maintenance object is committed to the target environment.

Fastpath: Refer to *Defining Database Process Instruction Options* for more information on setting up DB process instruction algorithms.

A Batch Control Must Exist

A DB process must reference a batch control. This batch job is submitted when you want to compare the maintenance objects defined in the DB process.

By convention, we recommend that you name the batch control the same as the DB process. For example, a DB Process **CI_COPSC** (Copy Scripts) references a batch control **CI_COPSC**. This naming convention is not required; it's recommended to simplify the administration of the batch controls.

To create a new batch control, you must duplicate the batch control **CL-COPDB** provided in the base product, because aside from the batch code and description, all the settings for the new batch control must match the base one.

The Comparison Process Creates Root Objects

When you submit the batch control defined on the DB process, "root objects" are created. A root object is a record that a difference exists between a maintenance object in the source environment and the target environment.

This diagram shows the state transition of root objects:

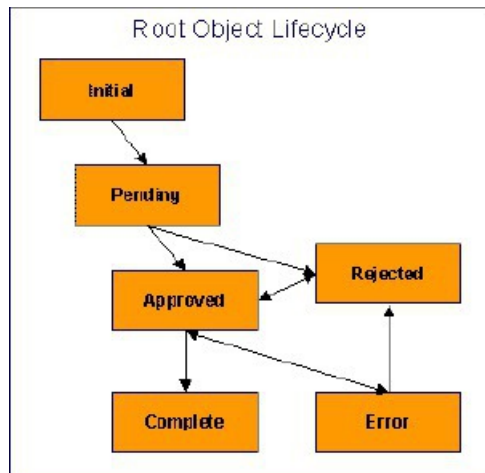

- Both the Initial and Pending states are transitory and should not be visible to end-users.
- The comparison background process puts root objects into either the Approved or Rejected state. You control the value by populate the parameters on the background process accordingly.
- You can manually change a Rejected root object to Approved (and vice versa).
- When you are ready to commit the changes to the target environment, run the apply changes (**CL-APPCH**) background process. This process only processes Approved root object. When a root object is processed, its status is changed to Complete if no problems are encountered (i.e., the change is committed on the target environment). The status of the root object is changed to Error if problems are encountered (e.g., validation fails).
- You can transition an Error object back to the Approved state if you want to reattempt applying the change to the target environment (you must resubmit the Apply Changes (**CL-APPCH**) background process to do this).
- You can transition an Error object to the Rejected state if you want to acknowledge that the change should not be applied to the target environment.

Note: Difference Query. Use the [Difference Query](#) to view the root objects produced by a comparison background process. On this query, you can also change the action of root objects as described above.

Applying Approved Changes To The Target Environment

As described [above](#), you submit a background process to compare the maintenance objects in two environments. This background process creates a "root object" record for every difference between the two environments. You can approve or reject any root object; rejecting a root object means the related difference will not be applied to the target environment.

When the root objects are in the desired state, you submit the Apply Changes (**CL-APPCH**) background process. This process applies all **approved** root objects to the target environment. If you've defined [processing algorithms](#) on the DB process's instructions, it will execute these as the changes are applied to the target environment.

How To Compare Objects In Two Databases

The above sections provided background information about comparing objects in two environments; the following section reiterates this information in step-by-step instructions:

Note: Remember, you always execute the comparison background process from the "target" environment (i.e., the one that will be changed)

- Make sure that an environment reference exists in the "target" database pointing at the source database. This environment reference must be defined as either a [Compare Source or a ConfigLab](#).
- Create a [batch control for the DB process](#) (if one doesn't already exist).
- Create a [DB process](#) to define the maintenance objects to be compared. Make sure to reference the batch control created in the previous step. Also inspect the [DB process instructions](#) to make sure they are consistent with what you want to compare.
- Submit the DB process's batch control.

Note: Time saver. The batch control's context menu has an entry that transfers you to the batch submission page. It also contains an entry that transfers you to the [Difference Query](#) (after the batch job completes).

- After the comparison batch process completes, transfer to the [Difference Query](#) to view the results of the comparison.
 - Approve all changes using the Difference Query.
 - Reject all changes that you don't want applied.
- After the changes are marked as desired, submit the apply changes background process (**CL-APPCH**). After this process completes, return to the Difference Query to check that all of your **approved** changes have become **complete** (this means that the target database has been changed).

Note: Time saver. A simple business process script in the demonstration database can be used to submit the apply changes background process from the [Difference Query](#). It's called **CI_APPCH**.

How To Copy Sample DB Processes From The Demonstration Database

Your product's demonstration database contains sample database processes. These database processes reference logical groups of maintenance objects that many customers compare. For example, the "control table" database process references every maintenance object that holds configuration data.

You may find that these sample database processes closely match your needs. If this proves true, you should copy these from the demonstration database. This will save you time as you won't have to set up the each database process. The topics in this section describe how to copy database processes from the demonstration database.

Note: The following assumes that the demonstration environment has been registered as a **Compare Source** environment for your target environment.

If You Work In A Non-English Language

The demonstration database is installed in English only. If you work in a non-English language, you must execute the **NEWLANG** background process on the demonstration database before using it as a **Compare Source** supporting environment. If you work in a supported language, you should apply the language package to the demonstration database as well.

If you don't execute **NEWLANG** on the demonstration database, any objects copied from the demonstration database will not have language rows for the language in which you work and therefore you won't be able to see the information in the target environment.

Setup A DB Process To Perform The Copy

The base package provides a DB process called **CL-COPDB**. This DB process copies the sample DB processes. This is confusing because you are configuring a DB process in one environment that copies DB processes from another.

This DB process has an instruction that references the database process *maintenance object* (MO). This instruction has a table rule with an override condition that selects the all database processes that are prefixed with **CL_** from the source database (there are numerous sample DB processes in the demonstration database and this process copies them all). If you only want to copy a single DB process, update the *table rule* to only copy the desired DB process.

Note that the DB Process includes additional instructions to copy any algorithms used by the DB process instructions and the associated background processes for each DB process.

Run CL-COPDB and CL-APPCH

After configuring the table rule on the DB processes instruction, submit the **CL-COPDB** background process in your target database. When you submit this process, you must supply it with an *environment reference* that points to the demonstration database. If you don't have an environment reference configured in your target database that references the demonstration database, you must have your technical staff execute a registration script that sets up this environment reference. Refer to *Registering ConfigLab Environments* for more information.

When the **CL-COPDB** process runs, it highlights differences between the DB process in the demonstration database and your target database. You can use the *Difference Query* to review these root objects and **approve** or **reject** them.

After you've approved the root object(s), submit the **CL-APPCH** batch process to change your target database. You must supply the **CL-APPCH** process with two parameters:

- The DB Process used to create the root objects (**CL-COPDB**)
- The environment reference that identifies the source database (e.g., the demonstration database)

Environment Management

When you want to *compare maintenance objects* in two environments, you submit a background process in the "target" environment. When you submit this job, you must define the "source" environment. This environment's data will be compared against the target environment's data. You identify the source environment by supplying an "environment reference code" to the background process.

You must run a utility to create an environment reference as this utility sets up many database synonyms (the comparison process uses these synonyms to access the data in this environment). The topics in this section describe how environment references are created and managed.

Two Types Of Environments

Caution: This section is confusing as it assumes you understand the difference between objects with random number prime-keys versus those that have user-assigned prime keys. If the object has a prime key that's suffixed with `_ID`, this is a random number object; otherwise, it's not.

When you run the utility that creates an environment reference, you must define the type of environment:

- If you want the prime-key values of "random number" objects to be unique across both environments, indicate the environment is a **ConfigLab** .
- If you don't care about the uniqueness of the prime-keys in the two environments, indicate the environment is a **Comparison Source** . If you choose this option and you add entities with system-assigned prime keys, there's a slight chance that your newly added rows will be rejected as duplicates if you promote the additions to the target environment.

Note: Rule of thumb. If you think you're going to add "random number" objects in the source environment and you don't want to risk the system assigning a prime-key that's already used in the current environment, indicate the environment is a **ConfigLab** . Otherwise, indicate the environment is a **Comparison Source**.

Registering Environments

You must run a utility to create an environment reference. Your implementation's database administrator should execute this utility because it performs functions that require administrative access. The following points summarize what this utility does:

- Adds an environment reference object. This object defines the environment's:
 - *Role*
 - Universal *environment ID*
 - **The prefix character used for creating synonyms described below.**
- Creates remote table synonyms in the current environment that reference tables in the environment being referenced. Refer to *Database Users* and *Database Relationships*. The names of these synonyms are the same as the physical table names except the first character is replaced with the environment reference's prefix character. For example, assuming the environment reference's prefix is **Z** , the **CL_SA_TYPE** table in the target environment database is referenced via the **ZI_SA_TYPE** synonym in the current environment.

Note: Note. Registering an environment is a one-time operation. Once the environment is registered, it maintains its role until it is *deregistered*. Also note that if an upgrade or single-fix makes a table change, you must *reregister* all environments.

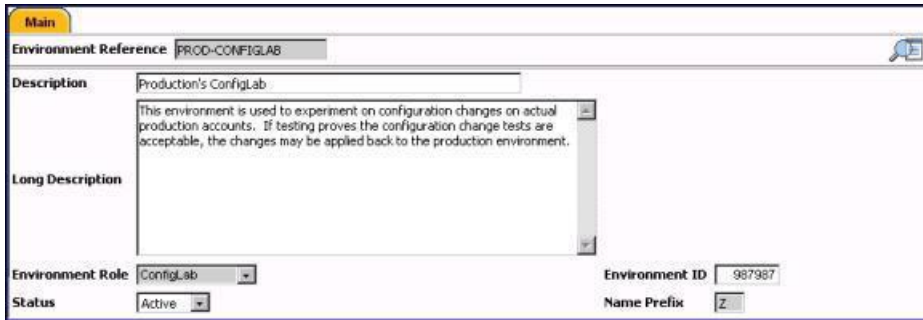

Figure 8: Environment Reference Example

Fastpath: For more information on registering environments, refer to [How To Register a ConfigLab Environment](#). For more information viewing environment references created by the registration utility, refer to [Defining Environment Reference Options](#)

Caution: While it is possible to register multiple **ConfigLab** environments for a given environment, we recommended NOT doing this because there is a slight chance that changes made in one ConfigLab would be overwritten with changes made in another. This warning does not apply to **Compare Source** environments. Refer to [Two Types Of Environments](#) for more information.

Deregistering ConfigLab Environments

You should deregister environments that you no longer plan to compare. When you deregister an environment, the remote table synonyms are removed and the *environment reference* status is changed to **inactive**.

Fastpath: For more information on deregistering environments, refer to [How To Register a ConfigLab Environment](#).

Reregistering ConfigLab Environments

If you deregistered an environment and you need to compare maintenance objects in that environment again, you must reregister it. You must also reregister an environment if you apply a single fix or upgrade that makes a database change.

When you reregister an environment, the *environment reference* status is changed to **active** and the remote table synonyms are updated accordingly.

Fastpath: For more information on reregistering environments, refer to [How To Register a ConfigLab Environment](#).

Database Users

When you install any Framework product, you define a user as the owner of the database schema objects. We'll call this database user **SPLADM**. To use ConfigLab tools, you need to define two additional database users in each environment's database:

- A user with read/write access to the database schema. We'll call this database user **CISUSER**.

- Note that this database user is installed automatically when your product is installed in an Oracle database. For DB2, this database user must be added manually following installation and prior to environment registration. For MS SQL Server this database user is not necessary.
- The application server(s) accessing the environment should be configured to access its database as the **CISUSER** database user.
- A user with read-only access to the database schema. We'll call this database user **CISREAD**.
 - Note that this database user is installed automatically when the system is installed in an Oracle database. For DB2 and MS SQL Server, this database user is not necessary.

Database Relationships

If an environment will be accessed by the ConfigLab tools (either as a source or a target), you must define database relationships between the two environments.

- In Oracle, a database link defines a database relationship. A database administrator must add database links in the "target" and "source" databases as described in the sections below. These database links must be added prior to executing the environment registration utility.
- In DB2, a database relationship is not a database object like it is in Oracle, however the same principles apply. A database administrator must ensure that security is configured to allow the database users in both environments to access remote host schemas as described in the sections below.
- In MS SQL Server, a database relationship is defined with the linked servers. A database administrator must add linked server and SQL Server data source (ODBC) for target and source database server prior to executing registration utility.

The DB2 version of the registration utility grants the privileges to individual remote host schema objects, the Oracle registration utility relies on the privileges associated with database links, whereas the MS SQL Server registration utility doesn't grant any privileges, rather uses fully qualified object name.

The topics in this section describe these database relationships.

ConfigLab Database Relationships

Prior to registering a *ConfigLab* environment, the following database relationships must be configured by your implementation's database administrator:

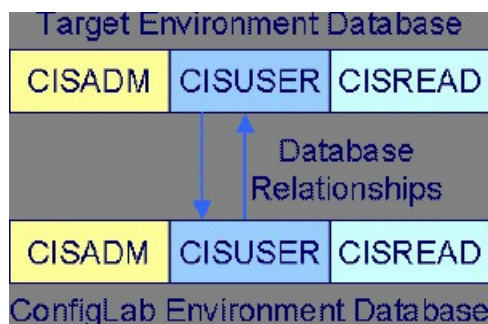

The following topics describe these database links.

From The Target To The ConfigLab

The diagram above shows how a database relationship allows the **CISUSER** database user defined in the target environment to access database objects in the ConfigLab environment's database.

From The ConfigLab To The Target

Remember that when you register an environment as a **ConfigLab**, there is a database relationship from the **CISUSER** schema in the **ConfigLab** environment database that points to the **CISUSER** schema in the target environment. This database relationship allows a subset of tables (i.e., the system-generated key tables) to access the target environment's **CISUSER** schema when generating a key value for a new record.

When a system-generated key value is assigned, the key value is also kept in the table's corresponding "key table" (see [Defining Table Options](#)). Key tables store the environment identifier along with the key value.

The key table in the target environment holds the key values of rows in its own environment plus the key values of rows in the **ConfigLab** environment. This ensures that system-generated keys added in the **ConfigLab** are not used in the target environment.

Compare Target Database Relationships

Prior to registering a [Compare Source](#) environment, the following database relationships must be configured by your implementation's database administrator to match the diagram below:

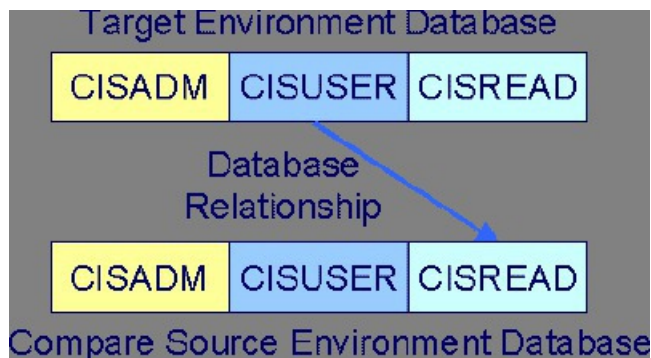

Notice that there is no database relationship originating from the **Compare Source** schema back to the target environment's schema. This is because random keys added in a **Compare Source** are not kept in the target environment's key table (because the system does not guarantee unique keys between a **Compare Source** and a target environment).

Note: In Oracle, the database link defines privileges to the remote database objects. The database link accesses the **Compare Source** database as **CISREAD**. In DB2, the registration utility grants the target environment's **CISUSER** database user read-only access to a **Compare Source** environment's database (a separate **CISREAD** database user defined in the **Compare Source** environment is unnecessary). In MS SQL Server, registration utility uses fully qualified object name to the remote database objects.

The diagram below shows how the script table in a **Compare Source** environment's database is accessed by the target environment using a remote table synonym, prefixed with "R" in this case:

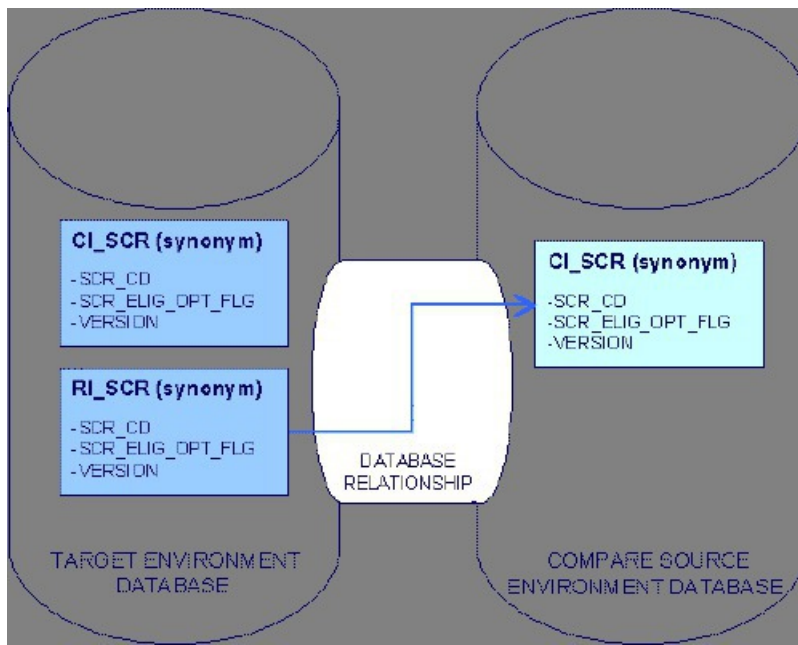

Figure 9: Compare Source Environment Tables Accessed Via Remote Table Synonyms

How To Register a ConfigLab Environment

A database administrator must execute the environment registration utility, as administrative access is required. This utility is also used to deregister and reregister environments.

Note: Oracle, DB2, MS SQL Server Environment Registration . Note that there are three separate versions of the registration utility, one for Oracle, one for DB2 and one for MS SQL Server:

Oracle (EnvSetup)

The registration utility may be executed from any workstation configured to connect to both the supported environment database and the ConfigLab environment database.

In this example, we describe how to register a **ConfigLab** (the same principles apply for **Compare Source** and **Sync Target**). We'll call the supported environment database "CDXPROD" and the **ConfigLab** environment database "CDXCLAB".

A sample file oracle-compare-source.bat is provided with an example for a **Compare Source** registration.

You may specify the following parameters on the command line. If parameters are not supplied, the registration utility prompts for them:

- Information about the supporting environment database:
 - Name of the database
 - Application Schema owner
 - Application Schema user password
 - Database user with read-write privileges to the application schema
 - Database user with read-only privileges to the application schema
- s CDXCLAB,CISADM,{application schema owner password},CISUSER,CISREAD**

- Information about the supported environment database:
 - Name of the database
 - Application Schema owner
 - Application Schema user password
 - Database user with read-write privileges to the application schema
 - Database user with read-only privileges to the application schema

-r CDXPROD,CISADM,{application schema owner password},CISUSER,CISREAD
- Action:
 - I-Install (register), U-Reconfigure (reregister), D-Uninstall (deregister)

-a I
- Environment type of the supporting environment:
 - CMPS-Compare Source, SYNT-Sync Target, CLAB-ConfigLab, ARCH-Archive

-t CLAB
- Environment reference code:
 - The environment reference used to track the ConfigLab environment.

-e PROD-CONFIGLAB
- Name prefix:
 - The prefix character used to reference database tables in the ConfigLab environment. Note that this character must not be C, S, or a name prefix used by an existing supporting environment.

-n L
- Environment description:
 - Description of the environment reference.

-d Production ConfigLab
- Source database link name:
 - Name of the database link from the production database to the ConfigLab environment database.

-x CDXPRODCISUSER-CDXCLABCISUSER
- Target database link name:
 - Name of the database link from the ConfigLab environment database to the production database. Not specified for **Compare Source** or **Sync Target** environments.

-y CDXCLABCISUSER-CDXPRODCISUSER
- Oracle character set:
 - The Oracle character set specified for the production database.

-c {Oracle database character set}
- Apply changes to the databases:
 - Specify this parameter to apply the changes directly instead of writing them to a log file.

-u
- Owner Flag:
 - Specify the Owner Flag for the application.

-o owner flag value

- Log file name:
 - Specify the name of the log file if the parameter above was not specified.
- l {log file name}**

DB2 (EnvSetup)

The registration utility may be executed from any workstation configured to connect to both the production environment database and the ConfigLab environment database.

In this example, we describe how to register a **ConfigLab** environment. We'll call the supported environment database "CDXPROD" and the **ConfigLab** environment database "CDXCLAB".

A sample file DB2-compare-source.bat is provided with an example for a **Compare Source** registration.

You may specify the following parameters on the command line. If parameters are not supplied, the registration utility prompts for them:

- Information about the supporting environment database:
 - Location of the database
 - Database user with SYSADM privileges
 - Password of database user with SYSADM privileges
 - Application Schema owner database user
 - Database user with read-write privileges to the application schema

-s CDXCLAB,{sysadm user},{sysadm user password},CISADM,CISUSER
- Information about the supported environment database:
 - Location of the database
 - Database user with SYSADM privileges
 - Password of database user with SYSADM privileges
 - Application Schema owner database user
 - Database user with read-write privileges to the application schema

-r CDXPROD,{sysadm user},{sysadm user password},CISADM,CISUSER
- Action:
 - I-Install (register), U-Reconfigure (reregister), D-Uninstall (deregister)

-a I
- Environment type of the supporting environment:
 - CMPS-Compare Source, SYNT-Sync Target, CLAB-ConfigLab, ARCH-Archive

-t CLAB
- Environment reference code:
 - The environment reference used to track the ConfigLab environment.

-e PROD-CONFIGLAB
- Name prefix:

- The prefix character used to reference database tables in the ConfigLab environment. Note that this character must not be C, S, or a name prefix used by an existing supporting environment.

-n A

- Environment description:
 - Description of the environment reference.

-d Production ConfigLab

- Apply changes to the databases:
 - Specify this parameter to apply the changes directly instead of writing them to a log file.

-u

- Owner Flag:
 - Specify the Owner Flag for the application.

-o owner flag value

- Log file name:
 - Specify the name of the log file if the parameter above was not specified.

-l {log file name}

MS SQL Server (EnvSetup)

The registration utility may be executed from any workstation configured to connect to both the production environment database and the ConfigLab environment database.

In this example, we describe how to register a **ConfigLab** environment. We'll call the supported environment database "CDXPROD" and the **ConfigLab** environment database "CDXCLAB".

A sample file MS SQL Server-compare-source.bat is provided with an example for a **Compare Source** >registration.

Database security will need to be setup for the utility to register.

Example:

CDXPROD - The database already has a user-id. CDXPRODUSER defined and security has been generated for this user.

CDXCLAB - The database already has a user-id. CDXCLABUSER defined and security has been generated for this user.

For the utility to register database CDXCLAB in database CDXPROD, additional security needs to run.

In database CDXCLAB, add the user CDXPRODUSER:

```
exec sp_adduser ' CDXPRODUSER ',' CDXPRODUSER ','public'
```

Generate security for the user CDXPRODUSER in database CDXCLAB.

Add an ODBC connection on the database server, called CDXCLAB, with login id sa connecting to CDXCLAB.

Add an ODBC connection on the database server, called CDXPROD with login id sa connecting to CDXPROD.

You may specify the following parameters on the command line. If parameters are not supplied, the registration utility prompts for them:

- Information about the supporting environment database:
 - Name of SQL Server data source (ODBC) for the database
 - Password for the sa account
 - Name of the Linked server in the supporting environment

- Name of the database
- Application schema owner database user
 - **-s CDXCLAB,{sa user password},SF-PDNT-032,CDXCLAB,dbo**
- Information about the supported environment database:
 - Name of SQL Server data source (ODBC) for the database
 - Password for the sa account
 - Name of the Linked server in supported environment
 - Name of the database
 - Application schema owner database user
 - **-r CDXPROD,{sa user password},SF-PDNT-022,CDXPROD,dbo**
- Action:
 - I-Install (register), U-Reconfigure (reregister), D-Uninstall (deregister)
 - **-a I**
- Environment type of the supporting environment:
 - CMPS-Compare Source, SYNT-Sync Target, CLAB-ConfigLab, ARCH-Archive
 - **-t CLAB**
- Environment reference code:
 - The environment reference used to track the ConfigLab environment.
 - **-e PROD-CONFIGLAB**
- Name prefix:
 - The prefix character used to reference database tables in the ConfigLab environment. Note that this character must not be C, S, or a name prefix used by an existing supporting environment.
 - **-n A**
- Environment description:
 - Description of the environment reference.
 - **-d Production ConfigLab**
- Apply changes to the databases:
 - Specify this parameter to apply the changes directly instead of writing them to a log file.
 - **-u**
- Owner Flag:
 - Specify the Owner Flag for the application.
 - **-o owner flag value**
- Log file name:
 - Specify the name of the log file if the parameter above was not specified.
 - **-l {log file name}**

Note: When you run a distributed transaction against a linked server in Microsoft SQL Server 2000 on a computer that is running Microsoft Windows Server 2003, the following settings are required for Microsoft Distributed Transaction Coordinator (MS DTC).

- Click **Start** , choose **All Programs** , then choose **Administrative Tools** , then click **Component Services**.
- **In the Component Services Wizard**, expand **Component Services** , then double-click **Computers**.
- Right-click **My Computer** , then click **Properties**.
- Click the **MS DTC** tab, then click **Security Configuration**.
- In the **Security Configuration** dialog box, click to select the **Network DTC Access** checkbox.
- Under **Network DTC Access** , click **Network Transactions**.
- Make sure that **DTC Logon Account** is set to **NT Authority\NetworkService**.
- Click **OK**.
- In the message box, click **Yes** to continue.
- In the **DTC Console Message** dialog box, click **OK**.
- In the **System Properties** dialog box, click **OK**.
- Reboot the computer for these changes to take effect.

Note: Note In some cases, you must start the DTC service before you start the SQL Server service so that the linked server distributed queries work correctly.

Difference Query

When you submit the batch job associated with a comparison DB process, the process saves the differences on the database. We refer to each difference as a "root object". The topics in this section describe the query used to view these differences.

Fastpath: Refer to [The Comparison Process Creates Root Objects](#) for more information.

Difference Query - Main

Use **Admin Menu > Difference Query** to view a summary of the differences between the maintenance objects in two environments.

Description of Page

Batch Control , **Batch Number** , and **Batch Business Date** is the batch run that compared the maintenance objects.

DB Process is the DB process that defines the maintenance objects that were compared.

Environment Reference is the name of the environment whose data was compared against the data in the current environment.

The grid contains a summary of the comparison results:

- **Add.** If a maintenance object exists in the source environment that is not in the current environment, the maintenance object is categorized as "add".
- **Change.** If a maintenance object exists in the source environment with the same prime key as data in the current environment but with different column values, the maintenance object is categorized as "change".
- **Delete.** If a maintenance objects exists in the current environment that is not in the source environment, the data is categorized as "delete".

The summary is further categorized based on the promotion status of the difference. Distinct summary lines are shown for each status value - **All** , **Approved** , **Complete** , **Error** , **Initial** , **Pending** , **Rejected**.

The area above the grid allows you to filter the items that appear in the grid:

- Use **Action** to restrict the summary information based on the comparison category (see above for a list of the categories).
- Use **Status** to restrict the summary information based on the status of the information. Refer to [The Comparison Process Creates Root Objects](#) for a description of each state.

Don't forget to click the search button after changing the filters.

The following points describe each column in the grid:

- Click the adjacent go to button to transfer to the Differences Query tab where the associated root objects can be viewed.
- The **Maintenance Object** column defines the type of maintenance object.
- The **Description** column describes the maintenance object.
- The **Action** column indicates if the maintenance objects are to be Added, Changed or Deleted (note, these actions are only performed if the execute the apply changes background process CL-APPCH).
- The **Status** column indicates the status of the maintenance objects.
- The **Total Root Objects** column displays the number of maintenance objects with this Action and Status for the Batch Control and Batch Number .

Click **Approve All** to set the status of all root objects associated with the Batch Control and Batch Number to **Approved**.

Click **Reject All** to set the status of all root objects associated with the Batch Control and Batch Number to **Rejected**.

Difference Query - Difference Query

The Main tab provides a summary of the differences in the maintenance objects. This tab shows the details of every maintenance object. Use **Admin Menu > Difference Query** and navigate to the 2nd tab to view this information.

Note: Drill-over from the main tab. The easiest way to populate information on this page is to drill over on a row in the summary grid on the Main tab.

Description of Page

Please see the Main tab for a description of the fields in the first section. The following points describe the remaining fields:

- Use Maintenance Object to restrict the root objects in the grid to those related to a specific maintenance object.
- Use Action to restrict the root objects that appear in the grid to those marked with the specified action (**Add** , **Change** , **Delete**).
- Use **Status** to restrict the root objects that appear in the grid to those in a specific state.
- You may also specify unique identifier of the maintenance object to further filter the root objects that appear in the grid. The prompts for the unique identifier differ depending on the selected Maintenance Object .

Don't forget to click the search button after changing the filters.

Click **Select All** to select all root objects currently displayed in the grid.

Click **Clear All** to unselect all root objects currently displayed in the grid.

The grid displays the root objects that correspond to the criteria specified in the filter. The following points describe each column:

- Click the **Select** checkbox to select or unselect a specific root object.
- Click the adjacent go to button to transfer to the [Root Object - Root Object Tree](#) page where the root object can be viewed.
- The **Maintenance Object** column displays the maintenance object associated with the root object.
- The **Description** column describes the maintenance object associated with the root object.

- The **PK Info** column displays primary key of the maintenance object.
- The **Action** column shows the action associated with the root object.
- The **Status** column shows the status associated with the root object.
- The **Primary Root** column displays information about the root object's Primary root object.
- The **Other Roots** column displays whether the root object is associated with more than one maintenance object.

Click **Approve** to set the status of selected root objects to **Approved**.

Click **Reject** to set the status of selected root objects to **Rejected**.

Note: Run CL-APPCH. After approving root object, run the apply changes background process (**CL-APPCH**) to apply the changes to this environment. Don't forget to return to this query to confirm that all of your **Approved** changes have **Completed**.

Root Object

When you submit the batch job associated with a comparison DB process, the process saves the differences on the database. We refer to each difference as a "root object". The topics in this section describe the transaction that shows the details of a root object.

Fastpath: Refer to [The Comparison Process Creates Root Objects](#) for more information about root objects.

Note: Drill-down from the Difference Query. The easiest way to populate information on this page is to drill down from the [Difference Query](#).

Root Object - Main

Use **Admin Menu > Root Object** to view the prime key root objects.

Description of Page

Root Object displays the description of the maintenance object related to the root object including:

- the value of the **Primary key** for the record stored on the **Primary** table associated with the root object's maintenance object,
- the environment reference used as the source of the **Compare** DB process,
- the action assigned to the root object, and
- the root object's status.

Root Object is the unique identifier of the root object.

Maintenance Object displays the code and description of the root object's maintenance object.

Environment Reference displays the code and description of the environment that was the source environment of the comparison.

Action displays the action assigned to the root object by the [comparison process](#).

Status displays the [status](#) assigned to the root object. This field is updateable for root objects in **approved**, **rejected**, and **error** status for the most recent batch run related to the Compare DB process.

Batch Control and **Batch Number** describe the batch run of the **Compare** DB process used to create the root object.

The first grid at the bottom of the page describes the components that make up the value of the **Primary key** of the maintenance object:

Field. The name of a given field that is part of the **Primary key** constraint for the record's table.

Description . The description of the field.

PK Value . Displays the PK field's value.

Constraint Id. Displays the **Primary key** constraint associated with the record's table.

Sequence Displays the order in which the record's field is displayed as part of the **Primary key** constraint.

The second grid describes the DB process instructions that are associated with the root object (as a difference could be highlighted by multiple DB process instructions).

DB process. The name of the **Compare** DB process used to create the root object.

Process Sequence. Along with DB Process , this represents the reference to the DB process instruction that specifies the root object's maintenance object.

Primary Root . The identifier for the root object that groups this root object together with other root objects for processing when changes are applied.

Maintenance Object Description.

This is the description of the maintenance object associated with the Primary Root object.

Level Nbr. An internal level number assigned to the root instruction during the compare.

Root Instruction. The unique identifier of the root instruction.

Root Object - Data Differences

The Main tab provides a summary of the root object. This tab shows the details of tables that will be changed if the root object is approved (and the apply changes background process is run). Use **Admin Menu > Root Object** and navigate to the Data Differences tab to view this information.

Description of Page

Table and Description. The identity of the table that will be changed

PK Value. The row's primary key.

Statement Type. May be **Insert** , **Update** , or **Delete** . This defines the type of SQL statement to be used to change this environment.

SQL. The actual SQL statement to be used to apply changes to the data in the current environment.

Suppress. Check this box if the SQL statement should not be executed when the Apply Changes process runs. This only applies to Insert and Update statements. A Delete statement cannot be suppressed as that could lead to orphaned records in the database.

Root Object - Root Object Tree

This tab provides an alternate view of the information shown on the Data Differences tab. Use **Admin Menu, Root Object** and navigate to the Root Object Tree tab to view this information.

Description of Page

This page displays a tree that shows the details of tables that will be changed if the root object is approved (and the apply changes background process is run).

Root Object Exception

After executing the background process to apply changes to data based on root objects created by a **Compare DB** process, any errors that occur as part of applying the changes are written to the root object exception table.

Fastpath: Refer to *The Comparison Process Creates Root Objects* for more information.

To view the messages associated with the exception records, schedule the **TD-CLERR** background process. This process generates a To Do entry for every record in the root object exception table.

After correcting the cause of the error, navigate to Root Object and change the status to **approved** or **rejected** , and run **CL-APPCH** again.

Chapter 17

Archiving and Purging

Note: This functionality is available only in Oracle Utilities Customer Care and Billing, and Oracle Enterprise Taxation and Policy Management.

The term archiving describes the process of moving selected data from production to an archive environment while maintaining the referential integrity of the overall application.

The term purging describes the process of deleting data from production without storing the data in another environment. Similar to archiving, the purge process must not affect the referential integrity of the application.

The Archiving Engine refers to the tools and infrastructure that are required for archiving and purging production data. The concepts for archiving and purging are very similar, except that purged production data is not transferred to an archive database.

Caution: Technical Chapter! The concepts described chapter do not relate to normal business process. If you are not responsible for managing product databases, skip this chapter.

The Big Picture of Archiving and Purging

As time passes, the amount of data stored in the production database grows. Some tables can become very large and retain seldom-accessed data in the production database. Extremely large volumes of data may impede system performance.

In order to reduce the amount of raw data stored in the production database, a subset of records in the production database can be moved to an archive database, or a purged from the system.

Archiving and purging keeps the volume of data in the production database at a manageable level without compromising the system's ability to perform normal operations.

Note: Production Environment. This document makes many references to the production environment. It is quite possible to archive and purge non-production data, but for the sake of clarity, this document refers to "production" in place of any source environment for archive or purge.

Caution: There are currently no sample processes for restoring archived data. Please make sure you are very familiar with the Archive Engine and sample archive procedures before attempting to archive production data.

Storing Archived Data

When you archive, you move data out of the production environment's database to an alternate Framework environment's database.

How To Run ArcSetup Utility

The utility may be executed from any workstation configured to connect to both the production environment database and the archiving environment database.

In this example, we describe how to setup an **Archive** environment. We'll call the production environment database "ENVPROD" and the **Archive** environment database "ENVARCH".

- Information about production database:
 - Name of Archiving Database
 - System Database user password
 - Application schema owner database user
 - Database user with read only privileges to the application schema**-d ENVPROD,manager,CISADM,CISREAD**
- Action:
 - A-After Archived, B-Before Archiving**-a B**
- DB Process Name:
-p CIARC_BI
- Log file name:
 - This is an optional parameter if not specified the log file will be generated with ArcSetup.log**-l {log file Name}**

Multi-Environment Application

Think of the product as an application that is not bound to a single database instance. To understand ConfigLab concepts, you must think of the product as a collection of environments. An environment is an installed version of the product database, application server and web server.

There is only one environment in the application whose database contains production data. Let's call this the production environment. Other environments exist to support the production environment in various ways. There is no logical limit to the number of supporting environments that may exist within the application.

Environment Roles

The environments supporting production are categorized into environment roles based on their function.

An **Archive** environment is a repository for data that is removed from production.

ConfigLab, **Compare Source**, and **Sync Target** environment roles are discussed in [Configuration Lab](#).

The following illustration depicts a production environment with multiple supporting environments:

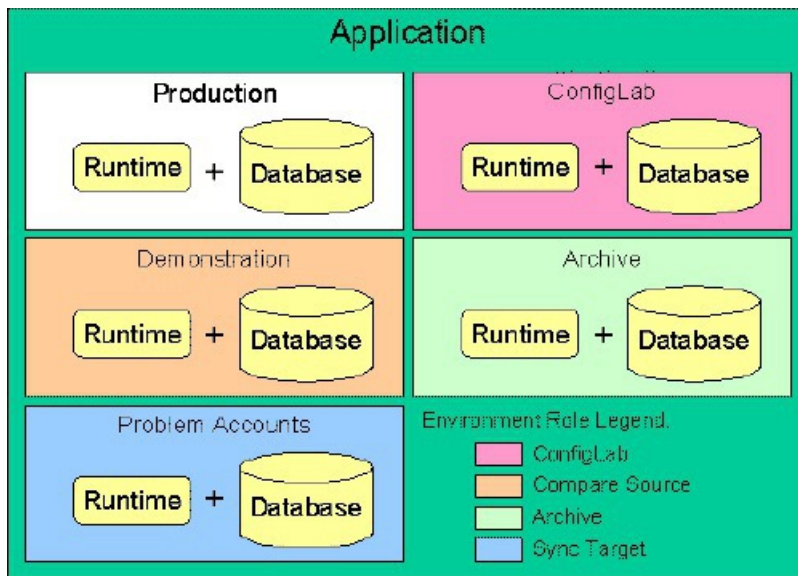

Figure 10: Production with Multiple Supporting Environments

Archive Environment Registration

Archive environments must be registered before they can be utilized. Registering an archive environment involves running an environment registration utility, specifying information about both production and the archive environment being registered. Your implementation's database administrator must execute the registration utility as the utility performs functions on the database that require administrative access.

When using Oracle as your database, you have the choice of configuring the archive database to be in the same Oracle instance (recommended) or a separate Oracle instance. For other databases, separate database instances are required.

The following summarizes the functions performed by the registration utility:

- Adds an environment reference in the production environment specifying the target environment's role (in this case **Archive**), the target environment's universal *environment ID*, as well as a prefix character used for creating synonyms described below.
- Creates synonyms in the production environment database that reference tables in the target environment database over a database relationship. Refer to *Database Users and Database Relationships* below. These synonyms are prefixed with the environment reference's name prefix that is used in place of the "C" in a normal table name. For example, assuming the environment reference's name prefix is **A**, the **CI_BILL** table in the target environment database is referenced via the **AI_BILL** synonym in the production environment database.

Note: Registering a supporting environment is a one-time operation. Once the environment is registered, it maintains its role until it is *deregistered*. Also note that if the system is upgraded or if a single fix is applied, you must *reregister* all supporting environments.

Fastpath: For more information on registering environments, refer to *How To Register an Archive Environment*. For more information on viewing environment references created by the registration utility, refer to *Defining Environment Reference Options*.

Caution: While it is possible to register multiple archive environments within the application, it is not recommended. Spreading archived financial data across multiple databases may cause financial balances to display inaccurately when viewed within an archive environment.

Deregistering an Environment

If you no longer want use a given environment for archive processing, you should deregister it using the registration utility. Deregistering an environment removes the remote table synonyms that were added when the environment was registered and it changes the *environment reference* status to **inactive**.

Fastpath: For more information on deregistering environments, refer to [How To Register an Archive Environment](#).

Reregistering an Environment

If you had previously deregistered an environment reference and you wish to make that environment available for archive processing again, you must reregister it using the registration utility. You must also reregister an environment after upgrading or applying a single fix. Reregistering an environment updates the *environment reference* status to **active** if it was previously inactive and it creates/drops/updates the remote table synonyms.

Fastpath: For more information on reregistering environments, refer to [How To Register an Archive Environment](#).

Database Users and Database Relationships

When an environment is installed initially, a database user is defined as the owner of all the application database schema objects. We'll call this database user **CISADM**. To use the archive engine, two additional database users are necessary for each environment's database:

- Database user with read/write access to the application database schema. We'll call this database user **CISUSER**.
 - This database user is installed automatically when the system is installed in an Oracle database.
 - The application server(s) used to access the production environment should be configured to access the production database as the **CISUSER** database user. This is the default in an Oracle installation. For DB2, this is a manual operation that must be performed manually following installation and prior to environment registration.
- Database user with read-only access to the application database schema. We'll call this database user **CISREAD**.
 - Note that this database user is installed automatically when the system is installed in an Oracle database.
 - The application server(s) used to access the archive environment should be configured to access the archive database as the **CISREAD** database user.

Prior to registering an **Archive** environment, the following database relationships must be configured by your implementation's database administrator to match the diagram below:

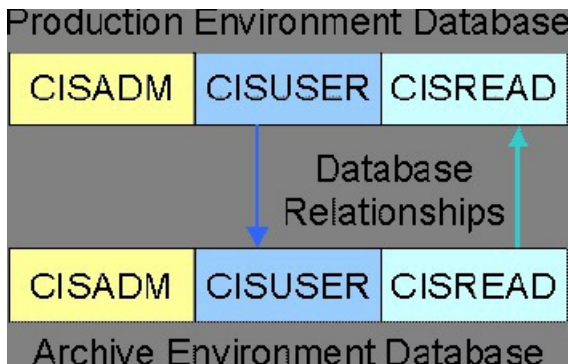

Note: Same Oracle Instance. If you configured your archiving environment to be in the same Oracle instance as your production environment then you don't need to configure a database link.

Notice that the database relationship originating from the production environment's **CISUSER** database schema references the **CISUSER** schema in the archive environment's database. A database relationship originating from the archive environment's **CISREAD** database schema references the master and configuration data in the **CISREAD** schema in the production environment's database.

Archive database processes that are run from the production environment move data into a given archive environment. When the process populates tables in an archive environment's database, the **CISUSER** to **CISUSER** database relationship is used.

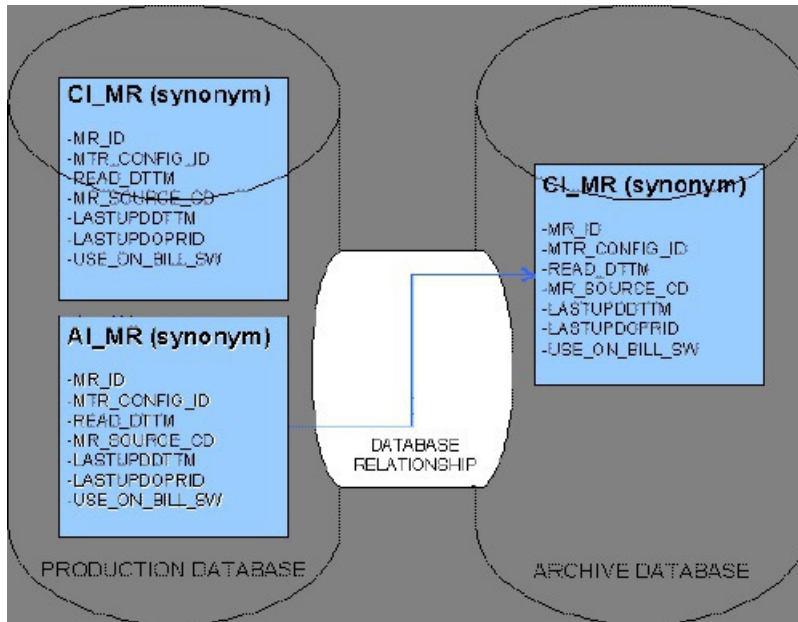

Note: Archiving Data Using Flat Files. As an alternative to archiving data using the database relationships described above, you can move your archive data to flat files and then subsequently import these flat files into your archive environment. For some environments, bypassing the database relationships for the archive step may provide better performance. Refer to [Step 4: Move or Delete Production Data](#) for more information about the background process that archives data to flat files.

Maintaining Data Integrity

Referential integrity of the production database must be maintained after archiving or purging. Imagine if bill records were purged and bill segment records were not. Some bill segment records would reference non-existent bill records in the production database. To effectively archive or purge production data without causing system problems, it is important to understand the system's data model.

Archiving or purging production data requires analysis of table dependencies. When choosing data to archive, a primary production *maintenance object* is selected. All of the table relationships related to the maintenance object must be analyzed. Rules for handling different table relationships during archiving or purging are necessary.

Identifying Relationships

Often parent-child relationships exist between tables. To avoid repeating groups of data stored on one table, a child table is used to store the repeating information. Records on a child table cannot exist without a related parent record. Child tables have identifying relationships with parent tables.

Records on a parent table should be archived or purged along with related records on all child tables. This ensures that child records are not orphaned. This axiom is recursive, as child tables may have child tables of their own.

Suppose that you want to archive meter read data. For each CI_MR (meter read) record that is archived, the related child records in CI_REG_READ (register reading) and CI_MR_REM (meter read remark) tables should also be archived. The following illustrates how register reading records and meter read remark records are related to a parent meter read record.

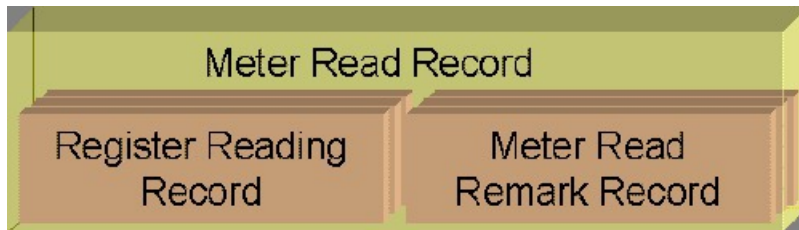

Non-Identifying Relationships

Parent-child is not the only way tables may be related. To minimize database storage requirements, attributes related to a specific entity exist on a single table. Generally tables do not redundantly store data that already exists on another table. Instead, a reference to the table is used. These tables have non-identifying relationships.

Consider a field activity step for reading a meter. The field activity step table does not store the date and time the meter was read, as this information is kept on the meter read table. The field activity step merely contains a reference to the meter read.

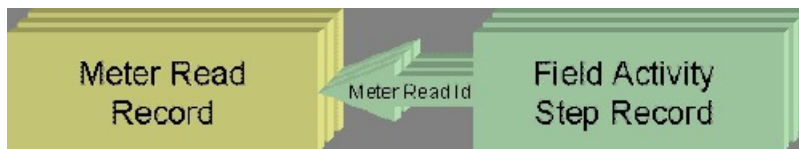

Special consideration must be taken to manage non-identifying relationships during the archiving or purging of production data. Most of the time, the best solution is to use non-identifying relationships as exclusion criteria, but there are exceptions where it is acceptable to allow foreign key references to archived data.

Let's take a look at this from an archive and purge perspective separately:

- Archive processes.
- When data is archived, it is moved from the production environment's database to an archive environment's database. Since the data still exists within the application, references to data moved from production to archive may still be considered valid. The system takes special measures when presenting archived foreign key references. This is considered an inter-database foreign key.

While references to foreign keys outside of the environment's database are sometimes valid, it is still good practice to minimize their occurrences. If you examine the [sample archive processes](#), you will notice that care has been taken to reduce the number of foreign keys that reference archived data.

- Purge processes.
- Dangling foreign key references to deleted records must not be left after a purge process has been executed. After a purge, the data does not exist in any environment, so any reference to the data is invalid.

Inter-Database Foreign Key References

When a system-generated key value is assigned to a record, the system also stores the key value in a key table that corresponds to the record's database table (see [Defining Table Options](#)). Key tables store the universal environment identifier along with the key values.

When data is moved from production to archive, the archived records' related key table records are not deleted from the production database. The key table records are instead updated with the universal environment identifier of the target archive environment. This prevents the system from re-using an archived key value. For example, since field activity steps are allowed to reference archived meter reads, the key values of the archived meter reads cannot be assigned to new meter reads.

Note: Imagine. What would happen if archived key values were re-used? New records added to production might be unwittingly linked to records that were simply preserving their link to archived records.

If the production system encounters a foreign key reference to a record that is not in the current environment's database, it will look up the key value on the record's associated key table to see if the underlying data has been archived. The existence of the key value on the key table satisfies application level referential integrity, because the key of the archived data is still present in the production database. Even though the key is displayed, the description of the object is blank, and any go-to functionality that is normally associated with the key is disabled.

Archive Process Order

To minimize the number of inter-database foreign key references, it is desirable to archive sets of production data in a specific order. Suppose that you wanted to archive meter read data. The `CI_BSEG_READ` (bill segment read detail) table contains non-identifying relationships to the `CI_MR` (meter read) table. Almost every meter read record is referenced on a bill segment read detail record.

Using the sample process for archiving meter reads alone would result in very few meter reads being archived because the sample meter read archiving processes would not allow dangling intra-database foreign key references from bill segment read to register reading. Performing a bill archive prior to performing a meter read archive alleviates this problem.

Cannot Archive Most Meter Reads

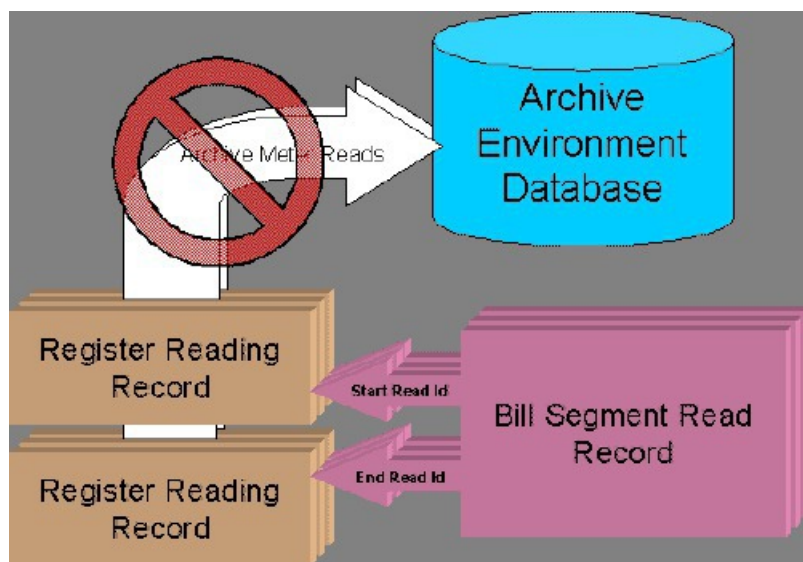

Figure 11: Bill Segment Reads Reference Register Readings

Archive Bills First

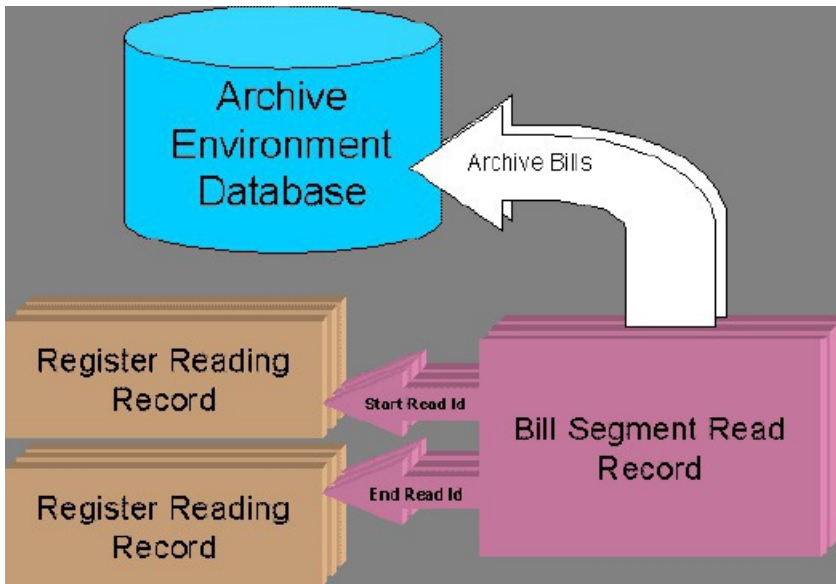

Figure 12: Archive Bills First To Remove References

Now Archive Meter Reads

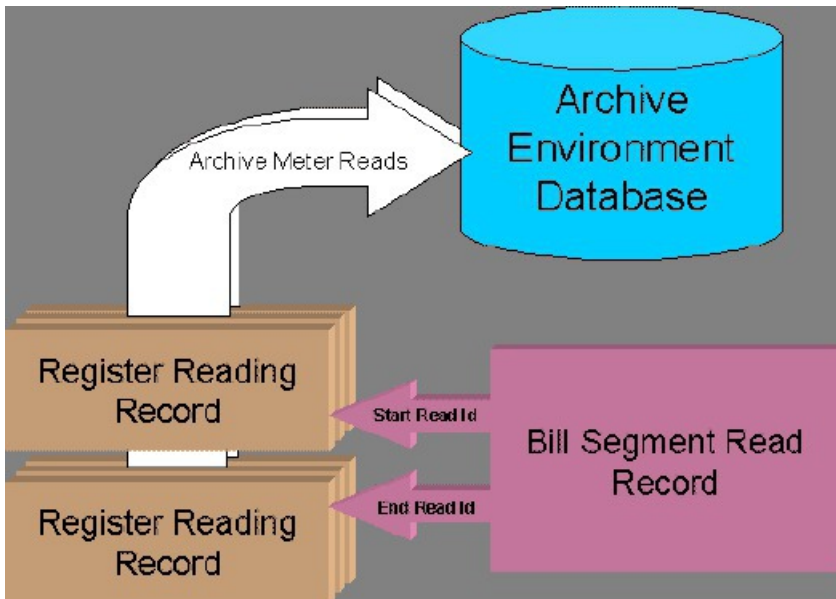

Figure 13: Bill Archive Removed References

Maintaining Normal System Operation

In addition to maintaining referential integrity of the production database, the archiving or purging processes must ensure that critical data is not archived or purged along with non-critical data stored on the same tables. It is important to understand system functionality and business processes to determine impact of archiving or purging production data.

Age of Data

Generally age is a factor in determining which production data to archive or purge. It makes sense to archive or purge older data that is accessed less often than recently added data. When a set of production data is chosen for archive or purge, consider how much of the data is still relevant to maintain normal operations.

Status Of Data

Many tables include a status field or state-identifying switch. These fields are used to track the state transition of a system entity. The system often keys processing or validation off of these status fields. Usually records are added in an initial state, and over time the state changes, eventually reaching some final status. Think of a service agreement moving from **Pending Start** to **Active** to **Pending Stop** to **Stopped** to **Closed**. Records that store data related to system entities controlled by state should generally not be archived or purged unless the system entity is in a final status.

Keys and Relationships

Archiving configuration data that is based on user-defined keys can be problematic. Since configuration tables' keys are user-defined (not *system-generated*), they do not have associated key tables. This means that if you archive configuration data, the system does not validate that the key has been used once it has been moved to an archive environment's database.

Fastpath: For more information on how data based on system-generated keys vs. data based on user-defined keys is handled during an archive, refer to [Step 4: Move or Delete Production Data](#).

Caution: It is possible to contort the archive and purge processes to introduce problems in an archive environment. Let's say that you archived bills with bill calculation headers that referenced a rate version, and then you purged that rate version from production. The archive environment would not have access to the rate version needed to view those archived bills.

Aggregate Summaries

Archiving or purging records from a production data table could affect balances and quantities that are calculated from details. There are various ways to handle these situations, and each situation must be treated individually.

There are very few cases where calculated or stored aggregate summaries exist in the system. The sample archive procedures deal with the most complex instances of aggregate summaries that exist in the system, which are those that deal with financial data.

There are different ways of dealing with aggregate summaries, and they may be used in combination:

- Add a detail record that is representative of a summary of archived or purged detail records.
- Use criteria algorithms to ensure that the removed detail records do not affect normal system operation. For example, if you archive credit rating history, only archive expired credit rating details so that the overall credit rating and cash-only point balances remain the same after an archive or purge.
- Change system functionality to alert users when an aggregate summary has been altered due to a purge or archive. Note that this option should not be necessary.

Fastpath: For more information on how the sample archive procedures deal with aggregate summaries, refer to the processing algorithms associated with the [Sample Archive and Purge DB Processes](#).

Metadata and Archive/Purge Procedures

You configure archive and purge processes using metadata. It is important to understand the following metadata objects in order to configure an archive or purge process.

- **Table.** Defines fields and constraints associated with a table.
- **Constraint.** Defines relationships between tables.
- **Maintenance Object.** Defines tables maintained by page maintenance application service.
- **Database Process.** Defines a group of maintenance objects that are archived/purged together.

Table Constraints Define Relationships

Tables are the metadata that correspond to database tables where records of data are stored in the application. The relationships between tables within the application are defined using constraints.

Unless your implementation has defined custom tables, you are not required to configure tables and constraints used in archiving and purging. All of the table and constraint metadata is populated when the system is installed. The information on tables and constraints is provided as background to make the archiving and purging functions easier to understand.

Constraints are examined during an archive or purge process to ensure that referential integrity is maintained. Intra-database foreign key references are not allowed to "dangle" after any purge or after data based on non-system-generated keys is archived.

Note: Referential Integrity. The constraints examined by purge and archive processes are the same constraints examined by the online system when a delete action is performed.

Below is an illustration of a foreign key constraint defined on the **CI_BSEG_READ** table. This represents one of the bill segment read detail's foreign keys that references a register reading's primary key:



Figure 14: Foreign Key Constraint Example

Fastpath: Refer to [Defining Table Options](#) for more information on viewing a table's constraints.

Maintenance Objects Group Tables

A maintenance object represents a primary table and child tables that are maintained as a logical unit. Each maintenance object has a page maintenance application service (runtime program) responsible for manipulating and validating the primary record and related child records defined in its tables. When records related to a maintenance object are archived or purged, records in the primary table and related child tables are automatically archived/purged at the same time. The system examines the constraints defined on the maintenance object's tables to ensure this is done.

Unless your implementation has defined custom tables, you are not required to configure maintenance objects used in archiving and purging. All of the maintenance objects are populated when the system is installed. The information on maintenance objects is provided as background to make the archiving and purging functions easier to understand.

For example, the bill segment page is responsible for maintaining a **CI_BSEG** record along with its related **CI_BSEG_READ** records, **CI_BSEG_CALC** records, **CI_BSEG_CALC_LN** records, etc. Below is an illustration of the **BILL SEG** maintenance object. Notice that the tables are defined with roles of either **Primary** or **Child**. Also note that the constraint representing the parent-child relationship is also defined for each table.

Table	Description	Table Role	Parent Constraint ID	Comps
CI_BSEG	Bill Segment	Primary		Norm
CI_BSEG_CALC	Bill Segment Calc Header	Child	CI_C0048081	Norm
CI_BSEG_CALC_LN	Bill Calc Line	Child	CI_C0048088	Norm
CI_BSEG_CL_CHAR	Bill Calc Line Characteristic	Child	CI_C0020003	Norm
CI_BSEG_EXCP	Bill Segment Exception	Child	CI_C0048090	Norm
CI_BSEG_ITEM	Bill Segment Item	Child	CI_C0048094	Norm
CI_BSEG_MSG	Bill Segment Messages	Child	CI_C0048097	Norm
CI_BSEG_READ	Bill Segment Register Read	Child	CI_C0048099	Norm
CI_BSEG_SQ	Bill Segment Service Quantity	Child	CI_C0048111	Norm

Figure 15: Maintenance Object Example

Fastpath: Refer to [Defining Maintenance Object Options](#) for more information on viewing maintenance objects.

Database Processes Group Maintenance Objects For A Purpose

More than one maintenance object may be involved in an archive or purge task. A maintenance object only specifies the child tables that are maintained as part of a page maintenance application service. Therefore, multiple maintenance objects may need to be archived or purged together to ensure that records in all parent-child relationships are archived or purged at the same time.

A database process (DB process) allows you to specify a group of maintenance objects that are processed together for a purpose. In addition, you specify the parent-child constraints that link child maintenance object tables with their parent maintenance object tables within the DB process.

The DB process type specifies the purpose. The DB process types used with the [Archive Engine](#) are **Archive** and **Purge**:

- An **Archive** DB process is used to move production data to an **Archive** environment.
- A **Purge** DB process is used to delete production data.

Note: For **Archive** and **Purge** DB processes, one maintenance object acts as the **Primary** in the collection of DB process instructions.

Let's say our DB process purpose is archiving bills that were more than four years old. Not only do you need to archive records in tables defined under the **BILL** maintenance object, you also need to archive the related records in tables defined under the **BILL SEG** maintenance object and the **FT** maintenance object. Note the linkage constraints specified for **BILL SEG** and **FT**.

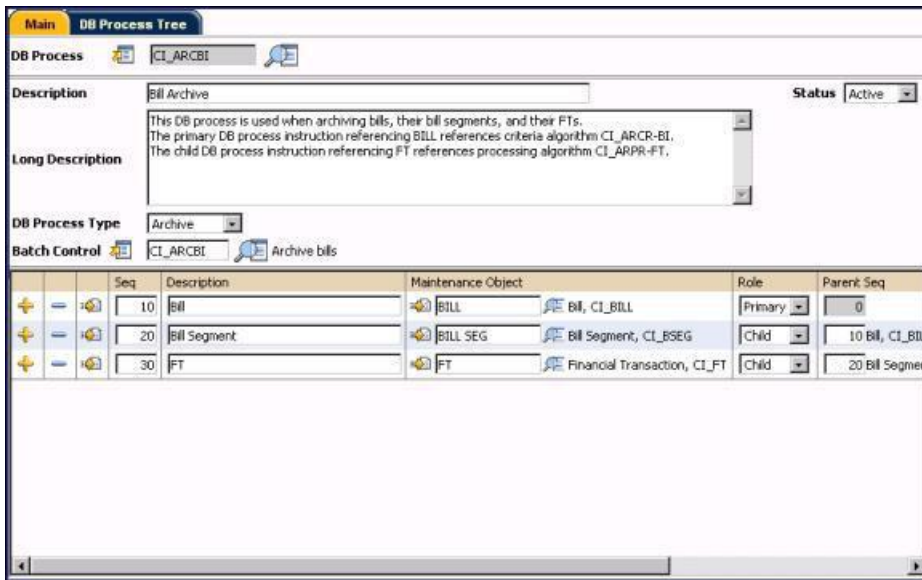

Figure 16: DB Process Example (left side of grid)

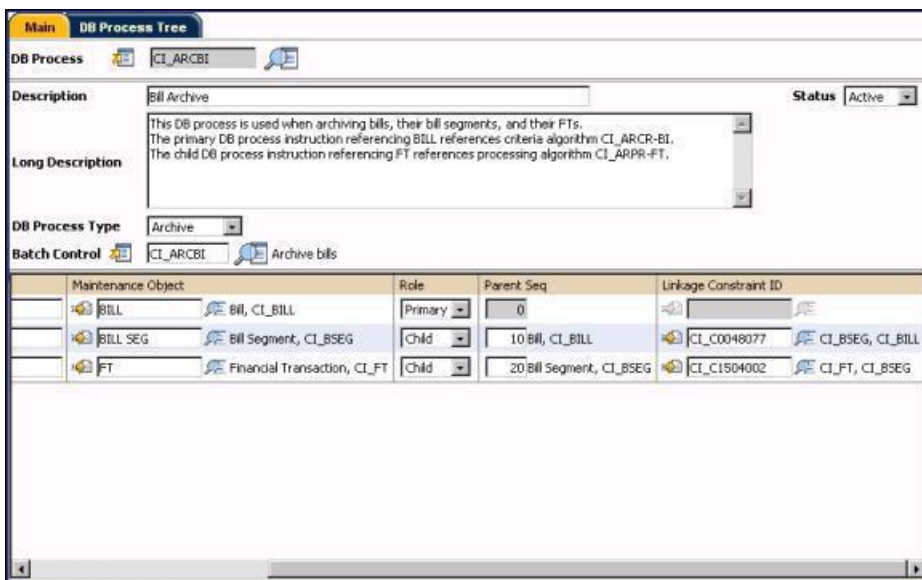

Figure 17: DB Process Example (right side of grid)

Fastpath: Refer to [Defining Database Process Options](#) for more information on setting up database processes.

DB Process Instructions Drive The Process

Each maintenance object specified for a DB process represents a DB process instruction. DB processes instructions used for archive and purge are the metadata that background processes use to build the subset of production data eligible for archive or purge (see [archive root objects](#)). DB process instructions specify exclusion criteria or extra processing that is done when an archive or purge procedure is performed.

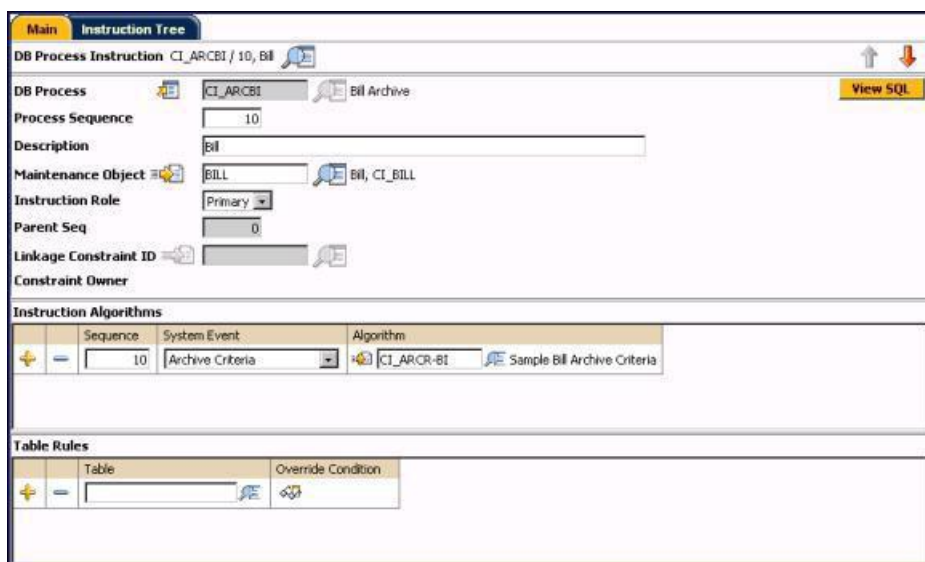

Figure 18: DB Process Instruction Example

Fastpath: Refer to [Defining Database Process Instruction Options](#) for more information on setting up DB process instructions.

Criteria Algorithms Exclude Records

During an archive or purge procedure, background processes are executed to build the subset of production data to be archived or purged. We'll call this set of background processes the *Archive Engine*. When the *Archive Engine* runs, criteria algorithms specified on DB process instructions are executed. Criteria algorithms are supplied with the primary key value of a maintenance object's primary table. These algorithms simply return a **Yes** or **No** value depending on program logic that determines whether the object may be archived or purged. These algorithms are usually defined on a **Primary** DB process instruction, but there is no restriction. When criteria algorithms specified on **Child** DB process instructions return a **No** (do not archive/purge), none of the records associated with the **Primary** DB process instruction nor any of its children are archived or purged.

Fastpath: Refer to [Defining Database Process Instruction Options](#) for more information on setting up DB process instruction algorithms.

For example, an "Archive Bill" DB process includes an instruction algorithm to determine "Bill Archive Criteria". The instruction algorithm's program logic performs queries based on the primary key values of records on the **CI_BILL** table, and returns **No** (do not archive/purge) if any of the following conditions are met:

Age and State

- Bill is less than n days old (n is specified as an algorithm parameter).
- Bill is not complete.
- FTs linked to the bill are not frozen.
- FTs linked to the bill are not redundant.
- FTs for the bill's bill segments are linked to an unbalanced match event.

Relationships

- Pay segment FTs or adjustment FTs are linked to the bill.
- Auto pay clearing staging records exist for the bill.
- Statements exist for the bill.

Table Rules Also Exclude Records

Another way to exclude records from being archived or purged is to set up table rules on a DB process instruction. A table rule's override condition is incorporated into the WHERE clause in the SQL statement that builds the subset of production data for archive or purge when the *Archive Engine* runs. Table rules may be specified on any DB process instruction for any table within that DB process instruction, but are generally specified only on a **Primary** DB process instruction's **Primary** table.

Imagine a table rule specified on the **Primary** DB process instruction for an "Archive Bill" DB process as follows: **#CI_BILL.ACCT_ID <> '2846738204'**. Specifying this table rule prevents the *Archive Engine* from archiving any bills for account 2846738204.

Caution: Table rules are usually not used with archive or purge DB processes. Specifying additional WHERE clauses may introduce inefficient data access. Only consider using a table rule if an index supports the WHERE clause.

Note: Inner Joins. If you specify a table rule on a **Child** table within the DB process instruction, that table is joined with its recursive parent tables in the resulting SQL. Use the SQL viewer to make sure that the resulting SQL is really what you want.

Fastpath: Refer to *Defining Database Process Instruction Options* for more information on setting up DB process instruction table rules.

Processing Algorithms Perform Extra Processing

As their names imply, **Archive Processing** and **Purge Processing** algorithms perform extra processing based on program logic. These algorithms are used to resolve *aggregate summaries*, and may also be used in some cases to set special archive attributes on records where unresolved *non-identifying relationships* result from archiving data. As with *criteria algorithms*, the *Archive Engine* supplies processing algorithms with the primary key value of a maintenance object's primary table when archive or purge background processes are executed.

For example, imagine archiving financial transactions. In this case, when an FT is archived, the following logic should also occur:

- Updates the SA's archive adjustment.
- Updates balance control.
- If the FT is linked to a bill, sets bill's archive flag to **Y**.
- If the FT is linked to a match event, sets the match event's archive flag to **Y**.

A special processing algorithm specified on a **Child** DB process instruction for an "Archive Bill" DB process could perform this logic.

Fastpath: Refer to *Defining Database Process Instruction Options* for more information on setting up DB process instruction algorithms.

Archive Engine

The archive engine is a conceptual metaphor that represents the framework used to archive or purge production data. We can think of the archive engine as a set of generic programs designed to move or delete any data from production.

Archive and Purge Procedures

An archive or purge procedure is a set of processes used to accomplish an archive or purge task. An archive or purge procedure consists of a set of four background processes that are executed in a specific order. Each background process is submitted separately, and has a specific function. An **Archive** or **Purge** DB process specifies a batch control that relates to the first background process that is executed. This is not to say that a different program is required for each **Archive** or **Purge** DB process, as there is one generic program that performs the first step of any archive or purge procedure.

For example:

- The **CI_ARCBI** ("Archive Bill") DB process may specify a batch control called **CI_ARCBI** ("Step 1 of Archive Bills"). The program associated with the **CI_ARCBI** batch control is **CIPYCPRB**.
- The **CI_ARCPY** ("Archive Pay Event") DB process may specify a batch control called **CI_ARCPY** ("Step 1 of Archive Pay Events"), and the program associated with the **CI_ARCPY** batch control is also **CIPYCPRB**.

Note: Batch Controls. The batch controls used for background processes submitted for [Step 1: Create Primary Archive Root Objects](#) are typically named the same as an archive or purge DB process.

The subsequent background processes are also generic programs that perform functions related to a step in any archive or purge task. The same programs are executed for [Step 2](#), [Step 3](#) and [Step 4](#) regardless of the archive or purge DB process. While this concept is confusing, it may become clearer as we look at what each step does.

Note: Separating Procedures. You may prefer to set up separate batch controls for steps [2](#), [3](#), and [4](#) for each **Archive** or **Purge** DB process. While there is slightly more configuration involved, it may be worthwhile in terms of maintaining clear separation of your archive and purge procedures; for example, you may want to keep steps [2](#), [3](#), and [4](#) of an "Archive Bills" archive procedure separate from steps [2](#), [3](#), and [4](#) of an "Archive Pay Events" archive procedure.

The following steps are performed for any archive or purge procedure. Remember that each step in an archive or purge procedure is a separately submitted batch process:

- Create Primary Archive Root Objects
- Build Child Archive Root Objects for Primary Archive Roots
- Check Recursive Integrity
- Move or Delete Production Data

Fastpath: For more information on submitting batch processes, refer to [Online Batch Submission](#).

ArcSetup Preprocessing

A utility called [ArcSetup](#) is provided to maximize performance. Run this as a pre-archive task with action type **B**. This utility generates the DDL for the tables that are associated with archive DB Processes resulting in the scripts `Gen_Index.sql` and `Enable_Pkey.sql`. It then drops indexes and disables primary key constraints for tables associated with archive DB processes.

Step 1 - Create Primary Archive Root Objects

When you submit the first step in an archive or purge procedure, the program attempts to build and store archive root objects. Archive root objects drive the subsequent steps in an archive or purge procedure. Archive root objects represent the subset of production data to be archived or purged. Archive root objects are transient, as they only exist during an archive

or purge procedure. Archive root objects reference the *primary key* value of the **Primary** table of the maintenance object specified on a DB process instruction.

This step creates archive root objects for the maintenance object specified on the DB process' **Primary** DB process instruction. We'll call these **Primary** archive root objects.

Remember:

- A DB process specifies the batch control used to submit the "first step" in an archive or purge procedure.
- A DB process' **Primary** DB process instruction specifies a maintenance object
- A maintenance object specifies its **Primary** table.
- A table specifies its **Primary key** constraint.

Note: Test Mode. You can specify a parameter on the batch control that prevents this background process from actually creating archive root objects. When executed in test mode, this step writes information about the archive root objects to a trace file.

Apply Table Rules

The program applies table rules related to the **Primary** DB process instruction (table rules related to **Child** DB process instructions are applied later). A table rule's override instruction (WHERE clause) prevents archive root objects from being created unless the data meets the condition.

Fastpath: Refer to *Table Rules Also Exclude Records* for more information on setting up table rules.

Execute Criteria Algorithms

As **Primary** archive root objects are being created, the program executes criteria algorithms specified on the **Primary** DB process instruction. The program passes the primary key values of the **Primary** table data of potential **Primary** archive root objects to the criteria algorithms. If a criteria algorithm returns a **false** (do not archive/purge), the program does not create an archive root object for the data.

Fastpath: Refer to *Criteria Algorithms Exclude Records* for more information on setting up criteria algorithms.

Create Archive Root Instructions For Archive Root Objects

For each archive root object stored by this step, the program stores an archive root instruction that links the archive root object and its DB process instruction. An archive root instruction references the archive root object that caused it to be stored and that archive root object's **Primary** archive root object. At this time, the program is creating root instructions for the **Primary** DB process instruction; so a root instruction's **Primary** root object reference and **Child** root object reference are the same archive root object. When we examine how the program creates **Child** archive root objects, it becomes clear that archive root instructions provide a cross-reference of **Primary** and **Child** archive root objects that are processed together as a group.

Step 2 - Build Child Archive Root Objects for Primary Archive Root Objects

The next step in an archiving procedure creates **Child** archive root objects for data related to **Primary** archive root objects with an **initial** status (archive root objects are added as **initial** in *Step 1: Create Primary Archive Root Objects*). Note that this background process processes archive root objects related to the specified **Archive** or **Purge** DB process. You specify the DB process as a parameter on the batch control.

For each **Primary** archive root object, the program creates **Child** archive root objects for data related to **Child** DB process instructions linked to the **Archive** or **Purge** DB process. As with the **Primary** archive root objects built in the previous step,

Child archive root objects reference the primary key value of the **Primary** table of the maintenance object specified on the **Child** DB process instruction.

Apply Table Rules

It would be unusual to include a table rule on a **Child** DB process instruction. If they are specified on any of the **Child** DB process instructions, they prevent archive root objects from being created for the data related to **Child** DB process instructions unless the data meets the conditions specified on a table rule's override instruction (**WHERE** clause). This is unusual because you would most likely create dangling foreign key references by specifying table rules at this level. It may be better to try and prevent the applicable **Primary** archive root objects from being created in the first place.

Fastpath: Refer to *Table Rules Also Exclude Records* for more information on setting up table rules.

Execute Criteria Algorithms

At this time, the program executes criteria algorithms related to the **Child** DB process instructions. As in the previous step, these criteria algorithms prevent archive root objects from being created. The difference is that if a criteria algorithm specified on a **Child** DB process instruction returns **false** (do not archive/purge), the program deletes all of the root objects related to the **Primary** archive root object. This is a fundamental difference between criteria algorithms and table rules specified at this level. Since the archive root objects are deleted, they will not be subject to further processing in subsequent steps. Again, criteria algorithms are generally specified on **Primary** DB process instructions.

Fastpath: Refer to *Criteria Algorithms Exclude Records* for more information on setting up criteria algorithms.

Create Archive Root Instructions For Archive Root Objects

For each **Child** archive root object, the program stores an archive root instruction that links the archive root object and its DB process instruction. The root instruction references the archive root object that caused it to be stored and that archive root object's **Primary** root object. Once the program processes all of the child archive root objects, the archive root instructions provide a cross-reference of **Primary** and **Child** archive root objects that are processed together by subsequent steps.

Step 3 - Recursive Integrity Check

This step in an archiving procedure performs a recursive integrity check on **Primary** archive root objects with a **pending** status (archive root objects were updated to **pending** in *Step 2: Build Child Archive Root Objects*). Again, this background process processes archive root objects related to the specified **Archive** or **Purge** DB process. You specify the DB process as a parameter on the batch control.

If any foreign key constraint specified on a table related to any of the maintenance objects associated with a given **Primary** archive root object or its children references the same table that the foreign key constraint is defined, the program performs a recursive integrity check.

If only one side of a recursive relationship is slated for archive or purge, the program deletes all of the archive root objects related to the root object in question (from the **Primary** root object down). In other words, this is an invalid condition and deleting the archive root objects prevents the corresponding data from being archived or purged by the last step.

If both sides of a recursive relationship are slated for archive or purge, the program updates the **Primary** archive root object references on all archive root instructions involved in the recursive relationship to match the current archive root object instruction's **Primary** archive root object. In other words, the archive root object cross-reference (archive root instruction) is updated so that all of the archive root objects involved in a recursive relationship are archived or purged together.

This is best explained by example:

Suppose that a DB process' purpose is to archive adjustments that are more than four years old.

- *Step 1* of the archive procedure creates applicable **Primary** archive root objects linked to the **ADJ** maintenance object's **Primary** table's primary key values (primary keys of the **CI_ADJ** table).

- *Step 2* propagates **Child** archive root objects (i.e. archive root objects for the **FT** maintenance object).
- *Step 3* examines the production data related to the archive root objects and makes sure that for any **CI_ADJ** record slated for archive, the corresponding **CI_ADJ** record specified by foreign key (**XFER_ADJ_ID**) is also slated for archive.
 - If the corresponding **CI_ADJ** record is not slated for archive, all of the archive root objects and archive root instructions related to the **Primary** archive root object are deleted.
 - Otherwise, the program updates all of the archive root instruction's related to the archive root object being processed, setting their **Primary** archive root object references to match the **Primary** archive root object reference specified on the current root object instruction. This way, all of the archive root instructions reference the same **Primary** archive root object and are processed together in *Step 4: Move or Delete Production Data*.

Note: Rarely performed. There are very few cases where recursive relationships exist in the system.

Step 4 - Move or Delete Production Data

The last step is the one that actually moves the production data into an archive environment, copies it to a flat file, or deletes it (in the case of purge). For step 4, you can select from two background processes: one that moves data to a target archive environment or one that calls an algorithm that moves the data to a flat file. If you archive to flat files, you can subsequently import the files into the archive environment using a database tool. The flat file method may provide better performance in some environments.

Archiving Data Directly to a Target Environment or Purging

The **AR-DCDT** background process loops through the archive root instructions related to **approved** archive root objects (they were set to **approved** in *Step 3: Recursive Integrity Check*). The processing order is by **Primary** archive root object reference, from the lowest level **Child** archive root objects up to the **Primary** archive root object. The program issues a commit after each **Primary** archive root instruction has been processed. If a validation error occurs while processing an archive root instruction, the program deletes all of the archive root objects whose root instructions reference the same **Primary** archive root object.

This background process processes archive root objects related to the specified **Archive** or **Purge** DB process. You specify the DB process as a parameter on the batch control.

Execute Processing Algorithms

If there are processing algorithms associated with the archive root instruction being processed, both programs execute them before the data is deleted. These algorithms resolve foreign key references on production data that reference the subset of data to be archived. They may also resolve *aggregate summaries* (e.g. updating a summary adjustment to maintain a service agreement balance).

Delete Production Data and Root Object

Both programs handle the deletion of production data. **Purge** DB processes are handled differently than **Archive** DB processes.

For a purge:

- The program calls the driver specified on the archive root object's maintenance object to validate intra-database foreign key references.
- If the archive root object's underlying data is not referenced by other data in the environment, the program deletes the underlying production data.
- The program deletes the archive root object and archive root instruction.

For an archive:

- The archive root object's underlying production data is copied to the archive environment's database using the archive environment's synonym prefix and the archive root object's underlying production data is deleted.
- For each table in the archive root object's maintenance object hierarchy that has a key table, the program updates the key value record related to the archived record with the universal environment identifier of the supporting archive environment. Refer to *Inter-Database Foreign Key References*.
- The program deletes the archive root object and archive root instruction.

Archiving Data to Flat Files

The **AR-DCDTF** background process calls an algorithm that copies the data to a flat file then deletes it from the product environment. This background process selects the archive root instructions related to **approved** archive root objects (they were set to **approved** in *Step 3: Recursive Integrity Check*), groups them by their Primary root object, and calls the **Archive Copy Data** algorithm specified on the DB process instruction.

The algorithm copies the records to the path and file specified as parameters to the algorithm. We have provided sample algorithms for archiving meter read data to a file. If you want to use **AR-DCDTF** for other archive jobs, you must develop your own algorithms using *ARCD-MR* as an example. If a validation or other error occurs while writing to the flat file, the program stops execution. You must manually delete the flat files and restart the background process.

This background process processes archive root objects related to the specified **Archive & Copy to File** DB process. You specify the DB process as a parameter on the batch control.

Execute Processing Algorithms and Delete Production Data and Root Objects

After the flat files are written, the background process performs the following steps:

- For each table in the archive root object's maintenance object hierarchy that has a key table, the program updates the key value record related to the archived record with the universal environment identifier of the supporting archive environment. This is the archive environment into which you should subsequently load the flat files. Refer to *Inter-Database Foreign Key References*.
- If there are processing algorithms associated with the archive root instruction being processed, both programs execute them before the data is deleted. These algorithms resolve foreign key references on production data that reference the subset of data to be archived. They may also resolve *aggregate summaries* (e.g. updating a summary adjustment to maintain a service agreement balance).
- The program deletes the archive root objects and archive root instructions for the DB process.

ArcSetup Post Processing

Run the *ArcSetup* utility as a post-archive task with action type **A**. This utility

- Drops the synonyms in the schema with read only privileges to the application schema (for example the ARCREAD schema) for the tables that are associated with the archive DB processes
- Generates synonyms in the schema with read only privileges that reference master and configuration tables in the production environment
- Logs on to SQLPlus as the application schema owner and execute scripts: Gen_Index.sql, Enable_Pkey.sql

Lifecycle of an Archive Root Object

This diagram shows the state transition for an archive root object. Note that archive root objects only persist during the execution of an archive procedure.

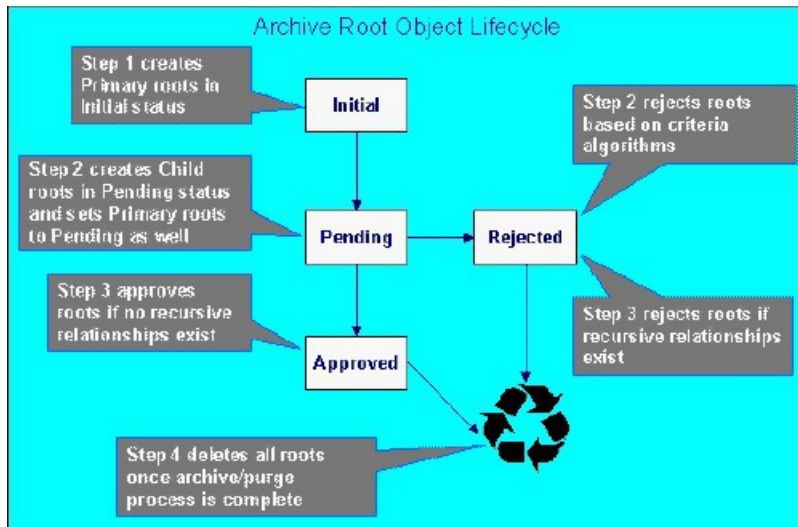

Figure 19: Archive Root Lifecycle

Developing Archive and Purge Procedures

The topics in this section describe how to design and develop new archive and purge procedures.

Caution: Designing and developing new archiving procedures requires thought. Become familiar with the sample archiving procedures before attempting to develop your own.

Configure Metadata

When designing an archive or purge procedure, choose a primary maintenance object to archive. If you have added custom tables and maintenance objects, make sure they have been configured with all relevant constraints. When configuring DB processes, remember that parent records should be archived or purged with all of their children even when they cross maintenance object boundaries. Constraints linking maintenance objects are very important.

Fastpath: Refer to *Database Processes Group Maintenance Objects* for more information on setting up DB processes for archive or purge.

Design and Develop Criteria Algorithms and Table Rules

Since you want to process only a subset of production data, you need to determine exclusion criteria and put the logic into criteria algorithms or table rules. Remember the general rules for determining subsets of data to archive or purge:

- Archive or purge older data.
- Archive or purge data in its final status.
- Archive data based on system-generated keys.
- Minimize intra-database dangling foreign key references.
- Be careful when purging configuration data.

Even though during a purge foreign key checking is performed in [Step 4: Move or Delete Production Data](#), you may consider reducing the number of eligible **Primary** archive root objects created by [Step 1: Create Primary Archive Root Objects](#) with criteria algorithms to reduce overall processing time.

Fastpath: For ideas on how to avoid creating extraneous **Primary** archive root objects during an archive or purge, refer to [Sample Archive and Purge DB Processes](#).

Design and Develop Processing Algorithms

If any of the tables are involved in an [aggregate summary](#), you may need to write a processing algorithm that inserts summary records to represent the deleted detail records. The logic for these programs depends heavily on the type of [aggregate summary](#). Often you can avoid these situations by limiting the set of archived or purged data.

For example, if you were to choose to archive credit rating history records, use a [criteria algorithm](#) that returns **false** if the credit rating history is not expired. Since expired credit rating history records do not contribute to the aggregate summary, it is not necessary to develop a processing algorithm.

Fastpath: For examples of archive processing algorithms, refer to [Sample Archive and Purge DB Processes](#).

Design and Develop Archive Copy Processing Algorithms

If you are [archiving production data to flat files](#), you need to write the archive copy data algorithms that writes the archived data to flat files. If you intend to reload the flat files into an archive environment, your algorithms should be written to structure the flat files so that they can be easily imported using your DB tools.

Sample Archive and Purge DB Processes

This section describes the archive and purge DB processes that exist in the demonstration database. We have provided sample **Archive** and **Purge** DB processes for the most complex high-volume transaction data. It may be useful to copy these DB processes from the demonstration database. Refer to [How To Copy Samples From The Demonstration Database](#).

Because of the logic in the criteria algorithms used to minimize the number of inter-database foreign key references, sample archive procedures should be performed in the order they appear in this document.

Fastpath: For more information on the execution order of sample archive processes, open the help index and navigate to the index entry labeled **background processes / system processes - archive and purge**.

How To Register an Archive Environment

A database administrator must execute the environment registration utility, as administrative access is required. This utility is also used to deregister and reregister environments.

EnvSetup Registration Script

The EnvSetup registration script provides two options for archiving.

Production and Archive Environments on Separate Oracle Instances

In Oracle Utilities Customer Care and Billing V231, the registration scripts initially create synonyms for all application objects in the archive database pointing to master and configuration data in the production schema using a CISREAD to CISREAD relationship.

Production and Archive on the same Oracle Instance

In current versions of the application framework, the support for archiving has been extended to allow for two schemas within the same Oracle instance.

Since both Production and Archive schema's data is being processed within the same Oracle instance, the configuration eliminates data processing over database link and improves performance for the archiving process. The following diagram illustrates the relationship between Production and Archive schemas.

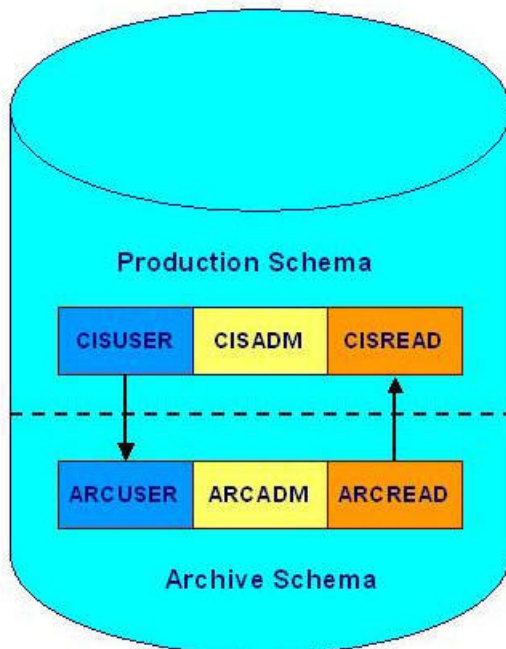

Production and archive on the same Oracle instance

Notice that the database relationship originating from the production **CISUSER** schema references the **ARCUSER** schema in the archive schema. A database relationship originating from the archive **ARCREAD** schema references the **CISREAD** in the production schema. Archive database processes that are run from the production environment move data into a given archive environment. When the process populates tables in an archive schema, the **CISUSER** to **ARCUSER** database relationship is used.

Since most application objects in a given archiving schema access an archive environment's data under its **ARCREAD** schema. This implies that an application server and web server must be installed and configured to reference the **ARCREAD** schema, not the **ARCUSER** schema.

In this example, we describe how to register an **Archive** environment. We'll call the production environment database "CCBPROD" and the **Archive** environment database "CCBARCH".

You may specify the following parameters on the command line. If parameters are not supplied, the registration utility prompts for them:

- Information about the production environment database:
 - Name of the database
 - System database user password
 - Application schema owner database user
 - Database user with read-write privileges to the application schema
 - Database user with read-only privileges to the application schema
 - **-r CCBPROD,{system password},CISADM,CISUSER,CISREAD**
- Information about the supporting environment database:
 - Name of the database
 - System database user password
 - Application schema owner database user
 - Database user with read-write privileges to the application schema
 - Database user with read-only privileges to the application schema
 - **-s CCBARCH,{system password},CISADM,CISUSER,CISREAD**
- Action:
 - I-Install (register), U-Reconfigure (reregister), D-Uninstall (deregister)
- **-a I**
- Environment type of the supporting environment:
 - CMPS-Compare Source, SYNT-Sync Target, CLAB-ConfigLab, ARCH-Archive
- **-t ARCH**
- Environment reference code:
 - The environment reference used to retrieve information about the supporting environment from the production environment.
- **-e PROD-ARCHIVE**
- Name prefix:
 - The prefix character used to reference database tables in the supporting environment from the production environment. Note that this character must not be C, S, or a name prefix used by an existing supporting environment.
- **-n A**
- Environment description:
 - **-d Production Archive Environment**
- Source database link name:
 - Name of the database link from the production database to the supporting environment database.
- **-x CCBPRODCISUSER-CCBARCHCISUSER**
- Target database link name:
 - Name of the database link from the supporting environment database to the production database. Not specified for **Compare Source** or **Sync Target** environments.
- **-y CCBARCHCISREAD-CCBPRODCISREAD**
- Oracle character set:
 - The Oracle character set specified for the production database.

- **-c {Oracle character set}**
- Apply changes to the databases:
 - Specify this parameter to apply the changes directly instead of writing them to a log file.
- **-u**
- Log file name:
 - Specify the name of the log file if the parameter above was not specified.
- **-l {log file name}**

ArcSetup

The ArcSetup utility is provided to configure pre-archive and post-archive tasks for an archive environment.

Pre-Archive Tasks

The utility performs the following tasks if the action type is "B":

- Generates the DDL for the tables that are associated with DB Process
 - Gen_Index.sql
 - Enable_Pkey.sql
- Drops the indexes and disables any primary key constraints for the tables that are associated with DB Process

Post-Archive Tasks

The utility performs the following tasks if the action type is "A":

- Drops the synonyms for the tables that are associated with the DB Process in the schema with read only privileges to the application schema
- Logs on to SQLPlus as the application schema owner and executes scripts: Gen_Index.sql, Enable_Pkey.sql

Executing ArcSetup

The utility may be executed from any workstation configured to connect to both the production environment database and the archiving environment database.

In this example, we describe how to setup an **Archive** environment. We'll call the production environment database "CCBPROD" and the **Archive** environment database "CCBARCH".

- Information about production database:
 - Name of Archiving Database
 - System Database user password
 - Application schema owner database user
 - Database user with read only privileges to the application schema

-d CCBPROD,manager,CISADM,CISREAD

- Action:

- A-After Archived, B-Before Archiving

-a B

•

- DB Process Name:

-p CIARC_BI

- Log file name:

- This is an optional parameter if not specified the log file will be generated with ArcSetup.log
-l {log file Name}

Performance Tuning Tips For Archive

- Generate database statistics prior to running the archive DB process
- Execute ArcSetup to drop the indexes for the table that are being archived by the DB process
- After moving the data from production to archive, generate the database statistics in both Production and Archive environments
- If the Production and Archive schemas are setup in the same Oracle Instance, extra care needs to be taken for configuring the instance parameters, SGA, distributing data files across multiple disks/disk controllers. Also, archive jobs are resource intensive and need to be scheduled during off production hours
- Database activities need to be monitored for archival job #3; performance can be improved if the recursive reference indexes would be created for the duration of archiving run on production tables. Execute the following SQL in order to retrieve the list of tables/columns for the DB process. Please note that any custom indexes can only be useful for archiving jobs, they can be overheads for non-archiving jobs

```
SELECT DISTINCT   DI.MAINT_OBJ_CD,
MO.TBL_NAME,
CF.CONST_ID,
CF.SEQ_NUM,
CF.FLD_NAME
FROM CI_DB_INSTR DI,
CI_MD_MO_TBL MO,
CI_MD_CONST CO,
CI_MD_CONST_FLD CF
WHERE DI.DB_PROC_CD = <input DB Process Code>
AND MO.MAINT_OBJ_CD = DI.MAINT_OBJ_CD
AND CO.TBL_NAME = MO.TBL_NAME
AND CO.REF_CONST_ID IN (SELECT C2.CONST_ID FROM CI_MD_CONST C2 WHERE C2.TBL_NAME = CO.TBL_
NAME)
AND CO.CONST_ID = CF.CONST_ID
AND CO.CONST_ID NOT IN (SELECT MDT.PRNT_CONST_ID FROM CI_MD_MO_TBL MDT WHERE MDT.MAINT_
OBJ_CD = MO.MAINT_OBJ_CD)
AND CO.CONST_ID NOT IN (SELECT DPP.LNKG_CONST_ID FROM CI_DB_INSTR DPP WHERE DPP.DB_PROC_CD =
DI.DB_PROC_CD)ORDER BY 1,2,3
```

How To Copy Samples From The Demonstration Database

Caution: If you are not familiar with the concepts described in the [ConfigLab](#) chapter, this section will be difficult to understand. Specifically, you need to understand how a **Compare** DB process is used to copy objects between two

databases. Please take the time to familiarize yourself with this concept before attempting to copy the sample **Archive** and **Purge** DB processes from the demonstration database.

The demonstration database contains several sample **Archive** and **Purge** DB processes. The topics in this section describe how to copy the sample **Archive** and **Purge** DB processes from the demonstration database to the production environment. The following assumes that the demonstration environment has been registered as a **Compare Source** supporting environment in your production environment.

If You Work In A Non-English Language

The demonstration database is installed in English only. If you work in a non-English language, you must execute the **F1-LANG** background process on the demonstration database before using it as a **Compare Source** supporting environment. If you work in a supported language, you should apply the language package to the demonstration database as well.

If you don't execute **F1-LANG** on the demonstration database, any objects copied from the demonstration database will not have language rows for the language in which you work and therefore you won't be able to see the information in the target environment.

Set Up A DB Process To Perform The Copy

You need to configure a DB process in your target environment that copies the sample archive and purge DB processes from the demonstration environment. This is confusing because you are configuring a DB process in one environment that copies DB processes from another.

First, set up batch controls to "copy sample archive/purge processes". Our suggestion is to duplicate the **CL-COPDB** batch control, as this is a system installed batch control that has the correct program name and batch parameters used to compare data between two environments. Make sure to populate the environment reference batch parameter with the environment reference of the demonstration environment.

Next, set up a DB process to "copy sample archive/purge processes". Our suggestion is to duplicate the **CL-COPDB** DB process, as this is a system installed DB process configured to copy other DB processes. For clarity make the name of the duplicated DB process match the name of the duplicated batch control. Also, make sure you change the override condition table rules on the **Primary** DB process instruction:

- Process Sequence: **10**
- Maintenance Object: **DB PROCESS** (DB Process, **CI_DB_PROC**)
- Instruction Role: **Primary**
- Table rules:
 - Table: **CI_DB_PROC**
 - Override Condition: **#CI_DB_PROC.DB_PROC_CD LIKE 'CI_ARC%' OR #CI_DB_PROC.DB_PROC_CD LIKE 'CI_PUR%'**

This assumes that you want to copy all of the DB processes prefixed with **CI_ARC or **CI_PUR** to your target environment. You may replace the table rule's override instruction with a **WHERE** clause defining any desired DB processes you want to copy from the demonstration database.**

Run The Background Processes

When the background process that you set up by duplicating **CL-COPDB** batch control runs, it highlights differences between the "copy archive/purge process" DB processes in the demonstration environment database and your target environment database.

The first time you run this process, it creates root objects in your target environment database to indicate the copied DB processes will be added. You can use the *Difference Query* to review these root objects and **approve** or **reject** them.

Note: Automatic approval. When you submit the background process, you can indicate that all root objects should be marked as **approved** (thus saving yourself the step of manually approving them using *Difference Query*).

Next duplicate the **CL-APPCH** batch control, as this is a system installed batch control that has the correct program name and batch parameters used to apply the changes of approved root objects created by the first batch process. Populate the identifier of the **Compare** DB process in the appropriate batch parameter.

After you've approved the root objects, submit the background process associated with the duplicated **CL-APPCH** DB process to add the DB processes to your target environment.

Set Up Archive Adjustment Type

Since the financial archive processes must maintain aggregate summaries, an archive adjustment type is necessary. The sample archive processes reference the processing algorithm **CL_ARPR-FT**. This algorithm references adjustment type **ARCADJ**. Before executing an archive process for financial entities using the sample **Archive** DB processes, add the **ARCADJ** adjustment type as shown in the demonstration database.

Note: Distribution Code. Since the archive adjustment has no general ledger impact, the distribution code may be any valid distribution code.

Note: Financial Algorithm. Although the chosen algorithm specifies Payoff Amt = 0, an archive adjustment itself may indeed have a payoff amount when calculated.

Managing Archive Environments

Remember that the *Archive Engine* may be used to archive or purge data in environments other than production. While archiving from environments other than production may not make sense, purging from an archive environment has merit. Over time, the amount of data kept in an archive environment has the potential to mount. This is especially true if you archive fast growing tables on a regular basis.

Purging data from an archive environment is not really any different from purging from the production environment. In order to purge from an archive environment, you need to log into it under the **CISUSR** schema. This means a web server and application server must process data against this schema. This is not the same application server that processes data against the **CISREAD** schema.

Once logged into the archive environment under the **CISUSR** schema, you execute a purge procedure to purge a subset of the archived data. You need to set up DB processes within the archive environment for purging the archived data.

Fastpath: Refer to *Metadata and Archive Purge Procedures* for information on configuring DB processes for archive and purge.

Example - Purge From an Archive Environment

Let's say that for the last five years, you have archived pay event data that is two years old or older to an archive environment. Now you want to implement a purge of the pay event data in the archive environment that is four years old or older.

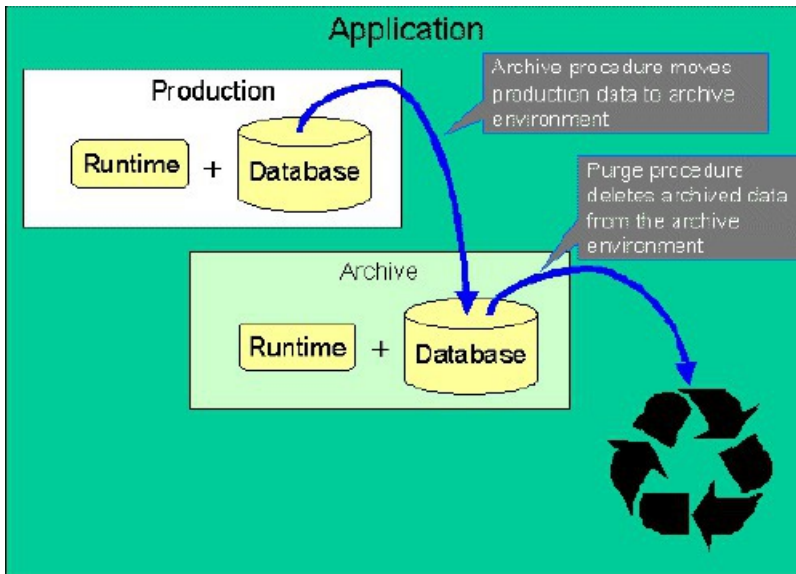

Figure 20: Purging from an Archive Environment

To perform the purge, you need to set up a batch control and a **Purge** DB process in the archive environment. The **Purge** DB process instructions for the pay event purge would look like this:

Proc Seq	Maintenance Object	Parent Seq	Constraint	Parent MO Table (from Constraint)
10	Pay Event	-	-	-
20	Payment	10 Pay Event	Pay Event Id	CI_PAY_EVENT
30	FT	20 Payment	Sibling ID	CI_PAY_SEG

PAY EVENT Maintenance Object Instruction Algorithm:

- Sequence: **10**
- System Event: **Purge Criteria**
- Algorithm: An algorithm whose program logic returns **false** if the pay event is four years old or less. Alternatively, a table rule may be used.

FT Maintenance Object Instruction Algorithm:

- Sequence: **10**
- System Event: **Purge Processing**
- Algorithm: (an algorithm of type *PRPR-FT*, this algorithm would have the "Modify Balance Control" parameter set to **N**)

Chapter 18

Configuration Tools

This section describes tools to facilitate detailed business configuration. The configuration tools allow you to extend both the front-end user interface as well as create and define specialized back-end services. Note that the tools described here are controlled completely by meta-data - no programming required!

Business Objects

This section provides an overview of business objects and describes how to maintain them.

The Big Picture of Business Objects

The topics in this section describe background topics relevant to business objects.

What Is A Business Object?

The fundamental idea behind a business object is that it should closely match the end user's conception of an object (e.g.; the specific information used to define a customer). This is in marked contrast to an application developer's notion of an object (e.g.; the normalized database tables used to capture generic person information). The business object configuration tool described here is a bridge between the two notions; a business object maps the end user's concept of an object to the physical database structures, and services, used to maintain the information. In other words, a business object is typically a simplification of the maintenance object.

Name:	Stepper, Sandra
Home Phone:	(415) 733-2513
Business Phone:	
Cell Phone:	
FAX:	
Social Security:	642-67-9820
Drivers License:	
Email:	ssandra@cassandra.net

Figure 21: Customer - as a Business Object

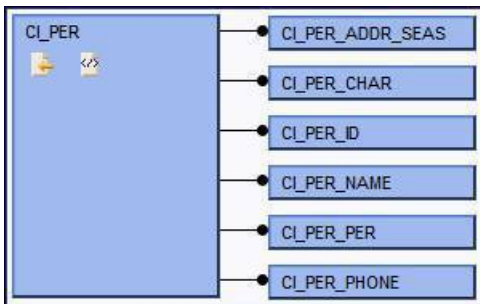

Figure 22: Customer - as Defined in the Database

Another definition of a business object is a structure that allows an implementation to define a simpler view of a maintenance object. For example, a tax management COTS team can set up business objects for individual taxpayer, corporation, and partnership all as simpler views of the Person maintenance object. Yet another use of business objects is for managing market messages: separate business objects can be defined for a multitude of market messages, all of which belong to a single market message MO.

A Business Object Has Properties

A business object has properties (AKA, elements). Properties such as "Social Security Number" and "Home Phone" are applicable to an individual taxpayer, whereas "Corporate Name" is applicable to a corporation. The structure of a business object is defined using an XML schema. The purpose of the schema is to describe the business object's properties and map them to the corresponding maintenance object fields.

```

<schema>
  <name mapField="ENTITY_NAME">
    <row mapChild="CI_PER_NAME">
      <SEQ_NUM is="1" />
      <NAME_TYPE_FLG default="PRIM" />
      <PRIM_NAME_SW default="true" />
    </row>
  </name>
  <driversLicense mapField="PER_ID_NBR">
    <row mapChild="CI_PER_ID">
      <ID_TYPE_CD is="DL" />
    </row>
  </driversLicense >
  <socialSecurity mapField="PER_ID_NBR">
    <row mapChild="CI_PER_ID">
      <ID_TYPE_CD is="SSN" />
      <PRIM_SW default="true" />
    </row>
  </socialSecurity>
  <email mapField="EMAILID"/>

```

Figure 23: Customer - Business Object Schema (partial)

Keep in mind that many maintenance objects have child table collections (e.g., a collection of phone numbers, or a collection of characteristics on an account) and therefore the definition of where a property resides can be sophisticated. For example, defining a business object property like "Name" requires the implementer to define:

- The child table on the maintenance object that holds names (e.g., CI_PER_NAME)
- The unique identifier of the instance of the collection in which the value resides (e.g., where Name Type Flag = **PRIM(ary)**)
- The name of the field in which the property resides (e.g., ENTITY_NAME)

Note: Flatten. We use the terms "flattening" and "flatten out" to describe a business object property that resides in a collection but is defined as a singular element.

Some maintenance objects allow data to be stored as an XML structure field (CLOB) with the entity. Business object properties may reside in the MO's XML extension. You will typically map business object properties to an MO XML extension when the property does not have to be exposed for SQL indexing or joining (e.g., most fields on a tax form or the elements in a market message).

Some business objects may have child tables that allow data to be stored as a CLOB. You can map to these CLOB fields in your schema.

Caution: CLOB is only for non-indexed / joined fields! We'd like to stress that putting properties in an XML document (CLOB) field should only be done for properties that will never be indexed or joined in an SQL statement. If you need to "join" to a property you must map it to an indexed field, like a characteristic, rather than to the CLOB. This is because databases do not commonly support indexes for elements in a CLOB field (at least not today).

Note: Schema Definition Tips. A context sensitive "Schema Tips" zone appears when you open the [Business Object](#) page to assist you with the schema definition syntax. The zone provides a complete list of the XML nodes and attributes available to you when you construct a schema.

[XAI incoming messages](#) and [scripts](#) support interaction with business objects. It is also possible to interact with business objects directly from a Java class.

A Business Object May Define Business Rules

A business object may define business rules that govern the behavior of entities of this type.

- Simple element-level validation is supported by schema attributes. Note that element-level validation is executed before any maintenance object processing. For more sophisticated rules you create **Validation** algorithms and associate them with your business object. BO validation algorithms are only executed after "core validation" held in the MO is passed.
- A **Pre-Processing** algorithm may be used to "massage" a business object's elements prior to any maintenance object processing. For example, you may use this type of algorithm to default element values.
- A **Post-Processing** algorithm may be used to perform additional steps such as creating a To Do Entry or add a log record as part of the business object logical transaction. These plug-ins are executed after all the validation rules are executed.
- An **Audit** algorithm may be used to audit changes made to entities of this type. Any time a business entity is added, changed or deleted, the system detects and summarizes the list of changes that took place in that transaction and hands it over to **Audit** plug-ins associated with the business object. These plug-ins are executed after all the post-processing rules are executed. It is the responsibility of such algorithms to log the changes if and where appropriate, for example as a log entry or an entry in an audit trail table or an entry in the [business event log](#)

By default all elements of the business object are subject to auditing. You can however mark certain elements to be excluded from the auditing process using the **noAudit** schema attribute. Marking an element as not auditable will prevent it from ever appearing as a changed element in the business object's audit plug-in spot. Refer to the "Schema Tips" context sensitive zone associated with the Business Object maintenance page for more information on this attribute.

Refer to [Business Object - Algorithms](#) for more information on the various types of algorithms .

The system applies business object rules (schema based and algorithms) whenever a business object instance is added, changed or deleted. This is only possible when the call is made via the maintenance object service. For example, when made via business object interaction ("invoke BO"), the MO's maintenance page or XAI services that reference the BO or the MO service, etc. In addition the system must be able to determine the business object associated with the actual object being processed. To do that the Maintenance Object itself has to have a **Determine BO** algorithm *plugged in*. If the business object cannot be determined for a maintenance object instance business object rules are not applied.

Note:

Pre-Processing is special. The pre-processing algorithm plug-in spot is unique in that it only applies during a BO interaction. It is executed prior to any maintenance object processing. It means that when performing add, change or delete via the maintenance object service, the pre-processing plug-in is not executed.

Caution: Direct entity updates bypass business rules! As mentioned above, it is the maintenance object service layer that applies business object rules. Processes that directly update entities not via the maintenance object service bypass any business object rules you may have configured.

Business Object Inheritance

A business object may inherit business rules from another business object by referencing the latter as its parent. A child business object can also have children, and so on. A parent's rules automatically apply to all of its children (no compilation - it's immediate). A child business object can always introduce rules of its own but never remove or bypass an inherited rule.

The following is an illustration of multiple levels of business object inheritance.

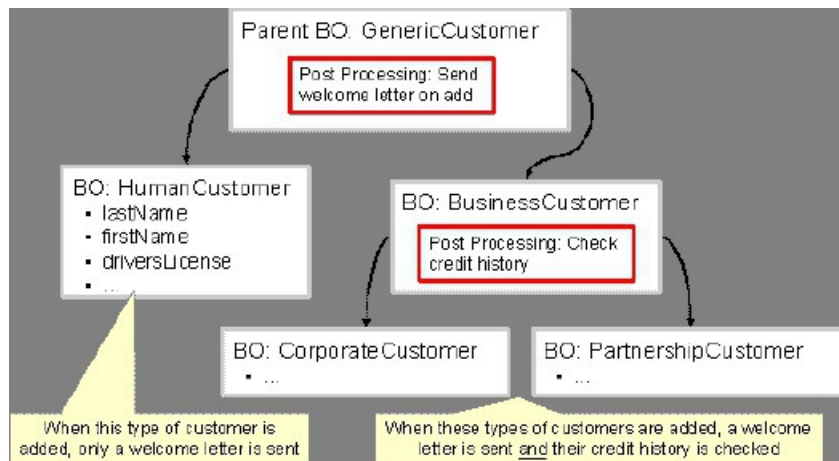

Notice how the "Business Customer" business object extends its parent rules to also enforce a credit history check on all types of customers associated with its child business objects.

Most types of business object system events allows for multiple algorithms to be executed. For example, you can have multiple **Validation** algorithms defined for a business object. For these, the system executes all algorithms at all levels in the inheritance chain starting from the highest-level parent business object moving on to lower levels.

Other types of system events allows for a single algorithm to be executed. For example, you can only have one **Information** algorithm to format the standard description of a business object instance. For these, the system executes the one at the level nearest to the business object currently being processed.

Note: Note. The parent and its children must reference the same maintenance object.

Note: Data structures are not inherited. While you can declare schemas on parent business objects, their children will not inherit them. A good practice is to design child business object schemas to **include** their parent business object's schema.

Note: Use Inheritance Wisely. While it is intellectually attractive to abstract behavior into parent BOs to avoid redundant logic and simplify maintenance, before doing this weigh the reuse benefits against the cost in transparency, as it is not easy to maintain a complex hierarchy of business objects.

Each Business Object Can Have A Different Lifecycle

Many maintenance objects have a status column that holds the business entity's current state within its lifecycle. Rules that govern lifecycle state transition (e.g., what is its initial state, when can it transition to another state, etc.) and the behavior associated with each state are referred to as lifecycle rules. Older Maintenance Objects, such as To Do Entry, have predefined lifecycles whose rules are governed by the base-package and cannot be changed. The lifecycle of newer Maintenance Objects exists in business object meta-data and as such considered softly defined. This allows you to have completely different lifecycle rules for business objects belonging to the same maintenance object.

Here are examples of two business objects with different lifecycles that belong to the same maintenance object.

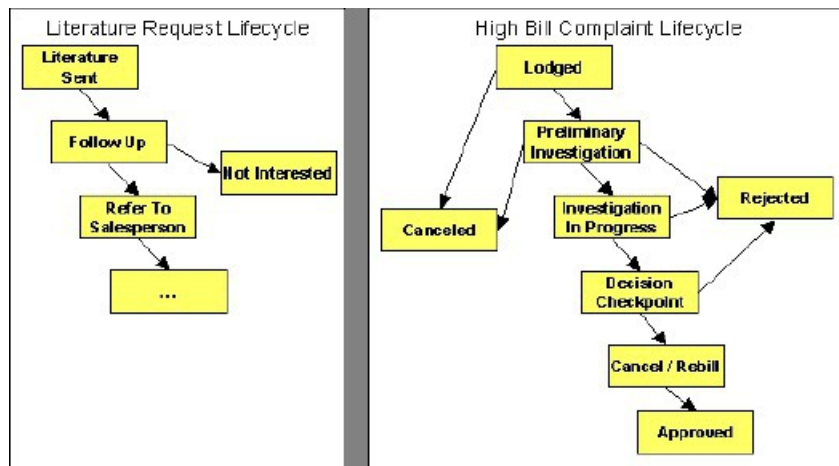

Note: A Maintenance Object supports soft lifecycle rules if it is defined with a **Status Field** *Maintenance Object option*.

The topics that follow describe important lifecycle oriented concepts.

Valid States versus State Transition Rules

The boxes in the above diagram show the potential valid states a business entity of the above business object can be in. The lines between the boxes indicate the state transition rules. These rules govern the states it can move to while in a given state. For example, the above diagram indicates a high bill complaint that's in the **Lodged** state can be either **Canceled** or moved into the **Preliminary Investigation** state.

When you set up a business object, you define both its valid states and the state transition rules.

One Initial State and Multiple Final States

When you set up lifecycle states, you must pick one as the initial state. The initial state is the state assigned to new entities associated with the business object. For example, the above high-bill complaint business object defines an initial state of **Lodged**, whereas the literature request one defines an initial state of **Literature Sent**.

You must also define which statuses are considered to be "final". Typically when an entity reaches a "final" state, its lifecycle is considered complete and no further processing is necessary.

Note: Allowing An Entity To Be "Reopened". You can set up your state transition rules to allow a business entity to be "reopened" (i.e., to be moved from a final state to a non-final state). Neither of the above examples allows this, but it is possible if you configure your business object accordingly.

State-Specific Business Rules

For each state in a business object's lifecycle, you can define the following types of business rules.

Logic To Take Place When Entering A State

You can define algorithms that execute before a business entity enters a given state. For example, you could develop an algorithm that requires a cancellation reason before an entity is allowed to enter the *Canceled* state.

You can also incorporate state auto-transitioning logic within this type of algorithms. Refer to [auto-transition](#) for more information.

Logic To Take Place When Exiting A State

You can define algorithms that execute when a business entity exists a given state. For example, you could develop an algorithm that clears out error messages when a given entity exits the *Error* state.

Monitor Rules

You can define algorithms to monitor a business entity while it is in a given state. This type of logic is typically used to check if the conditions necessary to [transition](#) the entity to another state exist (and, if so, transition it). For example, transition an entity to the *Canceled* state if it's been in the *Error* state too long. Another common use is to perform ancillary work while an entity is in a given state. For example, update statistics held on the object while it's in the *Active* state .

[Monitor algorithms](#) are invoked when a business entity first enters a state and periodically after that in batch. You have the option to defer the monitoring of a specific state until a specific monitoring batch job runs. You do so by associating the state with a specific monitoring process. In this case the system will only execute the monitoring rules of this state when that specific batch process runs. This may be useful for example in a market-messaging world where you do not want an inbound message processed when it is received; rather, you want to wait until a later point in time (maybe at the end of the day).

A monitor algorithm can carry out any business logic. In addition it can optionally tell the system to do either of the following:

- Stop monitoring and transition to another state. The system will not call any further monitoring algorithm plugged in on the state and attempt to transition the entity to the requested new state.
- Stop monitoring. Same as above except that no transition takes place. You may want to use this option to prevent transitions while some condition is true.

If none of the above is requested the system keeps executing subsequent monitoring algorithms.

Fastpath: Refer to [Business Object - Lifecycle](#) for more information on how to set up state-specific algorithms.

Inheriting Lifecycle

If a business object references a parent business object, it always [inherits](#) its lifecycle from the highest-level business object in the hierarchy. In other words, only the highest-level parent business object can define the lifecycle and the valid

state transitions for each state. Child business objects, in all levels, may still extend the business rules for a given state by introducing their own state-specific algorithms.

The system executes all state-specific algorithms at all levels in the inheritance chain starting from the highest-level parent business object moving on to lower levels.

Auto-Transition

In a single transition from one state to another, the system first executes the **Exit** algorithms of the current state, transitions the entity to the new state, executes the **Enter** algorithms of the new state followed by its **Monitor** algorithms. At this point if a **Monitor** algorithm determines that the entity should be further automatically transitioned to another state the remaining monitoring algorithm defined for the current state are NOT executed and the system initiates yet another transition cycle.

Notice that an **Enter** algorithm can also tell the system to automatically transition the entity to another state. In this case the remaining **Enter** algorithm as well as all **Monitor** algorithms defined for the current state are NOT executed.

The following illustration provides an example of an auto-transition chain of events.

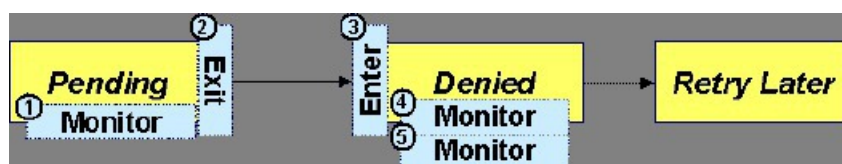

In this example a business entity is in a Pending state. While in that state a **Monitor** algorithm determines to auto-transition it to the Denied state. At this point the following takes place:

- No further **Monitor** algorithms of the Pending state are executed
- Pending state **Exit** algorithms are executed
- The system transitions the entity to the Denied state
- Denied state **Enter** algorithms are executed. No further auto-transition is requested.
- Denied state **Monitor** algorithms are executed. No further auto-transition is requested.

Keeping An Entity In Its Last Successful State

By default, any error encountered while transitioning a business entity from one state to another rolls back ALL changes leaving the entity in its original state.

When applicable, the Maintenance Object can be configured to always keep an entity in its last successful state rather than rolling all the way back to the original state. This practice is often referred to as "taking save-points". In case of an error, the entity is rolled back to the last successfully entered state and the error is logged on the [maintenance object's log](#). Notice that with this approach no error is returned to the calling process, the error is just logged!

The logic to properly log the error is in a **Transition Error Maintenance Object plug-in**. The system considers a maintenance object to practice "save-points" when such an algorithm is plugged into it.

Even if the maintenance object practices "save-points", in case of an error the system will not keep an entity in the last successfully entered state if that state is either marked as *transitory* or one of its **Enter** algorithms has determined that the entity should proceed to a next state. The system will roll back to the first previous state that does not match these conditions.

Monitoring Batch Processes

The base package provides a periodic monitoring batch process for each maintenance object that supports soft state transition. The process periodically executes the monitoring algorithms associated with the current state of an entity, excluding states explicitly referencing a deferred monitoring batch process.

A deferred monitoring process works in the same way but only considers entities whose current state references this particular batch control as their monitor process. Deferred monitoring is only needed for certain states based on business requirements.

Your business rules will dictate the execution frequency of each monitoring process and the order in which they should be scheduled.

Note: Updates to the business object. When the monitor algorithms indicate that the business object should transition, the monitor batch processes are responsible for ensuring the business object is transitioned appropriately and that the appropriate exit, enter and monitor algorithms are executed. Please note that the business object is not updated using a call to the maintenance object service and therefore the *business rules* plugged in to the business object are not executed.

Transitory States

You can define a state as **Transitory** if you do not wish the business entity to ever exist in that particular state.

The following illustrates a lifecycle with a transitory Validate state.

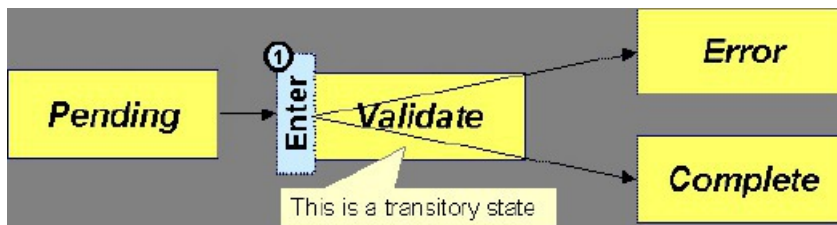

In this example, the business entity is saved still not validated in the Pending state. At some point, the user is ready to submit the entity for validation and transitions it into a transitory state Validate whose **Enter** rules contain the validation logic. The responsibility of the transitory state's **Enter** algorithms is to decide if the entity is valid or in error and then transitions it into the appropriate final state. In this scenario, you may not ever want the business entity to exist in the Validate state.

Let's also assume that the maintenance object in this example is practicing " *save-points*" and requires the entity to be kept in its last successful state. If an error were to occur during the transition from **Validate** to the next state, the system would roll back the entity back to Pending, and not Validate even though the entity has successfully entered the Validate state. Refer to the *Auto Transition* section for more information.

State Transitions Are Audited

Most Maintenance Objects that support soft lifecycle definition also have a log to hold significant events throughout a business entity's lifecycle. For example, log entries are created to record:

- When the business entity is created (and who created it)
- When its status changes (and who changed it)
- If a transition error occurred (and the error message)

- References to other objects created throughout the entity's lifecycle. For example, if a To Do entry is created as part of processing the entity, the To Do Entry is referenced in the log.
- Manual entries added by a user (think of these as "diary" entries)

When a business entity is first created and when it transitions into a new state the system calls **Transition** algorithm(s) plugged in on the *Maintenance Object* to record these events. If the maintenance object supports a log these events can be captured as log entries.

Note: Most base package maintenance objects supporting a log may already provide state transition logging as part of their core logic. In this case you only need to provide a **Transition** plug-in if you wish to override base logging logic with your own.

Required Elements Before Entering A State

You can define additional elements that are required before a business entity can enter a given state. For example, let's assume that a Cancel Reason must be defined before an object can enter the *Canceled* state. You do this by indicating that element as a **Required Element** *state-specific option* on the appropriate state on the business object.

Defining Reasons for Entering a State

Some states can be configured to require a user to provide a reason when an object enters the state.

For example, you might configure the Cancel state on the Field Activity BO so when you transition a field activity to the cancel state you must supply a reason such as "Customer Canceled" or "Wrong Address." Reasons for entering a state are called status reasons. Maintenance objects that support status reasons have a status reason field defined as an option. When you create a business object based on that maintenance object you can then configure each state to prompt the user for a status reason. The status reason can be required or optional. The status reasons are defined using the Status Reason portal.

Note: Status reasons can be defined only on the top level business object in a business object hierarchy.

Granting Access To Business Objects

Every business object must reference an *application service*. When you link a business object to an application service, you are granting all users in the group access to its instances. You can prevent users from transitioning a business object into specific states by correlating each business object status with each application service action (and then don't give the user group rights to the related action).

Fastpath: Refer to *The Big Picture Of Application Security* for information about granting users access rights to an application service.

The system checks if a user has access rights each time the application is invoked to add, change, delete, read, or transition a business object. However, if a business object invokes another business object, we assume that access was controlled by the initial business object invocation and we do not check access for other business objects that it invokes. In other words, access rights are only checked for the initial business object invoked in a service call.

In order to apply business object security the system must be able to determine the business object associated with the actual object being processed. To do that the Maintenance Object itself has to have a **Determine BO** algorithm *plugged in*. If this algorithm is not plugged in or it cannot determine the BO on the MO, the system will NOT invoke any BO rules. If the business object cannot be determined for a maintenance object instance, business object security is not checked. In this case the system checks the user's access rights using standard maintenance object security.

Note: Parent business objects are ignored. If a child business object exists, a user need only have access to the child business object's application service (not to every application service in the business object hierarchy).

Defining Business Objects

The topics in this section describe how to maintain business objects.

Business Object - Main

Use this page to define basic information about a business object. Open this page using **Admin Menu > Business Object**.

Description of Page

Enter a unique **Business Object** name and **Description**. Use the **Detailed Description** to describe the purpose of this business object in detail. **Owner** indicates if this business object is owned by the base package or by your implementation (**Customer Modification**).

Caution: Important! If you introduce a new business object, carefully consider its naming convention. Refer to [System Data Naming Convention](#) for more information.

Enter the **Maintenance Object** that is used to maintain objects of this type.

Enter a **Parent Business Object** from which to *inherit* business rules.

Lifecycle Business Object is only displayed for child business objects, i.e. those that reference a parent business object. It displays the highest-level business object in the inheritance hierarchy. Refer to [Inheriting Lifecycle](#) for more information.

Application Service is the application service that is used to provide security for the business object. Refer to [Granting Access To Business Objects](#) for more information. The application service on the child business object must have the same valid actions as the application service on the parent business object.

Use **Instance Control** to allow or prevent new entities from referencing the business object.

Click the **View MO** hyperlink to view the maintenance object in the [Maintenance Object Viewer](#). You may find it useful to leave the application viewer window open while defining your business object schema.

Click on the **View Schema** hyperlink to view the business object's expanded schema definition. Doing this opens the [schema viewer](#) window.

The options grid allows you to configure the business object to support extensible options. Select the **Option Type** dropdown to define its **Value**. **Detailed Description** may display additional information on the option type. Set the **Sequence** to **1** unless the option can have more than one value. **Owner** indicates if this option is owned by the base package or by your implementation (**Customer Modification**).

Note: You can add new options types. Your implementation may want to add additional option types. For example, your implementation may have plug-in driven logic that would benefit from a new option. To do that, add your new values to the customizable lookup field **BUS_OBJ_OPT_FLG**. If you add a new option type for a business option, you must update its maintenance object to declare this new option type. Otherwise, it won't appear on the option type dropdown. You do that by referencing the new option type as a **Valid BO Option Type** [maintenance object option](#).

Where Used

Follow this link to open the data dictionary to view the tables that reference [FI_BUS_OBJ](#).

Business Object - Schema

Use this page to maintain a business object's schema. Open this page using **Admin Menu > Business Object** and then navigate to the **Schema** tab.

Description of Page

The contents of this section describe the zones that are available on this portal page.

The **General Information** zone displays main attributes of the business object.

Click on the **View Schema** hyperlink to view the business object's expanded schema definition. Doing this opens the *schema viewer* window.

The *Schema Designer* zone allows you to edit the business object's schema. The purpose of the schema is to describe the business object's properties and map them to corresponding maintenance object fields.

Note: Schema Definition Tips. A context sensitive "Schema Tips" zone is associated with this page. The zone provides a complete list of the XML nodes and attributes available to you when you construct a schema.

Business Object - Algorithms

Use this page to maintain a business object's algorithms. Open this page using **Admin Menu > Business Object** and then navigate to the **Algorithms** tab.

Description of Page

The **Algorithms** grid contains algorithms that control important functions for entities defined by this business object. You must define the following for each algorithm:

- Specify the **System Event** with which the algorithm is associated (see the table that follows for a description of all possible events).
- Specify the **Sequence Number** and **Algorithm** for each system event. You can set the **Sequence Number** to 10 unless you have a **System Event** that has multiple **Algorithms**. In this case, you need to tell the system the **Sequence** in which they should execute.
- If the algorithm is implemented as a script, a link to the **Script** is provided. Refer to *Plug-In Scripts* for more information.
- **Owner** indicates if this is owned by the base package or by your implementation (**Customer Modification**).

The following table describes each **System Event**. Refer to *A Business Object May Define Business Rules* for more information about these system events.

System Event	Optional / Required	Description
Audit	Optional	<p>Algorithms of this type may be used to audit certain changes made to business object instances.</p> <p>The system hands over to the algorithms a summary of all the elements that were changed throughout a specific call to update an object. Excluded from this processing are elements explicitly marked on the schema as requiring no audit. For each element its original value before the change as well as its new value are provided.</p> <p>It is the responsibility of the algorithms to record corresponding audit information.</p> <p>The system invokes all algorithms of this type defined on the business object's inheritance hierarchy. Refer to <i>Business Object inheritance</i> for more information.</p> <p>Click here to see the algorithm types available for this system event.</p>
Information	Optional	<p>We use the term "Business Object Information" to describe the basic information that appears throughout the system to describe an entity defined by the business object. The data that appears in this</p>

information description is constructed using this algorithm.

The system invokes a single algorithm of this type. If more than one algorithm is plugged-in the system invokes the one with the greatest sequence number found on the business object closest to the current business object in the inheritance hierarchy. Refer to [Business Object inheritance](#) for more information.

Click [here](#) to see the algorithm types available for this system event.

Post-Processing	Optional	<p>Algorithms of this type may be used to perform additional business logic after a business object instance has been processed.</p> <p>The system invokes all algorithms of this type defined on the business object's inheritance hierarchy. Refer to Business Object inheritance for more information.</p> <p>Click here to see the algorithm types available for this system event.</p>
Pre-Processing	Optional	<p>Algorithms of this type further populates a request to maintain a business object instance right before it is processed.</p> <p>The system invokes all algorithms of this type defined on the business object's inheritance hierarchy. Refer to Business Object inheritance for more information.</p> <p>Click here to see the algorithm types available for this system event.</p>
Validation	Optional	<p>Algorithms of this type may be used to validate a business object instance when added, updated or deleted.</p> <p>The system invokes all algorithms of this type defined on the business object's inheritance hierarchy. Refer to Business Object inheritance for more information.</p> <p>Click here to see the algorithm types available for this system event.</p>

Note: You can add new system events. Your implementation may want to add additional business object oriented system events. For example, your implementation may have plug-in driven logic that would benefit from a new system event. To do that, add your new values to the customizable lookup field **BO_SEVT_FLG**. If you add a new business object system event, you must update the maintenance object to declare this new system event. Otherwise, it won't appear on the system event dropdown. You do that by referencing the new system event as a **Valid BO System Event** [maintenance object option](#).

Note: You can inactivate algorithms on base Business Objects. Your implementation may want to use a business object provided by the base product, but may want to inactivate one or more algorithms provided by the base business object. To do that, on the business object where this algorithm is referenced, go to the options grid on Business Object - Main and add a new option, setting the option type to **Inactive Algorithm** and setting the option value to the algorithm code.

Business Object - Lifecycle

Use this page to maintain a business object's lifecycle oriented business rules and options. Open this page using **Admin Menu > Business Object** and then navigate to the **Lifecycle** tab.

Description of Page

The **Status** accordion contains an entry for every status in the object's [lifecycle](#). The entry appears differently for a child business object as it can only extend its inherited lifecycle by introducing algorithms and options of its own.

Use **Status** to define the unique identifier of the status. This is NOT the status's description, it is simply the unique identifier used by the system. Only the highest-level business object can define lifecycle statuses. For a child business object the

inherited status description is displayed allowing navigation to the corresponding entry on the business object defining the lifecycle.

Use **Description** to define the label of the status. This field is hidden for a child business object.

Use **Access Mode** to define the action associated with this status. Refer to [Access Rights](#) for the details of how to use this field to restrict which users can transition a business entity into this state. This field is hidden for a child business object.

Enter a **Monitor Process** to defer the monitoring of entities in this state until the specific batch process runs. Refer to [Monitor Rules](#) for more information. This field is hidden for a child business object.

The **Status Reason** drop-down indicates if users should be prompted to provide a specific reason when the business object enters this state. This field appears only if the Status Reason Field is an option on the business object's maintenance object. Valid values are blank, Optional, and Required. The default value is blank (users are not prompted to provide a status reason). See [Maintaining Status Reasons](#) for more information about status reasons.

Use **Status Condition** to define if this status is an **Initial**, **Interim** or **Final** state. Refer to [One Initial State and Multiple Final States](#) for more information about how this field is used. This field is hidden for a child business object.

Use **Transitory State** to indicate whether a business entity should ever exist in this state. Only **Initial** or **Interim** states can have a transitory state value of **No**. Refer to [transitory states](#) for more information. This field is hidden for a child business object.

Use **Alert Flag** to indicate that being in this state warrants an application alert. This may be used by custom logic to provide an alert to a user that entities exist in this state. This field is hidden for a child business object.

Use **Display Sequence** to define the relative order of this status for display purposes. For example when displayed on the status accordion and on the summary tab page. This field is hidden for a child business object.

Algorithms

The **Algorithms** grid contains algorithms that control important functions for a given status. You must define the following for each algorithm:

- Specify the **System Event** with which the algorithm is associated (see the table that follows for a description of all possible events).
- Specify the **Sequence Number** and **Algorithm** for each system event. You can set the **Sequence Number** to 10 unless you have a **System Event** that has multiple **Algorithms**. In this case, you need to tell the system the **Sequence** in which they should execute.
- If the algorithm is implemented as a script, a link to the **Script** is provided. Refer to [Plug-In Scripts](#) for more information.
- **Owner** indicates if this is owned by the base package or by your implementation (**Customer Modification**).

The following table describes each **System Event**.

System Event	Optional / Required	Description
Enter	Optional	Algorithms of this type apply business rules when a business object instance enters a given state. The system invokes all algorithms of this type defined on the business object's inheritance hierarchy. Refer to Business Object Inheritance for more information. Click here to see the algorithm types available for this system event.
Exit	Optional	Algorithms of this type apply business rules when a business object instance exits a given state. The system invokes all algorithms of this type defined on the business object's inheritance hierarchy. Refer to Business Object Inheritance for more information.

Click [here](#) to see the algorithm types available for this system event.

Monitor

Optional

Algorithms of this type monitor a business object instance while in a given state. Typically these are used to auto-transition it to another state.

The system invokes all algorithms of this type defined on the business object's inheritance hierarchy. Refer to [Business Object Inheritance](#) for more information.

Click [here](#) to see the algorithm types available for this system event.

Note: You can inactivate status level algorithms on base Business Objects. Your implementation may want to use a business object provided by the base product, but may want to inactivate one or more of the status oriented algorithms provided by the base business object. To do that, on the business object and status where this algorithm is referenced, go to the options grid and add a new option, setting the option type to **Inactive Algorithm** and setting the option value to the algorithm code.

Next Statuses

Use the **Next Statuses** grid to define the valid statuses a business entity can transition into while it's in this state. This section is hidden for a child business object. Refer to [Valid States versus State Transition Rules](#) for more information. Please note the following about this grid:

- **Status** shows the statuses for the top-level business object, the **Status Code**, the **Lifecycle BO description**, and the **Status description** for each status.
- Use **Action Label** to indicate the verbiage to display on the action button used to transition to this status.
- **Sequence** controls the relative order of one status compared to others for display purposes. This information may be used to control the order in which action buttons are presented on a user interface.
- **Default** controls which next state (if any) is the default one. This information may be used by an **Enter** or **Monitor** algorithm to determine an auto-transition to the default state. It may also be used to also mark the associated button as the default one on a user interface.
- **Transition Condition** may be configured to identify a common transition path from the current state. By associating a given "next status" with a transition condition value, you can design your auto-transition rules to utilize those flag values without specifying a status particular to a given business object. Thus, similar logic may be used across a range of business objects to transition a business entity into, for example, the next **Ok** state for its current state. You'll need to add your values to the customizable lookup field **BO_TR_COND_FLG**.
- **Transition Role** controls whether only the **System** or both **System and User** have the ability to transition a business entity into a given "next status".
- When you initially set up a business object lifecycle, none of the statuses will reside on the database and therefore you can't use the search to define a "next status". We recommend working as follows to facilitate the definition of this information:
 - Leave the Next Statuses grid blank when you initially define a business object's statuses
 - After all statuses have been saved on the database, update each status to define its Next Statuses (this way, you can use the search to select the status).

Options

The options grid allows you to configure the business object status to support extensible options. Select the **Option Type** drop-down to define its **Value**. **Detailed Description** may display additional information on the option type. Set the **Sequence** to **1** unless the option can have more than one value. **Owner** indicates if this option is owned by the base package or by your implementation (**Customer Modification**).

Note: You can add new options types. Your implementation may want to add additional option types. For example, your implementation may have plug-in driven logic that would benefit from a new option. To do that, add your new values to the customizable lookup field **BO_OPT_FLG**. If you add a new option type for a status, you must update the business object's maintenance object to declare this new option type. Otherwise, it won't appear on the option type dropdown. You do that by referencing the new option type as a **Valid BO Status Option Type** [maintenance object option](#).

Business Object - Summary

This page summarizes business object information in a high level. Open this page using **Admin Menu > Business Object** and then navigate to the **Summary** tab.

Description of Page

The contents of this section describe the zones that are available on this portal page.

The **General Information** zone displays main attributes of the business object.

Click on the **View Schema** hyperlink to view the business object's expanded schema definition. Doing this opens the *schema viewer* window.

The **Options** zone summarizes business object and state specific options throughout the *inheritance* chain.

The **Rules** zone summarizes business object and state specific rules throughout the *inheritance* chain.

The **Schema Usage Tree** zone summarizes all cross-references to this schema. These may be other schemas, scripts, and XAI Inbound Services. For each type of referencing entity, the *tree* displays a summary node showing a total count of referencing items. The summary node appears if at least one referencing item exists. Expand the node to list the referencing items and use their description to navigate to their corresponding pages.

The **Business Object Hierarchy** zone displays in a tree view format the *hierarchy* of child business object associated with the current business object. It also shows the current business object's immediate parent business object.

Maintaining Status Reasons

Status Reasons define specific reasons for transitioning a business object to a specific status in the business object's lifecycle.

Each business object lifecycle status can be configured to prompt users for a status reason when transitioning to that status. For example, consider a business object with a status of "On Hold." You could define one or more status reasons for this status, and configure it to prompt users for a status reason whenever they transition the business object to the "On Hold" status.

Status Reasons are maintained on the Status Reason portal. Open this page using **Admin > Status Reason** .

The topics in this section describe the base-package zones that appear on the Status Reason portal.

Business Objects with Status Reason List

The Business Objects with Status Reason List zone displays the business objects that have one or more statuses that can have status reasons defined.

Click the broadcast icon to open other zones that contain more information about the business object's status reasons.

Status Reasons

The Status Reasons zone contains display-only information about the business object's status reasons.

This zone appears when a business object has been broadcast from the Business Objects with Status Reason List. The following actions are available:

- Click **Add** in the title bar to start a business process that creates a new status reason code for this business object. To create the new status reason:
 - Select the **Status** that is associated with the new status reason.

- Define the **Status Reason** and provide a **Description**.
- Define the **Status Reason Selection** value as Selectable or Not Selectable. Choose Selectable if you want a user to be able to select that status reason. Choose Not Selectable for status reasons that are used by system processes.
- Click **Save**.
- Click **Edit** to update the status reason. You can edit the description of the status reason and define the status reason as Selectable or Not Selectable.
- Click **Delete** to delete the status reason.
- Click **Duplicate** to duplicate status reason.

Business Services

In the same way that a *business object* is used to simplify a maintenance object, a business service can be used to simplify a back-end service. The rating engine is a good example of a complex back-end service because it must satisfy a vast array of differing requirements. However, it is also true that the actual data required for a specific rating task can be quite simple. For example, if your *script* must calculate a simple cost per ton: you can pass the rating engine just a single service quantity and receive a calculated amount back.

Business services define alternative services to our internal services that are easier to work with. A Business Service provides a "simpler" data interface thus making interaction with the actual service easier. For example, it may flatten out complex collections and set up default values for other pieces of information (like a rate schedule).

```
<input type="group">
  <serviceQuantity dataType="number"/>
</input>
<output type="group">
  <amount dataType="money"/>
</output>
```

Figure 24: Weight Calculation Business Service

```

</pageBody>
  <field type="date" name="USER_START_DT"> xpath </field>
  <field type="string" name="BSEG_ID"> xpath </field>
  <field type="string" name="BSEG_INFO"> xpath </field>
  <field type="string" name="SA_INFO"> xpath </field>
  <field type="string" name="SA_ID"> xpath </field>
  <field type="date" name="START_DT"> xpath </field>
  <field type="date" name="END_DT"> xpath </field>
  <field type="boolean" name="THIRD_PARTY_SW"> xpath </field>
  <field type="date" name="ACCOUNTING_DT"> xpath </field>
  <field type="string" name="SP_ID"> xpath </field>
  <field type="string" name="PREM_ID"> xpath </field>
  <field type="string" name="LANGUAGE_CD"> xpath </field>
  <field type="string" name="REV_CL_CD"> xpath </field>
  <field type="string" name="RC_DESCR"> xpath </field>
  <field type="string" name="RS_CD"> xpath </field>
  <field type="string" name="RS_DESCR"> xpath </field>
  <list>
    <listHeader>
    </listHeader>
    <listBody>
      <field type="rowActionFlag"> xpath </field>
      <field type="string" name="CHAR_TYPE_CD"> xpath </field>
      <field type="string" name="CHAR_TYPE_DESCR"> xpath </field>
      <field type="string" name="CHAR_VAL"> xpath </field>
      <field type="string" name="CHAR_VAL_DESCR"> xpath </field>
      <field type="string" name="ADHOC_CHAR_VAL"> xpath </field>
      <field type="string" name="CHAR_TYPE_FLG"> xpath </field>
    </listBody>
  </list>
  <list>
    <listHeader>
    </listHeader>
    <listBody>
      <field type="rowActionFlag"> xpath </field>
      <field type="string" name="RR_SP_ID"> xpath </field>
      <field type="bigInteger" name="SEQNO"> xpath </field>
      <field type="bigDecimal" name="REG_CONST"> xpath </field>
      <field type="string" name="USAGE_FLG"> xpath </field>
      <field type="bigInteger" name="USE_PCT"> xpath </field>
      <field type="string" name="HOW_TO_USE_FLG"> xpath </field>
      <field type="boolean" name="MSR_PEAK_QTY_SW"> xpath </field>
      <field type="string" name="UOM_CD"> xpath </field>
      <field type="string" name="TOU_CD"> xpath </field>
      <field type="string" name="SQI_CD"> xpath </field>
    </listBody>
  </list>

```

Figure 25: Rate Application Service (about 30% of actual service)

As with the business object, the business service's interface to the internal service is defined using its schema. The schema maps the business service's elements to the corresponding elements in the internal service program's XML document. Keep in mind that many back-end services have child table collections (e.g., a collection of input service quantities, or a collection of output bill lines) and therefore the definition of where a business service property resides can be sophisticated. For example, defining a business service property like "Weight" requires the implementer to define:

- The collection on the business service that holds service quantities (e.g., SQ)
- The unique identifier of the instance of the collection in which the value resides (e.g., where SQI Code = **TONS**)
- The name of the field in which the property resides (e.g., SQI_CD)

```

<input type="group">
  <serviceQuantity mapField="INIT_SQ">
    <row mapList="SQ">
      <SQI_CD is="TONS"/>
    </row>
  </serviceQuantity>
</input>
<output type="group">
  <amount mapField="CALC_AMT">
    <row mapList="CALC_HDR">
      <HEADER_SEQ is="1"/>
    </row>
  </amount>
</output>

```

Figure 26: Weight Charge Schema

Note: Flatten. We use the terms "flattening" and "flatten out" to describe a business service property that resides in a collection but is defined as a singular element.

Note: Schema Definition Tips. A context sensitive "Schema Tips" zone appears when you open the [Business Service](#) page to assist you with the schema definition syntax. The zone provides a complete list of the XML nodes and attributes available to you when you construct a schema.

[XAI incoming messages](#) and [scripts](#) support interaction with business services. You can also invoke a business service from a Java class.

Defining Business Services

The topics in this section describe how to maintain business services.

Business Service - Main

Use this page to define basic information about a Business Service. Open this page using **Admin Menu > Business Service**.

Description of Page

Enter a unique **Business Service** name and **Description**. Use the **Detailed Description** to describe the purpose of this business service in detail. **Owner** indicates if the business service is owned by the base package or by your implementation (**Customer Modification**).

Caution: Important! If you introduce a new business service, carefully consider its naming convention. Refer to [System Data Naming Convention](#) for more information.

Enter the internal **Service Name** being called when this business service is invoked.

Enter the **Application Service** that is used to provide security for the business service. The application service must have an Access Mode of Execute.

Click the **View XML** hyperlink to view the XML document used to pass data to and from the service in the [Service XML Viewer](#). You may find it useful to leave the application viewer window open while defining your business service schema.

Note: XML document may not be viewable. If you create a new page service and do not regenerate the application viewer, you will not be able to view its XML document.

Click on the **View Schema** to view the business service's expanded schema definition. Doing this opens the [schema viewer](#) window.

Where Used

Follow this link to open the data dictionary to view the tables that reference [FI_BUS_SVC](#).

Business Service - Schema

Use this page to maintain a Business Service's schema and to see where the Business Service is used in the system. Open this page using **Admin Menu > Business Service** and then navigate to the **Schema** tab.

Description of Page

The contents of this section describe the zones that are available on this portal page.

The **General Information** zone displays main attributes of the business service.

The **Schema Designer** zone allows you to edit the business service's schema. The purpose of the schema is to map the business service's elements to the corresponding fields of the backend service program it rides on.

Note: Schema Definition Tips. A context sensitive "Schema Tips" zone is associated with this page. The zone provides a complete list of the XML nodes and attributes available to you when you construct a schema.

The **Schema Usage Tree** zone summarizes all cross-references to this schema. These may be other schemas, scripts, and XAI Inbound Services. For each type of referencing entity, the *tree* displays a summary node showing a total count of referencing items. The summary node appears if at least one referencing item exists. Expand the node to list the referencing items and use their description to navigate to their corresponding pages.

User Interface (UI) Maps

The User Interface (UI) map holds HTML to be rendered within *portal zones* and *Business Process Assistant (BPA) scripts*. UI maps allow your implementation to create input forms and output maps that closely match your customer's business practices. In other words, the UI Map is designed to facilitate the capture and display of your *business objects* and *business services*.

The UI map is a repository for a single HTML document paired with an XML schema where the schema defines the data that the HTML document displays and/or modifies. The UI Map HTML gives you the ability to craft the display by any method that an html document can support, including JavaScript and full CSS functionality.

Configuration tool support for UI Maps hinges around the ability to inject and extract an XML document from the HTML. For more information on the specialized support for HTML and JavaScript functionality - please refer to the HTML tips document (more on this below).

```

<html>
<head>
<title>Output Personal Information</title>
<link rel="stylesheet" type="text/css" href="cm_templates/cmStyles.css"/>
</head>
<body>

<table width="100%" border="0" cellpadding="2" style="margin-top:15px;" >

  <tr>
    <td/>
    <td/> <!-- locate the edit button on the bottom of the third column -->
    <td rowspan="99" style="vertical-align:bottom; margin-left:5px">
      <input type="button" value="edit" onClick="oraRunScript('HumanInfoU','personId');"/>
    </td>
  </tr>

  <tr>
    <td class="outputLabel">Name:</td>
    <td><span oraField="name" class="outputData"></span></td>
  </tr>
  <tr>
    <td class="outputLabel">Home Phone:</td>
    <td><span oraField="homePhone" class="outputData"></span></td>
  </tr>
  <tr>
    <td class="outputLabel">Business Phone:</td>
    <td><span oraField="businessPhone" class="outputData"></span></td>
  </tr>
  <tr>
    <td class="outputLabel">Cell Phone:</td>
    <td><span oraField="cellPhone" class="outputData"></span></td>
  </tr>
  <tr>
    <td class="outputLabel">FAX:</td>
    <td><span oraField="fax" class="outputData"></span></td>
  </tr>
  <tr>
    <td class="outputLabel">Social Security:</td>
    <td><span oraField="socialSecurity" class="outputData"></span></td>
  </tr>
  <tr>
    <td class="outputLabel">Drivers License:</td>
    <td><span oraField="driversLicense" class="outputData"></span></td>
  </tr>
  <tr>
    <td class="outputLabel">Email:</td>
    <td><span oraField="email" class="outputData"></span></td>
  </tr>

</table>

</body>

<xml>
<root>
  <name>Greer, Johan</name>
  <email>jurgen.greer@media.com</email>
  <socialSecurity>939-30-3939</socialSecurity>
  <driversLicense>C8392020</driversLicense>
  <homePhone>(838) 030-0303</homePhone>
  <cellPhone>(444) 444-4040</cellPhone>
  <businessPhone>(737) 393-3838</businessPhone>
  <fax>(373) 939-3939</fax>
  <personId>1239997654</personId>
</root>
</xml>
</html>

```

Figure 27: HTML to Display Customer Business Object

Name:	Greer, Johan
Home Phone:	(838) 030-0303
Business Phone:	(737) 393-3838
Cell Phone:	(444) 444-4040
FAX:	(373) 939-3939
Social Security:	939-30-3939
Drivers License:	C8392020
Email:	jurgen.greer@media.com <input type="button" value="edit"/>

Figure 28: Customer HTML Rendered (Output Data for Zone)

UI maps are typically crafted as output tables when used in conjunction with portal zones - please refer to [Map Zones](#) for more information. When referenced within [BPA scripts](#), UI maps are typically crafted as forms for the capture and update of data.



Figure 29: HTML Input Form Rendered (for BPA Script)

Portal zones can reference a UI map for the zone header. They may also utilize a UI map to define their filter area. This type of UI map is not a complete HTML document, but is instead configured as a UI Map "fragment".

Note: UI Map Tips. A context sensitive "UI Map Tips" zone appears when you open the [UI Map](#) page to assist you with the HTML document and schema definition syntax. The "tips" describe methods to take advantage of the configuration tools, however, they are not an HTML reference.

Note: Editing HTML. You can use a variety of HTML editors to compose your HTML, which you can then cut, and paste into your UI map. In addition, the zone provides a complete list of the XML schema nodes and attributes available to you when you construct the map's data schema.

Defining UI Maps

The topics in this section describe how to maintain UI Maps.

UI Map - Main

Use this page to define basic information about a user interface (UI) Map. Open this page using **Admin Menu > UI Map**.

Description of Page

Enter a unique **Map** name. **Owner** indicates if the UI map is owned by the base package or by your implementation (**Customer Modification**).

Caution: Important! If you introduce a new UI map, carefully consider its naming convention. Refer to [System Data Naming Convention](#) for more information.

Use **UI Map Type** to indicate whether the map is a **Complete HTML Document** or an **HTML Fragment**. Portal zones can reference a UI map to describe a fragment of their HTML, for example the zone header or filter area. In this case the UI map is not a complete HTML document, but is instead configured as a UI Map "fragment".

Note: How used. A context sensitive "UI Map Tips" zone is associated with this page to assist you with the HTML document definition syntax. Refer to the tips zone for more information on how to use fragment UI maps to construct portal zone HTML components.

Enter a **Description**. Use the **Detailed Description** to describe how this map is used in detail.

Click on the **View Schema** to view the UI map's expanded schema definition. Doing this opens the *schema viewer* window.

Use the **Test UI Map** hyperlink to render your html in a test window.

Note: Testing your map. You can use the **Test UI Map** hyperlink to render your map's html. Importantly, the hyperlink also exercises the proprietary functionality that binds an xml element with an html element so you can get immediate feedback on your html syntax.

Where Used

Follow this link to open the data dictionary to view the tables that reference [FI_MAP](#).

UI Map - Schema

Use this page to maintain a UI Map's HTML and schema and to see where the UI Map is used in the system. Open this page using **Admin Menu > UI Map** and then navigate to the **Schema** tab.

Description of Page

The contents of this section describe the zones that are available on this portal page.

The **General Information** zone displays main attributes of the UI Map.

The **HTML Editor** zone allows you to edit the HTML document of the map.

Note: HTML Definition Tips. A context sensitive "UI Map Tips" zone is associated with this page to assist you with the HTML document definition syntax. The "tips" describe good ways to produce simple HTML, however, they are not an HTML reference. Note that you can use a variety of HTML editors to compose your HTML, which you can then cut and paste into your UI map.

Note: Providing Help. A *tool tip* can be used to display additional help information to the user. This applies to section elements as well as individual elements on a map. Refer to the tips context sensitive zone for more information on how to enable and provide UI map help.

The *Schema Designer* zone allows you to edit the data schema part of the map. The purpose of the schema is to describe the data elements being displayed by the map.

Note: Schema Definition Tips. The same "UI Map Tips" zone above also provides a complete list of the XML nodes and attributes available to you when you construct the map's data schema.

The **Schema Usage Tree** zone summarizes all cross-references to this schema. These may be other schemas, scripts, and XAI Inbound Services. For each type of referencing entity, the *tree* displays a summary node showing a total count of referencing items. The summary node appears if at least one referencing item exists. Expand the node to list the referencing items and use their description to navigate to their corresponding pages.

UI Hints

UI Hints are tags and elements that allow dynamic generation of formatted UI Maps. For example, UI Hints can be used as an alternative to manually creating maintenance and display UI Maps for business objects, thereby reducing the amount

of time and technical expertise needed for creating those objects. UI Hints can also be added to the schemas on business services, service scripts, data areas, and UI maps. If you develop a BO using UI Hints, you should use them for the other configuration tool schemas for the BO, such as the data areas, UI map fragments, and display service scripts.

Additional information, including a list of working business objects that use UI Hints, is available in the context sensitive “Tips” zone on the schema pages for the above configuration tools.

Ensuring Unique Element IDs for UI Maps

Note: The procedures described in this topic apply only to UI Maps in Oracle Utilities Customer Care and Billing version 2.4.0.0.

The following describes how to modify JavaScript code to ensure the proper rendering of unique element IDs for UI Maps in Customer Care and Billing 2.4.0.0.

The modification is required only for code that renders HTML using a `getElementById()` (or similar) function to generate list IDs and avoid account verification or related errors.

The following sample snippet contains the necessary modifications:

```
...
function getElementsFromList(namePrefix) {
var ret = [];
var elements = document.getElementsByTagName("INPUT");
for(var i=0;i<elements.length;i++) {
var elemID = elements[i].id;
if((id) && (id.startsWith(namePrefix + '_')) {
ret.push(elements[i]);
}
}
...
return ret;
}
```

Since IDs aren't necessarily unique in generated UI Map IDs, the code shown above ensures uniqueness at runtime by appending an underscore and row number (e.g., `myField_1`, `myField_2`) for proper handling by Framework in the rendered HTML, while still allowing you to reference the unmodified IDs contained in the generated UI Map.

A switch in the `spl.properties` file also permits you to disable the generation of unique IDs for elements in a grid (as described below), though, for standards compliance reasons, it is highly recommended that this switch be left at its default value.

```
Property Name: spl.runtime.compatibility.uiMapDisableGenerateUniqueHtmlIDs
File Name: spl.properties (under web project in FW)
Default Value: false
Accepted Values: true or false
Description: This property controls the generation of unique IDs for all input elements
inside a list. When this value is set to true it disables the generation of unique IDs,
thus replicating the old behavior. When this property is set to false or this property is
missing it enables the generation of unique IDs, thus enabling the list to be standards-
compliant.
```

Maintaining Managed Content

The Managed Content maintenance object is used to store content such as XSL files used to create vector charts, JavaScript include files, and CSS files. These files may then be maintained in the same manner as the HTML in UI Maps.

The topics in this section describe the Managed Content portal.

Managed Content - Main

This page is used to define basic information about the content. Open this page using **Admin > Managed Content** .

Description of Page

Enter a unique name for the content in the **Managed Content** field.

Owner indicates if the content is owned by the base package or by your implementation.

Use **Managed Content Type** to indicate the type of content, for example, XSLT or Javascript.

Enter a **Description**.

Use the **Detailed Description** to describe in detail how this map is used.

Managed Content - Schema

This page is used to create and maintain the managed content. Open this page using **Admin > Managed Content** and then navigate to the **Schema** tab.

Description of Page

The General Information zone displays the main attributes of the content. The Editor zone allows you to edit the content.

Data Areas

The data area has no business purpose other than to provide a common schema location for re-used schema structures. It exists solely to help eliminate redundant element declaration. For example, if you have multiple schemas that share a common structure, you can set up a stand-alone data area schema for the common elements and then include it in each of the other schemas.

Be aware that a stand-alone data area can hold elements that are mapped to true fields. For example, you might have 50 different types of field activities and all might share a common set of elements to identify where and when the activity should take place. It would be wise to declare the elements that are common for all in a stand-alone data area and then include it in the 50 field activity business objects.

It's strongly recommended that you take advantage of stand-alone data areas to avoid redundant data definition!

Caution: Dynamic inclusion! When the system renders a schema, all schemas included within it are expanded real-time. This means that any change you make to a data area will take affect immediately within all schemas it is referenced within.

Note: Schema Definition Tips. A context sensitive "Schema Tips" zone appears when you open the [Data Area](#) page to assist you with the schema definition syntax. The zone provides a complete list of the XML nodes and attributes available to you when you construct a schema.

Defining Data Areas

The topics in this section describe how to maintain Data Areas.

Data Area - Main

Use this page to define basic information about a data area. Open this page using **Admin Menu > Data Area**.

Description of Page

Enter a unique **Data Area** name and **Description**. Use the **Detailed Description** to describe what this data area defines in detail. **Owner** indicates if the data area is owned by the base package or by your implementation (**Customer Modification**).

Caution: Important! If you introduce a new data area, carefully consider its naming convention. Refer to [System Data Naming Convention](#) for more information.

Click on the **View Schema** to view the data area's expanded schema definition. Doing this opens the [schema viewer](#) window.

To extend another data area, reference that data area in the **Extended Data Area** field. By extending a data area you can add additional elements to a base product data area.

Here's an example of an extended data area:

- The product releases with data area A, which contains elements a, b, and c.
- Your implementation creates data area CM-A, which contains element z, and references data area A as the extended data area.
- At run time, everywhere data area A is included it will contain elements a, b, c, and z.

Where Used

Follow this link to open the data dictionary to view the tables that reference [FI_DATA_AREA](#).

Data Area - Schema

Use this page to maintain a Data Area's schema and to see where the data area is used in the system. Open this page using **Admin Menu > Data Area** and then navigate to the **Schema** tab.

Description of Page

The contents of this section describe the zones that are available on this portal page.

The **General Information** zone displays the main attributes of the data area.

The [Schema Designer](#) zone allows you to edit the data area's schema. The purpose of the schema is to describe the structure and elements of the data area.

Note: Schema Definition Tips. A context sensitive "Schema Tips" zone is associated with this page. The zone provides a complete list of the XML nodes and attributes available to you when you construct a schema.

The **Schema Usage Tree** zone summarizes all cross-references to this schema. These may be other schemas, scripts, and XAI Inbound Services. For each type of referencing entity, the [tree](#) displays a summary node showing a total count of referencing items. The summary node appears if at least one referencing item exists. Expand the node to list the referencing items and use their description to navigate to their corresponding pages.

Schema Designer

The Schema Designer is a Framework component that offers a user-friendly interface for performing the following common schema editing tasks:

- Displaying existing schemas.
- Creating schema elements.
- Moving elements within a schema.
- Adding attribute values.
- Defining "flattened" fields.
- Adding custom nodes.
- Adding custom attribute values.

The designer provides the ability to toggle between **Design** and **Source** modes by clicking the icons on the **Schema Designer** title bar:



In the graphical **Design** mode, the zone is split into two areas: the left pane displays elements of the schema in a tree-like presentation, while the right pane displays all valid attributes and values for selected schema elements.

Context-sensitive embedded help is provided for fields and controls in the right pane by clicking the Help icon .

You can also use links in the **Schema Tips** zone in the dashboard area to open a navigable Help window containing schema-related topics and tips. To search topic content, press `Ctrl+F` when the Schema Tips Help window has focus.

The **Schema Designer** is available by choosing the **Schema** tab on the [Business Object](#), [Data Area](#), [UI Map](#), [Business Service](#), and [Script](#) pages.

Schema Viewer

The schema viewer shows a tree-view presentation of a schema in its expanded form.

The schema illustrates the structure to be used when communicating with the schema's associated object. The following takes place when a schema is expanded:

- If the schema definition includes references to other schemas, these references are replaced with the corresponding schema definitions.
- Also, if the schema definition contains **private** elements, they are omitted from this view.

Clicking on any node on the tree populates the text box on the top with the node's absolute XPath expression. You will find this feature very useful when writing scripts interacting with schema-based objects. *Scripting* often involves referencing elements in a schema-based XML document using their absolute XPath expression. You can use this feature on the schema viewer to obtain the XPath expression for an element and copy it over to your script.

Business Event Log

Business Event Log may be viewed as a tool designed to capture any type of business event worth noting. You configure business objects to represent the various types of events your application calls for. The following type of details may be captured for each event:

- The business object representing the type of event.
- The date and time the event took place and who initiated it.
- The business entity for which this event is logged.

- Standard application message to describe the event.
- Additional context information that is available at the time of the event and varies for each type of event. The Business Event Log maintenance object supports a standard characteristics collection as well as an XML storage (CLOB) field. The event's business object determines where each piece of information resides. Refer to [Business Objects](#) for more information.

One common type of event may be the audit of changes made to sensitive data, for example, tracking an address change. Whenever an entity associated with a business object is added, changed, or deleted the system summarizes the list of changes that took place in that transaction and hands them over to **Audit** business object algorithms to process. You may design such an algorithm to audit the changes as business event logs. Refer to [a business object may define business rules](#) for more information.

You can also allow users to initiate business event logs to capture important notes about a business entity by exposing a [BPA Script](#) to invoke the event's corresponding business object.

Bottom line is that any process can create a business event log by invoking the business object representing the appropriate type of event.

Where Used

Follow this link to open the data dictionary where you can view the tables that reference [FI_BUS_EVT_LOG](#).

Chapter 19

Configuring Facts

Fact is an optional configuration tool for simple workflow-type business messages or tasks. The base package does not provide a dedicated Fact user interface because fact is generic by design. Implementations configure their own user interface to visualize the desired custom business process. The topics in this section describe the generic Fact entity and how it can be customized.

Fact Is A Generic Entity

The Fact maintenance object is a generic entity that can be configured to represent custom entities and support automated workflows for a variety of applications. Each fact references a business object to describe the type of entity it is. A status column on the fact may be used to capture its current state in the processing lifecycle controlled by its business object.

The maintenance object also supports a standard characteristic collection as well as a CLOB element to capture additional information.

Where Used

Follow this link to open the data dictionary where you can view the tables that reference [F1_FACT](#)

Fact's Business Object Controls Everything

A fact's business object controls its contents, lifecycle and various other business rules:

- Its schema defines where each piece of information resides on the physical Fact maintenance object.
- It may define a lifecycle for all fact instances of this type to follow. Each fact must exist in a valid state as per its business object's lifecycle definition.
- It may define validation and other business rules to control the behavior of facts of this type.

Fastpath: For more information about business objects, refer to [The Big Picture of Business Objects](#).

Fact Supports A Log

The Fact maintenance object supports a log. Any significant event related to a Fact may be recorded on its log. The system automatically records a log record when the fact is created and when it transitions into a new state. In addition, any custom process or manual user activity can add log entries.

Fastpath:

Refer to [State Transitions Are Audited](#) for more information on logging. For more information about the various configuration tools available, refer to [Configuration Tools](#). For more information about user interfaces, refer to [Configurable User Interface Features](#).