

A7.3

PTF INSTALL WORKBOOK

J.D. Edwards World Source Company
One Technology Way
Denver, CO 80237

Copyright ©J.D. Edwards World Source Company, 1996, 1998
All Rights Reserved

J.D. Edwards is a registered trademark of J.D. Edwards & Company. The names of all other products and services of J.D. Edwards used herein are trademarks or registered trademarks of J.D. Edwards World Source Company.

All other product names used are trademarks or registered trademarks of their respective owners.

The information in this guide is confidential and a proprietary trade secret of J.D. Edwards World Source Company. It may not be copied, distributed, or disclosed without prior written permission. This guide is subject to change without notice and does not represent a commitment on the part of J.D. Edwards & Company and/or its subsidiaries. The software described in this guide is furnished under a license agreement and may be used or copied only in accordance with the terms of the agreement. J.D. Edwards World Source Company uses automatic software disabling routines to monitor the license agreement. For more details about these routines, please refer to the technical product documentation.

This publication was revised 03/98

IMPORTANT: You must be on Version 3, Release 1, Modification 0 (V3R1M0), or IBM's current general availability level, of the AS/400 operating system to install this upgrade software.

TECHNICAL ASSISTANCE

Call the appropriate phone number in the chart below if you have problems installing this software during regular business hours.

LOCATION	PHONE NUMBER	HOURS (Monday through Friday)
The Americas	From the U.S. or Canada, call the 800 toll-free number J.D. Edwards gave to you if you subscribe to the J.D. Edwards annual maintenance program (customer support and software updates). If you do not subscribe, or if you are outside the U.S. or Canada, call (303) 334-4000 and ask for J.D. Edwards Worldwide Customer Support.	6:00 a.m. to 6:00 p.m., Mountain Time
Europe, Middle East, and Africa	Call 44-1494-682682.	8:00 a.m. to 6:00 p.m., Greenwich Mean Time
Asia Pacific	Call 65-229-1656.	8:00 a.m. to 6:00 p.m., Singapore Time

AFTER HOURS TECHNICAL ASSISTANCE

If you have emergency problems installing your software during hours other than those shown in the chart above, you can use our 24-hour customer support (same phone number as above) if:

- You have purchased the two-day blocks of 48-hour customer support, or
- You have contracted and paid for PREMIER maintenance services.

TRAINING CONSIDERATIONS

The updates described in this publication could affect how your staff uses J.D. Edwards software. Please make arrangements to train your staff concerning these updates.

Survey of the PTF Installation Procedures

Please use this form to send in your comments and questions about this document or the PTF installation process. We will use the information you provide to improve the process and enhance the *PTF Install Workbook*. Please cut along the vertical dashed line, then fold and tape with the J.D. Edwards address showing. No postage is required.

Your Name	Title	
Company Name		
Phone	Date	Release Level
AS/400 ___ S/38 ___	Model	Total Disk Space

1. Check those product groups you have installed on your system.

Core ___	Job Cost ___	Manufacturing ___
Distribution ___	FASTR ___	Property Management ___
Fixed Assets ___	Energy ___	Contract Administration ___
Work Orders ___	Payroll ___	Human Resources ___
		World Writer ___

2. How many hours were required to complete the installation? ___ The application specific instructions (ASIs) and any other post-installation procedures you performed? _____

To answer the next three questions, circle one of the numbers at the end of each question where: 4=Excellent, 3=Good, 2=Fair, 1=Poor (If you wish, you can substitute a decimal, for example, 3.5, to indicate between excellent and good).

3. I found the format of the *PTF Install Workbook* to be: 1 2 3 4
4. The instructions for the installation were: 1 2 3 4
5. The application specific instructions (ASIs) were: 1 2 3 4
6. Please indicate any information that would have been helpful before starting the installation.
7. Was this installation easier than previous installations? Yes ___ Same ___ No ___
8. Please provide any suggestions or ideas for improving the installation and the *PTF Install Workbook*.
9. Please indicate any major problems you had during the installation.

Note: If necessary, use additional pages for your comments. (May require separate envelope.)

J.D. Edwards PTF Installation Survey

Fold and Tape

Please Do Not Staple

Fold and Tape



NO POSTAGE
NECESSARY
IF MAILED
IN THE
UNITED STATES

BUSINESS REPLY MAIL

FIRST CLASS MAIL PERMIT NO. 1826 DENVER, CO.

POSTAGE WILL BE BY ADDRESSEE

JDEdwards®

ONE TECHNOLOGY WAY
DENVER CO 80237

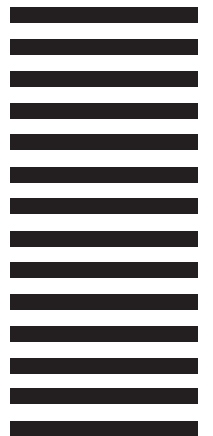

Fold and Tape

Please Do Not Staple

Fold and Tape



Table of Contents

Phase 1 – Plan the PTF Installation

Using the Checklist	1
What You Must Know	1
Considerations	3
Preliminary Procedures	8

Phase 2A – Install the PTF (One-Step Method)

Checklist	21
-----------------	----

Phase 2B – Install the PTF (Two-Step Method)

Checklist	27
First Part of the PTF Installation Process (PTF_STEP1)	27
Second Part of the PTF Installation Process (PTF_STEP2)	30

Phase 3 – Update Applications

Checklist	35
-----------------	----

Phase 4 – Create Files and Run Jobs

Checklist	47
-----------------	----

Phase 5 – Review Reports

Checklist	53
-----------------	----

Appendix A – Control File Dependencies

Control File Sets	A –1
-------------------------	------

Appendix B – LODRUN Command

Overview of the LODRUN Command	B –1
--------------------------------------	------

Appendix C – Upgrade Planner Screens

Plan the Upgrade Screen C -1
Libraries for This Plan Screen C -3
Systems to Install/Upgrade Screen C -6
Merge Information Screen C -7
Printer Information Screen C -15
Advanced Options Screen C -17

Appendix D – Change Decimal Character

Checklist D -1



Phase 1 – Plan the PTF Installation

This publication describes how to install a PTF for J.D. Edwards World Systems on an AS/400 computer system. In this publication, *PTF* means a cumulative PTF, an unscheduled PTF, or an untested quick fix. For general information about these PTF types, refer to *Introduction* in the *Upgrade Reference Guide*.

The easy-to-use checklist guides you through the steps that upgrade your J.D. Edwards systems to the shipped PTF level.

Using the Checklist

Read the checklist items consecutively and perform the procedures. A hollow box precedes each item. After you read an item and perform the procedure, put a check mark in the box. Do not skip items unless you are instructed to do so.

What You Must Know

- What this publication assumes.** This publication assumes you are converting to the PTF level from no earlier than release level A7.3.
- What you must know.**
 1. A working knowledge of the AS/400 operating system (OS/400) Version 3 Release 1 or later releases
 2. IBM keyboard functions
 3. A working knowledge of J.D. Edwards software, such as how to change a menu and update DREAM Writer versions

- ❑ **Some conventions.** In this workbook, **Enter** means type the information shown and press the Enter key, **Type** means type the information without pressing the Enter key, and **Select** means type the number that appears next to a menu selection and press the Enter key.

In addition, *tape* means a storage medium, such as a tape, cassette, or cartridge.

- ❑ **Technical support.** Call the appropriate phone number in the chart below if you have problems installing this software during regular business hours.

LOCATION	PHONE NUMBER	HOURS (Monday–Friday)
The Americas	From the U.S. or Canada, call the 800 toll-free number J.D. Edwards gave to you if you subscribe to the J.D. Edwards annual maintenance program (customer support and software updates). If you do not subscribe, or if you are outside the U.S. or Canada, call (303) 488-4000 and ask for J.D. Edwards Worldwide Customer Support.	6:00 a.m. to 6:00 p.m., Mountain Time
Europe, Middle East, and Africa	Call 44-1494-682682.	8:00 a.m. to 6:00 p.m., Greenwich Mean Time
Asia Pacific	Call 65-229-1656.	8:00 a.m. to 6:00 p.m., Singapore Time

If you have emergency problems installing your software during hours other than those shown in the previous chart, you can use our 24-hour customer support (same phone number as above) if:

- You have purchased the two-day blocks of 48-hour customer support, or
- You have contracted and paid for PREMIER maintenance services

□ How the PTF installation works.

Process Flow

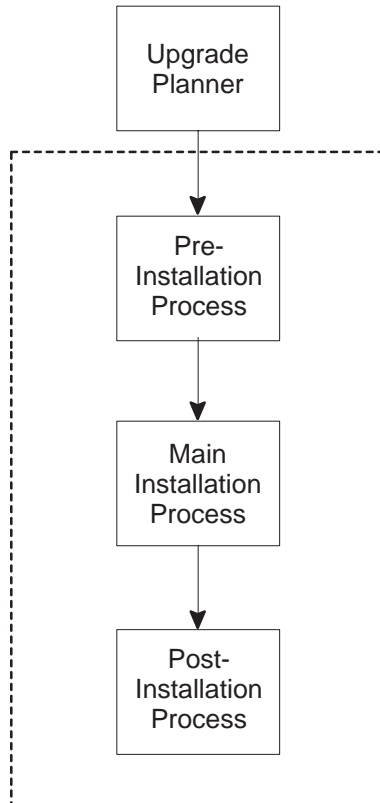

Process Highlights

- Issue the LODRUN command
- Create upgrade plans for environments
- Validate upgrade plans

- Sign off all users
- Back up all libraries

- Restore J.D. Edwards object, source, and data
- Convert control files (if necessary)
- Merge control files
- Convert data files (if necessary)

- Update menus and data dictionary
- Apply the ASIs
- Create new data files (if necessary)
- Rebuild menu word search facility (if necessary)
- Run special application jobs (if necessary)
- Review PTF installation reports

Considerations

- **Upgrade plan definition.** You will create one or more upgrade plans for the PTF installation process. When you create your plans, you must observe the following special rule when you define the libraries in each upgrade plan:

A file cannot exist in more than one library defined in the upgrade plan (with the exception of the J.D. Edwards data library)

The following illustrations shows valid and invalid upgrade plans.

Valid Plan

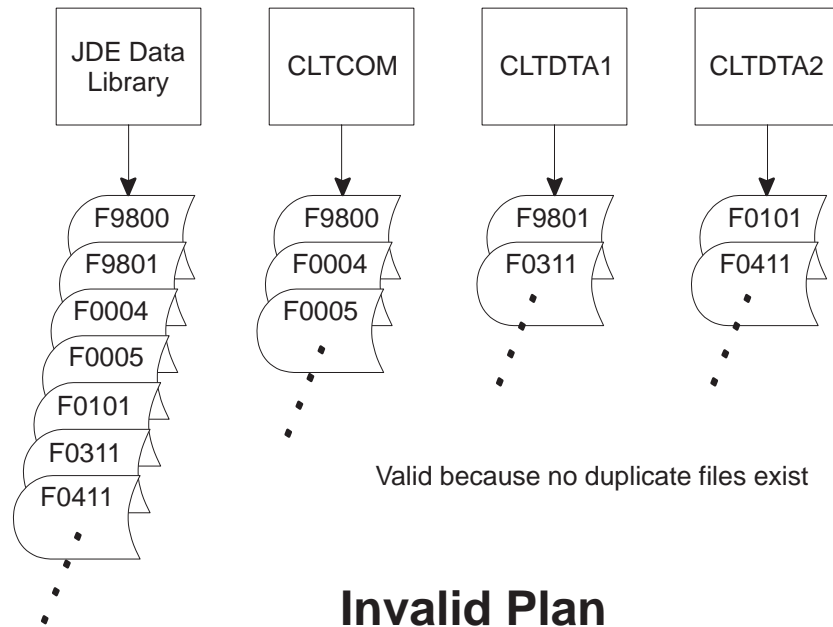

Invalid Plan

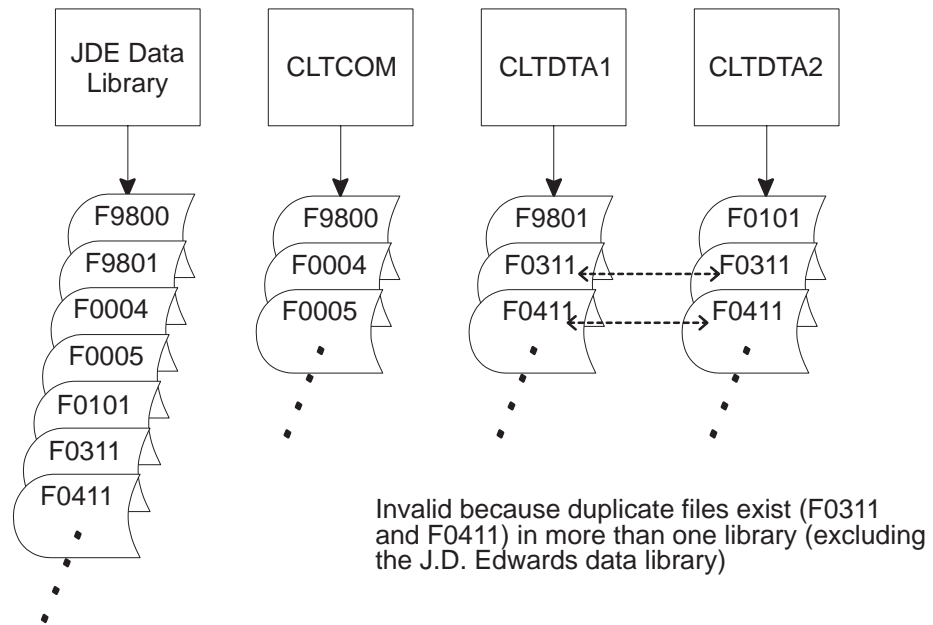

If the libraries you want to upgrade are set up as shown in the invalid plan, you must use the multi-plan upgrade process, which is described in the following checklist item.

- ❑ **Multi-plan upgrade process.** If you have multiple production libraries (data and/or common) to convert that will require multiple upgrade plans because of the duplicate files rule in the previous checklist item, J.D. Edwards gives you a way to upgrade those libraries in a single action.

Assumptions for three possible multi-plan scenarios are given in this section. Determine the one that matches your situation, then review the associated method (for example, Method A if your situation matches Scenario A) in *Install PTF to Multiple Environments* in the *Upgrade Reference Guide*. Each method has its own ZJDE model plans you can use to create your upgrade plans.

NOTE: Special considerations for multi-plan upgrades are noted in boxed areas throughout this workbook.

■ **Scenario A**

You have multiple environments where each has its own production data library, but shares the same common, object, J.D. Edwards data, source (optional), and security libraries with the other environments.

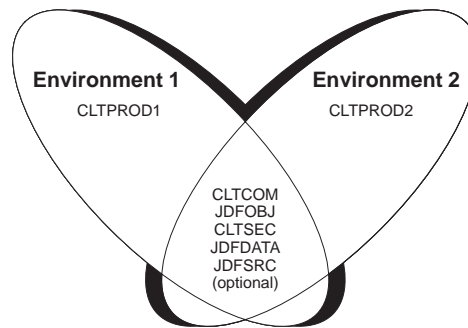

J.D. Edwards assumes that the shared common library contains all of the following common files and their associated logicals:

F0004	F0083	F9205	F9816
F0005	F81901	F9220	F98163
F0016	F81902	F9601	F98301
F00161	F9200	F9611	F98302
F00162	F9201	F9620	F98303
F00163	F9202	F9621	F9831
F0082	F9203	F9801	F98311
F00821	F9204	F9802	F98312

F126* (if you have system 12)

F83* (if you have system 83)

Use the ZJDE_A1 model plan for your first environment, and ZJDE_A2 for the second one.

If this scenario matches your situation, refer to Method A procedures in *Install PTF to Multiple Environments* in the *Upgrade Reference Guide*.

■ Scenario B

You have multiple environments where each has its own production data and common libraries, but shares the same object, J.D. Edwards data, source (optional), and security libraries with the other environments.

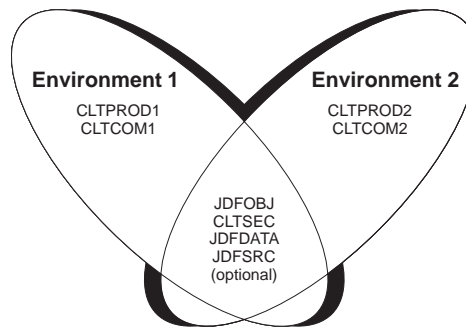

Use the ZJDE_B1 model plan for your first environment, and ZJDE_B2 for the second one.

If this scenario matches your situation, refer to Method B procedures in *Install PTF to Multiple Environments* in the *Upgrade Reference Guide*.

■ Scenario C

You have multiple environments where each has its own production data library, but shares the same common, object, J.D. Edwards data, source (optional), and security libraries. Each production library contains one or more of the common files, and the shared common library contains the remaining common files.

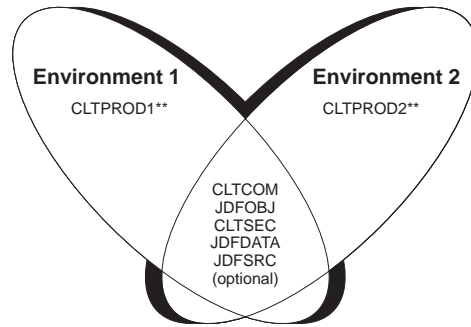

** includes some common files such as F0090

J.D. Edwards assumes that the production data libraries contain one or more of the following common files and their associated logicals:

F0004	F0083	F9205	F9816
F0005	F81901	F9220	F98163
F0016	F81902	F9601	F98301
F00161	F9200	F9611	F98302
F00162	F9201	F9620	F98303
F00163	F9202	F9621	F9831
F0082	F9203	F9801	F98311
F00821	F9204	F9802	F98312

F126* (if you have system 12)
 F83* (if you have system 83)

Use the ZJDE_C1 model plan for your first environment, and ZJDE_C2 for the second one.

NOTE: The model plans for this scenario assume that the production data libraries contain the Menu Master file (F0082). You must adjust your plan if the production data libraries contain different common files.

If this scenario matches your situation, refer to Method C procedures in *Install PTF to Multiple Environments* in the *Upgrade Reference Guide*.

- ❑ **Control file dependencies.** To avoid problems when you use or upgrade J.D. Edwards software, make sure specific sets of control files and their associated logical files are together in the same library on your machine. For a list of the control files, see *Appendix A – Control File Dependencies*.

Preliminary Procedures

- ❑ **Issue the LODRUN command.** After you mount the first PTF installation tape, you must use the LODRUN command, which is a standard IBM command, to update the upgrade planner library (JDFINS) and the installation library (JDEINSTAL). For information about what the command does, see *Appendix B – LODRUN Command*.
1. Sign on as QSECOFR or a profile that has QSECOFR as the group profile (not JDEINSTAL).

NOTE: When you run the LODRUN command, the JDEINSTAL profile will be created on your machine if it does not exist already.

2. From the command entry line, enter LODRUN *device* where *device* is your tape device name (for example, TAP01).

NOTE: To find a valid tape device name, at the command entry line, enter WRKCFGSTS CFGTYPE(*DEV) CFGD(*TAP). This displays all tape device names on your system. Choose one that matches the type of tape you received with your A7.3 materials.

The system sends you messages that show the progress of the LODRUN process.

At the end of the LODRUN process, you will receive a message that asks you to sign on as JDEINSTAL. After you sign on, the Software Upgrade Menu appears.

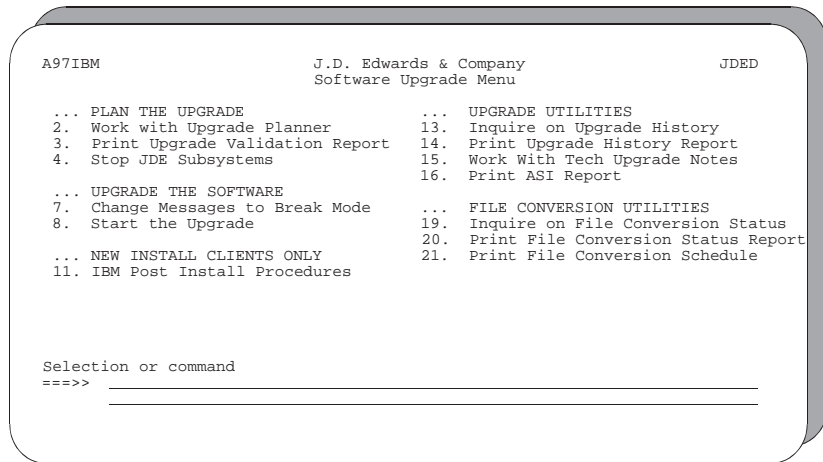

Print ASI Report. After the automatic portion of the upgrade completes, you may need to update your J.D. Edwards application systems by applying application specific instructions (ASIs) and running special application jobs. You can better prepare to do these by printing the ASIs and the special application jobs information (explained in the next checklist item) before starting the upgrade process.

1. From the Software Upgrade Menu (A97IBM), select Print ASI Report.
2. From the screen that appears, enter the name of the object library in your production environment (such as JDFOBJ) and the appropriate release level information. If you want to print the ASIs for previous PTFs, enter Y in the Print ASIs for Previous PTFs field. Otherwise, leave the field set to N.
3. After the job completes, print the R98490 report. You will use this report later in this workbook.

Print special application jobs information.

1. From the Software Upgrade Menu (A97IBM), select Work With Tech Upgrade Notes.

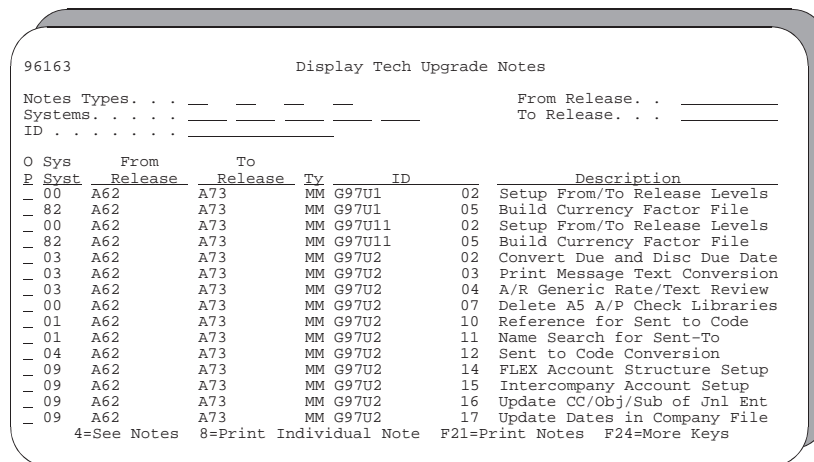

2. From the Display Tech Upgrade Notes screen, type MM in the first Notes Types field.
3. In the From Release Level field, type A73.
4. In the To Release Level field, enter the PTF level to which you want to upgrade (for example, A73PC00001).

A list of menu message (MM) items appears for any special application jobs required for this PTF. If the screen does not list any menu message items, skip to the next checklist item.

5. Press F21 (Print Notes).
6. After the job completes, print the R9616 report.

NOTE: You can use the Work With Tech Upgrade program to display and print other types of information, such as file changes, program changes, and SAR information. For more information about using this program, refer to the *Upgrade Reference Guide*.

- ❑ **Access the upgrade planner.** From the Software Upgrade Menu (A97IBM), select Work with Upgrade Planner. The Plan the Upgrade screen appears.

```

960099                                Plan the Upgrade
Action Code. . . I
Plan Name. . . ZJDE
Description. . . SIMPLE PRODUCTION PLAN

Enter the name of a plan.

You can choose one of the following or copy them
to create your own plan. Note that "ZJDE" plans
cannot be changed or deleted.

We RECOMMEND you review the following:

      ZJDE      - Simple Production Plan
      ZJDE_ALT - Alternate Upgrade Plan

** Press F5 key to enter upgrade data **

      F3=Exit      F24=More Keys

```

This screen is the first of a series of upgrade planner screens, all of which are described in checklist items that follow below. For detailed information about the screens, see *Appendix C – Upgrade Planner Screens*.

- ❑ **Create an upgrade plan.**

The Plan the Upgrade screen lets you begin to add or change an environment upgrade plan. J.D. Edwards recommends that you use the ZJDE upgrade plan model to create your plan.

MULTI-PLANS: If you are upgrading multiple environments, refer to *Install PTF to Multiple Environments* in the *Upgrade Reference Guide* to determine which of three scenarios best describes your environment setup. Use the appropriate ZJDE plan models indicated to create your upgrade plans.

1. From the Plan the Upgrade screen, inquire on ZJDE (an upgrade plan model supplied by J.D. Edwards).
2. In the Action Code field, type A (Add).
3. In the Plan Name field, type a name for the new upgrade plan.

IMPORTANT: Do not begin your plan name with ZJDE or use special characters except underscore (_).
4. In the Description field, type a description for the new upgrade plan.
5. To add the new upgrade plan, press Enter.

6. Inquire on the new upgrade plan, and then press F5.

The Libraries for This Plan screen appears.

```
96003                               Plan the Upgrade           Screen 1 of 3
                               Libraries for this plan

Plan Name. . . . . ZJDE           SIMPLE PRODUCTION PLAN

Specify all libraries for this plan that contain J.D. Edwards
files and programs.  Exclude IBM libraries such as QGPL and QTEMP.
Specify current software release level and the release to upgrade to.
Current JDE Release Level . . . . . A73
New JDE Release Level . . . . . A73PC000xx

Install Source Library. . . . . 0   (1=Yes, 0=No)
Install Object/Data Libraries . . 1

Lib   Library      Library
Typ   Name         Description
COM   CLTCOM       Client's Common Library
DTA   CLTDTA       Client's Data Library
SEC   CLTSEC       Client's Security Library
JDE   JDFDATA     JDE Data Library
OBJ   JDFOBJ       JDE Object Library
SRC   JDFSRC       JDE Source Library

ENTER=Update/Next Screen   F12=Previous Screen   F24=More Keys
```

□ Indicate the libraries for this plan.

The Libraries for This Plan screen lets you specify your current and new J.D. Edwards release levels, whether you want to install object and data only or source only, and the libraries that define one environment.

Be sure that the Current JDE Release Level field is set to A73, and the New JDE Release Level field is set to the PTF level you want to install (for example, A73PC00001).

MULTI-PLANS: All plans must have the same Current and New JDE Release Level values. They also must have the same object, J.D. Edwards data, and source library names (library types OBJ, JDF, and SRC).

After you make changes to this screen, press Enter twice.

NOTE: If one or more libraries you specify on this screen do not exist on your machine, the Create Plan Library screen appears. Verify the name of the library, or change it, and then press Enter to create it.

The Systems to Install/Upgrade screen appears.

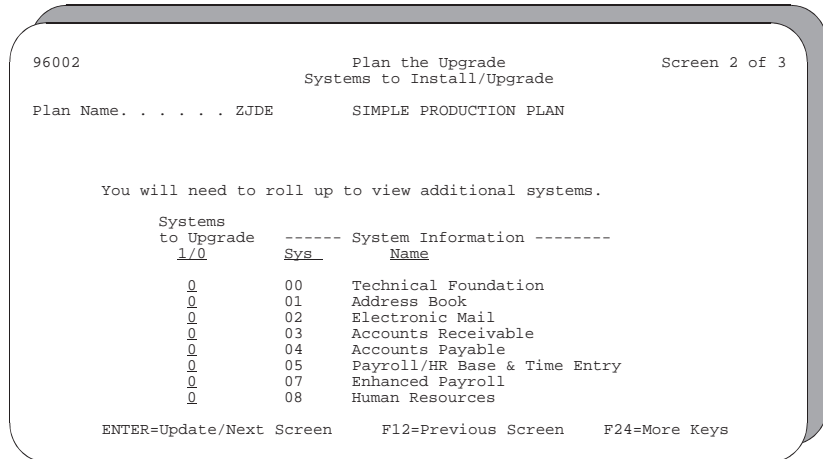

Verify the systems to upgrade.

On the Systems to Install/Upgrade screen, the Systems to Upgrade field is set to 1 for each application you are licensed to use.

IMPORTANT: Do not change the values that appear automatically in the Systems to Upgrade fields.

MULTI-PLANS: All plans must have the same application systems selected.

NOTE: If you have purchased the InterTrans Logistics Transportation Management product or the Data Systems International WorldRF product, select the systems assigned to the product. The J.D. Edwards PTF installation process restores the libraries for these systems, but it does not perform the product PTF installation. For product PTF installation procedures, refer to the *Strategic Alliance Products Installation Workbook*.

Press Enter twice.

The Merge Information screen appears.

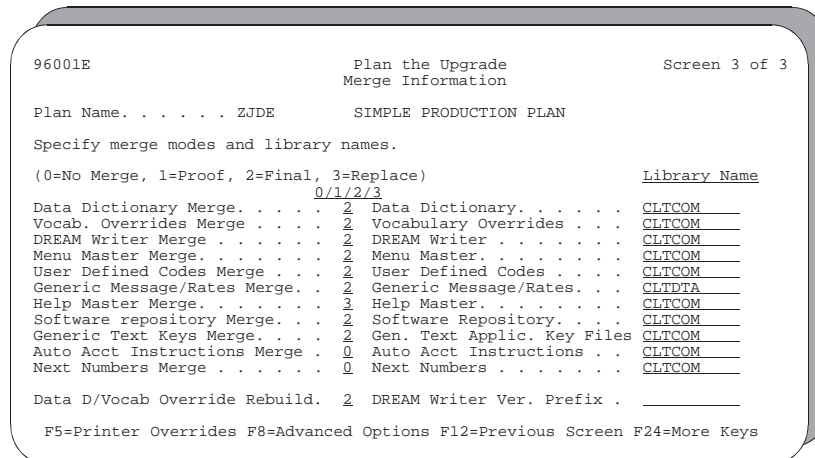

□ Indicate the merge information.

The Merge Information screen lets you specify modes in which you want the merges to run and the library locations of the control files.

NOTE: J.D. Edwards recommends that you do not change the merge modes except for automatic accounting instructions and next numbers, which you should change to 0 because they do not run for PTFs. If you run them, blank reports are printed. If the library locations on this screen are not correct, blank out the library name fields and press Enter. Your libraries will be searched and the correct locations will be retrieved.

MULTI-PLANS: If the plans share the same common files, you do not need to set the merge modes to run for the second and subsequent plans.

After you finish with this screen, you can access two screens that let you override printer file defaults and select advanced functions for the upgrade process. Review these screens to make sure your plans are correct.

- To access the Printer Information screen, press F5 (Printer Overrides).
- To access the Advanced Options screen, press F8 (Advanced Options).

□ Indicate the printer information.

```

96001D                                Plan the Upgrade
                                        Printer Information

Plan Name. . . . . ZJDE                SIMPLE PRODUCTION PLAN

The following information will be used to determine how to print
the reports created by the upgrade process.

                                        1/0   (1=Yes, 0=No)

Override Print Options . . . . . 0
Output Queue . . . . . OPRINT
Width of Form. . . . . 132
Length of Your Form. . . . . 68
Overflow Line. . . . . 62
Characters per Inch. . . . . 15
Lines per Inch . . . . . 8
Form Type. . . . . *STD
Number of Copies . . . . . 1

F12 or ENTER=Previous Screen          F24=More Keys
    
```

The Printer Information screen lets you override the default values set for various printer attributes, such as form length, form type, and line spacing.

If you make changes to this screen, press Enter twice. Otherwise, press Enter once. The Merge Information screen reappears.

□ Select advanced options.

```

96001A                                Plan the Upgrade
                                        Advanced Options

Plan Name. . . . . ZJDE                SIMPLE PRODUCTION PLAN

The following information will be used to determine the jobs that will run.

                                        1/0   (1=Yes, 0=No)

Hold on Print Queue. . . . . 0
Run Control File Conversion. . . . . 1
Update Data Dictionary Glossary. . . . . 1
User Defined Codes Detail Text Update. . . . . 1
Delete Obsolete Menus. . . . . 0

Double Byte Environment. . . . . 0

F12 or ENTER=Previous Screen          F24=More Keys
    
```

The Advanced Options screen lets you select from several advanced upgrade functions, including enabling or disabling:

- Hold on print queue option
- Control file conversion
- Data dictionary glossary update

- User defined codes detail text update
- Obsolete menu deletion

NOTE: Leave the default value for Delete Obsolete Menus set to 0. The PTF installation process does not delete menus that are obsolete.

You can also indicate whether the environment you are upgrading is double byte.

If you make changes to this screen, press Enter twice. Otherwise, press Enter once. The Merge Information screen reappears. To return to the Plan the Upgrade screen, press Enter again.

Validate your upgrade plan.

The upgrade planner creates the Upgrade Planner Validation Report (R96004YR) when you select Print Upgrade Validation Report from the Software Upgrade Menu (A97IBM). The validation process also creates the Duplicate Files Found Report (R97281) if a processing option for the Upgrade Planner Validation Report is set appropriately and duplicate files are found.

MULTI-PLANS: You must validate each plan.

The following pages describe the validation reports, how to create them, and a brief explanation of how the upgrade plans are validated when you begin the upgrade procedure.

■ The Duplicate Files Found Report

The report (R97281) identifies any duplicate files in the environment you ran the report against. This report will be created when you create the Upgrade Planner Validation Report. If you set the processing option for the Upgrade Planner Validation Report to check for duplicate files, the report will list the file and the library in which the duplicate was found for each duplicate file, or it will indicate “NO DUPLICATE FILES FOUND.” You must remove duplicate files from the environment before you perform the upgrade.

97281		J.D Edwards & Company		Page -	1
		Duplicate Files Found Report		Date -	2/05/96
		Plan Name . . . JORGE1		Time -	14:32:14
<u>Object Name</u>	<u>Object Library</u>	<u>Object Type</u>	<u>Description</u>		
F0092	SML52COM	*FILE	Library Lists - User		
F0092	KSHDATA	*FILE	Library Lists - User		
F0092LA	SML52COM	*FILE	LF - Multi Format by Library L		
F0092LA	KSHDATA	*FILE	LF - Multi Format by Library L		
F0092LB	SML52COM	*FILE	LF - Group/User		
F0092LB	KSHDATA	*FILE	LF - Group/User		
F0092LC	SML52COM	*FILE	LF - Multi Format by Security		
F0092LC	KSHDATA	*FILE	LF - Multi Format by Security		
F0092LD	SML52COM	*FILE	LF - Department		
F0092LD	KSHDATA	*FILE	LF - Department		
F0101	SML52COM	*FILE	Address Book Master		
F0101	KSHDATA	*FILE	Address Book Master		
F0411	SML52PROD	*FILE	Accounts Payable Ledger		
F0411	KSHPROD	*FILE	Accounts Payable Ledger		
F0411LA	SML52PROD	*FILE	LF - Address No, Doc Ty/No/Co,		
F0411LA	KSHPROD	*FILE	LF - Address No, Doc Ty/No/Co,		
F0411LB	SML52PROD	*FILE	LF - Address No,Check No,Bank,		
F0411LB	KSHPROD	*FILE	LF - Address No,Check No,Bank,		
F0411LC	SML52PROD	*FILE	LF - Address No, G/L Date(##YY		
F0411LC	KSHPROD	*FILE	LF - Address No, G/L Date(##YY		

■ Create the validation reports

1. Be sure you are signed on as JDEINSTAL.
2. From the Software Upgrade Menu (A97IBM), select Print Upgrade Validation Report. A processing options revisions screen appears.

3. Enter the appropriate information in the processing option fields. Specify in the first field an upgrade plan name. Specify 0 in the second field and 1 in the third field, which indicates you want a report created that checks for duplicate files. Specify *PTF in the fourth field.
4. After you verify your information, press Enter.

The report submits to batch.

5. If you receive a message that one or more errors occurred, you have errors listed in the Upgrade Planner Validation Report (R96004YR) and/or duplicate files listed in the Duplicate Files Found Report (R97281).

If the Upgrade Planner Validation Report lists errors, correct your upgrade plan and rerun the report. Repeat this step until the report lists no errors.

If the upgrade planner creates a Duplicate Files Found Report (R97281), verify that no duplicate files were found. If the report lists duplicate files, remove them.

IMPORTANT: If you have questions, contact J.D. Edwards Worldwide Customer Support. If no errors appear on the Upgrade Planner Validation Report and the Duplicate Files Found Report indicates that no duplicate files were found (or you correct the problems that appear on this report), you are ready to begin the PTF installation process for this environment. You must resolve all errors reported on these reports before you begin the PTF installation process.

- **Choose the appropriate method to install the PTF.** You can install the PTF by using one of the following methods:
 - *One-Step Method.* When you start to install the PTF, you will specify to run both PTF_STEP1 and PTF_STEP2. PTF_STEP1 restores the objects from the PTF tape to disk. PTF_STEP2 moves the PTF objects into your libraries and runs any necessary file conversions and merges. Before you start the installation process, you must sign off all users of the environment you want to upgrade if you choose this method.
 - *Two-Step Method.* When you start to install the PTF, you will specify to run PTF_STEP1 only. This restores the objects from the PTF tape to disk. You can run this job during the day while users are signed on to the environment. When you are ready to complete the installation, you will specify to run PTF_STEP2 only, which moves the PTF objects into your libraries and runs any necessary file conversions and merges. You must sign off all users of the environment before you start PTF_STEP2.

By using the two-step method, you can run PTF_STEP1 (a non-dedicated step) while users are signed on to the environment you want to upgrade. At a later time, you must run PTF_STEP2 (a dedicated step) while users are signed off of the environment.

IMPORTANT: Run PTF_STEP2 as soon as possible after PTF_STEP1. The upgrade process will use upgrade information that is created during PTF_STEP1 to complete the upgrade. To avoid problems, do not change your environment between PTF_STEP1 and PTF_STEP2 processing.

- **Go to Phase 2A or 2B.** If you choose the one-step method, continue with *Phase 2A – Install the PTF (One-Step Method)*. If you choose the two-step method, continue with *Phase 2B – Install the PTF (Two-Step Method)*.

Phase 2A – Install the PTF (One-Step Method)

This section shows what you must do to start the PTF installation process by using the one-step method.

Checklist

- ❑ **Move custom objects.** The PTF installation process replaces objects in the J.D. Edwards libraries (library types JDF, OBJ, and SRC). Therefore, your custom objects cannot be in libraries of these types.
 - ❑ **Stop the J.D. Edwards sleeper subsystem.**
 1. From the Software Upgrade Menu (A97IBM), select Stop JDE Subsystems.
 2. From the Stop JDE Subsystems menu, select Sleeper.
 - ❑ **Back up libraries.** Back up all libraries that appear in your upgrade plan.
- MULTI-PLANS: Be sure you back up all libraries specified in all upgrade plans.
- ❑ **Sign on as JDEINSTAL to access the Software Upgrade Menu.**

```
A97IBM                J.D. Edwards & Company                JDED
                    Software Upgrade Menu

... PLAN THE UPGRADE                ... UPGRADE UTILITIES
2. Work with Upgrade Planner        13. Inquire on Upgrade History
3. Print Upgrade Validation Report   14. Print Upgrade History Report
4. Stop JDE Subsystems              15. Work With Tech Upgrade Notes
                                    16. Print ASI Report

... UPGRADE THE SOFTWARE
7. Change Messages to Break Mode    ... FILE CONVERSION UTILITIES
8. Start the Upgrade                19. Inquire on File Conversion Status
                                    20. Print File Conversion Status Report
... NEW INSTALL CLIENTS ONLY        21. Print File Conversion Schedule
11. IBM Post Install Procedures

Selection or command
====>> _____
```

- ❑ **Ensure that no one is signed on to the production environment to which you will be installing the PTF.** When you install the PTF, you must have exclusive access to all J.D. Edwards libraries defined in your upgrade plan.

MULTI-PLANS: Be sure no one is signed on to any environments you want to upgrade.

- ❑ **Change messages to break mode.** From the Software Upgrade Menu (A97IBM), select Change Messages to Break Mode.
- ❑ **Start the upgrade.**

1. From the Software Upgrade Menu (A97IBM), select Start the Upgrade.

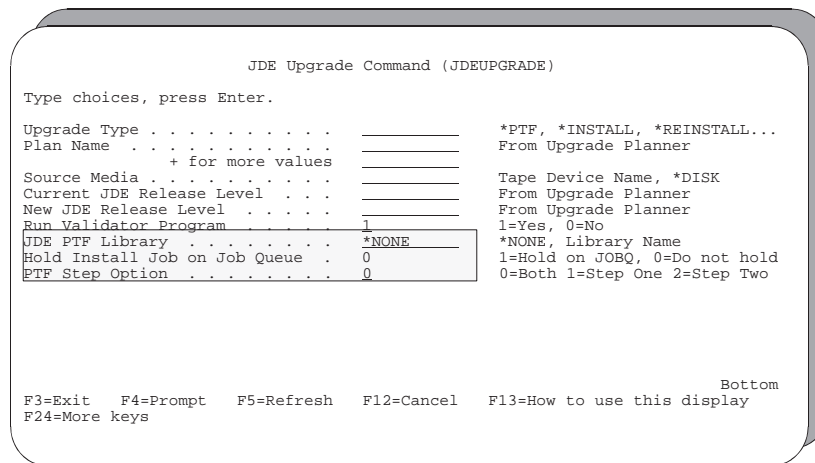

2. In the Upgrade Type field, enter *PTF.
The highlighted fields shown above appear on your screen.
3. In the Plan Name field, type the name of the upgrade plan that defines the environment you want to upgrade.

MULTI-PLANS: If you are upgrading more than one environment (multiple plans), enter a plus character (+) in the second Plan Name field, and then enter the additional plans in the fields provided.

4. In the Source Media field, type your tape device name.
5. In the Current JDE Release Level field, type A73.

This release level must match the current J.D. Edwards release level specified in the upgrade plan.

6. In the New JDE Release Level field, type the name of the PTF library (for example, A73PC00001).

This release level must match the new J.D. Edwards release level specified in the upgrade plan.

7. Leave the value in the Run Validator Program field set to 1.
8. In the JDE PTF Library field, type the name of the PTF library (for example, A73PC00001).

This name must be the same as you typed in the New JDE Release Level field. To avoid an error, do not blank this field out or leave it set to *NONE.

9. Leave the values in the Hold Install Job on Job Queue and PTF Step Option fields set to 0.
10. Press Enter.

The installation process begins. The PTF_STEP1 and PTF_STEP2 jobs submit to batch. A job named JDEMONITOR, which is a message handler, also submits to batch.

- Track the progress of the installation.** A period of time (varies depending on the size of your libraries and whether you are upgrading multiple environments) after you press Enter on the JDE Upgrade Command (JDEUPGRADE) screen, the IBM Display Messages screen appears and asks whether the first installation tape is loaded on the tape drive. Respond to this message and any others as appropriate.

The first part of the installation process (PTF_STEP1) begins to restore the systems from tape to the PTF library and sends you messages as it completes each system.

The second part of the installation process (PTF_STEP2) submits several merges and converts files if necessary. These jobs run in the JDEINSTAL subsystem in separate job queues. PTF_STEP2 also duplicates the objects from the PTF library to your environment. After you receive the message *You may now sign on using your JDE User Profile to continue*, you can sign on and begin Phase 3.

Phase 2A – Install the PTF (One-Step Method)

After PTF_STEP2 completes, the PTF installation process submits the following jobs automatically:

- Rebuild field reference files (FRFs) and the J.D. Edwards message file (J98FRFGEN)
- Build join logical files (J97JLFBLD)

MULTI-PLANS: PTF_STEP1 builds work files for all plans before prompting you for the first tape and performing the restore process from tape. Allow about 15 minutes for each plan before you receive the tape message prompt. A separate PTF_STEP2 runs for each plan and performs any necessary file conversions and merges.

You will not receive the message *You may now sign on using your JDE User Profile to continue* until PTF_STEP2 for the last plan sends it.

IMPORTANT: If you are installing the PTF to an alternate environment, be sure you keep the PTF installation tapes because you will use them again when you upgrade your production environment.

IMPORTANT: The installation process produces job logs (QPJOBLOG) for PTF_STEP1 and PTF_STEP2. Keep the job log files (QPJOBLOG) in an output queue where they will not be deleted. They are extremely useful for resolving installation problems. The PTF_STEP1 job log shows what happened during the tape restore portion of the PTF installation process. The PTF_STEP2 job logs show what happened during file conversions and merges.

❑ **V4R2 clients only.** If your operating system is currently at V4R2 **and you are at PTF level A73PC00008 or below**, you must restore the V4R2 J.D. Edwards PTF library to your machine and copy the V4R2 objects into your libraries. If you do not have the V4R2 PTF, contact J.D. Edwards Worldwide Customer Support.

1. Mount the V4R2 PTF tape on your tape device.
2. From the command entry line, enter
RSTLIB SAVLIB(V4R2) DEV(*device*) VOL(*MOUNTED)
where *device* is the name of your tape device.
3. After the library is restored, enter the command
ADDLIBLE V4R2.
4. From the command entry line, type
V4R2A73, then press F4 (prompt).

The Update Objects to V4R2 Level (V4R2A73) screen appears.

5. In the JDE Target Library field, type the name of your object library.
6. In the JDE Source Library field, type the name of your source library if you have source on your system.
7. Press Enter.

IMPORTANT: If you have more than one object library in multiple environments, you must issue this command for each object library.

❑ **Go to Phase 3.**

Phase 2B – Install the PTF (Two-Step Method)

This section shows what you must do to start the PTF installation process by using the two-step method.

NOTE: In this method, PTF_STEP1 can be done while users are signed on to the environment you want to upgrade. When you start PTF_STEP2, you must sign off all users.

Checklist

First Part of the PTF Installation Process (PTF_STEP1)

- ❑ **Sign on as JDEINSTAL to access the Software Upgrade Menu.**

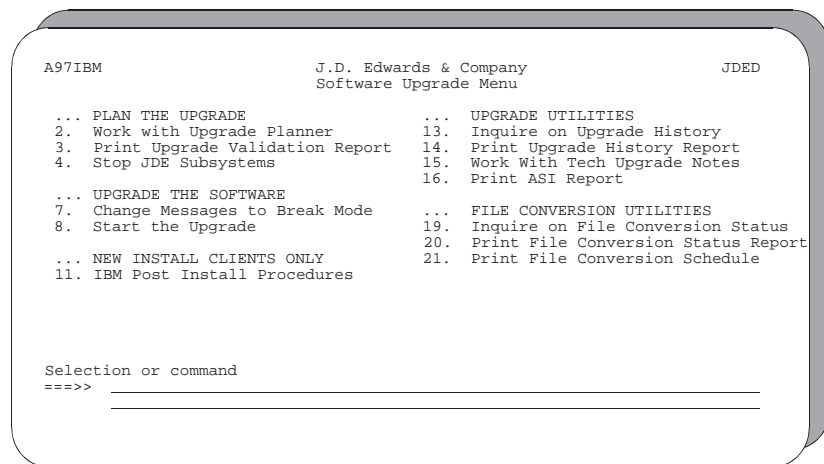

```
A97IBM                                J.D. Edwards & Company                                JDED
                                Software Upgrade Menu

... PLAN THE UPGRADE                                ... UPGRADE UTILITIES
2. Work with Upgrade Planner                        13. Inquire on Upgrade History
3. Print Upgrade Validation Report                  14. Print Upgrade History Report
4. Stop JDE Subsystems                             15. Work With Tech Upgrade Notes
                                                    16. Print ASI Report

... UPGRADE THE SOFTWARE
7. Change Messages to Break Mode                    ... FILE CONVERSION UTILITIES
8. Start the Upgrade                                19. Inquire on File Conversion Status
                                                    20. Print File Conversion Status Report
... NEW INSTALL CLIENTS ONLY                       21. Print File Conversion Schedule
11. IBM Post Install Procedures

Selection or command
====>>> _____
```

- ❑ **Change messages to break mode.** From the Software Upgrade Menu (A97IBM), select Change Messages to Break Mode.

❑ **Start the upgrade.** In this checklist item, you will start the first part of the PTF installation process (PTF_STEP1).

1. From the Software Upgrade Menu (A97IBM), select Start the Upgrade.

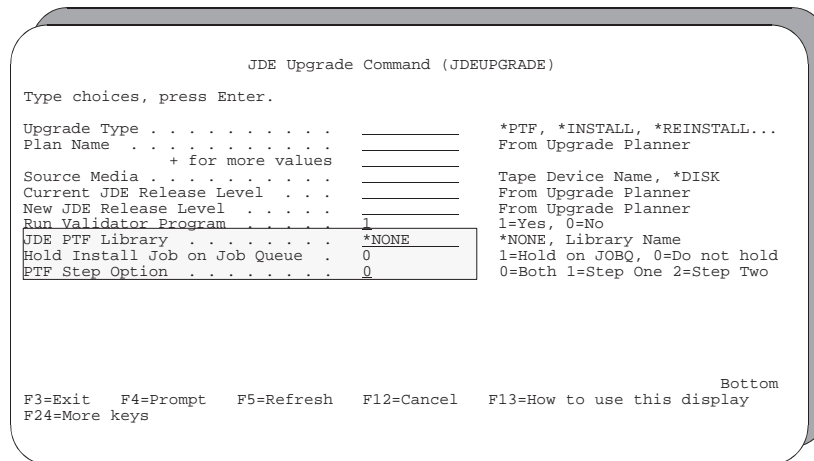

2. In the Upgrade Type field, enter *PTF.
The highlighted fields shown above appear on your screen.
3. In the Plan Name field, type the name of the upgrade plan that defines the environment you want to upgrade.

MULTI-PLANS: If you are upgrading more than one environment (multiple plans), enter a plus character (+) in the second Plan Name field, and then enter the additional plans in the fields provided.

4. In the Source Media field, type your tape device name.
5. In the Current JDE Release Level field, type A73.
This release level must match the current J.D. Edwards release level specified in the upgrade plan.
6. In the New JDE Release Level field, type the name of the PTF library (for example, A73PC00001).
This release level must match the new J.D. Edwards release level specified in the upgrade plan.
7. Leave the value in the Run Validator Program field set to 1.

8. In the JDE PTF Library field, type the name of the PTF library (for example, A73PC00001).

This name must be the same as you typed in the New JDE Release Level field. To avoid an error, do not blank this field out or leave it set to *NONE.

9. Leave the value in the Hold Install Job on Job Queue field set to 0.
10. In the PTF Step Option field, enter 1.

IMPORTANT: Do not leave this field set to 0, which runs both steps of the PTF installation process and causes objects in the PTF library to be copied into your environment prematurely.

The first part of the PTF installation process begins. PTF_STEP1 submits to batch, which restores the objects from the PTF tape to disk. A job named JDEMONITOR, which is a message handler, also submits to batch.

- Track the progress of the installation.** A period of time (varies depending on the size of your libraries and whether you are upgrading multiple environments) after you press Enter on the JDE Upgrade Command (JDEUPGRADE) screen, the IBM Display Messages screen appears and asks whether the first installation tape is loaded on the tape drive. Respond to this message and any others as appropriate.

The first part of the installation process (PTF_STEP1) begins to restore the systems from tape and sends you messages as it completes each system.

MULTI-PLANS: PTF_STEP1 builds work files for all plans before prompting you for the first tape and performing the restore process from tape. Allow about 15 minutes for each plan before you receive the tape message prompt.

IMPORTANT: If you are installing the PTF to an alternate environment, be sure you keep the PTF installation tapes because you will use them again when you upgrade your production environment.

IMPORTANT: The installation process produces a job log (QPJOBLOG) for PTF_STEP1. Keep the job log file (QPJOBLOG) in an output queue where it will not be deleted. It is extremely useful for resolving installation problems. The PTF_STEP1 job log shows what happened during the tape restore portion of the PTF installation process.

Second Part of the PTF Installation Process (PTF_STEP2)

- ❑ **Move custom objects.** The PTF installation process replaces objects in the J.D. Edwards libraries (library types JDF, OBJ, and SRC). Therefore, your custom objects cannot be in libraries of these types.
- ❑ **Stop the J.D. Edwards sleeper subsystem.**
 1. From the Software Upgrade Menu (A97IBM), select Stop JDE Subsystems.
 2. From the Stop JDE Subsystems menu, select Sleeper.
- ❑ **Back up libraries.** Back up all libraries that appear in your upgrade plan.

MULTI-PLANS: Be sure you back up all libraries specified in all upgrade plans.

- ❑ **Sign on as JDEINSTAL to access the Software Upgrade Menu.**

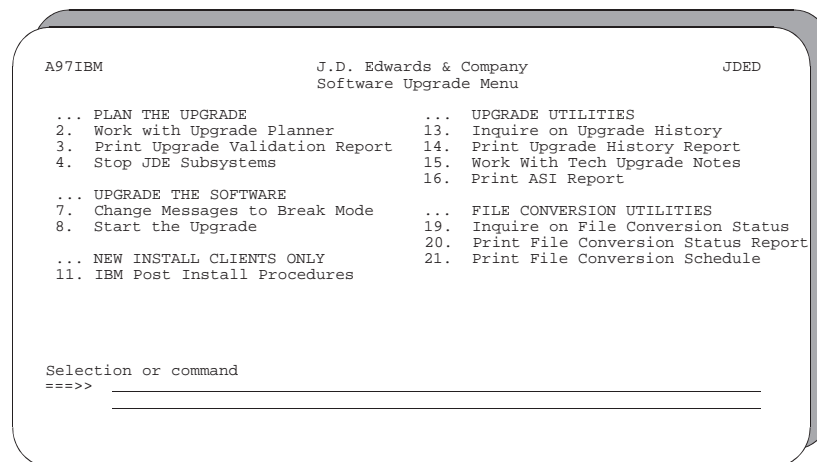

- ❑ **Ensure that no one is signed on to the production environment to which you will be installing the PTF.** When you install the PTF, you must have exclusive access to all J.D. Edwards libraries defined in your upgrade plan.

MULTI-PLANS: Be sure no one is signed on to any environments you want to upgrade.

- ❑ **Change messages to break mode.** From the Software Upgrade Menu (A97IBM), select Change Messages to Break Mode.

- ❑ **Start the upgrade.** In this checklist item, you will start the second part of the PTF installation process (PTF_STEP2).

1. From the Software Upgrade Menu (A97IBM), select Start the Upgrade.

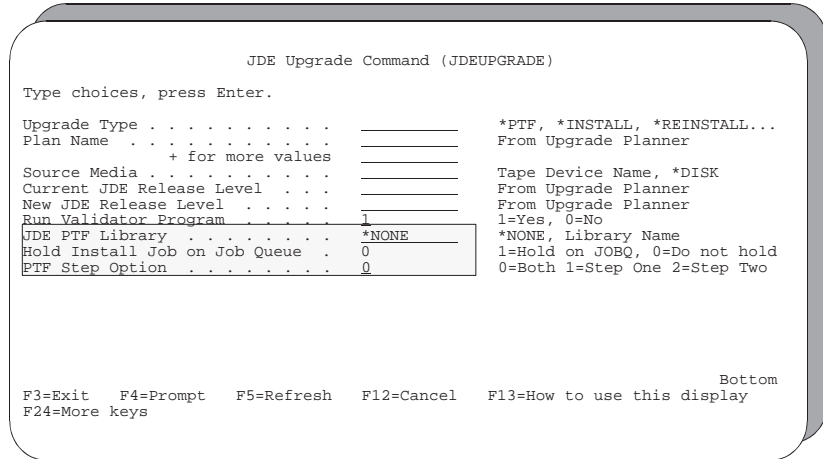

2. In the Upgrade Type field, enter *PTF.

The highlighted fields shown above appear on your screen.

3. In the Plan Name field, type the name of the upgrade plan that defines the environment you want to upgrade.

MULTI-PLANS: If you are upgrading more than one environment (multiple plans), enter a plus character (+) in the second Plan Name field, and then enter the additional plans in the fields provided.

4. In the Source Media field, type *DISK.
5. In the Current JDE Release Level field, type A73.

This release level must match the current J.D. Edwards release level specified in the upgrade plan.

6. In the New JDE Release Level field, type the name of the PTF library (for example, A73PC00001).

This release level must match the new J.D. Edwards release level specified in the upgrade plan.

7. Leave the value in the Run Validator Program field set to 0.

8. In the JDE PTF Library field, type the name of the PTF library (for example, A73PC00001).

This name must be the same as you typed in the New JDE Release Level field. To avoid an error, do not blank this field out or leave it set to *NONE.

9. Leave the value in the Hold Install Job on Job Queue field set to 0.
10. In the PTF Step Option field, enter 2.

- Track the progress of the installation.** The second part of the installation process (PTF_STEP2) submits several merges and converts files if necessary. These jobs run in the JDEINSTAL subsystem in separate job queues. PTF_STEP2 also duplicates the objects from the PTF library to your environment. After you receive the message *You may now sign on using your JDE User Profile to continue*, you can sign on and begin Phase 3.

After PTF_STEP2 completes, the PTF installation process submits the following jobs automatically:

- Rebuild field reference files (FRFs) and the J.D. Edwards message file (J98FRFGEN)
- Build join logical files (J97JLFBLD)

MULTI-PLANS: PTF_STEP2 performs any necessary file conversions and merges for the first environment. A separate PTF_STEP2 job runs for each subsequent plan.

You will not receive the message *You may now sign on using your JDE User Profile to continue* until the PTF_STEP2 for the last plan sends it.

IMPORTANT: The installation process produces a job log (QPJOBLOG) for PTF_STEP2. Keep the job log file (QPJOBLOG) in an output queue where it will not be deleted. It is extremely useful for resolving installation problems. The PTF_STEP2 job log shows what happened during file conversions and merges.

❑ **V4R2 clients only.** If your operating system is currently at V4R2 **and you are at PTF level A73PC00008 or below**, you must restore the V4R2 J.D. Edwards PTF library to your machine and copy the V4R2 objects into your libraries. If you do not have the V4R2 PTF, contact J.D. Edwards Worldwide Customer Support.

1. Mount the V4R2 PTF tape on your tape device.
2. From the command entry line, enter
RSTLIB SAVLIB(V4R2) DEV(*device*) VOL(*MOUNTED)
where *device* is the name of your tape device.
3. After the library is restored, enter the command
ADDLIBLE V4R2.
4. From the command entry line, type
V4R2A73, then press F4 (prompt).

The Update Objects to V4R2 Level (V4R2A73) screen appears.

5. In the JDE Target Library field, type the name of your object library.
6. In the JDE Source Library field, type the name of your source library if you have source on your system.
7. Press Enter.

IMPORTANT: If you have more than one object library in multiple environments, you must issue this command for each object library.

❑ **Go to Phase 3.**

Phase 3 – Update Applications

This phase shows what you must do to update your J.D. Edwards system applications.

NOTE: You can begin this phase when you receive the message *You may now sign on using your JDE User Profile to continue.*

MULTI-PLANS: In this phase, you may need to perform the following procedures more than once, depending on whether your plans share the same common files.

- Print the Menu Comparison Report and update menus
- Print the Data Dictionary Merge Report – Manual Changes, and update the data dictionary
- Print and apply the application specific instructions (ASIs)

To determine whether you must repeat these procedures, refer to the appropriate multi-plan scenario in *Install PTF to Multiple Environments* in the *Upgrade Reference Guide*.

Checklist

- Sign on as a user who accesses the production library you want to update.**

- ❑ **Access the PTF Post Upgrade Menu.** From any J.D. Edwards menu, enter G97PTF.

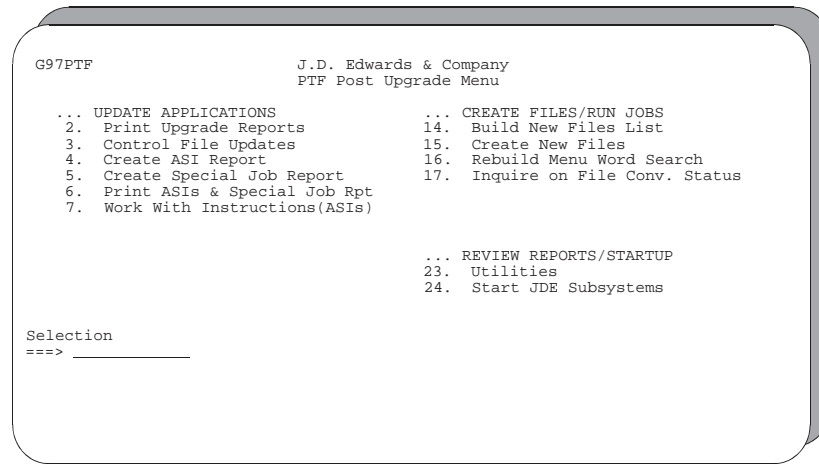

- ❑ **Print menu and data dictionary reports.**

1. From the PTF Post Upgrade Menu (G97PTF), select Print Menu/DD Report.

The Work with Spooled Files (WRKSPLF) screen appears.

2. In the User field, enter JDEINSTAL.
3. Print the following reports if they have not been printed already.

R98340	Menu Comparison Report
R98722	Data Dictionary Merge Report – Manual Changes

- ☐ **Update the menus.** You can update the menus by either replacing them or changing selections in them individually. Use the Menu Comparison Report (R98340) to determine the changes to make.

■ **How to use the Menu Comparison Report**

Using the Menu Comparison Report that you printed earlier, identify the differences between menus in the PTF library and those in your library. Differences are marked with an asterisk (*) on the report. The first column contains menu information from the PTF library, and the second column contains menu information from your library. The report only specifies changes that are necessary to the normal function of the menus.

```

98340                                J.D. Edwards & Company                Page -      1
                                      Menu Comparison Report                Date - 2/05/96
*****
                                      Menu Number - G0021
                                      Sales, Purchases & VAT Taxes
FROM Library - A73PC000xx           TO Library -      CLTCOM           Mode - Final
*****
Difference                          A73PC000xx                          VS                          CLTCOM
-----
Menu Header
-----
Advanced Ops . . *G0033                          *G003
  Job to Execute .
Menu Selection 02                          Menu Selection 02
-----
Selection Desc . Tax Authorities                          Tax Authorities
Job to Execute . J01051                          J01051
*   Version . . . . ZJDE0001
Menu Selection 03                          Menu Selection 03
-----
Selection Desc . Tax Rate/Areas                          Tax Rate/Areas
Job to Execute . J4008                          J4008
*   Version . . . . ZJDE0001
  
```

The report indicates whether menu selections have been rearranged. It also reports DREAM Writer versions that are missing in your library (an asterisk appears in the Difference column for Option Key and a detailed message appears in the TO Library Menu column).

After you identify the differences, apply the changes to your menus by using one of the following methods.

■ **To copy the entire menu**

NOTE: If you use this copy feature, any security you had set up for the affected menu must be set up again.

1. From the PTF Post Upgrade Menu (G97PTF), select Control File Updates. From the Control File Updates menu, select Copy DD,VO,DW,UDC,SVR,Menus.

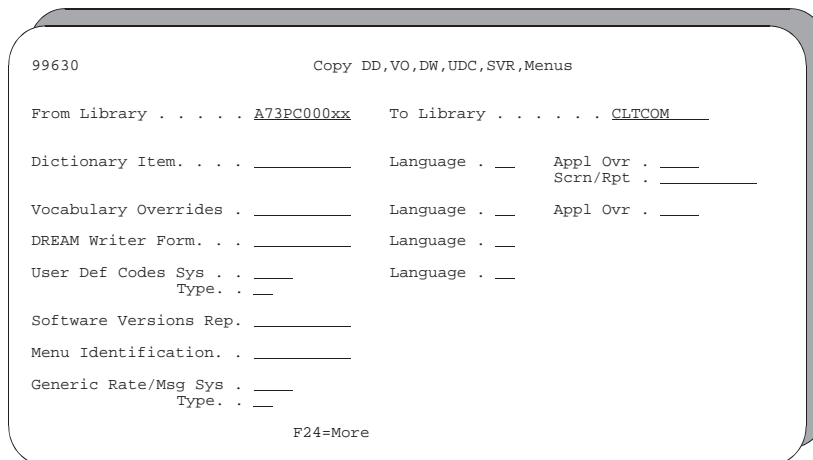

2. Enter the appropriate libraries in the From Library and To Library fields, and the menu you want to copy in the Menu ID field.

■ **To update a menu selection**

1. From the Control File Updates menu (G97R6), select Menu Selections.

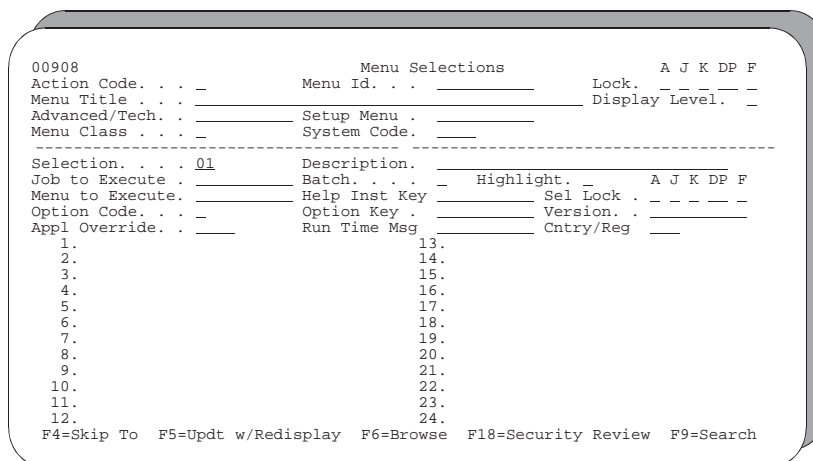

2. Inquire on the menu and make the appropriate changes.

- ❑ **Update the data dictionary.** You can update data dictionary items by either replacing them entirely or changing them individually. Use the Data Dictionary Merge Report – Manual Changes (R98722) to determine the changes you need to make. The Data Dictionary Merge Report – Replaced Changes (R98722A) lists the changes made automatically.

IMPORTANT: Do not change display decimals for items QTYINV or CURRENCY.

■ **How to use the Data Dictionary Merge Report – Manual Changes**

The Data Dictionary Merge Report – Manual Changes that you printed earlier lists the data items that you must update manually. Most updates are easily understood from the report. However, some need clarification, such as the shaded area on the partial report below.

Data Item	Description	Field	Was	Change
#Q	Number of Work Order	Data Display Rules	MASK	CODE
		Data Display Rules	A	Z
		Data Edit Rules	*BLANK	UDC
		Data Edit Rules Specification		48
		Data Edit Rules Specification		RL

On the Data Dictionary Items screen, two Data Display Rules fields are displayed together, and the Data Edit Rules field and Data Edit Rules Specification fields are displayed together. Using the update information from the report, you would make the following changes to data item #Q on the Data Dictionary Items screen.

```

9201          Data Dictionary Items          Rls Last Chg A62
Action Code . . . . C                      Item Parent.
Data Item . . . . #Q
Glossary Group . . U
-----
Alpha Desc . . . . Number - Work Order Releases
Reporting System . 48
Install System Cod 48          Type . P Size . 15  Data File Decimals 00
Data Item Class . .          Item Occurrences 12  Display Decimals . 0
-----
Row Description . . Number of Work Order Releases. . . . .
Column Title . . . . Number
                  Of Releases
-----
Default Value . . . .
Data Display Rules CODE Z
Data Edit Rules . . UDC 48 Justify. _
                  RL
Search Program . .
Next Nbr System . .          Next Number Index . . _
-----
F4=Search F8=UDC F9=Prev F10=Glossary F11=Descriptions F15=Where Used
    
```

The shaded area on this screen, which shows the changes, corresponds to the shaded area on the report.

■ **To copy the entire data item**

1. From the PTF Post Upgrade Menu (G97PTF), select Control File Updates. From the Control File Updates menu, select Copy DD,VO,DW,UDC,SVR,Menus.

```

99630                                Copy DD,VO,DW,UDC,SVR,Menus

From Library . . . . . A73PC000xx    To Library . . . . . CLTCOM

Dictionary Item. . . . .           Language . . . . . Appl Ovr . . . . .
                                   Scrn/Rpt . . . . .

Vocabulary Overrides . . . . .      Language . . . . . Appl Ovr . . . . .

DREAM Writer Form. . . . .         Language . . . . .

User Def Codes Sys . . . . .       Language . . . . .
Type. . . . .

Software Versions Rep. . . . .

Menu Identification. . . . .

Generic Rate/Msg Sys . . . . .
Type. . . . .

                                F24=More
    
```

2. Enter the appropriate libraries in the From Library and To Library fields, and the data item you want to copy in the Dictionary Item field.

■ **To update an individual data item**

1. From the Control File Updates menu (G97R6), select Data Dictionary Items.

```

9201                                Data Dictionary Items          Rls Last Chg _____
Action Code. . . . .                Item Parent.
Data Item. . . . .
Glossary Group . . . . .
----- General Information -----
Alpha Desc . . . . .
Reporting System . . . . .
Install System Cod _____ Type . P Size . . . . . Data File Decimals ____
Data Item Class. . . . . Item Occurrences ____ Display Decimals . . . . .

----- Descriptions -----
Row Description. . . . .
Column Title . . . . .

----- Default and Display/Edit Rules -----
Default Value. . . . .
Data Display Rules _____ Justify. _
Data Edit Rules. . . . .

Search Program . . . . .
Next Nbr System. . . . . Next Number Index . . . . .

F4=Search F8=UDC F9=Prev F10=Glossary F11=Descriptions F15=Where Used
    
```

2. Inquire on the data item and make the appropriate changes.

Create ASI Report.

NOTE: If you printed this report from the A97IBM menu in Phase 1 and have the report available, you can skip this checklist item.

1. From the PTF Post Upgrade Menu (G97PTF), select Create ASI Report.

The DREAM Writer data selection screen for Print Instructions (ASIs) appears.

```

98302                Print Instructions(ASIs)  Form ID. . . . P98490
                   Version. . . . ZJDE0002

ASI Report Instructions by System

  I      Explanation . . . Selection . .
  N      Rel.      Value
  Y Release. . . . . EQ  A73PC000xx
And Y Install System Code. . . . . EQ  *ALL
And Y ASI Type . . . . . EQ  *ALL
And Y Priority . . . . . EQ  *ALL
And Y ASI Parameter. . . . . EQ  *ALL
And Y Menu Job to Execute. . . . . EQ  *ALL
And Y SAR Number . . . . . EQ  *ALL

F4=Extra Data  F5=Updt w/Redisplay  F16=Display All Data Fields
    
```

2. Change the Release value to the name of the PTF library (for example, A73PC00001), and press Enter.

Create Special Jobs Report.

NOTE: If you printed the menu messages already from the A97IBM menu in Phase 1, you can skip this checklist item.

1. From the PTF Post Upgrade Menu (G97PTF), select Create Special Jobs Report.

A processing options screen appears.

2. In the first processing option field, type A73.
3. In the second processing option field, enter the PTF level to which you are upgrading (for example, A73PC00001).

Print ASIs and Special Jobs Report.

1. From the PTF Post Upgrade Menu (G97PTF), select Print ASIs & Special Job Rpt.
2. Print the following reports if you created them in the previous two checklist items:

R98490 ASI Report
R97454 Additional Jobs Menu Messages Report

Work with instructions (ASIs).

NOTE: If your ASI Report indicates that no ASIs are required, skip this checklist item.

Display the ASIs

1. From the PTF Post Upgrade Menu (G97PTF), select Work With Instructions (ASIs).

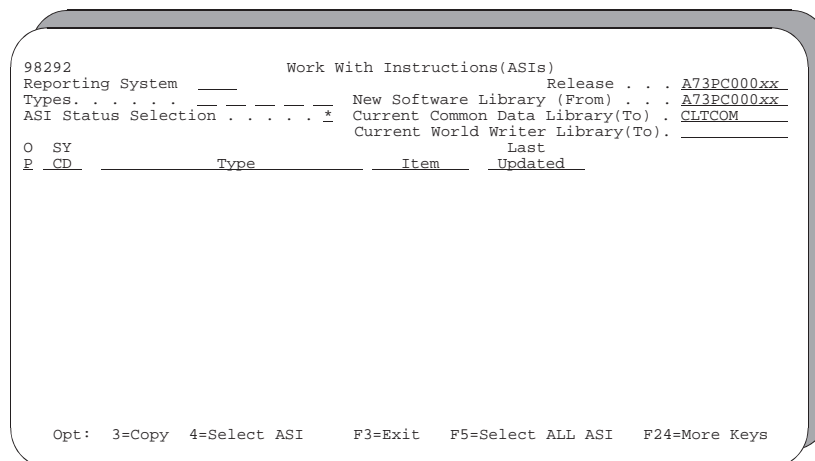

2. In the Release field, type the name of the PTF library (for example, A73PC00001).
3. In the New Software Library (From) field, type the name of the PTF library.
4. Leave the value in the ASI Status Selection field set to an asterisk (*), which displays all ASIs whether they have been applied or not.
5. In the Current Common Data Library (To) field, type the name of the common library that contains the control files you want to update.

6. If you have the World Writer system, in the Current World Writer Library (To) field, type the name of the production data library that contains the F82100 World Writer file.
7. After you verify your information, press Enter and then press F5 (Select ALL ASI's).

The screen lists all the ASIs for the application systems you have on your machine.

For additional information about how to apply ASIs or use the Work With Instructions (ASIs) screen, refer to the *Upgrade Reference Guide*.

■ **Apply the ASIs.**

- If an ASI affects a file located in a library that is different than the one appearing in the Current Common Data Library (To) field on the Work With Instructions (ASIs) screen, change the library name in that field to the appropriate one.
 - For DREAM Writer ASIs, each one instructs you to update a certain version for a form ID. You should update any other versions that are based on that version also.
 - If you need to update secured DREAM Writer versions, you must unsecure them first by using the Report Version selection from the Security Officer menu (G94).
 - The user ID on versions you update will change to the ID of the user who makes the changes.
1. From the Work With Instructions (ASIs) screen, press Enter.

The detail for the first ASI listed and selected on the Work With Instructions (ASIs) screen appears.

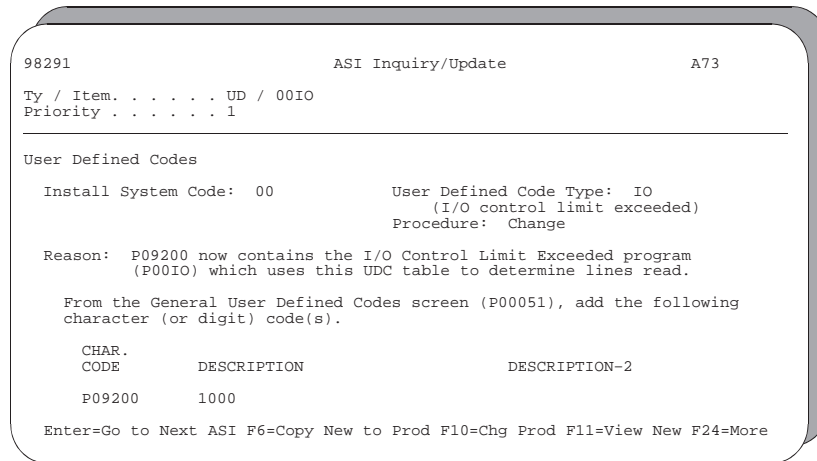

2. At this point, you can apply this ASI two ways:
 - Copy the item affected by this ASI in its entirety from the PTF library to your production data library, or
 - Update specific data associated with the item according to information contained in the ASI.

To copy the item in its entirety (F6)

To copy an entire item from the PTF library, press F6 (Copy New to Prod). The Record Transfer screen appears with the appropriate fields filled in. Press Enter to copy the item and return to the ASI Inquiry/Update screen. Press Enter again to continue to the next ASI.

NOTE: This copy feature cannot be applied to automatic accounting instructions (AAIs) or next numbers.

To update specific data associated with the item (F10)

To update the data, press F10 (Change Prod). The appropriate screen from which to manually apply this ASI appears. After you update the item, press F3 to return to the ASI Inquiry/Update screen. Press Enter to continue to the next ASI.

3. Continue to apply the ASIs by using the above methods until the Work With Instructions (ASIs) screen reappears. The Last Updated fields indicate the library locations where the ASIs were applied.

MULTI-PLANS: The Last Updated fields will help you determine the last library in which the ASIs were applied.

❑ IMPORTANT: Be sure file conversion in Phase 2 has finished before you proceed to the next phase.

1. At the command entry line, enter WRKSBSJOB JDEINSTAL.

If the only job in the subsystem is JDEMONITOR, no conversion jobs are still running.

2. At the command entry line, enter DSPMSG JDEINSTAL.

```
Display Messages
Queue . . . . . : JDEINSTAL      System: JDEI
Library . . . . : QUSRSYS       Program . . . . : *DSPMSG
Severity . . . . : 00           Library . . . . :
Delivery . . . . : *BREAK

Type reply (if required), press Enter.
Job 067682/JDEINSTAL/F0003 completed normally on 02/09/96 at 04:20:56.
Job 067708/JDEINSTAL/F0003 completed normally on 02/09/96 at 04:21:00.
Job 067684/JDEINSTAL/F0098 completed normally on 02/09/96 at 04:21:09.

More...
F3=Exit      F10=Display all  F11=Remove a message
F12=Cancel   F13=Remove all  F16=Remove all except unanswered
```

This screen may display messages related to file conversion, as the one above shows. If no conversion jobs are still running in the JDEINSTAL subsystem, you can continue to the next phase. Make sure all the jobs have completed normally before you continue.

❑ Go to Phase 4.

Phase 4 – Create Files and Run Jobs

This phase shows what you must do to create data files and run special application jobs in your production environment.

MULTI- PLANS: In this phase, you may need to rebuild the menu word search more than once, depending on whether your plans share the same common library and files.

When you create new files for the second (and subsequent) environment, you may need to create them again in the production data library only, depending on whether your plans share the same common library. The files would have been created already in the common library when you created the new files for the first environment.

To determine whether you must repeat any of these procedures, refer to the appropriate multi-plan scenario in *Install PTF to Multiple Environments* in the *Upgrade Reference Guide*.

Checklist

- Be sure you are signed on as a user who accesses the production library you want to update.**
- Access the PTF Post Upgrade Menu.** From any J.D. Edwards menu, enter G97PTF.

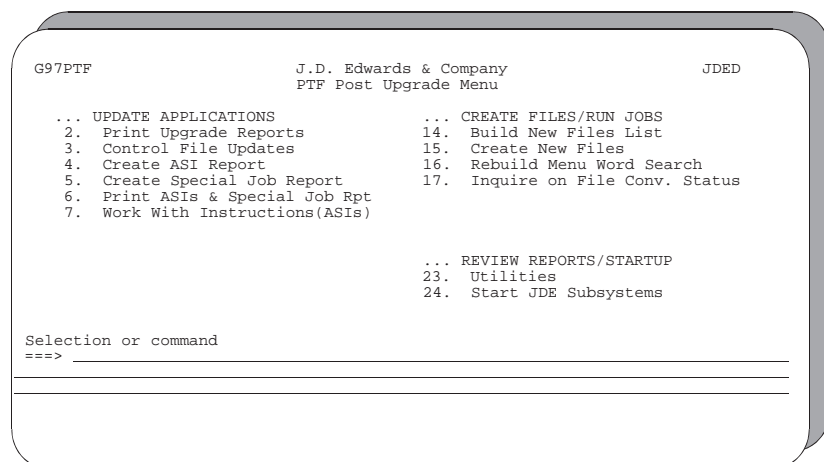

```
G97PTF                                J.D. Edwards & Company                                JDED
                                         PTF Post Upgrade Menu

... UPDATE APPLICATIONS                                ... CREATE FILES/RUN JOBS
 2. Print Upgrade Reports                               14. Build New Files List
 3. Control File Updates                               15. Create New Files
 4. Create ASI Report                                 16. Rebuild Menu Word Search
 5. Create Special Job Report                         17. Inquire on File Conv. Status
 6. Print ASIs & Special Job Rpt
 7. Work With Instructions(ASIs)

                                         ... REVIEW REPORTS/STARTUP
                                         23. Utilities
                                         24. Start JDE Subsystems

Selection or command
====> _____
_____
```

- ❑ **Run special application jobs.** If special application jobs exist for the PTF you are installing, they are listed on the G97Uxx menu, which is explained below. If no jobs exist, either the G97Uxx menu will not exist or the menu will let you know that no jobs exist. In this case, you can skip this checklist item.

IMPORTANT: You must select jobs in the order in which they appear for a product group. Be sure to read the menu message that appears after you select a job.

MULTI-PLANS: You must run the appropriate special application jobs against each production data library defined in your plans.

1. From the PTF Post Upgrade Menu (G97PTF), enter G97Uxx where xx is the last two characters in the PTF library name (for example, G97U01 if the PTF library name is A73PC00001).

The PTF Special Application Jobs menu appears.

2. Run any listed jobs for the product groups you have installed on your machine.

- ❑ **Only if you use a comma for the decimal character.** If your system uses a comma (,) for the decimal character, complete the checklist items in *Appendix D – Change Decimal Character*. Otherwise, continue to the next checklist item.

- ❑ **Inquire on file conversion status.** After PTF_STEP2 completes, check for file conversions that completed abnormally and resolve any problems.

MULTI-PLANS: You must inquire on file conversion status for each plan. Specify each plan name and the associated library name. Do not check file conversion status for an upgrade plan until the associated STEP2 job has finished. The message *STEP 2 Completed for Plan name* is sent for each plan where *name* is the name of the plan.

1. From the PTF Post Upgrade Menu (G97PTF), select Inquire on File Conversion Status.

```

972613                               File Conversion Status
Plan Name . . . _____
Library Name . . _____
Conversion Sts . . _____
Skip to File . . _____

Op  Object   Library  File  Conversion  Cvt  Cvt      User   Run
Op  Name     Name     Type  Type       Fil  Sts     ID     Date

Opt: 1=Display Joblog  8=Print Joblog  F3=Exit  F24=More
    
```

2. In the Plan Name field, type the name of the upgrade plan for which you want to check file conversion status.
3. In the Library Name field, type the name of your common library.
4. In the Conversion Sts field, enter CA (Completed Abnormally).
5. To display the job log for a file conversion listed on this screen, in the OP (Option) field next to a file conversion job, enter 1 (Display the job log).
6. Repeat steps 3 through 5 for your production and security libraries also.
7. Note any files that failed conversion and resolve any problems before you continue with the upgrade. For assistance, call J.D. Edwards Worldwide Customer Support.

- ❑ **Go to Phase 5.**

Phase 5 – Review Reports

This phase shows what you must do to review PTF installation reports and ready your production environment for use.

Checklist

- ❑ **Access the PTF Post Upgrade Menu.** From any J.D. Edwards menu, enter G97PTF.

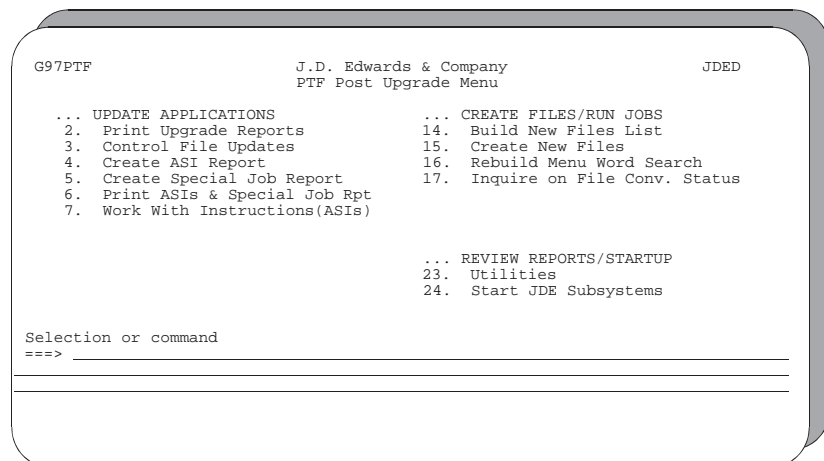

```
G97PTF                                J.D. Edwards & Company                JDED
                                         PTF Post Upgrade Menu

... UPDATE APPLICATIONS                ... CREATE FILES/RUN JOBS
 2. Print Upgrade Reports                14. Build New Files List
 3. Control File Updates                15. Create New Files
 4. Create ASI Report                   16. Rebuild Menu Word Search
 5. Create Special Job Report           17. Inquire on File Conv. Status
 6. Print ASIs & Special Job Rpt
 7. Work With Instructions(ASIs)

                                         ... REVIEW REPORTS/STARTUP
                                         23. Utilities
                                         24. Start JDE Subsystems

Selection or command
====> _____
```

- ❑ **Work with ‘Z’ libraries.** The work libraries are named *Zlibrary* where *library* is the name of your common or production data library. You must display your ‘Z’ libraries, and delete all empty ‘Z’ libraries.

IMPORTANT: If a ‘Z’ library is not empty, an unresolved file conversion problem may exist. For assistance, call J.D. Edwards Worldwide Customer Support.

1. From the PTF Post Upgrade Menu (G97PTF), select Utilities.
2. From the Upgrade Utilities menu (G97R42), select Work with ‘Z’ Libraries.
3. In the Library field on the Work with ‘Z’ Libraries screen, enter Z*. The ‘Z’ libraries are listed.

4. To view the contents of a library, enter 5 (Display) in the Opt field next to the library name.
5. If the library is empty, from the Work with 'Z' Libraries screen, enter 4 (Delete) in the option field next to the library.

❑ Sign on as JDEINSTAL to access the Software Upgrade Menu.

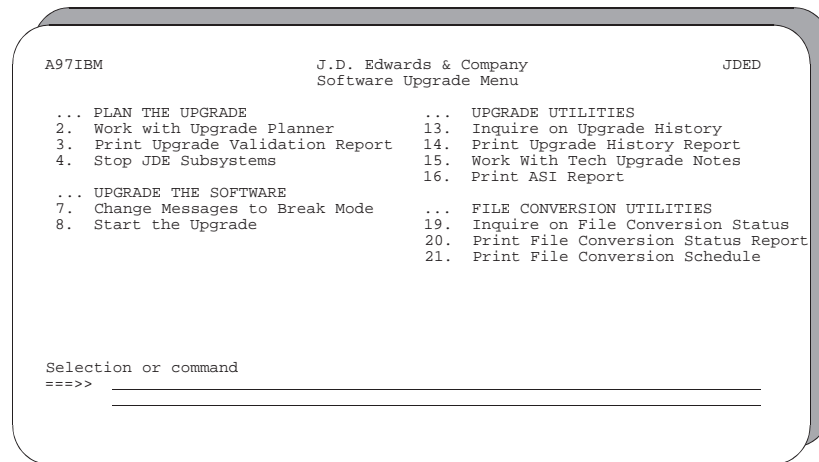

❑ Print the File Conversion Status report. J.D. Edwards recommends that you print this report for your records.

1. From the Software Upgrade Menu (A97IBM), select Print File Conversion Status Report.

The Version Selection screen appears for form ID P972612.
2. In the O (Option) field next to version ZJDE0001, enter 3 (Add).
3. Press Enter until the Data Selection screen appears.
4. In the Value field for Plan Name, type the name of the upgrade plan that defines the environment for which you want to run the report.
5. Press Enter until the Version Selection screen appears again.
6. In the O (Option) field next to the version you created, enter 1 (Run).
7. When the job finishes, print the report.

- ❑ **Review the installation reports.** After you complete Phase 4, you can review the various reports the system produced.
 - Software Versions Repository Merge Report (R98726A) – Lists the members in your production library that were affected by the merge.
 - Merge DREAM Writer Specifications Report (R98723) – Lists the DREAM Writer changes and additions.
 - Vocabulary Overrides Changed Report (R987212) – Lists the vocabulary overrides that were changed in your production library.
 - Vocabulary Overrides Not Changed Because of Overrides Report (R98721) – Lists the vocabulary overrides that were bypassed during the merge. They would have been changed if their override fields were not set to Y.
 - Transfer User Defined Codes Report (R98724) – Lists the user defined codes in your production library that were affected by the merge.
 - Menu Additions Report (R983402) – Lists the menus that were added to your production library.
 - Generic Rate/Message Update Report (R98725) – Lists table and code updates, including messages and rates.
 - Job Logs (QPJOBLOG) – Lists all installation messages, including AS/400 error messages and J.D. Edwards installation messages.

IMPORTANT: Keep the job log files (QPJOBLOG) in an output queue where they will not be deleted. They are extremely useful for resolving installation problems. The PTF_STEP1 job log shows what happened during the tape restore portion of the PTF installation process. The PTF_STEP2 job logs show what happened during file conversions and merges.

- ❑ **Start the J.D. Edwards sleeper subsystem.** While signed on as a user with security officer authority, start the sleeper subsystem.

- Sign off as JDEINSTAL.**
- Sign on as a user that accesses your production environment.**
- End the J.D. Edwards monitor.** After you have completely upgraded your environment, end the J.D. Edwards monitor.

MULTI-PLANS: Do not end the J.D. Edwards monitor until you have completely upgraded all environments.

1. From the PTF Post Upgrade Menu (G97PTF), select Utilities.
2. From the Upgrade Utilities menu (G97R42), select End JDE Monitor.

You are ready to operate J.D. Edwards software at the new PTF level.

Appendix A – Control File Dependencies

Even though you can put the following sets of control files in different libraries, you must keep the files of any particular set together in the same library on your machine. For example, you could put all of your User Security files in one library, and put your DREAM Writer files in another. This helps you avoid problems when you use or upgrade J.D. Edwards software.

Control File Sets

User Security

- F0092 – User Information
- F00921 – User Display Preferences
- F0093 – Library List Control
- F0094 – Library List Master Files

DREAM Writer

- F98301 – DREAM Writer Master Parameter
- F98302 – DREAM Writer Processing Options (Language Preference)
- F98303 – DREAM Writer Version Headings (Language Preference)
- F9831 – DREAM Writer Values Parameter
- F98311 – DREAM Writer Headings File
- F98312 – DREAM Writer Printer Overrides
- F81900 – DREAM Writer Performance Statistics Master
- F81901 – DREAM Writer Statistics Detail
- F81902 – DREAM Writer Statistics Detail Accumulator

Data Dictionary

- F9200 – Data Item Master
- F9201 – Data Field Specs
- F9202 – Data Field Display Text
- F9203 – Data Item Alpha Descriptions
- F9204 – Data Item Aliases
- F9205 – Data Dictionary – Error Message Program ID
- F9206 – Alternate User Defined Codes Tag File
- F9816 – Data Dictionary Generic Text File
- F98163 – Data Dictionary Generic Text Key Index File

Vocabulary Overrides/Function Keys

- F9220 – Screen/Report Text Master
- F9601 – Function Key Translation Master
- F9601D – Function Key Definitions – Alternate Language Descriptions
- F9611 – Function Key Translation Detail
- F9620 – Cursor Sensitive Control Master
- F9621 – Cursor Control Format Master Maintenance

User Defined Codes

- F0004 – User Defined Code Types
- F0004D – User Defined Code Types (Alternate Language Descriptions)
- F0005 – User Defined Codes
- F0005D – User Defined Codes (Alternate Language Descriptions)

Software Versions Repository

- F9801 – Software Versions Repository Master
- F98012 – SVR Member Category Codes
- F98013 – SVR Member Parm/Key List
- F9802 – Software Versions Repository Detail

Generic Message/Rates Files

- F0019 – Generic Message/Rates Types
- F00191 – Generic Message Rates
- F00192 – Generic Message Detail

Menu Files

- F0082 – Menu Master File
- F00821 – Menu Selections
- F0083 – Menu Text Overrides
- F009190 – Word Search Occurrences Master
- F009690 – Word Search Master
- F009790 – Word Search Verbs

Generic Text Files

- F0016 – Generic Text File
- F00161 – Generic Text Window Definition File
- F00162 – Generic Text Key Definition File
- F00163 – Generic Text Key Index File
- F00164 – Generic Text Key Index File (120 Character)

Appendix B – LODRUN Command

This appendix explains what functions the LODRUN command performs.

Overview of the LODRUN Command

To install the upgrade planner and the installation library (JDEINSTAL), you must use the LODRUN command, which is a standard IBM command. It performs the following functions:

- Restores the QINSTAPP program, which contains code that performs the functions listed below.
- Deletes the old JDEINSTAL library and restores the new one. The JDEINSTAL library contains all the programs you need to perform the installation, reinstallation, or PTF installation. It also includes the application specific instruction (ASI) files.
- Deletes and restores the JDFINS library. This library contains all the files and programs you need to plan the installation, reinstallation, or PTF installation, including:
 - Upgrade planner files and programs
 - Installation history files
 - Upgrade plans (ZJDE-type models) provided by J.D. Edwards. You can use these plans as base models for new plans by using the upgrade planner.

NOTE: When the LODRUN command deletes and restores JDFINS, the upgrade plans you have created previously will not be affected.

- Creates the JDEINSTAL user profile if it does not exist on your machine.
- Sends a message that tells the installer to sign on as JDEINSTAL.

Appendix C – Upgrade Planner Screens

This appendix describes the upgrade planner screens and their fields.

Plan the Upgrade Screen

This screen lets you add or change an upgrade plan that the installation or upgrade process will use.

```
960099                                Plan the Upgrade
Action Code. . . I
Plan Name. . . . ZJDE
Description. . . SIMPLE PRODUCTION PLAN

Enter the name of a plan.

You can choose one of the following or copy them
to create your own plan. Note that "ZJDE" plans
cannot be changed or deleted.

We RECOMMEND you review the following:

      ZJDE      - Simple Production Plan
      ZJDE_ALT - Alternate Upgrade Plan

** Press F5 key to enter upgrade data **

      F3=Exit      F24=More Keys
```

To display a list of all available plans, move the cursor to the Plan Name field on the Plan the Upgrade screen, and press F1. You cannot modify or delete the models (ZJDE-type plans).

Appendix C – Upgrade Planner Screens

The following table explains the fields on this screen.

FIELD	EXPLANATION
Action Code	Specify the action you want to perform on an upgrade plan. Valid action codes are: A Add C Change D Delete I Inquire
Plan Name	Specify the name of an upgrade plan. To add a plan, see the instructions that follow this table. Do not prefix your new plan name with ZJDE. NOTE: If you are a new client, J.D. Edwards recommends you use the ZJDE upgrade plan J.D. Edwards provides to set up your plans. In addition, J.D. Edwards recommends you retain the values that are set by J.D. Edwards in this plan. You can inquire on the ZJDE-type plans to view them, but you cannot modify or delete them.
Description	Specify a description for the plan.

■ To add an upgrade plan

1. From the Plan the Upgrade screen, inquire on a ZJDE upgrade plan model provided by J.D. Edwards.
2. In the Action Code field, type A (Add).
3. In the Plan Name field, type a name for the new upgrade plan.
4. In the Description field, enter a description for the new upgrade plan.
5. Inquire on the new upgrade plan.

Libraries for This Plan Screen

This screen lets you define environment information for the upgrade plan. It lets you specify the J.D. Edwards libraries to which you want the software installed and, for upgrades, the libraries that contain data files you want to convert.

```

96003                               Plan the Upgrade                               Screen 1 of 3
                               Libraries for this plan

Plan Name. . . . . ZJDE             SIMPLE PRODUCTION PLAN

Specify all libraries for this environment that contain J.D. Edwards
files and programs.  Exclude IBM libraries such as QGPL and QTEMP.
Specify current software release level and the release to upgrade to.
Current JDE Release Level . . . . . A73
New JDE Release Level . . . . . A73

Install Source Library. . . . . 0      (1=Yes, 0=No)
Install Object/Data Libraries . . 1

Lib   Library      Library
Typ   Name         Description
COM   CLTCOM       Client's Common Library
DTA   CLTDATA      Client's Data Library
SEC   CLTSEC       Client's Security Library
JDF   JDFDATA      JDE Data Library
OBJ   JDFOBJ       JDE Object Library
SRC   JDFSRC       JDE Source Library

ENTER=Update/Next Screen      F12=Previous Screen      F24=More Keys
    
```

The following table explains the fields on this screen.

FIELD	EXPLANATION
Current JDE Release Level	Specify the current J.D. Edwards software release level of the environment you want to upgrade (for example, A52 or A62). NOTE: For new installations, specify the release level of the J.D. Edwards software you are installing (for example, A73). IMPORTANT: Do not type more than three characters in this field.
New JDE Release Level	Specify the J.D. Edwards software release level to which you want to upgrade your environment (for example, A73). NOTE: For new installations, specify the release level of the J.D. Edwards software you are installing (for example, A73). For PTFs, specify the name of the PTF (for example, A73PC00001).

Appendix C – Upgrade Planner Screens

FIELD	EXPLANATION
Install Source Library	<p>Specify whether you want the J.D. Edwards source code library (usually JDFSRC) restored. Valid values are:</p> <p>0 Do not restore the source code library. 1 Restore the source code library.</p> <p>NOTE: For reinstallations, J.D. Edwards recommends that you restore source at a different time than you restore object and data to significantly reduce the time it takes to complete the reinstallation. For information about reinstalling source only, refer to the <i>Upgrade Reference Guide</i>.</p>
Install Object/Data Libraries	<p>Specify whether you want the J.D. Edwards object and data libraries (usually JDFOBJ and JDFDATA) restored. Valid values are:</p> <p>0 Do not restore the object and data libraries. 1 Restore the object and data libraries.</p>
Lib Typ (Library Type)	<p>Specify the type of library. Valid values are:</p> <p>COM Common Library CSO Custom Object CSS Custom Source DTA Client's Data Library JDF J.D. Edwards Data Library KBG CASE Constants Library OBJ J.D. Edwards Object Library SEC Security Library SRC J.D. Edwards Source Library</p> <p>IMPORTANT: Do not create new library types, which will cause unpredictable results. In addition, do not specify more than one library for JDF, OBJ, SEC, and SRC library types. For new installations, do not specify more than one library for the DTA library type also.</p> <p>Data libraries contain J.D. Edwards data files, such as Address Book. The common library holds J.D. Edwards control files, such as menu and DREAM Writer files.</p>

FIELD	EXPLANATION
Library Name	<p>Specify the name of a library for this environment.</p> <p>NOTE: If you are setting up your own upgrade plans for multiple environments that have separate object libraries, each environment plan must have separate sets of security files (F0092, F0093, F0094, and F0095). J.D. Edwards recommends you set up SEC-type libraries (security libraries) for these files.</p> <p>NOTE: If a library you specify in this field does not exist on your machine, the Create Plan Library screen appears after you press Enter from the Libraries for This Plan screen. An example of the Create Plan Library screen follows this table. This screen lets you verify the library name that appears on the Libraries for This Plan screen, but does not exist on your machine. Press Enter to create the library, or press F3 to exit without creating it. If the library name is not correct, enter a new name. The library name on the Libraries for This Plan screen will be updated automatically.</p>
Library Description	Specify a description for each library. For example, you could describe JDFDATA as J.D. Edwards Data Library.

The Create Plan Library screen appears below.

```

97CRTL                                Create Plan Library

      This procedure will create the library shown that currently does not
      exist on your system. Please verify that you have entered the correct
      library for your plan before pressing enter.

                Library                Library
                Name                    Description
      CLTCOM      Client's Common Library

ENTER - Create Library   F3=Exit w/o Create
    
```

FIELD	EXPLANATION
Sys (System)	Indicates the system code for the application. You cannot change the value in this field.
Name	The name of the application system. You cannot change the value in this field.

Merge Information Screen

The Merge Information screen lets you specify the modes in which the merges will run and indicate the library locations for the files to be merged.

NOTE: The merges do not run if you are installing the software for the first time (the J.D. Edwards object library never existed before on your machine). J.D. Edwards recommends you do not change the default merge modes whether you are installing to new environments or upgrading existing ones.

The upgrade planner fills the Library Name fields with the default library names from the Libraries for This Plan screen. Be sure the library names represent the locations of the files and also appear on the Libraries for This Plan screen.

NOTE: The DREAM Writer Ver. Prefix field is not a Library Name field.

IMPORTANT: Do not enter a DREAM Writer version prefix value of zeros (000000).

```

96001E                               Plan the Upgrade                               Screen 3 of 3
                                     Merge Information

Plan Name. . . . . ZJDE             SIMPLE PRODUCTION PLAN

Specify merge modes and library names.

(0=No Merge, 1=Proof, 2=Final, 3=Replace)
                                     Library Name
                                     0/1/2/3
Data Dictionary Merge. . . . . 2   Data Dictionary. . . . . CLTCOM
Vocab. Overrides Merge . . . . . 2   Vocabulary Overrides . . . CLTCOM
DREAM Writer Merge . . . . . 2     DREAM Writer . . . . . CLTCOM
Menu Master Merge. . . . . 2       Menu Master. . . . . CLTCOM
User Defined Codes Merge . . . . 2   User Defined Codes . . . CLTCOM
Generic Message/Rates Merge. . . 2   Generic Message/Rates. . CLTDTA
Help Master Merge. . . . . 3       Help Master. . . . . CLTCOM
Software Repository Merge. . . . 2   Software Repository. . . CLTCOM
Generic Text Keys Merge. . . . . 2   Gen. Text Applic. Key Files CLTCOM
Auto Acct Instructions Merge . . 2   Auto Acct Instructions . . CLTDTA
Next Numbers Merge . . . . . 2     Next Numbers . . . . . CLTCOM

Data D/Vocab Override Rebuild. 2   DREAM Writer Ver. Prefix .
F5=Printer Overrides F8=Advanced Options F12=Previous Screen F24=More Keys
    
```

Appendix C – Upgrade Planner Screens

The following table explains the fields on this screen.

FIELD	EXPLANATION
Data Dictionary Merge	<p>Specify the mode in which you want the merge to run.</p> <p>In final mode, the merge adds new data items and updates fields in your existing data items with the exception of those you have customized. The merge also produces a report that lists updates made to your data items.</p> <p>For more information about the merge and report, refer to the <i>Upgrade Reference Guide</i>. Valid values are:</p> <ul style="list-style-type: none"> 0 Do not run the merge (No Merge). 1 Generate the report without running the merge (Proof). 2 Run the merge and generate the report (Final). 3 Run the language upgrade (Replace). This is valid for language upgrades only. For reinstallations, it will run as 2 (Final). <p>NOTE: To update the data dictionary glossary, see <i>Advanced Options Screen</i> in this appendix.</p>
Data Dictionary Library Name	Specify the name of the production library that contains your Data Dictionary file (F9800 for A5, F9200 for A6 or A7).
Vocab. Overrides Merge	<p>Specify the mode in which you want the merge to run.</p> <p>In final mode, the merge adds new vocabulary override records and updates existing records, but not VTX (video and report soft-coded text) fields that have a Y in the override field. The merge also produces two reports: one that lists updates made to your records and another that lists VTX fields not updated because each has a Y in the override field.</p> <p>For more information about the merge and reports, refer to the <i>Upgrade Reference Guide</i>. Valid values are:</p> <ul style="list-style-type: none"> 0 Do not run the merge (No Merge). 1 Generate the reports without running the merge (Proof). 2 Run the merge and generate the reports (Final). 3 Run the language upgrade (Replace). This is valid for language upgrades only. For reinstallations, it will run as 2 (Final).
Vocabulary Overrides Library Name	Specify the name of the production library that contains your Vocabulary Overrides file (F0020 for A5, F9220 for A6 or A7).

FIELD	EXPLANATION
DREAM Writer Merge	<p>Specify the mode in which you want the merge to run.</p> <p>In final mode, the merge adds new form IDs and their associated versions, replaces processing option text, adds new ZJDE and XJDE versions, replaces existing XJDE versions, and updates the open query file option fields if your fields are different than those in JDFDATA.</p> <p>For reinstallations, the merge updates data selection, data sequencing, and processing options wherever it is possible, flags some items for your review, and does not produce a report.</p> <p>For PTFs, the merge does not add or change values in existing processing options, or update fields that could contain information you defined for your own specific purposes. It also produces a report that shows form IDs that have been added, ZJDE versions that have been added, and indicates whether open query file option fields have been updated.</p> <p>For more information about the merge and report, refer to the <i>Upgrade Reference Guide</i>. Valid values are:</p> <ul style="list-style-type: none"> 0 Do not run the merge (No Merge). 1 For PTFs, generate the report without running the merge (Proof) 2 Run the merge (Final). 3 Run the language upgrade (Replace). This is valid for language upgrades only. For reinstallations, it will run as 2 (Final).
DREAM Writer Library Name	Specify the name of the production library that contains your DREAM Writer file (F98301).

Appendix C – Upgrade Planner Screens

FIELD	EXPLANATION
Menu Master Merge	<p>Specify the mode in which you want the merge to run.</p> <p><i>For reinstallations:</i> In final or replace mode, the merge adds new menus and lists them on the Menu Additions Report. In final mode, the merge updates existing menus. In replace mode, it replaces all J.D. Edwards menus and updates existing custom menus. The merge does not affect menu security settings.</p> <p>The merge also produces an Obsolete Menus report, which lists menus that J.D. Edwards has made obsolete. It may produce a Menu Merge Exceptions report, which lists new and obsolete programs.</p> <p><i>For PTFs:</i> In final mode, the merge adds new menus and lists them on the Menu Additions Report. The merge also produces a report that lists the differences between your menus and those in JDFDATA. You will use the information on this report to update your menus.</p> <p><i>For reinstallations and PTFs:</i> For more information about the merge and reports, refer to the <i>Upgrade Reference Guide</i>. Valid values are:</p> <ul style="list-style-type: none"> 0 Do not run the merge (No Merge). 1 Generate the report(s) without running the merge (Proof). 2 For reinstallations, update existing menus and generate the reports. For PTFs, run the merge and generate the report (Final). 3 For reinstallations and language upgrades, replace all J.D. Edwards menus. For reinstallations, update custom menus also (Replace).
Menu Master Library Name	Specify the name of the production library that contains your menu files (F0082, F00821, F0083, and F0084).

FIELD	EXPLANATION
User Defined Codes Merge	<p>Specify the mode in which you want the merge to run.</p> <p>In final mode, the merge adds new user defined code tables and their values for all system codes, and adds new user defined code values for existing tables located in system codes 84 through 99 and in system code 00, record type IO. It adds selected new values to existing tables. The merge also produces a report that lists updates made to your tables and codes.</p> <p>For more information about the merge and report, refer to the <i>Upgrade Reference Guide</i>. Valid values are:</p> <ul style="list-style-type: none"> 0 Do not run the merge (No Merge). 1 Generate the report without running the merge (Proof). 2 Run the merge and generate the report (Final). 3 Run the language upgrade (Replace). This is valid for language upgrades only. For reinstallations, it will run as 2 (Final). <p>NOTE: To update the user defined code detail text, see <i>Advanced Options Screen</i> in this appendix.</p>
User Defined Codes Library Name	Specify the name of the production library that contains your User Defined Codes files (F0004 and F0005).
Generic Message/Rates Merge	<p>Specify the mode in which you want the merge to run. The merge operates the same as the user defined codes merge except that it includes the free form text associated with the rate on the message.</p> <p>In final mode, the merge adds new user defined code tables and their values for all system codes, and adds new user defined code values for existing tables located in system codes 80 through 99. It does not add new values for existing tables located in system codes 00 through 79. The merge also produces a report that lists updates made to your tables and codes.</p> <p>For more information about the merge and report, refer to the <i>Upgrade Reference Guide</i>. Valid values are:</p> <ul style="list-style-type: none"> 0 Do not run the merge (No Merge). 1 Generate the report without running the merge (Proof). 2 Run the merge and generate the report (Final).
Generic Message/Rates Library Name	Specify the name of the production library that contains your Generic Message/Rates files (F0019, F00191, and F00192).

Appendix C – Upgrade Planner Screens

FIELD	EXPLANATION
Help Master Merge	<p>Specify the mode in which you want the merge to run.</p> <p>This merge runs in replace mode only, which replaces the Help files. The merge does not produce a report.</p> <p>For more information about the merge, refer to the <i>Upgrade Reference Guide</i>. Valid values are:</p> <ul style="list-style-type: none"> 0 Do not run the merge (No Merge). 3 Run the merge in replace mode (Replace).
Help Master Library Name	Specify the name of the production library that contains your Help file (F98HELP).
Software Repository Merge	<p>Specify the mode in which you want the merge to run.</p> <p>For more information about the merge and report, refer to the <i>Upgrade Reference Guide</i>. Valid values are:</p> <ul style="list-style-type: none"> 0 Do not run the merge (No Merge). 1 Generate the report without running the merge (Proof). 2 Run the merge and generate the report (Final).
Software Repository Library Name	Specify the name of the production library that contains your Software Versions Repository files (F9801 and F9802).
Generic Text Keys Merge	<p>Specify the mode in which you want the merge to run.</p> <p>The merge does not produce a report.</p> <p>For more information about the merge, refer to the <i>Upgrade Reference Guide</i>. Valid values are:</p> <ul style="list-style-type: none"> 0 Do not run the merge (No Merge). 2 Run the merge (Final).
Gen. Text Applic. Key Files (Generic Text Application Key Files) Library Name	Specify the name of the library that contains your Generic Text Application Key files (F00161 and F00162). These files contain the key fields that are used on generic text windows (program P0016) to access the generic text. For example, F14 (Memo) on the User Defined Codes screen accesses the User Defined Code Detail window (a generic text window), which displays descriptive text about a specific user defined code. The three key fields displayed at the top of the window are defined in the Generic Text Application Key files. You cannot modify the information in these files.

FIELD	EXPLANATION
Auto Acct Instructions (Automatic Accounting Instructions) Merge	<p>Specify the mode in which you want the merge to run.</p> <p>In final mode, the merge adds new automatic accounting instructions (AAIs) with the exception of distribution AAIs. The merge also produces a report that lists the new AAIs.</p> <p>For more information about the merge and report, refer to the <i>Upgrade Reference Guide</i>. Valid values are:</p> <ul style="list-style-type: none"> 0 Do not run the merge (No Merge). 1 Generate the report without running the merge (Proof). 2 Run the merge and generate the report (Final). <p>NOTE: For PTFs, set this merge mode to 0 because the merge does not apply to PTFs.</p>
Auto Acct Instructions (Automatic Accounting Instructions) Library Name	<p>Specify the name of the production library that contains your Automatic Accounting Instructions file (F0012).</p>
Next Numbers Merge	<p>Specify the mode in which you want the merge to run.</p> <p>In final mode, the merge adds new next numbers (index lines) for existing systems or new systems. The merge also produces a report that lists the new next numbers.</p> <p>For more information about the merge and report, refer to the <i>Upgrade Reference Guide</i>. Valid values are:</p> <ul style="list-style-type: none"> 0 Do not run the merge (No Merge). 1 Generate the report without running the merge (Proof). 2 Run the merge and generate the report (Final). <p>NOTE: For PTFs, set this merge mode to 0 because the merge does not apply to PTFs.</p>
Next Numbers Library Name	<p>Specify the name of the production library that contains your Next Numbers file (F0002).</p>

Appendix C – Upgrade Planner Screens

FIELD	EXPLANATION
DD/VO/DREAM Writer Rebuild (Data Dictionary/ Vocabulary Overrides/DREAM Writer Rebuild)	<p>Specify the mode in which you want the rebuild job to run.</p> <p>The rebuild updates the vocabulary override fields with the row/column heading text specified in the data dictionary if the override flags for the fields are set to blank. The rebuild does not produce a report.</p> <p>For more information about the rebuild, refer to the <i>Upgrade Reference Guide</i>. Valid values are:</p> <p>0 Do not run the rebuild (No Merge). 2 Run the rebuild (Final).</p>
DREAM Writer Ver. (Version) Prefix	<p>Beginning with release A6.1, the upgrade process expands the version ID field to a 10-character alphanumeric field. If you are upgrading from release level A5.2, all DREAM Writer version IDs will be renamed. Specify a version prefix (up to six alphanumeric characters) you want added to your existing version IDs. Hard-coded versions (blind versions) will be automatically prefixed with ZJDE0 only if corresponding ZJDE versions exist in JDFDATA. Otherwise, they will be prefixed with the characters you indicate here. If you indicate no characters in this field, the non-ZJDE versions will be converted to four-digit numbers, such as 0005.</p> <p>If you are upgrading from release A6.2, A7.1, or A7.2, the upgrade process ignores the value in this field.</p> <p>For more information about how the upgrade process handles version IDs, refer to the <i>Upgrade Reference Guide</i>.</p>

Printer Information Screen

This screen lets you override default values for the various printer attributes, such as form length, form type, and lines per inch, for the reports created during the upgrade process.

IMPORTANT: The information you specify on this screen will affect upgrade reports only. If you want to change all printer files in the OBJ-type library, refer to *Miscellaneous* in the *Upgrade Reference Guide*.

```

96001D                               Plan the Upgrade
                                       Printer Information

Plan Name. . . . . ZJDE             SIMPLE PRODUCTION PLAN

The following information will be used to determine how to print
the reports created by the upgrade process.

                                       1/0   (1=Yes, 0=No)

Override Print Options . . . . .    0
Output Queue . . . . .             QPRINT_____

Width of Form. . . . .             132
Length of Your Form. . . . .       68
Overflow Line. . . . .             62
Characters per Inch. . . . .       15
Lines per Inch . . . . .           8
Form Type. . . . .                 *STD_____
Number of Copies . . . . .         1

                                       F12 or ENTER=Previous Screen
                                       F24=More Keys
    
```

The following table explains the fields on this screen.

FIELD	EXPLANATION
Override Print Options	Specify whether you want to override the default values for the printer file attributes, which determine how reports are printed. Valid values are: 0 Do not override printer file information. 1 Override printer file information.
Output Queue	Specify the name of the output queue to which you want reports sent. If the output queue does not exist, you must create it. Typically, the output queue is QPRINT. If no printer is assigned to the user's terminal, the default output queue will be used.
Width of Form	Specify the width of the form you will use to print reports. You must enter this value as the number of print positions per line in the range 1 to 378.

Appendix C – Upgrade Planner Screens

FIELD	EXPLANATION
Length of Your Form	Specify the length of the form you will use to print reports. You must enter this value as the number of lines per page in the range 1 to 255.
Overflow Line	Specify when overflow to a new page should occur. Overflow occurs when the line you specify becomes the current line number, regardless of whether printing occurs on that line. You must enter this value as the number of lines per page in the range 1 to 255.
Characters per Inch	Specify the horizontal printing density of characters you want to use for reports. You must enter this value as characters per inch, and it must be supported by your printer.
Lines per Inch	Specify the line spacing you want to use for reports. You must enter this value as lines per inch, and it must be supported by your printer. Valid values are: 4 IBM 5219, 5224, 5225, and 3287 printers only. 6 IBM 5224 printer only. 8 IBM 5224 printer only. 9 IBM 5224 printer only.
Form Type	Specify the type of form you want to use for reports. You must enter a value that is supported by your printer. Valid values are: *STD The standard printer form used by your printer. <i>name</i> The name of a special form type defined for your printer.
Number of Copies	Specify the number of copies you want printed for reports.

Advanced Options Screen

This screen lets you control several advanced upgrade functions, including:

- Hold on print queue option
- Control file conversion
- Data dictionary glossary update
- User defined codes detail text update
- Obsolete menus deletion

You can also indicate whether the environment you are upgrading is double byte.

NOTE: You may not need to change the values on this screen. Review the values to make sure the selections are appropriate for your upgrade plan.

```

96001A                               Plan the Upgrade
                                       Advanced Options

Plan Name. . . . . ZJDE             SIMPLE PRODUCTION PLAN

The following information will be used to determine the jobs that will run.

                                       1/0      (1=Yes, 0=No)

Hold on Print Queue. . . . . 0

Run Control File Conversion. . . . . 1
Update Data Dictionary Glossary. . . . 1
User Defined Codes Detail Text Update. 1
Delete Obsolete Menus. . . . . 0

Double Byte Environment. . . . . 0

                                       F12 or ENTER=Previous Screen
                                       F24=More Keys
    
```

The following table explains the fields on this screen.

FIELD	EXPLANATION
Hold on Print Queue	Specify whether to hold the print file in the print queue rather than printing it. Valid values are: 0 Do not hold files on the print queue. 1 Hold files on the print queue.

Appendix C – Upgrade Planner Screens

FIELD	EXPLANATION
Run Control File Conversion	<p>Specify whether control file conversion should run during the upgrade process. Leave this value set to 1 unless you are instructed otherwise. Valid values are:</p> <p>0 Do not run control file conversion. 1 Run control file conversion.</p> <p>NOTE: If you are a new client installing for the first time (no J.D. Edwards object library existed before), this option will be ignored.</p>
Update Data Dictionary Glossary	<p>Specify whether the data dictionary glossary should be updated during the upgrade process. If you have changed the glossary extensively in the past, you may not want to update it. However, because no report exists to show you the glossary differences between JDFDATA and your environment, no alternative exists to update your glossary. Glossary items cannot be selectively updated. Valid values are:</p> <p>0 Do not update the glossary. 1 Update the glossary.</p> <p>NOTE: If you are a new client installing for the first time (no J.D. Edwards object library existed before), this option will be ignored.</p>
User Defined Codes Detail Text Update	<p>Specify whether the detailed text associated with user defined codes (F9816 and F98163) should be updated during the upgrade process. Valid values are:</p> <p>0 Do not update the detailed text. 1 Add new detailed text (does not affect existing text).</p> <p>NOTE: If you are a new client installing for the first time (no J.D. Edwards object library existed before), this option will be ignored.</p>
Delete Obsolete Menus	<p>Specify whether the obsolete menus should be deleted during the upgrade process. Valid values are:</p> <p>0 Do not delete obsolete menus. 1 Delete obsolete menus.</p> <p>NOTE: For PTFs, leave the default value set to 0. The PTF installation process does not delete menus that are obsolete.</p>
Double Byte Environment	<p>Specify whether the environment you are upgrading is double byte. Valid values are:</p> <p>0 Not double-byte environment. 1 Double-byte environment.</p>

Appendix D – Change Decimal Character

These checklist items show what you must do to change the decimal character used in the Category Table of Contents to a comma character.

NOTE: The user signon you use for the following procedure must have command entry authority.

Checklist

Change the decimal character for the Category Table of Contents.

1. In the Selection field at the bottom of your screen, enter DSPSYSVAL QDECFMT. This displays your system's decimal format. If your format is 2, 3, I, or J, your system uses a comma for the decimal character.
2. After you determine the decimal character your system uses, exit this screen.
3. If your system does not use the comma, skip the following steps. Continue to the next checklist item.
4. From the PTF Post Upgrade Menu (G97PTF), select Control File Updates.
5. From the Control File Updates menu, select Data Dictionary Items.

The Data Dictionary Items screen appears.
6. In the Data Item field, inquire on HELP100A.

The Data Item Glossary Revisions screen appears.
7. In the Action Code field, type C.
8. In the series of numbers displayed as 1.1, 1.2, 1.3, and so on, replace the decimal point (.) with a comma (,).

Return to where you left off in Phase 4.

