

# **Tekelec EAGLE<sup>®</sup> 5 SAS - Release 34.0**

## **Database Administration - Gateway Screening**

### **Table of Chapters**

List of Figures

List of Tables

List of Flowcharts

Chapter 1. Introduction

Chapter 2. Gateway Screening (GWS) Overview

Chapter 3. Allowed Affected Point Code (AFTPC) Screen Configuration

Chapter 4. Allowed Called Party (CDPA) Screen Configuration

Chapter 5. Allowed Translation Type (TT) Screen Configuration

Chapter 6. Allowed Calling Party (CGPA) Screen Configuration

Chapter 7. Allowed Affected Destination Field (DESTFLD) Screen Configuration

Chapter 8. Blocked Destination Point Code (BLKDPC) Screen Configuration

Chapter 9. Allowed Destination Point Code (DPC) Screen Configuration

Chapter 10. Allowed Signaling Information Octet (SIO) Screen Configuration

Chapter 11. Blocked Originating Point Code (BLKOPC) Screen Configuration

Chapter 12. Allowed Originating Point Code (OPC) Screen Configuration

Chapter 13. Screen Set Configuration

Chapter 14. Calling Name Conversion Facility (CNCF) Configuration

Chapter 15. Allowed ISUP Message Type Screen Configuration

Index



*Tekelec EAGLE<sup>®</sup> 5*  
*Signaling Application System*

---

**Release 34.0**

**Database Administration Manual - Gateway  
Screening**

910-0098-001 Revision A

September 2005



**TEKELEC**

**Copyright© 2005 Tekelec.  
All Rights Reserved  
Printed in U.S.A.**

#### **Notice**

Information in this documentation is subject to change without notice. Unauthorized use or copying of this documentation can result in civil or criminal penalties.

Any export of Tekelec products is subject to the export controls of the United States and the other countries where Tekelec has operations.

No part of this documentation may be reproduced or transmitted in any form or by any means, electronic or mechanical, including photocopying or recording, for any purpose without the express written permission of an authorized representative of Tekelec.

Other product names used herein are for identification purposes only, and may be trademarks of their respective companies.

#### **Trademarks**

The Tekelec logo, EAGLE, G-Flex, G-Port, IP<sup>7</sup>, IP<sup>7</sup>Edge, IP<sup>7</sup> Secure Gateway, and TALI are registered trademarks of Tekelec, Inc. TekServer is a trademark of Tekelec, Inc. All other trademarks are the property of their respective owners.

#### **Patents**

This product is covered by one or more of the following U.S. and foreign patents:

##### U.S. Patent Numbers:

5,008,929, 5,953,404, 6,167,129, 6,324,183, 6,327,350, 6,606,379, 6,639,981, 6,647,113, 6,662,017, 6,735,441, 6,745,041, 6,765,990, 6,795,546, 6,819,932, 6,836,477, 6,839,423, 6,885,872

#### **Ordering Information**

Additional copies of this document can be ordered from:

Tekelec Network Signaling Group  
Attention: Central Logistics  
5200 Paramount Parkway  
Morrisville, North Carolina, 27560

Or e-mail your request to [CentralLogistics@tekelec.com](mailto:CentralLogistics@tekelec.com).

# Table of Contents

## Chapter 1. Introduction

Overview .....	1-2
Manual Organization .....	1-2
Related Publications .....	1-4
Documentation Packaging, Delivery, and Updates .....	1-8
Documentation Admonishments .....	1-9
Customer Care Center .....	1-9
Emergency Response .....	1-10
Maintenance and Administration Subsystem .....	1-11
Database Partitions .....	1-12
Fixed Disk Drive .....	1-13
Removable Cartridge .....	1-14
List of Acronyms and Abbreviations .....	1-15

## Chapter 2. Gateway Screening (GWS) Overview

Introduction .....	2-2
Gateway Screening States .....	2-5
Gateway Screening Attributes .....	2-7
Use of the Character “c” for the NI, NC, NCM, ZONE, AREA, ID, NPC, MSA, SSA, and SP Parameters .....	2-11
Specifying a Range of Values for Gateway Screening Parameters .....	2-12
Use of the Asterisk “*” for the ZONE, AREA, ID, MSA, SSA, and SP Parameters .....	2-15
User Interface Requirements .....	2-16
Command Summary .....	2-17
Enter Commands .....	2-18
Change Commands .....	2-18
Delete Commands .....	2-18
Retrieve Commands .....	2-19
14-Bit ITU National Point Code Formats .....	2-24
Gateway Screening Using Duplicate ITU National Point Codes .....	2-27
Gateway Screening Configuration .....	2-28
Gateway Screening Configuration Examples .....	2-32
Adding an GLS Card .....	2-46

Removing a GLS Card .....	2-50
Configuring Gateway Screening Stop Action Sets .....	2-54
Configuring TLNP Gateway Screening Stop Action Sets .....	2-65
Removing Gateway Screening Stop Action Sets .....	2-78
Setting the Threshold for Reporting Gateway Screening Activity .....	2-81
Setting the Maximum Number of Gateway Screening Rejected Messages .....	2-86
<b>Chapter 3. Allowed Affected Point Code (AFTPC) Screen Configuration</b>	
Introduction .....	3-2
Adding an Allowed Affected Point Code Screen .....	3-4
Removing an Allowed Affected Point Code Screen .....	3-14
Changing an Allowed Affected Point Code Screen .....	3-17
<b>Chapter 4. Allowed Called Party (CDPA) Screen Configuration</b>	
Introduction .....	4-2
Adding an Allowed Called Party Address Screen .....	4-5
Removing an Allowed Called Party Address Screen .....	4-17
Changing an Allowed Called Party Address Screen .....	4-22
<b>Chapter 5. Allowed Translation Type (TT) Screen Configuration</b>	
Introduction .....	5-2
Adding an Allowed Translation Type Screen .....	5-4
Removing an Allowed Translation Type Screen .....	5-11
Changing an Allowed Translation Type Screen .....	5-14
<b>Chapter 6. Allowed Calling Party (CGPA) Screen Configuration</b>	
Introduction .....	6-2
Adding an Allowed Calling Party Address Screen .....	6-6
Removing an Allowed Calling Party Address Screen .....	6-18
Changing an Allowed Calling Party Address Screen .....	6-23
<b>Chapter 7. Allowed Affected Destination Field (DESTFLD) Screen Configuration</b>	
Introduction .....	7-2
Adding an Allowed Affected Destination Field Screen .....	7-7
Removing an Allowed Affected Destination Field Screen .....	7-16
Changing an Allowed Affected Destination Field Screen .....	7-21
<b>Chapter 8. Blocked Destination Point Code (BLKDPC) Screen Configuration</b>	
Introduction .....	8-2
Adding a Blocked DPC Screen .....	8-8
Removing a Blocked DPC Screen .....	8-21

## Table of Contents

Changing a Blocked DPC Screen .....	8-26
<b>Chapter 9. Allowed Destination Point Code (DPC) Screen Configuration</b>	
Introduction .....	9-2
Adding an Allowed DPC Screen .....	9-8
Removing an Allowed DPC Screen .....	9-22
Changing an Allowed DPC Screen .....	9-26
<b>Chapter 10. Allowed Signaling Information Octet (SIO) Screen Configuration</b>	
Introduction .....	10-2
Adding an Allowed SIO Screen .....	10-9
Removing an Allowed SIO Screen .....	10-20
Changing an Allowed SIO Screen .....	10-23
<b>Chapter 11. Blocked Originating Point Code (BLKOPC) Screen Configuration</b>	
Introduction .....	11-2
Adding a Blocked OPC Screen .....	11-8
Removing a Blocked OPC Screen .....	11-22
Changing a Blocked OPC Screen .....	11-26
<b>Chapter 12. Allowed Originating Point Code (OPC) Screen Configuration</b>	
Introduction .....	12-2
Adding an Allowed OPC Screen .....	12-8
Removing an Allowed OPC Screen .....	12-22
Changing an Allowed OPC Screen .....	12-25
<b>Chapter 13. Screen Set Configuration</b>	
Introduction .....	13-2
Automatic Destination Field Screening .....	13-2
Adding a Screen Set .....	13-3
Removing a Screen Set .....	13-12
Changing a Screen Set .....	13-15
<b>Chapter 14. Calling Name Conversion Facility (CNCF) Configuration</b>	
Introduction .....	14-2
Configuring the EAGLE 5 SAS for the CNCF Feature .....	14-4
<b>Chapter 15. Allowed ISUP Message Type Screen Configuration</b>	
Introduction .....	15-2
Adding an Allowed ISUP Message Type Screen .....	15-9
Removing an Allowed ISUP Message Type Screen .....	15-16
Changing an Allowed ISUP Message Type Screen .....	15-20
<b>Index</b>	

# List of Figures

Figure 1-1. Database Partitions .....	1-12
Figure 2-1. Sample Network Showing Gateway Screening Using Duplicate ITU National Point Codes .....	2-27
Figure 2-2. The Gateway Screening Process .....	2-31
Figure 2-3. Gateway Screening Configuration - Example 1 .....	2-33
Figure 2-4. Gateway Screening Configuration - Example 2 .....	2-35
Figure 2-5. Gateway Screening Configuration - Example 3 .....	2-37
Figure 2-6. Gateway Screening Configuration - Example 4 .....	2-39
Figure 2-7. Gateway Screening Configuration - Example 5 .....	2-41
Figure 2-8. Gateway Screening Configuration - Example 6 .....	2-43
Figure 2-9. Gateway Screening Configuration - Example 7 .....	2-45
Figure 3-1. Allowed Affected Point Code Screening Function .....	3-3
Figure 4-1. Allowed Called Party Address Screening Function .....	4-4
Figure 5-1. Allowed Translation Type Screening Function .....	5-3
Figure 6-1. Allowed Calling Party Address Screening Function .....	6-5
Figure 7-1. Allowed Affected Destination Field Screening Function .....	7-6
Figure 8-1. Blocked DPC Screening Functions .....	8-7
Figure 9-1. Allowed DPC Screening Functions .....	9-7
Figure 10-1. Allowed SIO Screening Function .....	10-8
Figure 11-1. Blocked OPC Screening Functions .....	11-7
Figure 12-1. Allowed OPC Screening Functions .....	12-7
Figure 14-1. PIP/GN Parameter Conversion .....	14-2
Figure 14-2. CNCF Gateway Screening Configuration - Example 1 .....	14-5
Figure 14-3. CNCF Gateway Screening Configuration - Example 2 .....	14-6
Figure 14-4. CNCF Gateway Screening Configuration - Example 3 .....	14-7
Figure 14-5. CNCF Gateway Screening Configuration - Example 4 .....	14-8
Figure 15-1. Allowed ISUP Message Type Screening Function .....	15-8



# List of Tables

Table 2-1. Attributes for Gateway Screening Functions .....	2-10
Table 2-2. Valid Value Combinations for ANSI Point Code Parameters .....	2-12
Table 2-3. Valid Value Combinations for H0 and H1 Parameters .....	2-13
Table 2-4. Valid Parameter Combinations for ANSI Point Code Parameters .....	2-14
Table 2-5. Valid Value Combinations for ITU-I Point Code Parameters .....	2-15
Table 2-6. Valid Value Combinations for 24-Bit ITU-N Point Code Parameters .....	2-15
Table 2-7. Valid Parameter Combinations for ITU-I Point Code Parameters .....	2-15
Table 2-8. Valid Parameter Combinations for 24-bit ITU-N Point Code Parameters .....	2-16
Table 2-9. Gateway Screening Stop Action Definitions If the CNCF Feature Is Off .....	2-55
Table 2-10. Gateway Screening Stop Action Definitions If the CNCF Feature Is On .....	2-55
Table 2-11. Sample Gateway Screening Stop Action Set Configuration .....	2-57
Table 2-12. Sample TLNP Gateway Screening Stop Action Set Configuration .....	2-66
Table 3-1. Example Gateway Screening Allowed AFTPC Configuration Table .....	3-4
Table 3-2. Valid Value Combinations for ANSI Point Code Parameters .....	3-5
Table 3-3. Valid Value Combinations for ITU-I Point Code Parameters .....	3-5
Table 3-4. Valid Value Combinations for 24-Bit ITU-N Point Code Parameters .....	3-5
Table 3-5. Valid Value Combinations for ANSI Point Code Parameters .....	3-17
Table 3-6. Valid Value Combinations for ITU-I Point Code Parameters .....	3-18
Table 3-7. Valid Value Combinations for 24-Bit ITU-N Point Code Parameters .....	3-18
Table 4-1. Example Gateway Screening Allowed CDPA Configuration Table .....	4-5

Table 4-2. Valid Value Combinations for ANSI Point Code Parameters .....	4-6
Table 4-3. Valid Value Combinations for ITU-I Point Code Parameters .....	4-6
Table 4-4. Valid Value Combinations for 24-Bit ITU-N Point Code Parameters .....	4-7
Table 4-5. CDPA Parameter Combinations .....	4-11
Table 4-6. Valid Value Combinations for ANSI Point Code Parameters .....	4-23
Table 4-7. Valid Value Combinations for ITU-I Point Code Parameters .....	4-23
Table 4-8. Valid Value Combinations for 24-Bit ITU-N Point Code Parameters .....	4-23
Table 4-9. CDPA Parameter Combinations .....	4-27
Table 5-1. Example Gateway Screening Allowed TT Configuration Table .....	5-4
Table 6-1. Valid Parameter Combinations for the Allowed CGPA Screening Function .....	6-2
Table 6-2. Example Gateway Screening Allowed CGPA Configuration Table .....	6-6
Table 6-3. Valid Value Combinations for ANSI Point Code Parameters .....	6-7
Table 6-4. Valid Value Combinations for ITU-I Point Code Parameters .....	6-8
Table 6-5. Valid Value Combinations for 24-Bit ITU-N Point Code Parameters .....	6-8
Table 6-6. Valid Value Combinations for ANSI Point Code Parameters .....	6-24
Table 6-7. Valid Value Combinations for ITU-I Point Code Parameters .....	6-24
Table 6-8. Valid Value Combinations for 24-Bit ITU-N Point Code Parameters .....	6-25
Table 6-9. CGPA Parameter Combinations .....	6-28
Table 7-1. Example Gateway Screening Allowed DESTFLD Configuration Table .....	7-7
Table 7-2. Valid Value Combinations for ANSI Point Code Parameters .....	7-8
Table 7-3. Valid Value Combinations for ITU-I Point Code Parameters .....	7-8
Table 7-4. Valid Value Combinations for 24-Bit ITU-N Point Code Parameters .....	7-8
Table 7-5. Valid Value Combinations for ANSI Point Code Parameters .....	7-22

## List of Tables

Table 7-6. Valid Value Combinations for ITU-I Point Code Parameters .....	7-22
Table 7-7. Valid Value Combinations for 24-Bit ITU-N Point Code Parameters .....	7-22
Table 8-1. Example Gateway Screening Blocked DPC Configuration Table .....	8-8
Table 8-2. Valid Value Combinations for ANSI Point Code Parameters .....	8-9
Table 8-3. Valid Value Combinations for ITU-I Point Code Parameters .....	8-10
Table 8-4. Valid Value Combinations for 24-Bit ITU-N Point Code Parameters .....	8-10
Table 8-5. Valid Value Combinations for ANSI Point Code Parameters .....	8-27
Table 8-6. Valid Value Combinations for ITU-I Point Code Parameters .....	8-28
Table 8-7. Valid Value Combinations for 24-Bit ITU-N Point Code Parameters .....	8-28
Table 9-1. Example Gateway Screening Allowed DPC Configuration Table .....	9-8
Table 9-2. Valid Value Combinations for ANSI Point Code Parameters .....	9-9
Table 9-3. Valid Value Combinations for ITU-I Point Code Parameters .....	9-10
Table 9-4. Valid Value Combinations for 24-Bit ITU-N Point Code Parameters .....	9-10
Table 9-5. Valid Value Combinations for ANSI Point Code Parameters .....	9-27
Table 9-6. Valid Value Combinations for ITU-I Point Code Parameters .....	9-28
Table 9-7. Valid Value Combinations for 24-Bit ITU-N Point Code Parameters .....	9-28
Table 10-1. Valid Parameter Combinations for the Allowed SIO Screening Function .....	10-3
Table 10-2. Example Gateway Screening Allowed SIO Configuration Table .....	10-9
Table 10-3. Valid Value Combinations for H0 and H1 Parameters .....	10-11
Table 10-4. Valid Value Combinations for H0 and H1 Parameters .....	10-25
Table 11-1. Example Gateway Screening Blocked OPC Configuration Table .....	11-8

Table 11-2. Valid Value Combinations for ANSI Point Code Parameters .....	11-10
Table 11-3. Valid Value Combinations for ITU-I Point Code Parameters .....	11-10
Table 11-4. Valid Value Combinations for 24-Bit ITU-N Point Code Parameters .....	11-11
Table 11-5. Valid Value Combinations for ANSI Point Code Parameters .....	11-27
Table 11-6. Valid Value Combinations for ITU-I Point Code Parameters .....	11-28
Table 11-7. Valid Value Combinations for 24-Bit ITU-N Point Code Parameters .....	11-28
Table 12-1. Example Gateway Screening Allowed OPC Configuration Table .....	12-8
Table 12-2. Valid Value Combinations for ANSI Point Code Parameters .....	12-9
Table 12-3. Valid Value Combinations for ITU-I Point Code Parameters .....	12-10
Table 12-4. Valid Value Combinations for 24-Bit ITU-N Point Code Parameters .....	12-10
Table 12-5. Valid Value Combinations for ANSI Point Code Parameters .....	12-26
Table 12-6. Valid Value Combinations for ITU-I Point Code Parameters .....	12-27
Table 12-7. Valid Value Combinations for 24-Bit ITU-N Point Code Parameters .....	12-27
Table 13-1. Example Gateway Screening Screen Set Configuration Table .....	13-3
Table 14-1. ISUP IAM Message Conversion Examples .....	14-3
Table 14-2. Example Gateway Screening Allowed DPC Configuration Table for the CNCF Feature .....	14-11
Table 14-3. Example Gateway Screening Allowed SIO Configuration Table for the CNCF Feature .....	14-12
Table 14-4. Example Gateway Screening Allowed OPC Configuration Table for the CNCF Feature .....	14-13
Table 14-5. Example Gateway Screening Screen Set Configuration Table for the CNCF Feature .....	14-14
Table 14-6. Linkset Configuration Table for the CNCF Feature .....	14-15
Table 15-1. Example Gateway Screening Allowed ISUP Configuration Table .....	15-9

# List of Flowcharts

Flowchart 2-1. Adding an GLS Card to the Database .....	2-49
Flowchart 2-2. Removing a GLS Card .....	2-53
Flowchart 2-3. Configuring Gateway Screening Stop Action Sets .....	2-61
Flowchart 2-4. Configuring TLNP Gateway Screening Stop Action Sets .....	2-73
Flowchart 2-5. Removing Gateway Screening Stop Action Sets .....	2-80
Flowchart 2-6. Setting the Threshold for Reporting Gateway Screening Activity .....	2-85
Flowchart 2-7. Setting the Maximum Number of Gateway Screening Rejected Messages .....	2-87
Flowchart 3-1. Allowed AFTPC Screening Action .....	3-2
Flowchart 3-2. Adding an Allowed Affected Point Code Screen .....	3-11
Flowchart 3-3. Removing an Allowed Affected Point Code Screen .....	3-16
Flowchart 3-4. Changing an Allowed Affected Point Code Screen .....	3-23
Flowchart 4-1. Allowed CDPA Screening Action .....	4-3
Flowchart 4-2. Adding an Allowed Called Party Address Screen .....	4-13
Flowchart 4-3. Removing an Allowed Called Party Address Screen .....	4-20
Flowchart 4-4. Changing an Allowed Called Party Address Screen .....	4-29
Flowchart 5-1. Allowed TT Screening Action .....	5-2
Flowchart 5-2. Adding an Allowed Translation Type Screen .....	5-8
Flowchart 5-3. Removing an Allowed Translation Type Screen .....	5-13
Flowchart 5-4. Changing an Allowed Translation Type Screen .....	5-18
Flowchart 6-1. Allowed CGPA Screening Action .....	6-3
Flowchart 6-2. Adding an Allowed Calling Party Address Screen .....	6-14

Flowchart 6-3. Removing an Allowed Calling Party Address  
 Screen ..... 6-21

Flowchart 6-4. Changing an Allowed Calling Party Address  
 Screen ..... 6-30

Flowchart 7-1. Allowed Affected Destination Screening  
 Action ..... 7-3

Flowchart 7-2. Adding an Allowed Affected Destination Field  
 Screen ..... 7-13

Flowchart 7-3. Removing an Allowed Affected Destination Field  
 Screen ..... 7-19

Flowchart 7-4. Changing an Allowed Affected Destination  
 Field Screen ..... 7-27

Flowchart 8-1. Blocked DPC Screening Action ..... 8-3

Flowchart 8-2. Adding a Blocked DPC Screen ..... 8-16

Flowchart 8-3. Removing a Blocked DPC Screen ..... 8-24

Flowchart 8-4. Changing a Blocked DPC Screen ..... 8-33

Flowchart 9-1. Allowed DPC Screening Action ..... 9-3

Flowchart 9-2. Adding an Allowed DPC Screen ..... 9-17

Flowchart 9-3. Removing an Allowed DPC Screen ..... 9-25

Flowchart 9-4. Changing an Allowed DPC Screen ..... 9-33

Flowchart 10-1. Allowed SIO Screening Action ..... 10-4

Flowchart 10-2. Adding an Allowed SIO Screen ..... 10-17

Flowchart 10-3. Adding an Allowed SIO Screen ..... 10-18

Flowchart 10-4. Removing an Allowed SIO Screen ..... 10-22

Flowchart 10-5. Changing an Allowed SIO Screen ..... 10-28

Flowchart 11-1. Blocked OPC Screening Action ..... 11-3

Flowchart 11-2. Adding a Blocked OPC Screen ..... 11-17

Flowchart 11-3. Removing a Blocked OPC Screen ..... 11-25

Flowchart 11-4. Changing a Blocked OPC Screen ..... 11-33

Flowchart 12-1. Allowed OPC Screening Action ..... 12-3

Flowchart 12-2. Adding an Allowed OPC Screen ..... 12-17

Flowchart 12-3. Removing an Allowed OPC Screen ..... 12-24

Flowchart 12-4. Changing an Allowed OPC Screen ..... 12-32

Flowchart 13-1. Adding a Screen Set ..... 13-9

Flowchart 13-2. Removing a Screen Set ..... 13-14

Flowchart 13-3. Changing a Screen Set ..... 13-19

Flowchart 14-1. Calling Name Conversion Facility  
 Configuration ..... 14-16

Flowchart 15-1. Allowed ISUP Message Type Screening  
 Action ..... 15-4

## List of Flowcharts

Flowchart 15-2. Adding an Allowed ISUP Message Type Screen .....	15-13
Flowchart 15-3. Removing an Allowed ISUP Message Type Screen .....	15-19
Flowchart 15-4. Changing an Allowed ISUP Message Type Screen .....	15-23





# 1

## Introduction

Overview .....	1-2
Manual Organization .....	1-2
Related Publications.....	1-4
Documentation Packaging, Delivery, and Updates.....	1-8
Documentation Admonishments .....	1-9
Customer Care Center .....	1-9
Emergency Response .....	1-10
Maintenance and Administration Subsystem .....	1-11
Database Partitions.....	1-12
Fixed Disk Drive.....	1-13
Removable Cartridge.....	1-14
List of Acronyms and Abbreviations.....	1-15

## Overview

The *Database Administration Manual – Gateway Screening* describes the procedures necessary for database administration personnel or translations personnel to configure the EAGLE 5 SAS and its database to implement the Gateway Screening Feature.

The Gateway Screening (GWS) feature examines a Message Signaling Unit (MSU) attempting to enter the EAGLE 5 SAS against predefined criteria in the EAGLE 5 SAS database to determine whether the MSU should be allowed to enter. The screening functions are defined by using screening tables or screen sets containing a set of rules. Each screen set is uniquely identified by a screen set name. Each rule in the screen set is identified by a screening reference name. Each screening reference belongs to a specific category, which indicates the criteria used to either accept or reject an incoming MSU. Gateway screening tables provide screening of MTP messages on Link Interface Modules (LIMs) and SCCP messages on Translation Services Modules (TSMs) or Database Services Module (DSMs).

**NOTE: Before enabling any the Gateway Screening feature, make sure you have purchased this feature to be turned on. If you are not sure whether you have purchased this feature to be turned on, contact your Tekelec Sales Representative or Account Representative.**

**NOTE: Database administration privileges are password restricted. Only those persons with access to the command class “Database Administration” can execute the administrative functions. Refer to the *Commands Manual* for more information on command classes and commands allowed by those classes.**

It is possible for two or more users to make changes to the same database element at any time during their database administration sessions. It is strongly recommended that only one user at a time make any changes to the database.

## Manual Organization

Throughout this document, the terms database and system software are used. Database refers to all data that can be administered by the user, including shelves, cards, links, routes, global title translation tables, and gateway screening tables. System software refers to data that cannot be administered by the user, including generic program loads (GPLs).

This document is organized into the following sections.

Chapter 1, “Introduction,” contains general information about the gateway screening feature, the database, and the organization of this manual.

## Introduction

Chapter 2, "Gateway Screening (GWS) Overview," contains an overview of the Gateway screening feature and the procedures for provisioning the GLS card, gateway screening stop action sets, the threshold for gateway screening activity, and the maximum number of gateway screening rejected messages.

Chapter 3, "Allowed Affected Point Code (AFTPC) Screen Configuration," contains the procedures necessary to configure allowed affected point code screens.

Chapter 4, "Allowed Called Party (CDPA) Screen Configuration," contains the procedures necessary to configure allowed called party address screens.

Chapter 5, "Allowed Translation Type (TT) Screen Configuration," contains the procedures necessary to configure allowed translation type screens.

Chapter 6, "Allowed Calling Party (CGPA) Screen Configuration," contains the procedures necessary to configure allowed calling party address screens.

Chapter 7, "Allowed Affected Destination Field (DESTFLD) Screen Configuration," contains the procedures necessary to configure allowed affected destination field screens.

Chapter 8, "Blocked Destination Point Code (BLKDPC) Screen Configuration," contains the procedures necessary to configure blocked destination point code screens.

Chapter 9, "Allowed Destination Point Code (DPC) Screen Configuration," contains the procedures necessary to configure allowed destination point code screens.

Chapter 10, "Allowed Signaling Information Octet (SIO) Screen Configuration," contains the procedures necessary to configure allowed signaling information octet screens.

Chapter 11, "Blocked Originating Point Code (BLKOPC) Screen Configuration," contains the procedures necessary to configure blocked originating point code screens.

Chapter 12, "Allowed Originating Point Code (OPC) Screen Configuration," contains the procedures necessary to configure allowed originating point code screens.

Chapter 13, "Screen Set Configuration," contains the procedures necessary to configure screen sets.

Chapter 14, "Calling Name Conversion Facility (CNCF) Configuration," contains a description of the Calling Name Conversion Facility feature the procedure necessary to configure this feature.

Chapter 15, "Allowed ISUP Message Type Screen Configuration," contains the procedures necessary to configure allowed ISUP message type screens.

## Related Publications

The *Database Administration Manual – Gateway Screening* is part of the EAGLE 5 SAS documentation set and may refer to one or more of the following manuals:

- The *Commands Manual* contains procedures for logging into or out of the EAGLE 5 SAS, a general description of the terminals, printers, the disk drive used on the system, and a description of all the commands used in the system.
- The *Commands Pocket Guide* is an abridged version of the *Commands Manual*. It contains all commands and parameters, and it shows the command-parameter syntax.
- The *Commands Quick Reference Guide* contains an alphabetical listing of the commands and parameters. The guide is sized to fit a shirt-pocket.
- The *Commands Error Recovery Manual* contains the procedures to resolve error message conditions generated by the commands in the *Commands Manual*. These error messages are presented in numerical order.
- The *Database Administration Manual – Features* contains procedural information required to configure the EAGLE 5 SAS to implement these features:
  - X.25 Gateway
  - STP LAN
  - Database Transport Access
  - GSM MAP Screening
  - EAGLE 5 SAS Support for Integrated Sentinel
- The *Database Administration Manual – Global Title Translation* contains procedural information required to configure an EAGLE 5 SAS to implement these features:
  - Global Title Translation
  - Enhanced Global Title Translation
  - Variable Length Global Title Translation
  - Interim Global Title Modification
  - Intermediate GTT Load Sharing
  - ANSI-ITU-China SCCP Conversion
- The *Database Administration Manual - IP7 Secure Gateway* contains procedural information required to configure the EAGLE 5 SAS to implement the SS7-IP Gateway.

## Introduction

- The *Database Administration Manual – SEAS* contains the EAGLE 5 SAS configuration procedures that can be performed from the Signaling Engineering and Administration Center (SEAC) or a Signaling Network Control Center (SNCC). Each procedure includes a brief description of the procedure, a flowchart showing the steps required, a list of any EAGLE 5 SAS commands that may be required for the procedure but that are not supported by SEAS, and a reference to optional procedure-related information, which can be found in one of these manuals:
  - *Database Administration Manual – Gateway Screening*
  - *Database Administration Manual – Global Title Translation*
  - *Database Administration Manual – SS7*
- The *Database Administration Manual – SS7* contains procedural information required to configure an EAGLE 5 SAS to implement the SS7 protocol.
- The *Database Administration Manual – System Management* contains procedural information required to manage the EAGLE 5 SAS database and GPLs, and to configure basic system requirements such as user names and passwords, system-wide security requirements, and terminal configurations.
- The *Dimensioning Guide for EPAP Advanced DB Features* is used to provide EPAP planning and dimensioning information. This manual is used by Tekelec personnel and EAGLE 5 SAS customers to aid in the sale, planning, implementation, deployment, and upgrade of EAGLE 5 SAS systems equipped with one of the EAGLE 5 SAS EPAP Advanced Database (EADB) Features.
- The *ELAP Administration Manual* defines the user interface to the EAGLE 5 SAS LNP Application Processor on the MPS/ELAP platform. The manual defines the methods for accessing the user interface, menus, screens available to the user and describes their impact. It provides the syntax and semantics of user input, and defines the output the user receives, including information and error messages, alarms, and status.
- The *EPAP Administration Manual* describes how to administer the EAGLE 5 SAS Provisioning Application Processor on the MPS/EPAP platform. The manual defines the methods for accessing the user interface, menus, and screens available to the user and describes their impact. It provides the syntax and semantics of user input and defines the output the user receives, including messages, alarms, and status.
- The *Feature Manual - EIR* provides instructions and information on how to install, use, and maintain the EIR feature on the Multi-Purpose Server (MPS) platform of the EAGLE 5 SAS. The feature provides network operators with the capability to prevent stolen or disallowed GSM mobile handsets from accessing the network.

- The *Feature Manual - G-Flex C7 Relay* provides an overview of a feature supporting the efficient management of Home Location Registers in various networks. This manual gives the instructions and information on how to install, use, and maintain the G-Flex feature on the Multi-Purpose Server (MPS) platform of the EAGLE 5 SAS.
- The *Feature Manual - G-Port* provides an overview of a feature providing the capability for mobile subscribers to change the GSM subscription network within a portability cluster while retaining their original MSISDNs. This manual gives the instructions and information on how to install, use, and maintain the G-Port feature on the Multi-Purpose Server (MPS) platform of the EAGLE 5 SAS.
- The *Feature Manual - INP* provides the user with information and instructions on how to implement, utilize, and maintain the INAP-based Number Portability (INP) feature on the Multi-Purpose Server (MPS) platform of the EAGLE 5 SAS.
- The *FTP-Based Table Retrieve Application (FTRA) User Guide* describes how to set up and use a PC to serve as the offline application for the EAGLE 5 SAS FTP Retrieve and Replace feature.
- The *Hardware Manual - EAGLE 5 SAS* contains hardware descriptions and specifications of Tekelec's signaling products. These include the EAGLE 5 SAS, OEM-based products such as the ASi 4000 Service Control Point (SCP), the Netra-based Multi-Purpose Server (MPS), and the Integrated Sentinel with Extended Services Platform (ESP) subassembly.
- The *Hardware Manual* provides an overview of each system and its subsystems, details of standard and optional hardware components in each system, and basic site engineering. Refer to this manual to obtain a basic understanding of each type of system and its related hardware, to locate detailed information about hardware components used in a particular release, and to help configure a site for use with the system hardware.
- The *Hardware Manual - Tekelec 1000 Application Server* provides general specifications and a description of the Tekelec 1000 Applications Server (T1000 AS). This manual also includes site preparation, environmental and other requirements, procedures to physically install the T1000 AS, and troubleshooting and repair of Field Replaceable Units (FRUs).
- The *Hardware Manual - Tekelec 1100 Application Server* provides general specifications and a description of the Tekelec 1100 Applications Server (T1100 AS). This manual also includes site preparation, environmental and other requirements, procedures to physically install the T1100 AS, and troubleshooting and repair of Field Replaceable Units (FRUs).
- The *Installation Manual - EAGLE 5 SAS* contains cabling requirements, schematics, and procedures for installing the EAGLE 5 SAS along with LEDs, Connectors, Cables, and Power Cords to Peripherals. Refer to this manual to install components or the complete systems.

## Introduction

- The *Installation Manual - Integrated Applications* provides the installation information for integrated applications such as EPAP 4.0 or earlier (Netra-based Multi-Purpose Server (MPS) platform) and Sentinel. The manual includes information about frame floors and shelves, LEDs, connectors, cables, and power cords to peripherals. Refer to this manual to install components or the complete systems.
- The *LNP Database Synchronization Manual - LSMS with EAGLE 5 SAS* describes how to keep the LNP databases at the LSMS and at the network element (the EAGLE 5 SAS is a network element) synchronized through the use of resynchronization, audits and reconciles, and bulk loads. This manual is contained in both the LSMS documentation set and in the EAGLE 5 SAS documentation set.
- The *LNP Feature Activation Guide* contains procedural information required to configure the EAGLE 5 SAS for the LNP feature and to implement these parts of the LNP feature on the EAGLE 5 SAS:
  - LNP services
  - LNP options
  - LNP subsystem application
  - Automatic call gapping
  - Triggerless LNP feature
  - Increasing the LRN and NPANXX Quantities on the EAGLE 5 SAS
  - Activating and Deactivating the LNP Short Message Service (SMS) feature
- The *Maintenance Manual* contains procedural information required for maintaining the EAGLE 5 SAS and the card removal and replacement procedures. The *Maintenance Manual* provides preventive and corrective maintenance procedures used in maintaining the different systems.
- The *Maintenance Pocket Guide* is an abridged version of the Maintenance Manual and contains all the corrective maintenance procedures used in maintaining the EAGLE 5 SAS.
- The *Maintenance Emergency Recovery Pocket Guide* is an abridged version of the Maintenance Manual and contains the corrective maintenance procedures for critical and major alarms generated on the EAGLE 5 SAS.
- The *MPS Platform Software and Maintenance Manual - EAGLE 5 SAS with Tekelec 1000 Application Server* describes the platform software for the Multi-Purpose Server (MPS) based on the Tekelec 1000 Application Server (T1000 AS) and describes how to perform preventive and corrective maintenance for the T1000 AS-based MPS. This manual should be used with the EPAP-based applications (EIR, G-Port, G-Flex, and INP).

- The *MPS Platform Software and Maintenance Manual - EAGLE 5 SAS with Tekelec 1100 Application Server* describes the platform software for the Multi-Purpose Server (MPS) based on the Tekelec 1100 Application Server (T1100 AS) and describes how to perform preventive and corrective maintenance for the T1100 AS-based MPS. This manual should be used with the ELAP-based application (LNP).
- The *Provisioning Database Interface Manual* defines the programming interface that populates the Provisioning Database (PDB) for the EAGLE 5 SAS features supported on the MPS/EPAP platform. The manual defines the provisioning messages, usage rules, and informational and error messages of the interface. The customer uses the PDBI interface information to write his own client application to communicate with the MPS/EPAP platform.
- The *Previously Released Features Manual* summarizes the features of previous EAGLE, EAGLE 5 SAS, and IP<sup>7</sup> Secure Gateway releases, and it identifies the release number of their introduction.
- The *Release Documentation* contains the following documents for a specific release of the system:
  - *Feature Notice* - Describes the features contained in the specified release. The Feature Notice also provides the hardware baseline for the specified release, describes the customer documentation set, provides information about customer training, and explains how to access the Customer Support Website.
  - *Release Notice* - Describes the changes made to the system during the lifecycle of a release. The Release Notice includes Generic Program Loads (GPLs), a list of PRs resolved in a build, and all known PRs.  
**NOTE: The Release Notice is maintained solely on Tekelec's Customer Support site to provide you with instant access to the most up-to-date release information.**
  - *System Overview* - Provides high-level information on SS7, the IP7 Secure Gateway, system architecture, LNP, and EOAP.
  - *Master Glossary* - Contains an alphabetical listing of terms, acronyms, and abbreviations relevant to the system.
  - *Master Index* - Lists all index entries used throughout the documentation set.
- The *System Manual – EOAP* describes the Embedded Operations Support System Application Processor (EOAP) and provides the user with procedures on how to implement the EOAP, replace EOAP-related hardware, device testing, and basic troubleshooting information.



## Documentation Packaging, Delivery, and Updates

Customer documentation is provided with each EAGLE 5 SAS in accordance with the contract agreements.

Customer documentation is updated whenever significant changes that affect system operation or configuration are made.

Customer documentation updates may be issued in the form of an addendum, or a reissue of the affected documentation.

The document part number is shown on the title page along with the current revision of the document, the date of publication, and the software release that the document covers. The bottom of each page contains the document part number and the date of publication.

Two types of releases are major software releases and maintenance releases. Maintenance releases are issued as addenda with a title page and change bars. On the changed pages, the date and document part number are changed. On any unchanged pages that accompany the changed pages, the date and document part number are unchanged.



In the event a software release has minimum affect on documentation, an addendum is provided. The addendum provides an instruction page, a new title page, a change history page, and replacement chapters bearing the date of publication, the document part number, and change bars.

If a new release has a major impact on documentation, such as a new feature, the entire documentation set is reissued with a new part number and a new release number.

## Documentation Admonishments

Admonishments are icons and text that may appear in this and other Tekelec manuals that alert the reader to assure personal safety, to minimize possible service interruptions, and to warn of the potential for equipment damage.

Following are the admonishments, listed in descending order of priority.

	<b>DANGER:</b> (This icon and text indicate the possibility of <i>personal injury</i> .)
	<b>CAUTION:</b> (This icon and text indicate the possibility of <i>service interruption</i> .)
	<b>WARNING:</b> (This icon and text indicate the possibility of <i>equipment damage</i> .)

## Customer Care Center

The Customer Care Center offers a point of contact through which customers can receive support for problems that may be encountered during the use of Tekelec's products. The Customer Care Center is staffed with highly trained engineers to provide solutions to your technical questions and issues seven days a week, twenty-four hours a day. A variety of service programs are available through the Customer Care Center to maximize the performance of Tekelec products that meet and exceed customer needs.

To receive technical assistance, call the Customer Care Center at one of the following locations:

- Tekelec, UK

Phone: +44 1784 467 804

Fax: +44 1784 477 120

Email: [ecsc@tekelec.com](mailto:ecsc@tekelec.com)

- Tekelec, USA

Phone (within the continental US) 888-367-8552 (888-FOR-TKLC)  
(outside the continental US) +1 919-460-2150.

Email: [support@tekelec.com](mailto:support@tekelec.com).

When your call is received, the Customer Care Center issues a Customer Service Report (CSR). Each CSR includes an individual tracking number. When a CSR is issued, the Customer Care Center determines the classification of the trouble. The CSR contains the serial number of the system, problem symptoms, and messages. The Customer Care Center assigns the CSR to a primary engineer, who will work to solve the problem. The Customer Care Center closes the CSR when the problem is resolved.

If a critical problem exists, the Customer Care Center initiates emergency procedures (see the following topic, "Emergency Response").

## Emergency Response

If a critical service situation occurs, the Customer Care Center offers emergency response twenty-four hours a day, seven days a week. The emergency response provides immediate coverage, automatic escalation, and other features to ensure a rapid resolution to the problem.

A critical situation is defined as an EAGLE 5 SAS or LSMS problem that severely affects service, traffic, or maintenance capabilities, and requires immediate corrective action. Critical problems affect service or system operation, resulting in:

- Failure in the system that prevents transaction processing

## Introduction

- Reduction in EAGLE 5 SAS capacity or in EAGLE 5 SAS traffic-handling capability
- Inability to restart the EAGLE 5 SAS
- Corruption of the database
- Inability to perform maintenance or recovery operations
- Inability to provide any required critical or major trouble notification
- Any other problem severely affecting service, capacity, traffic, and billing. Maintenance capabilities may be defined as critical by prior discussion and agreement with the Customer Care Center.

## Maintenance and Administration Subsystem

The maintenance and administration subsystem consists of two processors, MASP (maintenance and administration subsystem processor) A and MASP B.

Each MASP is made up of two cards, the MCAP card (MAS communication application processor) and the TDM (terminal disk module).

The MCAP card contains the communications processor and applications processor and provides connections to the IMT bus. The MCAP controls the maintenance and database administration activity.

The TDM contains the fixed disk drive, the terminal processor for the 16 serial I/O ports and interfaces to the MDAL (maintenance disk and alarm) card which contains the removable cartridge drive and alarm logic. There is only one MDAL card in the maintenance and administration subsystem and it is shared between the two MASPs.

The procedures in the *Database Administration Manual – Gateway Screening* refer to the terms MASP and MDAL. The database commands, such as `rept-stat-db`, refer to the MASP because the MASP controls the input to the TDM and MDAL, and output from the TDM and MDAL. The MDAL is only referred to when inserting or removing the removable cartridge because the removable cartridge drive resides on the MDAL.

For more information on these cards, go to the *Hardware Manual - EAGLE 5 SAS*.

## Database Partitions

The data that the EAGLE 5 SAS uses to perform its functions are stored in two separate areas: the fixed disk drives, and the removable cartridge. The following sections describe these areas and data that is stored on them. These areas and their partitions are shown in Figure 1-1.

Figure 1-1. Database Partitions

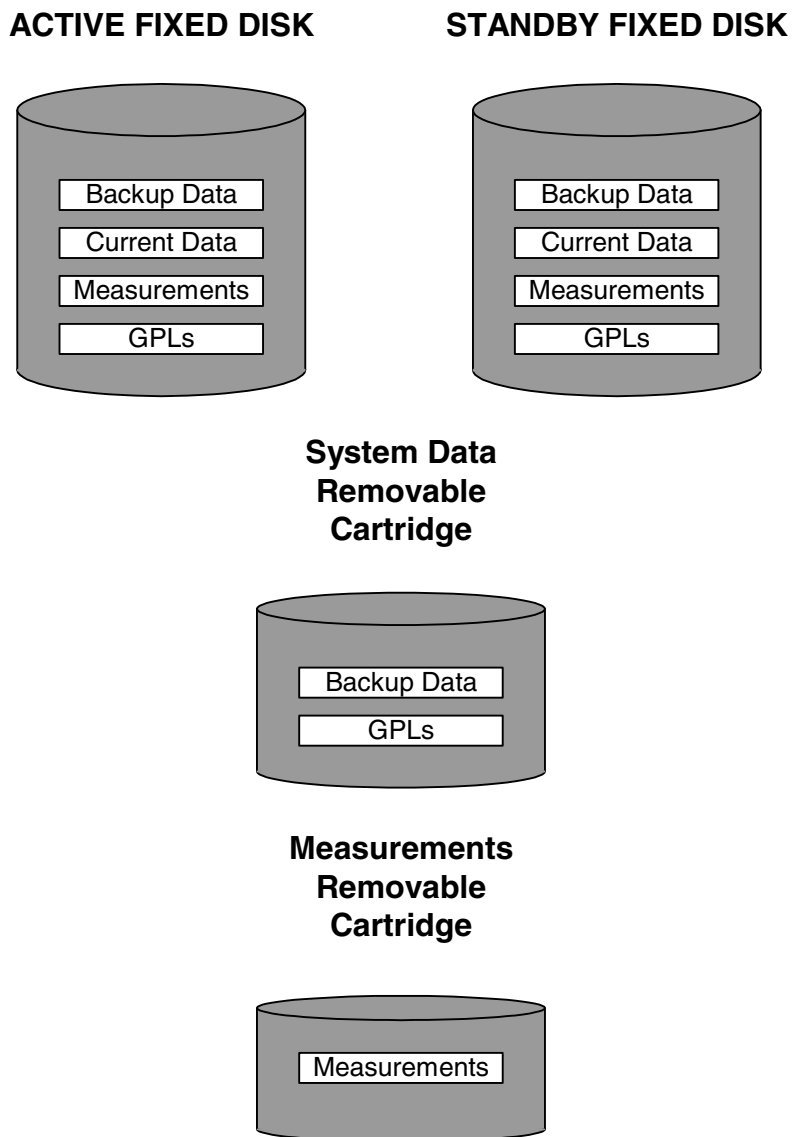

## Introduction

### Fixed Disk Drive

There are two fixed disk drives on the EAGLE 5 SAS. The fixed disk drives contain the “master” set of data and programs for the EAGLE 5 SAS. The two fixed disk drives are located on the terminal disk modules (TDMs). Both disks have the same files. The data stored on the fixed disks is partially replicated on the various cards in the EAGLE 5 SAS. Changes made during database administration sessions are sent to the appropriate cards.

The data on the fixed disks can be viewed as four partitions.

- Current partition
- Backup partition
- Measurements partition
- Generic program loads (GPLs) partition

The data which can be administered by users is stored in two partitions on the fixed disk, a current database partition which has the tables which are changed by on-line administration, and a backup database partition which is a user-controlled copy of the current partition.

All of the on-line data administration commands effect the data in the current partition. The purpose of the backup partition is to provide the users with a means of rapidly restoring the database to a known good state if there has been a problem while changing the current partition.

A full set of GPLs is stored on the fixed disk, in the GPL partition. There is an approved GPL and a trial GPL for each type of GPL in this set and a utility GPL, which has only an approved version. Copies of these GPLs are downloaded to the EAGLE 5 SAS cards. The GPL provides each card with its functionality. For example, the **ss7ansi** GPL provides MTP functionality for link interface modules (LIMs).

Measurement tables are organized as a single partition on the fixed disk. These tables are used as holding areas for the measurement counts.

## Removable Cartridge

A removable cartridge is used for two purposes.

- To hold an off-line back-up copy of the administered data and system GPLs
- To hold a copy of the measurement tables

Because of the size of the data stored on the fixed disk drives on the TDMs, a single removable cartridge cannot store all of the data in the database, GPL and measurements partitions.

To use a removable cartridge to hold the system data, it must be formatted for system data. To use a removable cartridge to hold measurements data, it must be formatted for measurements data. The EAGLE 5 SAS provides the user the ability to format a removable cartridge for either of these purposes. A removable cartridge can be formatted on the EAGLE 5 SAS by using the **format-disk** command. More information on the **format-disk** command can be found in the *Commands Manual*. More information on the removable cartridge drive can be found in the *Hardware Manual - EAGLE 5 SAS*.

The removable cartridge drive is located on the MDAL card in card location 1117.

Additional and preformatted removable cartridges are available from the Customer Care Center.

## List of Acronyms and Abbreviations

ACM .....	Application Communications Module
ACMENET.....	The card type assigned to an ACM with the <b>ent-card</b> command.
ACT.....	The action taken, either copy the MSU for the STP LAN feature or redirect the MSU for the gateway screening redirect function, if the NSFI is STOP.
AFTPC .....	Affected Point Code
ANSI .....	American National Standards Institute
APC.....	Adjacent Point Code
APCA.....	The ANSI adjacent point code
APCI .....	The ITU international adjacent point code
APCN .....	The ITU national adjacent point code
APPL.....	The application software assigned to the card.
AREA.....	The area value of an ITU international point code, expressed as zone-area-id.
AST .....	Associated State for Maintenance
BEI.....	Broadcast Exception Indicator
BLKDPC .....	Blocked Destination Point Code
BLKOPC .....	Blocked Originating Point Code
C .....	Continue – A point code value used in the blocked OPC or DPC screens that allows the gateway screening process to continue for messages containing point codes that do not match any point codes in the blocked OPC or DPC screens.
CANC .....	Cancel
CDPA .....	Called Party Address
CGPA .....	Calling Party Address
CHG.....	Change
Cmd Rej.....	Command Rejected
CNCF.....	Calling Name Conversion Facility
CNIP .....	Calling Name Identification Presentation
DCM .....	Database Communications Module
DESTFLD .....	Allowed Affected Destination Field

DLT.....	Delete
DPC.....	Destination Point Code
DS0.....	Digital Signal Zero (56 or 64 Kbs/second)
DS0A.....	Digital Signal Level - 0
DSM.....	Database Services Module
DTA.....	Database Transport Access
EOAM.....	Enhanced Operations, Administration, and Maintenance
ENT.....	Enter
GLS.....	Gateway Loading Services — The application software for the gateway screening loading services
GN.....	Generic Name parameter of an ISUP Initial Address Message (IAM)
GPL.....	Generic Program Load
GPSM.....	General Purpose Service Module
GT.....	Global Title Routing Indicator
GTT.....	Global Title Translation
GWS.....	Gateway Screening
GWSA.....	Gateway Screening Application
GWSD.....	Gateway Screening Message Discard
GWSM.....	Gateway Screening Mode
H0.....	The H0 heading code in the service information octet.
H1.....	The H1 heading code in the service information octet.
I/O.....	Input/Output
IAM.....	Initial Address Message
ID.....	The ID value of an ITU international point code, expressed as zone-area-id.
IMT.....	Interprocessor Message Transport
IP.....	Internet Protocol
IS-NR.....	In Service - Normal
ISUP.....	ISDN User Part
ISUPMT.....	ISDN User Part Message Type
ITU.....	International Telecommunications Union



## Introduction

ITU-I .....	ITU International
ITU-N.....	ITU National
LAN .....	Local Area Network
LIM .....	Link Interface Module
LIMDS0 .....	A LIM with a DS0A interface
LIMV35.....	A LIM with a V.35 interface
LINK .....	The signaling link assigned to the LIM.
LNKS .....	The number of signaling links in the linkset
LNP.....	Local Number Portability
LOC.....	Card Location
LS.....	Link Set
LSN .....	Link Set Name
LST .....	The linkset type of the specified linkset
MAP .....	Mobile Application Part
MAS .....	Maintenance and Administration Subsystem
MASP.....	Maintenance and Administration Subsystem Processor
MDAL.....	Maintenance Disk and Alarm Card
MPS.....	Multi-purpose Server
MSA .....	The main signaling area value of a 24-bit ITU national point code, expressed as msa-ssa-sp.
MSU .....	Message Signaling Unit
MTP .....	Message Transfer Part
NAREA .....	The new area value of an ITU international point code, expressed as zone-area-id.
NC.....	The network cluster of an ANSI point code, expressed as ni-nc-ncm.
NCM .....	The network cluster member of an ANSI point code, expressed as ni-nc-ncm.
NH0 .....	The new H0 heading code value in the service information octet.
NH1 .....	The new H1 heading code value in the service information octet.
NI .....	The network identifier of an ANSI point code, expressed as ni-nc-ncm.

NIC.....	The network indicator code in the service information octet.
NID .....	The new ID value of an ITU international point code, expressed as zone-area-id.
NMSA.....	The new main signaling area value of a 24-bit ITU national point code, expressed as msa-ssa-sp.
NNC.....	The new network cluster value of an ANSI point code, expressed as ni-nc-ncm.
NNCM.....	The new network cluster member value of an ANSI point code, expressed as ni-nc-ncm.
NNI .....	The new network identifier value of an ANSI point code, expressed as ni-nc-ncm.
NNIC .....	The new network indicator code value in the service information octet.
NNPC .....	The new 14-bit ITU national point code value.
NPC.....	The 14-bit ITU national point code.
NPCST .....	New Point Code Sub-Type
NSCRN.....	The new screen set name
NSFI .....	Next Screening Function Identifier
NSI .....	The new service indicator value in the service information octet.
NSP .....	The new signaling point value of a 24-bit ITU national point code, expressed as msa-ssa-sp.
NSR.....	Next Screening Reference
NSSA.....	The new sub-signaling area value of a 24-bit ITU national point code, expressed as msa-ssa-sp.
NSSN .....	The new subsystem number value
NTYPE.....	The new translation type value
NZONE .....	The new zone value of an ITU international point code, expressed as zone-area-id.
OCU .....	Office Channel Unit
OPC.....	Originating Point Code
PC .....	Point Code
PCST .....	Point Code Sub-Type
PIP .....	Party Information Parameter parameter of an ISUP Initial Address Message (IAM)

## Introduction

PRI.....	The priority of a single message or the beginning message priority in a range of priorities in the service information octet.
PST .....	Primary State for Maintenance
REF.....	An indicator of whether the specified screening table is referenced by another screening table.
REPT-STAT.....	Report Status
RI.....	The routing indicator in the called party address (CDPA) and the calling party address (CGPA).
RTRV .....	Retrieve
SCCP .....	Signaling Connection Control Part – The application software for the global title translation (GTT) feature
SCCPMT.....	The SCCP message type
SCMGFID.....	The SCCP management (SCMG) format ID, which defines the function and format of each SCMG message
SCP.....	Service Control Point
SCRN .....	Screen Set Name
SCRSET .....	Screen Set
SEAC.....	Signaling Engineering and Administration Center
SEAS .....	Signaling Engineering and Administration System
SI.....	The service indicator for the service information octet, which are the last two bits of the subservice field.
SIO .....	Service Information Octet
SLC.....	Signaling Link Code
SLS .....	Signaling Link Selector
SLSCI .....	5- to 8-bit SLS Conversion Indicator
SNCC .....	Signaling Network Control Center
SP.....	The signaling point value of a 24-bit ITU national point code, expressed as msa-ssa-sp.
SPC.....	Secondary Point Code
SR .....	The name of the screening reference.
SS7.....	Signaling System #7
SS7ANSI.....	The application software for the ANSI SS7 signaling links

SS7GX25 .....	The application software for the X.25/SS7 gateway feature
SSA .....	The sub-signaling area value of a 24-bit ITU national point code, expressed as msa-ssa-sp.
SSA .....	Subsystem Allowed network management message
SSN .....	SS7 Subsystem Number
SSP .....	Subsystem Prohibited network management message
SST .....	Secondary State for Maintenance
SST .....	Subsystem Status Test network management message
STP LAN .....	A feature that copies MSUs selected through the gateway screening process and sends these MSUs over the ethernet to an external host computer for further processing
STP .....	Signal Transfer Point
STPLAN .....	The application software used with the ACM for the STP LAN feature
TCAP .....	Transaction Capability Application Part
TDM .....	Terminal Disk Module
TFA .....	Transfer Allowed network management message
TFP .....	Transfer Prohibited network management message
TLNP .....	Triggerless LNP
TSM .....	Translation Services Module
TT .....	Translation Type
TUP .....	Telephone User Part
TYPE .....	The global title translation type
UDTS .....	Unitdata Service
VXWSLAN .....	The application software used with the DCM for the STP LAN feature
ZONE .....	The zone value of an ITU international point code, expressed as zone-area-id.

# 2

## Gateway Screening (GWS) Overview

Introduction.....	2-2
Gateway Screening States.....	2-5
Gateway Screening Attributes.....	2-7
Use of the Character “c” for the NI, NC, NCM, ZONE, AREA, ID, NPC, MSA, SSA, and SP Parameters.....	2-11
Specifying a Range of Values for Gateway Screening Parameters.....	2-12
Use of the Asterisk “*” for the ZONE, AREA, ID, MSA, SSA, and SP Parameters.....	2-15
User Interface Requirements.....	2-16
14-Bit ITU National Point Code Formats.....	2-24
Gateway Screening Using Duplicate ITU National Point Codes.....	2-27
Gateway Screening Configuration.....	2-28
Gateway Screening Configuration Examples.....	2-32
Adding an GLS Card.....	2-46
Removing a GLS Card.....	2-50
Configuring Gateway Screening Stop Action Sets.....	2-54
Configuring TLNP Gateway Screening Stop Action Sets.....	2-65
Setting the Threshold for Reporting Gateway Screening Activity.....	2-81
Setting the Maximum Number of Gateway Screening Rejected Messages.....	2-86

## Introduction

This chapter provides an overview of the gateway screening feature and procedures for provisioning these items in the database:

- GLS cards
- Gateway screening stop action sets
- The threshold for gateway screening activity
- Setting the maximum number of gateway screening rejected messages

The gateway screening tables are loaded onto Link Interface Modules (LIMs) or SCCP cards. SCCP cards can be any of these cards:

- Translation Services Modules (TSMs)
- Database Services Modules (DSMs).

The use of the TSMs or DSMs in the EAGLE 5 SAS is dependent on the combination of global title translation features that are being used in the EAGLE 5 SAS. For more information on the global title translation features, go to the *Database Administration Manual - Global Title Translation*.

The gateway screening tables provide screening of MTP (LIMs) and SCCP (TSMs or DSMs) messages.

MTP Screening consists of the following items:

- Allowed Originating Point Code (OPC)
- Blocked Originating Point Code (BLKOPC)
- Allowed Signaling Information Octet (SIO)
- Allowed Destination Point Code (DPC)
- Blocked Destination Point Code (BLKDPC)
- Allowed Affected Destination Field (DESTFLD)
- Allowed ISUP Message Type (ISUP) - ISUP and TUP messages can be screened by the allowed ISUP message type screen.

SCCP Screening consists of the following items:

- Allowed Calling Party Address (CGPA)
- Allowed Translation Type (TT)
- Allowed Called Party Address (CDPA)
- Allowed Affected Point Code (AFTPC).

## Gateway Screening (GWS) Overview

The procedures shown in this manual use a variety of commands. If more information than what is shown in these procedures is needed, go to the *Commands Manual* to find the required information.

The EAGLE 5 SAS's role in the SS7 network is to provide SS7 message transport between originating and destination signaling points. EAGLE 5 SASs that route messages to and from other networks also perform gateway screening. The screening process results in a message being accepted into the network or rejected. The criteria for message screening depends on the type of message received by the EAGLE 5 SAS, and the contents of the EAGLE 5 SAS screening tables.

Gateway screening functions on the EAGLE 5 SAS reside within the LIM and the SCCP cards and are defined using screening tables or screen sets which contain a set of rules. Each screen set is uniquely identified by a screen set name. Each rule in the screen set is identified by a screening reference name. Each screening reference belongs to a specific category, which indicates the criteria that is used to either accept or reject an incoming MSU. For example, the category **blkopc** rejects all MSUs with the OPCs specified in the screening reference. The screening parameters (point codes, routing indicator, subsystem number, etc.) are used to match information in the SS7 message. The screening data is defined by the attributes discussed in the "Gateway Screening Attributes" section on page 2-7.

Each group of screening references is referred to as a screen set and is identified by a particular screen set name (**scrn**). The screen set is applied to a particular linkset. This allows the capability, for example, for specific OPCs with particular SIOs and DPCs to be allowed into the network.

With the SEAS interface, the screen set function is performed by a gateway linkset. A gateway linkset combines the functions of a gateway screening screen set and an SS7 linkset specifying the **gwsa=on** and **scrn** parameters. Like an EAGLE 5 SAS gateway screening screen set, a gateway linkset defines the screening references that are to be used to screen the messages on the linkset. It also defines the linkset whose messages are to be screened. A gateway linkset can only be configured from a SEAS terminal and not from an EAGLE 5 SAS terminal. The linkset attributes of a gateway linkset can be displayed on an EAGLE 5 SAS terminal with the **rtrv-ls** command. A gateway linkset is shown by the entry **SEAS** in the **SCRN** field of the **rtrv-ls** command output. The gateway screening portion of the gateway linkset can only be displayed on the SEAS interface.

There are two basic functions, allow and block. In an allowed screen (for example, allowed DPC), if a match is found and the next screening function identifier (**nsfi**) is equal to anything but **stop**, the next screening reference (**nsr**) is identified and the screening process continues to the next screen identified by the **nsfi** and **nsr** parameters. If the next screening function identifier is **stop**, the message is processed and no further screening takes place. If no match is found, the message is rejected.

In a blocked screen (for example, blocked DPC), if a match is found and the next screening function identifier is **fail**, the message is rejected and no further screening takes place. If no match is found and the next screening function identifier is equal to anything but **stop**, the next screening reference is identified and the screening process continues to the next screen identified by the **nsfi** and **nsr** parameters. If the next screening function identifier is equal to **stop**, the message is processed and no further screening takes place.

When the screening process stops, other actions can be assigned to the screen set. These actions, called gateway screening stop actions, define the actions the EAGLE 5 SAS can perform on the MSU that passes gateway screening. For more information on configuring gateway screening stop actions, go to the “Configuring Gateway Screening Stop Action Sets” section on page 2-54. The EAGLE 5 SAS currently uses these gateways screening stop actions.

- **COPY** – copy the MSU for the STP LAN feature
- **RDCT** – redirect the MSU for the DTA feature
- **CNCF** – convert the PIP parameter with the GN parameter or the GN parameter with the PIP parameter in the ISUP IAM message for the Calling Name Conversion Facility feature.
- **TLNP** – ISUP IAMs that pass gateway screening are processed either by the ISUP NP with EPAP feature (if the ISUP NP with EPAP feature is enabled and turned on) or by the Triggerless LNP feature (if the Triggerless LNP feature is turned on).

The allowed OPC and DPC screens are useful in the gateway screening process when specifying particular sets of point codes that are allowed to send messages to another network or receive messages from another network. The blocked OPC and DPC screens are useful in the gateway screening process specifying particular sets of point codes that are not allowed to send SS7 messages to another network or receive SS7 messages from another network.

### TUP Message Screening

TUP messages are screened using the Allowed ISUP Message Type screen. The TUP protocol is an obsolete predecessor to the ISUP protocol that remains in use in some areas. To screen for TUP messages, a screen set must be defined to screen for messages containing the service indicator value of 4. This is accomplished by defining an allowed SIO screen in the screen set containing the **si=4** parameter.

Since both ISUP and TUP messages are screened using the allowed ISUP message type screen, it is recommended that the screen set contain an allowed SIO screen to screen for ISUP messages, messages containing the service indicator value of 5. Each of these entries in the allowed SIO screen should have separate next screening functions. This allows the screening rules after the allowed SIO screen to have two separate streams, one that ends with screening ISUP messages, the other that ends with screening TUP messages.



## Gateway Screening (GWS) Overview

The TUP messages can be screened for point codes before, with the allowed and blocked OPC screens, and after the SIO screen, with the allowed and blocked DPC screens. However, if the screen set does not contain an allowed SIO screen that screens for TUP messages (messages with the service indicator value of 4), the message will be treated by the allowed ISUP message type screen as an ISUP message.

The following commands show how a screen set can be provisioned to screen for TUP and ISUP messages.

```
ent-scr-isup:sr=is01:isupmt=10:nsfi=stop
ent-scr-isup:sr=tu01:tupmt=1:nsfi=stop
ent-scr-dpc:sr=dpc4:ni=1:nc=2:ncm=3:nsfi=isup:nsr=tu01
ent-scr-dpc:sr=dpc5:ni=7:nc=1:ncm=0:nsfi=isup:nsr=is01
ent-scr-sio:sr=si02:nic=2:pri=0:si=4:nsfi=dpc:nsr=dpc4
ent-scr-sio:sr=si02:nic=2:pri=0:si=5:nsfi=dpc:nsr=dpc5
ent-scrset:scrn=ist2:nsr=si02:nsfi=sio
```

In this example screen set configuration, messages are screened by the allowed SIO screen `si02` for either ISUP or TUP messages. ISUP messages are further screened by the allowed DPC screen `dpc5` and TUP messages are screened by the allowed DPC screen `dpc4`. The ISUP messages containing the ANSI point code 001-002-003 are passed onto the allowed ISUP screen `is01`. The TUP messages containing the ANSI point code 007-001-000 are passed onto the allowed ISUP screen `tu01`.

**NOTE:** The gateway screening rules are entered in reverse of the order that the screening process takes place.

## Gateway Screening States

Gateway screening on a particular linkset can be set to function in one of four states:

**NO SCREENING** – Screening is not performed. All message signaling units (MSUs) are passed. This state is set by the `gwsa=off` and `gwsn=off` parameters of the `ent-1s` or `chg-1s` commands.

**SCREEN AND REPORT** – Screening is performed. When an MSU fails screening it is discarded, an output message is generated, and measurements are pegged. This state is set by the `gwsa=on` and `gwsn=on` parameters of the `ent-1s` or `chg-1s` commands.

**SCREEN AND DON'T REPORT** – Screening is performed. When an MSU fails screening it is discarded and measurements are pegged, but no output message is generated. This state is set by the `gwsa=on` and `gwsn=off` parameters of the `ent-1s` or `chg-1s` commands.

**SCREEN TEST MODE** – Screening is performed, but all MSUs are passed. When an MSU fails screening, an output message is generated, but the MSU is still passed. This state is set by the `gwsa=off` and `gws=on` parameters of the `ent-1s` or `chg-1s` commands.



**CAUTION:** When Gateway Screening is in the screen test mode, any action in the gateway screening stop action set specified by the `actname` parameter at the end of the gateway screening process will be performed.

The `gwsa` and `gws` parameters are described in the “Linkset Parameters” section.

### Linkset Parameters

Optional parameters of the enter linkset (`ent-1s`) command or the change linkset (`chg-1s`) command are used to set the screening state. These parameters are:

**SCRN** – the name of the gateway screening screen set that is associated with the linkset.

**GWSA** – Gateway screening action – The value `on` allows gateway screening to be performed on the linkset. The value `off`, does not allow gateway screening to be performed on the linkset. This parameter can only be specified if the `scrn` parameter is specified.

**GWSM** – Gateway screening messaging – The value `on` allows output messages to be generated. The value `off` does not allow output messages to be generated. This parameter can only be specified if the `scrn` parameter is specified.

**GWSD** – Gateway screening MSU discard – If gateway screening cannot be performed and the `gwsd` parameter is set to `on`, all MSUs on the linkset are discarded. These are two examples of why gateway screening could not be performed.

- No GLS cards are configured and installed in the EAGLE 5 SAS.
- The screen set is too big to be loaded onto the LIM, TSM (if the LNP feature is enabled), or the SCCP card (if the LNP feature is not enabled).

The value `off` does not allow messages to be discarded. This parameter can only be specified if the `scrn` and `gwsa=on` parameters are specified.

**NOTE:** Discarding all MSUs on a linkset will not allow any MSUs on the linkset to be routed. It is recommended that the value specified for the `gwsd` parameter is `off`. The `gwsd` parameter should only be set to `on` if you wish screen MSUs for gateway screening rather than routing MSUs through the EAGLE 5 SAS.

Refer to the *Commands Manual* for more information on the `ent-1s` or `chg-1s` commands.

### Gateway Screening Attributes

Each screen has attributes which hold information required to perform a particular screening function. The following attributes are required in order to implement all of the screening functions.

The screen set name (**scrn**) is a four character (one alpha and up to three alphanumeric) value that specifies the name of the screen set.

The screening reference (**sr**) is a four character (one alpha and up to three alphanumeric) value. Combined with the next screening function identifier (**nsfi**), it uniquely defines a screening table.

The network identifier for ANSI point codes (**ni**) is an integer between 0 and 255, the asterisk "\*", or the character "c".

The network cluster for ANSI point codes (**nc**) is an integer between 0 and 255, the asterisk "\*", or the character "c".

The network cluster member for ANSI point codes (**ncm**) is an integer between 0 and 255, the asterisk "\*", or the character "c".

The zone for ITU international point codes (**zone**) is an integer between 0 and 7, the asterisk "\*", or the character "c".

The area for ITU international point codes (**area**) is an integer between 0 and 255, the asterisk "\*", or the character "c".

The ID for ITU international point codes (**id**) is an integer between 0 and 7, the asterisk "\*", or the character "c".

The 14-bit ITU national point code (**npc**) is an integer between 1 and 16383, the asterisk "\*", or the character "c". The EAGLE 5 SAS supports different formats for 14-bit ITU national point codes as defined by the **npcfmt i** parameter of the **chg-stpopts** command. No matter what format is defined by the **npcfmt i** parameter, the 14-bit ITU national point code must be entered as an integer for gateway screening. If the format of the 14-bit ITU national point code that you wish to enter for gateway screening is not a single integer, the point code value must be converted into a single integer value. For more information on converting 14-bit ITU national point code values, see the "14-Bit ITU National Point Code Formats" section on page 2-24. For more information on the different ITU national point code formats, see the "14-Bit ITU National Point Code Formats" section in Chapter 2, "Configuring Destination Tables" in the *Database Administration Manual - SS7*.

Gateway Screening supports using ITU international spare point codes in addition to ITU international point codes, and 14-bit ITU national spare point codes in addition to 14-bit ITU national point codes. The **pcst** parameter is used to specify the whether or not the ITU international and 14-bit ITU national point codes are spare point codes (**pcst=s** parameter) or not (**pcst=none** parameter). For more information about ITU international and 14-bit ITU national spare point codes, see Chapter 2, "Configuring Destination Tables" in the *Database Administration Manual - SS7*. Gateway Screening does not support using private point codes.

The main signaling area value for 24-bit ITU national point codes (**msa**) is an integer between 0 and 255, the asterisk "\*", or the character "c".

The sub-signaling area value for 24-bit ITU national point codes (**ssa**) is an integer between 0 and 255, the asterisk "\*", or the character "c".

The signaling point value for 24-bit ITU national point codes (**sp**) is an integer between 0 and 255, the asterisk "\*", or the character "c".

The ISUP message type (**isupmt**)/TUP message type (**tupmt**) is an integer between 0 and 255, or the character "\*". This parameter specifies either an ISUP message type or a TUP message type for the ISUP screening reference specified in the **sr** parameter.

The service indicator (**si**) is an integer between 0 and 15. This parameter specifies a service indicator for the SIO screening reference specified in the **sr** parameter. The service indicator is the first 4 bits of an SIO.

The network indicator code (**nic**) is an integer between 0 and 3 or an "\*" (asterisk). This parameter specifies a network indicator code for the SIO screening reference specified in the **sr** parameter. The network indicator code is the last 2 bits of an SIO.

The H0 heading code (**h0**) is an integer between 0 and 15, or an "\*" (asterisk). This parameter specifies the first four bits of a message type for the SIO screening reference.

The H1 heading code (**h1**) is an integer between 0 and 15, or an "\*" (asterisk). This parameter specifies last four bits of a message type for the SIO screening reference.

The message priority (**pri**) is an integer between 0 and 3. This parameter specifies the message priorities for the SIO screening reference.

The subsystem number (**ssn**) is an integer between 1 and 255 or an "\*" (asterisk). This parameter identifies the SCP application that should receive the message.

## Gateway Screening (GWS) Overview

The routing indicator (**ri**) is destination point code (DPC), global title translation (GT), or "\*" (asterisk). This parameter indicates whether a subsequent global title translation is required.

**gt** – indicates that a subsequent translation is required.

**dpc** – indicates that no further translation is required.

\* (asterisk) – indicates all possible values (DPC and GT).

The translation type (**type**) is an integer between 0 and 255 or a "\*" (asterisk). Identifies the type of global title translation. It is the decimal representation of the 1-byte field used in SS7.

The SCCP message type (**sccpmt**) is an integer with the values 9 (UDT messages), 10 (UDTS messages), 17 (XUDT messages), 18 (XUDTS messages), or "\*" (asterisk). This parameter specifies one of these message types and is part of the calling party address screen.

The SCCP management (SCMG) format ID (**scmgfid**) is an integer from 1 to 255 or "\*" (asterisk). This parameter specifies the function and format of an SCMG message and is part of the called party address screen.

The next screening function identifier (**nsfi**) is the screen function that is required to continue processing the message. It is the next step in processing the message. The values for this attribute are: **opc**, **blkopc**, **sio**, **dpc**, **blkdpc**, **destfld**, **isupcgpa**, **tt**, **cdpa**, **aftpc**, **stop**, and **fail**.

The next screening reference (**nsr**) is a four character (one alpha and up to three alphanumeric) value. Combined with the next screening function identifier (**nsfi**), it uniquely defines the next screening table to be used in the gateway screening process.

The gateway screening stop action set name (**actname**) is a six character (one alpha and up to five alphanumeric characters) value. Specified only with the **nsfi=stop** parameter, the gateway screening stop action set defines the additional actions the EAGLE 5 SAS can perform on MSUs that pass gateway screening.

The asterisk, or "\*", is a single entry that indicates all possible values for that parameter.

These attributes are not used on all screens. Table 2-1 indicates which attributes are required for each screening type. There are two types of attributes, search keys and results. The search keys are used to match fields in the SS7 message in order to determine the screening function result. The result is determined by matching a search key with information in the current SS7 message. The result indicates the next step in the screening process.

Table 2-1. Attributes for Gateway Screening Functions

Screening Function	Search Keys																				Result							
	SCRN	SR	NI	NC	NCM	ZONE	AREA	ID	NPC	MSSA	SSA	SP	NIC	SI	H0	H1	PRI	RI	SSN	SCCPMT	SCMGFD	TYPE	ISUPMT**	TUPMT**	PCST	NSFI	NSR*	ACTNAME†
Screen Set	X																									X	X	X
Allowed OPC		X	X	X	X	X	X	X	X	X	X	X													X	X	X	X
Blocked OPC		X	X	X	X	X	X	X	X	X	X	X													X	X‡	X‡	X
Allowed SIO		X											X	X	X	X	X									X	X	X
Allowed DPC		X	X	X	X	X	X	X	X	X	X	X	X												X	X	X	X
Blocked DPC		X	X	X	X	X	X	X	X	X	X	X	X												X	X‡	X‡	X
Allowed DESTFLD		X	X	X	X	X	X	X	X	X	X	X	X												X	X		X
Allowed CGPA		X	X	X	X	X	X	X	X	X	X	X					X	X	X						X	X	X	X
Allowed TT		X																			X				X	X	X	
Allowed CDPA		X	X	X	X	X	X	X	X	X	X	X						X		X					X	X	X	X
Allowed AFTPC		X	X	X	X	X	X	X	X	X	X	X							X						X	X		X
Allowed ISUP		X																				X	X		X		X	

\* The NSR parameter can only be specified when the NSFI is not STOP. The NSR cannot be specified with the ACTNAME parameter.  
 † The ACTNAME parameter can only be specified when the NSFI is STOP. The ACTNAME parameter cannot be specified with the NSR parameter.  
 ‡ NSFI and NSR can only be defined once per screening table.  
 \*\* The Allowed ISUP Screening function table contains both the ISUP message type (ISUPMT) and TUP message type (TUPMT). Only one of these parameters can be specified for an allowed ISUP screen. The parameter value to be used is dependent on the service indicator (SI) value specified in the allowed SIO screen: SI=5 for an ISUP message type, SI=4 for a TUP message type.

### Use of the Character “c” for the NI, NC, NCM, ZONE, AREA, ID, NPC, MSA, SSA, and SP Parameters

The character “c” is used in the blocked OPC or DPC screens (for parameters **ni**, **nc**, **ncm**, **zone**, **area**, **id**, **npc**, **msa**, **ssa**, and **sp**) to allow the screening process to continue for messages with point codes that do not match any point codes in the blocked OPC or DPC screens. The character “c” is used this way. When screening for a blocked OPC or DPC and the point code being screened does not match any of the point codes in the blocked OPC or DPC screens, the message is not rejected and the screening process continues. To allow the screening process to continue, the blocked OPC and blocked DPC screens must have at least one entry consisting of a screening reference, a point code, a next screening function identifier, and a next screening reference. The point code is in the form of **ni=c**, **nc=c**, **ncm=c** (for ANSI point codes), **zone=c**, **area=c**, **id=c** (for ITU international point codes), **npc=c** (for 14-bit ITU national point codes), and **msa=c**, **ssa=c**, **sp=c** (for 24-bit ITU national point codes). When the character “c” is specified, the next screening function identifier and next screening reference must be specified, unless the next screening function identifier is stop (**nsfi=stop**). Then the next screening reference cannot be specified.

When the point code does not match any entries in the blocked OPC or DPC screens, the screening process is directed to the screening reference with the point code **c-c-c** or **npc=c**. The next screening function identifier and next screening reference in this entry are examined to determine the next step in the screening process.

When a blocked OPC or DPC screen is created, the first entry for the **ni-nc-ncm**, **zone-area-id**, or **msa-ssa-sp** must be **c-c-c**, or the **npc** must “c.” Subsequent entries can be specific point codes.

If the character “c” is specified for any parameters **ni**, **nc**, **ncm**, **zone**, **area**, **id**, **msa**, **ssa**, or **sp**, it must be specified for all three parameters. No other values can be used. For example, a point code **c-c-255** is not allowed. The point code must be **c-c-c**. The “\*” (asterisk) value cannot be used with the character “c” (for example, a point code **c-c-\*** is not allowed).

ANSI, ITU international, or 24-bit ITU national point codes using the value “c” can be entered by specifying only the **ni=c** parameter (for ANSI point codes), **zone=c** parameter (for ITU international point codes), or **msa=c** parameter (for 24-bit ITU national point codes), and the **nc**, **ncm**, **area**, **id**, **ssa**, and **sp** parameters can be omitted.

The **pcst** and **npcst** parameters, for specifying the ITU international and 14-bit ITU national spare point codes, cannot be used with point codes containing the character “c”.

**Specifying a Range of Values for Gateway Screening Parameters**

The values of these gateway screening parameters can be specified as a range of values.

- ni** – the network identifier for an ANSI point code
- nc** – the network cluster for an ANSI point code
- ncm** – the network cluster member for an ANSI point code
- pri** – the message priority in the SIO field of an MSU
- h0** – the H0 heading code in the SIF field of an MSU
- h1** – the H1 heading code in the SIF field of an MSU
- type** – the translation type in the called party address field of an MSU
- isupmt** – the ISUP message type
- tupmt** – the TUP message type

A range of values is specified with the values that define the range separated by two ampersands (&&), for example, **:ni=025&&100** specifies all network indicators for ANSI point codes from 25 to 100.

A range of values for an ANSI point code parameter can be specified with asterisks (\*) or single values for other point code parameters. Table 2-2 shows the valid combinations of these parameter values.

**Table 2-2.** Valid Value Combinations for ANSI Point Code Parameters

NI	NC	NCM
Single Value	Single Value	Single Value
Single Value	Single Value	Range of Values
Single Value	Single Value	Asterisk
Single Value	Range of Values	Asterisk
Single Value	Asterisk	Asterisk
Range of Values	Asterisk	Asterisk
Asterisk	Asterisk	Asterisk

A range of values for the H0 and H1 heading codes can be specified with asterisks (\*) or single values for other heading code parameter. Table 2-3 shows the valid combinations of these parameter values.



## Gateway Screening (GWS) Overview

**Table 2-3.** Valid Value Combinations for H0 and H1 Parameters

H0	H1
Single Value	Single Value
Single Value	Range of Values
Single Value	Asterisk
Range of Values	Asterisk
Asterisk	Asterisk

When changing or removing an existing gateway screening entry, the ANSI point code values, priority values, H0 and H1 heading code values, translation type, ISUP message type, or TUP message type values specified with the command must match the values configured in the database for the specified screening reference. If a command is specified with a parameter value that is part of a range of values for that parameter already configured for that screening reference, the command is rejected.

For example, the database contains a gateway screening entry for the range of allowed OPCs 010-010-010 to 010-010-100 in Allowed OPC screening reference **opc1**. If an attempt is made to remove or change Allowed OPC screening reference **opc1** and the ANSI point code 010-010-025 is specified. The command is rejected because point code 010-010-025 is a part of the point code range configured in the database. To remove or change Allowed OPC screening reference **opc1**, these point code parameters must be specified with the command, **ni=010, nc=010, ncm=010&&100**.

If the ANSI point code, priority value, H0 and H1 heading code values, or translation type values specified with an enter command is within the range of values already configured for the specified screening reference, the command is rejected. For example, the **ent-scr-opc** command is entered with the point code 010-010-050 assigned to screening reference **opc1**. If the database contains the range of point codes 010-010-010 to 010-010-100, specified as **ni=010, nc=010, ncm=010&&100**, the command is rejected. If the database contains an entry for all point codes with the network identifier of 010 and network cluster of 010, **ni=010, nc=010, ncm=\***, the command is rejected.

A range of values can be specified when displaying gateway screening entries. The range of values does not have to match the values configured in the database. The range of values specified with a retrieve command is used to limit the number of entries to search for. There are some restrictions for using ANSI point code values with retrieve commands. Table 2-4 shows the valid combinations of the ANSI point code parameters.

**Table 2-4.** Valid Parameter Combinations for ANSI Point Code Parameters

NI	NC	NCM
Single value	Single value	Single value, a range of values, an asterisk, or the NCM value not specified
Single value	A range of values, an asterisk, or the NC value is not specified	the NCM value is not specified
A range of NI values, an asterisk, or the NI value is not specified	the NC value is not specified	the NCM value is not specified

The range of values are displayed in the output of the retrieve commands the same way as they were entered. The following are examples of outputs containing ranges of values.

**rtrv-scr-blkdpc:sr=iec:ni=240:nc=001:ncm=010&&018**

```
rlghncxa03w 05-09-25 15:25:30 GMT EAGLE5 34.0.0
SCREEN = BLOCKED DPC
SR  NI      NC      NCM      NSF1     NSR/ACT
IEC  240     001     010&&020 STOP  -----
```

**rtrv-scr-sio:sr=iec:nic=1:si=1**

```
rlghncxa03w 05-09-25 15:25:30 GMT EAGLE5 34.0.0
SCREEN = ALLOWED SIO
SR  NIC  PRI  SI  H0      H1      NSF1     NSR/ACT
IEC  2    0&&2  1   08&&11 *     BLKDPC  WDB2
IEC  2    1    1   11     03&&07 DPC     ABC2
```

**rtrv-scr-tt:all=yes**

```
rlghncxa03w 05-09-25 15:25:30 GMT EAGLE5 34.0.0
SCREEN = ALLOWED TT
SR  TYPE     NSF1     NSR/ACT
IEC  005&&010 STOP  -----
IEC  012      STOP  -----
IEC  016      CDPA  IEC
WRD2 243      STOP  -----
WRD4 *       STOP  -----
```

**Use of the Asterisk “\*” for the ZONE, AREA, ID, MSA, SSA, and SP Parameters**

A range of values for an ITU-I or 24-bit ITU-N point code parameter can be specified using a combination of asterisks (\*) and single values for the point code parameters. Table 2-5 shows the valid combinations of the ITU-I parameter values. Table 2-6 shows the valid combinations of the 24-bit ITU-N parameter values.

**Table 2-5.** Valid Value Combinations for ITU-I Point Code Parameters

ZONE	AREA	ID
Single Value	Single Value	Single Value
Single Value	Single Value	Asterisk
Single Value	Asterisk	Asterisk
Asterisk	Asterisk	Asterisk

**Table 2-6.** Valid Value Combinations for 24-Bit ITU-N Point Code Parameters

MSA	SSA	SP
Single Value	Single Value	Single Value
Single Value	Single Value	Asterisk
Single Value	Asterisk	Asterisk
Asterisk	Asterisk	Asterisk

Table 2-7 shows the valid combinations of the ITU-I point code parameters used with the retrieve commands when displaying ITU-I gateway screening entries.

**Table 2-7.** Valid Parameter Combinations for ITU-I Point Code Parameters

ZONE	AREA	ID
Single value	Single value	Single value, an asterisk, or the ID value not specified
Single value	An asterisk, or the AREA value is not specified	the ID value is not specified
An asterisk, or the ZONE value is not specified	the AREA value is not specified	the ID value is not specified

Table 2-8 shows the valid combinations of the 24-bit ITU-N point code parameters used with the retrieve commands when displaying 24-bit ITU-N gateway screening entries.

**Table 2-8.** Valid Parameter Combinations for 24-bit ITU-N Point Code Parameters

MSA	SSA	SP
Single value	Single value	Single value, an asterisk, or the SP value not specified
Single value	An asterisk, or the SSA value is not specified	the SP value is not specified
An asterisk, or the MSA value is not specified	the SSA value is not specified	the SP value is not specified

## User Interface Requirements

A screening table is created, modified, displayed and removed using these on-line commands. For more information on these commands, go to the *Commands Manual*.

- Screen Set – `ent-scrset`, `chg-scrset`, `dlt-scrset`, `rtrv-scrset`
- Allowed Originating Point Code – `ent-scr-opc`, `chg-scr-opc`, `dlt-scr-opc`, `rtrv-scr-opc`
- Blocked Originating Point Code – `ent-scr-blkopc`, `chg-scr-blkopc`, `dlt-scr-blkopc`, `rtrv-scr-blkopc`
- Allowed Service Information Octet – `ent-scr-sio`, `chg-scr-sio`, `dlt-scr-sio`, `rtrv-scr-sio`
- Allowed Destination Point Code – `ent-scr-dpc`, `chg-scr-dpc`, `dlt-scr-dpc`, `rtrv-scr-dpc`
- Blocked Destination Point Code – `ent-scr-blkdpc`, `chg-scr-blkdpc`, `dlt-scr-blkdpc`, `rtrv-scr-blkdpc`
- Allowed Affected Destination Field – `ent-scr-destfld`, `chg-scr-destfld`, `dlt-scr-destfld`, `rtrv-scr-destfld`
- Allowed ISUP/TUP Message Type – `ent-scr-isup`, `chg-scr-isup`, `dlt-scr-isup`, `rtrv-scr-isup`
- Allowed Calling Party Address – `ent-scr-cgpa`, `chg-scr-cgpa`, `dlt-scr-cgpa`, `rtrv-scr-cgpa`
- Allowed Called Party Address – `ent-scr-cdpa`, `chg-scr-cdpa`, `dlt-scr-cdpa`, `rtrv-scr-cdpa`

## Gateway Screening (GWS) Overview

- Allowed Translation Type – **ent-scr-tt**, **chg-scr-tt**, **dlt-scr-tt**, **rtrv-scr-tt**
- Allowed Affected Point Code – **ent-scr-aftpc**, **chg-scr-aftpc**, **dlt-scr-aftpc**, **rtrv-scr-aftpc**
- Gateway Screening Stop Action Sets – **chg-gws-actset**, **rtrv-gws-actset**

## Command Summary

This section briefly describes each type of command used in this chapter. There are four commands for each screening function. One to enter the screening information (**ent**), one to change the screening information after it has been entered (**chg**), one to delete screening information (**dlt**), and one to display the screening information (**rtrv**).

If the command is not accepted, a “Command Rejected” message is displayed. If the command is accepted, a time stamp and a “Command Completed” message is displayed. For example:

```
E2361 Cmd Rej: Screen set name not defined
```

or

```
rlghncxa03w 05-09-25 15:25:30 GMT EAGLE5 34.0.0  
ENT-SCR-OPC: MASP A - COMPLTD
```

Any time a screen set is affected by a command (for example, an entry is added to, removed from, or changed in the screen set) a “Screen Set Affected” message is displayed indicating the percentage of memory that screen set occupies (100% = the maximum space available). This information is useful in determining how “full” the screen set is at any given time. The percentages are calculated after the command is executed. For example, the output message, **ENT-SCR-OPC: SCREEN SET AFFECTED - SS01 25% FULL**, indicates that after an entry was added to screen set **SS01** by the **ent-scr-opc** command, it occupied 25% of the maximum space available. The following is an example of the output that can be received when a screen set is affected.

```
Extended Processing Time Required -- Please Wait  
Notice: The number of screensets affected is 2.  
ENT-SCR-OPC: SCREEN SET AFFECTED - ss01 25% FULL  
ENT-SCR-OPC: SCREEN SET AFFECTED - ss04 35% FULL  
ENT-SCR-OPC: MASP A - COMPLTD
```

When a new screen set is created it immediately occupies space which may or may not be over the allowed limit. The user must know how much space has been occupied by the new screen set. For example, if the screen set **SCR1** is created, the output of the **ent-scrset** command has the following format:

```
Extended Processing Time Required -- Please Wait  
Notice: The number of screensets affected is 1.  
ENT-SCRSET: SCREEN SET AFFECTED - scr1 95% FULL  
ENT-SCRSET: MASP A - COMPLTD
```

**NOTE:** A screen set can be over 100% full, but it is not recommended that the screen set remain in this condition. The gateway screening process will not function properly using a screen set that is over 100% full. Some entries must be removed from the screen set to reduce the screen set capacity to 100% or below.

### Enter Commands

All of the parameters in the enter command are mandatory. If the enter command contains a screening reference that does not exist, a new screening table is created. If the screening reference exists, and an entry that matches the specified parameters does not already exist, a new entry is added to the screening table. If an entry exists already, the command is rejected.

### Change Commands

At least one parameter must be changed in the change commands. Parameters that are considered part of the search key must be specified in every **chg** command (for example, the **ni**, **nc**, **ncm**, **zone**, **area**, **id**, **npc**, **msa**, **ssa**, and **sp** parameters for the **chg-scr-opc** command). Each of these parameters has a corresponding "new" parameter (for example, **nni**, **nnc**, **nncm**, **nzone**, **narea**, **nid**, **nnpc**, **nmsa**, **nssa**, **nsp**) which may be specified in order to change the entry in the screening table. Parameters that are not part of the search key may be specified, but do not have "new" values. For example, the **nsfi**, **nsr**, **ri**, and **actname** parameters do not have "new" parameters (for example, **nnsfi**, **nnsr**, **nri**, or **nactname**). If a "new" parameter is not specified, it assumes the value of the corresponding search key parameter. For example, if the **nni** parameter is not specified, then the **ni** parameter does not change since the **nni** parameter assumes the value of the **ni** parameter. If, however, a "new" parameter is specified, it must follow the same rules as the search keys. For example, if the **nni** and **nncm** parameters are not specified, and the **nnc** parameter is specified as an "\*" (asterisk), then the **ncm** parameter must be an "\*" (asterisk). The new data must not already exist in the screening table. If an entry already exists which matches the new data, the command is rejected.

### Delete Commands

The use of the asterisk value in a delete command implies the deletion of a specific entry containing that asterisk value, not the deletion of multiple entries whose values may be in the range implied by the asterisk. For example, entering **dlt-scr-opc:sr=opc1:ni=\*:nc=\*:ncm=\*** cannot be used to remove all entries in **opc1**.

When the last entry is deleted from a screening table, the entire table is deleted, unless it is referenced by another screening table. If a screening table is referenced and an attempt is made to delete the last entry in the screening table, an error message is displayed.

Retrieve Commands

The retrieve commands for each screening function have the same parameters as the enter commands with an additional parameter called **a11**. The **a11** parameter defaults to **no**, and can only be specified if no other parameters are specified. If the **a11** parameter is specified and is **yes**, then a detailed output consisting of every entry in each rule of the indicated screening function type is displayed. There are no rules associated with parameter combinations (for example, if the **nc** parameter is equal to \* then the **ncm** parameter must be ""). If an entry is specified using a "", then only the entries where that parameter is a "" is output.

If the NSFI has a value other than STOP or FAIL, then the name of the screening reference to be used in the next step of the gateway screening process (NSR) must be specified. The value of the NSR is shown in the **NSR/ACT** field.

If the NSFI is STOP, no NSR value can be specified. The gateway screening stop action sets can be specified with the **actname** parameter if the NSFI is STOP. If a gateway screening stop set has been assigned to the screen, the **NSR/ACT** field shows the name of the gateway screening stop action set. for more information on the gateway screening stop action sets, go to the "Configuring Gateway Screening Stop Action Sets" procedure on page 2-54.

If the NSFI is FAIL or STOP and no NSR or ACTNAME value is assigned to the screen, the entry ----- is shown in the **NSR/ACT** field.

The following is an example of a detailed output using the **rtrv-scr-opc** command with the **a11=yes** parameter specified.

```

rlghncxa03w 05-09-25 15:25:30 GMT EAGLE5 34.0.0
SCREEN = ALLOWED OPC
SR      NI      NC      NCM      NSFI      NSR/ACT
IEC     240     001     010&&200 STOP     -----
IEC     241     *      *      CGPA     cg04

SR      ZONE   AREA   ID      NSFI      NSR/ACT
IEC     1      003   4      BLKOPC   blk1
IEC     1      003   5      STOP     COPY

SR      NPC
IEC     00235
IEC     00240
           CGPA     cg04
           CGPA     cg01

SR      NI      NC      NCM      NSFI      NSR/ACT
WRD2   243     015&&075 *      STOP     RDCT
WRD3   243     105     002     CGPA     WRD4

SR      NPC
WRD4   00245
WRD4   00247
           BLKOPC   blk3
           STOP     CR
    
```

For the `rtrv-scrset:all=yes` command, the output consists of every screen set and every screening table in each screen set, in addition to the fields displayed from the `rtrv-scrset` command with no parameters. The following is an example of the detailed output of the `rtrv-scrset:all=yes` command.

```
rlghncxa03w 05-09-25 15:25:30 GMT EAGLE5 34.0.0
SCRN  NSFI    NSR/ACT  RULES  DESTFLD
SS01  OPC     IEC      120    Y
      DPC     GOOP     33
      SIO     WRD1     5
SS02  STOP    -----  0      Y
SS03  DPC     WRD1     56     Y
      SIO     WRD2     10
      BLKDPC  WRD5     30
```

Parameters that are not specified default to “all possible values” for that parameter. If no parameters are specified (except for the `rtrv-scrset` command), a summary output is displayed. A summary output consists of three columns of information, the screening references for the specified screen (**SR**), and an indicator of whether the screen table is referenced or not (**REF**), and the number of entries in the screening reference (**RULES**). The following is an example of a summary output using the `rtrv-scr-opc` command with no parameters.

```
rlghncxa03w 05-09-25 15:25:30 GMT EAGLE5 34.0.0
SCREEN = ALLOWED OPC
SR    REF  RULES
IEC   YES   2
WRD2  YES   1
WRD3  NO    4
WRD4  YES   9
```

For the `rtrv-scrset` command, if no parameters are specified, the output displays the following information.

- The capacity of the gateway screening database, as a percentage of the maximum capacity
- The percentage of the maximum number of the CDPA and AFTPC tables
- The total number of screen sets in the database with the percentage of the screen set capacity
- The number of SEAS and EAGLE 5 SAS screen sets being used
- The screen set name (**SCRN**)
- The next screening function that should be used in the gateway screening process (**NSFI**)
- The next screening reference or the gateway screening stop action set name (**NSR/ACT**)
- The memory capacity (percentage) of each screen set (**FULL**)
- The number of entries (rules) in the screen set (**RULES**)



## Gateway Screening (GWS) Overview

- The number of tables in the screen set (**TABLES**)
- Whether the automatic allowed affected destination screening (**DESTFLD**) for network management messages is applied against the routing table, self point codes, and capability point codes. When this parameter is on, the automatic screening is applied at the end of the provisioned screen set.

The following is an example of the output of the **rtrv-scrset** command with no parameters.

```
rlghncxa03w 05-09-25 15:25:30 GMT EAGLE5 34.0.0
ENTIRE GWS DATABASE IS 1% FULL
CDPA + AFTPC TABLES ARE 1% FULL
SCREEN SET TABLE IS (7 OF 255) 2% FULL
THERE ARE 0 SEAS SCREEN SETS USED ( prefix 00nn )
THERE ARE 7 EAGLE SCREEN SETS USED

SCRN  NSFI    NSR/ACT  FULL  RULES  TABLES  DESTFLD
ss01  OPC     opc1    51%   2075   22       Y
ss02  OPC     opc2     2%    75     22       Y
ss03  OPC     opc3     2%    75     22       Y
ss04  OPC     opc1    51%   2075   22       N
ss07  OPC     opc1    51%   2075   22       Y
ss09  OPC     opc1    51%   2075   22       N
ss28  OPC     opc1    51%   2075   22       Y
```

The outputs of the retrieve commands contains the following fields. There are certain fields that are used with specific commands and these are noted in the description of the field.

**AREA** – The area value of an ITU international point code, expressed as **zone-area-id**. This field is used with all screening functions except screen set, allowed SIO, and allowed TT screening functions.

**DESTFLD** – Whether the automatic allowed affected destination screening for network management messages is applied against the routing table, self point codes, and capability point codes. When this parameter is on, the automatic screening is applied at the end of the provisioned screen set. This field is only used with the screen set function.

**FULL** – The capacity of allowed memory a given screen set occupies, expressed as percentage. This field is only used with the screen set function.

**H0** – The H0 heading code in the service information field. The **H0** field shows the first four bits of the message type indicator in the SIO field. This field is only used with the allowed SIO screening function.

**H1** – The H1 heading code in the service information field. The **H1** field shows the last four bits of the message type indicator in the SIO field. This field is only used with the allowed SIO screening function.

**ID** – The ID value of an ITU international point code, expressed as **zone-area-id**. This field is used with all screening functions except screen set, allowed SIO, and allowed TT screening functions.

**ISUPMT/TUPMT** – The ISUP message type (**ISUPMT**) in the service information field of an ISUP message or the TUP message type (**TUPMT**) in the service information field of a TUP message. This field is used only with allowed ISUP screening functions.

**MSA** – The main signaling area value of a 24-bit ITU national point code, expressed as **msa-ssa-sp**. This field is used with all screening functions except screen set, allowed SIO, and allowed TT screening functions.

**NC** – The network cluster of an ANSI point code, expressed as **ni-nc-ncm**. This field is used with all screening functions except screen set, allowed SIO, and allowed TT screening functions.

**NCM** – The network cluster member of an ANSI point code, expressed as **ni-nc-ncm**. This field is used with all screening functions except screen set, allowed SIO, and allowed TT screening functions.

**NI** – The network identifier of an ANSI point code, expressed as **ni-nc-ncm**. This field is used with all screening functions except screen set, allowed SIO, and allowed TT screening functions.

**NIC** – The network indicator code in the service information octet. This field is only used with the allowed SIO screening function.

**NPC** – The ITU national point code. This field is used with all screening functions except screen set, allowed SIO, and allowed TT screening functions.

**NSFI** – The next screening function identifier. The next screening function identifier specifies the next screening function that should be used in the gateway screening process. This field is used with all screening functions.

**NSR/ACT** – The next screening reference or the gateway screening stop action set name. The next screening reference is the name of the of the next gateway screening entity that should be used in the screening process. The gateway screening stop action set name is the name of the gateway screening stop action set assigned to the screen defining the additional action to be performed on the MSU that passes gateway screening. This field is used with all screening functions.

**PRI** – The priority of a message in the service information octet. This field is only used with the allowed SIO screening function.

**REF** – An indicator of whether the specified screening table is referenced by another screening table. This field is used with the summary outputs of all retrieve commands except the retrieve screen set (**rtrv-scrset**) command.

**RI** – The routing indicator in the called party address (CDPA). This field is only used with the allowed CGPA screening function.

**RULES** – The number of entries in the screen. This field is only used with the screen set function.

## Gateway Screening (GWS) Overview

**SCCPMT** – The SCCP message type. This field is only used with the allowed calling party address function.

**SCMGFID** – The SCCP management (SCMG) format ID, which defines the function and format of each SCMG message. This field is only used with the allowed called party address function.

**SCRN** – The name of the screen set. This field is only used with the screen set function.

**SI** – The service indicator for the service information octet, which are the last two bits of the subservice field. This field is only used with the allowed SIO screening function.

**SP** – The signaling point value of a 24-bit ITU national point code, expressed as **msa-ssa-sp**. This field is used with all screening functions except screen set, allowed SIO, and allowed TT screening functions.

**SR** – The name of the screening reference. This field is used with all screening functions except the screen set screening function.

**SSA** – The sub-signaling area value of a 24-bit ITU national point code, expressed as **msa-ssa-sp**. This field is used with all screening functions except screen set, allowed SIO, and allowed TT screening functions.

**SSN** – The subsystem number of a given point code. This field is only used with the allowed CGPA, allowed CDPA, and allowed AFTPC screening functions.

**TABLES** – The number of tables in the screen. This field is only used with the screen set function.

**TYPE** – The translation type that is allowed for global title translation. This field is only used with the allowed TT screening function.

**ZONE** – The zone value of an ITU international point code, expressed as **zone-area-id**. This field is used with all screening functions except screen set, allowed SIO, and allowed TT screening functions.

The ITU international and 14-bit ITU national spare point codes are displayed in the output of the Gateway Screening retrieve commands with the spare point code subtype prefix “s-”.

## 14-Bit ITU National Point Code Formats

Gateway screening only allows 14-bit ITU national point codes to be provisioned in the database by the enter, delete, or change gateway screening commands, and displayed by the gateway screening retrieve commands as a single number. If a format other than a single number (14-0-0-0) for the 14-bit ITU national point code has been defined by the **npcfmt*i*** parameter of the **chg-stpopts** command, the 14-bit ITU national point code must be converted into a single number so that it can be used by gateway screening.

For example, the format of the 14-bit ITU national point code is 4-4-4-2 and the user would like to add point code value 7-7-7-1 into the allowed OPC screen. The point code value 7-7-7-1 would have to be converted to a single number so that the point code can be added to the allowed OPC screen. To determine what multiple part 14-bit ITU national point code is represented by the single number 14-bit ITU national point code in the gateway screening table, the single number point code must be converted to a multiple part point code.

To convert a single number 14-bit ITU national point code to a multiple part point code, go to “Converting Single Number 14-Bit ITU National Point Codes” on page 2-24.

To convert a multiple part 14-bit ITU national point code to a single number point code, go to “Converting Multiple Part 14-Bit ITU National Point Codes” on page 2-26.

For a definition of the different formats that can be used for 14-bit ITU national point codes, see the “14-Bit ITU National Point Code Formats” section in Chapter 2, “Configuring Destination Tables” in the *Database Administration Manual - SS7*.

### Converting Single Number 14-Bit ITU National Point Codes

To convert a single number 14-bit ITU national point code to a multiple part 14-bit ITU national point code, perform these steps. To make this conversion, you will need to know the format of the 14-bit ITU national point code. This can be verified in the **NPCFMTI** field of the **rtrv-stpopts** command output. For this example, the 14-bit ITU national point codes 14781 and 695 are converted to point codes using the 3-8-3-0 format.

1. The point code is converted to a binary number. This can be done with most scientific calculators.
  - a. The number 14781 converts to the binary number 11100110111101.

b. The number 695 converts to the binary number 1010110111.

**NOTE: Make sure the binary number contains 14 digits. If it does not, add leading zeros to the binary number to bring the total number of digits in the number to 14.**

**In this example, the binary equivalent for the decimal number 695 (1010110111) contains 10 digits, so four zeros must be added to the beginning of the binary number. The resulting binary number is now 00001010110111.**

2. Divide the binary number into the number of parts required by the format of the 14-bit ITU national point code. For this example, the format is 3-8-3-0. Since the last part of the point code format is 0, the point code format contains only three parts. Divide the point code into three parts, the first part of the point code contains the first three digits of the 14-digit binary number, the second part of the point code contains the next eight digits of the 14-digit binary number, and the third part of the point code contains the last three digits of the 14-digit binary number.

For this example, the binary numbers would be divided like this:

a. 11100110111101 = 111 00110111 101

b. 00001010110111 = 000 01010110 111

3. Convert each part of the point code into a decimal number using the same scientific calculator used in step 1 and separate each part of the point code with dashes. The results are as follows.

a. 111 00110111 101 = 7-55-5

b. 000 01010110 111 = 0-86-7

When the 14-bit ITU national point codes are converted from single numbers to multiple part point codes, the resulting value of the multiple part point code depends on the point code format specified by the `npcfmt` parameter of the `chg-stpopts` command. When converting the single number point code 14781 to the point code format 3-8-3-0, the resulting point code value is 7-55-5. If point code 14781 is converted to the point code format 4-4-4-2, the resulting point code value is 14-6-15-1.

### Converting Multiple Part 14-Bit ITU National Point Codes

To convert multiple part 14-bit ITU national point codes to a single number, perform these steps. To make this conversion, you will need to know the format of the 14-bit ITU national point code. This can be verified in the **NPCFMTI** field of the **rtrv-stpopts** command output. For this example, the 14-bit ITU national point codes 7-55-5 and 0-86-7, using the 3-8-3-0 point code format, are converted into a single number.

1. Convert each part of the point code into a binary number using a scientific calculator. The results are as follows.
  - a. 7-55-5 = 111 00110111 101
  - b. 0-86-7 = 000 01010110 111
2. Combine each part of the point code into a single binary number as follows.
  - a. 111 00110111 101 = 11100110111101
  - b. 000 01010110 111 = 00001010110111

**NOTE:** If the binary number has any zeros at the beginning of the number, remove these zeros as they are not necessary.

**In this example, the binary equivalent for the point code 0-86-7 (00001010110111) contains four zeros at the beginning of the binary number. When the leading zeros are removed from the binary number, the resulting binary number is now 1010110111.**

3. Convert the binary number to a decimal number using the same scientific calculator used in step 1.
  - a. The binary number 11100110111101 converts to the decimal number 14781.
  - b. The binary number 1010110111 converts to the decimal number 695.

## Gateway Screening Using Duplicate ITU National Point Codes

**NOTE: The Duplicate ITU National Point Code feature applies only to 14-bit ITU national point codes.**

Gateway screening does not support the Duplicate ITU National Point Code Support feature. The point code value specified with the `npc` parameter can only be a 5-digit number and cannot contain any group code values. However, by assigning a different screenset to the linksets that have different group codes, you can screen on ITU national point codes that have group codes assigned to them. The screenset is assigned to the linkset with the `scrn` parameter of either the `ent-1s` or `chg-1s` command.

For example, in the network in Figure 2-1, if you want to screen out MSUs coming from OPC 6217 in group GE, but allow MSUs coming from OPC 6217 in group FR, you could assign different screensets to linksets LSB1 and LSB2. The screenset assigned to linkset LSB1 would allow MSUs from OPC 6217. The screenset assigned to linkset LSB2 would block MSUs from OPC 6217.

**Figure 2-1.** Sample Network Showing Gateway Screening Using Duplicate ITU National Point Codes

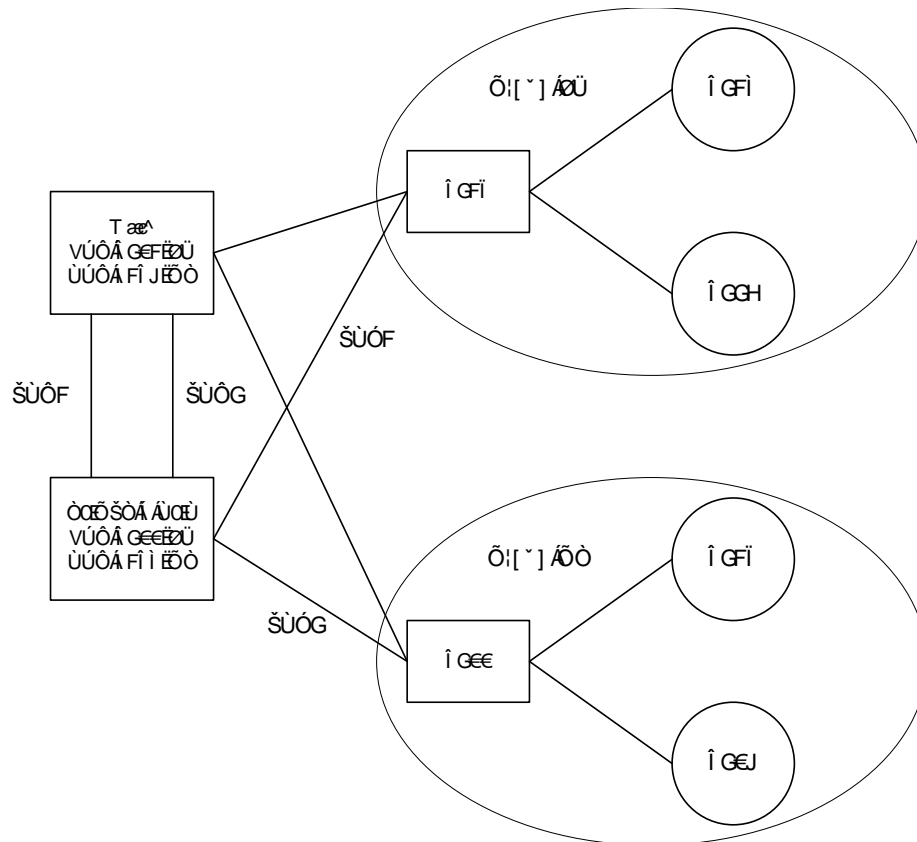

## Gateway Screening Configuration

Gateway screening can be configured in a variety of ways, depending on the criteria you wish to screen the messages for. The examples used in these procedures are based on five example configurations (Figures 2-3 through 2-7). Each example configuration shows the screening order used by the EAGLE 5 SAS, with the screening criteria for each screen, and the order that these screens are added to the database to achieve the screening order, with the command entry required to enter the screening criteria into the database.

Each procedure adding a gateway screening entity to the database contains a table showing the parameters and the data used for the command examples.

**NOTE: The gateway screening rules table can contain a maximum of 360,700 rules.**

**The EAGLE 5 SAS can contain a maximum of 255 screen sets.**

**Each screen set can contain a maximum of 4,000 rules.**

These general rules apply to configuring gateway screening entities in the database. Each procedure contains any rules that are specific to that procedure.

1. The gateway screening feature must be turned on before gateway screening entities can be added to the database. Verify this by entering the `rtrv-feat` command. If the gateway screening feature is off, it can be turned on by entering the `chg-feat:gws=on` command.

**NOTE: Once the gateway screening feature is turned on with the `chg-feat` command, it cannot be turned off**

2. A TSM running the GLS GPL must be configured in the database with the `ent-card:type=tsm:appl=glis:loc=<TSM Card Location>` command. Verify this with the `rtrv-card` command.
3. Changing or removing an existing gateway screening entity will change the screening order for the messages on the linkset. Verify the new screening order before changing or removing any gateway screening entities.
4. If the screen set being added to the database, includes existing screening references, messages in the linkset being screened will be screened against all entries in those screening references. This could allow a message into the EAGLE 5 SAS that was not supposed to be allowed in, or a message blocked from the EAGLE 5 SAS that is supposed to be allowed in. Verify the contents of existing screening references to make sure that you want all messages in the linkset screened against all entries in the existing screening references.



## Gateway Screening (GWS) Overview

5. The gateway screening entity specified by the **nsfi** and **nsr** parameters must be in the database.
6. If the **nsfi** and **nsr** parameters do not reference an existing screening entity, the **nsfi** parameter must be set to **stop** and the **nsr** parameter cannot be specified. When the **nsfi** parameter is set to **stop**, the gateway screening process stops at the specified screen.
7. The **actname** parameter, specifying the gateway screening stop action set assigned to the screen, can only be specified with the **nsfi=stop** parameter.



**CAUTION:** When Gateway Screening is in the screen test mode, as defined by the linkset parameters **gwsa=off** and **gws=on**, any action in the gateway screening stop action set specified by the **actname** parameter at the end of the gateway screening process will be performed.

8. The word **SEAS** cannot be used as a value for the **scrn** parameter of the **ent-scrset**, **dlt-scrset**, and **chg-scrset** commands. The word **SEAS** is used in the **rtrv-ls** command output, in the **SCRN** field, to show gateway linksets created on the SEAS interface. A gateway linkset can only be configured from a SEAS terminal and not from an EAGLE 5 SAS terminal. Gateway linksets can only be displayed from the SEAS interface.
9. When removing gateway screening entities from the database, the specified entity cannot be removed if it is referenced by other gateway screening entities. If it is referenced by other gateway screening entities, either the **nsfi** parameter in those gateway screening entities must be changed to **stop**, or the **nsfi** and **nsr** parameters in the those gateway screening entities must be changed to reference other gateway screening entities.
10. Point code values containing all zeros, shown in the following list, cannot be specified for any gateway screening command:

- ANSI Point Code – 000-000-000
- ITU-I Point Code – 0-000-0

ITU national point codes, both 14-bit and 24-bit, containing all zeros can be specified for any gateway screening command.

11. If the last entry in the specified screening reference is removed from the database, the screening reference is removed from the database. If an attempt is made to display that specified screening reference name (for example, entering the **rtrv-scr-opc:sr=iec** command after removing the last entry in the allowed OPC screen IEC), the following error message is displayed showing that the specified screening reference name could not be found in the database.

E2573 Cmd Rej: SR or NSR does not reference an existing SR

12. The EAGLE 5 SAS screens messages in a hierarchical fashion. For example, allowed OPC screens are checked before blocked OPC screens; blocked OPC screens are checked before allowed SIO screens, and so on. The gateway screening entities must be entered in reverse of the order that the screening process takes place (see Figure 2-2). To add gateway screening entities into the database, the first entity to be entered must be the entity that you want to stop screening the message on. The other entities follow in the proper order and the screen set is the last entity to be added into the database. The screen set entity must be in the database for gateway screening to take place. The following lists shows the order of the MTP gateway screening process and the SCCP gateway screening process and the order that these gateway screening entities must be entered into the database.

MTP Gateway Screening Order		SCCP Gateway Screening Order	
Screening Order	Order of Entry into the Database	Screening Order	Order of Entry into the Database
1. Screen Set	1. Allowed DESTFLD or Allowed ISUP*	1. Screen Set	1. Allowed AFTPC
2. Allowed OPC	2. Blocked DPC	2. Allowed OPC	2. Allowed CDPA
3. Blocked OPC	3. Allowed DPC	3. Blocked OPC	3. Allowed TT
4. Allowed SIO	4. Allowed SIO	4. Allowed SIO	4. Allowed CGPA
5. Allowed DPC	5. Blocked OPC	5. Allowed DPC	5. Blocked DPC
6. Blocked DPC	6. Allowed OPC	6. Blocked DPC	6. Allowed DPC
7. Allowed DESTFLD or Allowed ISUP*	7. Screen Set	7. Allowed CGPA	7. Allowed SIO
		8. Allowed TT	8. Blocked OPC
		9. Allowed CDPA	9. Allowed OPC
		10. Allowed AFTPC	10. Screen Set

\* The allowed ISUP screen can contain ISUP and TUP message types.

Using the **ent-1s** or **chg-1s** commands, the screen set can then be assigned to a linkset and all messages on that linkset are screened for acceptance into the network.

# Gateway Screening (GWS) Overview

Figure 2-2. The Gateway Screening Process

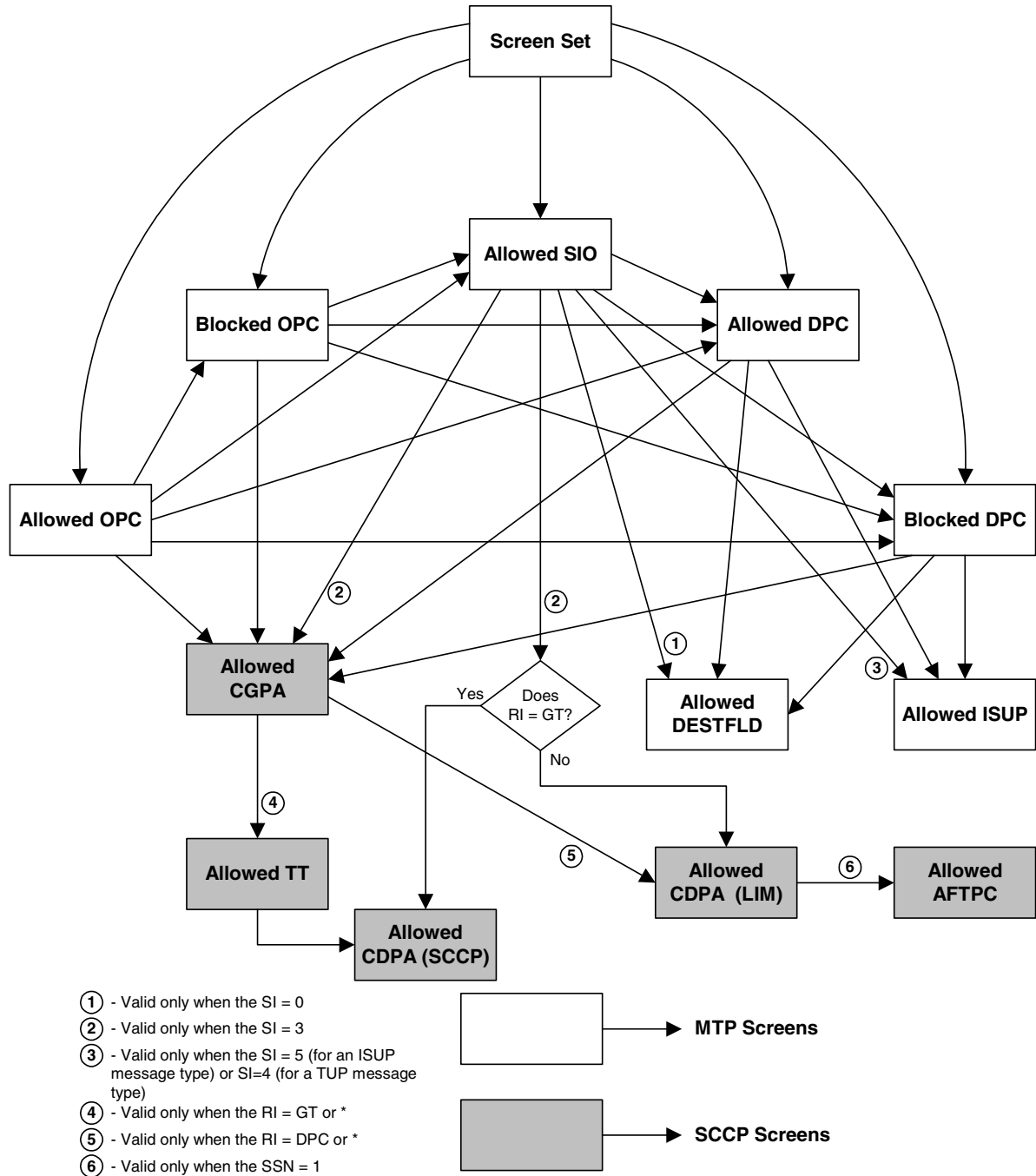

## Gateway Screening Configuration Examples

### Example 1

Example 1 screens the messages in a linkset for the following criteria. Figure 2-3 shows the screening order the EAGLE 5 SAS uses and the order that the screens must be entered into the database.

- Allow into the EAGLE 5 SAS messages containing the following items
  - The OPC 001-001-001
  - The DPC 003-003-003
  - The calling party address (CGPA) 006-006-006, with the subsystem number of 253 and the routing indicator (*ri*) of *dpc* and the SCCP message type of UDT
  - The called party address (CDPA) 003-003-003 with the subsystem number of 001, and the SCMG format ID of 050
  - The allowed affected point code (AFTPC) of 008-008-008 with the subsystem number of 250
- Block from the EAGLE 5 SAS messages containing these items
  - The OPC 001-002-002
  - The DPC 004-004-004
- The message that passes the gateway screening criteria is copied for the STPLAN application (specified with the *actname* parameter and the name of the gateway screening stop action set containing the *COPY* gateway screening stop action).

Figure 2-3. Gateway Screening Configuration - Example 1

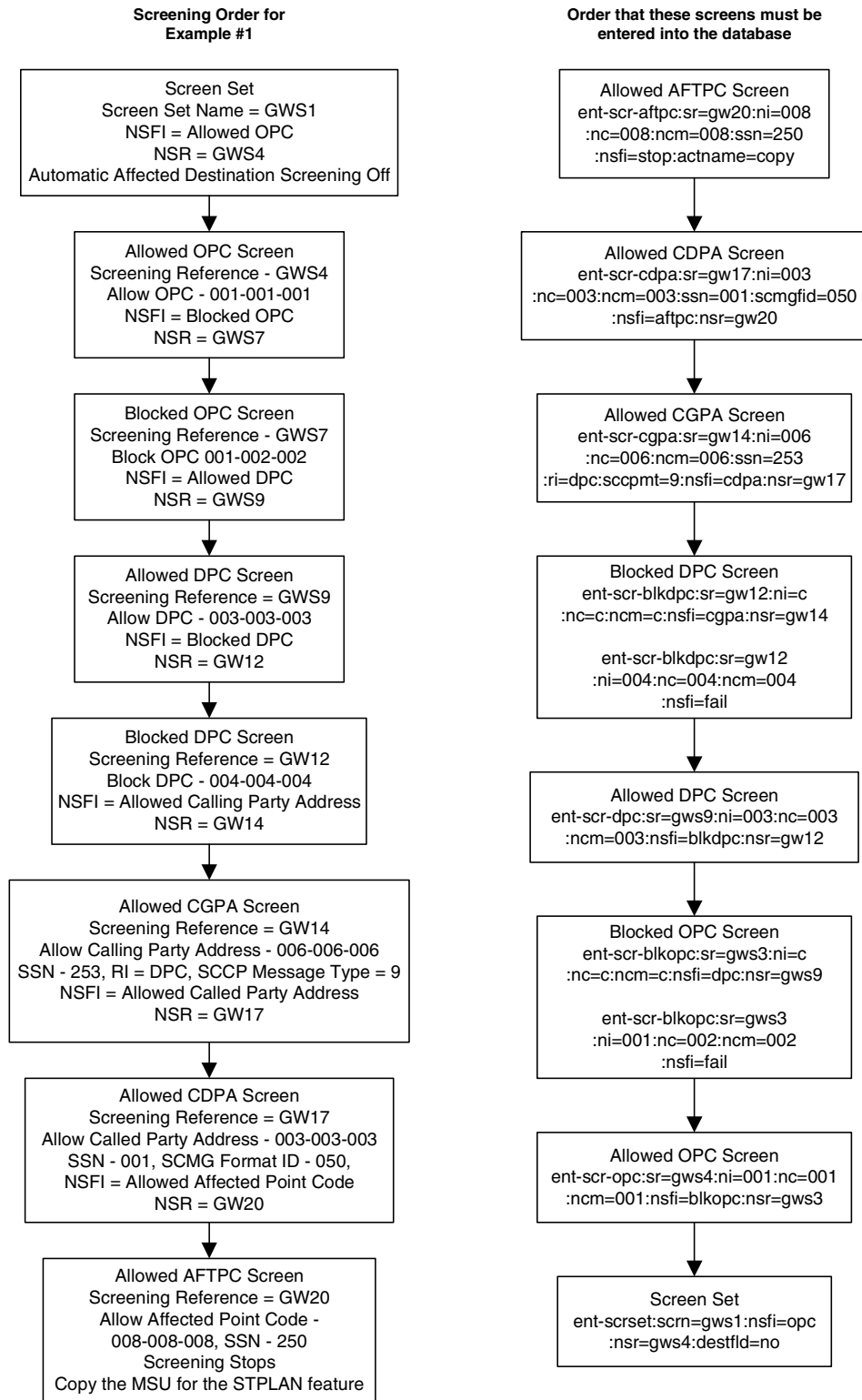

## Example 2

Example 2 screens the messages in a linkset for the following criteria. Figure 2-4 shows the screening order the EAGLE 5 SAS uses and the order that the screens must be entered into the database.

- Allow messages containing the following items into the EAGLE 5 SAS

The following SIO information:

- a. The network indicator code of 2 (**nic=2**)
- b. The service indicator of 3 (**si=3**)
- c. Message priorities ranging from 1 to 3 (**:pri=1&&3**)

The calling party address (CGPA) 7-100-4, with the subsystem number of 254 and the routing indicator (**ri**) of \*, and the SCCP message type of UDTS

The called party address (CDPA) 5-117-2 with the subsystem number of 254

- Block messages containing the OPC 4-250-3 from the EAGLE 5 SAS

## Gateway Screening (GWS) Overview

**Figure 2-4.** Gateway Screening Configuration - Example 2

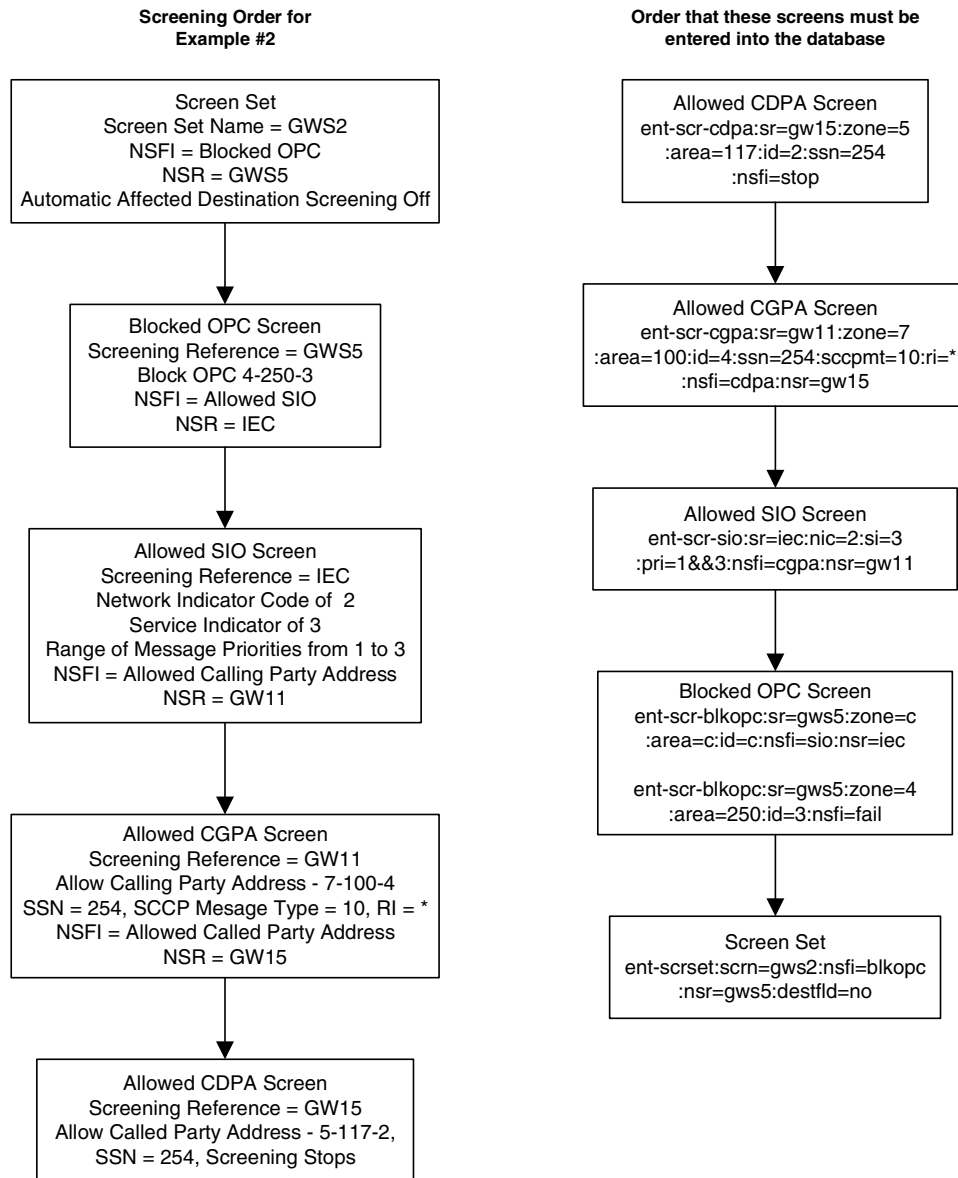

### Example 3

Example 3 screens the messages in a linkset for the following criteria. Figure 2-5 shows the screening order the EAGLE 5 SAS uses and the order that the screens must be entered into the database.

- Allow into the EAGLE 5 SAS messages containing the following items
  - The DPCs from 070-070-025 to 070-070-135
  - The calling party address (CGPA) 007-007-007, with the subsystem number of 250 and the routing indicator (**ri**) of **gt** and the SCCP Message type of XUDT
  - The translation type (TT) 250
  - The called party address (CDPA) 006-006-006 with the subsystem number of 253
- Block messages containing the DPC 005-005-005 from the EAGLE 5 SAS
- Automatic Destination Field screening is on.



# Gateway Screening (GWS) Overview

**Figure 2-5. Gateway Screening Configuration - Example 3**

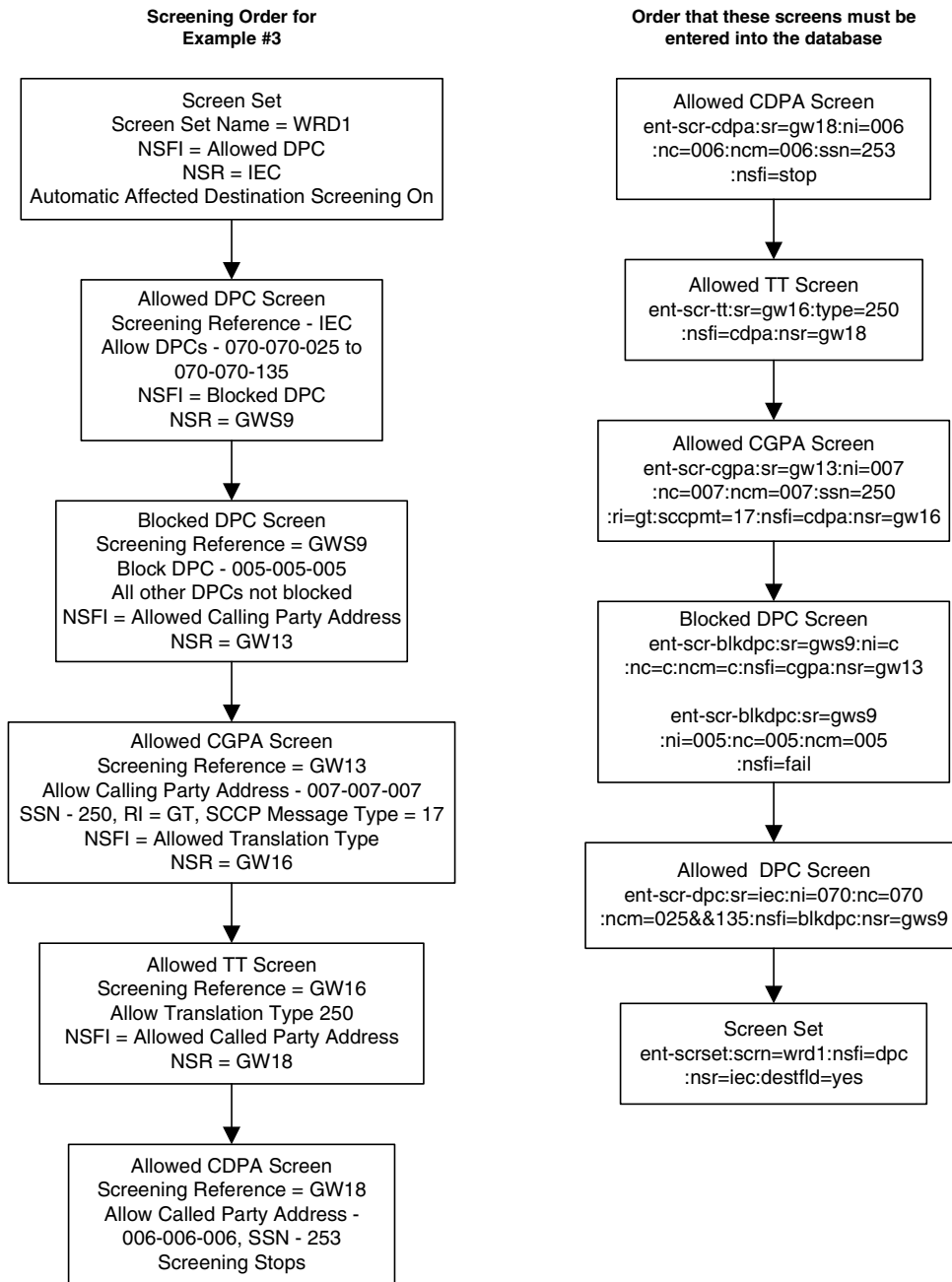

### Example 4

Example 4 screens the messages in a linkset for the following criteria. Figure 2-6 shows the screening order the EAGLE 5 SAS uses and the order that the screens must be entered into the database.

- Allow messages containing the following items into the EAGLE 5 SAS

The following SIO information:

- a. The network indicator code of 2 (**nic=2**)
- b. The service indicator of 3 (**si=3**)
- c. Message priority of 3 (**pri=3**)

The called party address (CDPA) 007-007-007 with the subsystem number of 001 and SCMG format ID of 100

The allowed affected point code (AFTPC) of 010-010-010 with the subsystem number of 015

- The message that passes the gateway screening criteria is copied for the STPLAN application (specified with the **actname** parameter and the name of the gateway screening stop action set containing the **COPY** gateway screening stop action).
- Automatic Destination Field screening is on.

## Gateway Screening (GWS) Overview

Figure 2-6. Gateway Screening Configuration - Example 4

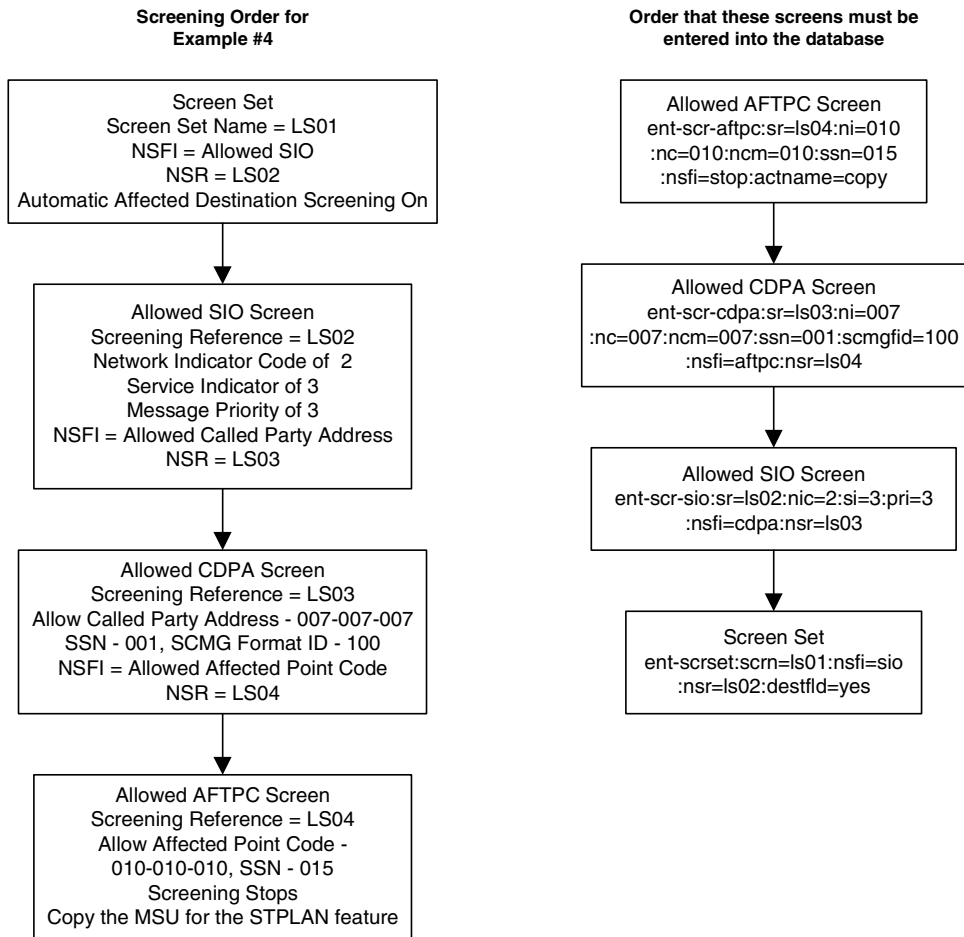

### Example 5

Example 5 screens the messages in a linkset for the following criteria. Figure 2-7 shows the screening order the EAGLE 5 SAS uses and the order that the screens must be entered into the database.

- Allow into the EAGLE 5 SAS messages containing the following items
  - The OPC 010-010-010
  - The following SIO information:
    - a. The network indicator code of 2 (**nic=2**)
    - b. The service indicator of 0 (**si=0**)
    - c. Heading code 0 of 4 (**h0=4**)
    - d. Heading code 1 of 5 (**h1=5**)
    - e. Message priority of 3 (**pri=3**)
  - The allowed affected destination field (DESTFLD) of 100-100-100
- Block messages containing the OPC 020-020-020 from the EAGLE 5 SAS
- The message that passes the gateway screening criteria is copied for the STPLAN application and is redirected for the gateway screening redirect function (specified with the **actname** parameter and the name of the gateway screening stop action set containing the **COPY** and **RDCT** gateway screening stop actions).

# Gateway Screening (GWS) Overview

**Figure 2-7. Gateway Screening Configuration - Example 5**

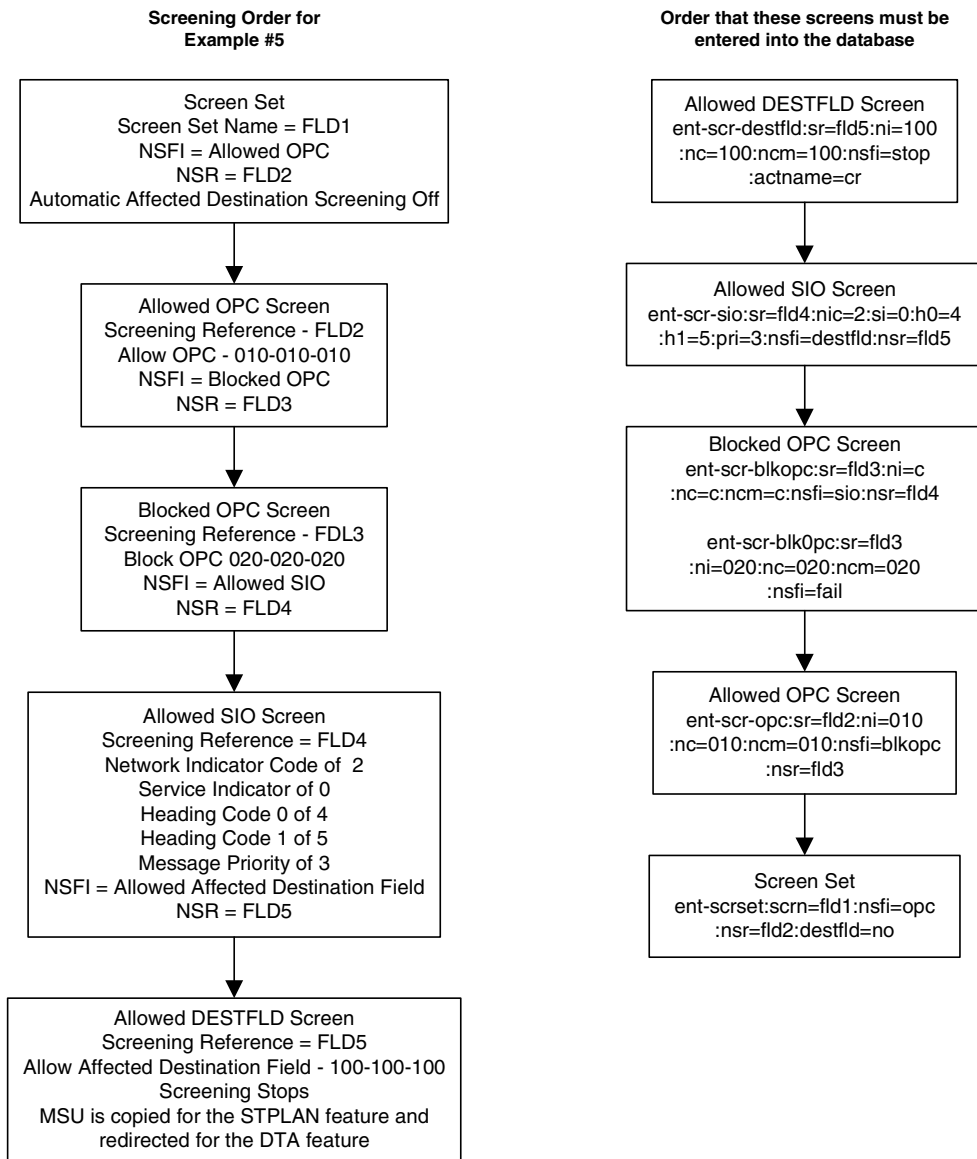

### Example 6

Example 6 screens the messages in a linkset for the following criteria. Figure 2-8 shows the screening order the EAGLE 5 SAS uses and the order that the screens must be entered into the database.

- Allow into the EAGLE 5 SAS messages containing the following items
  - The OPC 015-015-015
  - The following SIO information:
    - a. The network indicator code of 2 (**nic=2**)
    - b. The service indicator of 5 (**si=5**)
    - c. Message priority of 3 (**pri=3**)
  - The allowed ISUP message type (ISUP) of 135
- Block messages containing the OPC 025-025-025 from the EAGLE 5 SAS
- The message that passes the gateway screening criteria is copied for the STPLAN application and is redirected for the gateway screening redirect function (specified with the **actname** parameter and the name of the gateway screening stop action set containing the **COPY** and **RDCT** gateway screening stop actions).

# Gateway Screening (GWS) Overview

**Figure 2-8.** Gateway Screening Configuration - Example 6

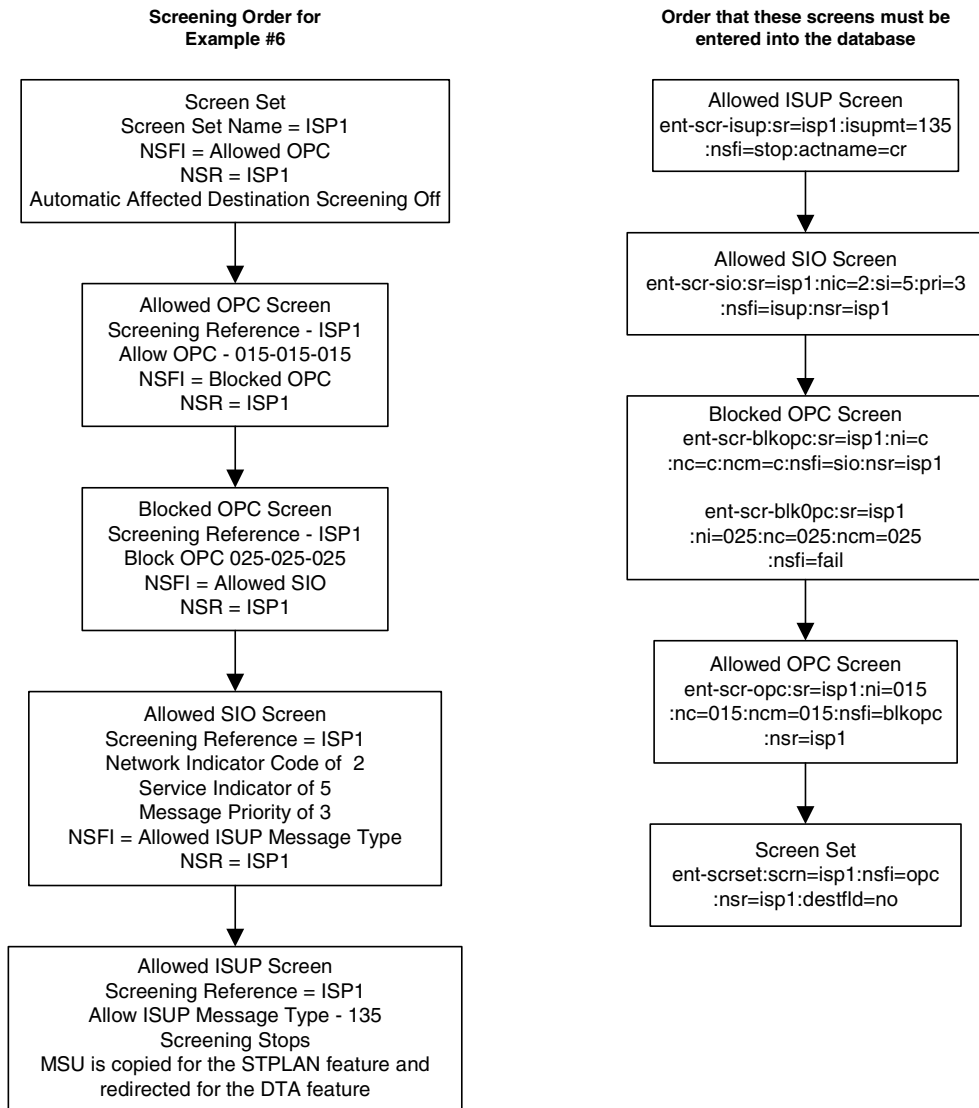

**Example 7**

Example 7 screens the messages in a linkset for the following criteria. Figure 2-9 shows the screening order the EAGLE 5 SAS uses and the order that the screens must be entered into the database.

- Allow into the EAGLE 5 SAS messages containing the following items:
  - TUP messages containing these items:
    - The OPC 017-017-017
    - The DPC 050-034-049
    - The following SIO information:
      - a. The network indicator code of 2 (**nic=2**)
      - b. The service indicator of 4 (**si=4**)
      - c. Message priority of 3 (**pri=3**)
    - The allowed TUP message type of 100
  - ISUP messages containing these items:
    - The OPC 017-017-017
    - The DPC 073-200-059
    - The following SIO information:
      - a. The network indicator code of 2 (**nic=2**)
      - b. The service indicator of 5 (**si=5**)
      - c. Message priority of 3 (**pri=3**)
    - The allowed ISUP message type of 139
- The messages, both TUP and ISUP, that pass the gateway screening criteria are copied for the STPLAN application and are redirected for the gateway screening redirect function (specified with the **actname** parameter and the name of the gateway screening stop action set containing the **COPY** and **RDCT** gateway screening stop actions).



# Gateway Screening (GWS) Overview

**Figure 2-9.** Gateway Screening Configuration - Example 7

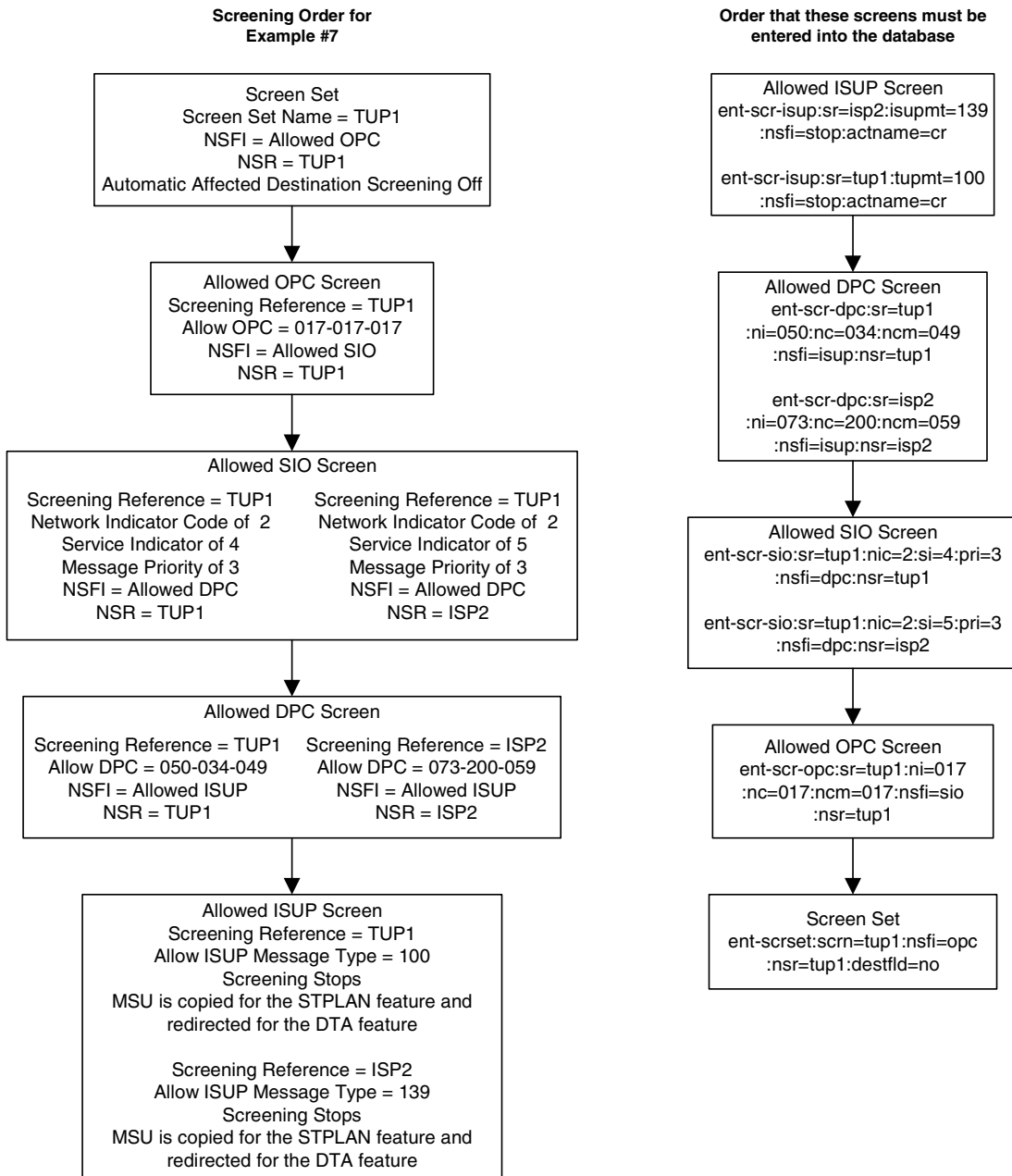

## Adding an GLS Card

This procedure is used to add a TSM running the GLS GPL to support the gateway screening feature using the **ent-card** command. The **ent-card** command uses these parameters.

- :loc** – The location of the card being added to the database.
- :type** – The type of card being added to the database. For this procedure, the value of this parameter is **tsm**.
- :app1** – The application software or GPL that is assigned to the card. For this procedure, the value of this parameter is **gls**.
- :force** – Allow the LIM to be added to the database even if there are not enough cards running the SCCP GPL (either TSM or DSM) to support the number of LIMs in the EAGLE 5 SAS. This parameter is obsolete and is no longer used.

The shelf to which the card is to be added, must already be in the database. This can be verified with the **rtrv-shlf** command. If the shelf is not in the database, see the “Adding a Shelf” procedure in the *Database Administration Manual – System Management*.

The card cannot be added to the database if the specified card location already has a card assigned to it.

Before the TSM can be configured in the database for the gateway screening feature, the gateway screening feature must be turned on with the **chg-feat** command. The **rtrv-feat** command can verify that the gateway screening feature is on.

**NOTE: Once the gateway screening feature is turned on with the **chg-feat** command, they cannot be turned off.**

The EAGLE 5 SAS can contain a maximum of 8 TSMs running the GLS GPL.

The examples in this procedure are used to add a TSM running the GLS GPL in card slot 1214 to the database.

**Procedure**

---

1. Display the cards in the EAGLE 5 SAS using the `rtrv-card` command. This is an example of the possible output. Cards should be distributed throughout the EAGLE 5 SAS for proper power distribution. Refer to the *Installation Manual - EAGLE 5 SAS* for the shelf power distribution. This is an example of the possible output.

```
rlghncxa03w 05-09-25 09:58:31 GMT EAGLE5 34.0.0
CARD  TYPE      APPL      LSET NAME      LINK SLC  LSET NAME      LINK SLC
1101  TSM          SCCP
1102  TSM          GLS
1113  GPSM        EOAM
1114  TDM-A
1115  GPSM        EOAM
1116  TDM-B
1117  MDAL
1201  LIMDS0      SS7ANSI    sp2           A      0      sp1           B      0
1203  LIMDS0      SS7ANSI    sp3           A      0
1204  LIMDS0      SS7ANSI    sp3           A      1
1206  LIMDS0      SS7ANSI    nsp3          A      1      nsp4          B      1
1207  LIMV35      SS7GX25    nsp1          A      0
1208  LIMV35      SS7GX25    nsp1          A      1
1216  ACMENET     STPLAN
1308  LIMDS0      SS7ANSI    sp6           A      1      sp7           B      0
1314  LIMDS0      SS7ANSI    sp7           A      1      sp5           B      1
1317  ACMENET     STPLAN
```

If the **APPL** field of the `rtrv-card` command output shows cards assigned to the **GLS** GPL, skip steps 2, and 3, and go to step 4.

---

2. Verify that the gateway screening feature is on, by entering the `rtrv-feat` command. If the gateway screening feature is on, the **GWS** field should be set to **on**. For this example, the gateway screening feature is off.

**NOTE:** The `rtrv-feat` command output contains other fields that are not used by this procedure. If you wish to see all the fields displayed by the `rtrv-feat` command, see the `rtrv-feat` command description in the *Commands Manual*.

If the gateway screening feature is on, skip steps 3 and go to step 4. If the gateway screening feature is not on, go to step 3.

---

3. If the gateway screening feature is not on, shown by the **GWS = off** entry in the `rtrv-feat` command output in step 2, turn the gateway screening feature on by entering this command.

```
chg-feat:gws=on
```

**NOTE:** Once the gateway screening feature is turned on with the `chg-feat` command, it cannot be turned off.

When the `chg-feat` has successfully completed, this message should appear.

```
rlghncxa03w 05-09-25 15:27:30 GMT EAGLE5 34.0.0
CHG-FEAT: MASP A - COMPLTD
```

---

4. Verify that the TSM has been physically installed into the proper location.
- 

5. Add the TSM to the database using the **ent-card** command. For this example, enter this command.

```
ent-card:loc=1212:type=tsm:appl=gls
```

When each of these commands have successfully completed, this message should appear.

```
rlghncxa03w 05-09-25 15:28:30 GMT EAGLE5 34.0.0
ENT-CARD: MASP A - COMPLTD
```

---

6. Verify the changes using the **rtrv-card** command with the card location specified. For this example, enter this command.

```
rtrv-card:loc=1212
```

This is an example of the possible output.

```
rlghncxa03w 05-09-25 15:29:30 GMT EAGLE5 34.0.0
CARD   TYPE      APPL      LSET NAME      LINK SLC  LSET NAME      LINK SLC
1212   TSM          GLS
```

---

7. Backup the new changes using the **chg-db:action=backup:dest=fixed** command. These messages should appear, the active Maintenance and Administration Subsystem Processor (MASP) appears first.

```
BACKUP (FIXED) : MASP A - Backup starts on active MASP.
BACKUP (FIXED) : MASP A - Backup on active MASP to fixed disk complete.
BACKUP (FIXED) : MASP A - Backup starts on standby MASP.
BACKUP (FIXED) : MASP A - Backup on standby MASP to fixed disk complete.
```

---

Flowchart 2-1. Adding an GLS Card to the Database

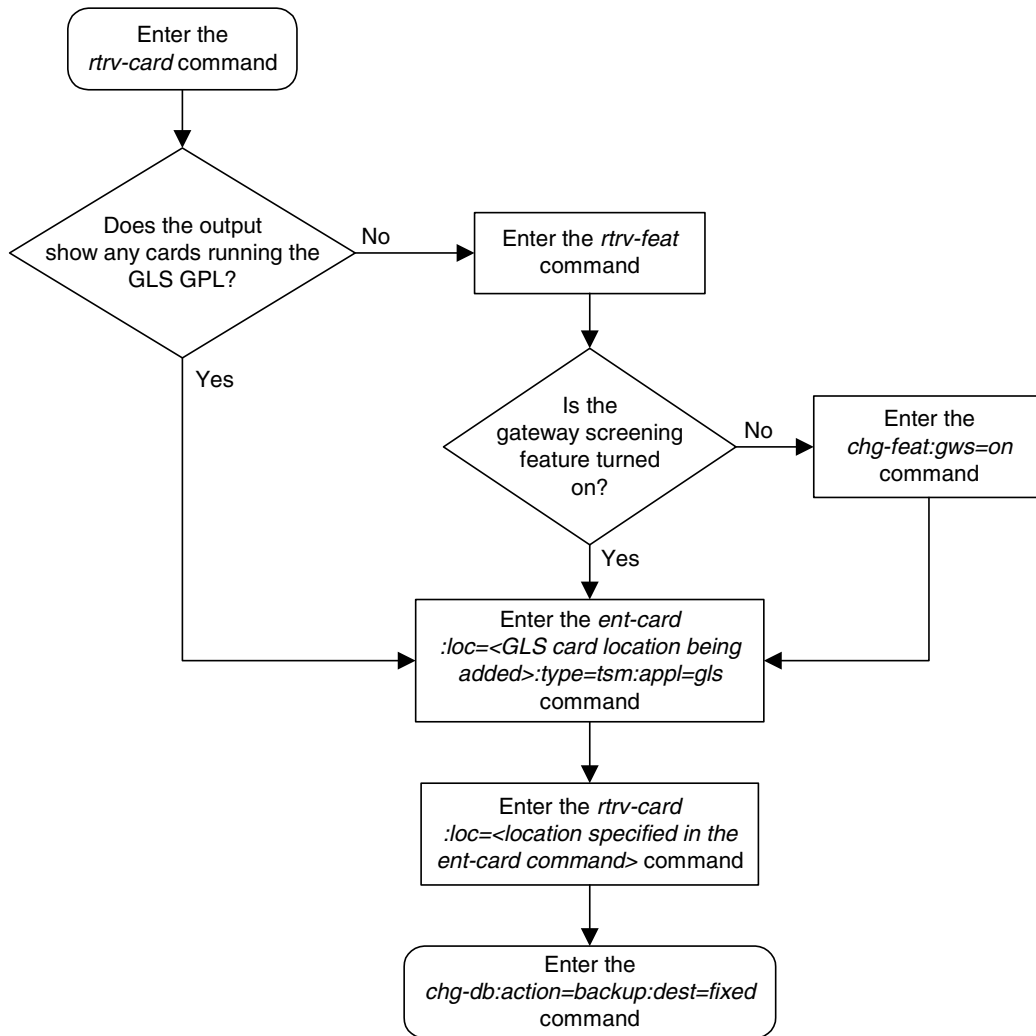

## Removing a GLS Card

This procedure is used to remove GLS cards, used by gateway screening, from the database using the `dlc-card` command. The card cannot be removed if it does not exist in the database.



**CAUTION:** If the GLS card is the last GLS card in service, removing this card from the database will disable the gateway screening feature.

The examples in this procedure are used to remove the GLS card in card location 1205.

### Canceling the `REPT-STAT-CARD` Command

Because the `rept-stat-card` command used in this procedure can output information for a long period of time, the `rept-stat-card` command can be canceled and the output to the terminal stopped. There are three ways that the `rept-stat-card` command can be canceled.

- Press the **F9** function key on the keyboard at the terminal where the `rept-stat-card` command was entered.
- Enter the `canc-cmd` without the `trm` parameter at the terminal where the `rept-stat-card` command was entered.
- Enter the `canc-cmd:trm=<xx>`, where `<xx>` is the terminal where the `rept-stat-card` command was entered, from another terminal other than the terminal where the `rept-stat-card` command was entered. To enter the `canc-cmd:trm=<xx>` command, the terminal must allow Security Administration commands to be entered from it and the user must be allowed to enter Security Administration commands. The terminal's permissions can be verified with the `rtrv-secu-trm` command. The user's permissions can be verified with the `rtrv-user` or `rtrv-secu-user` commands.

For more information about the `canc-cmd` command, go to the *Commands Manual*.

## Procedure

---

1. Display the cards in the database using the **rtrv-card** command. This is an example of the possible output.

```
rlghncxa03w 05-09-25 09:58:31 GMT EAGLE5 34.0.0
CARD  TYPE      APPL      LSET NAME      LINK SLC  LSET NAME      LINK SLC
1101  TSM          SCCP
1102  TSM          GLS
1103  ACMENET     STPLAN
1104  ACMENET     STPLAN
1113  GPSM        EOAM
1114  TDM-A
1115  GPSM        EOAM
1116  TDM-B
1117  MDAL
1201  LIMDS0      SS7ANSI    lsn1           A    0    lsn2           B    1
1202  LIMV35      SS7GX25    lsngwy         A    0
1203  LIMV35      SS7ANSI    lsn2           A    0    lsn1           B    1
1205  TSM          GLS
```

---

2. Display the cards that are in service with the **rept-stat-card:stat=nr** command.

**rept-stat-card:stat=nr**

This is an example of the possible output.

```
rlghncxa03w 05-09-25 15:26:30 GMT EAGLE5 34.0.0
CARD  VERSION      TYPE      APPL      PST          SST          AST
1101  110-003-000    TSM      SCCP      IS-NR        Active       ---
1102  110-003-000    TSM      GLS        IS-NR        Active       ---
1103  110-002-000    ACMENET  STPLAN    IS-NR        Active       ---
1104  110-002-000    ACMENET  STPLAN    IS-NR        Active       ---
1109  109-003-000    HMUX     BPHMUX    IS-NR        Active       ---
1110  109-003-000    HMUX     BPHMUX    IS-NR        Active       ---
1201  110-003-000    LIMDS0   SS7ANSI    IS-NR        Active       ---
1202  110-002-000    LIMV35   SS7GX25    IS-NR        Active       ---
1203  110-003-000    LIMV35   SS7ANSI    IS-NR        Active       ---
1205  110-003-000    TSM      GLS        IS-NR        Active       ---
1209  109-003-000    HMUX     BPHMUX    IS-NR        Active       ---
1210  109-003-000    HMUX     BPHMUX    IS-NR        Active       ---
```

---

- An GLS card is identified by the entry **GLS** in the **APPL** fields in the outputs in steps 1 and 2. Remove the card from service using the **rmv-card** command and specifying the card location. If the GLS card to be inhibited is the only GLS card in service, shown in step 2, the **force=yes** parameter must also be specified. For this example, enter this command.

```
rmv-card:loc=1205
```

When this command has successfully completed, this message should appear.

```
rlghncxa03w 05-09-25 15:27:30 GMT EAGLE5 34.0.0
Card has been inhibited.
```

---

- Remove the card from the database using the **dlt-card** command. The **dlt-card** command has only one parameter, **loc**, which is the location of the card. For this example, enter this command.

```
dlt-card:loc=1205
```

When this command has successfully completed, this message should appear.

```
rlghncxa03w 05-09-25 15:28:30 GMT EAGLE5 34.0.0
DLT-CARD: MASP A - COMPLTD
```

---

- Verify the changes using the **rtrv-card** command specifying the card that was removed in step 4. For this example, enter this command.

```
rtrv-card:loc=1205
```

When this command has successfully completed, this message should appear.

```
E2144 Cmd Rej: Location invalid for hardware configuration
```

---

- Backup the new changes using the **chg-db:action=backup:dest=fixed** command. These messages should appear, the active Maintenance and Administration Subsystem Processor (MASP) appears first.

```
BACKUP (FIXED) : MASP A - Backup starts on active MASP.
BACKUP (FIXED) : MASP A - Backup on active MASP to fixed disk complete.
BACKUP (FIXED) : MASP A - Backup starts on standby MASP.
BACKUP (FIXED) : MASP A - Backup on standby MASP to fixed disk complete.
```

---



Flowchart 2-2. Removing a GLS Card

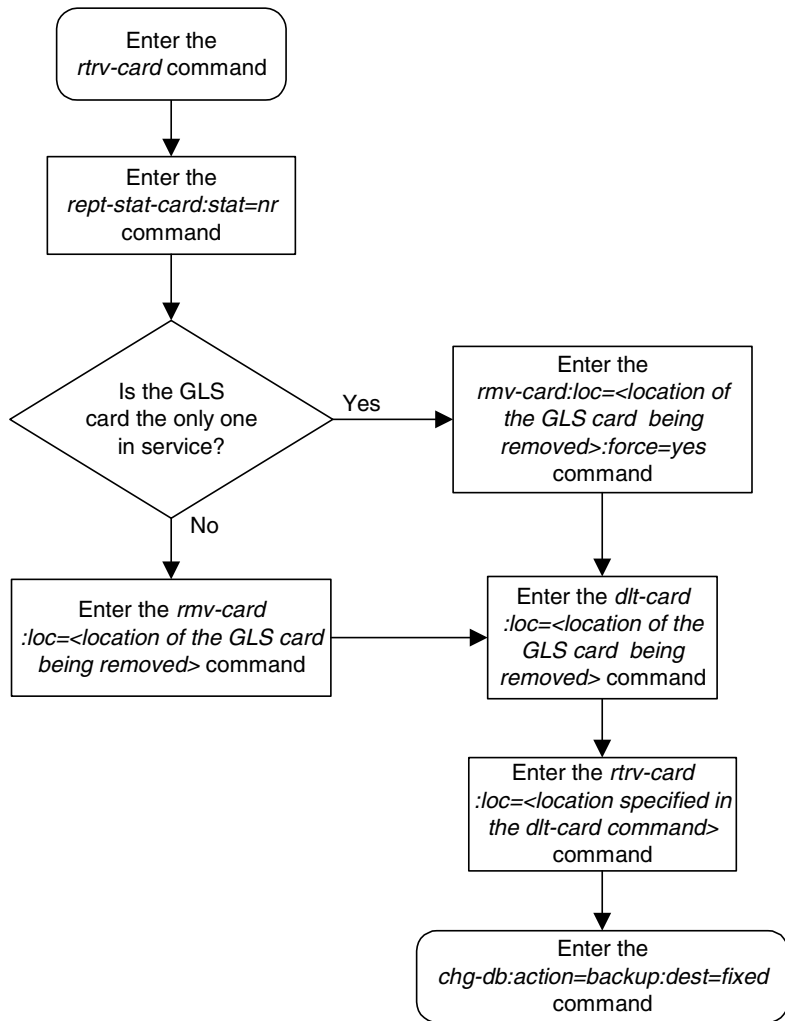

## Configuring Gateway Screening Stop Action Sets

This procedure is used to add a gateway screening stop action set to the database or change an existing gateway screening stop action set using the `chg-gws-actset` command.

The gateway screening stop action sets define the actions that are performed on the MSU when the gateway screening process has stopped. These gateway screening stop action sets replace the `copy` and `redirect` parameters that have been used with the gateway screening commands when the gateway screening process stops.

The database can contain a maximum of 16 gateway screening stop action sets, with each set containing a maximum of 10 gateway screening stop actions. Five gateway screening stop actions have been defined.

- `COPY` – copy the MSU for the STP LAN feature
- `RDCT` – redirect the MSU for the DTA feature
- `CNCF` – convert the PIP parameter with the GN parameter or the GN parameter with the PIP parameter in the ISUP IAM message for the Calling Name Conversion Facility feature.
- `TLNP` – ISUP IAMs that pass gateway screening are processed either by the ISUP NP with EPAP feature or by the Triggerless LNP feature. This gateway screening stop action is discussed in more detail in the “Configuring TLNP Gateway Screening Stop Action Sets” procedure on page 2-65.
- `NONE` – no action is performed on the MSU



**CAUTION:** When Gateway Screening is in the screen test mode, as defined by the linkset parameters `gwsa=off` and `gws=on`, any action in the gateway screening stop action sets created in this procedure will be performed.

The `chg-gws-actset` command uses these parameters.

**:actid** – The ID number of the gateway screening stop action set. The value of this parameter is from 4 to 16.

**:actname** – The name of the gateway screening stop action set consisting of 1 alphabetic character followed by up to 5 alphanumeric characters.

**:force** – The `force=yes` parameter must be specified when changing the gateway screening stop actions of an existing gateway screening stop action set.

**:all=none** – sets the value of each gateway screening stop action in the gateway screening stop action set to `none`.

## Gateway Screening (GWS) Overview

:act1 to :act10 – The ten gateway screening stop actions for each gateway screening stop action set. Gateway screening stop action 1 (act1) is the first stop action to be performed and gateway screening stop action 10 (act10) is the last stop action to be performed on the MSU.

The first three gateway screening stop action sets (actid=1, actid=2, and actid=3) are already defined with the existing gateway screening stop actions shown in Table 2-9 and Table 2-10.

**Table 2-9.** Gateway Screening Stop Action Definitions If the CNCF Feature Is Off

Gateway Screening Stop Action ID	Gateway Screening Stop Action Set Name	Stop Action 1	Stop Action 2	Action Performed by the EAGLE 5 SAS
1	copy	copy	—	copy the MSU for the STP LAN feature
2	rdct	rdct	—	redirect the MSU for the DTA feature
3	cr	copy	rdct	copy the MSU for the STP LAN feature and redirect the MSU for the DTA feature

**Table 2-10.** Gateway Screening Stop Action Definitions If the CNCF Feature Is On

Gateway Screening Stop Action ID	Gateway Screening Stop Action Set Name	Stop Action 1	Stop Action 2	Action Performed by the EAGLE 5 SAS
1	copy	copy	—	copy the MSU for the STP LAN feature
2	cncf	cncf	—	convert the PIP parameter with the GN parameter or the GN parameter with the PIP parameter in the ISUP IAM message for the Calling Name Conversion Facility feature.
3	cpcncf	copy	cncf	copy the MSU for the STP LAN feature and convert the PIP parameter with the GN parameter or the GN parameter with the PIP parameter in the ISUP IAM message for the Calling Name Conversion Facility feature.

The word **none** cannot be used for the **actname** parameter.

No other optional parameters can be specified **a11=none** parameter.

The **force=yes** parameter must be specified when changing an existing gateway screening stop action set.

If the **cncf** value is specified for the **act1** through **act10** parameters, the CNCF feature must be on. This can be verified with the **rtrv-feat** command. The **cncf=on** field in the **rtrv-feat** command output shows that the CNCF feature is on.

If the **copy** gateway screening action is specified with the **chg-gws-actset** command, it must be specified with the **act1** parameter.

A specific gateway screening stop action can only be specified once in a specific gateway screening stop action set. For example, the **chg-gws-actset** command cannot be executed if the **copy** gateway screening stop action is specified for gateway screening stop action parameters **act1** and **act2** as shown in this command example.

```
chg-gws-actset:actid=4:act1=copy:act2=copy
```

The gateway screening stop action set can only have one **copy**, **cncf**, **rdct**, or **t1np** gateway screening stop action.

The value of the **actname** parameter must be unique. The value of this parameter is used by the **actname** parameter in the gateway screening commands and is shown in the **NSR/ACT** field of the outputs of the retrieve gateway screening commands to define the action that is performed on the MSU that passes gateway screening.

If the redirect gateway screening action (**rdct**) is specified with other gateway screening stop actions, it must be specified with the last gateway screening stop action parameter specified with the **chg-gws-actset** command. For example, the **chg-gws-actset** command is specified with three gateway screening stop actions (using parameters **act1**, **act2**, and **act3**) with one of the stop actions being the redirect gateway screening stop action. The redirect gateway screening stop action must be specified with the **act3** parameter.

When a gateway screening stop action set is being entered in to the database for the first time, the name of the gateway screening stop action set (**actname**) must be added to the database before any gateway screening stop actions are assigned to the gateway screening stop action set.

The **t1np** gateway screening stop action cannot be specified with either the **cncf** (calling name conversion facility) or **rdct** (redirect) gateway screening actions in the same gateway screening action set.

## Gateway Screening (GWS) Overview

The examples in this procedure are used to create four new gateway screening stop action sets. The CNCF feature is not on.

**Table 2-11.** Sample Gateway Screening Stop Action Set Configuration

ACTID	ACTNAME	ACT1	ACT2	ACT3
4	CNCF	cncf	—	—
5	CPCNCF	copy	cncf	—
6	CNCFRD	cncf	rdct	—
7	CPCFRD	copy	cncf	rdct

### Procedure

---

1. Verify that the gateway screening feature is turned on, by entering the `rtrv-feat` command. If the gateway screening feature is turned on, the `GWS` field should be set to `on`. In this example, the gateway screening feature is off.

**NOTE:** The `rtrv-feat` command output contains other fields that are not used by this procedure. If you wish to see all the fields displayed by the `rtrv-feat` command, see the `rtrv-feat` command description in the *Commands Manual*.

If the gateway screening feature is turned on, go to step 3.

2. If the gateway screening feature is not turned on, shown by the `GWS = off` entry in the `rtrv-feat` command output in step 1, turn it on by entering this command.

```
chg-feat:gws=on
```

**NOTE:** Once the gateway screening feature is turned on with the `chg-feat` command, it cannot be turned off.

When this command has successfully completed, this message should appear.

```
rlghncxa03w 05-09-25 15:26:30 GMT EAGLE5 34.0.0  
CHG-FEAT: MASP A - COMPLTD
```

---

- Display the gateway screening stop action sets in the database with the `rtrv-gws-actset` command. Action IDs 1, 2, and 3 are predefined and cannot be changed. Action ID 1 contains only the COPY stop action. Action ID 2 contains either the RDCT or CNCF stop action. Action ID 3 contains the COPY and either the RDCT or CNCF stop actions as shown in the following output examples.

```
rlghncxa03w 05-09-25 15:28:30 GMT EAGLE5 34.0.0
ACT ACT ACT ACT ACT ACT ACT ACT ACT ACT ACT
ID NAME 1 2 3 4 5 6 7 8 9 10
-- -----
1 copy copy
2 cncf cncf
3 cpncf copy cncf
GWS action set table is (3 of 16) 19% full
```

```
rlghncxa03w 05-09-25 15:27:30 GMT EAGLE5 34.0.0
ACT ACT ACT ACT ACT ACT ACT ACT ACT ACT ACT
ID NAME 1 2 3 4 5 6 7 8 9 10
-- -----
1 copy copy
2 rdct rdct
3 cr copy rdct
GWS action set table is (3 of 16) 19% full
```

---

**NOTE:** If the CNCF stop action is shown in the `rtrv-gws-actset` output in step 3, or if the `rtrv-feat` output in step 1 shows that the CNCF feature is on, skip this step and go to step 5.

- If the calling name conversion facility feature is not turned on, shown by the `CNCF = off` entry in the `rtrv-feat` command output in step 1, turn it on by entering this command.

```
chg-feat:cncf=on
```

**NOTE:** Once the calling name conversion facility feature is turned on with the `chg-feat` command, it cannot be turned off.

When this command has successfully completed, this message should appear.

```
rlghncxa03w 05-09-25 15:29:30 GMT EAGLE5 34.0.0
CHG-FEAT: MASP A - COMPLTD
```

---

5. Add the gateway screening stop action to the database by using the **chg-gws-actset** command. For this example, enter these commands based on the sample configuration shown in Table 2-11.

```
chg-gws-actset:actid=4:actname=cncf:act1=cncf
chg-gws-actset:actid=5:actname=cpcncf:act1=copy:act2=cncf
chg-gws-actset:actid=6:actname=cncfrd:act1=cncf:act2=rdct
chg-gws-actset:actid=7:actname=cpcfrd:act1=copy:act2=cncf
:act3=rdct
```

If you wish to remove the gateway screening stop actions from an existing gateway screening stop action set (stop action sets 4 through 16), enter the **chg-gws-actset** command with the **all=none**, **actid**, and **force=yes** parameters, as shown in this command example.

```
chg-gws-actset:actid=4:all=none:force=yes
```

If you wish to remove individual gateway screening stop actions from an existing gateway screening stop action set (stop action sets 4 through 16), enter the **chg-gws-actset** command with the stop action parameter (**act1** through **act10**) value equal to **none** and the **force=yes** parameter, as shown in this command example.

```
chg-gws-actset:actid=4:act1=none:force=yes
```

If an existing gateway screening stop action set is being changed, the **force=yes** parameter must be specified with the **chg-gws-actset** command.

The **force=yes** parameter can be specified with the **chg-gws-actset** command if a new GWS stop action set is being created, but is not necessary.

The **CNCF** feature must be on to specify the **CNCF** GWS stop action.

The **actname** parameter must be specified for a new GWS stop action set.

The **actname** parameter is not required, but can be specified, if an existing stop action set is being changed.

If the **actname** parameter value is different from what is shown in the **rtrv-gws-actset** output for the GWS stop action set being changed, the name of the GWS stop action set will be changed to the new **actname** parameter value (see the first Caution).



**CAUTION:** Changing the name of an existing GWS stop action set will prevent the actions defined in the GWS stop action set from being used to process the MSUs that pass gateway screening. If the name of the GWS stop action set is changed, enter the gateway screening retrieve commands (**rtrv-scrset**, **rtrv-scr-opc**, **rtrv-scr-blkopc**, **rtrv-scr-sio**, **rtrv-scr-dpc**, **rtrv-scr-blkdpc**, **rtrv-scr-destfld**, **rtrv-scr-isup**, **rtrv-scr-cgpa**, **rtrv-scr-tt**, **rtrv-scr-cdpa**, and **rtrv-scr-aftpc**) with the **actname** parameter and the old GWS stop action set name to identify the screens that need to be changed to use the new GWS stop action set name. To change these screens, perform the appropriate procedures in Chapters 3 through 15 in this manual.



**CAUTION:** Caution must be used when changing the stop actions in existing gateway screening stop action sets because these gateway screening stop action sets may be used by one or more gateway screening rules. Changes in the existing gateway screening stop action sets will change how MSUs that pass gateway screening are processed.



**CAUTION:** Caution must be used when specifying the RDCT stop action in an existing GWS stop action set. Specifying the RDCT stop action for Allowed OPC screens containing the adjacent point code of a linkset, for Allowed SIO screens containing the service indicator values 1 (SI=1) or 2 (SI=2), or for Allowed DPC screens containing the EAGLE 5 SAS's point code can cause signaling link failures. To verify whether or not the GWS stop action set name used in this procedure is referenced by these screens, enter the `rtrv-scr-opc`, `rtrv-scr-sio`, or `rtrv-scr-dpc` commands, with the `actname` parameter and the GWS stop action set name used in this procedure.

When each of these commands have successfully completed, this message should appear.

```
rlghncxa03w 05-09-25 15:30:30 GMT EAGLE5 34.0.0
CAUTION: GWS action set may be referenced by one or more GWS rules
CHG-GWS-ACTSET: MASP A - COMPLTD
```

- Verify the changes using the `rtrv-gws-actset` command. This is an example of the possible output.

```
rlghncxa03w 05-09-25 15:31:30 GMT EAGLE5 34.0.0
ACT ACT ACT ACT ACT ACT ACT ACT ACT ACT
ID NAME 1 2 3 4 5 6 7 8 9 10
-- -----
1 copy copy
2 rdct rdct
3 cr copy rdct
4 cncf cncf
5 cpcncf copy cncf
6 cncfrd cncf rdct
7 cpcfird copy cncf rdct
```

GWS action set table is (7 of 16) 44% full

- Backup the new changes using the `chg-db:action=backup:dest=fixed` command. These messages should appear, the active Maintenance and Administration Subsystem Processor (MASP) appears first.

```
BACKUP (FIXED) : MASP A - Backup starts on active MASP.
BACKUP (FIXED) : MASP A - Backup on active MASP to fixed disk complete.
BACKUP (FIXED) : MASP A - Backup starts on standby MASP.
BACKUP (FIXED) : MASP A - Backup on standby MASP to fixed disk complete.
```



## Gateway Screening (GWS) Overview

**Flowchart 2-3.** Configuring Gateway Screening Stop Action Sets (Sheet 1 of 4)

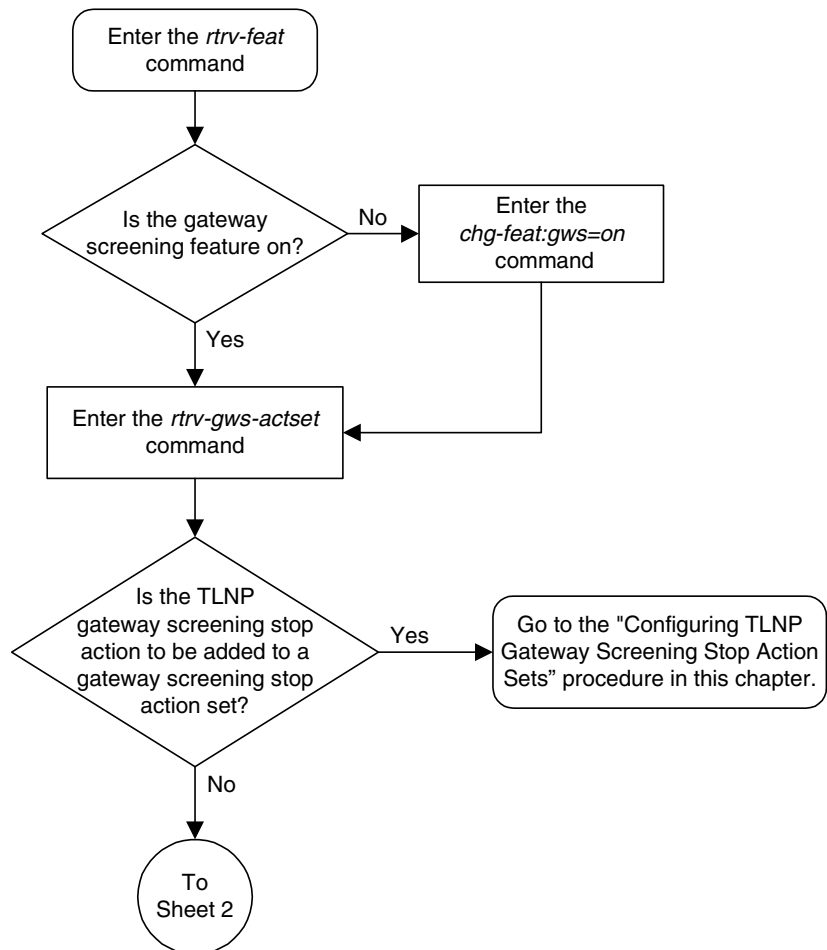

**Flowchart 2-3.** Configuring Gateway Screening Stop Action Sets (Sheet 2 of 4)

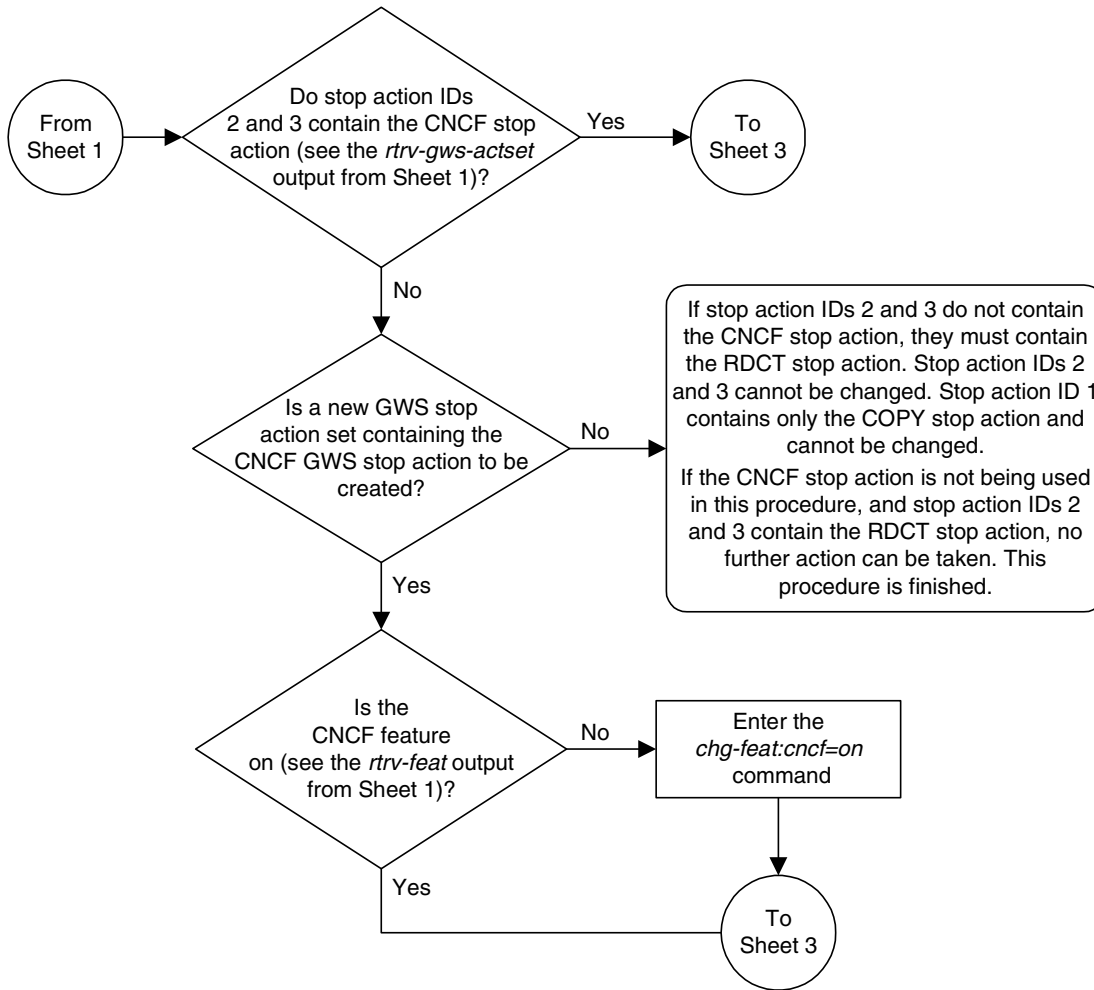

Flowchart 2-3. Configuring Gateway Screening Stop Action Sets (Sheet 3 of 4)

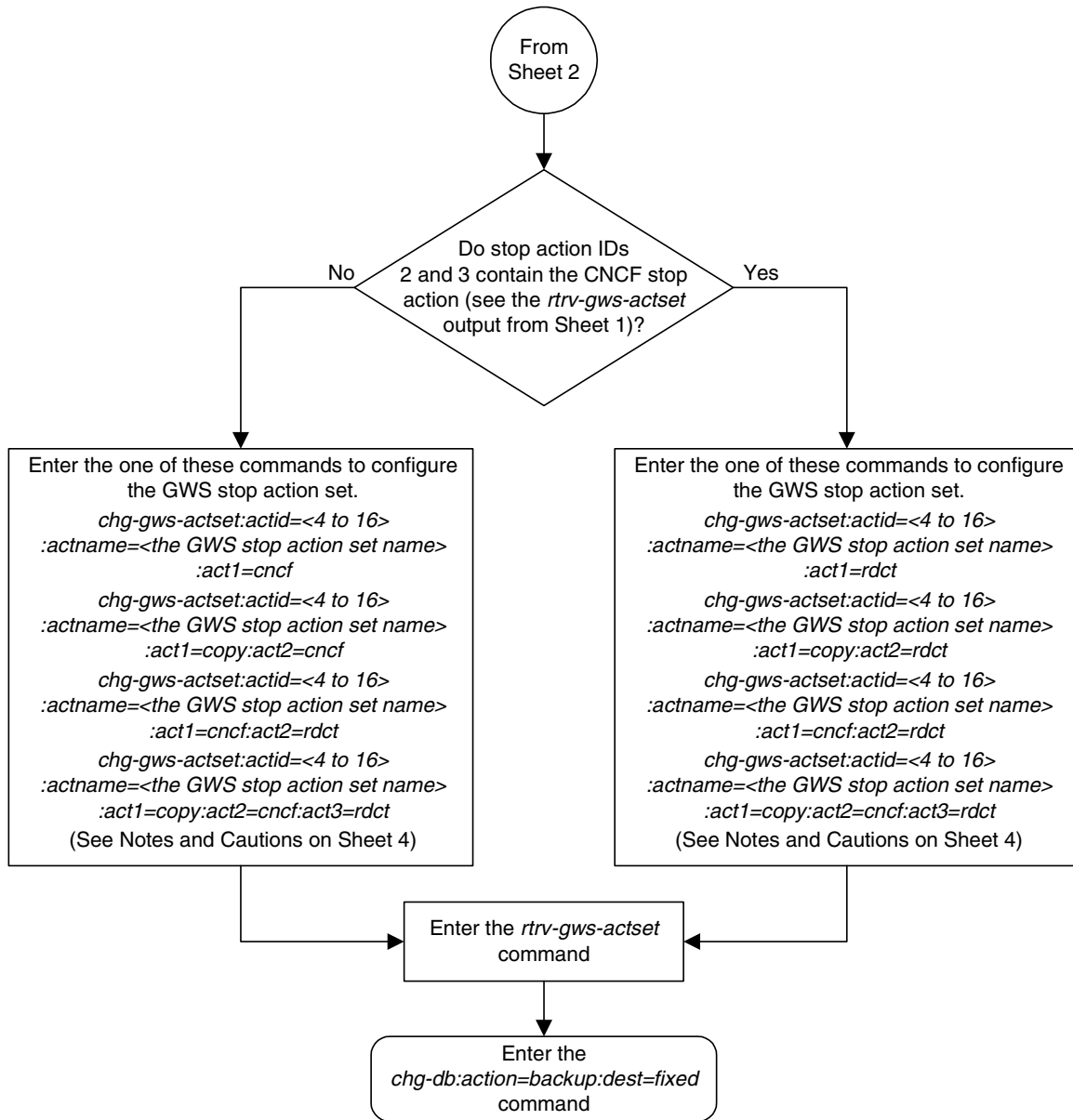

**Flowchart 2-3. Configuring Gateway Screening Stop Action Sets (Sheet 4 of 4)****Notes:**

1. The *force=yes* parameter must be specified with the *chg-gws-actset* command if an existing GWS stop action set is being changed.
2. The *force=yes* parameter can be specified with the *chg-gws-actset* command if a new GWS stop action set is being created, but is not necessary.
3. The CNCF feature must be on to specify the CNCF GWS stop action.
4. The *actname* parameter must be specified for a new GWS stop action set.
5. The *actname* parameter is not required, but can be specified, if an existing stop action set is being changed.
6. If the *actname* parameter value is different from what is shown in the *rtrv-gws-actset* output for the GWS stop action set being changed, the name of the GWS stop action set will be changed to the new *actname* parameter value (see Caution 1).

**Cautions:**

1. Changing the name of an existing GWS stop action set will prevent the actions defined in the GWS stop action set from being used to process the MSUs that pass gateway screening. If the name of the GWS stop action set is changed, enter the gateway screening retrieve commands (*rtrv-scrset*, *rtrv-scr-opc*, *rtrv-scr-blkopc*, *rtrv-scr-sio*, *rtrv-scr-dpc*, *rtrv-scr-blkdpc*, *rtrv-scr-destfld*, *rtrv-scr-isup*, *rtrv-scr-cgpa*, *rtrv-scr-tt*, *rtrv-scr-cdpa*, and *rtrv-scr-aftpc*) with the *actname* parameter and the old GWS stop action set name to identify the screens that need to be changed to use the new GWS stop action set name. To change these screens, perform the appropriate procedures in Chapters 3 through 15 in this manual.
2. Caution must be used when changing the stop actions in existing gateway screening stop action sets because these gateway screening stop action sets may be used by one or more gateway screening rules. Changes in the existing gateway screening stop action sets will change how MSUs that pass gateway screening are processed.
3. Caution must be used when specifying the RDCT stop action in an existing GWS stop action set. Specifying the RDCT stop action for Allowed OPC screens containing the adjacent point code of a linkset, for Allowed SIO screens containing the service indicator values 1 (SI=1) or 2 (SI=2), or for Allowed DPC screens containing the Eagle's point code can cause signaling link failures.  
To verify whether or not the GWS stop action set name used in this procedure is referenced by these screens, enter the *rtrv-scr-opc*, *rtrv-scr-sio*, or *rtrv-scr-dpc* commands, with the *actname* parameter and the GWS stop action set name used in this procedure.

## Configuring TLNP Gateway Screening Stop Action Sets

This procedure is used to add a gateway screening stop action set containing the TLNP gateway screening stop action to the database using the `chg-gws-actset` command.

The gateway screening stop action sets define the actions that are performed on the MSU when the gateway screening process has stopped.

The database can contain a maximum of 16 gateway screening stop action sets, with each set containing a maximum of 10 gateway screening stop actions. For this procedure only two gateway screening stop actions can be used.

- COPY – copy the MSU for the STP LAN feature
- TLNP – ISUP IAMs that pass gateway screening are processed either by the ISUP NP with EPAP feature (if the ISUP NP with EPAP feature is enabled and turned on) or by the Triggerless LNP feature (if the LNP feature is enabled and the Triggerless LNP feature is turned on). The ISUP NP with EPAP feature is discussed in more detail in the *Feature Manual - G-Port*. The Triggerless LNP feature is discussed in more detail in the *LNP Feature Activation Guide*.

The status of the ISUP NP with EPAP feature can be verified with the `rtrv-ctrl-feat` command. The ISUP NP with EPAP feature also requires that the G-Port and Gateway Screening features are turned on. The status of the G-Port and Gateway Screening features can be verified with the `rtrv-feat` command. Turning on the G-Port feature is discussed in more detail in the *Feature Manual - G-PORT*.



**CAUTION:** When Gateway Screening is in the screen test mode, as defined by the linkset parameters `gwsa=off` and `gws=on`, any action in the gateway screening stop action sets created in this procedure will be performed.

The `chg-gws-actset` command in this procedure uses these parameters.

**:actid** – The ID number of the gateway screening stop action set. The value of this parameter is from 4 to 16.

**:actname** – The name of the gateway screening stop action set consisting of 1 alphabetic character followed by up to 5 alphanumeric characters. The word `none` cannot be used for the `actname` parameter.

**:force** – The `force=yes` parameter must be specified when changing the gateway screening stop actions of an existing gateway screening stop action set.

**:act1** and **:act2** – Only two gateway screening stop action sets can be defined with the TLNP gateway screening stop action:

- One set with only the TLNP gateway Screening stop action (defined with the `act1=tlnp` parameter).

- Another set with the COPY and TLNP gateway screening stop action (defined by the `act1=copy` and `act2=tlnp` parameters).

The value of the `actname` parameter must be unique. The value of this parameter is used by the `actname` parameter in the gateway screening commands and is shown in the `NSR/ACT` field of the outputs of the retrieve gateway screening commands to define the action that is performed on the MSU that passes gateway screening.

When a gateway screening stop action set is being entered into the database for the first time, the name of the gateway screening stop action set (`actname`) must be added to the database before any gateway screening stop actions are assigned to the gateway screening stop action set.

The `tlnp` gateway screening stop action cannot be specified with either the `cncf` (calling name conversion facility) or `rdct` (redirect) gateway screening actions in the same gateway screening action set.

**Table 2-12.** Sample TLNP Gateway Screening Stop Action Set Configuration

ACTID	ACTNAME	ACT1	ACT2	ACT3
4	TLNP	tlnp	—	—
5	CPNP	copy	tlnp	—

**Procedure**

---

1. Verify that the gateway screening feature is turned on, by entering the `rtrv-feat` command. If the gateway screening feature is turned on, the `GWS` field should be set to `on`. In this example, the gateway screening feature is off.

**NOTE:** The `rtrv-feat` command output contains other fields that are not used by this procedure. If you wish to see all the fields displayed by the `rtrv-feat` command, see the `rtrv-feat` command description in the *Commands Manual*.

If the gateway screening feature is turned on, go to step 3.

---

2. If the gateway screening feature is not turned on, shown by the `GWS = off` entry in the `rtrv-feat` command output in step 1, turn it on by entering this command.

```
chg-feat:gws=on
```

**NOTE:** Once the gateway screening feature is turned on with the `chg-feat` command, it cannot be turned off.

When this command has successfully completed, this message should appear.

```
rlghncxa03w 05-09-25 15:26:30 GMT EAGLE5 34.0.0
CHG-FEAT: MASP A - COMPLTD
```

---

## Gateway Screening (GWS) Overview

3. Display the gateway screening stop action sets in the database with the **rtrv-gws-actset** command. Action IDs 1, 2, and 3 are predefined and cannot be changed. Action ID 1 contains only the COPY stop action. Action ID 2 contains either the RDCT or CNCF stop action. Action ID 3 contains the COPY and either the RDCT or CNCF stop actions as shown in the following output examples.

```
rlghncxa03w 05-09-25 15:28:30 GMT EAGLE5 34.0.0
ACT ACT ACT ACT ACT ACT ACT ACT ACT ACT ACT ACT
ID NAME 1 2 3 4 5 6 7 8 9 10
--
1 copy copy
2 cncf cncf
3 cpcncf copy cncf
GWS action set table is (3 of 16) 19% full
```

```
rlghncxa03w 05-09-25 15:27:30 GMT EAGLE5 34.0.0
ACT ACT ACT ACT ACT ACT ACT ACT ACT ACT ACT ACT
ID NAME 1 2 3 4 5 6 7 8 9 10
--
1 copy copy
2 rdct rdct
3 cr copy rdct
GWS action set table is (3 of 16) 19% full
```

If the **rtrv-gws-actset** output shows that these gateway screening stop action sets: one with **ACT1=t1np** and the other with **ACT1=copy** and **ACT2=t1np**, this procedure cannot be performed.

If only one of these gateway screening stop action sets are shown, skip steps 4 through 11, and go to step 12.

If neither of these gateway screening stop action sets are shown, go to step 4.

- 
4. Verify whether or not the LNP or ISUP NP with EPAP features are enabled, using the **rtrv-ctrl-feat** command. If the LNP feature is enabled, the **LNP TNs** field with a telephone number quantity greater than zero is shown in the **rtrv-ctrl-feat** output. If the ISUP NP with EPAP feature is enabled, the **ISUP NP with EPAP** field is shown in the **rtrv-ctrl-feat** output.

This is an example of the possible output.

```
rlghncxa03w 05-09-30 21:15:37 GMT EAGLE5 34.0.0
The following features have been permanently enabled:

Feature Name                Partnum    Status    Quantity
IPGWx Signaling TPS        893012814 on        20000
ISUP Normalization         893000201 on        ----
Command Class Management   893005801 off       ----
Intermed GTT Load Sharing  893006901 off       ----
XGTT Table Expansion       893006101 off       ----
XMAP Table Expansion       893007710 on        3000
Large System # Links       893005910 on        2000
Routesets                  893006401 on        6000
GSM MAP SRI Redirect       893014001 on        ----
ISUP NP with EPAP         893013801 on        ----
HC-MIM SLK Capacity       893012707 on         64
```

The following features have been temporarily enabled:

Feature Name	Partnum	Status	Quantity	Trial Period Left
Zero entries found.				

The following features have expired temporary keys:

Feature Name	Partnum
Zero entries found.	

If the ISUP NP with EPAP feature is enabled, skip steps 5 through 10, and go to step 11.

If the LNP feature is enabled, perform the “Configuring the Triggerless LNP Feature” procedure in the *LNP Feature Activation Guide*.

If neither the ISUP NP with EPAP or the LNP features are enabled, perform the “Configuring the Triggerless LNP Feature” procedure in the *LNP Feature Activation Guide* to use the `t1np` gateway screening stop action for the Triggerless LNP feature.

To use the `t1np` gateway screening stop action for the ISUP NP with EPAP feature, neither the ISUP NP with EPAP or the LNP features are enabled, verify that the G-Port feature is on. If the `rtrv-feat` command output in step 1 shows that the G-Port feature is not on, go to the *Feature Manual - G-Port* and turn the G-Port feature on. Then go to step 5.

If the G-Port feature is on, go to step 5.

**NOTE:** If the `rtrv-ctrl-feat` output in step 4 shows any controlled features, skip steps 5, 6, 7, and 8, and go to step 9.

**NOTE:** If the `rtrv-ctrl-feat` output shows only the IPGWx Signaling TPS feature with a quantity of 200 and the HC-MIM SLK Capacity feature with a quantity of 64, then no other features are enabled. Steps 5, 6, 7, and 8 must be performed.

5. Display the serial number in the database with the `rtrv-serial-num` command. This is an example of the possible output.

```
rlghncxa03w 05-09-30 21:15:37 GMT EAGLE5 34.0.0
System serial number = ntxxxxxxxxxxxxxx
```

System serial number is not locked.

```
rlghncxa03w 05-09-30 21:15:37 GMT EAGLE5 34.0.0
Command Completed
```



**NOTE:** If the serial number is locked, skip step 6 and go to step 7.

**NOTE:** If the serial number is correct and locked, skip steps 6, 7, and 8, and go to step 9. If the serial number is correct but not locked, skip steps 6 and 7, and go to step 8. If the serial number is not correct, but is locked, the ISUP NP with EPAP feature cannot be enabled and the remainder of this procedure cannot be performed. Contact the Customer Care Center to get an incorrect and locked serial number changed. Refer to "Customer Care Center" on page 1-9 for the contact information. The serial number can be found on a label affixed to the control shelf (shelf 1100).

6. Enter the correct serial number into the database using the `ent-serial-num` command with the `serial` parameter.

For this example, enter this command.

```
ent-serial-num:serial=<EAGLE 5 SAS's correct serial number>
```

When this command has successfully completed, the following message should appear.

```
rlghncxa03w 05-09-28 21:15:37 GMT EAGLE5 34.0.0  
ENT-SERIAL-NUM: MASP A - COMPLTD
```

---

7. Verify that the serial number entered into step 6 was entered correctly using the `rtrv-serial-num` command. This is an example of the possible output.

```
rlghncxa03w 05-09-28 21:15:37 GMT EAGLE5 34.0.0  
System serial number = nt00001231
```

System serial number is not locked.

```
rlghncxa03w 05-09-28 21:15:37 GMT EAGLE5 34.0.0  
Command Completed
```

If the serial number was not entered correctly, repeat steps 6 and 7 and re-enter the correct serial number.

---

8. Lock the serial number in the database by entering the `ent-serial-num` command with the serial number shown in step 5, if the serial number shown in step 5 is correct, or with the serial number shown in step 7, if the serial number was changed in step 6, and with the `lock=yes` parameter.

For this example, enter this command.

```
ent-serial-num:serial=<EAGLE 5 SAS's serial number>:lock=yes
```

When this command has successfully completed, the following message should appear.

```
rlghncxa03w 05-09-28 21:15:37 GMT EAGLE5 34.0.0  
ENT-SERIAL-NUM: MASP A - COMPLTD
```

---

9. Enable the ISUP NP with EPAP feature by entering the `enable-ctrl-feat` command. For this example, enter this command.

```
enable-ctrl-feat:partnum=893013801:fak=<feature access key>
```

**NOTE:** The values for the feature access key (the `fak` parameter) are provided by Tekelec. If you do not have the controlled feature part number or the feature access key for the feature you wish to enable, contact your Tekelec Sales Representative or Account Representative.

When the `enable-ctrl-feat` command has successfully completed, this message should appear.

```
rlghncxa03w 05-09-30 21:15:37 GMT EAGLE5 34.0.0
ENABLE-CTRL-FEAT: MASP B - COMPLTD
```

---

10. Verify the changes by entering the `rtrv-ctrl-feat` command with the part number specified in step 9.

```
rtrv-ctrl-feat:partnum=893013801
```

The following is an example of the possible output.

```
rlghncxa03w 05-09-30 21:16:37 GMT EAGLE5 34.0.0
The following features have been permanently enabled:
Feature Name          Partnum    Status    Quantity
ISUP NP with EPAP    893013801  off      ----
```

---

**NOTE:** If the TLNP feature is on, shown in the `rtrv-feat` output in step 1, skip this step and step 12, and go to step 13.

11. Turn the TLNP feature on by entering this command.

```
chg-feat:tlnp=on
```

**NOTE:** Once the TLNP feature is turned on with the `chg-feat` command, it cannot be turned off.

When this command has successfully completed, this message should appear.

```
rlghncxa03w 05-09-25 15:26:30 GMT EAGLE5 34.0.0
CHG-FEAT: MASP A - COMPLTD
```

---

12. Add the TLNP gateway screening stop action to the database by using the `chg-gws-actset` command. For this example, enter these commands based on the sample configuration shown in Table 2-11 on page 2-57.

```
chg-gws-actset:actid=4:actname=tlnp:act1=tlnp
```

```
chg-gws-actset:actid=5:actname=cpnp:act1=copy:act2=tlnp
```

If an existing gateway screening stop action set is being changed, the `force=yes` parameter must be specified with the `chg-gws-actset` command.

The `force=yes` parameter can be specified with the `chg-gws-actset` command if a new GWS stop action set is being created, but is not necessary.

The `actname` parameter must be specified for a new GWS stop action set.

The `actname` parameter is not required, but can be specified, if an existing stop action set is being changed.

If the `actname` parameter value is different from what is shown in the `rtrv-gws-actset` output for the GWS stop action set being changed, the name of the GWS stop action set will be changed to the new `actname` parameter value (see the first Caution).



**CAUTION:** Changing the name of an existing GWS stop action set will prevent the actions defined in the GWS stop action set from being used to process the MSUs that pass gateway screening. If the name of the GWS stop action set is changed, enter the gateway screening retrieve commands (`rtrv-scrset`, `rtrv-scr-opc`, `rtrv-scr-blkopc`, `rtrv-scr-sio`, `rtrv-scr-dpc`, `rtrv-scr-blkdpc`, `rtrv-scr-destfld`, `rtrv-scr-isup`, `rtrv-scr-cgpa`, `rtrv-scr-tt`, `rtrv-scr-cdpa`, and `rtrv-scr-aftpc`) with the `actname` parameter and the old GWS stop action set name to identify the screens that need to be changed to use the new GWS stop action set name. To change these screens, perform the appropriate procedures in Chapters 3 through 15 in this manual.



**CAUTION:** Caution must be used when changing the stop actions in existing gateway screening stop action sets because these gateway screening stop action sets may be used by one or more gateway screening rules. Changes in the existing gateway screening stop action sets will change how MSUs that pass gateway screening are processed.

When each of these commands have successfully completed, this message should appear.

```
rlghncxa03w 05-09-25 15:30:30 GMT EAGLE5 34.0.0
```

```
CAUTION: GWS action set may be referenced by one or more GWS rules  
CHG-GWS-ACTSET: MASP A - COMPLTD
```

---

13. Verify the changes using the `rtrv-gws-actset` command. This is an example of the possible output.

```
rlghncxa03w 05-09-25 15:31:30 GMT EAGLE5 34.0.0
ACT ACT ACT ACT ACT ACT ACT ACT ACT ACT ACT
ID NAME 1 2 3 4 5 6 7 8 9 10
--  -----
1 copy copy
2 rdct rdct
3 cr copy rdct
4 tlnp tlnp
5 cpnp copy tlnp

GWS action set table is (5 of 16) 31% full
```

---

14. Backup the new changes using the `chg-db:action=backup:dest=fixed` command. These messages should appear, the active Maintenance and Administration Subsystem Processor (MASP) appears first.

```
BACKUP (FIXED) : MASP A - Backup starts on active MASP.
BACKUP (FIXED) : MASP A - Backup on active MASP to fixed disk complete.
BACKUP (FIXED) : MASP A - Backup starts on standby MASP.
BACKUP (FIXED) : MASP A - Backup on standby MASP to fixed disk complete.
```

---

Flowchart 2-4. Configuring TLNP Gateway Screening Stop Action Sets (Sheet 1 of 5)

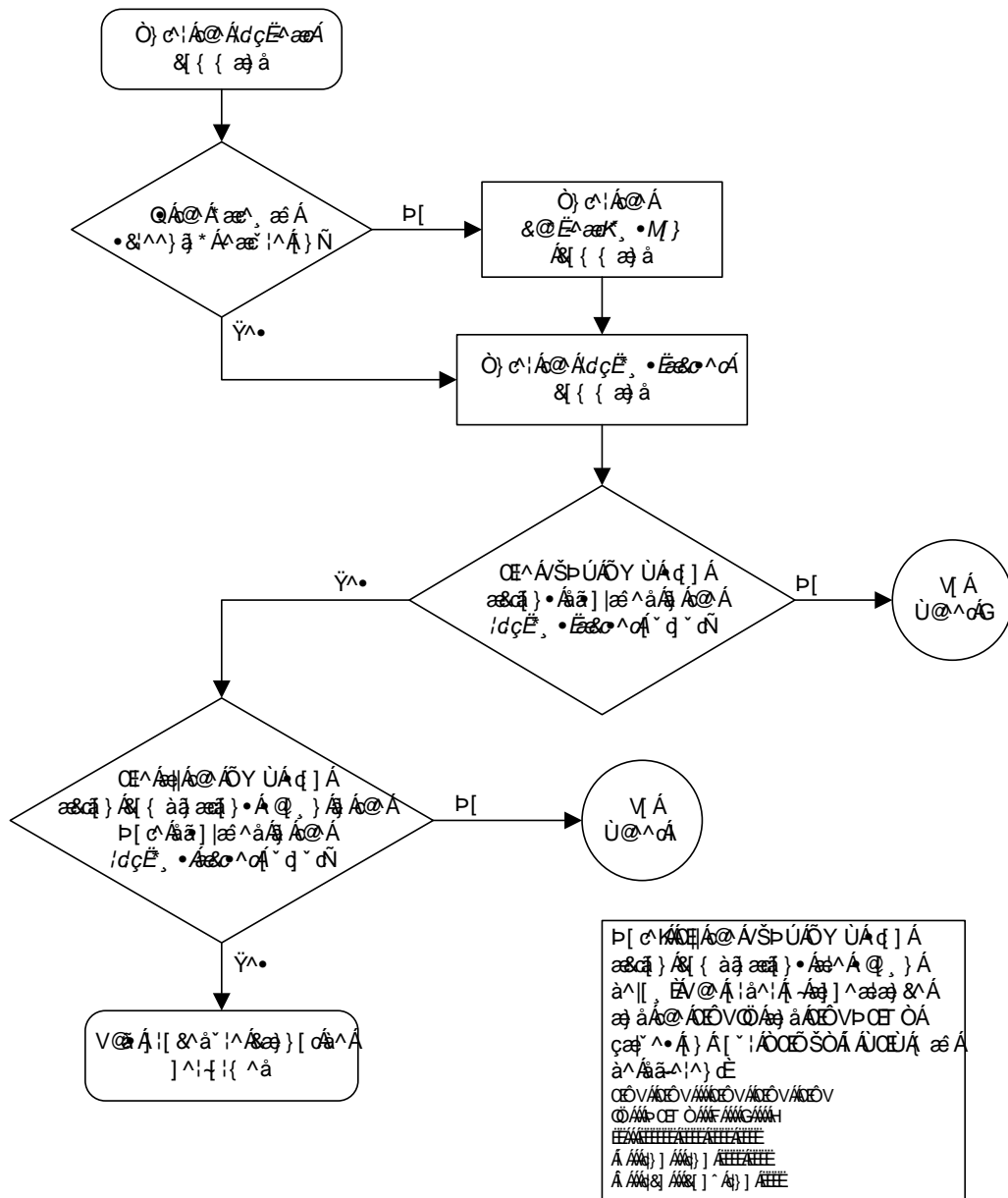

Flowchart 2-4. Configuring TLNP Gateway Screening Stop Action Sets (Sheet 2 of 5)

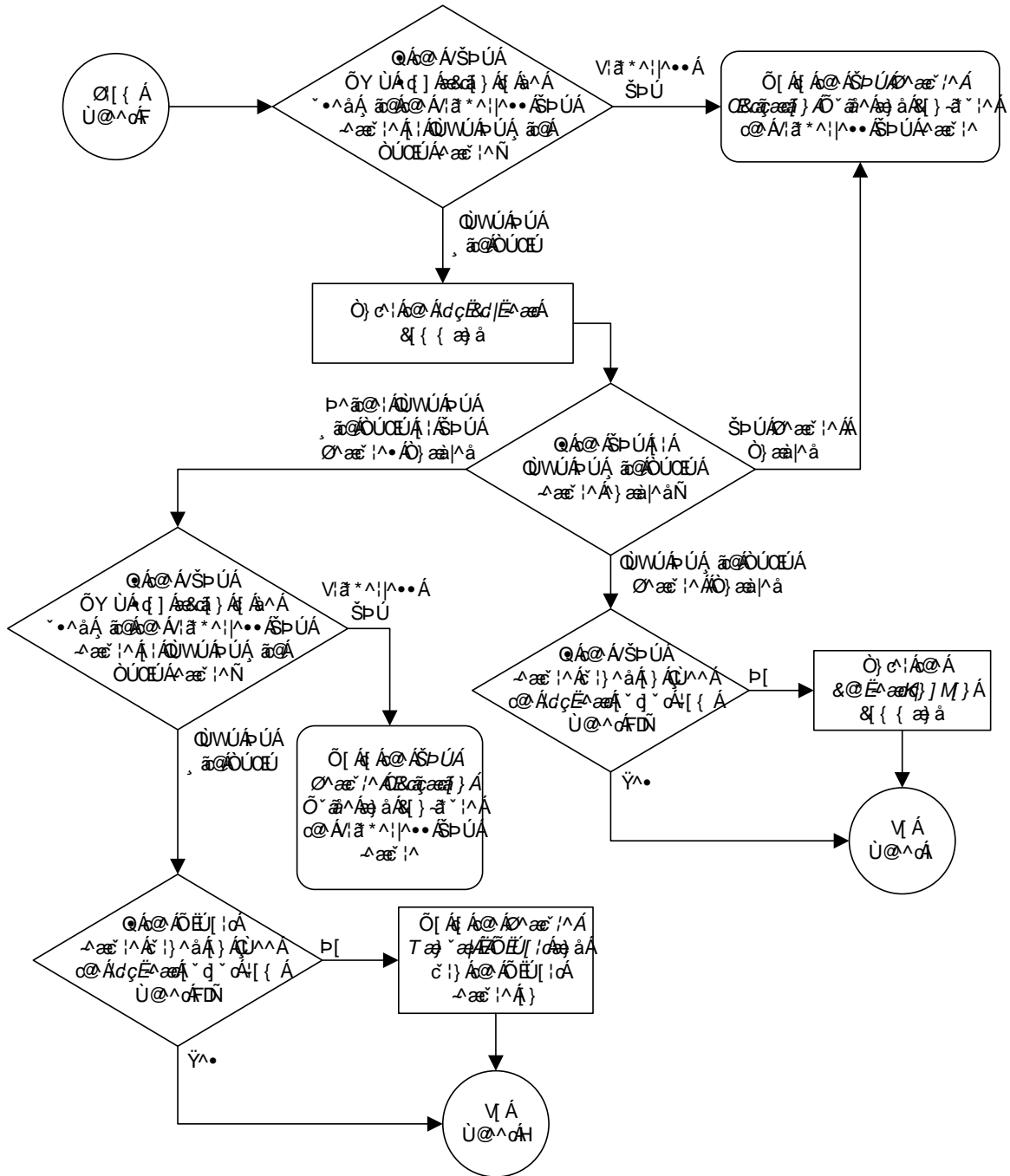

Flowchart 2-4. Configuring TLNP Gateway Screening Stop Action Sets (Sheet 3 of 5)

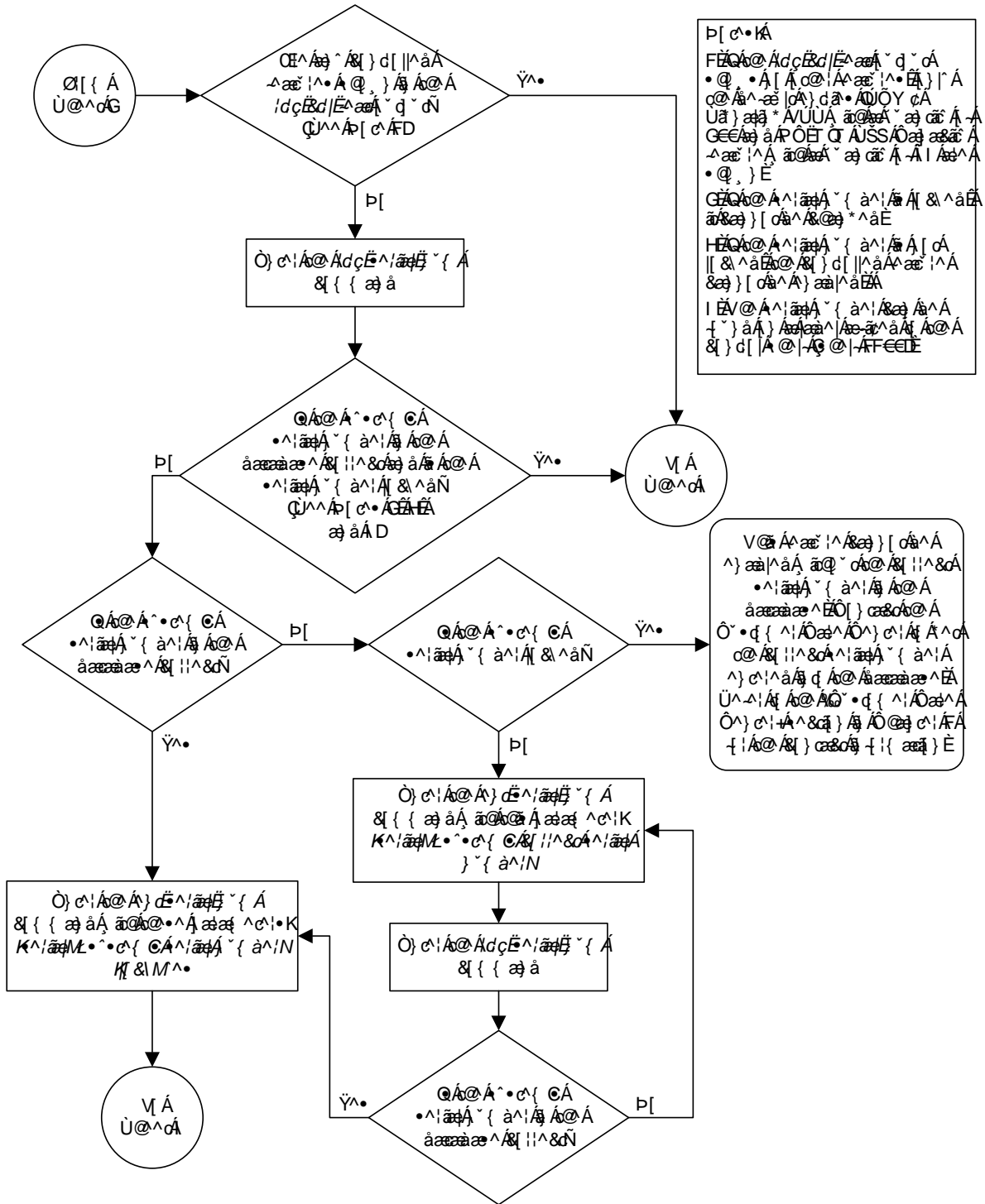

Flowchart 2-4. Configuring TLNP Gateway Screening Stop Action Sets (Sheet 4 of 5)

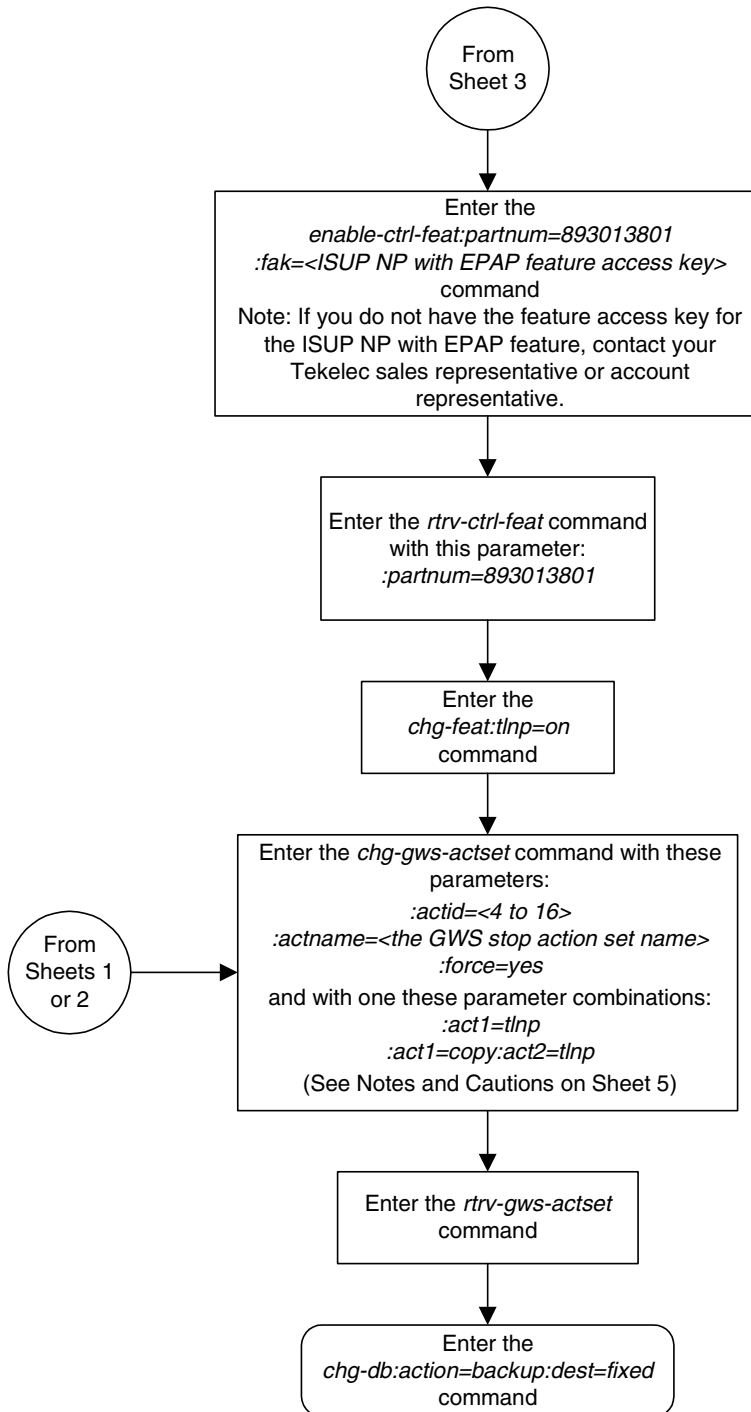



### Flowchart 2-4. Configuring TLNP Gateway Screening Stop Action Sets (Sheet 5 of 5)

**Notes:**

1. The *force=yes* parameter must be specified with the *chg-gws-actset* command if an existing GWS stop action set is being changed.
2. The *force=yes* parameter can be specified with the *chg-gws-actset* command if a new GWS stop action set is being created, but is not necessary.
3. The TLNP GWS stop action cannot be in the same GWS stop action set with either the CNCF or RDCT GWS stop actions.
4. The *actname* parameter must be specified for a new GWS stop action set.
5. The *actname* parameter is not required, but can be specified, if an existing stop action set is being changed.
6. If the *actname* parameter value is different from what is shown in the *rtrv-gws-actset* output for the GWS stop action set being changed, the name of the GWS stop action set will be changed to the new *actname* parameter value (see Caution 1).

**Cautions:**

1. Changing the name of an existing GWS stop action set will prevent the actions defined in the GWS stop action set from being used to process the MSUs that pass gateway screening. If the name of the GWS stop action set is changed, enter the gateway screening retrieve commands (*rtrv-scrset*, *rtrv-scr-opc*, *rtrv-scr-blkopc*, *rtrv-scr-sio*, *rtrv-scr-dpc*, *rtrv-scr-blkdpc*, *rtrv-scr-destfld*, *rtrv-scr-isup*, *rtrv-scr-cgpa*, *rtrv-scr-tt*, *rtrv-scr-cdpa*, and *rtrv-scr-aftpc*) with the *actname* parameter and the old GWS stop action set name to identify the screens that need to be changed to use the new GWS stop action set name. To change these screens, perform the appropriate procedures in Chapters 3 through 15 in this manual.
2. Caution must be used when changing the stop actions in existing gateway screening stop action sets because these gateway screening stop action sets may be used by one or more gateway screening rules. Changes in the existing gateway screening stop action sets will change how MSUs that pass gateway screening are processed.

## Removing Gateway Screening Stop Action Sets

This procedure is used to remove a gateway screening stop action set from the database or a gateway screening stop action from a gateway screening stop action set from the database using the `chg-gws-actset` command.

The database can contain a maximum of 16 gateway screening stop action sets, with each set containing a maximum of 10 gateway screening stop actions. Five gateway screening stop actions have been defined.

The `chg-gws-actset` command uses these parameters in this procedure.

**:actid** – The ID number of the gateway screening stop action set. The value of this parameter is from 4 to 16.

**:force** – The `force=yes` parameter must be specified when changing the gateway screening stop actions of an existing gateway screening stop action set.

**:all=none** – Sets the value of each gateway screening stop action in the gateway screening stop action set to `none`.

**:act1** to **:act10** – One of ten gateway screening stop actions being removed from the gateway screening stop action set.

The first three gateway screening stop action sets (`actid=1`, `actid=2`, and `actid=3`) cannot be changed or removed.

No other optional parameters can be specified `all=none` parameter.

The `force=yes` parameter must be specified when changing an existing gateway screening stop action set.

### Procedure

---

1. Display the gateway screening stop action sets in the database with the `rtrv-gws-actset` command. This is an example of the possible output.

```
rlghncxa03w 05-09-25 15:27:30 GMT EAGLE5 34.0.0
ACT ACT ACT ACT ACT ACT ACT ACT ACT ACT ACT
ID NAME 1 2 3 4 5 6 7 8 9 10
--
1 copy copy
2 rdct rdct
3 cr copy rdct
4 cnf cnf
5 cpnf copy cnf
6 cfrd copy cnf rdct
7 cnrd cnf rdct
8 tlnp tlnp
9 tlcp copy tlnp

GWS action set table is (9 of 16) 56% full
```

---

2. Either remove a gateway screening stop action set from the database or remove a gateway screening stop action from a gateway screening stop action set from the database by entering the `chg-gws-actset` command.

If you wish to remove the gateway screening stop actions from an existing gateway screening stop action set (stop action sets 4 through 16), enter the `chg-gws-actset` command with the `all=none`, `actid`, and `force=yes` parameters, as shown in this command example.

```
chg-gws-actset:actid=4:all=none:force=yes
```

If you wish to remove individual gateway screening stop actions from an existing gateway screening stop action set (stop action sets 4 through 16), enter the `chg-gws-actset` command with the stop action parameter (`act1` through `act10`) value equal to none and the `force=yes` parameter, as shown in this command example.

```
chg-gws-actset:actid=5:act2=none:force=yes
```



**CAUTION:** Caution must be used when changing the stop actions in existing gateway screening stop action sets because these gateway screening stop action sets may be used by one or more gateway screening rules. Changes in the existing gateway screening stop action sets will change how MSUs that pass gateway screening are processed.

When each of these commands have successfully completed, this message should appear.

```
rlghncxa03w 05-09-25 15:30:30 GMT EAGLE5 34.0.0
CAUTION: GWS action set may be referenced by one or more GWS rules
CHG-GWS-ACTSET: MASP A - COMPLTD
```

3. Verify the changes using the `rtrv-gws-actset` command. This is an example of the possible output.

```
rlghncxa03w 05-09-25 15:31:30 GMT EAGLE5 34.0.0
ACT  ACT      ACT  ACT  ACT  ACT  ACT  ACT  ACT  ACT  ACT  ACT
ID   NAME     1    2    3    4    5    6    7    8    9    10
--   -
1    copy     copy
2    rdct     rdct
3    cr       copy rdct
4    ----     ----
5    cpncf    copy
6    cncfrd   cncf rdct
7    cpcfrd   copy cncf rdct
8    tlnp     tlnp
9    cpnp     copy tlnp
GWS action set table is (8 of 16) 50% full
```

4. Backup the new changes using the `chg-db:action=backup:dest=fixed` command. These messages should appear, the active Maintenance and Administration Subsystem Processor (MASP) appears first.

```
BACKUP (FIXED) : MASP A - Backup starts on active MASP.
BACKUP (FIXED) : MASP A - Backup on active MASP to fixed disk complete.
BACKUP (FIXED) : MASP A - Backup starts on standby MASP.
BACKUP (FIXED) : MASP A - Backup on standby MASP to fixed disk complete.
```

**Flowchart 2-5.** Removing Gateway Screening Stop Action Sets

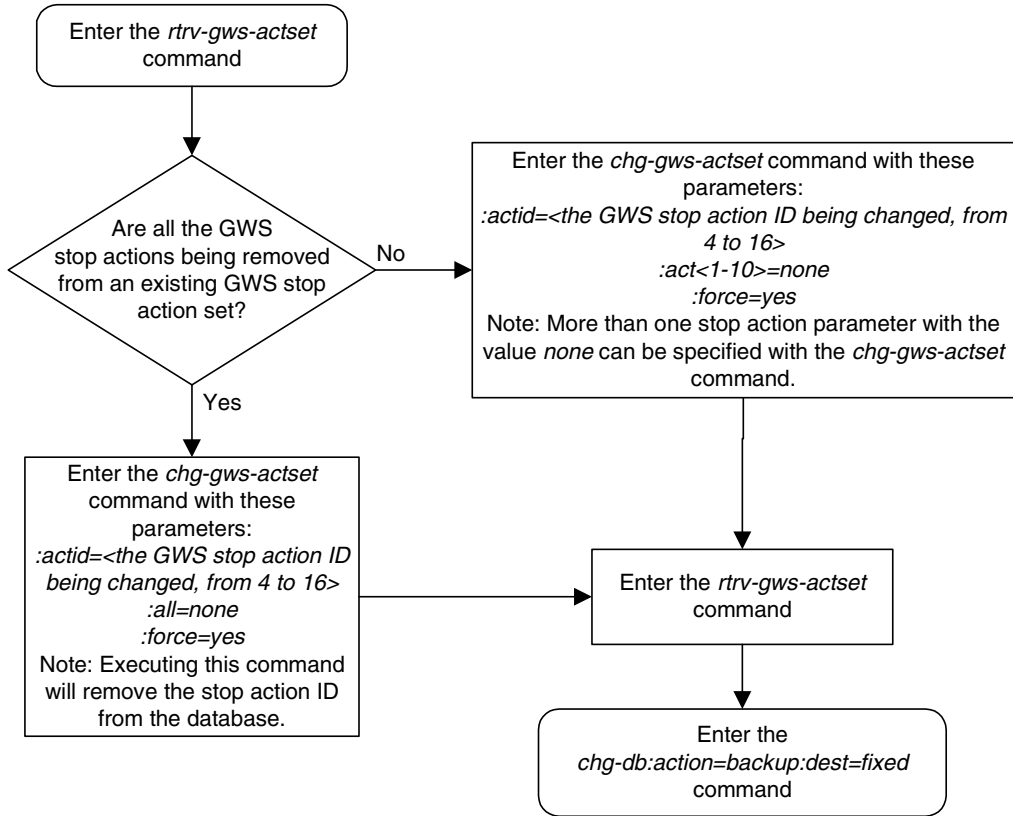

## Setting the Threshold for Reporting Gateway Screening Activity

This procedure is used to set the threshold for reporting these gateway screening activities using the `set-gtwy-acthresh` command.

- The threshold for MSUs received on a gateway link set.
- The threshold for MSUs rejected on a gateway link set because of screening.

These thresholds are set on a linkset basis. These gateway screening activities are reported only if the threshold is set and only if the threshold is reached.

The `set-gtwy-acthresh` command uses these parameters.

`:intrvl` – The examination period, in minutes, during which the gateway screening activity thresholds are to be tested.

`:lsn` – The name of the linkset that the thresholds are assigned to.

`:recv` – The threshold for MSUs received on the gateway link set.

`:rej` – The threshold for MSUs rejected on the gateway link set because of screening.

One or more of the optional parameters must be specified with the `set-gtwy-acthresh` command.

The linkset specified must be in the database and must have a gateway screening screen set assigned to it and gateway screening must be enabled for the linkset. This can be verified with the `rtrv-ls` command. The name of the gateway screening screen set is shown in the `SCRN` field and the entry `on` is shown in the `GWSA` field. If the linkset does not have gateway screening assigned to it, display the screen sets in the database using the `rtrv-scrset` command. Go to either the “Changing an SS7 Linkset” procedure in the *Database Administration Manual - SS7* or the “Changing an X.25 Linkset” procedure in the *Database Administration Manual - Features* and change the linkset configuration specifying the `scrn` parameter with a screen set name shown in the `rtrv-scrset` command output and specifying the `gwsa=on` parameter

The examples in this procedure are used to set these gateway thresholds on linkset `lsa2`.

The examination period – 20 minutes

The number of MSUs received on the linkset – 2500

The number of MSUs rejected because of screening – 30

### Canceling the RTRV-LS Command

Because the `rtrv-ls` command used in this procedure can output information for a long period of time, the `rtrv-ls` command can be canceled and the output to the terminal stopped. There are three ways that the `rtrv-ls` command can be canceled.

- Press the **F9** function key on the keyboard at the terminal where the `rtrv-ls` command was entered.
- Enter the `canc-cmd` without the `trm` parameter at the terminal where the `rtrv-ls` command was entered.
- Enter the `canc-cmd:trm=<xx>`, where `<xx>` is the terminal where the `rtrv-ls` command was entered, from another terminal other than the terminal where the `rtrv-ls` command was entered. To enter the `canc-cmd:trm=<xx>` command, the terminal must allow Security Administration commands to be entered from it and the user must be allowed to enter Security Administration commands. The terminal's permissions can be verified with the `rtrv-secu-trm` command. The user's permissions can be verified with the `rtrv-user` or `rtrv-secu-user` commands.

For more information about the `canc-cmd` command, go to the *Commands Manual*.

### Procedure

---

1. Display the gateway screening thresholds in the database using the `rtrv-gtwy-acthresh` command. The following is an example of the possible output.

```
rlghncxa03w 05-09-25 15:25:30 GMT EAGLE5 34.0.0
LSN      REJ      RECV     INTRVL
WY644368 10       1000     10
WY234456 25       2000     20
LN123556 25       2500     30
OP239900 -         5        5
```

---

## Gateway Screening (GWS) Overview

2. Display the current linkset configuration using the `rtrv-ls` command. The following is an example of the possible output.

```
rlghncxa03w 05-09-25 15:26:30 GMT EAGLE5 34.0.0

          L3T SLT          GWS GWS GWS
LSN      APCA  (SS7)  SCRN  SET SET  BEI LST LNKS ACT MES DIS SLSCI NIS
lsa1     240-020-000  ss01  1  1  yes A  1  off off off no  off
lsa2     240-030-000  ss02  1  2  no  C  3  on  on  on yes  off
lsa3     240-040-000  ss03  1  3  yes C  5  off off off yes  off
ln123556 240-050-000  ss01  1  8  yes C  5  on  on  on yes  off
op239900 240-060-000  ss01  1  7  yes C  5  on  on  on yes  off
wy234456 240-070-000  ss01  1  6  yes C  5  on  on  on yes  off
wy644368 240-080-000  ss01  1  5  yes C  5  on  on  on yes  off

          L3T SLT          GWS GWS GWS
LSN      APCA  (X25) SCRN  SET SET  BEI LST LNKS ACT MES DIS SLSCI NIS
ls6      244-010-004  ss04  1  4  no  A  6  off off off ---  off
ls7      244-012-005  ss07  1  5  no  C  3  on  on  on ---  off
ls8      244-012-006  ss09  1  6  no  C  8  off off off ---  off

          L3T SLT          GWS GWS GWS
LSN      APCI  (SS7)  SCRN  SET SET  BEI LST LNKS ACT MES DIS SLSCI NIS
lsi1     1-111-1      ss01  1  1  yes A  1  off off off ---  ---
lsi2     1-111-2      ss02  1  2  no  C  3  on  on  on ---  ---
lsi3     1-111-3      ss03  1  3  yes C  5  off off off ---  ---

          L3T SLT          GWS GWS GWS
LSN      APCN  (SS7)  SCRN  SET SET  BEI LST LNKS ACT MES DIS SLSCI NIS
lsn1     11111        ss01  1  1  yes A  1  off off off ---  off
lsn2     11112        ss02  1  2  no  C  3  on  on  on ---  off
lsn3     11113        ss03  1  3  yes C  5  off off off ---  off

          L3T SLT          GWS GWS GWS
LSN      APCN24 (SS7) SCRN  SET SET  BEI LST LNKS ACT MES DIS SLSCI NIS

          L3T SLT          GWS GWS GWS
LSN      APCN24 (SS7) SCRN  SET SET  BEI LST LNKS ACT MES DIS SLSCI NIS

          L3T SLT          GWS GWS GWS
LSN (CHINA) APCN  (SS7) SCRN  SET SET  BEI LST LNKS ACT MES DIS SLSCI NIS

          L3T SLT          GWS GWS GWS
LSN (CHINA) APCN24 (SS7) SCRN  SET SET  BEI LST LNKS ACT MES DIS SLSCI NIS

Link set table is ( 12 of 1024) 1% full
```

3. Set the gateway screening thresholds for a linkset using the `set-gtwy-actthresh` command. For this example, enter this command.

```
set-gtwy-actthresh:lsn=lsa2:intrvl=20:rej=30:recv=2500
```

When this command has successfully completed, a message similar to the following should appear.

```
rlghncxa03w 05-09-25 15:29:30 GMT EAGLE5 34.0.0
SET-GTWY-TRHSHLD: MASP A - COMPLTD
```

4. Verify the changes using the **rtrv-gtwy-acthresh** command with the linkset name specified in step 3. For this example, enter this command.

```
rtrv-gtwy-acthresh:lsn=lsa2
```

The following is an example of the possible output.

```
rlghncxa03w 05-09-25 15:30:30 GMT EAGLE5 34.0.0
LSN      REJ      RECV     INTRVL
LSA2     30      2500    20
```

---

5. Backup the new changes using the **chg-db:action=backup:dest=fixed** command. The following messages should appear, the active Maintenance and Administration Subsystem Processor (MASP) appears first.

```
BACKUP (FIXED) : MASP A - Backup starts on active MASP.
BACKUP (FIXED) : MASP A - Backup on active MASP to fixed disk complete.
BACKUP (FIXED) : MASP A - Backup starts on standby MASP.
BACKUP (FIXED) : MASP A - Backup on standby MASP to fixed disk complete.
```

---



Flowchart 2-6. Setting the Threshold for Reporting Gateway Screening Activity

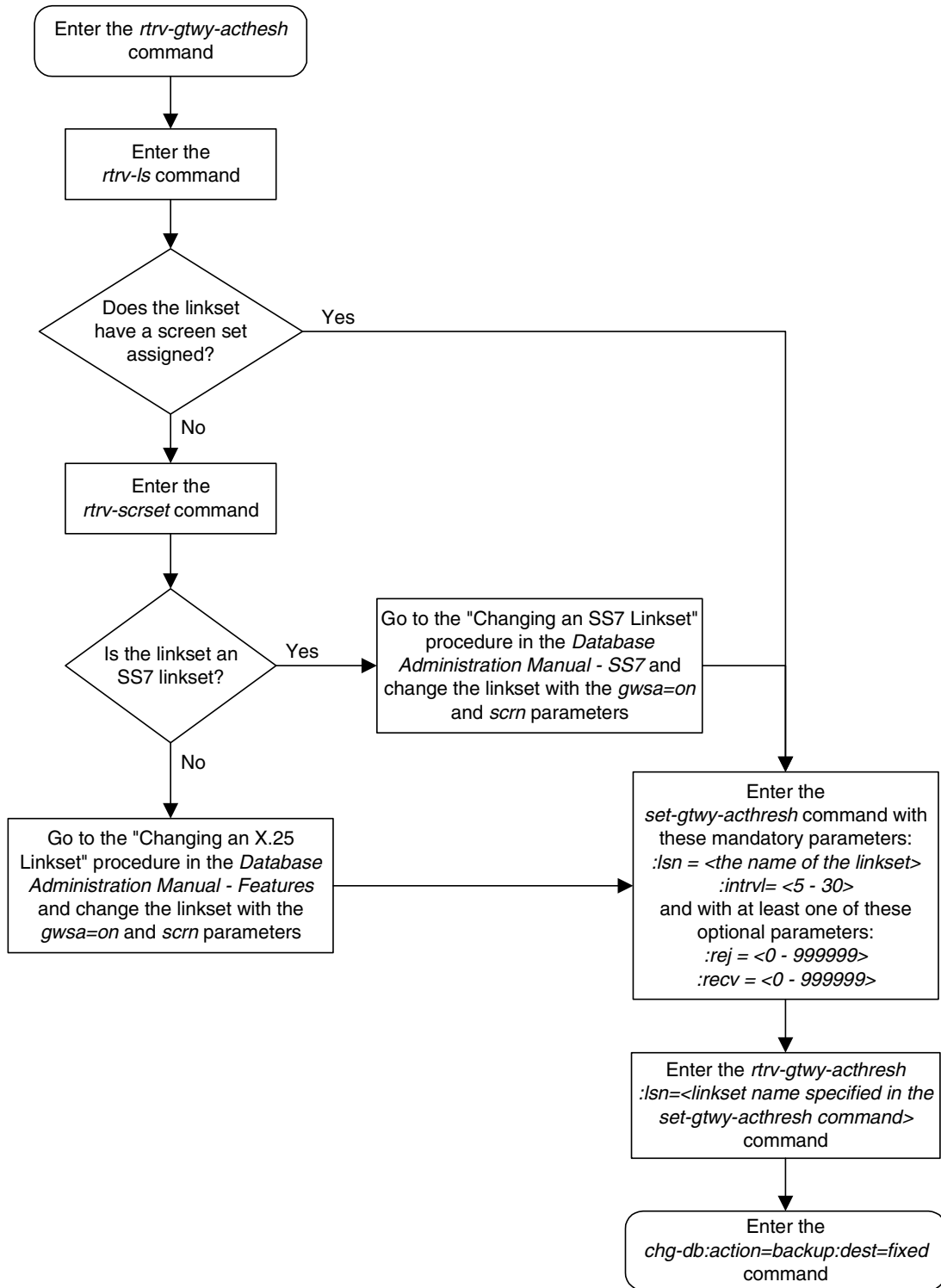

## Setting the Maximum Number of Gateway Screening Rejected Messages

When an MSU is rejected because of gateway screening, a UIM is sent to the terminal alerting the user that the MSU has been rejected. The EAGLE 5 SAS allows the user to configure the maximum number of these UIMs that can be sent to the terminal for a specified time period. This procedure is used to configure the maximum number of UIMs sent to the terminal and the time period using the `set-scrrej-prmtrs` command.

The `set-scrrej-prmtrs` command uses these parameters.

**:limit** – the number of UIMs to be sent to the EAGLE 5 SAS terminals during the time period specified by the `intrvl` parameter. The values for this parameter range from 0 to 9999.

**:intrvl** – the amount of time, in minutes, that the maximum number of UIMs, defined by the `limit` parameter, can be sent to the EAGLE 5 SAS terminals.

The examples in this procedure are used to set the number of UIMs to 500 and the time period to 20 minutes.

### Procedure

---

1. Display the current gateway screening rejected UIM limit in the database using the `rtrv-gtwy-prmtrs` command. The following is an example of the possible output.

```
rlghncxa03w 05-09-25 15:25:30 GMT EAGLE5 34.0.0
LIMIT INTRVL
1000 15
```

---

2. Set the gateway screening rejected UIM limit using the `set-scrrej-prmtrs` command. For this example, enter this command.

```
set-scrrej-prmtrs:limit=500:intrvl=20
```

When this command has successfully completed, a message similar to the following should appear.

```
rlghncxa03w 05-09-25 15:26:30 GMT EAGLE5 34.0.0
SET-SCRREJ-PRMTRS: MASP A - COMPLTD
```

---

3. Verify the changes using the `rtrv-gtwy-prmtrs` command. The following is an example of the possible output.

```
rlghncxa03w 05-09-25 15:27:30 GMT EAGLE5 34.0.0
LIMIT INTRVL
500 20
```

---

## Gateway Screening (GWS) Overview

4. Backup the new changes using the `chg-db:action=backup:dest=fixed` command. The following messages should appear, the active Maintenance and Administration Subsystem Processor (MASP) appears first.

```
BACKUP (FIXED) : MASP A - Backup starts on active MASP.  
BACKUP (FIXED) : MASP A - Backup on active MASP to fixed disk complete.  
BACKUP (FIXED) : MASP A - Backup starts on standby MASP.  
BACKUP (FIXED) : MASP A - Backup on standby MASP to fixed disk complete.
```

---

### Flowchart 2-7. Setting the Maximum Number of Gateway Screening Rejected Messages

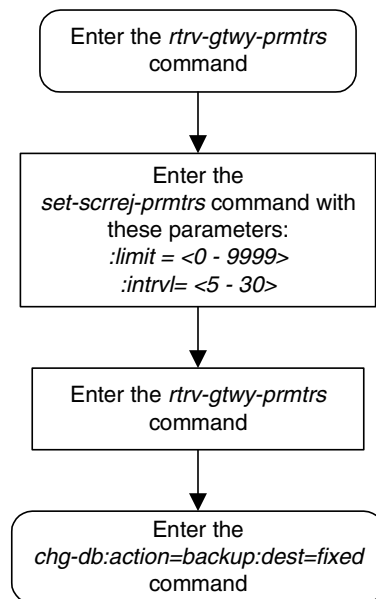

## Gateway Screening (GWS) Overview

# 3

## Allowed Affected Point Code (AFTPC) Screen Configuration

Introduction.....	3-2
Adding an Allowed Affected Point Code Screen .....	3-4
Removing an Allowed Affected Point Code Screen.....	3-14
Changing an Allowed Affected Point Code Screen.....	3-17

## Introduction

The allowed affected point code (AFTPC) screen is used to identify affected point codes. Messages containing the allowed affected point code in the AFTPC screen are allowed into the EAGLE 5 SAS for further processing. The gray shaded areas in Figure 3-1 shows the fields of the SS7 message that are checked by the AFTPC screening function.

Affected point codes are found in subsystem-prohibited (SSP), subsystem-status-test (SST) and subsystem-allowed (SSA) SCCP management messages. This is the last screen in the gateway screening process. If a match is found, the **nsfi** is equal to **stop**, and the message is processed.

If the **copy** gateway screening stop action is specified, the message is processed and a copy of the message is sent by the STP LAN feature to an external application through an ACM running the **stp1an** application or a DCM running the **vxwslan** application.

If no match is found, the message is rejected.

Flowchart 3-1 shows the screening action of the allowed AFTPC screen.

**Flowchart 3-1.** Allowed AFTPC Screening Action

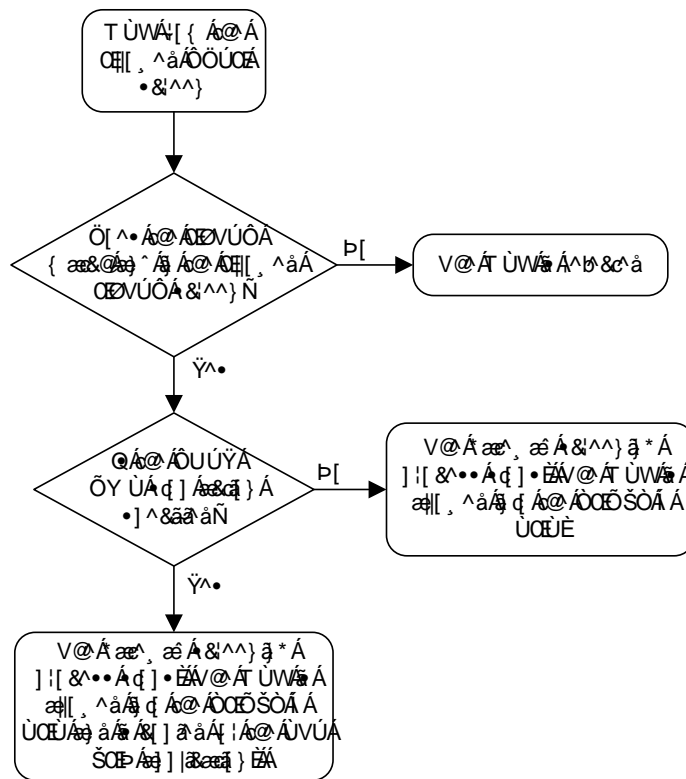

# Allowed Affected Point Code (AFTPC) Screen Configuration

**Figure 3-1.** Allowed Affected Point Code Screening Function

**ANSI MSU (ANSI Message Signal Unit)**

BSN FSN LI	SIO xx xx xxxx NIC PRI SI	SIF					
		Routing Label DPC OPC SLS NCM NC NI NCM NC NI xx			CGPA	CDPA	SCMG Data Length Message Type\ (SSA, SSP, SST) Affected Subsystem Affected Point Code (NCM NC NI) Subsystem Multiplicity

**ITU-I MSU (ITU International Message Signal Unit)**

BSN FSN LI	SIO xx xx xxxx NIC PRI SI	SIF					
		Routing Label DPC OPC SLS ID AREA ZONE ID AREA ZONE xx			CGPA	CDPA	SCMG Data Length Message Type\ (SSA, SSP, SST) Affected Subsystem Affected Point Code (ID AREA ZONE) Subsystem Multiplicity

**14-Bit ITU-N MSU (14-Bit ITU National Message Signal Unit)**

BSN FSN LI	SIO xx xx xxxx NIC PRI SI	SIF					
		Routing Label DPC OPC SLS NPC NPC xx			CGPA	CDPA	SCMG Data Length Message Type\ (SSA, SSP, SST) Affected Subsystem Affected Point Code (NPC) Subsystem Multiplicity

**24-Bit ITU-N MSU (24-Bit ITU National Message Signal Unit)**

BSN FSN LI	SIO xx xx xxxx NIC PRI SI	SIF					
		Routing Label DPC OPC SLS SP SSA MSA SP SSA MSA xx			CGPA	CDPA	SCMG Data Length Message Type\ (SSA, SSP, SST) Affected Subsystem Affected Point Code (SP SSA MSA) Subsystem Multiplicity

## Adding an Allowed Affected Point Code Screen

This procedure is used to add an allowed affected point code (AFTPC) screen to the database using the `ent-scr-aftpc` command. The parameters used by the `ent-scr-aftpc` command are shown in the “Gateway Screening Attributes” section on page 2-7. The general rules that apply to configuring gateway screening entities are shown in the “Gateway Screening Configuration” section on page 2-28.

The examples in this procedure are used to add the allowed AFTPC screen data shown in Table 3-1 and based on the example configurations shown in Figure 2-3 on page 2-33 and Figure 2-6 on page 2-39.

**Table 3-1.** Example Gateway Screening Allowed AFTPC Configuration Table

Screening Reference	NI	NC	NCM	SSN	NSFI	ACTNAME
gw20	008	008	008	250	stop	COPY
ls04	010	010	010	015	stop	COPY

**NOTE:** If you using multiple-part ITU national point codes with gateway screening, see “14-Bit ITU National Point Code Formats” on page 2-24.

### Specifying a Range of Values

A range of values can be specified for the point code parameters `ni`, `nc`, or `ncm`.

If a range of values is specified for any of these parameters, and the value of the other parameters match existing values for the screening reference name, the range of values for the point code parameter cannot include any values for that parameter that are currently provisioned for the screening reference name.

For example, screening reference name `scr1` contains these entries:

SR	NI	NC	NCM	SSN	NSFI	NSR/ACT
SCR1	240	001	010	012	STOP	-----
SCR1	241	010	020	015	STOP	-----

Another entry for screening reference `scr1` with the `ni` value of 240 and the `nc` value of 001 cannot be specified if the range of values for the `ncm` parameter includes the value 010.

The ANSI point code parameter values can be specified as a single value, a range of values, or with an asterisk (\*). The asterisk specifies all possible values for the `ni`, `nc`, and `ncm` parameters. Table 3-2 shows the valid combinations of these parameter values.



## Allowed Affected Point Code (AFTPC) Screen Configuration

**Table 3-2.** Valid Value Combinations for ANSI Point Code Parameters

NI	NC	NCM
Single Value	Single Value	Single Value
Single Value	Single Value	Range of Values
Single Value	Single Value	Asterisk
Single Value	Range of Values	Asterisk
Single Value	Asterisk	Asterisk
Range of Values	Asterisk	Asterisk
Asterisk	Asterisk	Asterisk

A range of values can also be specified for an ITU-I or 24-bit ITU-N point code parameter using a combination of asterisks (\*) and single values for the point code parameters. Table 3-3 shows the valid combinations of the ITU-I parameter values. Table 3-4 shows the valid combinations of the 24-bit ITU-N parameter values.

**Table 3-3.** Valid Value Combinations for ITU-I Point Code Parameters

ZONE	AREA	ID
Single Value	Single Value	Single Value
Single Value	Single Value	Asterisk
Single Value	Asterisk	Asterisk
Asterisk	Asterisk	Asterisk

**Table 3-4.** Valid Value Combinations for 24-Bit ITU-N Point Code Parameters

MSA	SSA	SP
Single Value	Single Value	Single Value
Single Value	Single Value	Asterisk
Single Value	Asterisk	Asterisk
Asterisk	Asterisk	Asterisk

## Procedure

---

1. Verify that the gateway screening feature is on, by entering the `rtrv-feat` command. If the gateway screening feature is on, the `GWS` field is set to `on`.

**NOTE:** The `rtrv-feat` command output contains other fields that are not used by this procedure. If you wish to see all the fields displayed by the `rtrv-feat` command, see the `rtrv-feat` command description in the *Commands Manual*.

If the gateway screening feature is on, shown by the entry `GWS = on` in the `rtrv-feat` command output, skip step 2, and go to step 3.

---

2. Turn the gateway screening feature on by entering this command.

```
chg-feat:gws=on
```

**NOTE:** Once the gateway screening feature is turned on with the `chg-feat` command, it cannot be turned off.

The gateway screening feature must be purchased before you turn this feature on with the `chg-feat` command. If you are not sure if you have purchased the gateway screening feature, contact your Tekelec Sales Representative or Account Representative.

When the `chg-feat` has successfully completed, this message should appear.

```
rlghncxa03w 05-09-28 11:43:04 GMT EAGLE5 34.0.0  
CHG-FEAT: MASP A - COMPLTD
```

---

## Allowed Affected Point Code (AFTPC) Screen Configuration

3. Display all allowed AFTPC screens in the database using the `rtrv-scr-aftpc` command. The following is an example of the possible output.

```
rlghncxa03w 05-09-25 15:25:30 GMT EAGLE5 34.0.0
SCREEN = ALLOWED AFTPC
SR   REF  RULES
IEC  YES   2
WRD2 YES   1
WRD4 YES   9
```

If the screening reference names that you wish to add with this procedure are not shown in the `rtrv-scr-aftpc` command output, go to step 4. For this example, the screening reference names are not shown. If these screening reference names are shown in the `rtrv-scr-aftpc` command output, make sure the screening data you wish to enter is not already in the database by entering the `rtrv-scr-aftpc` command with the screening reference name. For example, enter the `rtrv-scr-aftpc:sr=iec` command. The following is an example of the possible output.

```
rlghncxa03w 05-09-25 15:26:30 GMT EAGLE5 34.0.0
SCREEN = ALLOWED AFTPC
SR   NI      NC      NCM      SSN      NSF1      NSR/ACT
IEC  010      010      011      012      STOP      -----
IEC  010      010      013      012      STOP      -----
```

If a gateway screening stop action set is to be assigned to the allowed AFTPC screen being added to the database, go to step 4. Otherwise, go to step 5.

- 
4. Display the gateway screening stop action sets in the database with the `rtrv-gws-actset` command. This is an example of the possible output.

```
rlghncxa03w 05-09-25 15:26:30 GMT EAGLE5 34.0.0
ACT  ACT    ACT  ACT  ACT  ACT  ACT  ACT  ACT  ACT  ACT  ACT
ID   NAME    1    2    3    4    5    6    7    8    9    10
--   -
1    copy    copy
2    rdct    rdct
3    cr      copy  rdct
4    cnf     cnf
5    cpcnf   copy  cnf
6    cnfrd   cnf   rdct
7    cpcfrd  copy  cnf   rdct
```

```
GWS action set table is (7 of 16) 44% full
```

If the required gateway screening stop action set is not in the database, go to the "Configuring Gateway Screening Stop Action Sets" procedure on page 2-54 and configure the required gateway screening stop action set.

---

**NOTE:** If the point code being added in this procedure is not an ITU-I or 14-bit ITU-N spare point code, skip this step and to to step 6.

**NOTE:** If the point code being added in this procedure is an ITU-I or 14-bit ITU-N spare point code and the screening reference contains ITU-I or 14-bit ITU-N spare point codes, skip this step and go to step 6.

5. Display the status of the ITU National and International Spare Point Code Support feature by entering the `rtrv-ctrl-feat` command with the ITU National and International Spare Point Code Support feature part number. Enter this command.

```
rtrv-ctrl-feat:partnum=893013601
```

This is an example of the possible output.

```
rlghncxa03w 05-09-25 15:25:30 GMT EAGLE5 34.0.0  
The following features have been permanently enabled:
```

Feature Name	Partnum	Status	Quantity
Spare Point Code Support	893013601	on	----

The following features have been temporarily enabled:

Feature Name	Partnum	Status	Quantity	Trial Period Left
Zero entries found.				

The following features have expired temporary keys:

Feature Name	Partnum
Zero entries found.	

If the ITU National and International Spare Point Code Support feature is enabled, go to step 6.

If the ITU National and International Spare Point Code Support feature is not enabled, perform the “Activating the ITU National and International Spare Point Code Support Feature” procedure in the *Database Administration Manual - SS7* to enable the ITU National and International Spare Point Code Support feature as required. After the feature has been enabled, go to step 6.

---

6. Add the new allowed AFTPC screen to the database using the `ent-scr-aftpc` command.



**CAUTION:** The EAGLE 5 SAS does not support redirecting MSUs for the DTA feature or intercepting ISUP IAM messages for the Calling Name Conversion Facility feature from the allowed AFTPC screen. Gateway screening stop action sets containing either the RDCT (redirect) or CNCF (calling name conversion facility) stop actions should not be assigned to the allowed AFTPC screen. If a gateway screening stop action set containing the RDCT or CNCF stop actions is specified with the `ent-scr-aftpc` command, unsolicited information message (UIM) 1127 is generated when the attempt is made to redirect MSUs from the allowed AFTPC screen. Unsolicited information message (UIM) 1217 is generated when ISUP IAM MSUs are intercepted from the allowed AFTPC screen. For more information on UIMs 1127 and 1217, go to the *Maintenance Manual*.

If a gateway screening stop action is to be assigned to the allowed AFTPC screen being changed, enter the `ent-scr-aftpc` command with the `nsfi=stop` parameter and the `actname` parameter with the name of a gateway screening stop action set shown in the output of the `rtrv-gws-actset` command executed in step 4.

The following list contains the values for `ni`, `nc`, `ncm`, `zone`, `area`, `id`, `npc`, `msa`, `ssa`, `sp`, and `ssn` parameters:

- `ni` – 0 - 255 or an asterisk (\*)
- `nc` – 0 - 255 or an asterisk (\*)
- `ncm` – 0 - 255 or an asterisk (\*)
- `zone` – 0 - 7 or an asterisk (\*)
- `area` – 0 - 255 or an asterisk (\*)
- `id` – 0 - 7 or an asterisk (\*)
- `npc` – 1 - 16383 or an asterisk (\*)
- `msa` – 0 - 255 or an asterisk (\*)
- `ssa` – 0 - 255 or an asterisk (\*)
- `sp` – 0 - 255 or an asterisk (\*)
- `ssn` – 0 - 255 or an asterisk (\*)

A range of values can be specified for the `ni`, `nc`, and `ncm` parameters. See the “Specifying a Range of Values” section on page 3-4 for more information on how the asterisk and a range of values are used for the `ni`, `nc`, and `ncm` parameters.

## Allowed Affected Point Code (AFTPC) Screen Configuration

To add a spare point code to the allowed AFTPC screen, the **pcst=s** parameter must be specified. To add a non-spare point code to the allowed AFTPC screen, the **pcst** parameter does not have to be specified. If the **pcst** parameter is specified for a screen containing an ITU-I or 14-bit ITU-N non-spare point code, the value must be **none**.

For this example, enter these commands.

```
ent-scr-aftpc:sr=gw20:ni=008:nc=008:ncm=008:ssn=250:nsfi=stop
:actname=copy
```

A message similar to the following should appear.

```
rlghncxa03w 05-09-25 15:27:30 GMT EAGLE5 34.0.0
ENT-SCR-AFTPC: SCREEN SET AFFECTED - GW20 1% FULL
ENT-SCR-AFTPC: MASP A - COMPLTD
```

```
ent-scr-aftpc:sr=ls04:ni=010:nc=010:ncm=010:ssn=015:nsfi=stop
:actname=copy
```

A message similar to the following should appear.

```
rlghncxa03w 05-09-25 15:28:30 GMT EAGLE5 34.0.0
ENT-SCR-AFTPC: SCREEN SET AFFECTED - LS04 1% FULL
ENT-SCR-AFTPC: MASP A - COMPLTD
```

- 
7. Verify the changes using the **rtrv-scr-aftpc** command with the screening reference name used in step 6. For this example, enter these commands.

```
rtrv-scr-aftpc:sr=gw20
```

The following is an example of the possible output.

```
rlghncxa03w 05-09-25 15:29:30 GMT EAGLE5 34.0.0
SCREEN = ALLOWED AFTPC
SR      NI      NC      NCM      SSN      NSFI      NSR/ACT
GW20   008      008      008      250      STOP      COPY
```

```
rtrv-scr-aftpc:sr=ls04
```

The following is an example of the possible output.

```
rlghncxa03w 05-09-25 15:30:30 GMT EAGLE5 34.0.0
SCREEN = ALLOWED AFTPC
SR      NI      NC      NCM      SSN      NSFI      NSR/ACT
LS04   010      010      010      015      STOP      COPY
```

- 
8. Backup the new changes using the **chg-db:action=backup:dest=fixed** command. The following messages should appear, the active Maintenance and Administration Subsystem Processor (MASP) appears first.

```
BACKUP (FIXED) : MASP A - Backup starts on active MASP.
BACKUP (FIXED) : MASP A - Backup on active MASP to fixed disk complete.
BACKUP (FIXED) : MASP A - Backup starts on standby MASP.
BACKUP (FIXED) : MASP A - Backup on standby MASP to fixed disk complete.
```

---

# Allowed Affected Point Code (AFTPC) Screen Configuration

Flowchart 3-2. Adding an Allowed Affected Point Code Screen (Sheet 1 of 3)

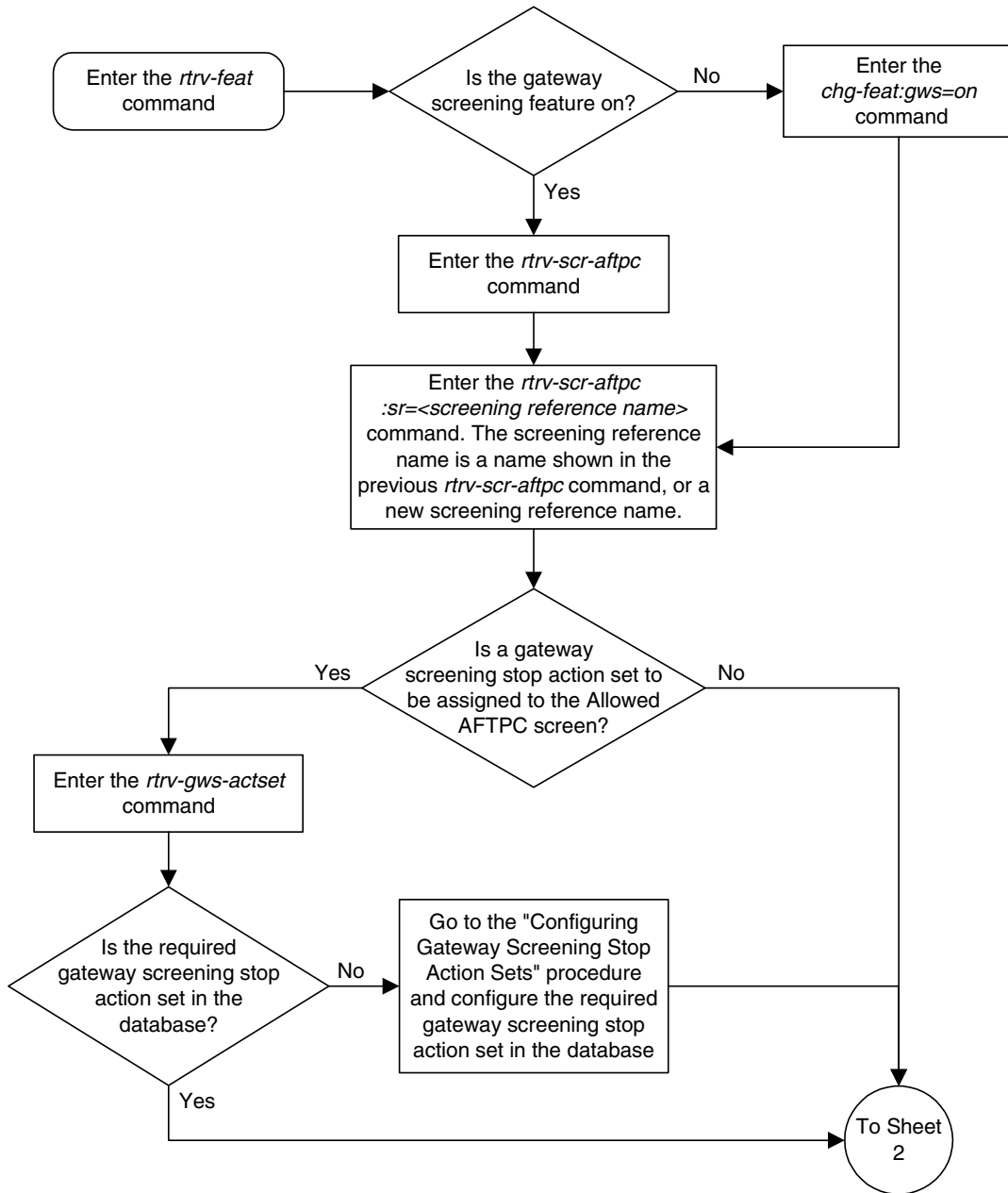

Flowchart 3-2. Adding an Allowed Affected Point Code Screen (Sheet 2 of 3)

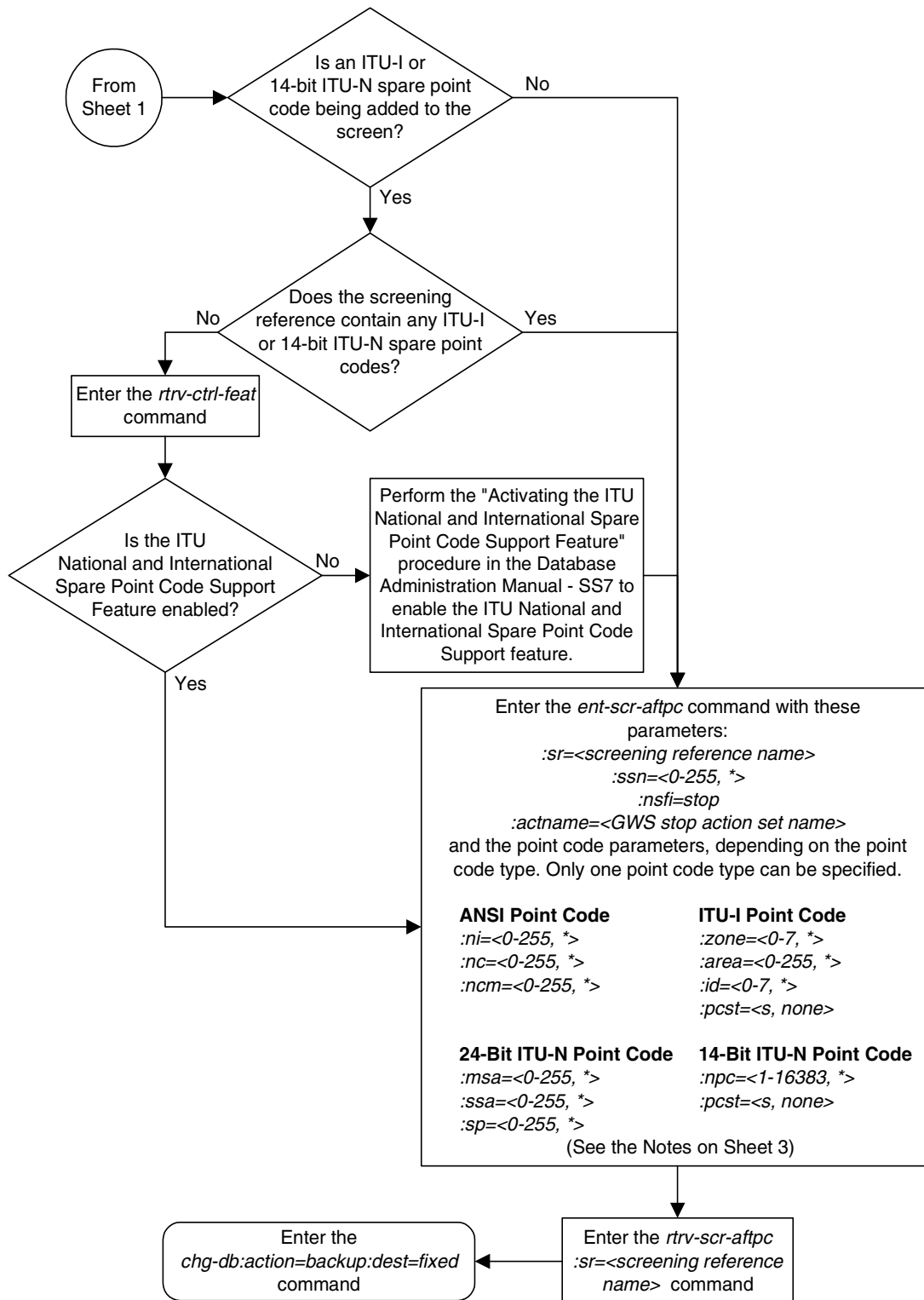



## Allowed Affected Point Code (AFTPC) Screen Configuration

### Flowchart 3-2. Adding an Allowed Affected Point Code Screen (Sheet 3 of 3)

**Notes:**

1. A range of values can be specified for the *ni*, *nc*, or *ncm* parameters by inserting double ampersands (&&) between the parameter values defining the range. For example, to specify the range 025 to 200 for the *ni* parameter, enter 025&&200 for the *ni* parameter value.
2. The asterisk (\*) specifies the entire range of values for that parameter.  
For more information about specifying a range of values and about using the asterisk, see the "Gateway Screening Attributes" section in Chapter 2 and the "Specifying a Range of Values" section in this procedure.
3. The *actname* parameter is optional. If the *actname* parameter is specified, the *actname* parameter value is one of the gateway screening stop action set names shown in the *rtrv-gws-actset* output on Sheet 1.
4. To add a non-spare point code, the *pcst* parameter does not have to be specified. If the *pcst* parameter is specified for a screen containing an ITU-I or 14-bit ITU-N non-spare point code, the value must be *none*.
5. To add a spare point code, the *pcst=s* parameter must be specified.

## Removing an Allowed Affected Point Code Screen

This procedure is used to remove an allowed affected point code (AFTPC) screen from the database using the `dlt-scr-aftpc` command. The parameters used by the `dlt-scr-aftpc` command are shown in the “Gateway Screening Attributes” section on page 2-7. The general rules that apply to configuring gateway screening entities are shown in the “Gateway Screening Configuration” section on page 2-28.

The example in this procedure removes the allowed AFTPC screen `wrd0` from the database.

**NOTE:** If you using multiple-part ITU national point codes with gateway screening, see “14-Bit ITU National Point Code Formats” on page 2-24.

### Procedure

---

1. Display the allowed AFTPC screens in the database using the `rtrv-scr-aftpc` command. The following is an example of the possible output.

```
rlghncxa03w 05-09-25 15:25:30 GMT EAGLE5 34.0.0
SCREEN = ALLOWED AFTPC
SR    REF  RULES
GW20  YES   1
IEC   YES   2
LS04  YES   1
WRD0  YES   1
WRD2  YES   1
WRD4  YES   9
```

From the `rtrv-scr-aftpc` output, display the allowed AFTPC screen you wish to remove using the `rtrv-scr-aftpc` command with the screening reference name. For this example, enter the `rtrv-scr-aftpc:sr=wrd0` command. The following is an example of the possible output.

```
rlghncxa03w 05-09-25 15:25:30 GMT EAGLE5 34.0.0
SCREEN = ALLOWED AFTPC
SR    ZONE  AREA  ID      SSN      NSFI      NSR/ACT
WRD0  1       004   6       023      STOP      -----
```

---

2. An allowed AFTPC screen can only be referenced by an allowed CDPA screen. Verify any references to the allowed AFTPC screen being removed from the database using the `rtrv-scr-cdpa:nsfi=aftpc` command. The following is an example of the possible output.

```
rlghncxa03w 05-09-25 15:26:30 GMT EAGLE5 34.0.0
SCREEN = ALLOWED CDPA
SR    ZONE  AREA  ID      SSN      SCMGFID  NSFI      NSR/ACT
IEC   1       134   *       001      002      AFTPC    IEC

SR    ZONE  AREA  ID      SSN      SCMGFID  NSFI      NSR/ACT
WRD1  1       004   6       001      005      AFTPC    WRD0

SR    NPC
WRD4  12345          001      100      AFTPC    IEC
```

## Allowed Affected Point Code (AFTPC) Screen Configuration

If the screen being removed is referenced by any CDPA screens, go to the "Changing an Allowed Called Party Address Screen" procedure on page 4-22 and change the NSFI of those CDPA screens to reference other AFTPC screens or change the NSFI of these screens to STOP.

---

3. Remove the allowed AFTPC screen from the database using the **dlt-scr-aftpc** command with the screening reference name shown in the **rtrv-scr-aftpc** output in step 1 and with the point code parameter values (**ni, nc, ncm, or zone, area, id, or npc, or msa, ssa, sp**) and the **ssn** parameter value of the screen being removed from the database. The values for these parameters must be entered exactly as shown in the **rtrv-scr-aftpc** output.

To remove an entry containing either an ITU-I or a 14-bit ITU-N spare point code, the **pcst=s** parameter must be specified with the **dlt-scr-aftpc** command.

To remove an entry containing either an ITU-I or a 14-bit ITU-N non-spare point code, the **pcst** parameter does not have to be specified with the **dlt-scr-aftpc** command. If the **pcst** parameter is specified, the value must be **none**.

For this example, enter this command.

```
dlt-scr-aftpc:sr=wrld0:zone=1:area=004:id=6:ssn=023
```

A message similar to the following should appear.

```
rlghncxa03w 05-09-25 15:29:30 GMT EAGLE5 34.0.0
DLT-SCR-AFTPC: SCREEN SET AFFECTED - WRD0 0% FULL
DLT-SCR-AFTPC: MASP A - COMPLTD
```

---

4. Verify the changes using the **rtrv-scr-aftpc** command with screening reference name used in step 3. For this example, enter this command.

```
rtrv-scr-aftpc:sr=wrld0
```

The following message should appear.

```
E2573 Cmd Rej: SR or NSR does not reference an existing SR
```

This message shows that the specified screening reference name is not in the database and the action of the **dlt-scr-aftpc** command in step 5 was successful. If the specified screening reference name contained more than one entry when the **dlt-scr-aftpc** command was executed in step 4, the **rtrv-scr-aftpc:sr=** command output would show the remaining entries in the screening reference instead of error message E2573.

---

5. Backup the new changes using the **chg-db:action=backup:dest=fixed** command. The following messages should appear, the active Maintenance and Administration Subsystem Processor (MASP) appears first.

```
BACKUP (FIXED) : MASP A - Backup starts on active MASP.
BACKUP (FIXED) : MASP A - Backup on active MASP to fixed disk complete.
BACKUP (FIXED) : MASP A - Backup starts on standby MASP.
BACKUP (FIXED) : MASP A - Backup on standby MASP to fixed disk complete.
```

---

**Flowchart 3-3.** Removing an Allowed Affected Point Code Screen

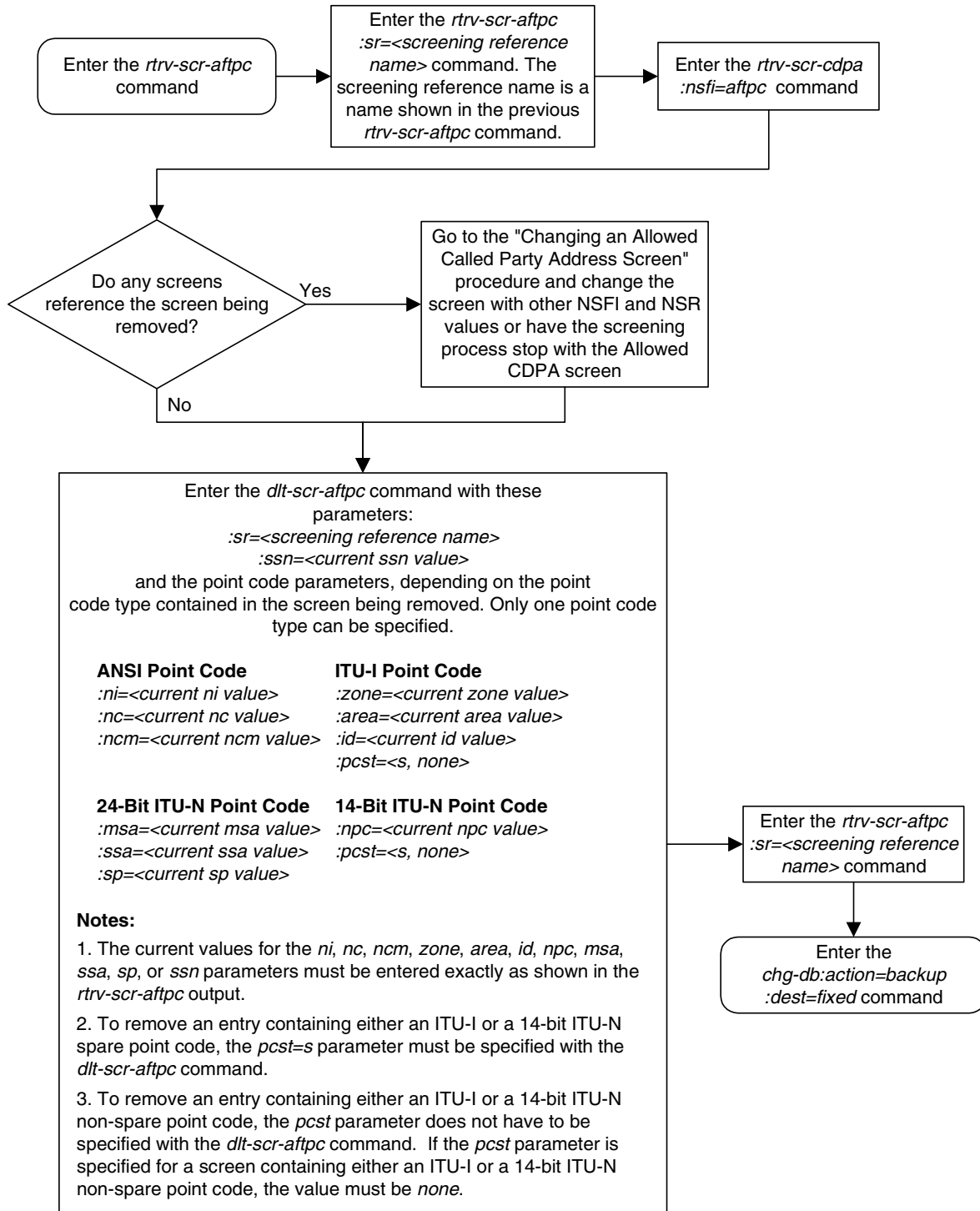

## Changing an Allowed Affected Point Code Screen

This procedure is used to change the attributes of an allowed affected point code (AFTPC) screen in the database using the `chg-scr-aftpc` command. The parameters used by the `chg-scr-aftpc` command are shown in the “Gateway Screening Attributes” section on page 2-7. The general rules that apply to configuring gateway screening entities are shown in the “Gateway Screening Configuration” section on page 2-28.

The example in this procedure is used to change the point code 009-009-009 for the allowed AFTPC screen `gw21` to 100-100-100, and the subsystem number from 253 to 150.

**NOTE:** If you using multiple-part ITU national point codes with gateway screening, see “14-Bit ITU National Point Code Formats” on page 2-24.

### Specifying a Range of Values

A range of values can be specified for the point code parameters `ni`, `nc`, or `ncm`.

If a range of values is specified for any of these parameters, and the value of the other parameters match existing values for the screening reference name, the range of values for the point code parameter cannot include any values for that parameter that are currently provisioned for the screening reference name.

For example, screening reference name `scr1` contains these entries:

SR	NI	NC	NCM	SSN	NSFI	NSR/ACT
SCR1	240	001	010	012	STOP	-----
SCR1	241	010	020	015	STOP	-----

Another entry for screening reference `scr1` with the `ni` value of 240 and the `nc` value of 001 cannot be specified if the range of values for the `ncm` parameter includes the value 010.

The ANSI point code parameter values can be specified as a single value, a range of values, or with an asterisk (\*). The asterisk specifies all possible values for the `ni`, `nc`, and `ncm` parameters. Table 3-5 shows the valid combinations of these parameter values.

**Table 3-5.** Valid Value Combinations for ANSI Point Code Parameters

NI	NC	NCM
Single Value	Single Value	Single Value
Single Value	Single Value	Range of Values
Single Value	Single Value	Asterisk
Single Value	Range of Values	Asterisk
Single Value	Asterisk	Asterisk

**Table 3-5.** Valid Value Combinations for ANSI Point Code Parameters (Continued)

NI	NC	NCM
Range of Values	Asterisk	Asterisk
Asterisk	Asterisk	Asterisk

A range of values can also be specified for an ITU-I or 24-bit ITU-N point code parameter using a combination of asterisks (\*) and single values for the point code parameters. Table 3-6 shows the valid combinations of the ITU-I parameter values. Table 3-7 shows the valid combinations of the 24-bit ITU-N parameter values.

**Table 3-6.** Valid Value Combinations for ITU-I Point Code Parameters

ZONE	AREA	ID
Single Value	Single Value	Single Value
Single Value	Single Value	Asterisk
Single Value	Asterisk	Asterisk
Asterisk	Asterisk	Asterisk

**Table 3-7.** Valid Value Combinations for 24-Bit ITU-N Point Code Parameters

MSA	SSA	SP
Single Value	Single Value	Single Value
Single Value	Single Value	Asterisk
Single Value	Asterisk	Asterisk
Asterisk	Asterisk	Asterisk

**Procedure**

---

1. Display the allowed AFTPC screens in the database using the **rtrv-scr-aftpc** command. The following is an example of the possible output.

```
rlghncxa03w 05-09-25 15:25:30 GMT EAGLE5 34.0.0
SCREEN = ALLOWED AFTPC
SR   REF  RULES
GW20 YES   1
GW21 YES   1
IEC  YES   2
LS04 YES   1
WRD0 YES   1
WRD2 YES   1
WRD4 YES   9
```

From the **rtrv-scr-aftpc** output, display the allowed AFTPC screen you wish to change using the **rtrv-scr-aftpc** command with the screening reference name. For this example, enter this command.

**rtrv-scr-aftpc:sr=gw21**

The following is an example of the possible output.

```
rlghncxa03w 05-09-25 15:25:30 GMT EAGLE5 34.0.0
SCREEN = ALLOWED AFTPC
SR   NI      NC      NCM      SSN      NSF1      NSR/ACT
GW21 009      009      009      253      STOP      -----
```

If a gateway screening stop action set is to be assigned to the allowed AFTPC screen being changed in this procedure, go to step 2. Otherwise, skip step 2 and go to step 3.

2. Display the gateway screening stop action sets in the database with the **rtrv-gws-actset** command. This is an example of the possible output.

```
rlghncxa03w 05-09-25 15:26:30 GMT EAGLE5 34.0.0
ACT ACT  ACT ACT  ACT ACT  ACT ACT  ACT ACT  ACT ACT
ID  NAME  1    2    3    4    5    6    7    8    9    10
--  ----  - - - - - - - - - - - - - - - - - - - - - - - - - - - - - - - -
1   copy  copy
2   rdct  rdct
3   cr    copy rdct
4   cncf  cncf
5   cpcncf copy cncf
6   cncfrd cncf rdct
7   cpcfrd copy cncf rdct
```

GWS action set table is (7 of 16) 44% full

If the required gateway screening stop action set is not in the database, go to the “Configuring Gateway Screening Stop Action Sets” procedure on page 2-54 and configure the required gateway screening stop action set.

---

**NOTE:** If any of these conditions apply to this procedure, skip this step and go to step 4:

- The point code in the screen is not being changed.
  - The screen being changed contains either an ANSI or 24-bit ITU-N point code.
  - The ITU-I or 14-bit ITU-N non-spare point code in the screen is not being changed to an ITU-I or 14-bit ITU-N spare point code.
  - The point code in the screen is an ITU-I or 14-bit ITU-N spare point code or the screening reference contains other screens with ITU-I or 14-bit ITU-N spare point codes.
3. Display the status of the ITU National and International Spare Point Code Support feature by entering the `rtrv-ctrl-feat` command with the ITU National and International Spare Point Code Support feature part number. Enter this command.

```
rtrv-ctrl-feat:partnum=893013601
```

This is an example of the possible output.

```
rlghncxa03w 05-09-25 15:25:30 GMT EAGLE5 34.0.0
The following features have been permanently enabled:
```

Feature Name	Partnum	Status	Quantity
Spare Point Code Support	893013601	on	----

```
The following features have been temporarily enabled:
```

Feature Name	Partnum	Status	Quantity	Trial Period Left
Zero entries found.				

```
The following features have expired temporary keys:
```

Feature Name	Partnum
Zero entries found.	

If the ITU National and International Spare Point Code Support feature is enabled, go to step 4.

If the ITU National and International Spare Point Code Support feature is not enabled, perform the “Activating the ITU National and International Spare Point Code Support Feature” procedure in the *Database Administration Manual - SS7* to enable the ITU National and International Spare Point Code Support feature as required. After the feature has been enabled, go to step 4.

---



## Allowed Affected Point Code (AFTPC) Screen Configuration

4. Change the attributes of an allowed AFTPC screen using the **chg-scr-aftpc** command.

If a gateway screening stop action is to be assigned to the allowed AFTPC screen being changed, enter the **chg-scr-aftpc** command with the **nsfi=stop** parameter and the **actname** parameter with the name of a gateway screening stop action set shown in the output of the **rtrv-gws-actset** command executed in step 2.

The current values for the **ni**, **nc**, **ncm**, **zone**, **area**, **id**, **npc**, **msa**, **ssa**, **sp**, and **ssn** parameters must be entered exactly as shown in the **rtrv-scr-aftpc** output in step 1.

The following list contains the values for the **nni**, **nnc**, **nncm**, **nzone**, **narea**, **nid**, **nnpc**, **nmsa**, **nssa**, **nsp**, and **nssn** parameters:

- **nni** – 0 - 255 or an asterisk (\*)
- **nnc** – 0 - 255 or an asterisk (\*)
- **nncm** – 0 - 255 or an asterisk (\*)
- **nzone** – 0 - 7 or an asterisk (\*)
- **narea** – 0 - 255 or an asterisk (\*)
- **nid** – 0 - 7 or an asterisk (\*)
- **nnpc** – 1 - 16383 or an asterisk (\*)
- **nmsa** – 0 - 255 or an asterisk (\*)
- **nssa** – 0 - 255 or an asterisk (\*)
- **nsp** – 0 - 255 or an asterisk (\*)
- **nssn** – 0 - 255 or an asterisk (\*)

A range of values can be specified for the **nni**, **nnc**, and **nncm** parameters. See the "Specifying a Range of Values" section on page 3-17 for more information on how the asterisk and a range of values are used for the **nni**, **nnc**, and **nncm** parameters.

To change an ITU-I or 14-bit ITU-N spare point code to a non-spare point code, both the **pcst=s** and **npcst=none** parameters must be specified with the **chg-scr-aftpc** command.

To change an ITU-I or 14-bit ITU-N non-spare point code to a spare point code, the **npcst=s** parameter must be specified with the **chg-scr-aftpc** command. The **pcst** parameter does not have to be specified.

If the current point code in the screen being changed is either an ITU-I or 14-bit ITU-N spare point code, the **pcst=s** parameter must be specified with the **chg-scr-aftpc** command.

If the current point code in the screen being changed is either an ITU-I or 14-bit ITU-N non-spare point code, the **pcst** parameter does not have to be specified with the **chg-scr-aftpc** command. If the **pcst** parameter is

specified for a screen containing either an ITU-I or 14-bit ITU-N non-spare point code, the `pcst` parameter value must be `none`.

For this example, enter this command.

```
chg-scr-aftpc:sr=gw21:ni=009:nc=009:ncm=009:ssn=253:nni=100
:nnc=100:nncm=100:nssn=150
```



**CAUTION:** The EAGLE 5 SAS does not support redirecting MSUs for the DTA feature or intercepting ISUP IAM messages for the Calling Name Conversion Facility feature from the allowed AFTPC screen. Gateway screening stop action sets containing either the RDCT (redirect) or CNCF (calling name conversion facility) stop actions should not be assigned to the allowed AFTPC screen. If a gateway screening stop action set containing the RDCT or CNCF stop actions is specified with the `chg-scr-aftpc` command, unsolicited information message (UIM) 1127 is generated when the attempt is made to redirect MSUs from the allowed AFTPC screen. Unsolicited information message (UIM) 1217 is generated when ISUP IAM MSUs are intercepted from the allowed AFTPC screen. For more information on UIMs 1127 and 1217, go to the *Maintenance Manual*.

A message similar to the following should appear.

```
rlghncxa03w 05-09-25 15:27:30 GMT EAGLE5 34.0.0
CHG-SCR-AFTPC: SCREEN SET AFFECTED - GW21 1% FULL
CHG-SCR-AFTPC: MASP A - COMPLTD
```

5. Verify the changes using the `rtrv-scr-aftpc` command with screening reference name used in step 4. For this example, enter this command.

```
rtrv-scr-aftpc:sr=gw21
```

The following is an example of the possible output.

```
rlghncxa03w 05-09-25 15:28:30 GMT EAGLE5 34.0.0
SCREEN = ALLOWED AFTPC
SR   NI      NC      NCM      SSN      NSF1     NSR/ACT
GW21 100      100      100      150      STOP     -----
```

6. Backup the new changes using the `chg-db:action=backup:dest=fixed` command. The following messages should appear, the active Maintenance and Administration Subsystem Processor (MASP) appears first.

```
BACKUP (FIXED) : MASP A - Backup starts on active MASP.
BACKUP (FIXED) : MASP A - Backup on active MASP to fixed disk complete.
BACKUP (FIXED) : MASP A - Backup starts on standby MASP.
BACKUP (FIXED) : MASP A - Backup on standby MASP to fixed disk complete.
```

## Allowed Affected Point Code (AFTPC) Screen Configuration

Flowchart 3-4. Changing an Allowed Affected Point Code Screen (Sheet 1 of 4)

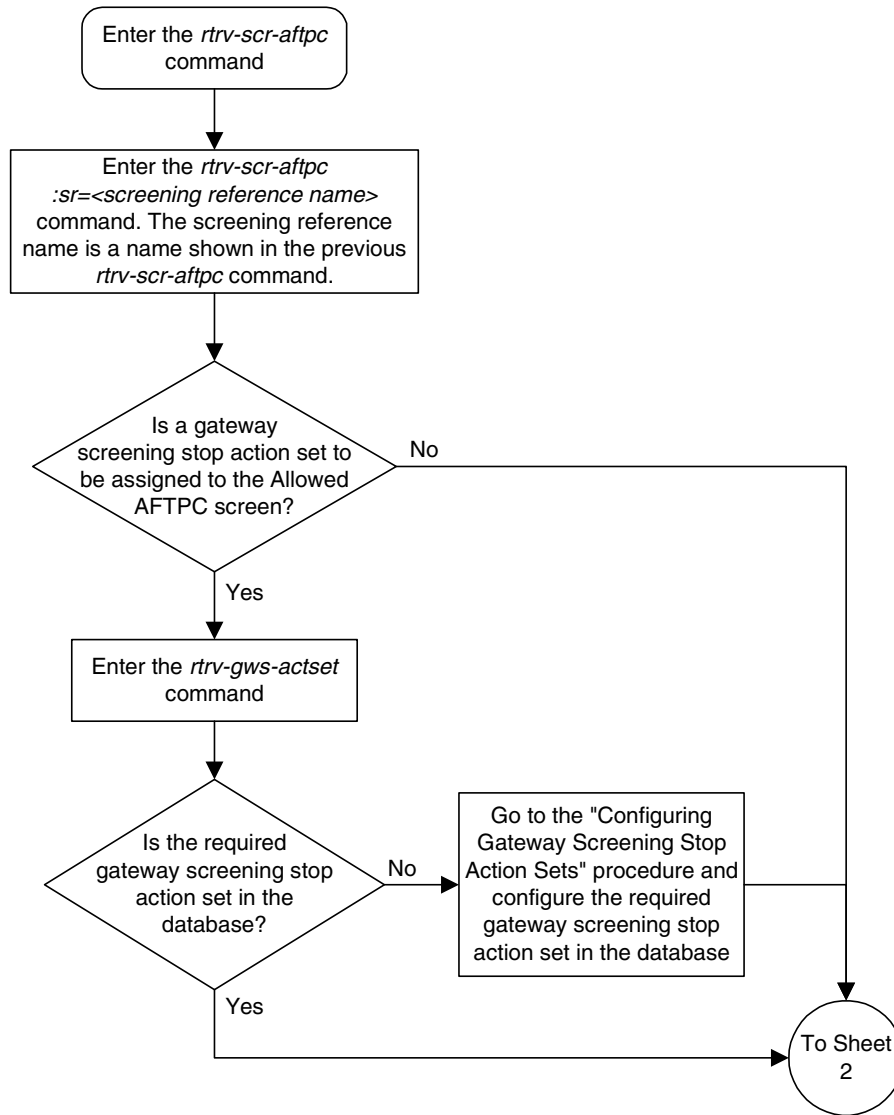

Flowchart 3-4. Changing an Allowed Affected Point Code Screen (Sheet 2 of 4)

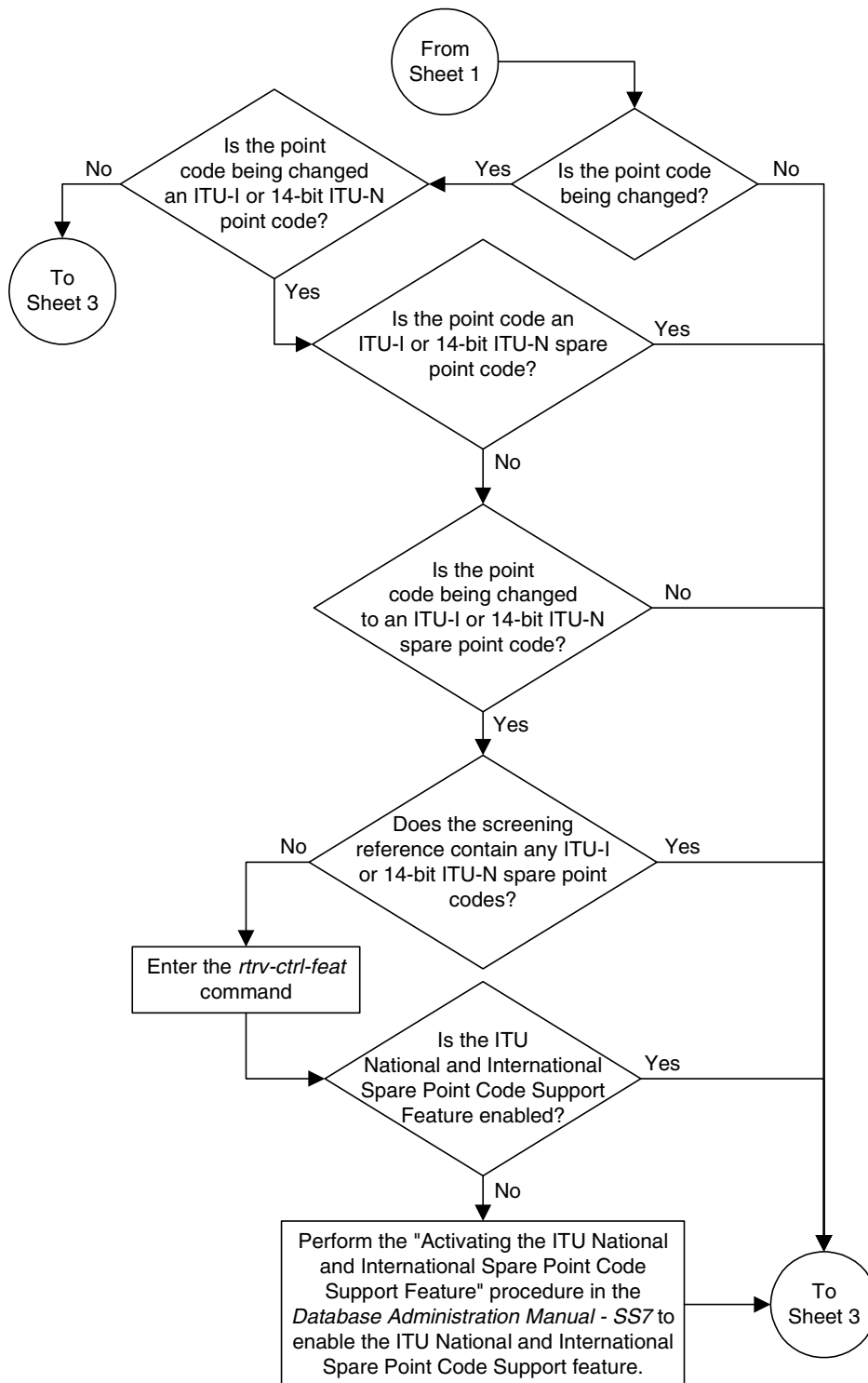

## Allowed Affected Point Code (AFTPC) Screen Configuration

Flowchart 3-4. Changing an Allowed Affected Point Code Screen (Sheet 3 of 4)

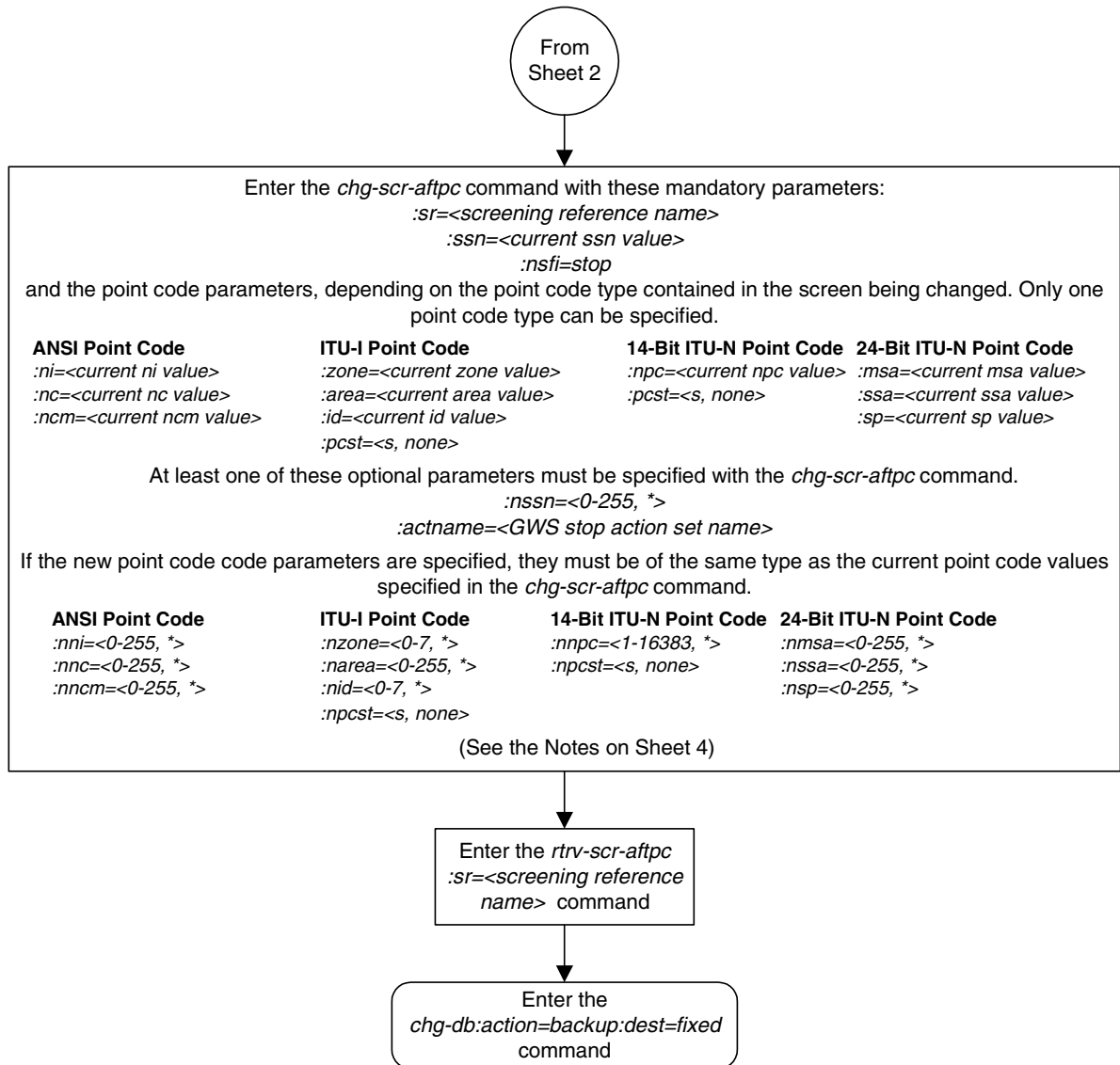

**Flowchart 3-4.** Changing an Allowed Affected Point Code Screen (Sheet 4 of 4)

**Notes:**

1. A range of values can be specified for the *ni*, *nc*, or *ncm* parameters by inserting double ampersands (&&) between the parameter values defining the range. For example, to specify the range 025 to 200 for the *ni* parameter, enter 025&&200 for the *ni* parameter value.
2. The current values for the *ni*, *nc*, *ncm*, *zone*, *area*, *id*, or *ssn* parameters must be entered exactly as shown in the *rtrv-scr-aftpc* output.
3. The asterisk (\*) specifies the entire range of values for that parameter.  
For more information about specifying a range of values and about using the asterisk, see the "Gateway Screening Attributes" section in Chapter 2 and the "Specifying a Range of Values" section in this procedure.
4. The *actname* parameter is optional. If the *actname* parameter is specified, the *actname* parameter value is one of the gateway screening stop action set names shown in the *rtrv-gws-actset* output on Sheet 1.
5. To change an ITU-I or 14-bit ITU-N spare point code to a non-spare point code, both the *pcst=s* and *npcst=none* parameters must be specified with the *chg-scr-aftpc* command.
6. To change an ITU-I or 14-bit ITU-N non-spare point code to a spare point code, the *npcst=s* parameter must be specified with the *chg-scr-aftpc* command. The *pcst* parameter does not have to be specified.
7. If the current point code in the screen being changed is either an ITU-I or 14-bit ITU-N spare point code, the *pcst=s* parameter must be specified with the *chg-scr-aftpc* command.
8. If the current point code in the screen being changed is either an ITU-I or 14-bit ITU-N non-spare point code, the *pcst* parameter does not have to be specified with the *chg-scr-aftpc* command. If the *pcst* parameter is specified for a screen containing either an ITU-I or 14-bit ITU-N non-spare point code, the *pcst* parameter value must be *none*.

# 4

## Allowed Called Party (CDPA) Screen Configuration

Introduction.....	4-2
Adding an Allowed Called Party Address Screen .....	4-5
Removing an Allowed Called Party Address Screen.....	4-17
Changing an Allowed Called Party Address Screen.....	4-22

### Introduction

The allowed called party address (CDPA) screen is used to screen SCCP messages for a DPC in the routing label and a subsystem number in the called party address. The gray shaded areas in Figure 4-1 shows the fields of the SS7 message that are checked by the CDPA screening function. The screening reference contains a list of point codes and subsystem number combinations. If a match is found, the **nsfi** is examined to determine the next step in the screening process. If the **nsfi** is equal to **stop**, the message is processed and no further screening takes place.

If the **nsfi** is equal to **stop**, and the **copy** gateway screening stop action is specified, the message is processed and a copy of the message is sent by the STP LAN feature to an external application through an ACM running the **stpplan** application or a DCM running the **vxwslan** application.

If the **nsfi** is equal to anything else, the next screening reference (**nsr**) is identified and the screening process continues to the next screen identified by the **nsfi** and **nsr** parameters. If no match is found, the message is discarded.

Flowchart 4-1 shows the screening action of the allowed CDPA screen.



Allowed Called Party (CDPA) Screen Configuration

Flowchart 4-1. Allowed CDPA Screening Action

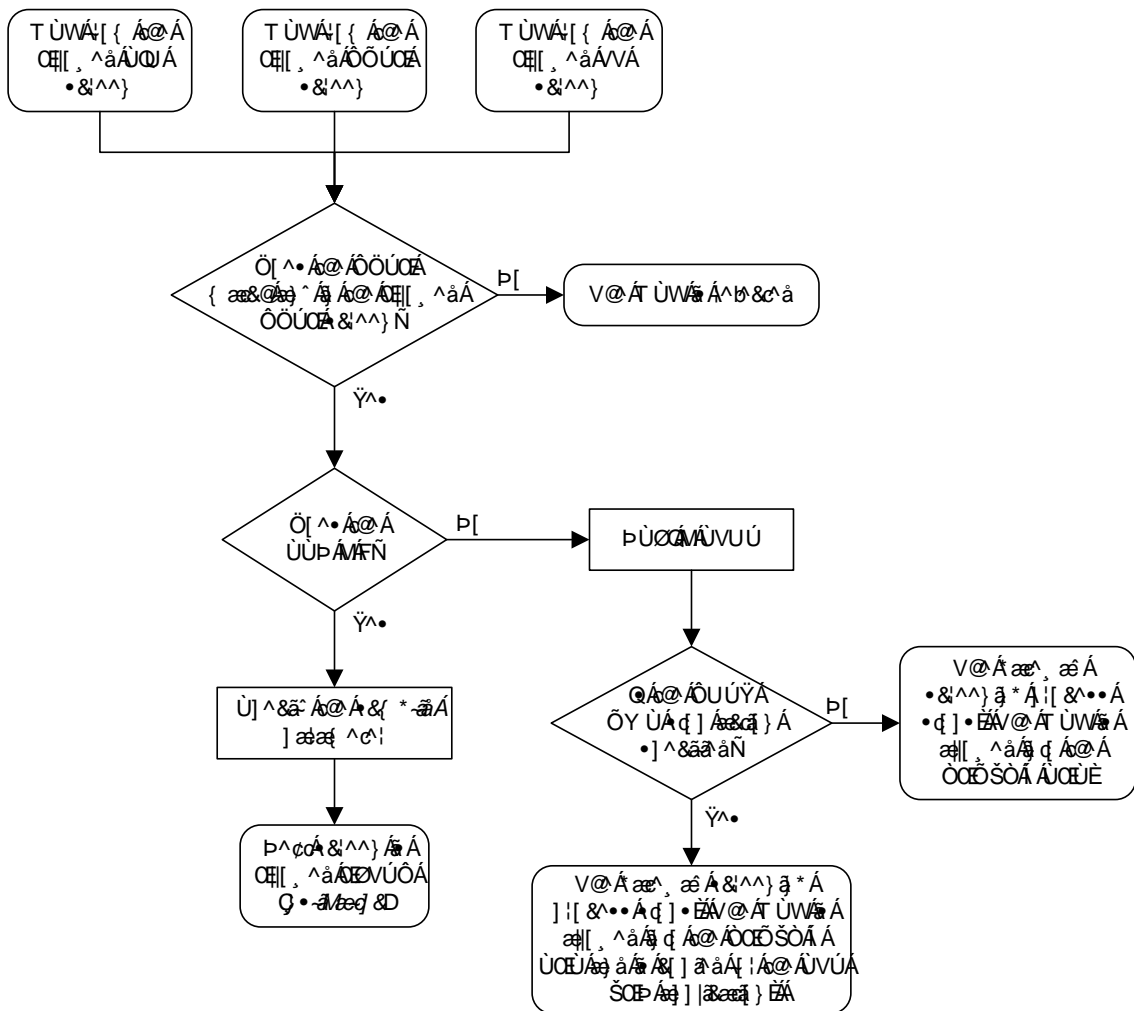

Figure 4-1. Allowed Called Party Address Screening Function

ANSI MSU (ANSI Message Signal Unit)

BSN FSN LI	SIO xx xx xxxx NIC PRI SI	SIF			
		Routing Label DPC OPC SLS NCM NC NI NCM NC NI xx	CGPA Length Address Indicator Subsystem Point Code (NCM NC NI)	CDPA Length Address Indicator (x x xxxx xx) (x RI xxxx xx) Subsystem Point Code (NCM NC NI)	SCMG Data Length SCMG Format (xxxx xxxx) Point Code (NCM NC NI) Subsystem

ITU-I MSU (ITU International Message Signal Unit)

BSN FSN LI	SIO xx xx xxxx NIC PRI SI	SIF			
		Routing Label DPC OPC SLS ID AREA ZONE ID AREA ZONE xx	CGPA Length Address Indicator Subsystem Point Code (ID AREA ZONE)	CDPA Length Address Indicator (x x xxxx xx) (x RI xxxx xx) Subsystem Point Code (ID AREA ZONE)	SCMG Data Length SCMG Format (xxxx xxxx) Point Code (ID AREA ZONE) Subsystem

14-Bit ITU-N MSU (14-Bit ITU National Message Signal Unit)

BSN FSN LI	SIO xx xx xxxx NIC PRI SI	SIF			
		Routing Label DPC OPC SLS NPC NPC xx	CGPA Length Address Indicator Subsystem Point Code (NPC)	CDPA Length Address Indicator (x x xxxx xx) (x RI xxxx xx) Subsystem Point Code (NPC)	SCMG Data Length SCMG Format (xxxx xxxx) Point Code (NPC) Subsystem

24-Bit ITU-N MSU (24-bit ITU National Message Signal Unit)

BSN FSN LI	SIO xx xx xxxx NIC PRI SI	SIF			
		Routing Label DPC OPC SLS SP SSA MSA SP SSA MSA xx	CGPA Length Address Indicator Subsystem Point Code (SP SSA MSA)	CDPA Length Address Indicator (x x xxxx xx) (x RI xxxx xx) Subsystem Point Code (SP SSA MSA)	SCMG Data Length SCMG Format (xxxx xxxx) Point Code (SP SSA MSA) Subsystem

## Adding an Allowed Called Party Address Screen

This procedure is used to add an allowed called party address (CDPA) screen to the database using the `ent-scr-cdpa` command. The parameters used by the `ent-scr-cdpa` command are shown in the “Gateway Screening Attributes” section on page 2-7. The general rules that apply to configuring gateway screening entities are shown in the “Gateway Screening Configuration” section on page 2-28.

The examples in this procedure are used to add the allowed CDPA screen data shown in Table 4-1 and based on the example configurations shown in Figure 2-3 on page 2-33 through Figure 2-6 on page 2-39.

**Table 4-1.** Example Gateway Screening Allowed CDPA Configuration Table

Screening Reference	ZONE	AREA	ID	SSN	SCMGFID	NSFI	NSR
gw15	5	117	2	254	----	stop	----
Screening Reference	NI	NC	NCM	SSN	SCMGFID	NSFI	NSR
gw17	003	003	003	001	050	aftpc	gw20
gw18	006	006	006	253	----	stop	----
ls03	007	007	007	001	100	aftpc	ls04

**NOTE:** If you using multiple-part ITU national point codes with gateway screening, see “14-Bit ITU National Point Code Formats” on page 2-24.

The allowed CDPA screen can only reference an allowed AFTPC screen and the allowed AFTPC screen being referenced must be in the database. This can be verified using the `rtrv-scr-aftpc:all=yes` command. If the desired allowed AFTPC screen is not in the database, go to one of these procedures to add the required screen to the database or change an existing screen in the database.

- “Adding an Allowed Affected Point Code Screen” procedure on page 3-4
- “Changing an Allowed Affected Point Code Screen” procedure on page 3-17

### Specifying a Range of Values

A range of values can be specified for the point code parameters `ni`, `nc`, or `ncm`.

If a range of values is specified for any of these parameters, and the value of the other parameters match existing values for the screening reference name, the range of values for the point code parameter cannot include any values for that parameter that are currently provisioned for the screening reference name.

For example, screening reference name **scr1** contains these entries:

SR	NI	NC	NCM	SSN	SCMGFID	NSFI	NSR/ACT
SCR1	240	001	010	012	-----	STOP	-----
SCR1	241	010	020	001	002	AFTPC	SCR1

Another entry for screening reference **scr1** with the **ni** value of 240 and the **nc** value of 001 cannot be specified if the range of values for the **ncm** parameter includes the value 010.

The ANSI point code parameter values can be specified as a single value, a range of values, or with an asterisk (\*). The asterisk specifies all possible values for the **ni**, **nc**, and **ncm** parameters. Table 4-2 shows the valid combinations of these parameter values.

**Table 4-2.** Valid Value Combinations for ANSI Point Code Parameters

NI	NC	NCM
Single Value	Single Value	Single Value
Single Value	Single Value	Range of Values
Single Value	Single Value	Asterisk
Single Value	Range of Values	Asterisk
Single Value	Asterisk	Asterisk
Range of Values	Asterisk	Asterisk
Asterisk	Asterisk	Asterisk

A range of values can also be specified for an ITU-I or 24-bit ITU-N point code parameter using a combination of asterisks (\*) and single values for the point code parameters. Table 4-3 shows the valid combinations of the ITU-I parameter values. Table 4-4 shows the valid combinations of the 24-bit ITU-N parameter values.

**Table 4-3.** Valid Value Combinations for ITU-I Point Code Parameters

ZONE	AREA	ID
Single Value	Single Value	Single Value
Single Value	Single Value	Asterisk
Single Value	Asterisk	Asterisk
Asterisk	Asterisk	Asterisk

## Allowed Called Party (CDPA) Screen Configuration

**Table 4-4.** Valid Value Combinations for 24-Bit ITU-N Point Code Parameters

MSA	SSA	SP
Single Value	Single Value	Single Value
Single Value	Single Value	Asterisk
Single Value	Asterisk	Asterisk
Asterisk	Asterisk	Asterisk

### Procedure

---

1. Verify that the gateway screening feature is on, by entering the `rtrv-feat` command. If the gateway screening feature is on, the `GWS` field is set to `on`.

**NOTE:** The `rtrv-feat` command output contains other fields that are not used by this procedure. If you wish to see all the fields displayed by the `rtrv-feat` command, see the `rtrv-feat` command description in the *Commands Manual*.

If the gateway screening feature is on, shown by the entry `GWS = on` in the `rtrv-feat` command output, skip step 2, and go to step 3.

---

2. Turn the gateway screening feature on by entering this command.

```
chg-feat:gws=on
```

**NOTE:** Once the gateway screening feature is turned on with the `chg-feat` command, it cannot be turned off.

The gateway screening feature must be purchased before you turn this feature on with the `chg-feat` command. If you are not sure if you have purchased the gateway screening feature, contact your Tekelec Sales Representative or Account Representative.

When the `chg-feat` has successfully completed, this message should appear.

```
rlghncxa03w 05-09-28 11:43:04 GMT EAGLE5 34.0.0  
CHG-FEAT: MASP A - COMPLTD
```

---

3. Display all allowed CDPA screens in the database using the `rtrv-scr-cdpa` command. The following is an example of the possible output.

```
rlghncxa03w 05-09-25 15:25:30 GMT EAGLE5 34.0.0
SCREEN = ALLOWED CDPA
SR    REF  RULES
IEC   YES   2
WRD2  YES   1
WRD4  YES   9
```

If the screening reference names that you wish to add with this procedure are not shown in the `rtrv-scr-cdpa` command output, go to step 4. For this example, the screening reference names are not shown. If these screening reference names are shown in the `rtrv-scr-cdpa` command output, make sure the screening data you wish to enter is not already in the database by entering the `rtrv-scr-cdpa` command with the screening reference name. For example, enter the `rtrv-scr-cdpa:sr=iec` command.

The following is an example of the possible output.

```
rlghncxa03w 05-09-25 15:26:30 GMT EAGLE5 34.0.0
SCREEN = ALLOWED CDPA
SR    NI      NC      NCM      SSN      SCMGFID  NSFI      NSR/ACT
IEC   240     001     010     012     -----  STOP     -----

SR      ZONE   AREA   ID      SSN      SCMGFID  NSFI      NSR/ACT
IEC     1      134   *      001     002     AFTPC    IEC
```

If a gateway screening stop action set is to be assigned to the allowed CDPA screen being added to the database, go to step 4.

Step 4 verifies the gateway screening stop action set names in the database. The gateway screening stop action set names are assigned only if the NSFI of the screen being added in this procedure is STOP. If the NSFI of the new screen will be STOP, but a gateway screening stop action set name will not be assigned to the new screen, skip steps 4 and 5 and go to step 6. If the NSFI of the new screen is AFTPC, skip step 4 and go to step 5.

4. Display the gateway screening stop action sets in the database with the `rtrv-gws-actset` command. This is an example of the possible output.

```
rlghncxa03w 05-09-25 15:27:30 GMT EAGLE5 34.0.0
ACT  ACT  ACT  ACT  ACT  ACT  ACT  ACT  ACT  ACT  ACT  ACT
ID   NAME  1    2    3    4    5    6    7    8    9    10
--  -----
1    copy  copy
2    rdct  rdct
3    cr    copy rdct
4    cncf  cncf
5    cpcncf copy cncf
6    cncfrd cncf rdct
7    cpcf rd copy cncf rdct

GWS action set table is (7 of 16) 44% full
```

## Allowed Called Party (CDPA) Screen Configuration

If the required gateway screening stop action set is not in the database, go to the "Configuring Gateway Screening Stop Action Sets" procedure on page 2-54 and configure the required gateway screening stop action set.

---

**NOTE: If the NSFI of the screen being added in this procedure is STOP, skip step 5 and go to step 6.**

5. Enter the `rtrv-scr-aftpc` command to verify that the screen that will be specified by the NSFI/NSR parameter combination in step 7 is in the database.

If the desired screen is not in the database, go to one of these procedures and either add the desired screen to the database or change an existing screen in the database.

- "Adding an Allowed Affected Point Code Screen" procedure on page 3-4
- "Changing an Allowed Affected Point Code Screen" procedure on page 3-17

---

**NOTE: If the point code being added in this procedure is not an ITU-I or 14-bit ITU-N spare point code, skip this step and to to step 7.**

**NOTE: If the point code being added in this procedure is an ITU-I or 14-bit ITU-N spare point code and the screening reference contains ITU-I or 14-bit ITU-N spare point codes, skip this step and go to step 7.**

6. Display the status of the ITU National and International Spare Point Code Support feature by entering the `rtrv-ctrl-feat` command with the ITU National and International Spare Point Code Support feature part number. Enter this command.

```
rtrv-ctrl-feat:partnum=893013601
```

This is an example of the possible output.

```
rlghncxa03w 05-09-25 15:25:30 GMT EAGLE5 34.0.0
The following features have been permanently enabled:
```

Feature Name	Partnum	Status	Quantity
Spare Point Code Support	893013601	on	----

The following features have been temporarily enabled:

Feature Name	Partnum	Status	Quantity	Trial Period Left
Zero entries found.				

The following features have expired temporary keys:

Feature Name	Partnum
Zero entries found.	

If the ITU National and International Spare Point Code Support feature is enabled, go to step 6.

If the ITU National and International Spare Point Code Support feature is not enabled, perform the “Activating the ITU National and International Spare Point Code Support Feature” procedure in the *Database Administration Manual - SS7* to enable the ITU National and International Spare Point Code Support feature as required. After the feature has been enabled, go to step 7.

7. Add a new allowed CDPA screen to the database using the `ent-scr-cdpa` command.

If a gateway screening stop action is to be assigned to the allowed CDPA screen being added to the database, enter the `ent-scr-cdpa` command with the `nsfi=stop` parameter and the `actname` parameter with the name of a gateway screening stop action set shown in the output of the `rtrv-gws-actset` command executed in step 4.



**CAUTION:** The EAGLE 5 SAS does not support redirecting MSUs for the DTA feature or intercepting ISUP IAM messages for the Calling Name Conversion Facility feature from the allowed CDPA screen. Gateway screening stop action sets containing either the RDCT (redirect) or CNCF (calling name conversion facility) stop actions should not be assigned to the allowed CDPA screen. If a gateway screening stop action set containing the RDCT or CNCF stop actions is specified with the `ent-scr-cdpa` command, unsolicited information message (UIM) 1125 is generated when the attempt is made to redirect MSUs from the allowed CDPA screen. Unsolicited information message (UIM) 1215 is generated when ISUP IAM MSUs are intercepted from the allowed CDPA screen. For more information on UIMs 1125 and 1215, go to the *Maintenance Manual*.

The following list contains the values for `ni`, `nc`, `ncm`, `zone`, `area`, `id`, `npc`, `msa`, `ssa`, `sp`, `ssn`, and `scmgfid` parameters:

- `ni` – 0 - 255 or an asterisk (\*)
- `nc` – 0 - 255 or an asterisk (\*)
- `ncm` – 0 - 255 or an asterisk (\*)
- `zone` – 0 - 7 or an asterisk (\*)
- `area` – 0 - 255 or an asterisk (\*)
- `id` – 0 - 7 or an asterisk (\*)
- `npc` – 1 - 16383 or an asterisk (\*)
- `msa` – 0 - 255 or an asterisk (\*)
- `ssa` – 0 - 255 or an asterisk (\*)
- `sp` – 0 - 255 or an asterisk (\*)
- `ssn` – 0 - 255 or an asterisk (\*)
- `scmgfid` – 1 - 255 or an asterisk (\*)



## Allowed Called Party (CDPA) Screen Configuration

**NOTE:** The `scmgfid`, `ssn`, `nsfi`, and `nsr` parameters can be specified only as shown in Table 4-5.

**Table 4-5.** CDPA Parameter Combinations

SSN	SCMGFID	NSFI	NSR
1	1 - 255, *	AFTPC	Must be specified
0, 2-255, *	Cannot be specified	STOP	Cannot be specified

A range of values can be specified for the `ni`, `nc`, and `ncm` parameters. See the “Specifying a Range of Values” section on page 4-5 for more information on how the asterisk and a range of values are used for the `ni`, `nc`, and `ncm` parameters.

To add a spare point code to the allowed CDPA screen, the `pcst=s` parameter must be specified. To add a non-spare point code to the allowed CDPA screen, the `pcst` parameter does not have to be specified. If the `pcst` parameter is specified for a screen containing an ITU-I or 14-bit ITU-N non-spare point code, the value must be `none`.

For this example, enter these commands.

```
ent-scr-cdpa:sr=gw15:zone=5:area=117:id=2:ssn=254:nsfi=stop
```

A message similar to the following should appear.

```
rlghncxa03w 05-09-25 15:28:30 GMT EAGLE5 34.0.0
ENT-SCR-CDPA: SCREEN SET AFFECTED - GW15 1% FULL
ENT-SCR-CDPA: MASP A - COMPLTD
```

```
ent-scr-cdpa:sr=gw17:ni=003:nc=003:ncm=003:ssn=001:scmgfid=050
:nsfi=aftpc:nsr=gw20
```

A message similar to the following should appear.

```
rlghncxa03w 05-09-25 15:29:30 GMT EAGLE5 34.0.0
ENT-SCR-CDPA: SCREEN SET AFFECTED - GW17 1% FULL
ENT-SCR-CDPA: MASP A - COMPLTD
```

```
ent-scr-cdpa:sr=gw18:ni=006:nc=006:ncm=006:ssn=253:nsfi=stop
```

A message similar to the following should appear.

```
rlghncxa03w 05-09-25 15:30:30 GMT EAGLE5 34.0.0
ENT-SCR-CDPA: SCREEN SET AFFECTED - GW18 1% FULL
ENT-SCR-CDPA: MASP A - COMPLTD
```

```
ent-scr-cdpa:sr=ls03:ni=007:nc=007:ncm=007:ssn=001:scmgfid=100
:nsfi=aftpc:nsr=ls04
```

A message similar to the following should appear.

```
rlghncxa03w 05-09-25 15:31:30 GMT EAGLE5 34.0.0
ENT-SCR-CDPA: SCREEN SET AFFECTED - LS03 1% FULL
ENT-SCR-CDPA: MASP A - COMPLTD
```

8. Verify the changes using the **rtrv-scr-cdpa** command with the screening reference name used in step 7. For this example, enter these commands.

**rtrv-scr-cdpa:sr=gw15**

The following is an example of the possible output.

```
rlghncxa03w 05-09-25 15:32:30 GMT EAGLE5 34.0.0
SCREEN = ALLOWED CDPA
SR      ZONE  AREA  ID      SSN      SCMGFID  NSFI     NSR/ACT
GW15    5      117   2       254      -        STOP     -
```

**rtrv-scr-cdpa:sr=gw17**

The following is an example of the possible output.

```
rlghncxa03w 05-09-25 15:33:30 GMT EAGLE5 34.0.0
SCREEN = ALLOWED CDPA
SR      NI      NC      NCM      SSN      SCMGFID  NSFI     NSR/ACT
GW17    003     003     003     001      050     AFTPC    GW20
```

**rtrv-scr-cdpa:sr=gw18**

The following is an example of the possible output.

```
rlghncxa03w 05-09-25 15:34:30 GMT EAGLE5 34.0.0
SCREEN = ALLOWED CDPA
SR      NI      NC      NCM      SSN      SCMGFID  NSFI     NSR/ACT
GW18    006     006     006     253      -        STOP     -
```

**rtrv-scr-cdpa:sr=ls03**

The following is an example of the possible output.

```
rlghncxa03w 05-09-25 15:35:30 GMT EAGLE5 34.0.0
SCREEN = ALLOWED CDPA
SR      NI      NC      NCM      SSN      SCMGFID  NSFI     NSR/ACT
LS03    007     007     007     001      100     AFTPC    -
```

9. Backup the new changes using the **chg-db:action=backup:dest=fixed** command. The following messages should appear, the active Maintenance and Administration Subsystem Processor (MASP) appears first.

```
BACKUP (FIXED) : MASP A - Backup starts on active MASP.
BACKUP (FIXED) : MASP A - Backup on active MASP to fixed disk complete.
BACKUP (FIXED) : MASP A - Backup starts on standby MASP.
BACKUP (FIXED) : MASP A - Backup on standby MASP to fixed disk complete.
```

## Allowed Called Party (CDPA) Screen Configuration

Flowchart 4-2. Adding an Allowed Called Party Address Screen (Sheet 1 of 4)

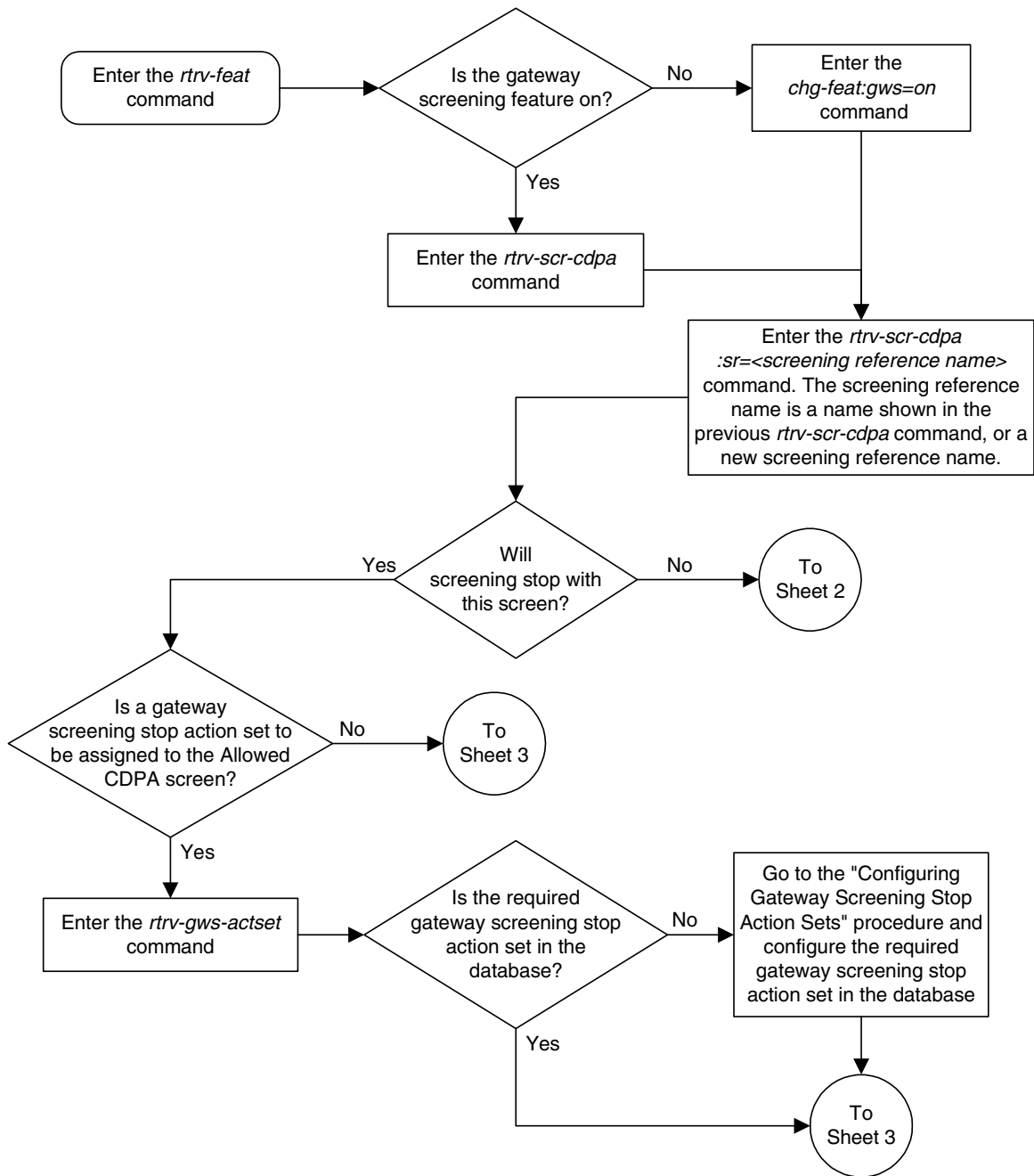

Flowchart 4-2. Adding an Allowed Called Party Address Screen (Sheet 2 of 4)

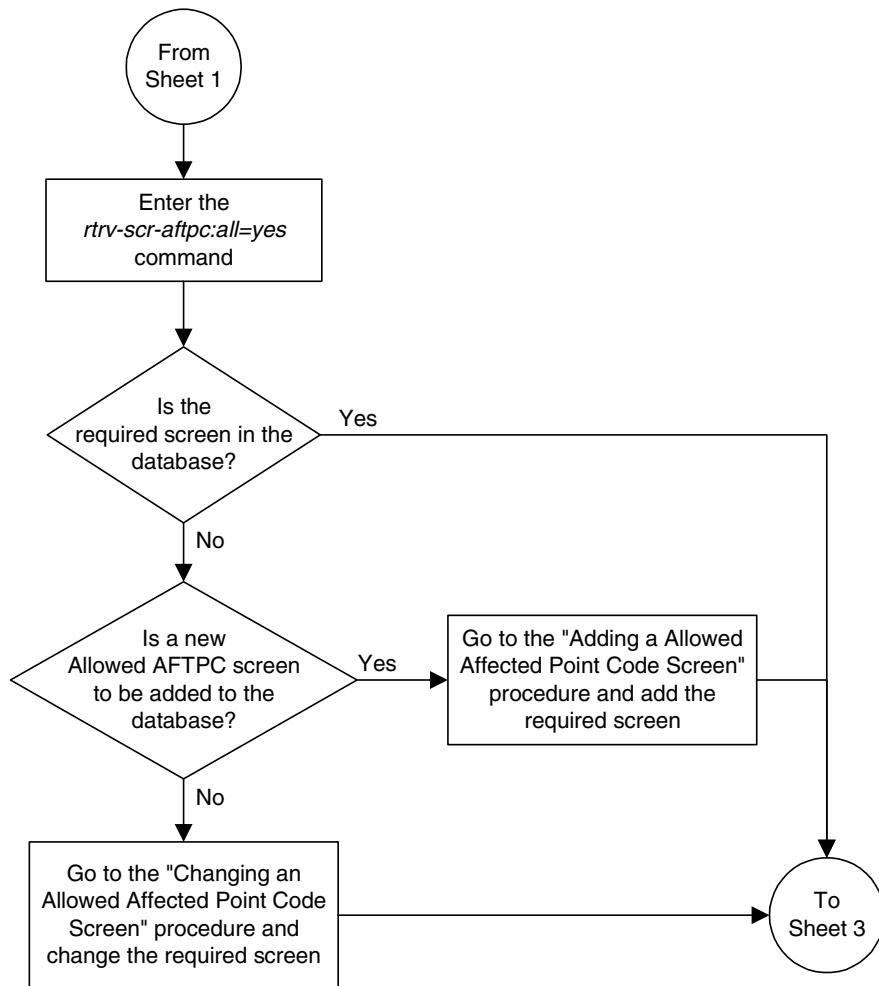

# Allowed Called Party (CDPA) Screen Configuration

**Flowchart 4-2.** Adding an Allowed Called Party Address Screen (Sheet 3 of 4)

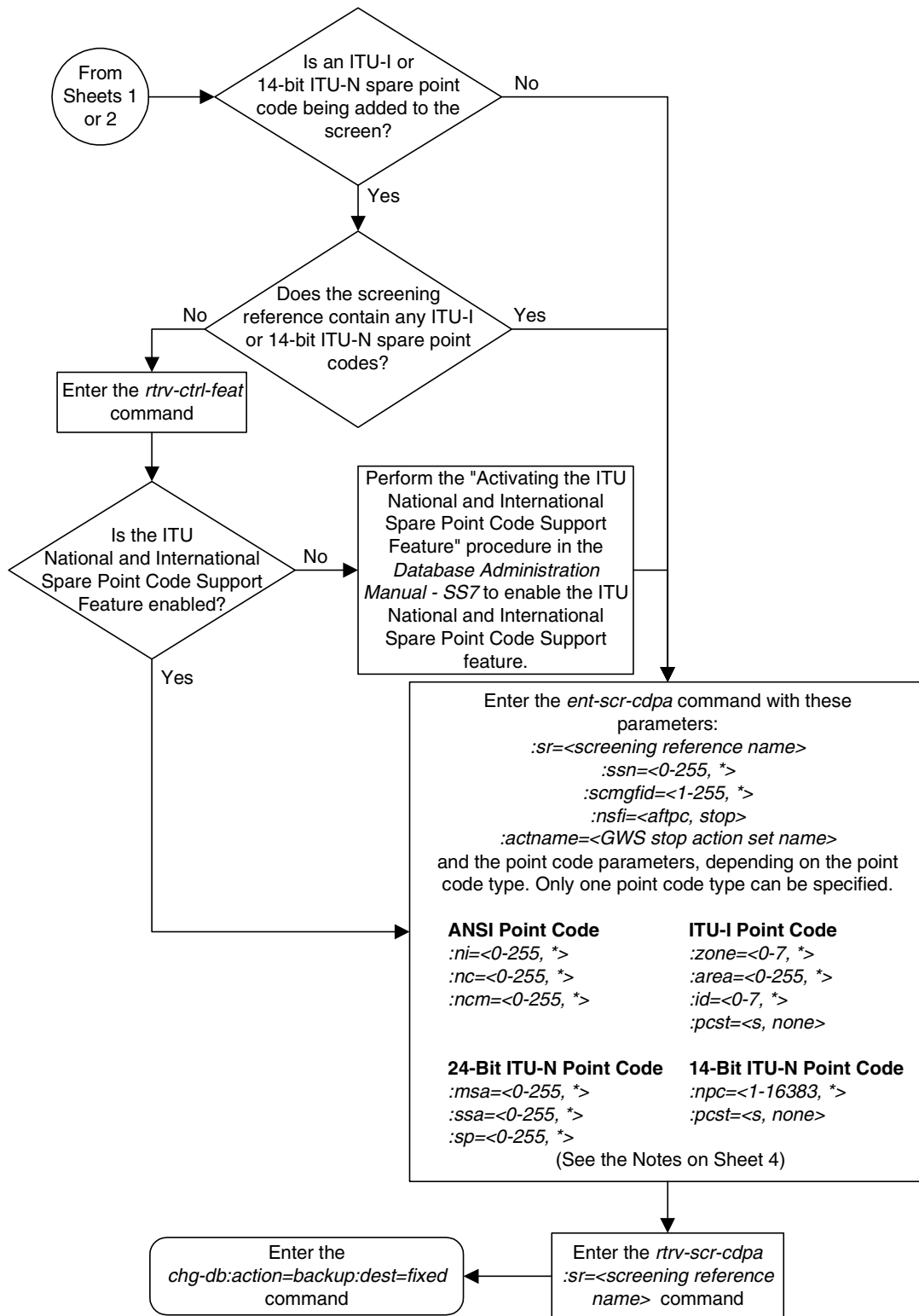

**Flowchart 4-2.** Adding an Allowed Called Party Address  
Screen (Sheet 4 of 4)

**Notes:**

1. A range of values can be specified for the *ni*, *nc*, or *ncm* parameters by inserting double ampersands (&&) between the parameter values defining the range. For example, to specify the range 025 to 200 for the *ni* parameter, enter 025&&200 for the *ni* parameter value.
2. The asterisk (\*) specifies the entire range of values for that parameter.  
For more information about specifying a range of values and about using the asterisk, see the "Gateway Screening Attributes" section in Chapter 2 and the "Specifying a Range of Values" section in this procedure.
3. The *scmgfid* parameter can be specified only if the *ssn=1* parameter is specified. If either the *ssn=1* or *scmgfid* parameter is specified, the other parameter must be specified. The *scmgfid* parameter cannot be specified if the *ssn* parameter value is 2 through 255, or \*.
4. To specify the *nsfi=atpc* parameter, the *ssn* parameter value must be 1.
5. If the *ssn* parameter value is 2 through 255, or \*, the *nsfi* parameter value must be *stop*.
6. If the *ssn* parameter value is 1, the *nsfi* parameter value can be *atpc* or *stop*.
7. The *nsr* parameter can be specified only, and must be specified, if the *nsfi=atpc* parameter is specified.
8. The *actname* parameter can be specified only if the *nsfi=stop* parameter is specified. The *actname* parameter is optional. If the *actname* parameter is specified, the *actname* parameter value is one of the gateway screening stop action set names shown in the *rtrv-gws-actset* output on Sheet 1.
9. To add a non-spare point code, the *pcst* parameter does not have to be specified. If the *pcst* parameter is specified for a screen containing an ITU-I or 14-bit ITU-N non-spare point code, the value must be *none*.
10. To add a spare point code, the *pcst=s* parameter must be specified.

## Removing an Allowed Called Party Address Screen

This procedure is used to remove an allowed called party address (CDPA) screen from the database using the `dlt-scr-cdpa` command. The parameters used by the `dlt-scr-cdpa` command are shown in the “Gateway Screening Attributes” section on page 2-7. The general rules that apply to configuring gateway screening entities are shown in the “Gateway Screening Configuration” section on page 2-28.

The example in this procedure removes the allowed CDPA screen `gw17` from the database.

**NOTE:** If you using multiple-part ITU national point codes with gateway screening, see “14-Bit ITU National Point Code Formats” on page 2-24.

The allowed CDPA screen can be referenced by one of the following screens.

- Allowed SIO
- Allowed CGPA
- Allowed TT

Enter the following commands to verify that none of these screens reference the allowed CDPA screen being removed from the database.

- `rtrv-scr-sio:nsfi=cdpa`
- `rtrv-scr-cgpa:nsfi=cdpa`
- `rtrv-scr-tt:nsfi=cdpa`

To change the NSFI of any of these screens, go to one of the following procedures.

- “Changing an Allowed Translation Type Screen” procedure on page 5-14
- “Changing an Allowed Calling Party Address Screen” procedure on page 6-23
- “Changing an Allowed SIO Screen” procedure on page 10-23

**Procedure**

---

1. Display the allowed CDPA screens in the database using the `rtrv-scr-cdpa` command. The following is an example of the possible output.

```
rlghncxa03w 05-09-25 15:25:30 GMT EAGLE5 34.0.0
SCREEN = ALLOWED CDPA
SR   REF  RULES
GW15 YES   1
GW17 YES   1
GW18 YES   1
IEC  YES   2
LS03 YES   1
WRD2 YES   1
WRD4 YES   9
```

From the `rtrv-scr-cdpa` output, display the allowed CDPA screen you wish to remove using the `rtrv-scr-cdpa` command with the screening reference name. For this example, enter the `rtrv-scr-cdpa:sr=gw17` command. The following is an example of the possible output.

The following is an example of the possible output.

```
rlghncxa03w 05-09-25 15:25:30 GMT EAGLE5 34.0.0
SCREEN = ALLOWED CDPA
SR   NI      NC      NCM      SSN      SCMGFID  NSF1      NSR/ACT
GW17 003      003      003      001      050      AFTPC     GW20
```

---

2. Enter the commands on page 4-17 to verify that the screen being removed is not referenced by other screens in the database. If the screen being removed is referenced by other screens, go to the procedures shown on page 4-17 and change the NSF1 of those screens to reference other screens or change the NSF1 of these screens to STOP.
- 

3. Remove the allowed CDPA screen from the database using the `dlt-scr-cdpa` command. The current values for the `ni`, `nc`, `ncm`, `zone`, `area`, `id`, `npc`, `msa`, `ssa`, `sp`, `ssn`, and `scmgfid` parameters must be entered exactly as shown in the `rtrv-scr-cdpa` output. If dashes are shown for the `scmgfid` parameter, the `scmgfid` parameter cannot be specified with the `dlt-scr-cdpa` command.

To remove an entry containing either an ITU-I or a 14-bit ITU-N spare point code, the `pcst=s` parameter must be specified with the `dlt-scr-cdpa` command.

To remove an entry containing either an ITU-I or a 14-bit ITU-N non-spare point code, the `pcst` parameter does not have to be specified with the `dlt-scr-cdpa` command. If the `pcst` parameter is specified, the value must be `none`.

For this command, enter this command

```
dlt-scr-cdpa:sr=gw17:ni=003:nc=003:ncm=003:ssn=001:scmgfid=050
```



## Allowed Called Party (CDPA) Screen Configuration

A message similar to the following should appear.

```
rlghncxa03w 05-09-25 15:26:30 GMT EAGLE5 34.0.0  
DLT-SCR-CDPA: SCREEN SET AFFECTED - GW17 0% FULL  
DLT-SCR-CDPA: MASP A - COMPLTD
```

---

4. Verify the changes using the **rtrv-scr-cdpa** command with the screening reference name used in step 3. For this example, enter this command.

```
rtrv-scr-cdpa:sr=gw17
```

The following is an example of the possible output.

```
E2573 Cmd Rej: SR or NSR does not reference an existing SR
```

This message shows that the specified screening reference name is not in the database and the action of the **dlt-scr-cdpa** command in step 3 was successful. If the specified screening reference name contained more than one entry when the **dlt-scr-cdpa** command was executed in step 3, the **rtrv-scr-cdpa:sr=** command output would show the remaining entries in the screening reference instead of error message E2573.

---

5. Backup the new changes using the **chg-db:action=backup:dest=fixed** command. The following messages should appear, the active Maintenance and Administration Subsystem Processor (MASP) appears first.

```
BACKUP (FIXED) : MASP A - Backup starts on active MASP.  
BACKUP (FIXED) : MASP A - Backup on active MASP to fixed disk complete.  
BACKUP (FIXED) : MASP A - Backup starts on standby MASP.  
BACKUP (FIXED) : MASP A - Backup on standby MASP to fixed disk complete.
```

---

**Flowchart 4-3.** Removing an Allowed Called Party Address Screen (Sheet 1 of 2)

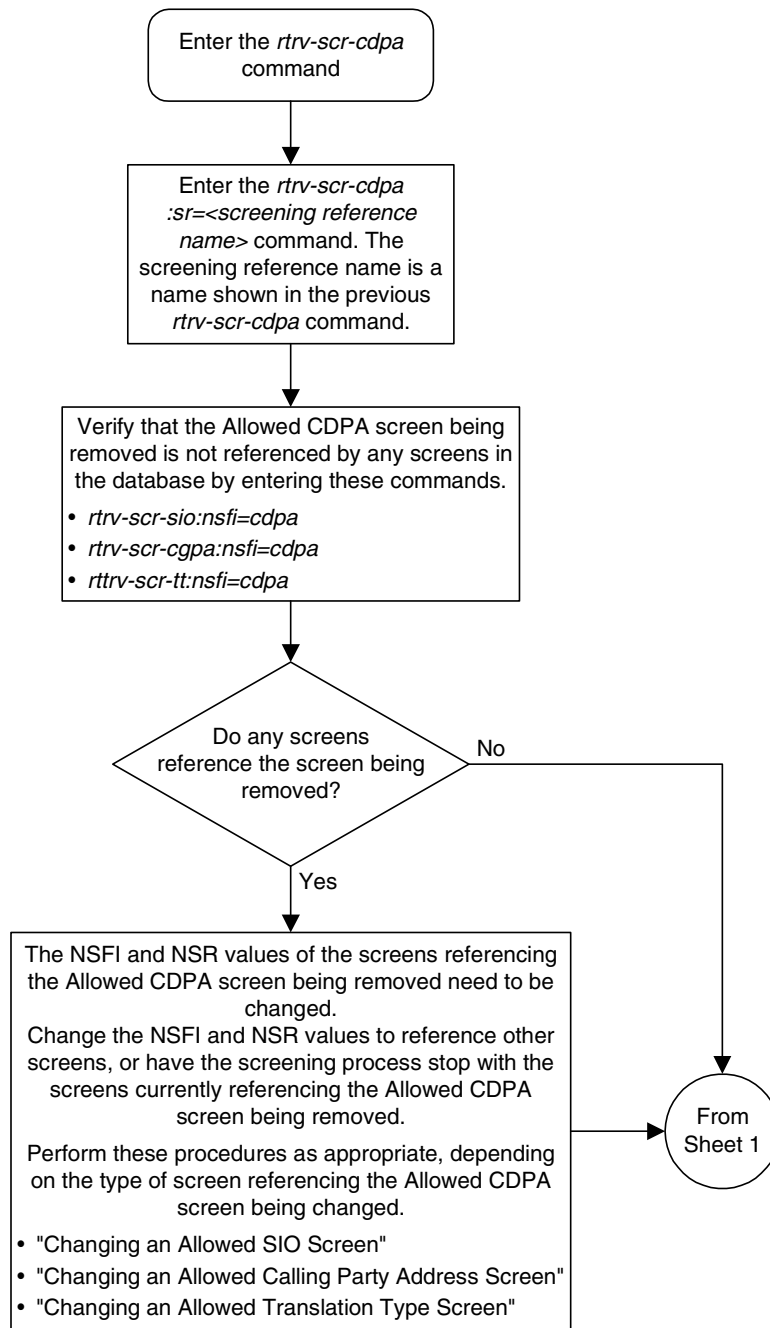

## Allowed Called Party (CDPA) Screen Configuration

Flowchart 4-3. Removing an Allowed Called Party Address Screen (Sheet 2 of 2)

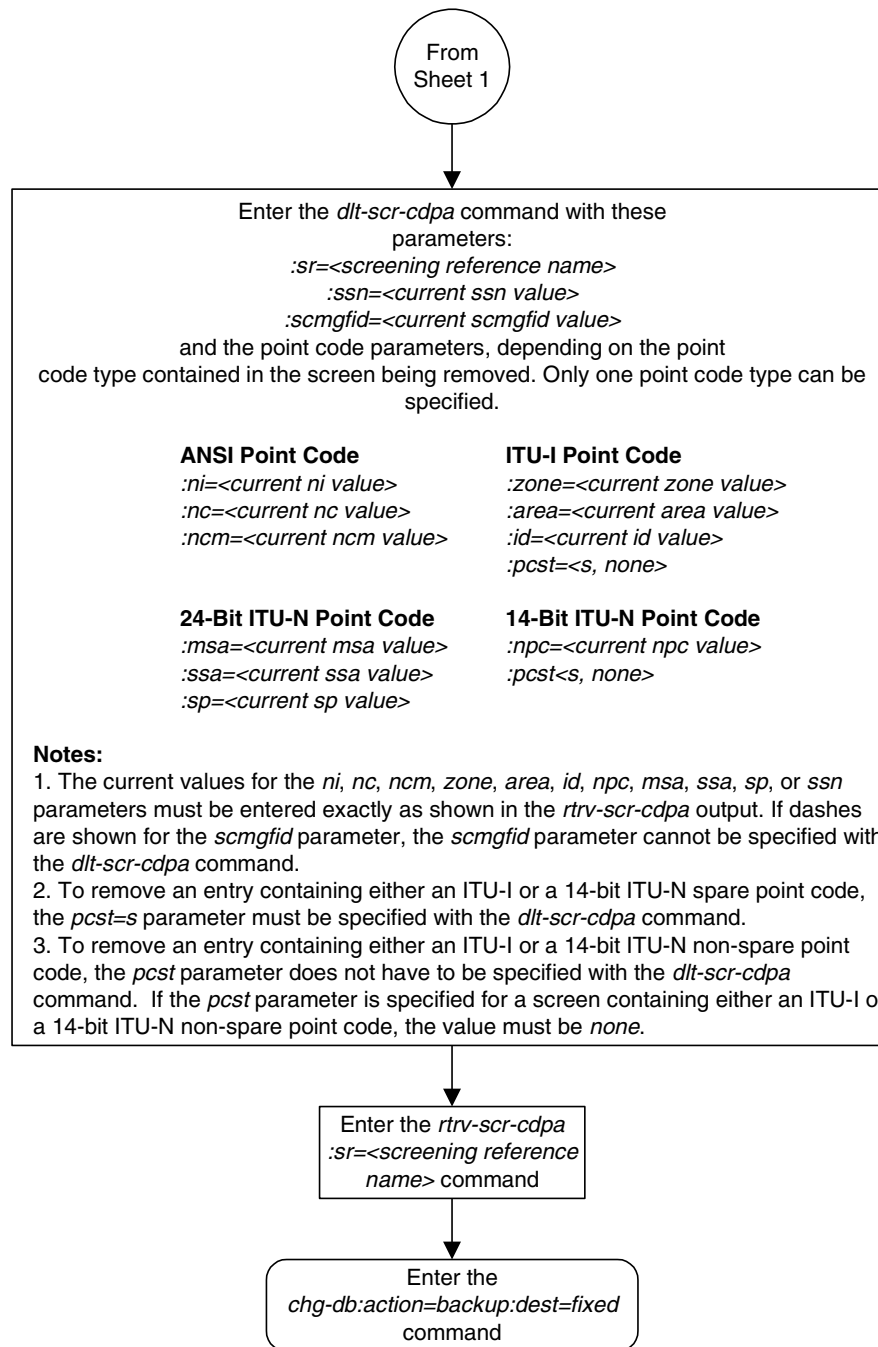

## Changing an Allowed Called Party Address Screen

This procedure is used to change the attributes of an allowed called party address (CDPA) screen in the database using the **chg-scr-cdpa** command. The parameters used by the **chg-scr-cdpa** command are shown in the “Gateway Screening Attributes” section on page 2-7. The general rules that apply to configuring gateway screening entities are shown in the “Gateway Screening Configuration” section on page 2-28.

The example in this procedure is used to change the point code 5-117-2 for the allowed CDPA screen **gw15** to 2-230-7, the subsystem number from 254 to 001, the NSFI to **aftpc**, the NSR of **itu1**, and the new SCMG format ID of 150.

**NOTE:** If you using multiple-part ITU national point codes with gateway screening, see “14-Bit ITU National Point Code Formats” on page 2-24.

The allowed CDPA screen can only reference an allowed AFTPC screen. This can be verified using the **rtrv-scr-aftpc:all=yes** command. If the desired allowed AFTPC screen is not in the database, go to one of these procedures to add the required screen to the database or change an existing screen in the database.

- “Adding an Allowed Affected Point Code Screen” procedure on page 3-4
- “Changing an Allowed Affected Point Code Screen” procedure on page 3-17

### Specifying a Range of Values

A range of values can be specified for the point code parameters **ni**, **nc**, or **ncm**.

If a range of values is specified for any of these parameters, and the value of the other parameters match existing values for the screening reference name, the range of values for the point code parameter cannot include any values for that parameter that are currently provisioned for the screening reference name.

For example, screening reference name **scr1** contains these entries:

SR	NI	NC	NCM	SSN	SCMGFID	NSFI	NSR/ACT
SCR1	240	001	010	012	-----	STOP	-----
SCR1	241	010	020	001	002	AFTPC	SCR1

Another entry for screening reference **scr1** with the **ni** value of 240 and the **nc** value of 001 cannot be specified if the range of values for the **ncm** parameter includes the value 010.

The ANSI point code parameter values can be specified as a single value, a range of values, or with an asterisk (\*). The asterisk specifies all possible values for the **ni**, **nc**, and **ncm** parameters. Table 4-2 on page 4-6 shows the valid combinations of these parameter values.

## Allowed Called Party (CDPA) Screen Configuration

**Table 4-6.** Valid Value Combinations for ANSI Point Code Parameters

NI	NC	NCM
Single Value	Single Value	Single Value
Single Value	Single Value	Range of Values
Single Value	Single Value	Asterisk
Single Value	Range of Values	Asterisk
Single Value	Asterisk	Asterisk
Range of Values	Asterisk	Asterisk
Asterisk	Asterisk	Asterisk

A range of values can also be specified for an ITU-I or 24-bit ITU-N point code parameter using a combination of asterisks (\*) and single values for the point code parameters. Table 4-7 shows the valid combinations of the ITU-I parameter values. Table 4-8 shows the valid combinations of the 24-bit ITU-N parameter values.

**Table 4-7.** Valid Value Combinations for ITU-I Point Code Parameters

ZONE	AREA	ID
Single Value	Single Value	Single Value
Single Value	Single Value	Asterisk
Single Value	Asterisk	Asterisk
Asterisk	Asterisk	Asterisk

**Table 4-8.** Valid Value Combinations for 24-Bit ITU-N Point Code Parameters

MSA	SSA	SP
Single Value	Single Value	Single Value
Single Value	Single Value	Asterisk
Single Value	Asterisk	Asterisk
Asterisk	Asterisk	Asterisk

**Procedure**

---

1. Display the allowed CDPA screens in the database using the **rtrv-scr-cdpa** command. The following is an example of the possible output.

```
rlghncxa03w 05-09-25 15:25:30 GMT EAGLE5 34.0.0
SCREEN = ALLOWED CDPA
SR   REF  RULES
GW15 YES   1
GW17 YES   1
GW18 YES   1
IEC  YES   2
LS03 YES   1
WRD2 YES   1
WRD4 YES   9
```

From the **rtrv-scr-cdpa** output, display the allowed CDPA screen you wish to change using the **rtrv-scr-cdpa** command with the screening reference name. For this example, enter this command.

**rtrv-scr-cdpa:sr=gw15**

The following is an example of the possible output.

```
rlghncxa03w 05-09-25 15:25:30 GMT EAGLE5 34.0.0
SCREEN = ALLOWED CDPA
SR      ZONE  AREA  ID      SSN      SCMGFID  NSFI    NSR/ACT
GW15    5      117   2       254      -----  STOP    -----
```

If a gateway screening stop action set is to be assigned to the allowed CDPA screen being changed in this procedure, go to step 2.

Step 2 verifies the gateway screening stop action set names in the database. The gateway screening stop action set names are assigned only if the NSFI of the screen being changed in this procedure is STOP. If the NSFI of the screen will be changed to STOP, but a gateway screening stop action set name will not be assigned to the screen, skip steps 2 and 3 and go to step 4. If the NSFI of the screen will not be STOP, skip step 2 and go to step 3.

- 
2. Display the gateway screening stop action sets in the database with the **rtrv-gws-actset** command. This is an example of the possible output.

```
rlghncxa03w 05-09-25 15:26:30 GMT EAGLE5 34.0.0
ACT ACT  ACT ACT  ACT ACT  ACT ACT  ACT ACT  ACT ACT
ID  NAME  1    2    3    4    5    6    7    8    9    10
--  -----
1   copy  copy
2   rdct  rdct
3   cr    copy rdct
4   cncf  cncf
5   cpncf copy cncf
6   cncfrd cncf rdct
7   cpcfrd copy cncf rdct
```

GWS action set table is (7 of 16) 44% full

If the required gateway screening stop action set is not in the database, go to the "Configuring Gateway Screening Stop Action Sets" procedure on page 2-54 and configure the required gateway screening stop action set.

---

## Allowed Called Party (CDPA) Screen Configuration

**NOTE:** If the NSFI of the screen being added in this procedure is STOP, skip step 3 and go to step 4.

3. Enter the `rtrv-scr-aftpc` command to verify that the screen that will be specified by the NSFI/NSR parameter combination in step 5 is in the database.

If the desired screen is not in the database, go to one of these procedures and either add the desired screen to the database or change an existing screen in the database.

- “Adding an Allowed Affected Point Code Screen” procedure on page 3-4
- “Changing an Allowed Affected Point Code Screen” procedure on page 3-17

---

**NOTE:** If any of these conditions apply to this procedure, skip this step and go to step 5:

- The point code in the screen is not being changed.
  - The screen being changed contains either an ANSI or 24-bit ITU-N point code.
  - The ITU-I or 14-bit ITU-N non-spare point code in the screen is not being changed to an ITU-I or 14-bit ITU-N spare point code.
  - The point code in the screen is an ITU-I or 14-bit ITU-N spare point code or the screening reference contains other screens with ITU-I or 14-bit ITU-N spare point codes.
4. Display the status of the ITU National and International Spare Point Code Support feature by entering the `rtrv-ctrl-feat` command with the ITU National and International Spare Point Code Support feature part number. Enter this command.

```
rtrv-ctrl-feat:partnum=893013601
```

This is an example of the possible output.

```
rlghncxa03w 05-09-25 15:25:30 GMT EAGLE5 34.0.0
The following features have been permanently enabled:
```

Feature Name	Partnum	Status	Quantity
Spare Point Code Support	893013601	on	----

```
The following features have been temporarily enabled:
```

Feature Name	Partnum	Status	Quantity	Trial Period Left
Zero entries found.				

```
The following features have expired temporary keys:
```

Feature Name	Partnum
Zero entries found.	

If the ITU National and International Spare Point Code Support feature is enabled, go to step 5.

If the ITU National and International Spare Point Code Support feature is not enabled, perform the “Activating the ITU National and International Spare Point Code Support Feature” procedure in the *Database Administration Manual - SS7* to enable the ITU National and International Spare Point Code Support feature as required. After the feature has been enabled, go to step 5.

- 
5. Change the attributes for the allowed CDPA screen using the `chg-scr-cdpa` command.

If a gateway screening stop action is to be assigned to the allowed CDPA screen being changed, enter the `chg-scr-cdpa` command with the `nsfi=stop` parameter and the `actname` parameter with the name of a gateway screening stop action set shown in the output of the `rtrv-gws-actset` command executed in step 2.



**CAUTION:** The EAGLE 5 SAS does not support redirecting MSUs for the DTA feature or intercepting ISUP IAM messages for the Calling Name Conversion Facility feature from the allowed CDPA screen. Gateway screening stop action sets containing either the RDCT (redirect) or CNCF (calling name conversion facility) stop actions should not be assigned to the allowed CDPA screen. If a gateway screening stop action set containing the RDCT or CNCF stop actions is specified with the `chg-scr-cdpa` command, unsolicited information message (UIM) 1125 is generated when the attempt is made to redirect MSUs from the allowed CDPA screen. Unsolicited information message (UIM) 1215 is generated when ISUP IAM MSUs are intercepted from the allowed CDPA screen. For more information on UIMs 1125 and 1215, go to the *Maintenance Manual*.

The current values for the `ni`, `nc`, `ncm`, `zone`, `area`, `id`, `npc`, `msa`, `ssa`, and `sp`, `ssn`, and `scmgfid` parameters must be entered exactly as shown in the `rtrv-scr-cdpa` output in step 1. If the `scmgfid` value is shown as dashes, the `scmgfid` parameter cannot be specified.

The following list contains the values for `nni`, `nnc`, `nncm`, `nzone`, `narea`, `nid`, `nnpc`, `nmsa`, `nssa`, `nsp`, `nssn`, and `nscmgfid` parameters:

- `nni` – 0 - 255 or an asterisk (\*)
- `nnc` – 0 - 255 or an asterisk (\*)
- `nncm` – 0 - 255 or an asterisk (\*)
- `nzone` – 0 - 7 or an asterisk (\*)
- `narea` – 0 - 255 or an asterisk (\*)
- `nid` – 0 - 7 or an asterisk (\*)
- `nnpc` – 1 - 16383 or an asterisk (\*)



## Allowed Called Party (CDPA) Screen Configuration

- **nmsa** – 0 - 255 or an asterisk (\*)
- **nssa** – 0 - 255 or an asterisk (\*)
- **nsp** – 0 - 255 or an asterisk (\*)
- **nssn** – 0 - 255 or an asterisk (\*)
- **nscmgfid** – 1 - 255 or an asterisk (\*)

**NOTE:** The **nsfi=aftpc** parameter can be specified only if the **ssn** value (new or current) is 1. Table 4-9 shows the valid parameter combinations for the **ssn**, **scmgfid**, **nsfi**, and **nsr** parameter values.

**Table 4-9.** CDPA Parameter Combinations

New or Current SSN Value	New or Current SCMGFID Value	NSFI	NSR
1	1 - 255, *	AFTPC or STOP	Must be specified if NSFI=AFTPC
0, 2-255, *	Cannot be specified	STOP	Cannot be specified

A range of values can be specified for the **nni**, **nnc**, and **nncm** parameters. See the “Specifying a Range of Values” section on page 4-22 for more information on how the asterisk and a range of values are used for the **nni**, **nnc**, and **nncm** parameters.

To change an ITU-I or 14-bit ITU-N spare point code to a non-spare point code, both the **pcst=s** and **npcst=none** parameters must be specified with the **chg-scr-cdpa** command.

To change an ITU-I or 14-bit ITU-N non-spare point code to a spare point code, the **npcst=s** parameter must be specified with the **chg-scr-cdpa** command. The **pcst** parameter does not have to be specified.

If the current point code in the screen being changed is either an ITU-I or 14-bit ITU-N spare point code, the **pcst=s** parameter must be specified with the **chg-scr-cdpa** command.

If the current point code in the screen being changed is either an ITU-I or 14-bit ITU-N non-spare point code, the **pcst** parameter does not have to be specified with the **chg-scr-cdpa** command. If the **pcst** parameter is specified for a screen containing either an ITU-I or 14-bit ITU-N non-spare point code, the **pcst** parameter value must be **none**.

For this example, enter this command.

```
chg-scr-cdpa:sr=gw15:zone=5:area=117:id=2:ssn=254:nzone=2:narea=230:nid=7:nssn=001:nscmgfid=150:nsfi=aftpc:nsr=itul
```

## Allowed Called Party (CDPA) Screen Configuration

A message similar to the following should appear.

```
rlghncxa03w 05-09-25 15:27:30 GMT EAGLE5 34.0.0
CHG-SCR-CDPA: SCREEN SET AFFECTED - GW15 1% FULL
CHG-SCR-CDPA: MASP A - COMPLTD
```

---

6. Verify the changes using the **rtrv-scr-cdpa** command with the screening reference name used in step 5. For this example, enter this command.

```
rtrv-scr-cdpa:sr=gw15
```

The following is an example of the possible output.

```
rlghncxa03w 05-09-25 15:28:30 GMT EAGLE5 34.0.0
SCREEN = ALLOWED CDPA
SR      ZONE  AREA  ID      SSN      SCMGFID  NSFI     NSR/ACT
GW15   2      230   7       001      150     AFTPC    ITU1
```

---

7. Backup the new changes using the **chg-db:action=backup:dest=fixed** command. The following messages should appear, the active Maintenance and Administration Subsystem Processor (MASP) appears first.

```
BACKUP (FIXED) : MASP A - Backup starts on active MASP.
BACKUP (FIXED) : MASP A - Backup on active MASP to fixed disk complete.
BACKUP (FIXED) : MASP A - Backup starts on standby MASP.
BACKUP (FIXED) : MASP A - Backup on standby MASP to fixed disk complete.
```

---

## Allowed Called Party (CDPA) Screen Configuration

Flowchart 4-4. Changing an Allowed Called Party Address Screen (Sheet 1 of 5)

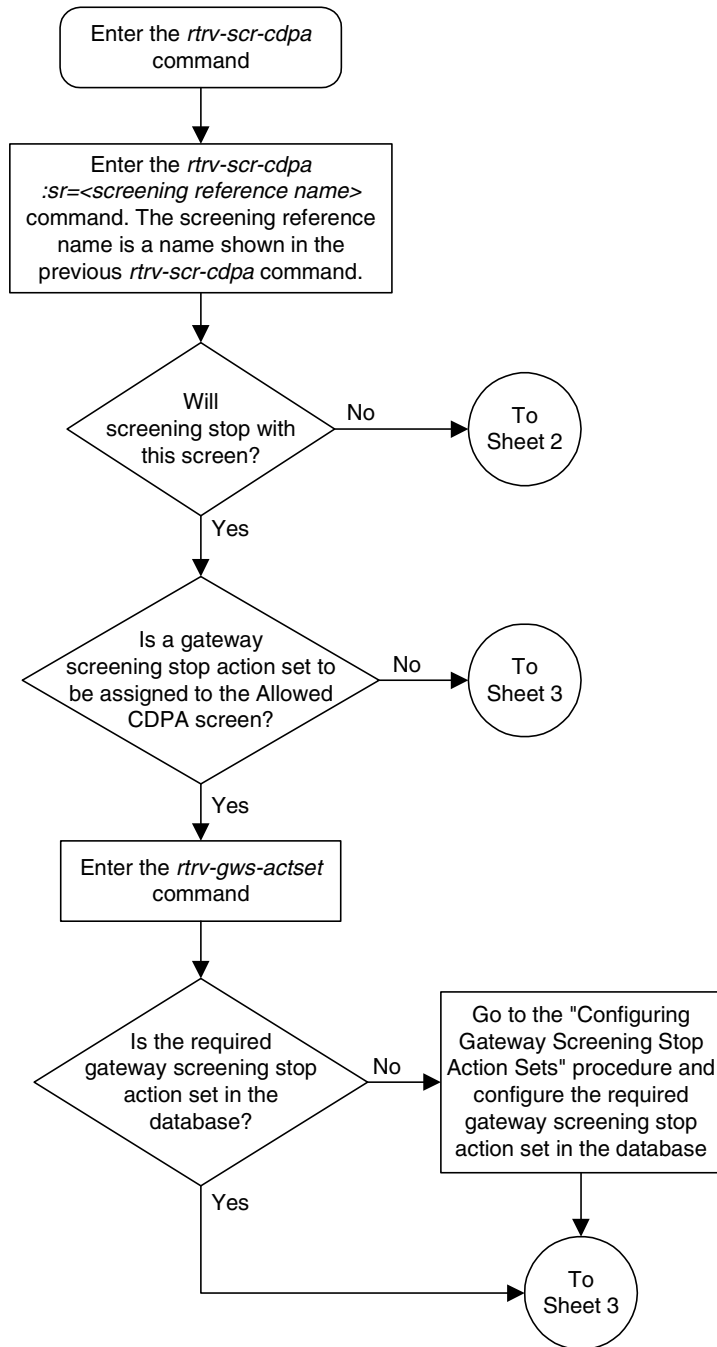

Flowchart 4-4. Changing an Allowed Called Party Address Screen (Sheet 2 of 5)

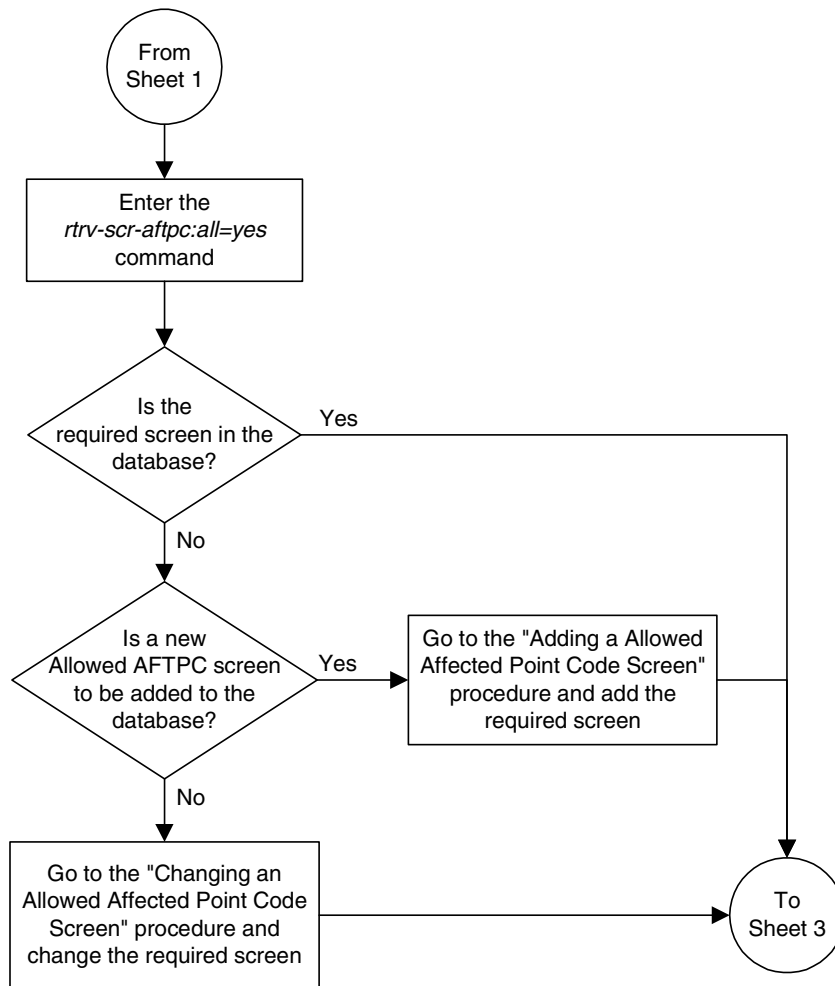

# Allowed Called Party (CDPA) Screen Configuration

Flowchart 4-4. Changing an Allowed Called Party Address Screen (Sheet 3 of 5)

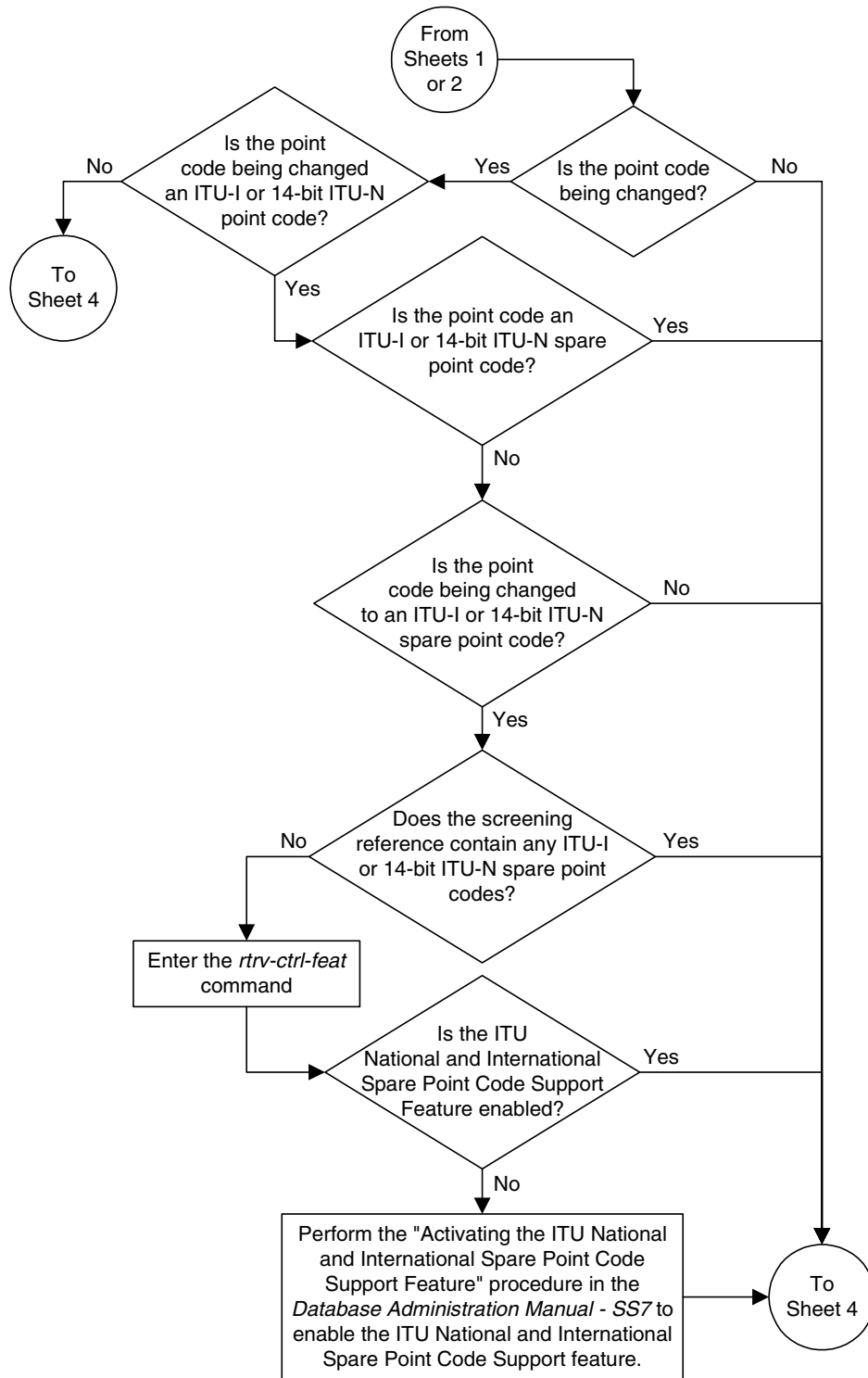

Flowchart 4-4. Changing an Allowed Called Party Address Screen (Sheet 4 of 5)

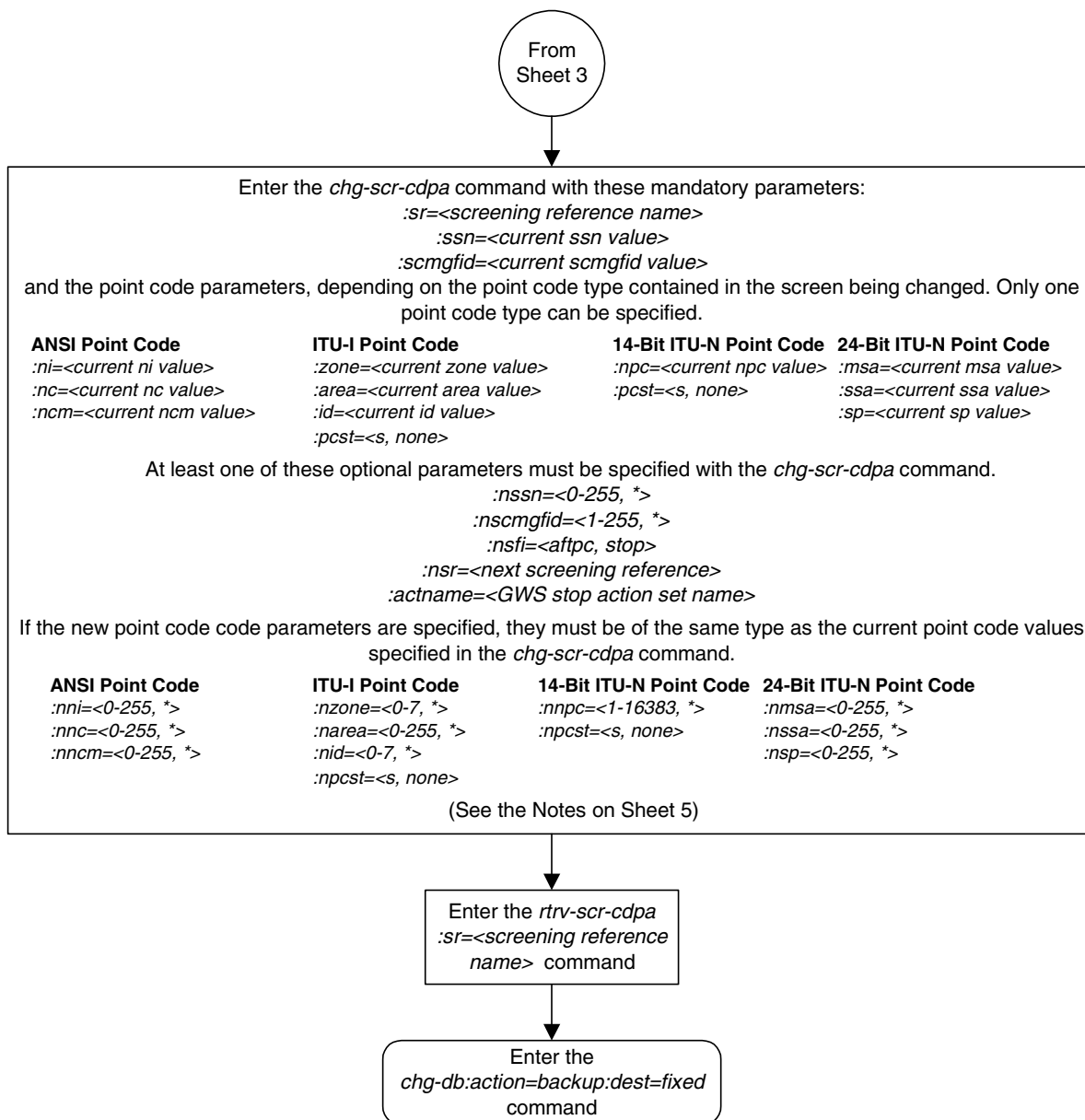

## Allowed Called Party (CDPA) Screen Configuration

### Flowchart 4-4. Changing an Allowed Called Party Address Screen (Sheet 5 of 5)

#### Notes:

1. A range of values can be specified for the *nni*, *nnc*, or *nncm* parameters by inserting double ampersands (&&) between the parameter values defining the range. For example, to specify the range 025 to 200 for the *nni* parameter, enter 025&&200 for the *nni* parameter value.
2. The asterisk (\*) specifies the entire range of values for that parameter.  
For more information about specifying a range of values and about using the asterisk, see the "Gateway Screening Attributes" section in Chapter 2 and the "Specifying a Range of Values" section in this procedure.
3. The *nscmgfid* parameter can be specified only if the *ssn* parameter value (if unchanged) or the *nssn* parameter value is 1. If either the *nssn=1* or *nscmgfid* parameter is specified, the other parameter must be specified. The *nscmgfid* parameter cannot be specified if the *ssn* parameter value is 2 through 255, or \*.
4. To specify the *nsfi=atpc* parameter, the *ssn* parameter value (if unchanged) or the *nssn* parameter value must be 1.
5. If the *ssn* parameter value (if unchanged) or the *nssn* parameter value is 2 through 255, or \*, the *nsfi* parameter value must be *stop*.
6. If the *ssn* parameter value (if unchanged) or the *nssn* parameter value is 1, the *nsfi* parameter value can be either *atpc* or *stop*.
7. The *nsr* parameter can be specified only, and must be specified, if the *nsfi=atpc* parameter is specified.
8. The *actname* parameter can be specified only if the *nsfi* value is *stop* (either the current *nsfi* value is *stop* and not being changed, or the *nsfi* value is being changed to *stop*). The *actname* parameter is optional. If the *actname* parameter is specified, the *actname* parameter value is one of the gateway screening stop action set names shown in the *rtrv-gws-actset* output on Sheet 1.
9. The current values for the *ni*, *nc*, *nmc*, *zone*, *area*, *id*, *npc*, *msa*, *ssa*, *sp*, or *ssn* parameters must be entered exactly as shown in the *rtrv-scr-cdpa* output. If dashes are shown for the *scmgfid* parameter, the *scmgfid* parameter cannot be specified with the *chg-scr-cdpa* command.
10. To change an ITU-I or 14-bit ITU-N spare point code to a non-spare point code, both the *pcst=s* and *npcst=none* parameters must be specified with the *chg-scr-cdpa* command.
11. To change an ITU-I or 14-bit ITU-N non-spare point code to a spare point code, the *npcst=s* parameter must be specified with the *chg-scr-cdpa* command. The *pcst* parameter does not have to be specified.
12. If the current point code in the screen being changed is either an ITU-I or 14-bit ITU-N spare point code, the *pcst=s* parameter must be specified with the *chg-scr-cdpa* command.
13. If the current point code in the screen being changed is either an ITU-I or 14-bit ITU-N non-spare point code, the *pcst* parameter does not have to be specified with the *chg-scr-cdpa* command. If the *pcst* parameter is specified for a screen containing either an ITU-I or 14-bit ITU-N non-spare point code, the *pcst* parameter value must be *none*.

## Allowed Called Party (CDPA) Screen Configuration



## Allowed Translation Type (TT) Screen Configuration

Introduction.....	5-2
Adding an Allowed Translation Type Screen.....	5-4
Removing an Allowed Translation Type Screen .....	5-11
Changing an Allowed Translation Type Screen .....	5-14

## Introduction

The allowed translation type (TT) screen is used to screen all SCCP messages which have the specified translation type value in the called party address. The gray shaded areas in Figure 5-1 shows the fields of the SS7 message that are checked by the TT screening function. If a match is found, the **nsfi** is examined to determine the next step in the screening process. If the **nsfi** is equal to **stop**, the message is processed and no further screening takes place.

If the **nsfi** is equal to **stop**, and the **copy** gateway screening stop action is specified, the message is processed and a copy of the message is sent by the STP LAN feature to an external application through an ACM running the **stplan** application or a DCM running the **vxwslan** application.

If the **nsfi** is equal to anything else, the next screening reference (**nsr**) is identified and the screening process continues to the next screen identified by the **nsfi** and **nsr** parameters. If no match is found, the message is discarded.

Flowchart 5-1 shows the screening action of the allowed TT screen.

**Flowchart 5-1.** Allowed TT Screening Action

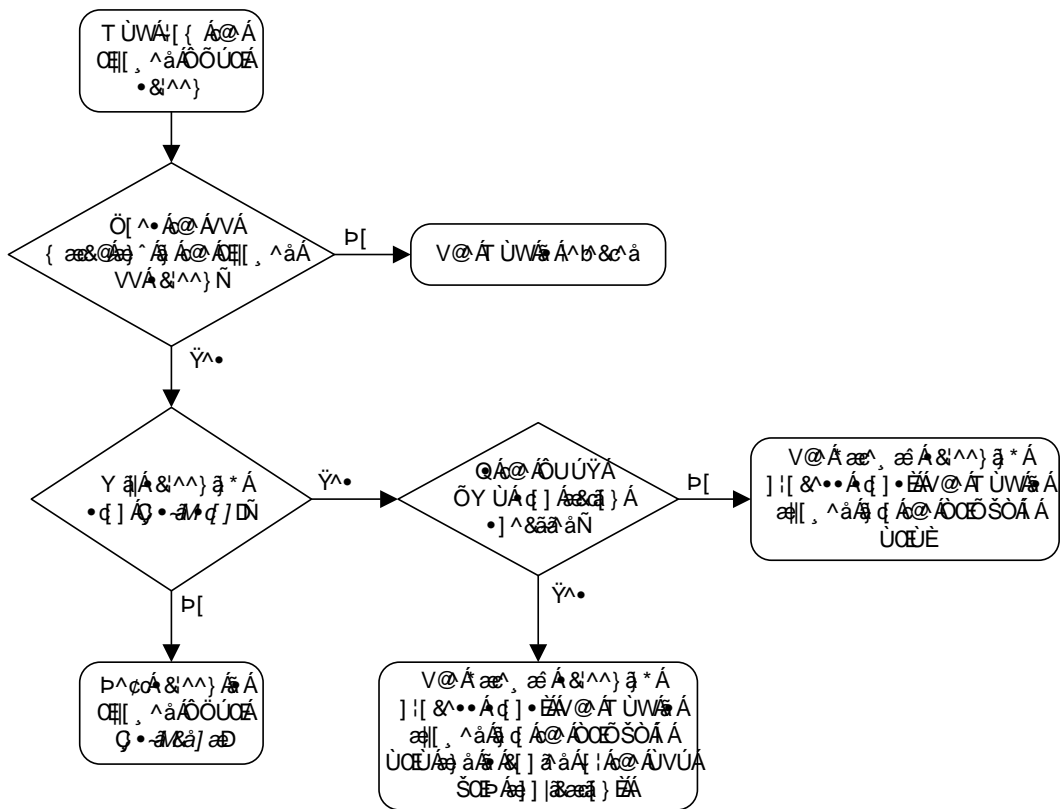

# Allowed Translation Type (TT) Screen Configuration

Figure 5-1. Allowed Translation Type Screening Function

**ANSI MSU (ANSI Message Signal Unit)**

BSN FSN LI	SIO xx xx xxxx NIC PRI SI	SIF			
		DPC NCM NC NI	Routing Label OPC NCM NC NI	SLS xx	CGPA Length Address Indicator Subsystem Point Code (NCM NC NI)

**ITU-I MSU (ITU International Message Signal Unit)**

BSN FSN LI	SIO xx xx xxxx NIC PRI SI	SIF			
		DPC ID AREA ZONE	Routing Label OPC ID AREA ZONE	SLS xx	CGPA Length Address Indicator Subsystem Point Code (ID AREA ZONE)

**14-Bit ITU-N MSU (14-Bit ITU National Message Signal Unit)**

BSN FSN LI	SIO xx xx xxxx NIC PRI SI	SIF			
		DPC NPC	Routing Label OPC NPC	SLS xx	CGPA Length Address Indicator Subsystem Point Code (NPC)

**24-Bit ITU-N MSU (24-Bit ITU National Message Signal Unit)**

BSN FSN LI	SIO xx xx xxxx NIC PRI SI	SIF			
		DPC SP SSA MSA	Routing Label OPC SP SSA MSA	SLS xx	CGPA Length Address Indicator Subsystem Point Code (SP SSA MSA)

## Adding an Allowed Translation Type Screen

This procedure is used to add an allowed translation type (TT) screen to the database using the `ent-scr-tt` command. The parameters used by the `ent-scr-tt` command are shown in the “Gateway Screening Attributes” section on page 2-7. The general rules that apply to configuring gateway screening entities are shown in the “Gateway Screening Configuration” section on page 2-28.

The examples in this procedure are used to add the allowed TT screen data shown in Table 5-1 and based on the example configuration shown in Figure 2-5 on page 2-37.

**Table 5-1.** Example Gateway Screening Allowed TT Configuration Table

Screening Reference	TYPE	NSFI	NSR
gw16	250	cdpa	gw18

The allowed TT screen can only reference an allowed CDPA screen and the allowed CDPA screen being referenced must be in the database. This can be verified using the `rtrv-scr-cdpa:all=yes` command. If the desired allowed CDPA screen is not in the database, go to one of these procedures to add the required screen to the database or change an existing screen in the database.

- “Adding an Allowed Called Party Address Screen” procedure on page 4-5
- “Changing an Allowed Called Party Address Screen” procedure on page 4-22

### Specifying a Range of Values

A range of values can be specified for the `type` parameter. The range of values specified for the `type` parameter cannot include any values currently provisioned for the screen reference name.

For example, screening reference name `scr1` contains these entries:

```
SR   TYPE   NSFI   NSR/ACT
scr1 110    STOP   -----
scr1 125    STOP   -----
```

Another entry for screening reference `scr1` cannot contain a range of values that would include the `type` parameter values 110 or 125.

## Procedure

---

1. Verify that the gateway screening feature is on, by entering the **rtrv-feat** command. If the gateway screening feature is on, the **GWS** field is set to **on**.

**NOTE:** The **rtrv-feat** command output contains other fields that are not used by this procedure. If you wish to see all the fields displayed by the **rtrv-feat** command, see the **rtrv-feat** command description in the *Commands Manual*.

If the gateway screening feature is on, shown by the entry **GWS = on** in the **rtrv-feat** command output, skip step 2, and go to step 3.

---

2. Turn the gateway screening feature on by entering this command.

```
chg-feat:gws=on
```

**NOTE:** Once the gateway screening feature is turned on with the **chg-feat** command, it cannot be turned off.

The gateway screening feature must be purchased before you turn this feature on with the **chg-feat** command. If you are not sure if you have purchased the gateway screening feature, contact your Tekelec Sales Representative or Account Representative.

When the **chg-feat** has successfully completed, this message should appear.

```
rlghncxa03w 05-09-28 11:43:04 GMT EAGLE5 34.0.0  
CHG-FEAT: MASP A - COMPLTD
```

---

3. Display all allowed TT screens in the database using the **rtrv-scr-tt** command. The following is an example of the possible output.

```
rlghncxa03w 05-09-25 15:25:30 GMT EAGLE5 34.0.0  
SCREEN = ALLOWED TT  
SR   REF  RULES  
IEC  YES   2  
WRD2 YES   1  
WRD4 YES   9
```

If the screening reference names that you wish to add with this procedure are not shown in the **rtrv-scr-tt** command output, go to step 4. For this example, the screening reference names are not shown. If these screening reference names are shown in the **rtrv-scr-tt** command output, make sure the screening data you wish to enter is not already in the database by entering the **rtrv-scr-tt** command with the screening reference name. For example, enter the **rtrv-scr-tt:sr=iec** command.

The following is an example of the possible output.

```
rlghncxa03w 05-09-25 15:26:30 GMT EAGLE5 34.0.0  
SCREEN = ALLOWED TT  
SR   TYPE      NSFI   NSR/ACT  
IEC  005&&010  STOP  -----  
IEC  012       STOP  -----
```

## Allowed Translation Type (TT) Screen Configuration

```
IEC 016      CDPA  IEC
WRD2 243     STOP  -----
WRD4 *      STOP  -----
```

If a gateway screening stop action set is to be assigned to the allowed TT screen being added to the database, go to step 4.

Step 4 verifies the gateway screening stop action set names in the database. The gateway screening stop action set names are assigned only if the NSFI of the screen being added in this procedure is STOP. If the NSFI of the new screen will be STOP, but a gateway screening stop action set name will not be assigned to the new screen, skip steps 4 and 5 and go to step 6. If the NSFI of the new screen is CDPA, skip step 4 and go to step 5.

- 
4. Display the gateway screening stop action sets in the database with the **rtrv-gws-actset** command. This is an example of the possible output.

```
r1ghncxa03w 05-09-25 15:27:30 GMT EAGLE5 34.0.0
ACT ACT  ACT  ACT  ACT  ACT  ACT  ACT  ACT  ACT  ACT  ACT
ID  NAME  1    2    3    4    5    6    7    8    9    10
--  ----  ---  ---  ---  ---  ---  ---  ---  ---  ---  ---
1   copy  copy
2   rdct  rdct
3   cr    copy rdct
4   cncf  cncf
5   cpncf copy cncf
6   cncfrd cncf rdct
7   cpcfrd copy cncf rdct
```

GWS action set table is (7 of 16) 44% full

If the required gateway screening stop action set is not in the database, go to the "Configuring Gateway Screening Stop Action Sets" procedure on page 2-54 and configure the required gateway screening stop action set.

---

**NOTE:** If the NSFI of the screen being added in this procedure is STOP, skip step 5 and go to step 6.

5. Enter the **rtrv-scr-cdpa** command to verify that the screen that will be specified by the NSFI/NSR parameter combination in step 6 is in the database.

If the desired screen is not in the database, go to one of these procedures and either add the desired screen to the database or change an existing screen in the database.

- "Adding an Allowed Called Party Address Screen" procedure on page 4-5
  - "Changing an Allowed Called Party Address Screen" procedure on page 4-22
-

## Allowed Translation Type (TT) Screen Configuration

6. Add a new allowed TT screen to the database using the `ent-scr-tt` command.

If a gateway screening stop action is to be assigned to the allowed TT screen being changed, enter the `ent-scr-tt` command with the `nsfi=stop` parameter and the `actname` parameter with the name of a gateway screening stop action set shown in the output of the `rtrv-gws-actset` command executed in step 4.



**CAUTION:** The EAGLE 5 SAS does not support redirecting MSUs for the DTA feature or intercepting ISUP IAM messages for the Calling Name Conversion Facility feature from the allowed TT screen. Gateway screening stop action sets containing either the RDCT (redirect) or CNCF (calling name conversion facility) stop actions should not be assigned to the allowed TT screen. If a gateway screening stop action set containing the RDCT or CNCF stop actions is specified with the `ent-scr-tt` command, unsolicited information message (UIM) 1128 is generated when the attempt is made to redirect MSUs from the allowed TT screen. Unsolicited information message (UIM) 1218 is generated when ISUP IAM MSUs are intercepted from the allowed TT screen. For more information on UIMs 1128 and 1218, go to the *Maintenance Manual*.

The value of the `type` parameter can be from 0 to 255 or an asterisk (\*).

A range of values can be specified for the `type` parameter. See the “Specifying a Range of Values” section on page 5-4 for more information on how a range of values is used for the `type` parameter.

For this example, enter this command.

```
ent-scr-tt:sr=gw16:type=250:nsfi=cdpa:nsr=gw18
```

A message similar to the following should appear.

```
rlghncxa03w 05-09-25 15:28:30 GMT EAGLE5 34.0.0
ENT-SCR-TT: SCREEN SET AFFECTED - GW16 1% FULL
ENT-SCR-TT: MASP A - COMPLTD
```

---

7. Verify the changes using the `rtrv-scr-tt` command with the screening reference name used in step 6. For this example, enter this command.

```
rtrv-scr-tt:sr=gw16
```

The following is an example of the possible output.

```
rlghncxa03w 05-09-25 15:29:30 GMT EAGLE5 34.0.0
SCREEN = ALLOWED TT
SR   TYPE   NSFI   NSR/ACT
GW16 250     CDPA   GW18
```

---

- Backup the new changes using the `chg-db:action=backup:dest=fixed` command. The following messages should appear, the active Maintenance and Administration Subsystem Processor (MASP) appears first.

```

BACKUP (FIXED) : MASP A - Backup starts on active MASP.
BACKUP (FIXED) : MASP A - Backup on active MASP to fixed disk complete.
BACKUP (FIXED) : MASP A - Backup starts on standby MASP.
BACKUP (FIXED) : MASP A - Backup on standby MASP to fixed disk complete.
    
```

Flowchart 5-2. Adding an Allowed Translation Type Screen (Sheet 1 of 3)

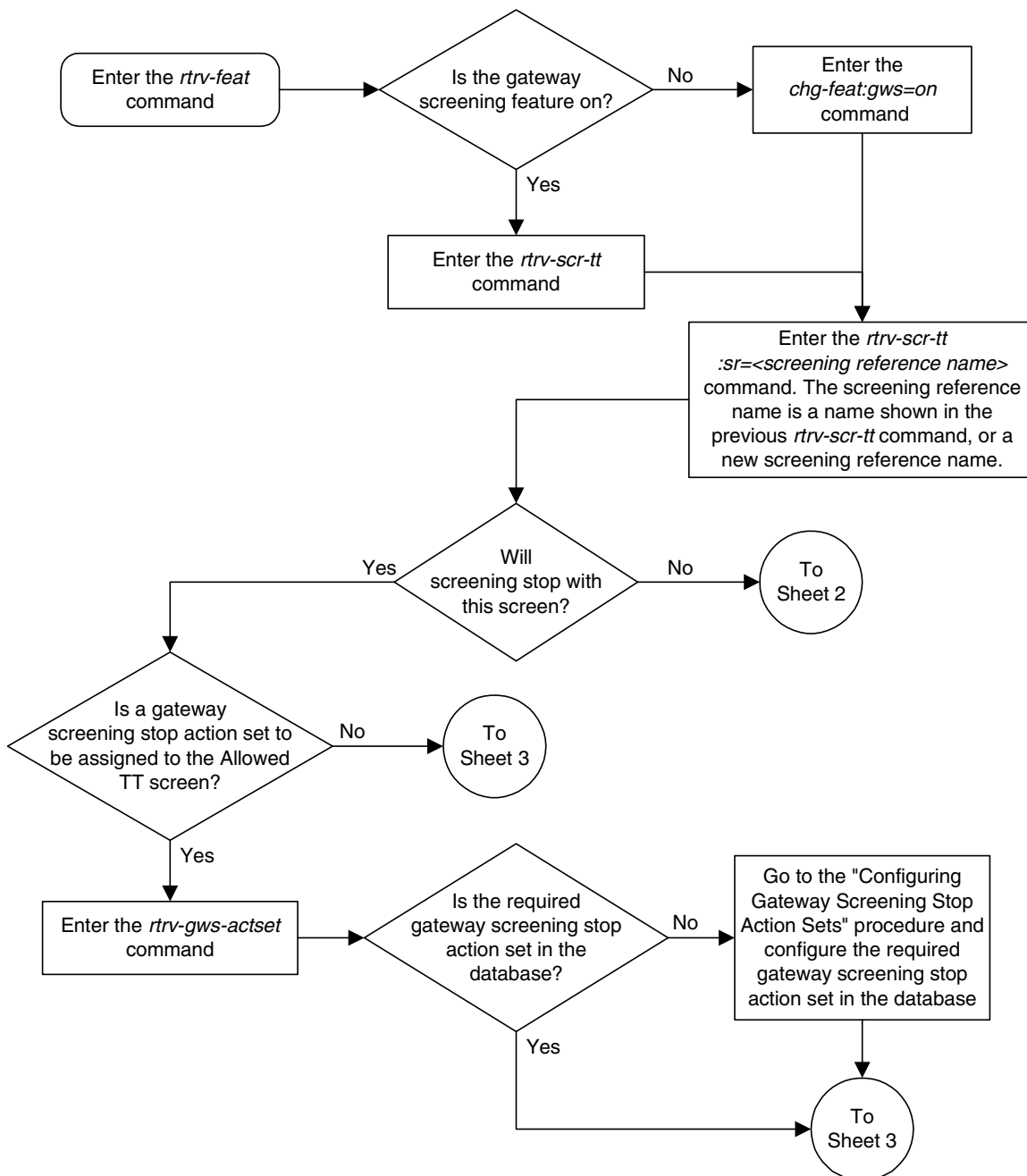



## Allowed Translation Type (TT) Screen Configuration

Flowchart 5-2. Adding an Allowed Translation Type Screen (Sheet 2 of 3)

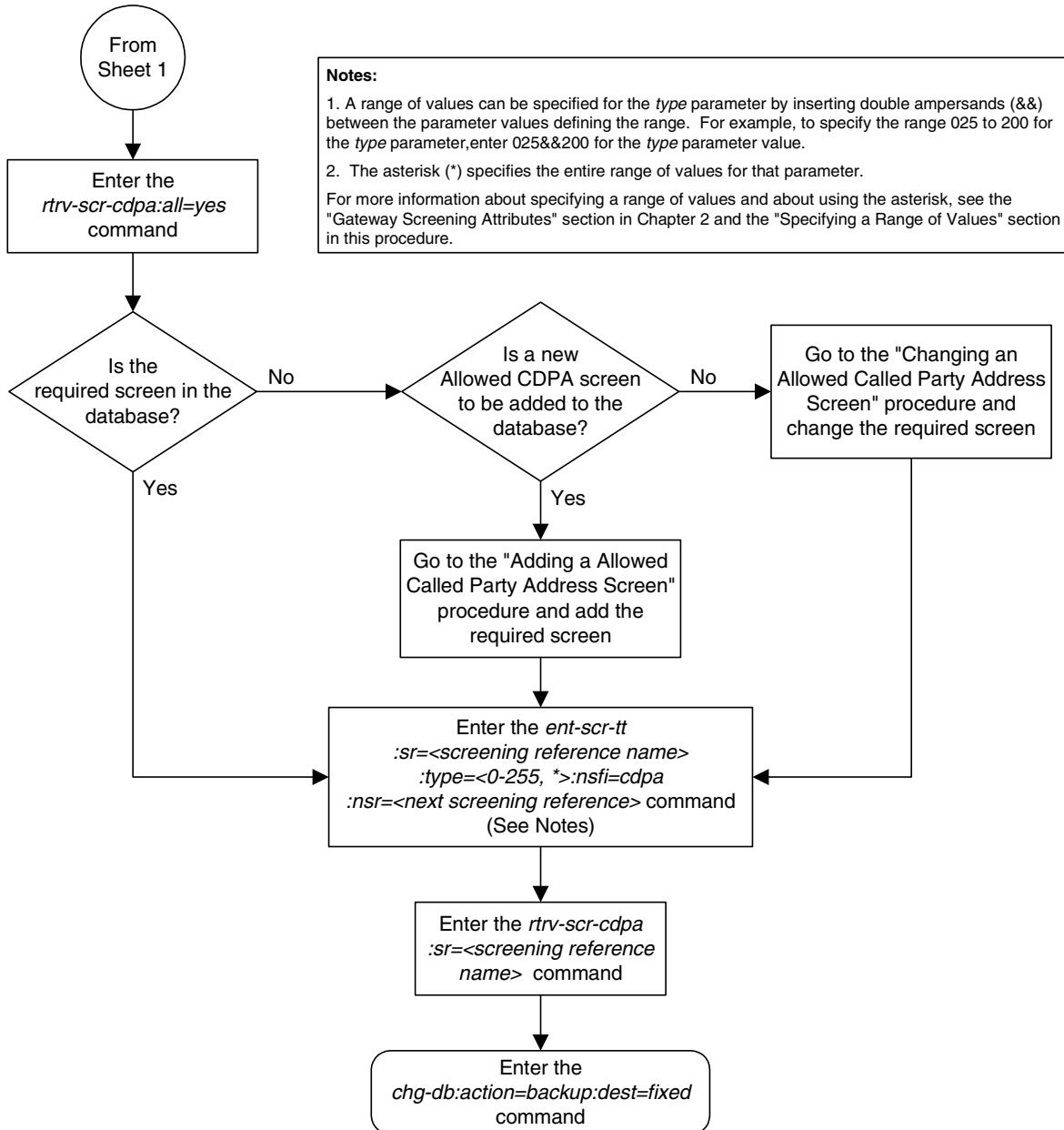

Flowchart 5-2. Adding an Allowed Translation Type Screen (Sheet 3 of 3)

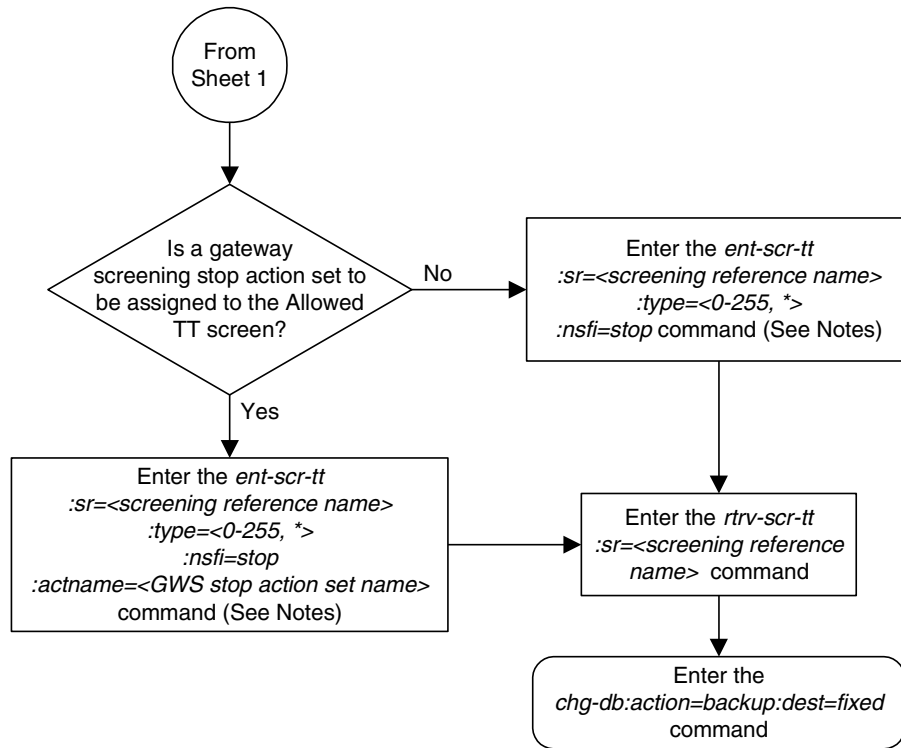

**Notes:**

1. A range of values can be specified for the *type* parameter by inserting double ampersands (&&) between the parameter values defining the range. For example, to specify the range 025 to 200 for the *type* parameter, enter 025&&200 for the *type* parameter value.

2. The asterisk (\*) specifies the entire range of values for that parameter.

For more information about specifying a range of values and about using the asterisk, see the "Gateway Screening Attributes" section in Chapter 2 and the "Specifying a Range of Values" section in this procedure.

## Removing an Allowed Translation Type Screen

This procedure is used to remove an allowed translation type (TT) screen from the database using the `dlt-scr-tt` command. The parameters used by the `dlt-scr-tt` command are shown in the "Gateway Screening Attributes" section on page 2-7. The general rules that apply to configuring gateway screening entities are shown in the "Gateway Screening Configuration" section on page 2-28.

The example in this procedure removes the allowed TT screen `iec`, with the translation type 016 from the database.

The allowed TT screen can be referenced by the Allowed CGPA screen. Enter the `rtrv-scr-cgpa:nsfi=tt` command to verify that this screen does not reference the allowed TT screen being removed from the database.

To change the NSFI of any of these screens, go to the "Changing an Allowed Calling Party Address Screen" procedure on page 6-23.

### Procedure

---

1. Display the allowed TT screens in the database using the `rtrv-scr-tt` command. The following is an example of the possible output.

```
rlghncxa03w 05-09-25 15:26:30 GMT EAGLE5 34.0.0
SCREEN = ALLOWED TT
SR   REF  RULES
GW16 YES   1
IEC  YES   3
WRD2 YES   1
WRD4 YES   1
```

From the `rtrv-scr-tt` output, display the allowed TT screen you wish to remove using the `rtrv-scr-tt` command with the screening reference name. For this example, enter the `rtrv-scr-tt:sr=iec` command. The following is an example of the possible output.

The following is an example of the possible output.

```
rlghncxa03w 05-09-25 15:26:30 GMT EAGLE5 34.0.0
SCREEN = ALLOWED TT
SR   TYPE    NSFI    NSR/ACT
IEC  005&&010 STOP    -----
IEC  012      STOP    -----
IEC  016      CDPA    IEC
```

---

2. Enter the **rtrv-scr-cgpa:nsfi=tt** command to verify that the screen being removed is not referenced by other screens in the database. If the screen being removed is referenced by other screens, go to the "Changing an Allowed Calling Party Address Screen" procedure on page 6-23 procedure and change the NSFIs of those screens to reference other screens or change the NSFIs of these screens to STOP.

- 
3. Remove the allowed TT screen from the database using the **dlt-scr-tt** command. The current value of the **type** parameter must be entered exactly as shown in the **rtrv-scr-tt** output. For this example, enter this command.

**dlt-scr-tt:sr=iec:type=016**

A message similar to the following should appear.

```
rlghncxa03w 05-09-25 15:26:30 GMT EAGLE5 34.0.0
DLT-SCR-TT: SCREEN SET AFFECTED - IEC 2% FULL
DLT-SCR-TT: MASP A - COMPLTD
```

- 
4. Verify the changes using the **rtrv-scr-tt** command with the screening reference name used in step 3. For this example, enter this command.

**rtrv-scr-tt:sr=iec**

The following is an example of the possible output.

```
rlghncxa03w 05-09-25 15:26:30 GMT EAGLE5 34.0.0
SCREEN = ALLOWED TT
SR      TYPE      NSFI      NSR/ACT
IEC     005&&010  STOP     -----
IEC     012        STOP     -----
```

- 
5. Backup the new changes using the **chg-db:action=backup:dest=fixed** command. The following messages should appear, the active Maintenance and Administration Subsystem Processor (MASP) appears first.

```
BACKUP (FIXED) : MASP A - Backup starts on active MASP.
BACKUP (FIXED) : MASP A - Backup on active MASP to fixed disk complete.
BACKUP (FIXED) : MASP A - Backup starts on standby MASP.
BACKUP (FIXED) : MASP A - Backup on standby MASP to fixed disk complete.
```

---

## Allowed Translation Type (TT) Screen Configuration

Flowchart 5-3. Removing an Allowed Translation Type Screen

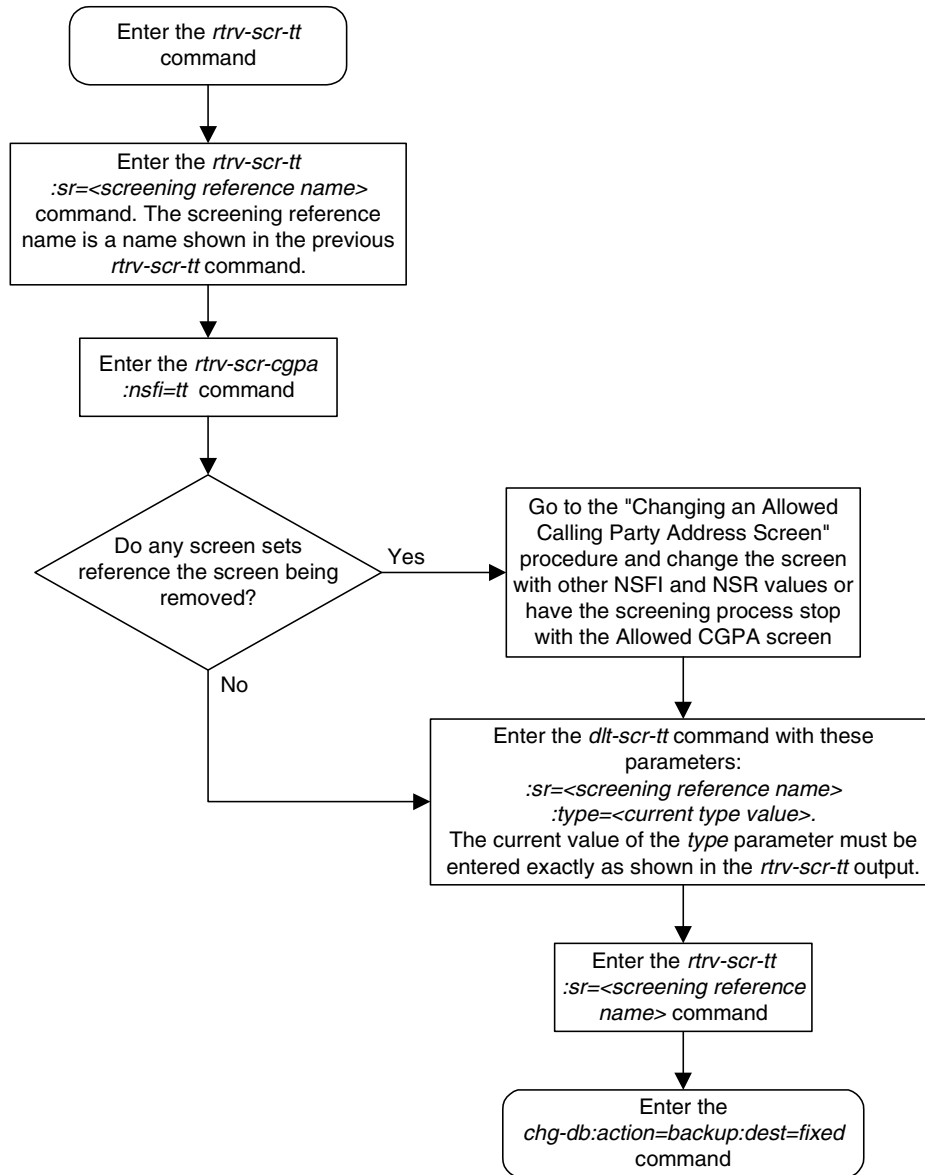

## Changing an Allowed Translation Type Screen

This procedure is used to change the attributes of an allowed translation type (TT) screen in the database using the **chg-scr-tt** command. The parameters used by the **chg-scr-tt** command are shown in the “Gateway Screening Attributes” section on page 2-7. The general rules that apply to configuring gateway screening entities are shown in the “Gateway Screening Configuration” section on page 2-28.

The example in this procedure is used to change the translation type 016 for the allowed CGPA screen **iec** to 210 and change the NSFI to **stop**.

The allowed TT screen can only reference an allowed CDPA screen. This can be verified using the **rtrv-scr-cdpa:all=yes** command. If the desired allowed CDPA screen is not in the database, go to one of these procedures to add the required screen to the database or change an existing screen in the database.

- “Adding an Allowed Called Party Address Screen” procedure on page 4-5
- “Changing an Allowed Called Party Address Screen” procedure on page 4-22

### Specifying a Range of Values

A range of values can be specified for the **type** parameter. The range of values specified for the **type** parameter cannot include any values currently provisioned for the screen reference name.

For example, screening reference name **scr1** contains these entries:

SR	TYPE	NSFI	NSR/ACT
scr1	110	STOP	-----
scr1	125	STOP	-----

Another entry for screening reference **scr1** cannot contain a range of values that would include the **type** parameter values 110 or 125.

### Procedure

---

1. Display the allowed TT screens in the database using the **rtrv-scr-tt** command. The following is an example of the possible output.

```
rlghncxa03w 05-09-25 15:26:30 GMT EAGLE5 34.0.0
SCREEN = ALLOWED TT
SR   REF  RULES
GW16 YES   1
IEC  YES   3
WRD2 YES   1
WRD4 YES   1
```

From the **rtrv-scr-tt** output, display the allowed TT screen you wish to remove using the **rtrv-scr-tt** command with the screening reference name. For this example, enter the **rtrv-scr-tt:sr=iec** command. The following is an example of the possible output.

## Allowed Translation Type (TT) Screen Configuration

The following is an example of the possible output.

```
rlghncxa03w 05-09-25 15:26:30 GMT EAGLE5 34.0.0
SCREEN = ALLOWED TT
SR      TYPE      NSFI      NSR/ACT
IEC     005&&010  STOP     -----
IEC     012       STOP     -----
IEC     016       CDPA     IEC
```

If a gateway screening stop action set is to be assigned to the allowed TT screen being added to the database, go to step 2.

Step 2 verifies the gateway screening stop action set names in the database. The gateway screening stop action set names are assigned only if the NSFI of the screen being changed in this procedure is STOP. If the NSFI of the screen will be changed to STOP, but a gateway screening stop action set name will not be assigned to the screen, skip steps 2 and 3 and go to step 4. If the NSFI of the screen will not be STOP, skip step 2 and go to step 3.

- 
2. Display the gateway screening stop action sets in the database with the **rtrv-gws-actset** command. This is an example of the possible output.

```
rlghncxa03w 05-09-25 15:26:30 GMT EAGLE5 34.0.0
ACT  ACT      ACT  ACT  ACT  ACT  ACT  ACT  ACT  ACT  ACT  ACT
ID   NAME     1    2    3    4    5    6    7    8    9    10
--   -----
1    copy     copy
2    rdct     rdct
3    cr       copy rdct
4    cnf      cnf
5    cpcnf    copy cnf
6    cnf      rdct
7    cpcnf    copy cnf rdct
```

GWS action set table is (7 of 16) 44% full

If the required gateway screening stop action set is not in the database, go to the "Configuring Gateway Screening Stop Action Sets" procedure on page 2-54 and configure the required gateway screening stop action set.

---

**NOTE:** If the NSFI of the screen being added in this procedure is STOP, skip step 3 and go to step 4.

3. Enter the **rtrv-scr-cdpa** command to verify that the screen that will be specified by the NSFI/NSR parameter combination in step 4 is in the database.

If the desired screen is not in the database, go to one of these procedures and either add the desired screen to the database or change an existing screen in the database.

- "Adding an Allowed Called Party Address Screen" procedure on page 4-5
- "Changing an Allowed Called Party Address Screen" procedure on page 4-22

4. Change the attributes of an allowed TT screen using the `chg-scr-tt` command.

If a gateway screening stop action is to be assigned to the allowed TT screen being changed, enter the `chg-scr-tt` command with the `nsfi=stop` parameter and the `actname` parameter with the name of a gateway screening stop action set shown in the output of the `rtrv-gws-actset` command executed in step 2.



**CAUTION:** The EAGLE 5 SAS does not support redirecting MSUs for the DTA feature or intercepting ISUP IAM messages for the Calling Name Conversion Facility feature from the allowed TT screen. Gateway screening stop action sets containing either the RDCT (redirect) or CNCF (calling name conversion facility) stop actions should not be assigned to the allowed TT screen. If a gateway screening stop action set containing the RDCT or CNCF stop actions is specified with the `chg-scr-tt` command, unsolicited information message (UIM) 1128 is generated when the attempt is made to redirect MSUs from the allowed TT screen. Unsolicited information message (UIM) 1218 is generated when ISUP IAM MSUs are intercepted from the allowed TT screen. For more information on UIMs 1128 and 1218, go to the *Maintenance Manual*.

The value of the `ntype` parameter can be from 0 to 255 or an asterisk (\*). The current value of the `type` parameter must be entered exactly as shown in the `rtrv-scr-tt` output in step 1.

A range of values can be specified for the `ntype` parameter. See the "Specifying a Range of Values" section on page 5-14 for more information on how a range of values is used for the `ntype` parameter.

For this example, enter this command.

```
chg-scr-tt:sr=iec:type=016:ntype=210:nsfi=stop
```

A message similar to the following should appear.

```
rlghncxa03w 05-09-25 15:27:30 GMT EAGLE5 34.0.0
CHG-SCR-TT: SCREEN SET AFFECTED - IEC 4% FULL
CHG-SCR-TT: MASP A - COMPLTD
```

---

5. Verify the changes using the `rtrv-scr-tt` command with the screening reference name used in step 4. For this example, enter this command.

```
rtrv-scr-tt:sr=iec
```

The following is an example of the possible output.

```
rlghncxa03w 05-09-25 15:26:30 GMT EAGLE5 34.0.0
SCREEN = ALLOWED TT
SR   TYPE   NSFI   NSR/ACT
IEC  005&&010 STOP  -----
IEC  012     STOP  -----
IEC  210     STOP  -----
```

---



## Allowed Translation Type (TT) Screen Configuration

6. Backup the new changes using the `chg-db:action=backup:dest=fixed` command. The following messages should appear, the active Maintenance and Administration Subsystem Processor (MASP) appears first.

```
BACKUP (FIXED) : MASP A - Backup starts on active MASP.  
BACKUP (FIXED) : MASP A - Backup on active MASP to fixed disk complete.  
BACKUP (FIXED) : MASP A - Backup starts on standby MASP.  
BACKUP (FIXED) : MASP A - Backup on standby MASP to fixed disk complete.
```

---

Flowchart 5-4. Changing an Allowed Translation Type Screen (Sheet 1 of 3)

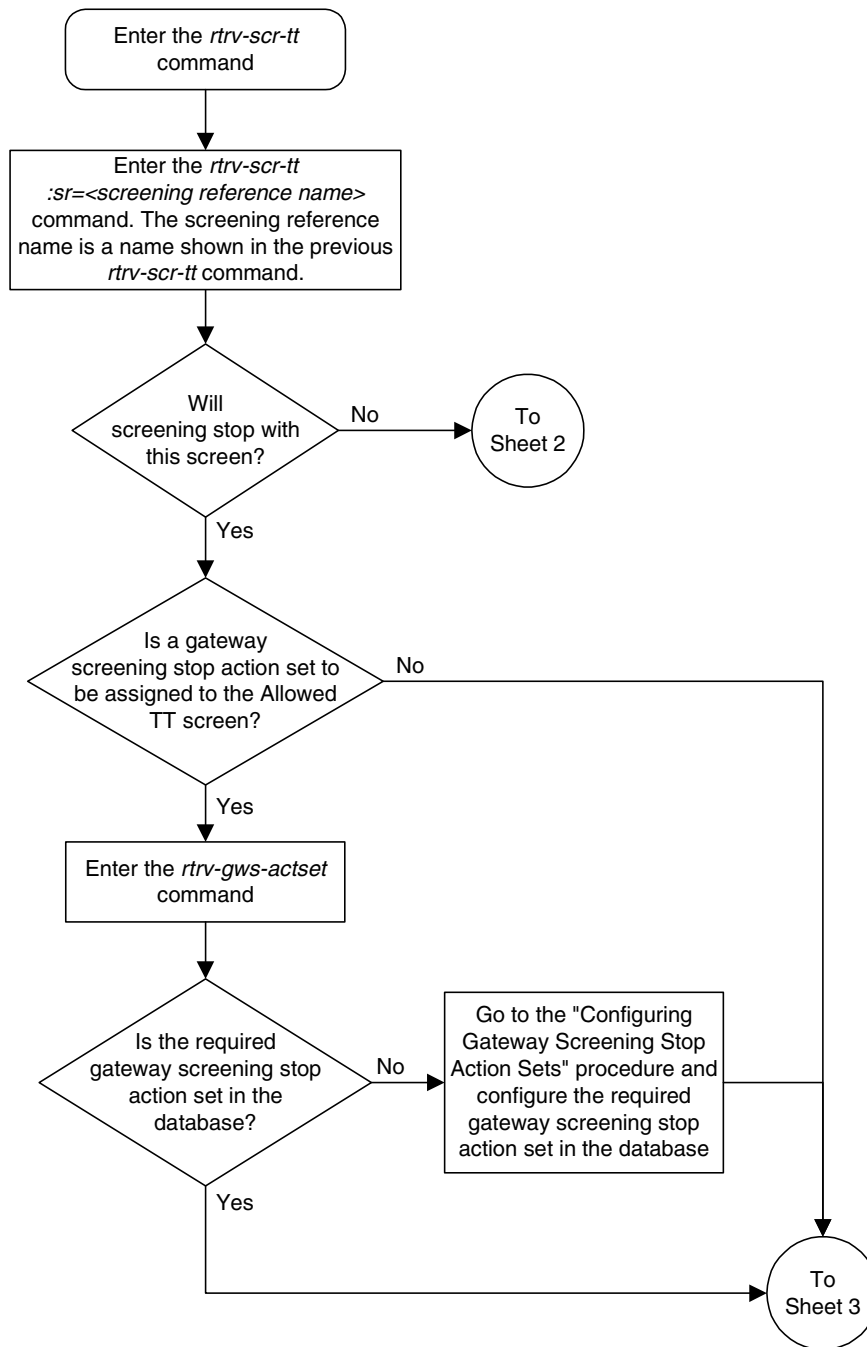

## Allowed Translation Type (TT) Screen Configuration

Flowchart 5-4. Changing an Allowed Translation Type Screen (Sheet 2 of 3)

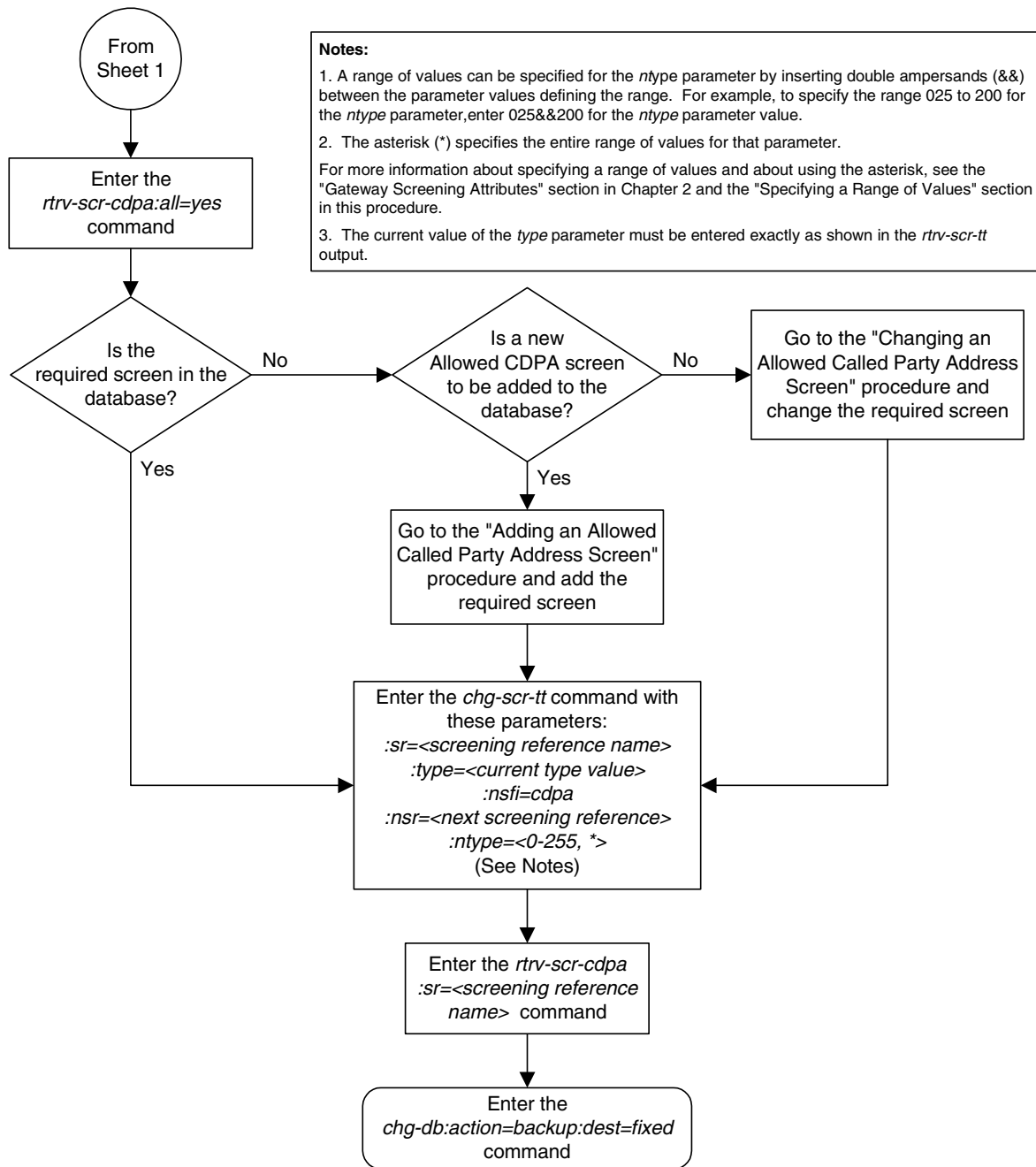

Flowchart 5-4. Changing an Allowed Translation Type Screen (Sheet 3 of 3)

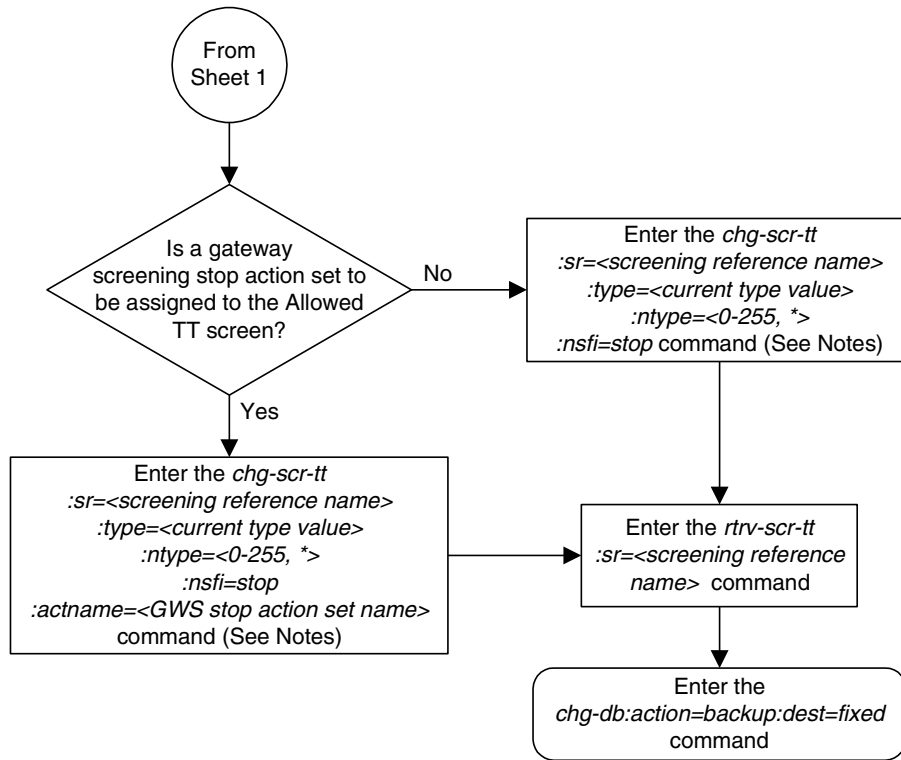

**Notes:**

1. A range of values can be specified for the *ntype* parameter by inserting double ampersands (&&) between the parameter values defining the range. For example, to specify the range 025 to 200 for the *ntype* parameter, enter 025&&200 for the *ntype* parameter value.
  2. The asterisk (\*) specifies the entire range of values for that parameter.
- For more information about specifying a range of values and about using the asterisk, see the "Gateway Screening Attributes" section in Chapter 2 and the "Specifying a Range of Values" section in this procedure.
3. The current value of the *type* parameter must be entered exactly as shown in the *rtrv-scr-tt* output.

# 6

## Allowed Calling Party (CGPA) Screen Configuration

Introduction.....	6-2
Adding an Allowed Calling Party Address Screen.....	6-6
Removing an Allowed Calling Party Address Screen .....	6-18
Changing an Allowed Calling Party Address Screen .....	6-23

## Introduction

The allowed calling party address (CGPA) screen is used to screen SCCP messages from another network. The gray shaded areas in Figure 6-1 shows the fields of the SS7 message that are checked by the CGPA screening function. The screening reference contains a list of point codes and subsystem number combinations. If a match is found, the **nsfi** is examined to determine the next step in the screening process.

If the **nsfi** is equal to **stop**, the message is processed and no further screening takes place.

If the **nsfi** is equal to **stop**, and the **copy** gateway screening stop action is specified, the message is processed and a copy of the message is sent by the STP LAN feature to an external application through an ACM running the **stplan** application or a DCM running the **vxwslan** application.

If the **nsfi** is equal to anything else, the next screening reference (**nsr**) is identified and the screening process continues to the next screen identified by the **nsfi** and **nsr** parameters. If no match is found, the message is discarded.

Any MSU that does not contain a service indicator of 3 in the SIO field and does not contain the SCCP message types 9, 10, 17, or 18 and reaches this screen in the gateway screening process automatically passes gateway screening and is allowed into the EAGLE 5 SAS.

The value of the **nsfi** parameter is based on the value of the routing indicator (**ri**) parameter. Table 6-1 shows the valid combinations of **nsfi** values and routing indicator values.

**Table 6-1.** Valid Parameter Combinations for the Allowed CGPA Screening Function

Routing Indicator (RI) Values	Nest Screening Function Identifier (NSFI) Values
GT	TT
DPC	CDPA
* (asterisk)	TT, CDPA

Flowchart 6-1 shows the screening action of the allowed CGPA screen.

Allowed Calling Party (CGPA) Screen Configuration

Flowchart 6-1. Allowed CGPA Screening Action (Sheet 1 of 2)

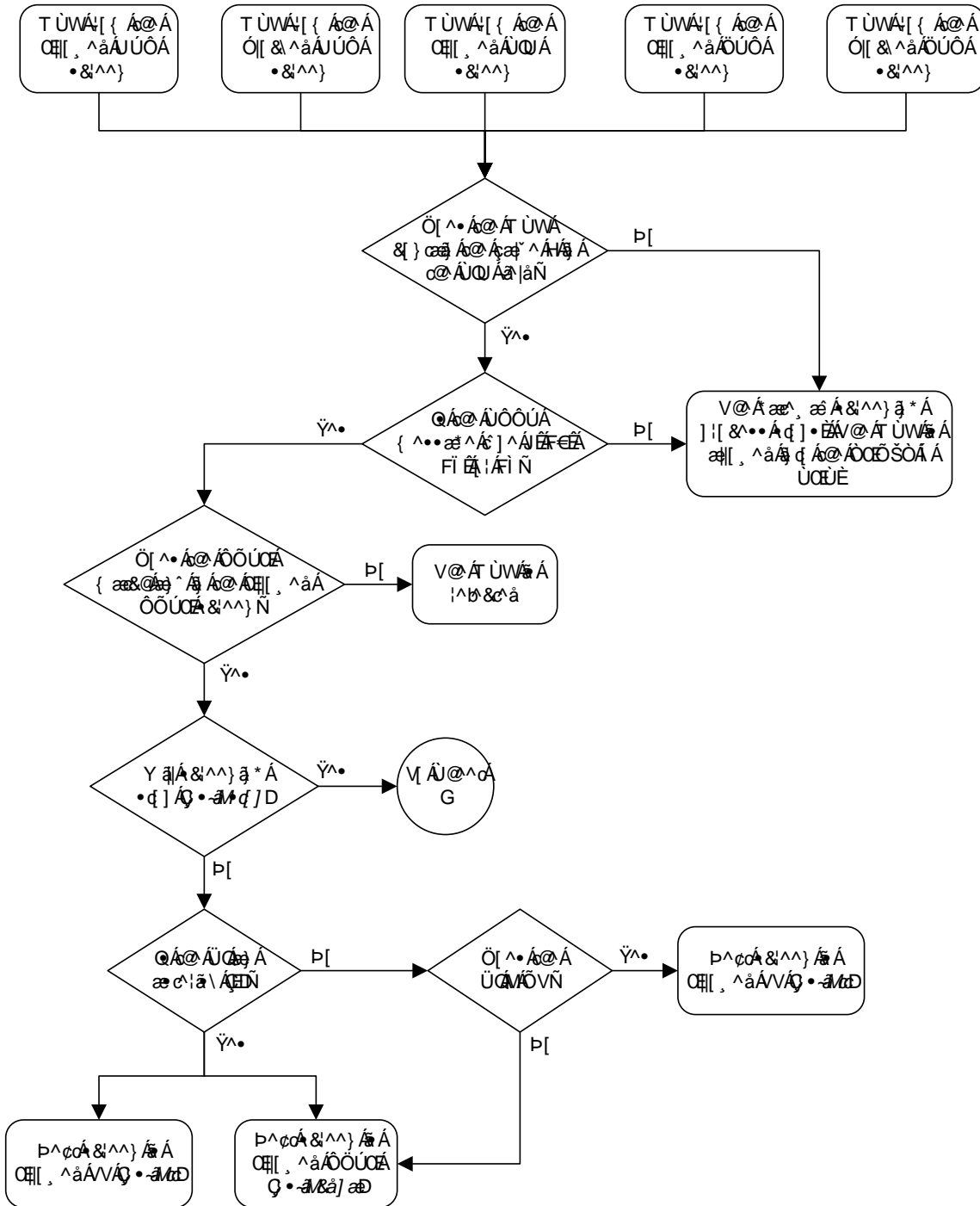





# Allowed Calling Party (CGPA) Screen Configuration

**Figure 6-1.** Allowed Calling Party Address Screening Function

**ANSI MSU (ANSI Message Signal Unit)**

BSN FSN LI	SIO xx xx xxxx NIC PRI SI	SIF				
		Routing Label DPC      OPC      SLS NCM NC NI   NCM NC NI   xx	SCCP Message Type xxxx xxxx	CGPA Length Address Indicator Subsystem Point Code (NCM NC NI)	CDPA Length Address Indicator (x x xxxx xx) (x RI xxxx xx) Subsystem Point Code (NCM NC NI)	

**ITU-I MSU (ITU International Message Signal Unit)**

BSN FSN LI	SIO xx xx xxxx NIC PRI SI	SIF				
		Routing Label DPC      OPC      SLS ID AREA ZONE ID AREA ZONE xx	SCCP Message Type xxxx xxxx	CGPA Length Address Indicator Subsystem Point Code (ID AREA ZONE)	CDPA Length Address Indicator (x x xxxx xx) (x RI xxxx xx) Subsystem Point Code (ID AREA ZONE)	

**14-Bit ITU-N MSU (14-Bit ITU National Message Signal Unit)**

BSN FSN LI	SIO xx xx xxxx NIC PRI SI	SIF				
		Routing Label DPC      OPC      SLS NPC      NPC      xx	SCCP Message Type xxxx xxxx	CGPA Length Address Indicator Subsystem Point Code (NPC)	CDPA Length Address Indicator (x x xxxx xx) (x RI xxxx xx) Subsystem Point Code (NPC)	

**24-Bit ITU-N MSU (24-Bit ITU National Message Signal Unit)**

BSN FSN LI	SIO xx xx xxxx NIC PRI SI	SIF				
		Routing Label DPC      OPC      SLS SP SSA MSA   SP SSA MSA   xx	SCCP Message Type xxxx xxxx	CGPA Length Address Indicator Subsystem Point Code (SP SSA MSA)	CDPA Length Address Indicator (x x xxxx xx) (x RI xxxx xx) Subsystem Point Code (SP SSA MSA)	

## Adding an Allowed Calling Party Address Screen

This procedure is used to add an allowed calling party address (CGPA) screen to the database using the `ent-scr-cgpa` command. The parameters used by the `ent-scr-cgpa` command are shown in the “Gateway Screening Attributes” section on page 2-7. The general rules that apply to configuring gateway screening entities are shown in the “Gateway Screening Configuration” section on page 2-28.

The examples in this procedure are used to add the allowed CGPA screen data shown in Table 6-2 and based on the example configurations shown in Figure 2-3 on page 2-33 through Figure 2-5 on page 2-37.

**Table 6-2.** Example Gateway Screening Allowed CGPA Configuration Table

Screening Reference	ZONE	AREA	ID	SSN	RI	SCCPMT	NSFI	NSR
gw11	7	100	4	254	*	010	cdpa	gw15
Screening Reference	NI	NC	NCM	SSN	RI	SCCPMT	NSFI	NSR
gw13	007	007	007	250	gt	017	tt	gw16
gw14	006	006	006	253	dpc	009	cdpa	gw17

**NOTE:** If you using multiple-part ITU national point codes with gateway screening, see “14-Bit ITU National Point Code Formats” on page 2-24.

The allowed CGPA screen can reference one of the following screens.

- Allowed TT
- Allowed CDPA

Enter the following commands to verify that these screens are in the database.

- `rtrv-scr-tt:all=yes`
- `rtrv-scr-cdpa:all=yes`

If the desired screen is not in the database, go to one of the following procedures and add the desired screen to the database or change an existing screen in the database.

- “Adding an Allowed Translation Type Screen” procedure on page 5-4
- “Adding an Allowed Called Party Address Screen” procedure on page 4-5
- “Changing an Allowed Translation Type Screen” procedure on page 5-14
- “Changing an Allowed Called Party Address Screen” procedure on page 4-22

## Allowed Calling Party (CGPA) Screen Configuration

### Specifying a Range of Values

A range of values can be specified for the point code parameters **ni**, **nc**, or **ncm**.

If a range of values is specified for any of these parameters, and the value of the other parameters match existing values for the screening reference name, the range of values for the point code parameter cannot include any values for that parameter that are currently provisioned for the screening reference name.

For example, screening reference name **scr1** contains these entries:

SR	NI	NC	NCM	SSN	RI	SCCPMT	NSFI	NSR/ACT
SCR1	240	001	010	012	DPC	009	STOP	-----
SCR1	241	010	020	*	GT	017	TT	SCR1

Another entry for screening reference **scr1** with the **ni** value of 240 and the **nc** value of 001 cannot be specified if the range of values for the **ncm** parameter includes the value 010.

The ANSI point code parameter values can be specified as a single value, a range of values, or with an asterisk (\*). The asterisk specifies all possible values for the **ni**, **nc**, and **ncm** parameters. Table 6-3 shows the valid combinations of these parameter values.

**Table 6-3.** Valid Value Combinations for ANSI Point Code Parameters

NI	NC	NCM
Single Value	Single Value	Single Value
Single Value	Single Value	Range of Values
Single Value	Single Value	Asterisk
Single Value	Range of Values	Asterisk
Single Value	Asterisk	Asterisk
Range of Values	Asterisk	Asterisk
Asterisk	Asterisk	Asterisk

A range of values can also be specified for an ITU-I or 24-bit ITU-N point code parameter using a combination of asterisks (\*) and single values for the point code parameters. Table 6-4 shows the valid combinations of the ITU-I parameter values. Table 6-5 shows the valid combinations of the 24-bit ITU-N parameter values.

**Table 6-4.** Valid Value Combinations for ITU-I Point Code Parameters

ZONE	AREA	ID
Single Value	Single Value	Single Value
Single Value	Single Value	Asterisk
Single Value	Asterisk	Asterisk
Asterisk	Asterisk	Asterisk

**Table 6-5.** Valid Value Combinations for 24-Bit ITU-N Point Code Parameters

MSA	SSA	SP
Single Value	Single Value	Single Value
Single Value	Single Value	Asterisk
Single Value	Asterisk	Asterisk
Asterisk	Asterisk	Asterisk

**Procedure**

---

1. Verify that the gateway screening feature is on, by entering the `rtrv-feat` command. If the gateway screening feature is on, the `GWS` field is set to `on`.

**NOTE:** The `rtrv-feat` command output contains other fields that are not used by this procedure. If you wish to see all the fields displayed by the `rtrv-feat` command, see the `rtrv-feat` command description in the *Commands Manual*.

If the gateway screening feature is on, shown by the entry `GWS = on` in the `rtrv-feat` command output, skip step 2, and go to step 3.

---

2. Turn the gateway screening feature on by entering this command.

`chg-feat:gws=on`

**NOTE:** Once the gateway screening feature is turned on with the `chg-feat` command, it cannot be turned off.

The gateway screening feature must be purchased before you turn this feature on with the `chg-feat` command. If you are not sure if you have purchased the gateway screening feature, contact your Tekelec Sales Representative or Account Representative.

When the `chg-feat` has successfully completed, this message should appear.

```
rlghncxa03w 05-09-28 11:43:04 GMT EAGLE5 34.0.0
CHG-FEAT: MASP A - COMPLTD
```

---

## Allowed Calling Party (CGPA) Screen Configuration

3. Display all allowed CGPA screens in the database using the **rtrv-scr-cgpa** command. The following is an example of the possible output.

```
rlghncxa03w 05-09-25 15:25:30 GMT EAGLE5 34.0.0
SCREEN = ALLOWED CGPA
SR   REF  RULES
IEC  YES   2
WRD2 YES   1
WRD4 YES   9
```

If the screening reference names that you wish to add with this procedure are not shown in the **rtrv-scr-cgpa** command output, go to step 2. For this example, the screening reference names are not shown. If these screening reference names are shown in the **rtrv-scr-cgpa** command output, make sure the screening data you wish to enter is not already in the database by entering the **rtrv-scr-cgpa** command with the screening reference name. For example, enter the **rtrv-scr-cgpa:sr=iec** command. The following is an example of the possible output.

```
rlghncxa03w 05-09-25 15:26:30 GMT EAGLE5 34.0.0
SCREEN = ALLOWED CGPA
SR  NI      NC      NCM      SSN      RI      SCCPMT  NSFI      NSR/ACT
IEC 240      001      010      012      DPC  009      STOP      -----
IEC 241      010      *        *        GT   017      TT        TT1
```

If a gateway screening stop action set is to be assigned to the allowed CGPA screen being added to the database, go to step 4.

Step 4 verifies the gateway screening stop action set names in the database. The gateway screening stop action set names are assigned only if the NSFI of the screen being added in this procedure is STOP. If the NSFI of the new screen will be STOP, but a gateway screening stop action set name will not be assigned to the new screen, skip steps 4 and 5 and go to step 6. If the NSFI of the new screen is not STOP, skip step 4 and go to step 5.

- 
4. Display the gateway screening stop action sets in the database with the **rtrv-gws-actset** command. This is an example of the possible output.

```
rlghncxa03w 05-09-25 15:27:30 GMT EAGLE5 34.0.0
ACT ACT  ACT ACT  ACT ACT  ACT ACT  ACT ACT  ACT ACT
ID  NAME  1    2    3    4    5    6    7    8    9    10
--  ----  ---  ---  ---  ---  ---  ---  ---  ---  ---  ---
1   copy  copy
2   rdct  rdct
3   cr    copy rdct
4   cnf   cnf
5   cpcnf copy cnf
6   cnfrd cnf rdct
7   cpcfrd copy cnf rdct
```

```
GWS action set table is (7 of 16) 44% full
```

If the required gateway screening stop action set is not in the database, go to the “Configuring Gateway Screening Stop Action Sets” procedure on page 2-54 and configure the required gateway screening stop action set.

---

**NOTE:** If the NSFI of the screen being added in this procedure is STOP, skip step 5 and go to step 6.

5. Enter the commands on page 6-6 to verify that the screen that will be specified by the NSFI/NSR parameter combination in step 7 is in the database.

If the desired screen is not in the database, go to one of the procedures shown on page 6-6 and either add the desired screen to the database or change an existing screen in the database.

**NOTE:** If the point code being added in this procedure is not an ITU-I or 14-bit ITU-N spare point code, skip this step and to to step 7.

**NOTE:** If the point code being added in this procedure is an ITU-I or 14-bit ITU-N spare point code and the screening reference contains ITU-I or 14-bit ITU-N spare point codes, skip this step and go to step 7.

6. Display the status of the ITU National and International Spare Point Code Support feature by entering the `rtrv-ctrl-feat` command with the ITU National and International Spare Point Code Support feature part number. Enter this command.

`rtrv-ctrl-feat:partnum=893013601`

This is an example of the possible output.

```
rlghncxa03w 05-09-25 15:25:30 GMT EAGLE5 34.0.0
The following features have been permanently enabled:
```

Feature Name	Partnum	Status	Quantity
Spare Point Code Support	893013601	on	----

The following features have been temporarily enabled:

Feature Name	Partnum	Status	Quantity	Trial Period	Left
Zero entries found.					

The following features have expired temporary keys:

Feature Name	Partnum
Zero entries found.	

If the ITU National and International Spare Point Code Support feature is enabled, go to step 7.

If the ITU National and International Spare Point Code Support feature is not enabled, perform the "Activating the ITU National and International Spare Point Code Support Feature" procedure in the *Database Administration Manual - SS7* to enable the ITU National and International Spare Point Code Support feature as required. After the feature has been enabled, go to step 7.

## Allowed Calling Party (CGPA) Screen Configuration

7. Add a new allowed CGPA screen to the database using the `ent-scr-cgpa` command.

If a gateway screening stop action is to be assigned to the allowed CGPA screen being changed, enter the `ent-scr-cgpa` command with the `nsfi=stop` parameter and the `actname` parameter with the name of a gateway screening stop action set shown in the output of the `rtrv-gws-actset` command executed in step 4.



**CAUTION:** The EAGLE 5 SAS does not support redirecting MSUs for the DTA feature or intercepting ISUP IAM messages for the Calling Name Conversion Facility feature from the allowed CGPA screen. Gateway screening stop action sets containing either the RDCT (redirect) or CNCF (calling name conversion facility) stop actions should not be assigned to the allowed CGPA screen. If a gateway screening stop action set containing the RDCT or CNCF stop actions is specified with the `ent-scr-cgpa` command, unsolicited information message (UIM) 1126 is generated when the attempt is made to redirect MSUs from the allowed CGPA screen. Unsolicited information message (UIM) 1216 is generated when ISUP IAM MSUs are intercepted from the allowed CGPA screen. For more information on UIMs 1126 and 1216, go to the *Maintenance Manual*.

The following list contains the values for `ni`, `nc`, `ncm`, `zone`, `area`, `id`, `npc`, `msa`, `ssa`, `sp`, `ssn`, `ri`, and `sccpmt` parameters:

- `ni` – 0 - 255 or an asterisk (\*)
- `nc` – 0 - 255 or an asterisk (\*)
- `ncm` – 0 - 255 or an asterisk (\*)
- `zone` – 0 - 7 or an asterisk (\*)
- `area` – 0 - 255 or an asterisk (\*)
- `id` – 0 - 7 or an asterisk (\*)
- `npc` – 1 - 16383 or an asterisk (\*)
- `msa` – 0 - 255 or an asterisk (\*)
- `ssa` – 0 - 255 or an asterisk (\*)
- `sp` – 0 - 255 or an asterisk (\*)
- `ssn` – 0 - 255 or an asterisk (\*)
- `ri` – gt, dpc or an asterisk (\*)
- `sccpmt` – 9, 10, 17, 18 or an asterisk (\*)

**NOTE:** If either the `ri=gt` or `nsfi=tt` parameter is specified, the other parameter must be specified. If either the `ri=dpc` or `nsfi=cdpa` parameter is specified, the other parameter must be specified. If the `ri=*` parameter is specified, either the `nsfi=gt` or `nsfi=dpc` parameters can be specified.

**NOTE:** If the **sccpmt** parameter is not specified, an asterisk will be entered as the value of the **sccpmt** parameter.

A range of values can be specified for the **ni**, **nc**, and **ncm** parameters. See the "Specifying a Range of Values" section on page 6-7 for more information on how the asterisk and a range of values are used for the **ni**, **nc**, and **ncm** parameters.

To add a spare point code to the allowed CGPA screen, the **pcst=s** parameter must be specified. To add a non-spare point code to the allowed CGPA screen, the **pcst** parameter does not have to be specified. If the **pcst** parameter is specified for a screen containing an ITU-I or 14-bit ITU-N non-spare point code, the value must be **none**.

For this example, enter these commands.

```
ent-scr-cgpa:sr=gw11:zone=7:area=100:id=4:ssn=254:ri=*
:sccpmt=010:nsfi=cdpa:nsr=gw15
```

A message similar to the following should appear.

```
rlghncxa03w 05-09-25 15:28:30 GMT EAGLE5 34.0.0
ENT-SCR-CGPA: SCREEN SET AFFECTED - GW11 1% FULL
ENT-SCR-CGPA: MASP A - COMPLTD
```

```
ent-scr-cgpa:sr=gw13:ni=007:nc=007:ncm=007:ssn=250:ri=gt
:sccpmt=017:nsfi=tt:nsr=gw16
```

A message similar to the following should appear.

```
rlghncxa03w 05-09-25 15:29:30 GMT EAGLE5 34.0.0
ENT-SCR-CGPA: SCREEN SET AFFECTED - GW13 1% FULL
ENT-SCR-CGPA: MASP A - COMPLTD
```

```
ent-scr-cgpa:sr=gw14:ni=006:nc=006:ncm=006:ssn=253:ri=dpc
:sccpmt=009:nsfi=cdpa:nsr=gw17
```

A message similar to the following should appear.

```
rlghncxa03w 05-09-25 15:30:30 GMT EAGLE5 34.0.0
ENT-SCR-CGPA: SCREEN SET AFFECTED - GW14 1% FULL
ENT-SCR-CGPA: MASP A - COMPLTD
```

- Verify the changes using the **rtrv-scr-cgpa** command with the screening reference name used in step 7. For this example, enter these commands.

```
rtrv-scr-cgpa:sr=gw11
```

The following is an example of the possible output.

```
rlghncxa03w 05-09-25 15:32:30 GMT EAGLE5 34.0.0
SCREEN = ALLOWED CGPA
SR      ZONE  AREA  ID      SSN      RI  SCCPMT  NSFI  NSR/ACT
GW11    7      100   4       254     *   010     CDPA  GW15
```

```
rtrv-scr-cgpa:sr=gw13
```

The following is an example of the possible output.

```
rlghncxa03w 05-09-25 15:33:30 GMT EAGLE5 34.0.0
SCREEN = ALLOWED CGPA
SR  NI      NC      NCM      SSN      RI  SCCPMT  NSFI  NSR/ACT
GW13 007     007     007     250     SSN 017     CDPA  GW16
```



## Allowed Calling Party (CGPA) Screen Configuration

```
rtrv-scr-cgpa:sr=gw14
```

The following is an example of the possible output.

```
rlghncxa03w 05-09-25 15:34:30 GMT EAGLE5 34.0.0
SCREEN = ALLOWED CGPA
SR      NI      NC      NCM      SSN      RI      SCCPMT  NSFI      NSR/ACT
GW14   006      006      006      253      GT      009      TT        GW17
```

---

9. Backup the new changes using the **chg-db:action=backup:dest=fixed** command. The following messages should appear, the active Maintenance and Administration Subsystem Processor (MASP) appears first.

```
BACKUP (FIXED) : MASP A - Backup starts on active MASP.
BACKUP (FIXED) : MASP A - Backup on active MASP to fixed disk complete.
BACKUP (FIXED) : MASP A - Backup starts on standby MASP.
BACKUP (FIXED) : MASP A - Backup on standby MASP to fixed disk complete.
```

---

**Flowchart 6-2.** Adding an Allowed Calling Party Address Screen (Sheet 1 of 4)

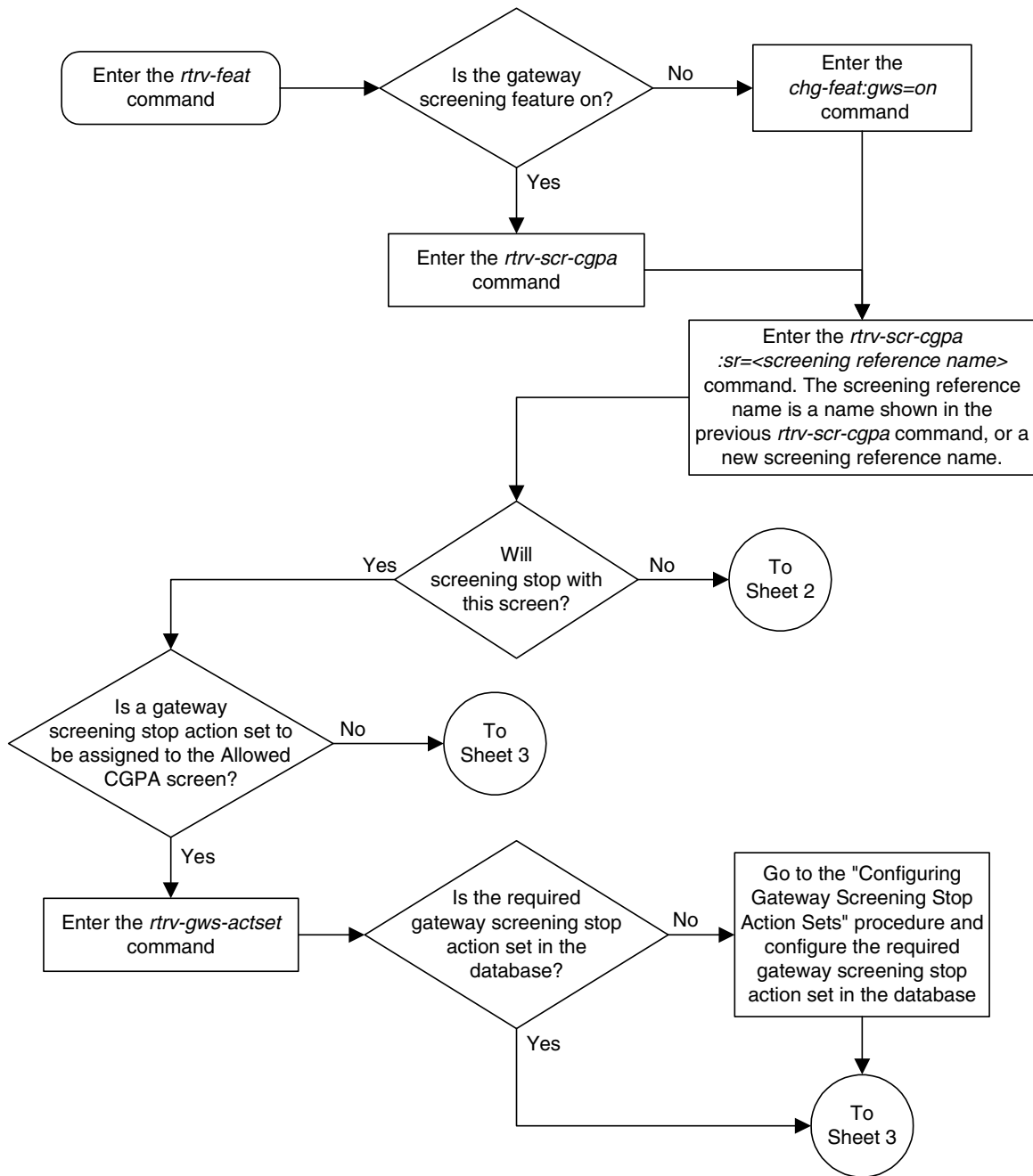

## Allowed Calling Party (CGPA) Screen Configuration

**Flowchart 6-2.** Adding an Allowed Calling Party Address Screen (Sheet 2 of 4)

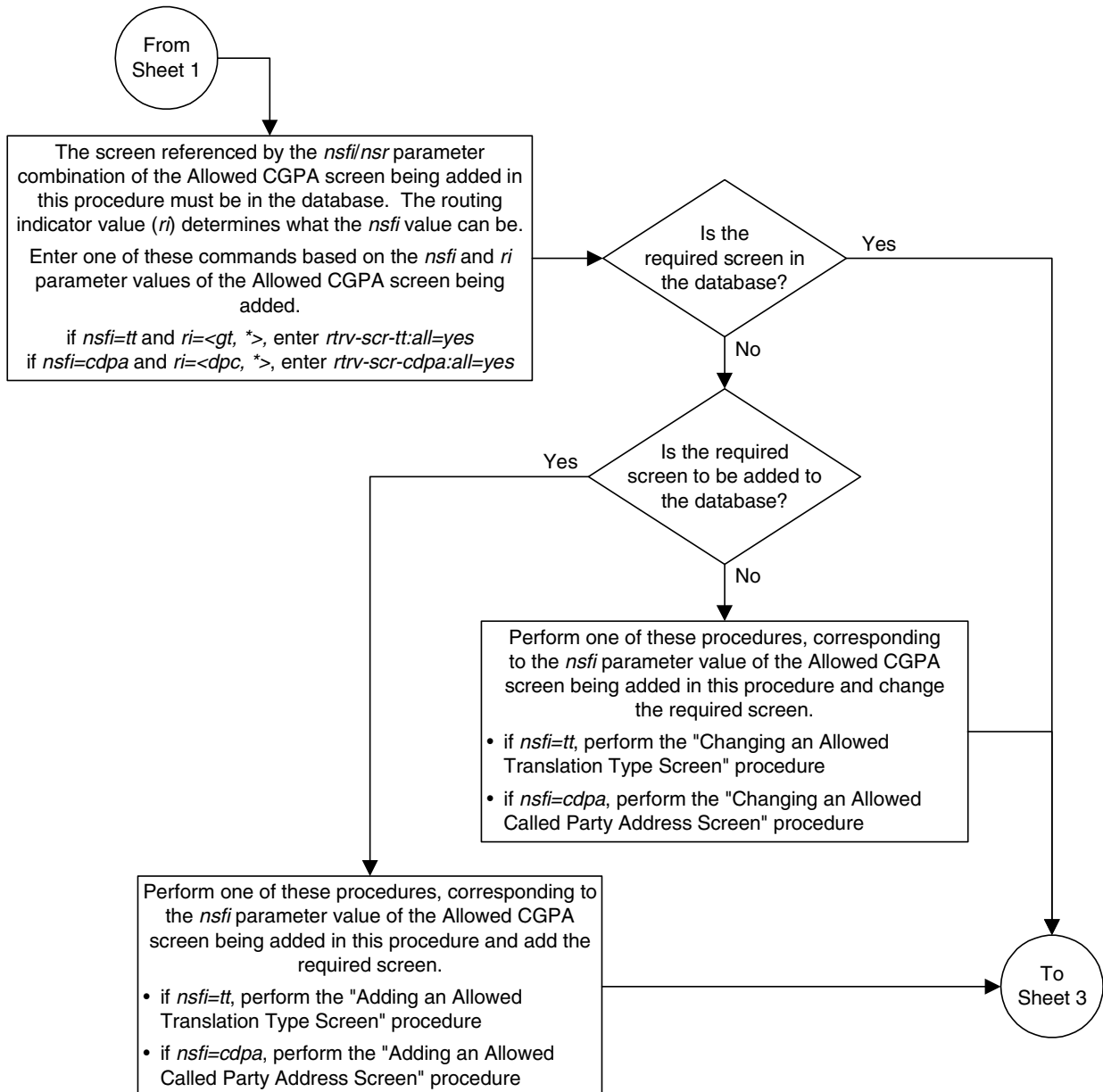

Flowchart 6-2. Adding an Allowed Calling Party Address Screen (Sheet 3 of 4)

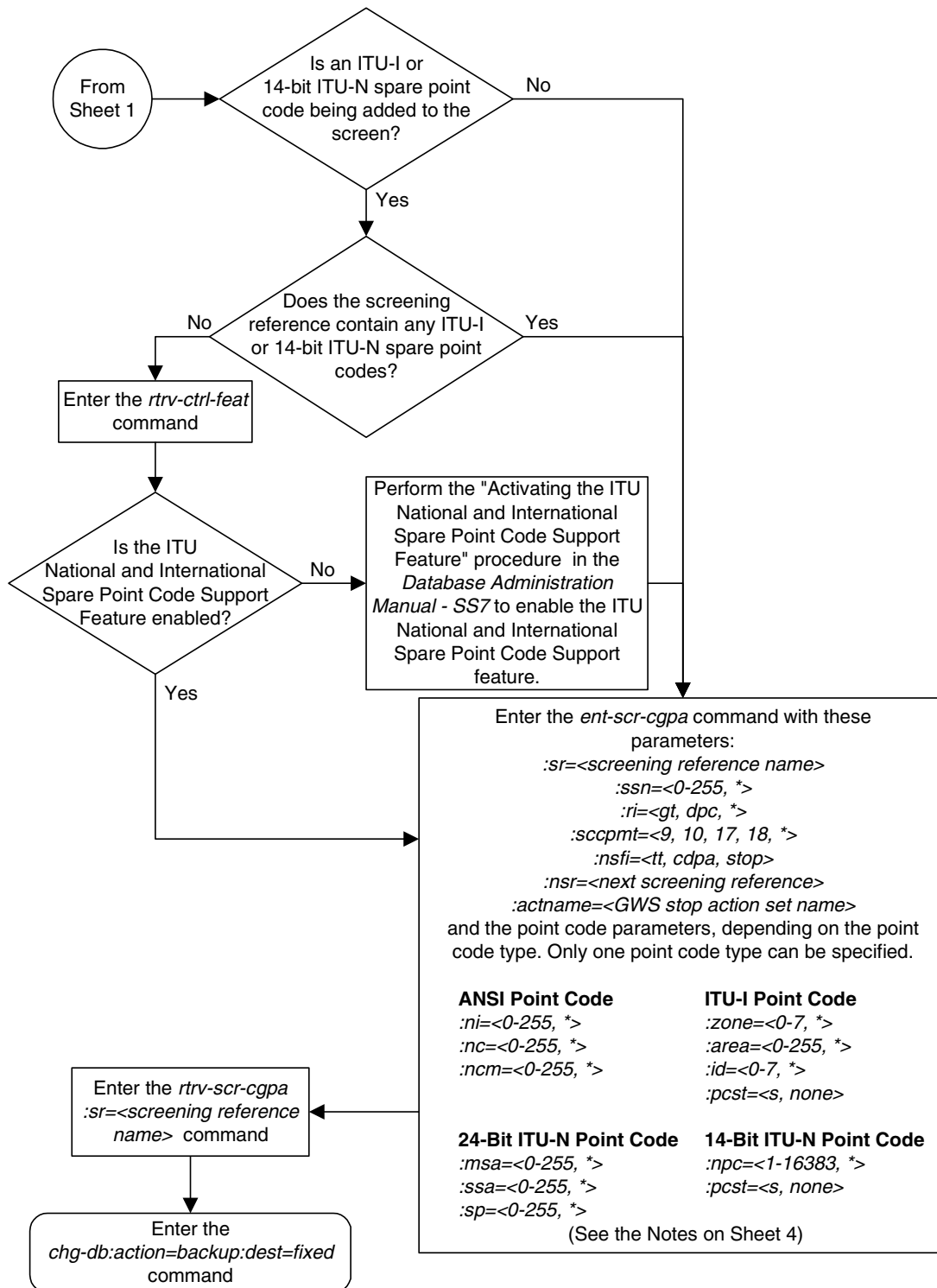

## Allowed Calling Party (CGPA) Screen Configuration

### Flowchart 6-2. Adding an Allowed Calling Party Address Screen (Sheet 4 of 4)

**Notes:**

1. A range of values can be specified for the *ni*, *nc*, or *ncm* parameters by inserting double ampersands (&&) between the parameter values defining the range. For example, to specify the range 025 to 200 for the *ni* parameter, enter 025&&200 for the *ni* parameter value.
2. The asterisk (\*) specifies the entire range of values for that parameter.  
For more information about specifying a range of values and about using the asterisk, see the "Gateway Screening Attributes" section in Chapter 2 and the "Specifying a Range of Values" section in this procedure.
3. If the *scpmt* parameter is not specified, an asterisk will be entered as the value for the *scpmt* parameter.
4. To specify the *nsfi=tt* parameter, the *ri* parameter value must be *gt* or \*.
5. To specify the *nsfi=cdpa* parameter, the *ri* parameter value must be *dpc* or \*.
6. The *nsr* parameter can be specified only, and must be specified, if the *nsfi=tt* or *nsfi=cdpa* parameters are specified.
7. The *actname* parameter can be specified only if the *nsfi=stop* parameter is specified. The *actname* parameter is optional. If the *actname* parameter is specified, the *actname* parameter value is one of the gateway screening stop action set names shown in the *rtrv-gws-actset* output on Sheet 1.
8. To add a non-spare point code, the *pcst* parameter does not have to be specified. If the *pcst* parameter is specified for a screen containing an ITU-I or 14-bit ITU-N non-spare point code, the value must be *none*.
9. To add a spare point code, the *pcst=s* parameter must be specified.

## Removing an Allowed Calling Party Address Screen

This procedure is used to remove an allowed calling party address (CGPA) screen from the database using the `dlt-scr-cgpa` command. The parameters used by the `dlt-scr-cgpa` command are shown in the "Gateway Screening Attributes" section on page 2-7. The general rules that apply to configuring gateway screening entities are shown in the "Gateway Screening Configuration" section on page 2-28.

The example in this procedure removes the allowed CGPA screen `gw14` from the database.

**NOTE:** If you using multiple-part ITU national point codes with gateway screening, see "14-Bit ITU National Point Code Formats" on page 2-24.

The allowed CGPA screen can be referenced by one of the following screens.

- Allowed OPC
- Blocked OPC
- Allowed SIO
- Allowed DPC
- Blocked DPC

Enter the following commands to verify that none of these screens reference the allowed CGPA screen being removed from the database.

- `rtrv-scr-opc:nsfi=cgpa`
- `rtrv-scr-blkopc:nsfi=cgpa`
- `rtrv-scr-sio:nsfi=cgpa`
- `rtrv-scr-dpc:nsfi=cgpa`
- `rtrv-scr-blkdpc:nsfi=cgpa`

To change the NSFI of any of these screens, go to one of the following procedures.

- "Changing a Blocked DPC Screen" procedure on page 8-26
- "Changing an Allowed DPC Screen" procedure on page 9-26
- "Changing an Allowed SIO Screen" procedure on page 10-23
- "Changing a Blocked OPC Screen" procedure on page 11-26
- "Changing an Allowed OPC Screen" procedure on page 12-25

### Procedure

---

1. Display the allowed CGPA screens in the database using the **rtrv-scr-cgpa** command. The following is an example of the possible output.

```
rlghncxa03w 05-09-25 15:25:30 GMT EAGLE5 34.0.0
SCREEN = ALLOWED CGPA
SR   REF  RULES
GW11 YES   1
GW13 YES   1
GW14 YES   1
IEC  YES   2
WRD2 YES   1
WRD4 YES   9
```

From the **rtrv-scr-cgpa** output, display the allowed CGPA screen you wish to remove using the **rtrv-scr-cgpa** command with the screening reference name. For this example, enter the **rtrv-scr-cgpa:sr=gw14** command. The following is an example of the possible output.

```
rtrv-scr-cgpa:sr=gw14
```

The following is an example of the possible output.

```
rlghncxa03w 05-09-25 15:25:30 GMT EAGLE5 34.0.0
SCREEN = ALLOWED CGPA
SR  NI      NC      NCM      SSN      RI      SCCPMT  NSFI  NSR/ACT
GW14 003      003      003      253      GT      009     TT     GW17
```

---

2. Enter the commands on page 6-18 to verify that the screen being removed is not referenced by other screens in the database. If the screen being removed is referenced by other screens, go to the procedures shown on page 6-18 and change the NSFI of those screens to reference other screens or change the NSFI of these screens to STOP.
- 

3. Remove the allowed CGPA screen from the database using the **dlt-scr-cgpa** command. The current values for the **ni**, **nc**, **ncm**, **zone**, **area**, **id**, **npc**, **msa**, **ssa**, **sp**, **ri**, **ssn**, or **sccpmt** parameters must be entered exactly as shown in the **rtrv-scr-cgpa** output.

To remove an entry containing either an ITU-I or a 14-bit ITU-N spare point code, the **pcst=s** parameter must be specified with the **dlt-scr-cgpa** command.

To remove an entry containing either an ITU-I or a 14-bit ITU-N non-spare point code, the **pcst** parameter does not have to be specified with the **dlt-scr-cgpa** command. If the **pcst** parameter is specified, the value must be **none**.

## Allowed Calling Party (CGPA) Screen Configuration

For this example, enter this command.

```
dlt-scr-cgpa:sr=gw14:ni=003:nc=003:ncm=003:ssn=253:sccpmt=009
```

A message similar to the following should appear.

```
rlghncxa03w 05-09-25 15:26:30 GMT EAGLE5 34.0.0  
DLT-SCR-CGPA: SCREEN SET AFFECTED - GW14 0% FULL  
DLT-SCR-CGPA: MASP A - COMPLTD
```

---

4. Verify the changes using the **rtrv-scr-cgpa** command with the screening reference name used in step 3. For this example, enter this command.

```
rtrv-scr-cgpa:sr=gw14
```

The following is an example of the possible output.

```
E2573 Cmd Rej: SR or NSR does not reference an existing SR
```

This message shows that the specified screening reference name is not in the database and the action of the **dlt-scr-cgpa** command in step 3 was successful. If the specified screening reference name contained more than one entry when the **dlt-scr-cgpa** command was executed in step 3, the **rtrv-scr-cgpa:sr=** command output would show the remaining entries in the screening reference instead of error message E2573.

---

5. Backup the new changes using the **chg-db:action=backup:dest=fixed** command. The following messages should appear, the active Maintenance and Administration Subsystem Processor (MASP) appears first.

```
BACKUP (FIXED) : MASP A - Backup starts on active MASP.  
BACKUP (FIXED) : MASP A - Backup on active MASP to fixed disk complete.  
BACKUP (FIXED) : MASP A - Backup starts on standby MASP.  
BACKUP (FIXED) : MASP A - Backup on standby MASP to fixed disk complete.
```

---



## Allowed Calling Party (CGPA) Screen Configuration

**Flowchart 6-3.** Removing an Allowed Calling Party Address Screen (Sheet 1 of 2)

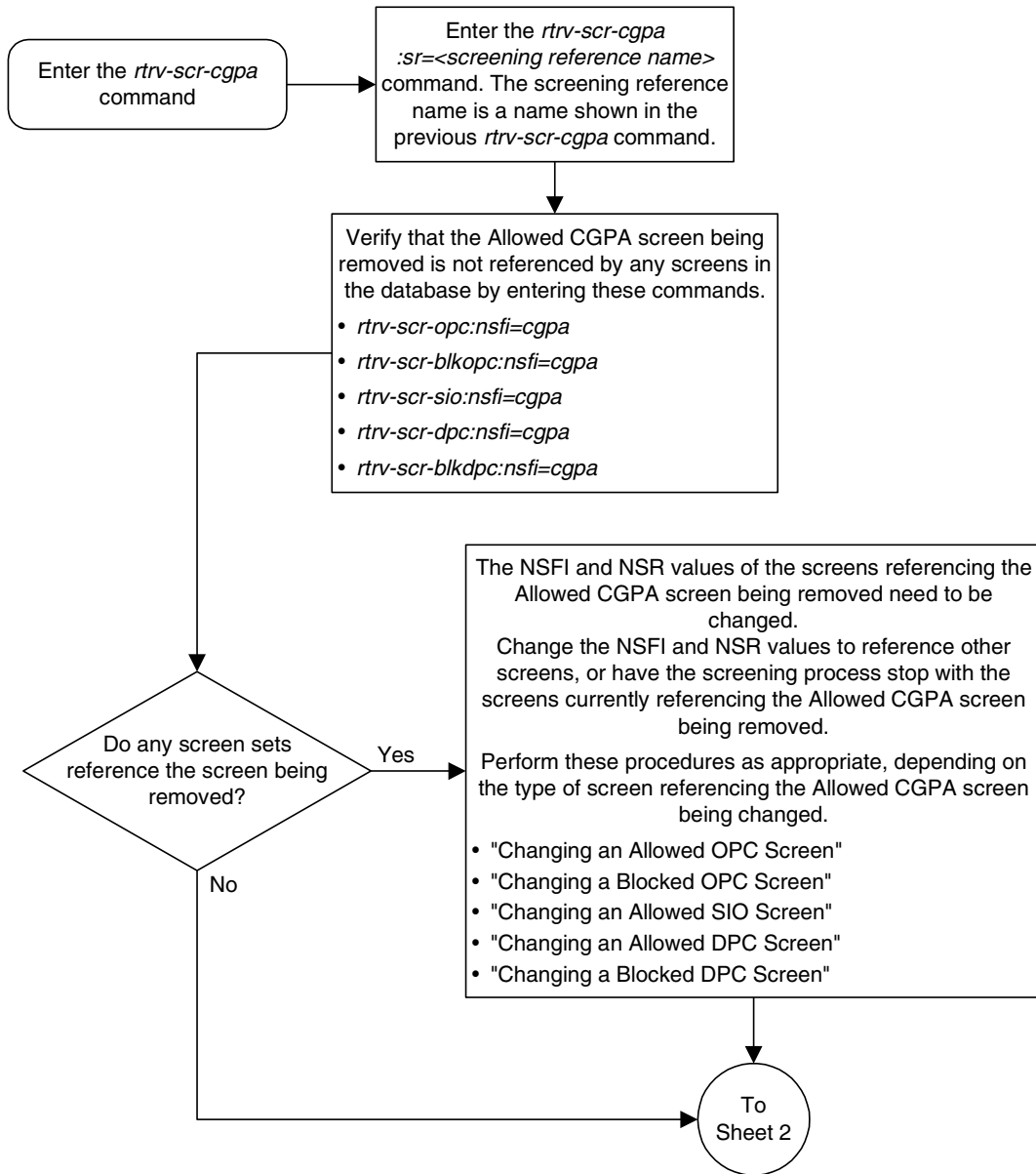

Flowchart 6-3. Removing an Allowed Calling Party Address Screen (Sheet 2 of 2)

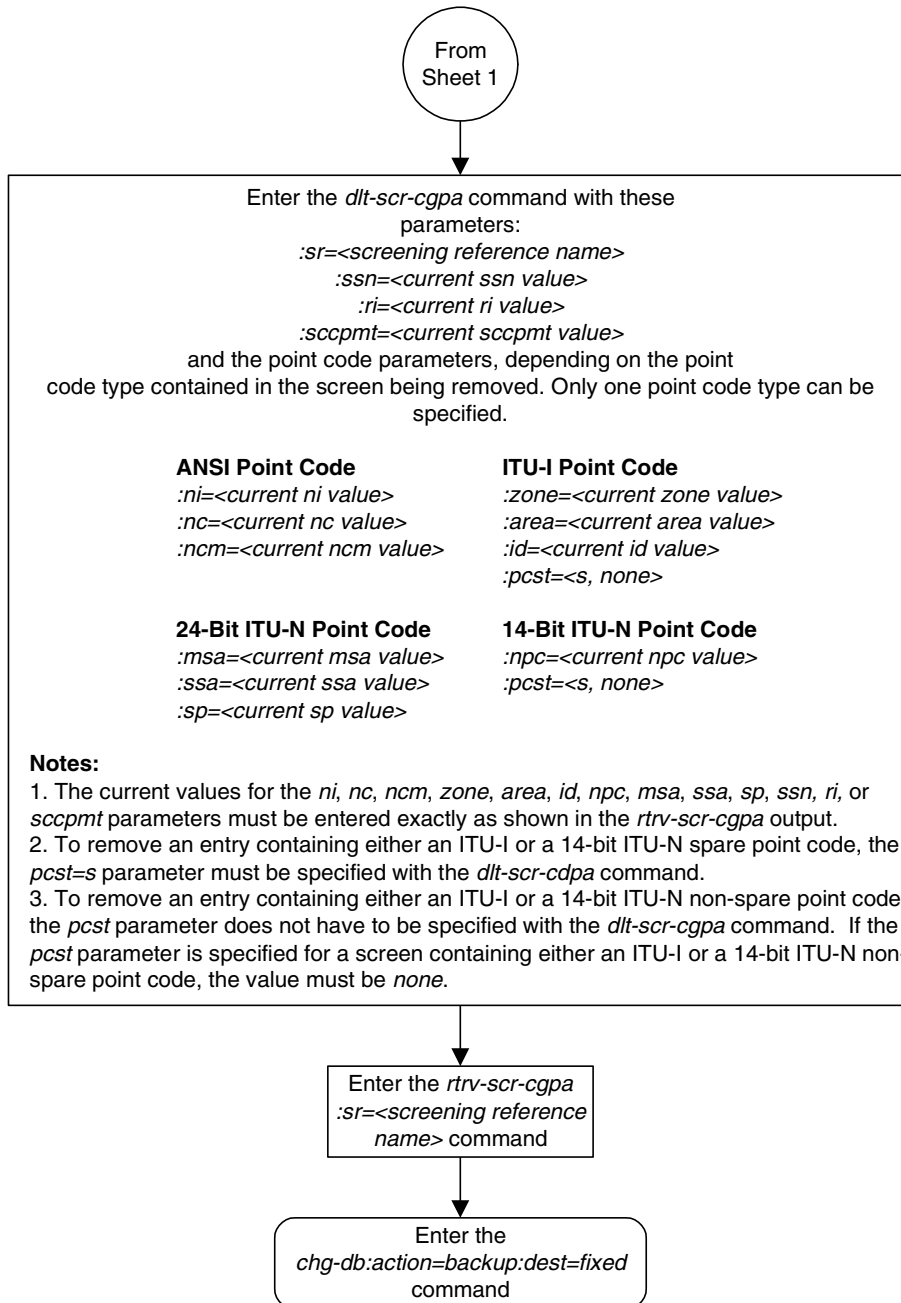

## Changing an Allowed Calling Party Address Screen

This procedure is used to change the attributes of an allowed calling party address (CGPA) screen in the database using the `chg-scr-cgpa` command. The parameters used by the `chg-scr-cgpa` command are shown in the “Gateway Screening Attributes” section on page 2-7. The general rules that apply to configuring gateway screening entities are shown in the “Gateway Screening Configuration” section on page 2-28.

The example in this procedure is used to change the point code 003-003-003 for the allowed CGPA screen `gw14` to 230-230-230 and change the subsystem number from 253 to 150.

**NOTE:** If you using multiple-part ITU national point codes with gateway screening, see “14-Bit ITU National Point Code Formats” on page 2-24.

The allowed CGPA screen can reference one of the following screens.

- Allowed TT
- Allowed CDPA

Enter the following commands to verify that these screens are in the database.

- `rtrv-scr-tt:all=yes`
- `rtrv-scr-cdpa:all=yes`

If the desired screen is not in the database, go to one of the following procedures and add the desired screen to the database or change an existing screen in the database.

- “Adding an Allowed Translation Type Screen” procedure on page 5-4
- “Adding an Allowed Called Party Address Screen” procedure on page 4-5
- “Changing an Allowed Translation Type Screen” procedure on page 5-14
- “Changing an Allowed Called Party Address Screen” procedure on page 4-22

### Specifying a Range of Values

A range of values can be specified for the point code parameters `ni`, `nc`, or `ncm`.

If a range of values is specified for any of these parameters, and the value of the other parameters match existing values for the screening reference name, the range of values for the point code parameter cannot include any values for that parameter that are currently provisioned for the screening reference name.

For example, screening reference name `scr1` contains these entries:

SR	NI	NC	NCM	SSN	RI	SCCPMT	NSFI	NSR/ACT
SCR1	240	001	010	012	DPC	009	STOP	-----
SCR1	241	010	020	*	GT	017	TT	SCR1

Another entry for screening reference **scr1** with the **ni** value of 240 and the **nc** value of 001 cannot be specified if the range of values for the **ncm** parameter includes the value 010.

The ANSI point code parameter values can be specified as a single value, a range of values, or with an asterisk (\*). The asterisk specifies all possible values for the **ni**, **nc**, and **ncm** parameters. Table 6-6 shows the valid combinations of these parameter values.

**Table 6-6.** Valid Value Combinations for ANSI Point Code Parameters

NI	NC	NCM
Single Value	Single Value	Single Value
Single Value	Single Value	Range of Values
Single Value	Single Value	Asterisk
Single Value	Range of Values	Asterisk
Single Value	Asterisk	Asterisk
Range of Values	Asterisk	Asterisk
Asterisk	Asterisk	Asterisk

A range of values can also be specified for an ITU-I or 24-bit ITU-N point code parameter using a combination of asterisks (\*) and single values for the point code parameters. Table 6-7 shows the valid combinations of the ITU-I parameter values. Table 6-8 shows the valid combinations of the 24-bit ITU-N parameter values.

**Table 6-7.** Valid Value Combinations for ITU-I Point Code Parameters

ZONE	AREA	ID
Single Value	Single Value	Single Value
Single Value	Single Value	Asterisk
Single Value	Asterisk	Asterisk
Asterisk	Asterisk	Asterisk

## Allowed Calling Party (CGPA) Screen Configuration

**Table 6-8.** Valid Value Combinations for 24-Bit ITU-N Point Code Parameters

MSA	SSA	SP
Single Value	Single Value	Single Value
Single Value	Single Value	Asterisk
Single Value	Asterisk	Asterisk
Asterisk	Asterisk	Asterisk

### Procedure

---

1. Display the allowed CGPA screens in the database using the `rtrv-scr-cgpa` command. The following is an example of the possible output.

```
rlghncxa03w 05-09-25 15:25:30 GMT EAGLE5 34.0.0
SCREEN = ALLOWED CGPA
SR   REF  RULES
GW11 YES   1
GW13 YES   1
GW14 YES   1
IEC  YES   2
WRD2 YES   1
WRD4 YES   9
```

From the `rtrv-scr-cgpa` output, display the allowed CGPA screen you wish to change using the `rtrv-scr-cgpa` command with the screening reference name.

For this example, enter this command.

```
rtrv-scr-cgpa:sr=gw14
```

The following is an example of the possible output.

```
rlghncxa03w 05-09-25 15:25:30 GMT EAGLE5 34.0.0
SCREEN = ALLOWED CGPA
SR   NI      NC      NCM      SSN      RI      SCCPMT  NSFI      NSR/ACT
GW14 003      003      003      253      GT      009      TT        GW17
```

If a gateway screening stop action set is to be assigned to the allowed CGPA screen being added to the database, go to step 2.

Step 2 verifies the gateway screening stop action set names in the database. The gateway screening stop action set names are assigned only if the NSFI of the screen being changed in this procedure is STOP. If the NSFI of the screen will be changed to STOP, but a gateway screening stop action set name will not be assigned to the screen, skip steps 2 and 3 and go to step 4. If the NSFI of the screen will not be STOP, skip step 2 and go to step 3.

---

2. Display the gateway screening stop action sets in the database with the `rtrv-gws-actset` command. This is an example of the possible output.

```
rlghncxa03w 05-09-25 15:26:30 GMT EAGLE5 34.0.0
ACT ACT ACT ACT ACT ACT ACT ACT ACT ACT ACT
ID NAME 1 2 3 4 5 6 7 8 9 10
-----
1 copy copy
2 rdct rdct
3 cr copy rdct
4 cncf cncf
5 cpncf copy cncf
6 cncfrd cncf rdct
7 cpcf rd copy cncf rdct
```

GWS action set table is (7 of 16) 44% full

If the required gateway screening stop action set is not in the database, go to the “Configuring Gateway Screening Stop Action Sets” procedure on page 2-54 and configure the required gateway screening stop action set.

**NOTE:** If the NSFI of the screen being changed in this procedure will be **STOP**, or if the NSFI of the screen is not being changed, skip step 3 and go to step 4.

3. Enter the commands on page 6-23 to verify that the screen that will be specified by the NSFI/NSR parameter combination in step 5 is in the database.

If the desired screen is not in the database, go to one of the procedures shown on page 6-23 and either add the desired screen to the database or change an existing screen in the database.

**NOTE:** If any of these conditions apply to this procedure, skip this step and go to step 5:

- The point code in the screen is not being changed.
- The screen being changed contains either an ANSI or 24-bit ITU-N point code.
- The ITU-I or 14-bit ITU-N non-spare point code in the screen is not being changed to an ITU-I or 14-bit ITU-N spare point code.
- The point code in the screen is an ITU-I or 14-bit ITU-N spare point code or the screening reference contains other screens with ITU-I or 14-bit ITU-N spare point codes.

4. Display the status of the ITU National and International Spare Point Code Support feature by entering the `rtrv-ctrl-feat` command with the ITU National and International Spare Point Code Support feature part number. Enter this command.

```
rtrv-ctrl-feat:partnum=893013601
```

## Allowed Calling Party (CGPA) Screen Configuration

This is an example of the possible output.

```
rlghncxa03w 05-09-25 15:25:30 GMT EAGLE5 34.0.0
The following features have been permanently enabled:
```

Feature Name	Partnum	Status	Quantity
Spare Point Code Support	893013601	on	----

The following features have been temporarily enabled:

Feature Name	Partnum	Status	Quantity	Trial Period Left
Zero entries found.				

The following features have expired temporary keys:

Feature Name	Partnum
Zero entries found.	

If the ITU National and International Spare Point Code Support feature is enabled, go to step 5.

If the ITU National and International Spare Point Code Support feature is not enabled, perform the “Activating the ITU National and International Spare Point Code Support Feature” procedure in the *Database Administration Manual - SS7* to enable the ITU National and International Spare Point Code Support feature as required. After the feature has been enabled, go to step 5.

- 
5. Change the attributes of an allowed CGPA screen using the `chg-scr-cgpa` command.

If a gateway screening stop action is to be assigned to the allowed CGPA screen being changed, enter the `chg-scr-cgpa` command with the `nsfi=stop` parameter and the `actname` parameter with the name of a gateway screening stop action set shown in the output of the `rtrv-gws-actset` command executed in step 2.



**CAUTION:** The EAGLE 5 SAS does not support redirecting MSUs for the DTA feature or intercepting ISUP IAM messages for the Calling Name Conversion Facility feature from the allowed CGPA screen. Gateway screening stop action sets containing either the RDCT (redirect) or CNCF (calling name conversion facility) stop actions should not be assigned to the allowed CGPA screen. If a gateway screening stop action set containing the RDCT or CNCF stop actions is specified with the `chg-scr-cgpa` command, unsolicited information message (UIM) 1126 is generated when the attempt is made to redirect MSUs from the allowed CGPA screen. Unsolicited information message (UIM) 1216 is generated when ISUP IAM MSUs are intercepted from the allowed CGPA screen. For more information on UIMs 1126 and 1216, go to the *Maintenance Manual*.

The current values for the `ni`, `nc`, `ncm`, `zone`, `area`, `id`, `npc`, `msa`, `ssa`, `sp`, `ssn`, `ri`, and `sccpmt` parameters must be entered exactly as shown in the `rtrv-scr-cgpa` output in step 1.

## Allowed Calling Party (CGPA) Screen Configuration

The following list contains the values for **nni**, **nnc**, **nncm**, **nzone**, **narea**, **nid**, **nnpc**, **nssn**, **nmsa**, **nssa**, **nsp**, **nri**, and **nsccpmt** parameters:

- **nni** – 0 - 255 or an asterisk (\*)
- **nnc** – 0 - 255 or an asterisk (\*)
- **nncm** – 0 - 255 or an asterisk (\*)
- **nzone** – 0 - 7 or an asterisk (\*)
- **narea** – 0 - 255 or an asterisk (\*)
- **nid** – 0 - 7 or an asterisk (\*)
- **nnpc** – 1 - 16383 or an asterisk (\*)
- **nmsa** – 0 - 255 or an asterisk (\*)
- **nssa** – 0 - 255 or an asterisk (\*)
- **nsp** – 0 - 255 or an asterisk (\*)
- **nssn** – 0 - 255 or an asterisk (\*)
- **nri** – gt, dpc or an asterisk (\*)
- **nsccpmt** – 9, 10, 17, 18 or an asterisk (\*)

**NOTE:** The **nri**, **nsfi**, and **nsr** parameters can be specified only as shown in Table 6-9.

**Table 6-9.** CGPA Parameter Combinations

New or Current RI Value	NSFI	NSR
GT	TT, STOP	Must be specified if NSFI=TT
DPC	CDPA, STOP	Must be specified if NSFI=CDPA
*	TT, CDPA, STOP	Must be specified if NSFI=TT or NSFI=CDPA

A range of values can be specified for the **nni**, **nnc**, and **nncm** parameters. See the “Specifying a Range of Values” section on page 6-23 for more information on how the asterisk and a range of values are used for the **nni**, **nnc**, and **nncm** parameters.

To change an ITU-I or 14-bit ITU-N spare point code to a non-spare point code, both the **pcst=s** and **npcst=none** parameters must be specified with the **chg-scr-cgpa** command.

To change an ITU-I or 14-bit ITU-N non-spare point code to a spare point code, the **npcst=s** parameter must be specified with the **chg-scr-cgpa** command. The **pcst** parameter does not have to be specified.



## Allowed Calling Party (CGPA) Screen Configuration

If the current point code in the screen being changed is either an ITU-I or 14-bit ITU-N spare point code, the **pcst=s** parameter must be specified with the **chg-scr-cgpa** command.

If the current point code in the screen being changed is either an ITU-I or 14-bit ITU-N non-spare point code, the **pcst** parameter does not have to be specified with the **chg-scr-cgpa** command. If the **pcst** parameter is specified for a screen containing either an ITU-I or 14-bit ITU-N non-spare point code, the **pcst** parameter value must be **none**.

For this example, enter this command.

```
chg-scr-cgpa:sr=gw14:ni=003:nc=003:ncm=003:ssn=253:sccpmt=009  
:nni=230:nnc=230:nncm=230:nssn=150
```

A message similar to the following should appear.

```
rlghncxa03w 05-09-25 15:27:30 GMT EAGLE5 34.0.0  
CHG-SCR-CGPA: SCREEN SET AFFECTED - GW14 1% FULL  
CHG-SCR-CGPA: MASP A - COMPLTD
```

---

6. Verify the changes using the **rtrv-scr-cgpa** command with the screening reference name used in step 5. For this example, enter this command.

```
rtrv-scr-cgpa:sr=gw14
```

The following is an example of the possible output.

```
rlghncxa03w 05-09-25 15:28:30 GMT EAGLE5 34.0.0  
SCREEN = ALLOWED CGPA  
SR   NI      NC      NCM      SSN      RI   SCCPMT  NSFI   NSR/ACT  
GW14 230      230      230      150      GT   009     TT     GW17
```

---

7. Backup the new changes using the **chg-db:action=backup:dest=fixed** command. The following messages should appear, the active Maintenance and Administration Subsystem Processor (MASP) appears first.

```
BACKUP (FIXED) : MASP A - Backup starts on active MASP.  
BACKUP (FIXED) : MASP A - Backup on active MASP to fixed disk complete.  
BACKUP (FIXED) : MASP A - Backup starts on standby MASP.  
BACKUP (FIXED) : MASP A - Backup on standby MASP to fixed disk complete.
```

---

**Flowchart 6-4.** Changing an Allowed Calling Party Address Screen (Sheet 1 of 5)

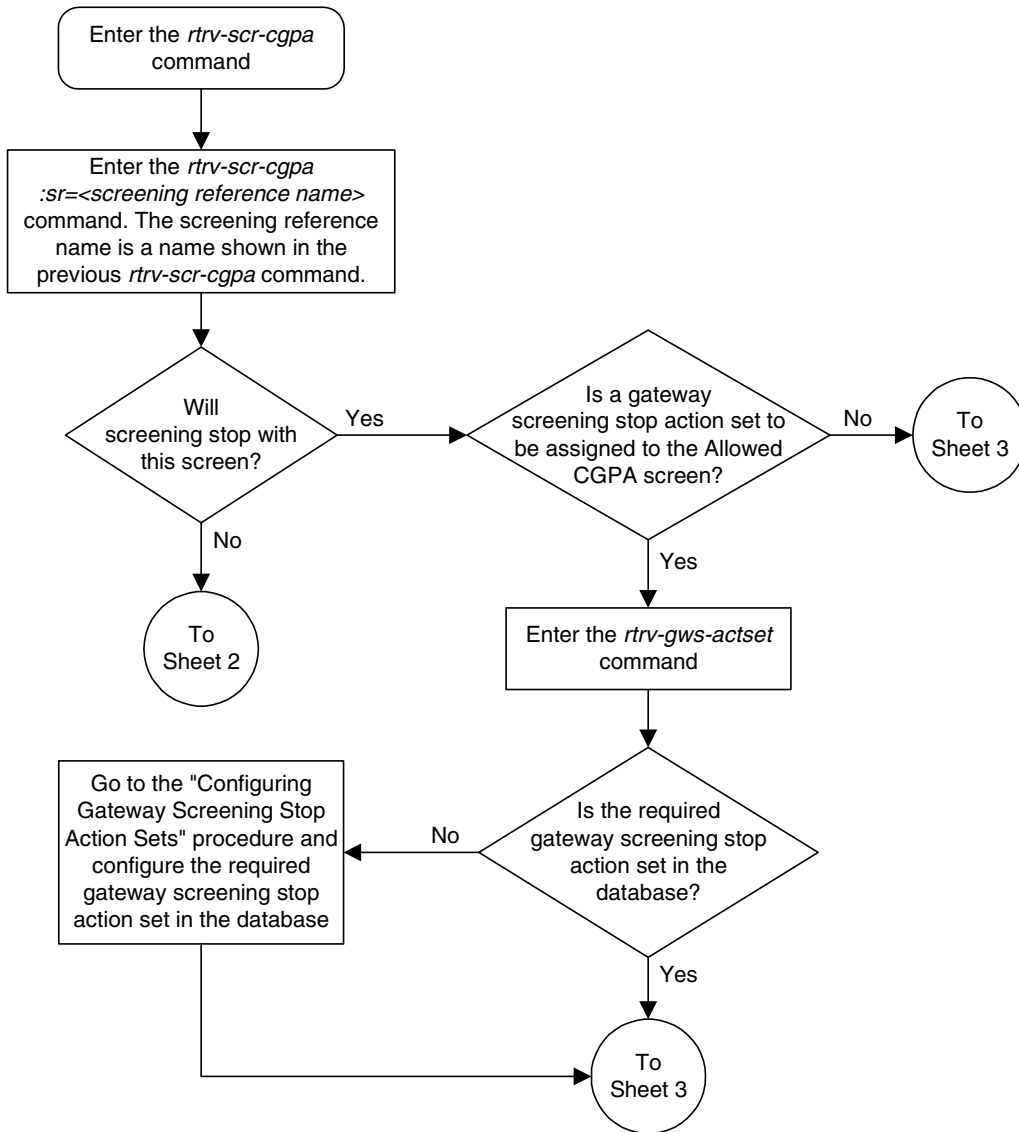

# Allowed Calling Party (CGPA) Screen Configuration

**Flowchart 6-4.** Changing an Allowed Calling Party Address Screen (Sheet 2 of 5)

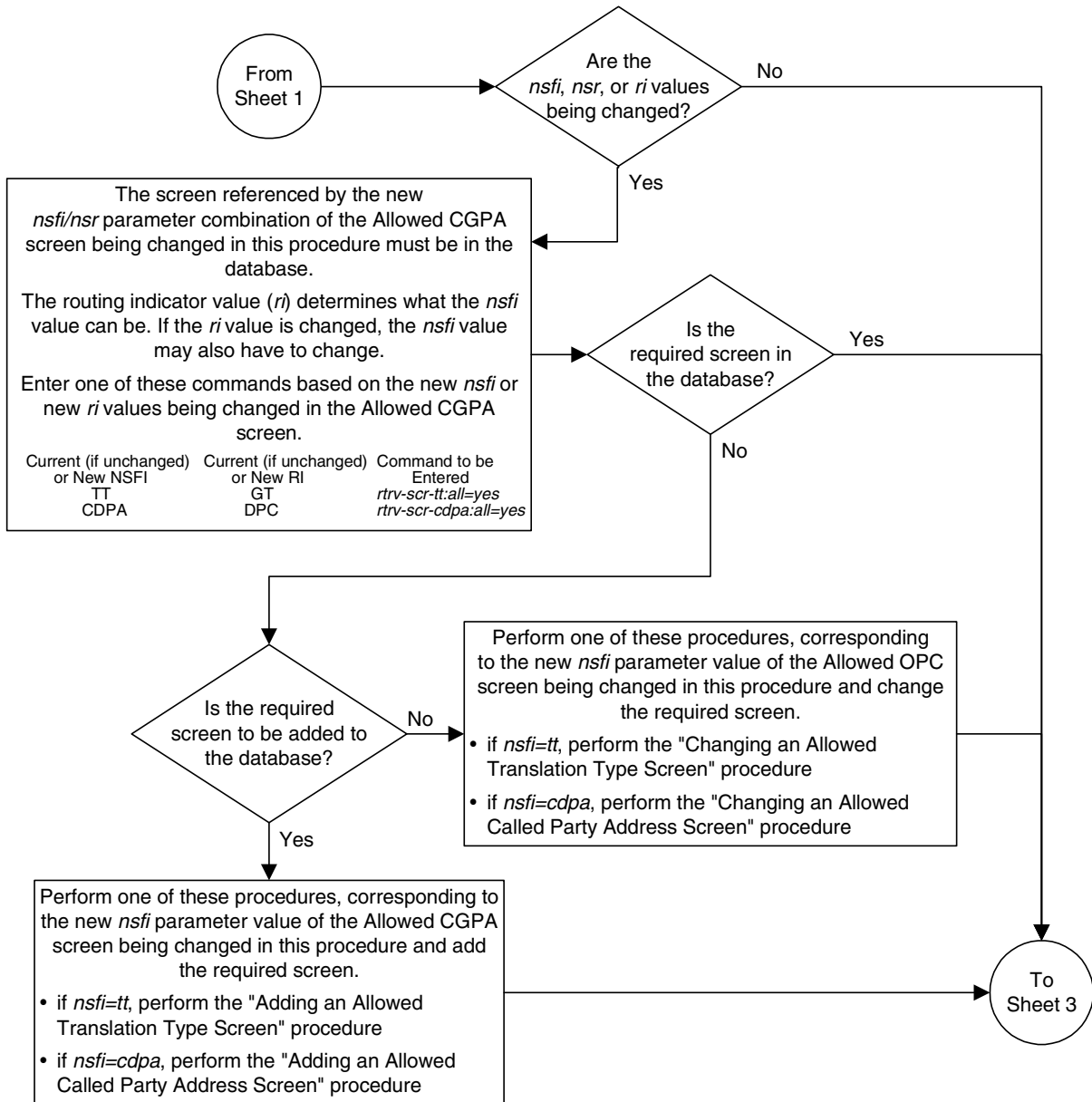

Flowchart 6-4. Changing an Allowed Calling Party Address Screen (Sheet 3 of 5)

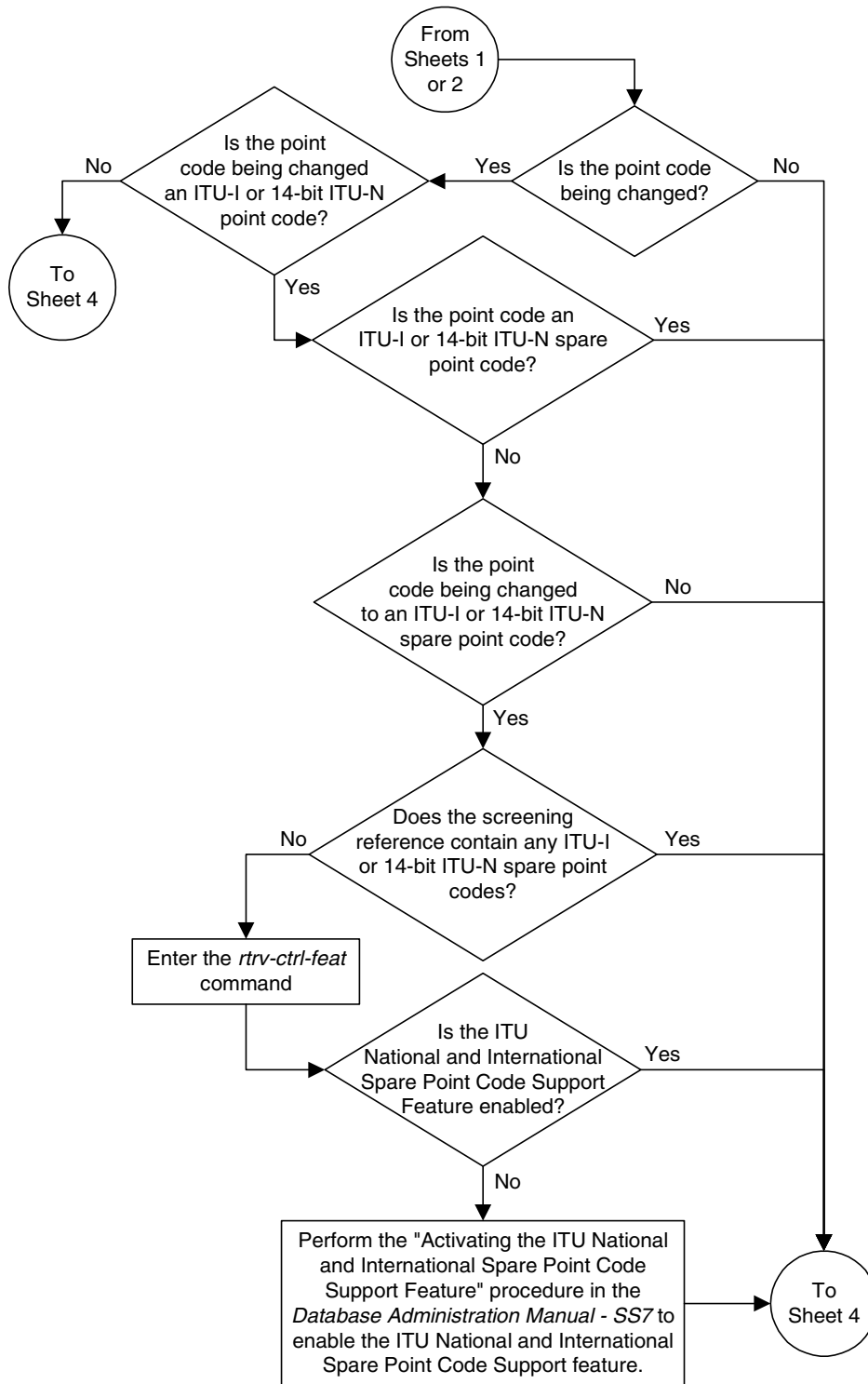

## Allowed Calling Party (CGPA) Screen Configuration

**Flowchart 6-4.** Changing an Allowed Calling Party Address Screen (Sheet 4 of 5)

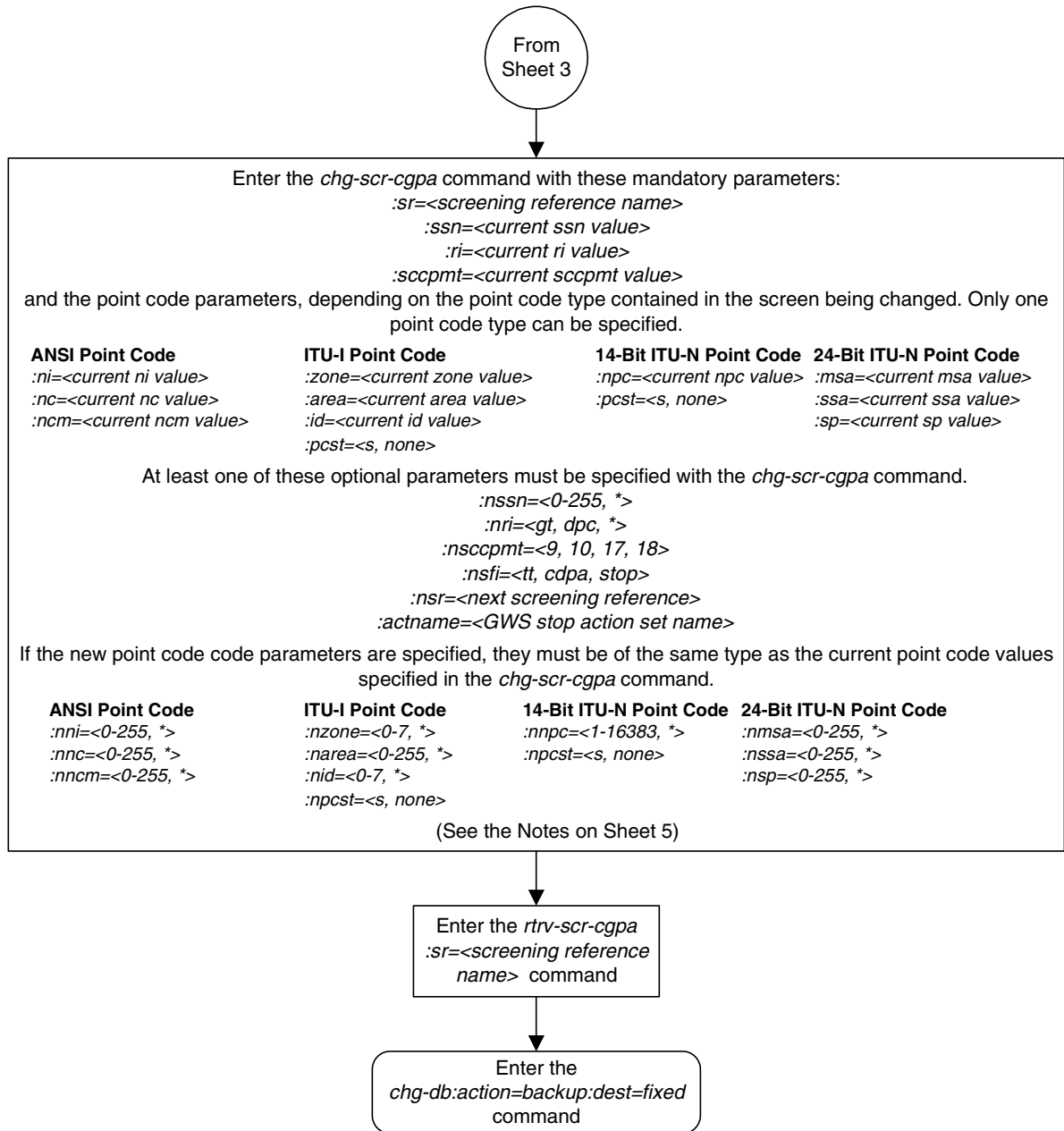

### Flowchart 6-4. Changing an Allowed Calling Party Address Screen (Sheet 5 of 5)

**Notes:**

1. A range of values can be specified for the *nni*, *nnc*, or *nncm* parameters by inserting double ampersands (&&) between the parameter values defining the range. For example, to specify the range 025 to 200 for the *nni* parameter, enter 025&&200 for the *nni* parameter value.
2. The asterisk (\*) specifies the entire range of values for that parameter.  
For more information about specifying a range of values and about using the asterisk, see the "Gateway Screening Attributes" section in Chapter 2 and the "Specifying a Range of Values" section in this procedure.
3. If either the *nsfi=<tt or cdpa>* or *nsr* parameters are specified, the other parameter must be specified.
4. If the *nsfi=stop* parameter is specified, or if the current *nsfi* value is stop and is not being changed, the *nsr* parameter cannot be specified.
5. The *actname* parameter can be specified only when the *nsfi* value is stop (either the current *nsfi* value is stop and not being changed, or if the *nsfi* value is being changed to stop). The *actname* parameter is optional. If the *actname* parameter is specified, the *actname* parameter value is one of the gateway screening stop action set names shown in the *rtrv-gws-actset* output on Sheet 1.
6. The *nri=gt* parameter can be specified only if the *nsfi* value is TT. If the *nsfi=tt* parameter is specified, the *ri* value must be GT or \*.
7. The *nri=dpc* parameter can be specified only if the *nsfi* value is CDPA. If the *nsfi=cdpa* parameter is specified, the *ri* value must be DPC or \*.
8. The current values for the *ni*, *nc*, *nncm*, *zone*, *area*, *id*, *npc*, *ssn*, *ri*, and *sccpmt* parameters must be entered exactly as shown in the *rtrv-scr-cgpa* output.
9. To change an ITU-I or 14-bit ITU-N spare point code to a non-spare point code, both the *pcst=s* and *npcst=none* parameters must be specified with the *chg-scr-cgpa* command.
10. To change an ITU-I or 14-bit ITU-N non-spare point code to a spare point code, the *npcst=s* parameter must be specified with the *chg-scr-cgpa* command. The *pcst* parameter does not have to be specified.
11. If the current point code in the screen being changed is either an ITU-I or 14-bit ITU-N spare point code, the *pcst=s* parameter must be specified with the *chg-scr-cgpa* command.
12. If the current point code in the screen being changed is either an ITU-I or 14-bit ITU-N non-spare point code, the *pcst* parameter does not have to be specified with the *chg-scr-cgpa* command. If the *pcst* parameter is specified for a screen containing either an ITU-I or 14-bit ITU-N non-spare point code, the *pcst* parameter value must be none.

## Allowed Affected Destination Field (DESTFLD) Screen Configuration

Introduction.....	7-2
Adding an Allowed Affected Destination Field Screen.....	7-7
Removing an Allowed Affected Destination Field Screen .....	7-16
Changing an Allowed Affected Destination Field Screen .....	7-21

## Introduction

The Affected Destination Field screen identifies the point code in the affected destination field, the concerned signaling point code of incoming MTP network management messages from another network that are allowed into the EAGLE 5 SAS. The gray shaded areas in Figure 7-1 shows the fields of the SS7 message that are checked by the Affected Destination Field screening function.

Network management messages contain the entry 0 in the service indicator field of the SIO. This is the last screen in the MTP portion of the gateway screening process. This `nsfi` for this screen has only one value, `stop`.

**NOTE: Screening of the affected destination field can also be performed without configuring an allowed affected destination field screen by specifying the `destfld=yes` parameter when configuring a screen set. For more information on the screen set `destfld=yes` parameter, see the “Automatic Destination Field Screening” section on page 13-2.**

If no match is found, the MTP network management message is not allowed into the EAGLE 5 SAS. If a match is found, the message is allowed into the EAGLE 5 SAS for further processing.

If the `copy` gateway screening stop action is specified, the message is processed and a copy of the message is sent by the STP LAN feature to an external application through an ACM running the `stp1an` application or a DCM running the `vxws1an` application.

If the `rdct` (redirect) gateway screening stop action is specified, the message is diverted from the original destination and sent to another destination with the Database Transport Access feature, specified by global title translation, for further processing.

If the Calling Name Conversion Facility (CNCF) feature is on and the `cncf` gateway screening stop action is specified, the PIP parameter in the incoming ISUP IAM message is converted to the GN parameter. The GN parameter in the incoming ISUP IAM message is converted to the PIP parameter. The message is then sent to the node specified by the DPC in the routing label in the message. For more information on the Calling Name Conversion Facility feature, see Chapter 14, “Calling Name Conversion Facility (CNCF) Configuration.”

These network management messages are screened by the Allowed Affected Destination Field: TFP, TFA, TFR, TFC, UPU, and SRST (RSP, RSR). Any MSU that is not one of these network management message types, or does not contain a service indicator of 0 in the SIO field and reaches this screen in the gateway screening process automatically passes gateway screening and is allowed into the EAGLE 5 SAS.

Flowchart 7-1 shows the screening action of the allowed affected destination field screen.



Allowed Affected Destination Field (DESTFLD) Screen Configuration

Flowchart 7-1. Allowed Affected Destination Screening Action (Sheet 1 of 3)

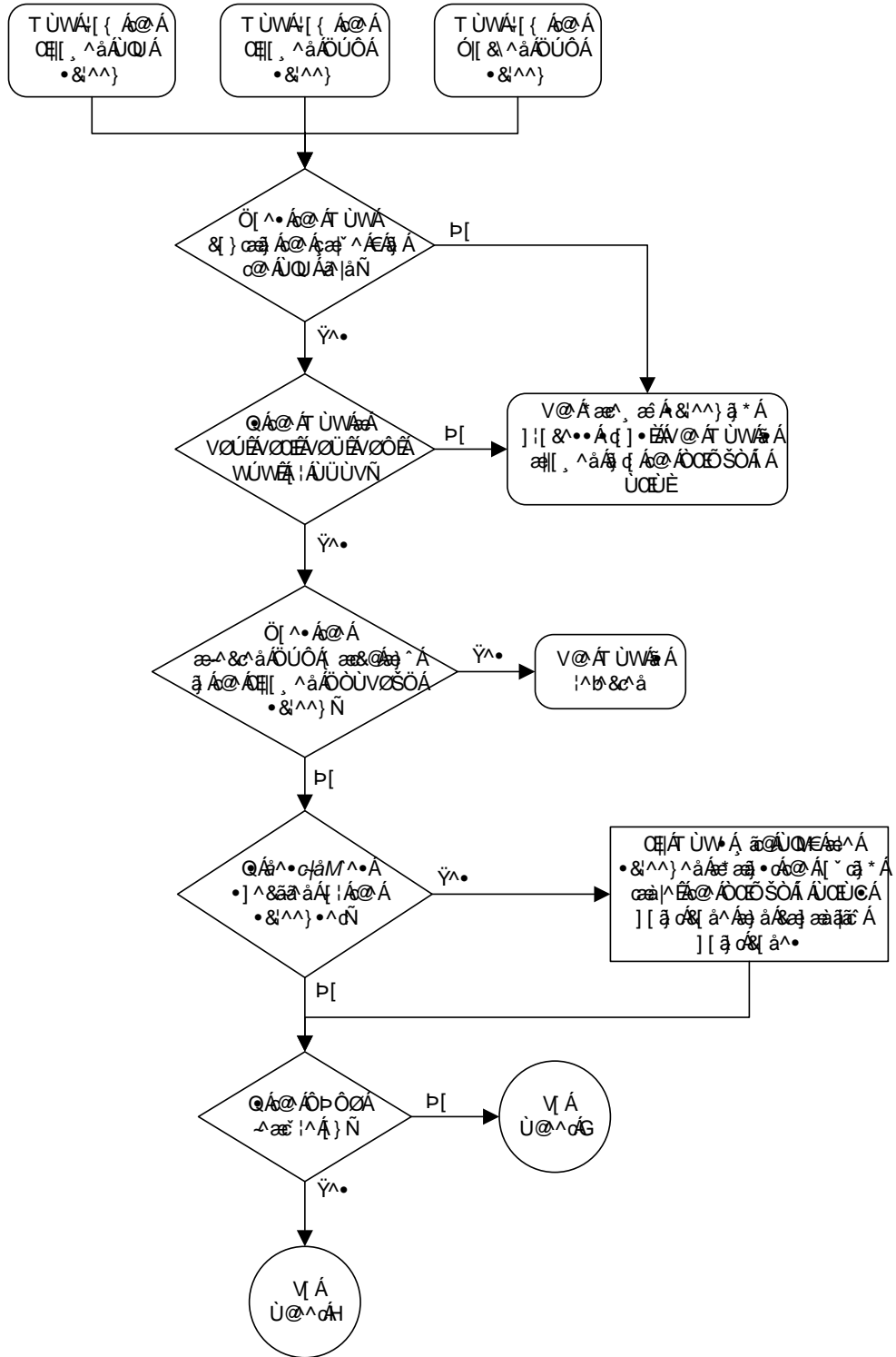

Allowed Affected Destination Field (DESTFLD) Screen Configuration

Flowchart 7-1. Allowed Affected Destination Screening Action (Sheet 2 of 3)

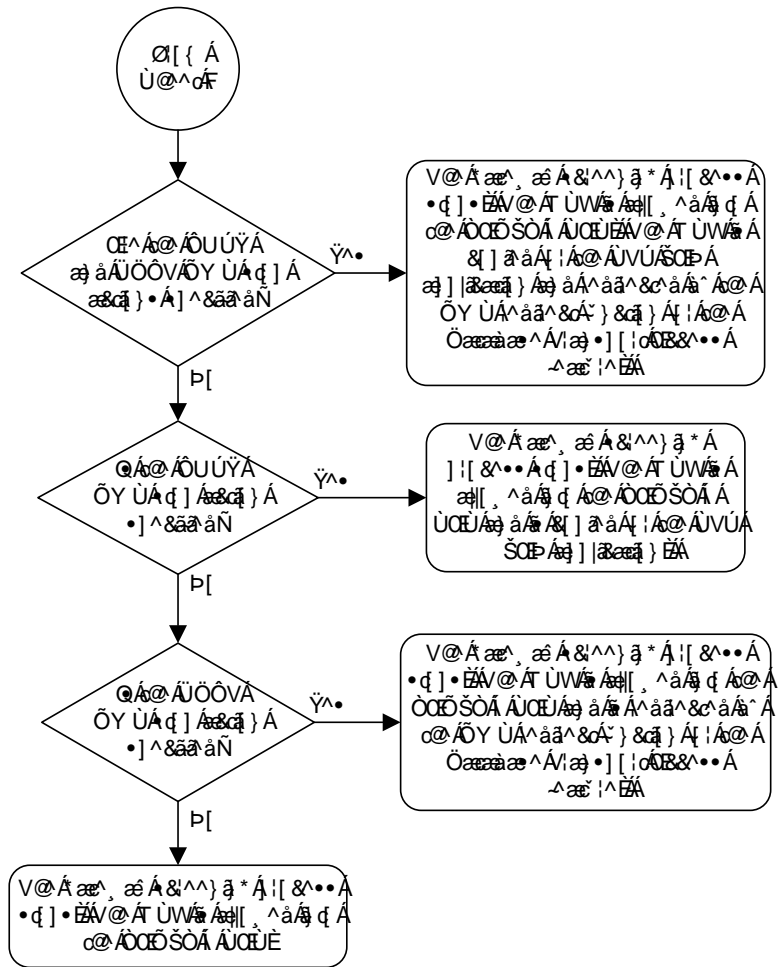



## Allowed Affected Destination Field (DESTFLD) Screen Configuration

**Figure 7-1.** Allowed Affected Destination Field Screening Function

**ANSI MSU (ANSI Message Signal Unit)**

BSN FSN LI	SIO xx xx xxxx NIC PRI SI	SIF			
		DPC NCM NC NI	Routing Label OPC NCM NC NI	SLS xx	H1 H0

**ITU-I MSU (ITU International Message Signal Unit)**

BSN FSN LI	SIO xx xx xxxx NIC PRI SI	SIF			
		DPC ID AREA ZONE ID	Routing Label OPC AREA ZONE	SLS xx	H1 H0

**14-Bit ITU-N MSU (14-Bit ITU National Message Signal Unit)**

BSN FSN LI	SIO xx xx xxxx NIC PRI SI	SIF			
		DPC NPC	Routing Label OPC NPC	SLS xx	H1 H0

**24-Bit ITU-N MSU (24-Bit ITU National Message Signal Unit)**

BSN FSN LI	SIO xx xx xxxx NIC PRI SI	SIF			
		DPC SP SSA MSA	Routing Label OPC SP SSA MSA	SLS xx	H1 H0

## Adding an Allowed Affected Destination Field Screen

This procedure is used to add an allowed affected destination field (DESTFLD) screen to the database using the `ent-scr-destfld` command. The parameters used by the `ent-scr-destfld` command are shown in the “Gateway Screening Attributes” section on page 2-7. The general rules that apply to configuring gateway screening entities are shown in the “Gateway Screening Configuration” section on page 2-28.

The examples in this procedure are used to add the allowed DESTFLD screen data shown in Table 7-1 and based on the example configuration shown in Figure 2-7 on page 2-41.

**Table 7-1.** Example Gateway Screening Allowed DESTFLD Configuration Table

Screening Reference	NI	NC	NCM	NSFI	ACTNAME
fld5	100	100	100	stop	CR

**NOTE:** If you using multiple-part ITU national point codes with gateway screening, see “14-Bit ITU National Point Code Formats” on page 2-24.

### Specifying a Range of Values

A range of values can be specified for the point code parameters `ni`, `nc`, or `ncm`.

If a range of values is specified for any of these parameters, and the value of the other parameters match existing values for the screening reference name, the range of values for the point code parameter cannot include any values for that parameter that are currently provisioned for the screening reference name.

For example, screening reference name `scr1` contains these entries:

SR	NI	NC	NCM	NSFI	NSR/ACT
SCR1	240	001	010	STOP	-----
SCR1	241	010	020	STOP	-----

Another entry for screening reference `scr1` with the `ni` value of 240 and the `nc` value of 001 cannot be specified if the range of values for the `ncm` parameter includes the value 010.

The ANSI point code parameter values can be specified as a single value, a range of values, or with an asterisk (\*). The asterisk specifies all possible values for the `ni`, `nc`, and `ncm` parameters. Table 7-2 shows the valid combinations of these parameter values.

**Table 7-2.** Valid Value Combinations for ANSI Point Code Parameters

NI	NC	NCM
Single Value	Single Value	Single Value
Single Value	Single Value	Range of Values
Single Value	Single Value	Asterisk
Single Value	Range of Values	Asterisk
Single Value	Asterisk	Asterisk
Range of Values	Asterisk	Asterisk
Asterisk	Asterisk	Asterisk

A range of values can also be specified for an ITU-I or 24-bit ITU-N point code parameter using a combination of asterisks (\*) and single values for the point code parameters. Table 7-3 shows the valid combinations of the ITU-I parameter values. Table 7-4 shows the valid combinations of the 24-bit ITU-N parameter values.

**Table 7-3.** Valid Value Combinations for ITU-I Point Code Parameters

ZONE	AREA	ID
Single Value	Single Value	Single Value
Single Value	Single Value	Asterisk
Single Value	Asterisk	Asterisk
Asterisk	Asterisk	Asterisk

**Table 7-4.** Valid Value Combinations for 24-Bit ITU-N Point Code Parameters

MSA	SSA	SP
Single Value	Single Value	Single Value
Single Value	Single Value	Asterisk
Single Value	Asterisk	Asterisk
Asterisk	Asterisk	Asterisk

### Procedure

---

1. Verify that the gateway screening feature is on, by entering the **rtrv-feat** command. If the gateway screening feature is on, the **GWS** field is set to **on**.

**NOTE:** The **rtrv-feat** command output contains other fields that are not used by this procedure. If you wish to see all the fields displayed by the **rtrv-feat** command, see the **rtrv-feat** command description in the *Commands Manual*.

If the gateway screening feature is on, shown by the entry **GWS = on** in the **rtrv-feat** command output, skip step 2, and go to step 3.

---

2. Turn the gateway screening feature on by entering this command.

```
chg-feat:gws=on
```

**NOTE:** Once the gateway screening feature is turned on with the **chg-feat** command, it cannot be turned off.

The gateway screening feature must be purchased before you turn this feature on with the **chg-feat** command. If you are not sure if you have purchased the gateway screening feature, contact your Tekelec Sales Representative or Account Representative.

When the **chg-feat** has successfully completed, this message should appear.

```
rlghncxa03w 05-09-28 11:43:04 GMT EAGLE5 34.0.0  
CHG-FEAT: MASP A - COMPLTD
```

---

3. Display all allowed DESTFLD screens in the database using the **rtrv-scr-destfld** command. The following is an example of the possible output.

```
rlghncxa03w 05-09-25 15:25:30 GMT EAGLE5 34.0.0  
SCREEN = ALLOWED DESTFLD  
SR   REF  RULES  
IEC  YES   2  
WRD2 YES   1  
WRD4 YES   9
```

If the screening reference names that you wish to add with this procedure are not shown in the **rtrv-scr-destfld** command output, go to step 4. For this example, the screening reference names are not shown. If these screening reference names are shown in the **rtrv-scr-destfld** command output, make sure the screening data you wish to enter is not already in the database by entering the **rtrv-scr-destfld** command with the screening reference name. For example, enter the **rtrv-scr-destfld:sr=iec** command.

## Allowed Affected Destination Field (DESTFLD) Screen Configuration

The following is an example of the possible output.

```
rlghncxa03w 05-09-25 15:26:30 GMT EAGLE5 34.0.0
SCREEN = ALLOWED DESTFLD
SR   NI       NC       NCM       NSF1     NSR/ACT
IEC  240      001      010      STOP     -----
IEC  241      010      *        STOP     COPY
```

If a gateway screening stop action set is to be assigned to the allowed DESTFLD screen being added to the database, go to step 4. Otherwise, go to step 5.

- 
4. Display the gateway screening stop action sets in the database with the **rtrv-gws-actset** command. This is an example of the possible output.

```
rlghncxa03w 05-09-25 15:28:30 GMT EAGLE5 34.0.0
ACT  ACT  ACT  ACT  ACT  ACT  ACT  ACT  ACT  ACT  ACT  ACT
ID   NAME  1    2    3    4    5    6    7    8    9    10
--   ----  -    -    -    -    -    -    -    -    -    -
1    copy  copy
2    rdct  rdct
3    cr    copy rdct
4    cncf  cncf
5    cpcncf copy cncf
6    cncfrd cncf rdct
7    cpcfrd copy cncf rdct
```

GWS action set table is (7 of 16) 44% full

If the required gateway screening stop action set is not in the database, go to the "Configuring Gateway Screening Stop Action Sets" procedure on page 2-54 and configure the required gateway screening stop action set.

---

**NOTE:** If the point code being added in this procedure is not an ITU-I or 14-bit ITU-N spare point code, skip this step and go to step 6.

**NOTE:** If the point code being added in this procedure is an ITU-I or 14-bit ITU-N spare point code and the screening reference contains ITU-I or 14-bit ITU-N spare point codes, skip this step and go to step 6.

5. Display the status of the ITU National and International Spare Point Code Support feature by entering the **rtrv-ctrl-feat** command with the ITU National and International Spare Point Code Support feature part number. Enter this command.

```
rtrv-ctrl-feat:partnum=893013601
```

This is an example of the possible output.

```
rlghncxa03w 05-09-25 15:25:30 GMT EAGLE5 34.0.0
The following features have been permanently enabled:

Feature Name                Partnum  Status  Quantity
Spare Point Code Support    893013601 on      ----
```

The following features have been temporarily enabled:



## Allowed Affected Destination Field (DESTFLD) Screen Configuration

Feature Name	Partnum	Status	Quantity	Trial	Period	Left
Zero entries found.						

The following features have expired temporary keys:

Feature Name	Partnum
Zero entries found.	

If the ITU National and International Spare Point Code Support feature is enabled, go to step 6.

If the ITU National and International Spare Point Code Support feature is not enabled, perform the “Activating the ITU National and International Spare Point Code Support Feature” procedure in the *Database Administration Manual - SS7* to enable the ITU National and International Spare Point Code Support feature as required. After the feature has been enabled, go to step 6.

- 
6. Add a new allowed DESTFLD screen to the database using the **ent-scr-destfld** command.

If a gateway screening stop action is to be assigned to the allowed DESTFLD screen being changed, enter the **ent-scr-destfld** command with the **nsfi=stop** parameter and the **actname** parameter with the name of a gateway screening stop action set shown in the output of the **rtrv-gws-actset** command executed in step 4.

The following list contains the values for **ni**, **nc**, **ncm**, **zone**, **area**, **id**, **npc**, **msa**, **ssa**, and **sp** parameters:

- **ni** – 0 - 255 or an asterisk (\*)
- **nc** – 0 - 255 or an asterisk (\*)
- **ncm** – 0 - 255 or an asterisk (\*)
- **zone** – 0 - 7 or an asterisk (\*)
- **area** – 0 - 255 or an asterisk (\*)
- **id** – 0 - 7 or an asterisk (\*)
- **npc** – 1 - 16383 or an asterisk (\*)
- **msa** – 0 - 255 or an asterisk (\*)
- **ssa** – 0 - 255 or an asterisk (\*)
- **sp** – 0 - 255 or an asterisk (\*)

A range of values can be specified for the **ni**, **nc**, and **ncm** parameters. See the “Specifying a Range of Values” section on page 7-7 for more information on how the asterisk and a range of values are used for the **ni**, **nc**, and **ncm** parameters.

## Allowed Affected Destination Field (DESTFLD) Screen Configuration

To add a spare point code to the allowed DESTFLD screen, the **pcst=s** parameter must be specified. To add a non-spare point code to the allowed DESTFLD screen, the **pcst** parameter does not have to be specified. If the **pcst** parameter is specified for a screen containing an ITU-I or 14-bit ITU-N non-spare point code, the value must be **none**.

For this example, enter this command.

```
ent-scr-destfld:sr=fld5:ni=100:nc=100:ncm=100:nsfi=stop
:actname=cr
```

A message similar to the following should appear.

```
rlghncxa03w 05-09-25 15:29:30 GMT EAGLE5 34.0.0
ENT-SCR-DESTFLD: SCREEN SET AFFECTED - FLD5 1% FULL
ENT-SCR-DESTFLD: MASP A - COMPLTD
```

---

7. Verify the changes using the **rtrv-scr-destfld** command with the screening reference name used in step 6. For this example, enter this command.

```
rtrv-scr-destfld:sr=fld5
```

The following is an example of the possible output.

```
rlghncxa03w 05-09-25 15:30:30 GMT EAGLE5 34.0.0
SCREEN = ALLOWED DESTFLD
SR      NI      NC      NCM      NSFI      NSR/ACT
FLD5   100     100     100     STOP     CR
```

---

8. Backup the new changes using the **chg-db:action=backup:dest=fixed** command. The following messages should appear, the active Maintenance and Administration Subsystem Processor (MASP) appears first.

```
BACKUP (FIXED) : MASP A - Backup starts on active MASP.
BACKUP (FIXED) : MASP A - Backup on active MASP to fixed disk complete.
BACKUP (FIXED) : MASP A - Backup starts on standby MASP.
BACKUP (FIXED) : MASP A - Backup on standby MASP to fixed disk complete.
```

---

## Allowed Affected Destination Field (DESTFLD) Screen Configuration

Flowchart 7-2. Adding an Allowed Affected Destination Field Screen (Sheet 1 of 3)

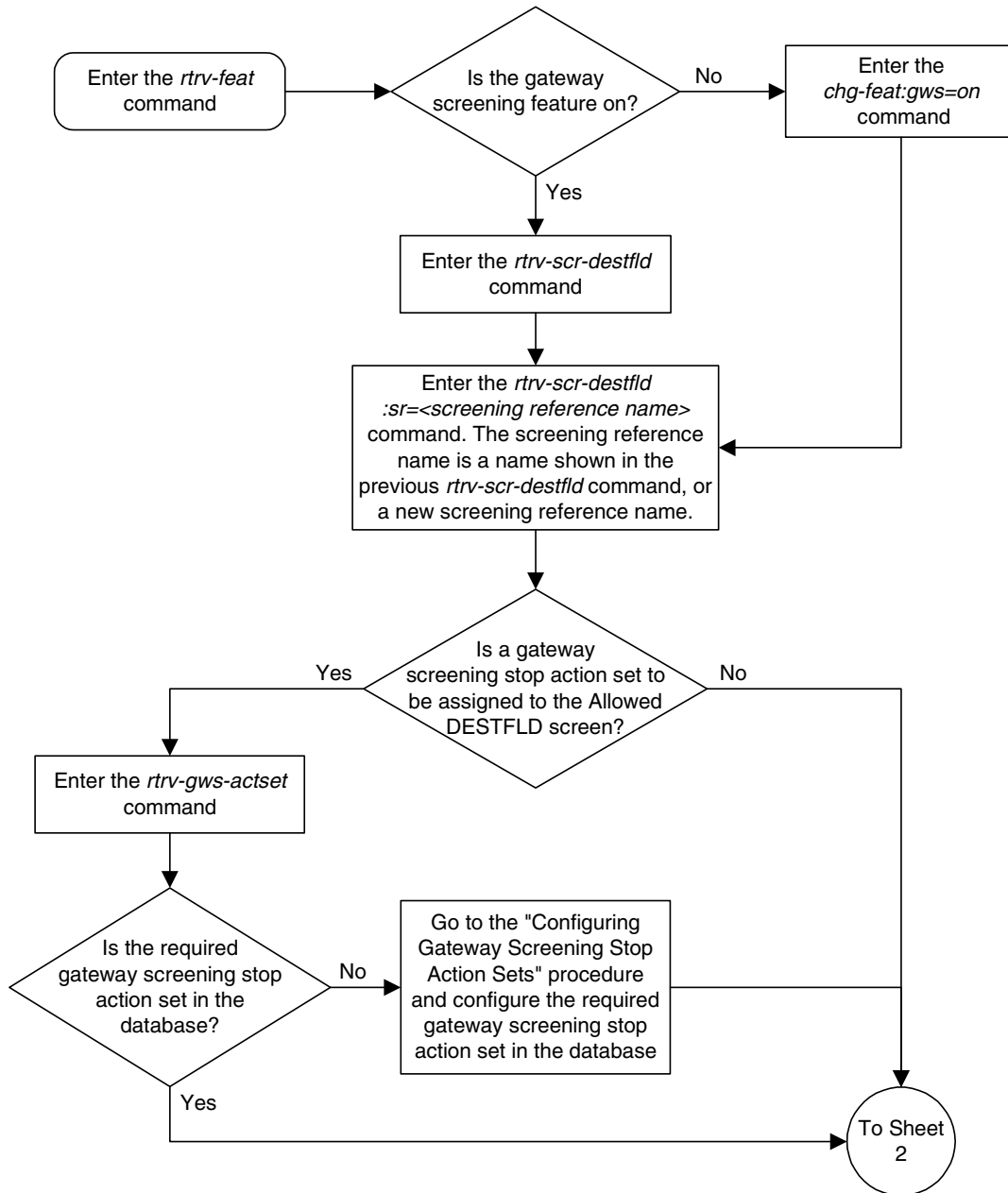

Flowchart 7-2. Adding an Allowed Affected Destination Field Screen (Sheet 2 of 3)

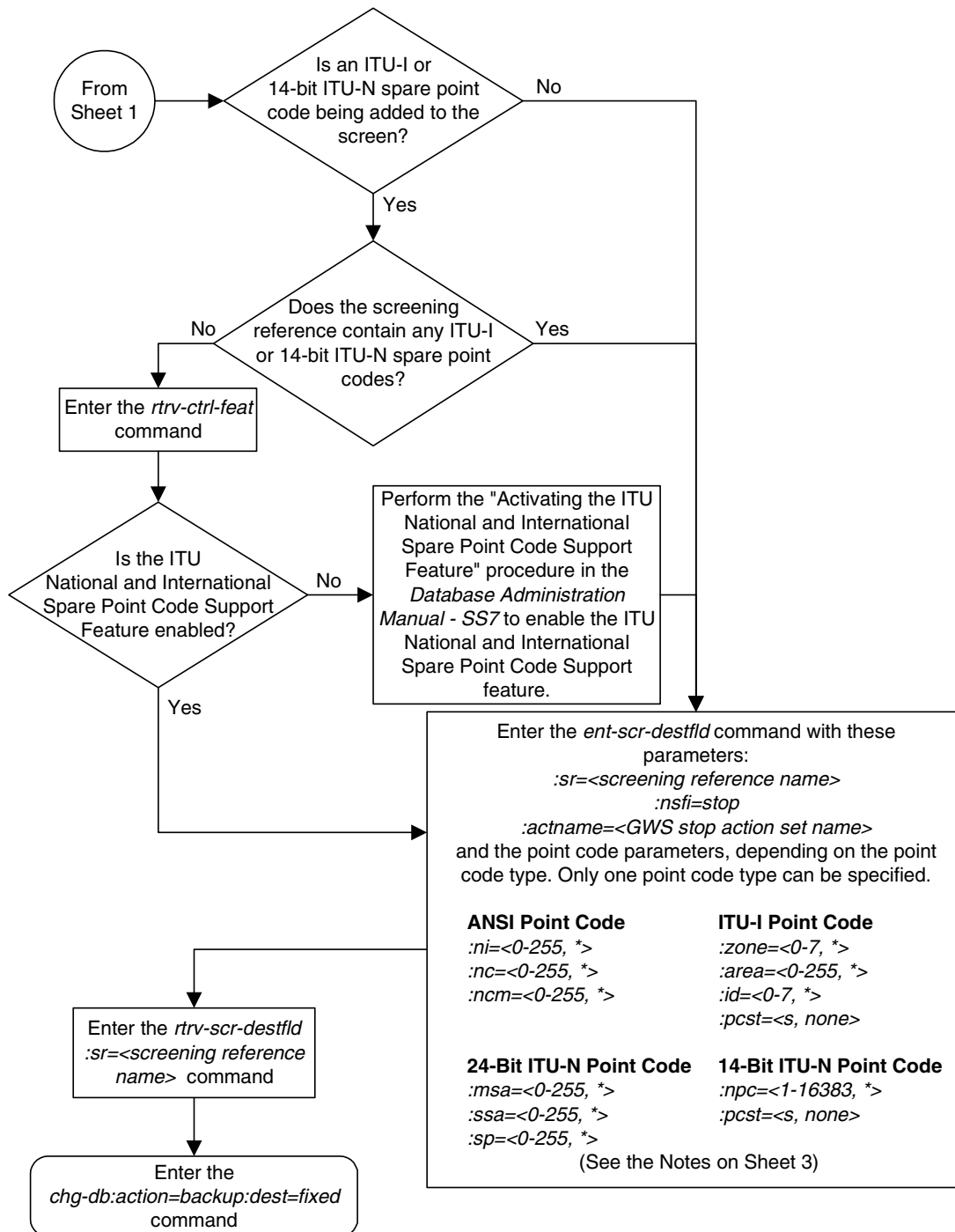

## Allowed Affected Destination Field (DESTFLD) Screen Configuration

### Flowchart 7-2. Adding an Allowed Affected Destination Field Screen (Sheet 3 of 3)

**Notes:**

1. A range of values can be specified for the *ni*, *nc*, or *ncm* parameters by inserting double ampersands (&&) between the parameter values defining the range. For example, to specify the range 025 to 200 for the *ni* parameter, enter 025&&200 for the *ni* parameter value.
2. The asterisk (\*) specifies the entire range of values for that parameter.  
For more information about specifying a range of values and about using the asterisk, see the "Gateway Screening Attributes" section in Chapter 2 and the "Specifying a Range of Values" section in this procedure.
3. The *actname* parameter is optional. If the *actname* parameter is specified, the *actname* parameter value is one of the gateway screening stop action set names shown in the *rtrv-gws-actset* output on Sheet 1.
4. To add a non-spare point code, the *pcst* parameter does not have to be specified. If the *pcst* parameter is specified for a screen containing an ITU-I or 14-bit ITU-N non-spare point code, the value must be *none*.
5. To add a spare point code, the *pcst=s* parameter must be specified.

## Removing an Allowed Affected Destination Field Screen

This procedure is used to remove an allowed affected destination field (DESTFLD) screen from the database using the `dlt-scr-destfld` command. The parameters used by the `dlt-scr-destfld` command are shown in the "Gateway Screening Attributes" section on page 2-7. The general rules that apply to configuring gateway screening entities are shown in the "Gateway Screening Configuration" section on page 2-28.

The example in this procedure removes the allowed DESTFLD screen `fld5` from the database.

**NOTE:** If you using multiple-part ITU national point codes with gateway screening, see "14-Bit ITU National Point Code Formats" on page 2-24.

The allowed DESTFLD screen can be referenced by one of the following screens.

- Allowed SIO
- Allowed DPC
- Blocked DPC

Enter the following commands to verify that none of these screens reference the allowed CGPA screen being removed from the database.

- `rtrv-scr-sio:nsfi=destfld`
- `rtrv-scr-dpc:nsfi=destfld`
- `rtrv-scr-blkdpc:nsfi=destfld`

To change the NSFI of any of these screens, go to one of the following procedures.

- "Changing an Allowed SIO Screen" procedure on page 10-23
- "Changing an Allowed DPC Screen" procedure on page 9-26
- "Changing a Blocked DPC Screen" procedure on page 8-26

### Procedure

---

1. Display the allowed DESTFLD screens in the database using the `rtrv-scr-destfld` command. The following is an example of the possible output.

```
rlghncxa03w 05-09-25 15:25:30 GMT EAGLE5 34.0.0
SCREEN = ALLOWED DESTFLD
SR      REF  RULES
FLD5   YES   1
IEC    YES   6
WRD2   YES   1
WRD4   YES   9
```

## Allowed Affected Destination Field (DESTFLD) Screen Configuration

From the **rtrv-scr-destfld** output, display the allowed DESTFLD screen you wish to remove using the **rtrv-scr-destfld** command with the screening reference name. For this example, enter this command.

```
rtrv-scr-destfld:sr=fld5
```

The following is an example of the possible output.

```
rlghncxa03w 05-09-25 15:25:30 GMT EAGLE5 34.0.0
SCREEN = ALLOWED DESTFLD
SR      NI      NC      NCM      NSFI  NSR/ACT
fld5   100      100      100      STOP  cr
```

---

2. Enter the commands on page 7-16 to verify that the screen being removed is not referenced by other screens in the database. If the screen being removed is referenced by other screens, go to the procedures shown on page 7-16 and change the NSFI of those screens to reference other screens or change the NSFI of these screens to STOP.
- 

3. Remove the allowed DESTFLD screen from the database using the **dlt-scr-destfld** command with the screening reference name shown in the **rtrv-scr-destfld** output in step 1 and with the point code parameter values (**ni**, **nc**, **ncm**, or **zone**, **area**, **id**, **npc**, **msa**, **ssa**, or **sp**) of the screen being removed from the database. The values for these parameters must be entered exactly as shown in the **rtrv-scr-destfld** output.

To remove an entry containing either an ITU-I or a 14-bit ITU-N spare point code, the **pcst=s** parameter must be specified with the **dlt-scr-destfld** command.

To remove an entry containing either an ITU-I or a 14-bit ITU-N non-spare point code, the **pcst** parameter does not have to be specified with the **dlt-scr-destfld** command. If the **pcst** parameter is specified, the value must be **none**.

For this example, enter this command.

```
dlt-scr-destfld:sr=fld5:ni=100:nc=100:ncm=100
```

A message similar to the following should appear.

```
rlghncxa03w 05-09-25 15:26:30 GMT EAGLE5 34.0.0
DLT-SCR-DESTFLD: SCREEN SET AFFECTED - FLD5 0% FULL
DLT-SCR-DESTFLD: MASP A - COMPLTD
```

---

## Allowed Affected Destination Field (DESTFLD) Screen Configuration

4. Verify the changes using the **rtrv-scr-destfld** command with the screening reference name used in step 3. For this example, enter this command.

```
rtrv-scr-destfld:sr=fld5
```

The following is an example of the possible output.

```
E2573 Cmd Rej: SR or NSR does not reference an existing SR
```

This message shows that the specified screening reference name is not in the database and the action of the **dlt-scr-destfld** command in step 3 was successful. If the specified screening reference name contained more than one entry when the **dlt-scr-destfld** command was executed in step 3, the **rtrv-scr-destfld:sr=** command output would show the remaining entries in the screening reference instead of error message E2573.

- 
5. Backup the new changes using the **chg-db:action=backup:dest=fixed** command. The following messages should appear, the active Maintenance and Administration Subsystem Processor (MASP) appears first.

```
BACKUP (FIXED) : MASP A - Backup starts on active MASP.  
BACKUP (FIXED) : MASP A - Backup on active MASP to fixed disk complete.  
BACKUP (FIXED) : MASP A - Backup starts on standby MASP.  
BACKUP (FIXED) : MASP A - Backup on standby MASP to fixed disk complete.
```

---



## Allowed Affected Destination Field (DESTFLD) Screen Configuration

**Flowchart 7-3.** Removing an Allowed Affected Destination Field Screen (Sheet 1 of 2)

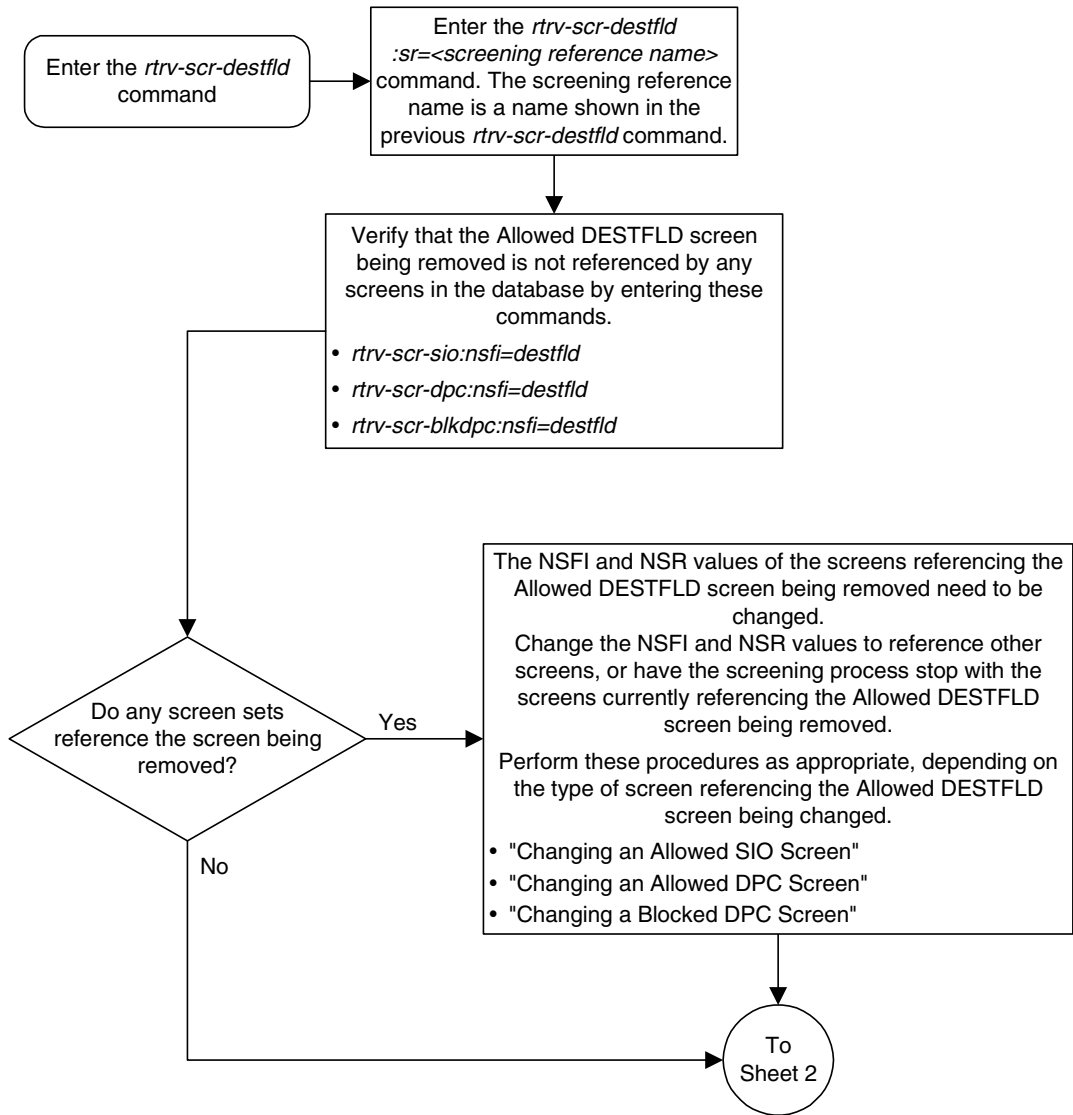

## Allowed Affected Destination Field (DESTFLD) Screen Configuration

**Flowchart 7-3.** Removing an Allowed Affected Destination Field Screen (Sheet 2 of 2)

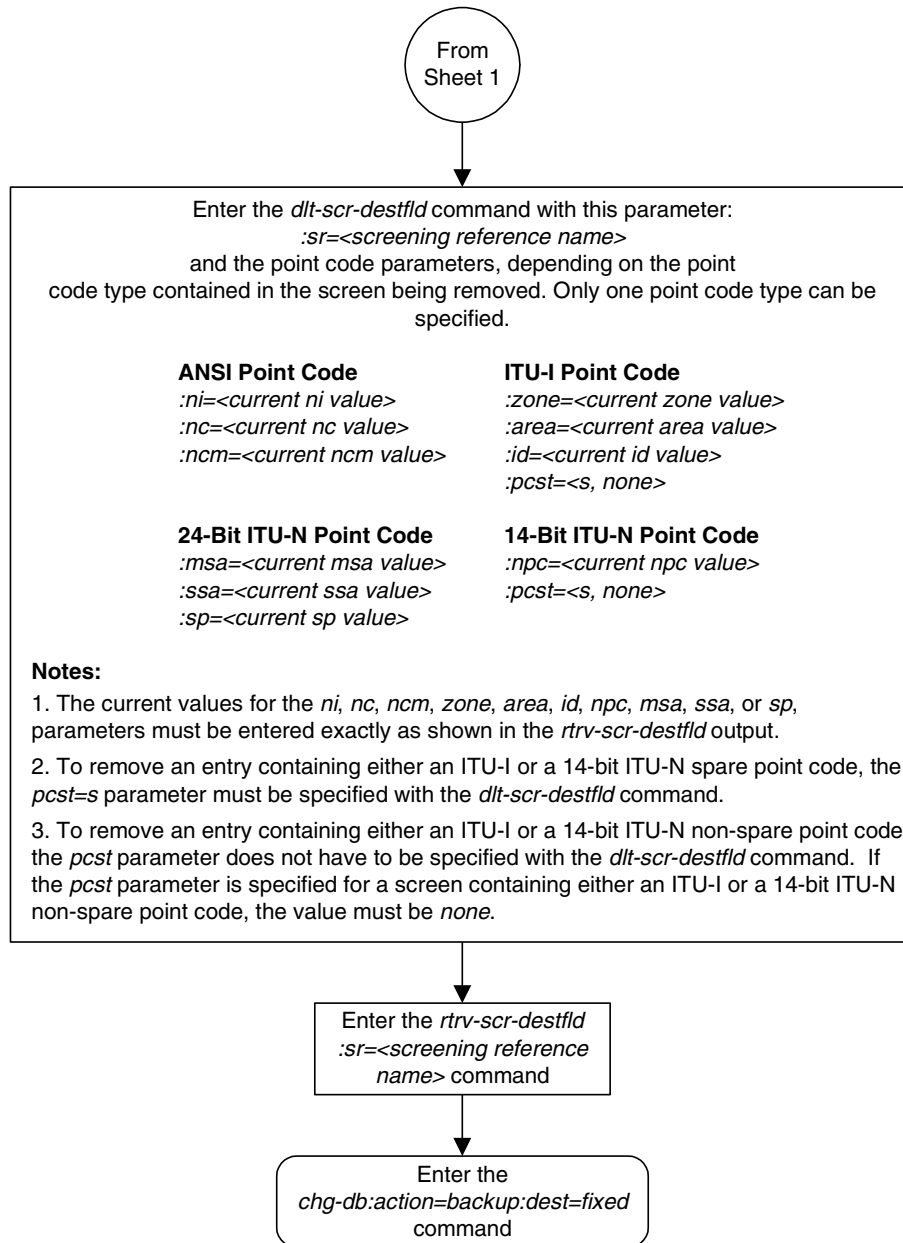

## Changing an Allowed Affected Destination Field Screen

This procedure is used to change the attributes of an allowed affected destination field (DESTFLD) screen in the database using the `chg-scr-destfld` command. The parameters used by the `chg-scr-destfld` command are shown in the "Gateway Screening Attributes" section on page 2-7. The general rules that apply to configuring gateway screening entities are shown in the "Gateway Screening Configuration" section on page 2-28.

The example in this procedure is used to change the point code 100-100-100 for the allowed DESTFLD screen `fld5` to 030-030-030 and to redirect the MSU for the DTA feature.

**NOTE:** If you using multiple-part ITU national point codes with gateway screening, see "14-Bit ITU National Point Code Formats" on page 2-24.

### Specifying a Range of Values

A range of values can be specified for the point code parameters `ni`, `nc`, or `ncm`.

If a range of values is specified for any of these parameters, and the value of the other parameters match existing values for the screening reference name, the range of values for the point code parameter cannot include any values for that parameter that are currently provisioned for the screening reference name.

For example, screening reference name `scr1` contains these entries:

SR	NI	NC	NCM	NSFI	NSR/ACT
SCR1	240	001	010	STOP	-----
SCR1	241	010	020	STOP	-----

Another entry for screening reference `scr1` with the `ni` value of 240 and the `nc` value of 001 cannot be specified if the range of values for the `ncm` parameter includes the value 010.

The ANSI point code parameter values can be specified as a single value, a range of values, or with an asterisk (\*). The asterisk specifies all possible values for the `ni`, `nc`, and `ncm` parameters. Table 7-5 shows the valid combinations of these parameter values.

**Table 7-5.** Valid Value Combinations for ANSI Point Code Parameters

NI	NC	NCM
Single Value	Single Value	Single Value
Single Value	Single Value	Range of Values
Single Value	Single Value	Asterisk
Single Value	Range of Values	Asterisk
Single Value	Asterisk	Asterisk
Range of Values	Asterisk	Asterisk
Asterisk	Asterisk	Asterisk

A range of values can also be specified for an ITU-I or 24-bit ITU-N point code parameter using a combination of asterisks (\*) and single values for the point code parameters. Table 7-6 shows the valid combinations of the ITU-I parameter values. Table 7-7 shows the valid combinations of the 24-bit ITU-N parameter values.

**Table 7-6.** Valid Value Combinations for ITU-I Point Code Parameters

ZONE	AREA	ID
Single Value	Single Value	Single Value
Single Value	Single Value	Asterisk
Single Value	Asterisk	Asterisk
Asterisk	Asterisk	Asterisk

**Table 7-7.** Valid Value Combinations for 24-Bit ITU-N Point Code Parameters

MSA	SSA	SP
Single Value	Single Value	Single Value
Single Value	Single Value	Asterisk
Single Value	Asterisk	Asterisk
Asterisk	Asterisk	Asterisk

**Procedure**

---

1. Display the allowed DESTFLD screens in the database using the **rtrv-scr-destfld** command. The following is an example of the possible output.

```
rlghncxa03w 05-09-25 15:25:30 GMT EAGLE5 34.0.0
SCREEN = ALLOWED DESTFLD
SR      REF  RULES
FLD5   YES   1
IEC    YES   6
WRD2   YES   1
WRD4   YES   9
```

From the **rtrv-scr-destfld** output, display the allowed DESTFLD screen you wish to change using the **rtrv-scr-destfld** command with the screening reference name. For this example, enter this command.

**rtrv-scr-destfld:sr=fld5**

The following is an example of the possible output.

```
rlghncxa03w 05-09-25 15:25:30 GMT EAGLE5 34.0.0
SCREEN = ALLOWED DESTFLD
SR  NI      NC      NCM      NSFI  NSR/ACT
fld5 100      100     100     STOP  cr
```

If a gateway screening stop action set is to be assigned to the allowed DESTFLD screen being added to the database, go to step 2. Otherwise, go to step 3.

---

2. Display the gateway screening stop action sets in the database with the **rtrv-gws-actset** command. This is an example of the possible output.

```
rlghncxa03w 05-09-25 15:26:30 GMT EAGLE5 34.0.0
ACT ACT  ACT ACT  ACT ACT  ACT ACT  ACT ACT  ACT ACT
ID  NAME  1   2   3   4   5   6   7   8   9   10
--  -----
1   copy  copy
2   rdct  rdct
3   cr    copy rdct
4   cnf   cnf
5   cpcnf copy cnf
6   cnf   rdct
7   cpcnf copy cnf rdct
```

GWS action set table is (7 of 16) 44% full

If the required gateway screening stop action set is not in the database, go to the “Configuring Gateway Screening Stop Action Sets” procedure on page 2-54 and configure the required gateway screening stop action set.

---

**NOTE:** If any of these conditions apply to this procedure, skip this step and go to step 4:

- The point code in the screen is not being changed.
  - The screen being changed contains either an ANSI or 24-bit ITU-N point code.
  - The ITU-I or 14-bit ITU-N non-spare point code in the screen is not being changed to an ITU-I or 14-bit ITU-N spare point code.
  - The point code in the screen is an ITU-I or 14-bit ITU-N spare point code or the screening reference contains other screens with ITU-I or 14-bit ITU-N spare point codes.
3. Display the status of the ITU National and International Spare Point Code Support feature by entering the `rtrv-ctrl-feat` command with the ITU National and International Spare Point Code Support feature part number. Enter this command.

```
rtrv-ctrl-feat:partnum=893013601
```

This is an example of the possible output.

```
rlghncxa03w 05-09-25 15:25:30 GMT EAGLE5 34.0.0
The following features have been permanently enabled:
```

Feature Name	Partnum	Status	Quantity
Spare Point Code Support	893013601	on	----

The following features have been temporarily enabled:

Feature Name	Partnum	Status	Quantity	Trial Period Left
Zero entries found.				

The following features have expired temporary keys:

Feature Name	Partnum
Zero entries found.	

If the ITU National and International Spare Point Code Support feature is enabled, go to step 4.

If the ITU National and International Spare Point Code Support feature is not enabled, perform the “Activating the ITU National and International Spare Point Code Support Feature” procedure in the *Database Administration Manual - SS7* to enable the ITU National and International Spare Point Code Support feature as required. After the feature has been enabled, go to step 4.

---

## Allowed Affected Destination Field (DESTFLD) Screen Configuration

4. Change the attributes of an allowed DESTFLD screen using the **chg-scr-destfld** command.

If a gateway screening stop action is to be assigned to the allowed DESTFLD screen being changed, enter the **chg-scr-destfld** command with the **actname** parameter with the name of a gateway screening stop action set shown in the output of the **rtrv-gws-actset** command executed in step 2.

The current values for the **ni**, **nc**, **ncm**, **zone**, **area**, **id**, **npc**, **msa**, **ssa**, and **sp** parameters must be entered exactly as shown in the **rtrv-scr-destfld** output in step 1.

The following list contains the values for the **nni**, **nnc**, **nncm**, **nzone**, **narea**, **nid**, **nnpc**, **nmsa**, **nssa**, and **nsp** parameters:

- **nni** – 0 - 255 or an asterisk (\*)
- **nnc** – 0 - 255 or an asterisk (\*)
- **nncm** – 0 - 255 or an asterisk (\*)
- **nzone** – 0 - 7 or an asterisk (\*)
- **narea** – 0 - 255 or an asterisk (\*)
- **nid** – 0 - 7 or an asterisk (\*)
- **nnpc** – 1 - 16383 or an asterisk (\*)
- **nmsa** – 0 - 255 or an asterisk (\*)
- **nssa** – 0 - 255 or an asterisk (\*)
- **nsp** – 0 - 255 or an asterisk (\*)

A range of values can be specified for the **nni**, **nnc**, and **nncm** parameters. See the "Specifying a Range of Values" section on page 7-21 for more information on how the asterisk and a range of values are used for the **nni**, **nnc**, and **nncm** parameters.

To change an ITU-I or 14-bit ITU-N spare point code to a non-spare point code, both the **pcst=s** and **npcst=none** parameters must be specified with the **chg-scr-destfld** command.

To change an ITU-I or 14-bit ITU-N non-spare point code to a spare point code, the **npcst=s** parameter must be specified with the **chg-scr-destfld** command. The **pcst** parameter does not have to be specified.

If the current point code in the screen being changed is either an ITU-I or 14-bit ITU-N spare point code, the **pcst=s** parameter must be specified with the **chg-scr-destfld** command.

If the current point code in the screen being changed is either an ITU-I or 14-bit ITU-N non-spare point code, the **pcst** parameter does not have to be specified with the **chg-scr-destfld** command. If the **pcst** parameter is specified for a screen containing either an ITU-I or 14-bit ITU-N non-spare point code, the **pcst** parameter value must be **none**.

## Allowed Affected Destination Field (DESTFLD) Screen Configuration

For this example, enter this command.

```
chg-scr-destfld:sr=fld5:ni=100:nc=100:ncm=100:nni=030:nnc=030  
:nncm=030:actname=rdct
```

The following messages appear.

```
rlghncxa03w 05-09-25 15:27:30 GMT EAGLE5 34.0.0  
CHG-SCR-DESTFLD: SCREEN SET AFFECTED - FLD5 1% FULL  
CHG-SCR-DESTFLD: MASP A - COMPLTD
```

---

5. Verify the changes using the **rtrv-scr-destfld** command with screening reference name used in step 4. For this example, enter this command.

```
rtrv-scr-destfld:sr=fld5
```

The following is an example of the possible output.

```
rlghncxa03w 05-09-25 15:28:30 GMT EAGLE5 34.0.0  
SCREEN = ALLOWED DESTFLD  
SR      NI      NC      NCM      NSFI     NSR/ACT  
fld5   030     030     030     STOP     rdct
```

---

6. Backup the new changes using the **chg-db:action=backup:dest=fixed** command. The following messages should appear, the active Maintenance and Administration Subsystem Processor (MASP) appears first.

```
BACKUP (FIXED) : MASP A - Backup starts on active MASP.  
BACKUP (FIXED) : MASP A - Backup on active MASP to fixed disk complete.  
BACKUP (FIXED) : MASP A - Backup starts on standby MASP.  
BACKUP (FIXED) : MASP A - Backup on standby MASP to fixed disk complete.
```

---



## Allowed Affected Destination Field (DESTFLD) Screen Configuration

**Flowchart 7-4.** Changing an Allowed Affected Destination Field Screen (Sheet 1 of 4)

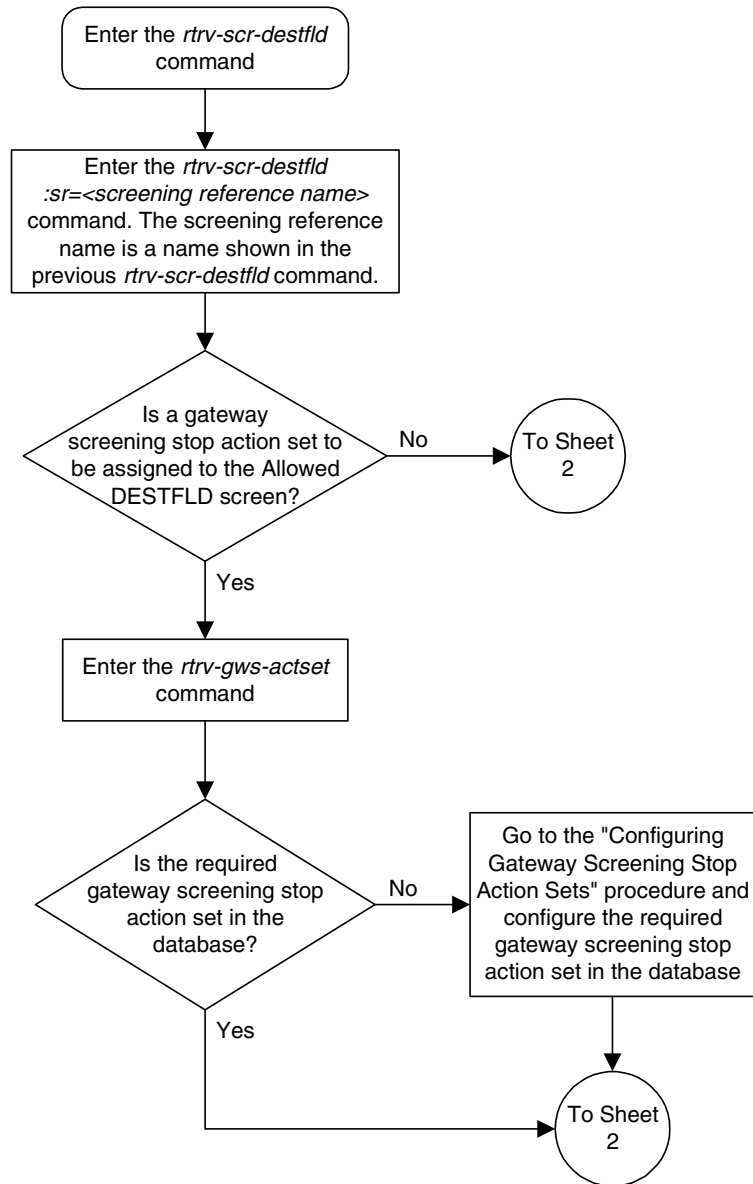

# Allowed Affected Destination Field (DESTFLD) Screen Configuration

Flowchart 7-4. Changing an Allowed Affected Destination Field Screen (Sheet 2 of 4)

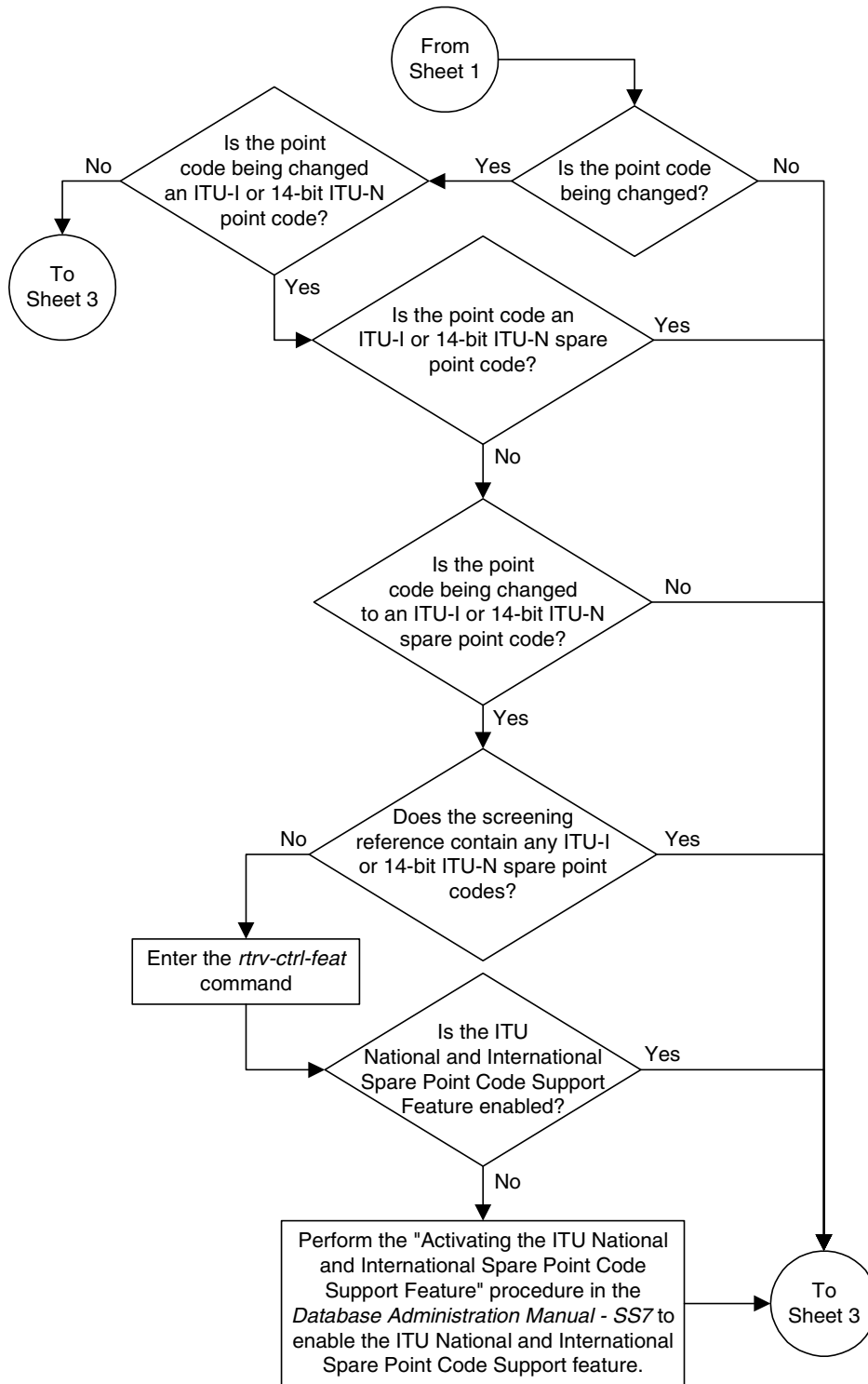

## Allowed Affected Destination Field (DESTFLD) Screen Configuration

**Flowchart 7-4.** Changing an Allowed Affected Destination Field Screen (Sheet 3 of 4)

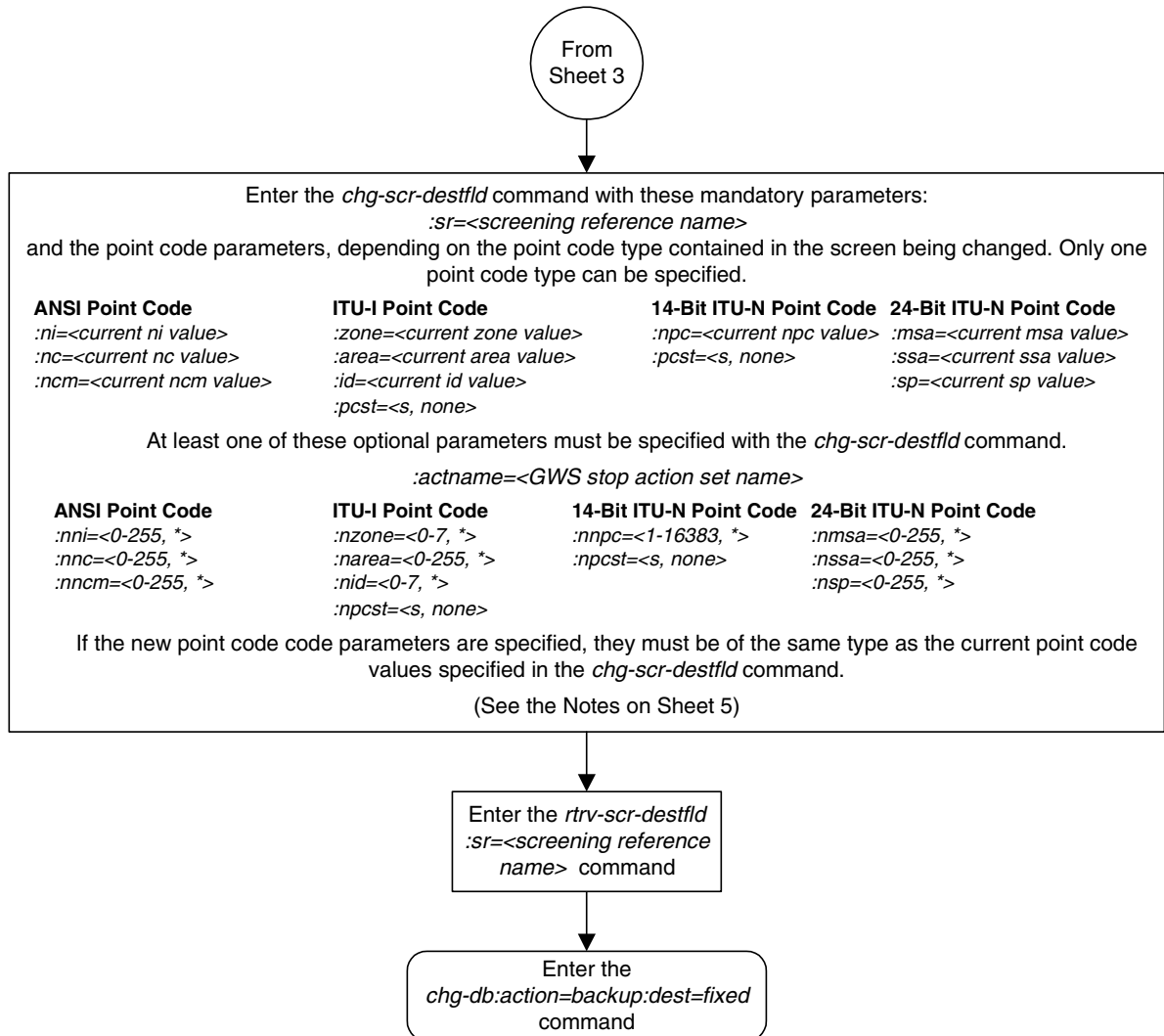

**Flowchart 7-4.** Changing an Allowed Affected Destination Field Screen (Sheet 4 of 4)

**Notes:**

1. A range of values can be specified for the *nni*, *nnc*, or *nncm* parameters by inserting double ampersands (&&) between the parameter values defining the range. For example, to specify the range 025 to 200 for the *nni* parameter, enter 025&&200 for the *nni* parameter value.
2. The asterisk (\*) specifies the entire range of values for that parameter.  
For more information about specifying a range of values and about using the asterisk, see the "Gateway Screening Attributes" section in Chapter 2 and the "Specifying a Range of Values" section in this procedure.
3. The *actname* parameter is optional. If the *actname* parameter is specified, the *actname* parameter value is one of the gateway screening stop action set names shown in the *rtrv-gws-actset* output on Sheet 1.
4. The current values for the *ni*, *nc*, *nncm*, *zone*, *area*, *id*, *npc*, *msa*, *ssa*, and *sp* parameters must be entered exactly as shown in the *rtrv-scr-destfld* output.
5. To change an ITU-I or 14-bit ITU-N spare point code to a non-spare point code, both the *pcst=s* and *npcst=none* parameters must be specified with the *chg-scr-destfld* command.
6. To change an ITU-I or 14-bit ITU-N non-spare point code to a spare point code, the *npcst=s* parameter must be specified with the *chg-scr-destfld* command. The *pcst* parameter does not have to be specified.
7. If the current point code in the screen being changed is either an ITU-I or 14-bit ITU-N spare point code, the *pcst=s* parameter must be specified with the *chg-scr-destfld* command.
8. If the current point code in the screen being changed is either an ITU-I or 14-bit ITU-N non-spare point code, the *pcst* parameter does not have to be specified with the *chg-scr-destfld* command. If the *pcst* parameter is specified for a screen containing either an ITU-I or 14-bit ITU-N non-spare point code, the *pcst* parameter value must be *none*.

# 8

## Blocked Destination Point Code (BLKDPC) Screen Configuration

Introduction.....	8-2
Adding a Blocked DPC Screen .....	8-8
Removing a Blocked DPC Screen.....	8-21
Changing a Blocked DPC Screen.....	8-26

## Introduction

The blocked DPC screen identifies DPC's that are not allowed to receive SS7 messages from another network. The gray shaded areas in Figure 8-1 on page 8-7 shows the fields of the SS7 message that are checked by the blocked DPC screening function. If a match is found, the **nsfi** is equal to **fail**, the message is discarded and no further screening takes place.

If no match is found, the **nsfi** is examined to determine the next step in the screening process. If the **nsfi** is equal to **stop**, the message is processed and no further screening takes place.

If the **nsfi** is equal to **stop**, and the **copy** gateway screening stop action is specified, the message is processed and a copy of the message is sent by the STP LAN feature to an external application through an ACM running the **stplan** application or a DCM running the **vxwslan** application.

If the **nsfi** is equal to **stop**, and the **rdct** (redirect) gateway screening stop action is specified, the message is diverted from the original destination and sent to another destination with the Database Transport Access feature, specified by global title translation, for further processing.

If the Calling Name Conversion Facility (CNCF) feature is on, the **nsfi** is equal to **stop**, and the **cncf** gateway screening stop action is specified, the PIP parameter in the incoming ISUP IAM message is converted to the GN parameter. The GN parameter in the incoming ISUP IAM message is converted to the PIP parameter. The message is then sent to the node specified by the DPC in the routing label in the message. For more information on the Calling Name Conversion Facility feature, see Chapter 14, "Calling Name Conversion Facility (CNCF) Configuration."

If the Triggerless LNP (TLNP) feature is on, the **nsfi** is equal to **stop**, and the **tlnp** gateway screening stop action is specified, ISUP IAMs that pass gateway screening are processed either by the ISUP NP with EPAP feature (if the ISUP NP with EPAP feature is enabled and turned on) or by the Triggerless LNP feature (if the Triggerless LNP feature is turned on). The ISUP NP with EPAP feature is discussed in more detail in the *Feature Manual - G-Port*. The Triggerless LNP feature is discussed in more detail in the *LNP Feature Activation Guide*.

If the **nsfi** is equal to anything else, the next screening reference (**nsr**) is identified and the screening process continues to the next screen identified by the **nsfi** and **nsr** parameters.

Flowchart 8-1 shows the screening action of the blocked DPC screen.

# Blocked Destination Point Code (BLKDPC) Screen Configuration

Flowchart 8-1. Blocked DPC Screening Action (Sheet 1 of 4)

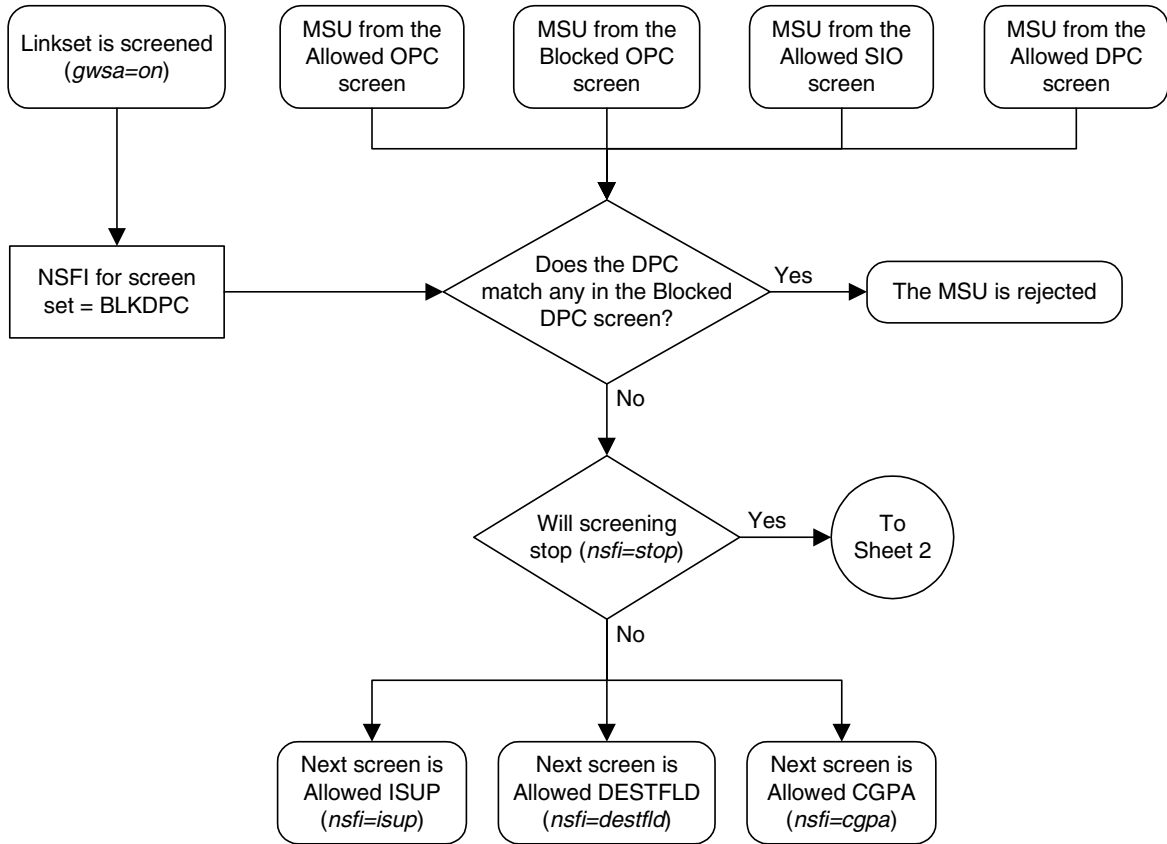

Flowchart 8-1. Blocked DPC Screening Action (Sheet 2 of 4)

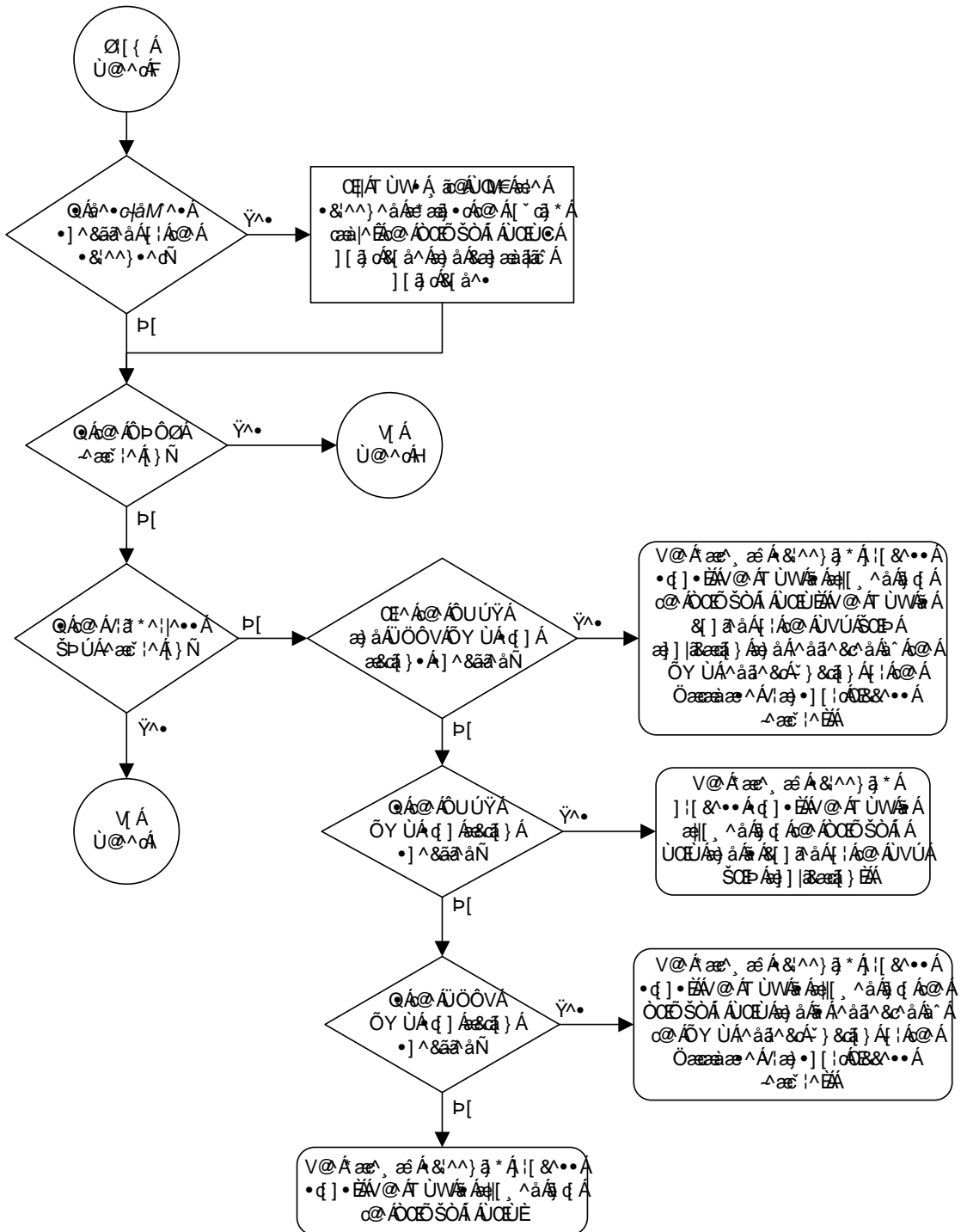



Blocked Destination Point Code (BLKDPC) Screen Configuration

Flowchart 8-1. Blocked DPC Screening Action (Sheet 3 of 4)

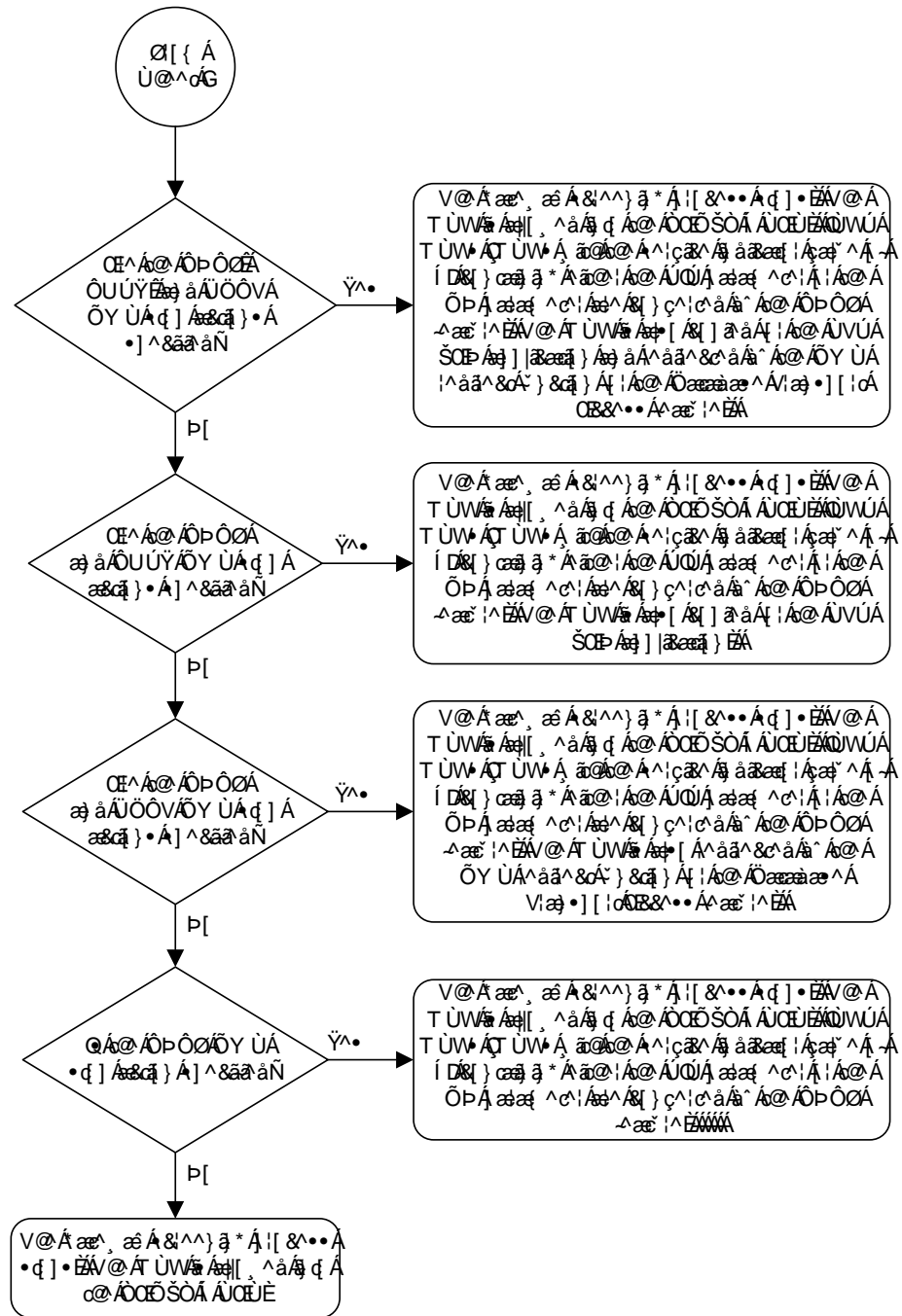

Flowchart 8-1. Blocked DPC Screening Action (Sheet 4 of 4)

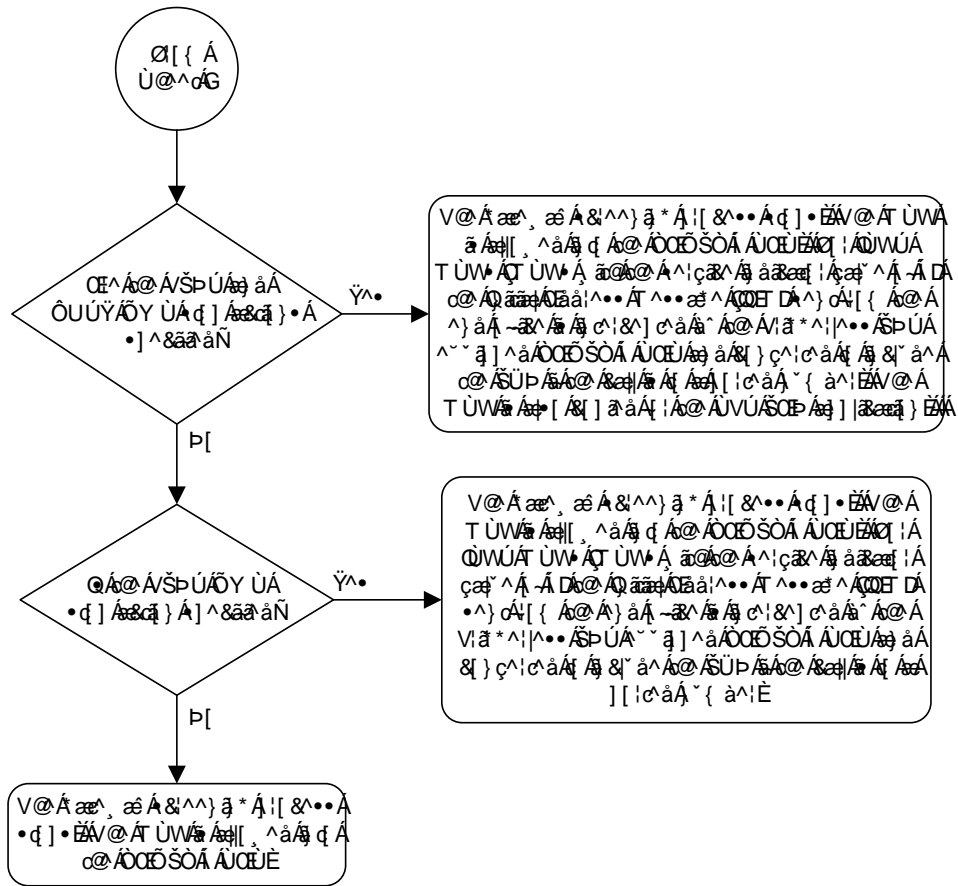

# Blocked Destination Point Code (BLKDPC) Screen Configuration

Figure 8-1. Blocked DPC Screening Functions

ANSI MSU (ANSI Message Signal Unit)

BSN FSN LI	SIO xx xx xxxx NIC PRI SI	SIF		
		Routing Label		SLS
		DPC NCM NC NI	OPC NCM NC NI	xx

ITU-I MSU (ITU International Message Signal Unit)

BSN FSN LI	SIO xx xx xxxx NIC PRI SI	SIF		
		Routing Label		SLS
		DPC ID AREA ZONE	OPC ID AREA ZONE	xx

14-Bit ITU-N MSU (14-Bit ITU National Message Signal Unit)

BSN FSN LI	SIO xx xx xxxx NIC PRI SI	SIF		
		Routing Label		SLS
		DPC NPC	OPC NPC	xx

24-Bit ITU-N MSU (24-Bit ITU National Message Signal Unit)

BSN FSN LI	SIO xx xx xxxx NIC PRI SI	SIF		
		Routing Label		SLS
		DPC SP SSA MSA	OPC SP SSA MSA	xx

## Adding a Blocked DPC Screen

This procedure is used to add a blocked destination point code (DPC) screen to the database using the `ent-scr-blkdpc` command. The parameters used by the `ent-scr-blkdpc` command are shown in the “Gateway Screening Attributes” section on page 2-7. The general rules that apply to configuring gateway screening entities are shown in the “Gateway Screening Configuration” section on page 2-28.

The examples in this procedure are used to add the blocked DPC screen data shown in Table 8-1 and based on the example configurations shown in Figure 2-3 on page 2-33 and Figure 2-5 on page 2-37.

**Table 8-1.** Example Gateway Screening Blocked DPC Configuration Table

Screening Reference	NI	NC	NCM	NSFI	NSR
gws9	C	C	C	cgpa	gw13
gws9	005	005	005	fail	----
gw12	C	C	C	cgpa	gw14
gw12	004	004	004	fail	----

**NOTE:** If you using multiple-part ITU national point codes with gateway screening, see “14-Bit ITU National Point Code Formats” on page 2-24.

The blocked DPC screen can reference one of the following screens.

- Allowed Affected Destination Field
- Allowed CGPA
- Allowed ISUP

Enter the following commands to verify that these screens are in the database.

- `rtrv-scr-destfld:all=yes`
- `rtrv-scr-cgpa:all=yes`
- `rtrv-scr-isup:all=yes`

If the desired screen is not in the database, go to one of the following procedures and add the desired screen to the database or change an existing screen in the database.

- “Adding an Allowed Affected Destination Field Screen” procedure on page 7-7
- “Adding an Allowed Calling Party Address Screen” procedure on page 6-6
- “Adding an Allowed ISUP Message Type Screen” procedure on page 15-9

## Blocked Destination Point Code (BLKDPC) Screen Configuration

- “Changing an Allowed Affected Destination Field Screen” procedure on page 7-21
- “Changing an Allowed Calling Party Address Screen” procedure on page 6-23
- “Changing an Allowed ISUP Message Type Screen” procedure on page 15-20

For the first entry for a specific screening reference, the value for the point code must be **c**, and the NSFI must be either **stop** or **cgpa**. If the NSFI is **stop**, the screening of the message will stop at the specified blocked DPC screen. If the NSFI is **cgpa**, then any message containing a point code that is not listed in the blocked DPC screen with a NSFI equal to **fail**, will continue to be screened with the allowed CGPA screen. All subsequent entries for that screening reference must contain a numeric point code value, the NSFI must be equal to **fail**, and the **nsr** parameter cannot be specified. Any message that contains a DPC in the blocked DPC screen with the NSFI equal to **fail** will be rejected from the network and the screening process is stopped.

The **pcst** parameter, specifying whether or not the ITU-I or 14-bit ITU-N point code is a spare point code, cannot be used with the **zone=c** or **npc=c** parameters.

### Specifying a Range of Values

A range of values can be specified for the point code parameters **ni**, **nc**, or **ncm**.

If a range of values is specified for any of these parameters, and the value of the other parameters match existing values for the screening reference name, the range of values for the point code parameter cannot include any values for that parameter that are currently provisioned for the screening reference name.

For example, screening reference name **scr1** contains these entries:

SR	NI	NC	NCM	NSFI	NSR/ACT
SCR1	C	C	C	CGPA	cg01
SCR1	240	001	010	FAIL	-----
SCR1	241	010	020	FAIL	-----

Another entry for screening reference **scr1** with the **ni** value of 240 and the **nc** value of 001 cannot be specified if the range of values for the **ncm** parameter includes the value 010.

The ANSI point code parameter values can be specified as a single value, a range of values, or with an asterisk (\*). The asterisk specifies all possible values for the **ni**, **nc**, and **ncm** parameters. Table 8-2 shows the valid combinations of these parameter values.

**Table 8-2.** Valid Value Combinations for ANSI Point Code Parameters

NI	NC	NCM
Single Value	Single Value	Single Value
Single Value	Single Value	Range of Values

**Table 8-2.** Valid Value Combinations for ANSI Point Code Parameters (Continued)

NI	NC	NCM
Single Value	Single Value	Asterisk
Single Value	Range of Values	Asterisk
Single Value	Asterisk	Asterisk
Range of Values	Asterisk	Asterisk
Asterisk	Asterisk	Asterisk

A range of values can also be specified for an ITU-I or 24-bit ITU-N point code parameter using a combination of asterisks (\*) and single values for the point code parameters. Table 8-3 shows the valid combinations of the ITU-I parameter values. Table 8-4 shows the valid combinations of the 24-bit ITU-N parameter values.

**Table 8-3.** Valid Value Combinations for ITU-I Point Code Parameters

ZONE	AREA	ID
Single Value	Single Value	Single Value
Single Value	Single Value	Asterisk
Single Value	Asterisk	Asterisk
Asterisk	Asterisk	Asterisk

**Table 8-4.** Valid Value Combinations for 24-Bit ITU-N Point Code Parameters

MSA	SSA	SP
Single Value	Single Value	Single Value
Single Value	Single Value	Asterisk
Single Value	Asterisk	Asterisk
Asterisk	Asterisk	Asterisk

### Procedure

---

1. Verify that the gateway screening feature is on, by entering the `rtrv-feat` command. If the gateway screening feature is on, the `GWS` field is set to `on`.

**NOTE:** The `rtrv-feat` command output contains other fields that are not used by this procedure. If you wish to see all the fields displayed by the `rtrv-feat` command, see the `rtrv-feat` command description in the *Commands Manual*.

If the gateway screening feature is on, shown by the entry `GWS = on` in the `rtrv-feat` command output, skip step 2, and go to step 3.

---

2. Turn the gateway screening feature on by entering this command.

```
chg-feat:gws=on
```

**NOTE:** Once the gateway screening feature is turned on with the `chg-feat` command, it cannot be turned off.

The gateway screening feature must be purchased before you turn this feature on with the `chg-feat` command. If you are not sure if you have purchased the gateway screening feature, contact your Tekelec Sales Representative or Account Representative.

When the `chg-feat` has successfully completed, this message should appear.

```
rlghncxa03w 05-09-28 11:43:04 GMT EAGLE5 34.0.0  
CHG-FEAT: MASP A - COMPLTD
```

---

3. Display all blocked DPC screens in the database using the `rtrv-scr-blkdp` command. The following is an example of the possible output.

```
rlghncxa03w 05-09-25 15:25:30 GMT EAGLE5 34.0.0  
SCREEN = BLOCKED DPC  
SR    REF  RULES  
IEC   YES   6  
WRD2  YES   1  
WRD3  NO    4  
WRD4  YES   9
```

If the screening reference names that you wish to add with this procedure are not shown in the `rtrv-scr-blkdp` command output, go to step 4. For this example, the screening reference names are not shown. If these screening reference names are shown in the `rtrv-scr-blkdp` command output, make sure the screening data you wish to enter is not already in the database by entering the `rtrv-scr-blkdp` command with the screening reference name. For example, enter the `rtrv-scr-blkdp:sr=iec` command. The following is an example of the possible output.

## Blocked Destination Point Code (BLKDPC) Screen Configuration

```
rlghncxa03w 05-09-25 15:26:30 GMT EAGLE5 34.0.0
SCREEN = BLOCKED DPC
SR   NI      NC      NCM      NSF1     NSR/ACT
IEC  240     001     010     FAIL     -----
IEC  241     010     *       FAIL     -----

SR      NPC
IEC     00235
                NSF1     NSR/ACT
                FAIL     -----

SR      ZONE  AREA  ID      NSF1     NSR/ACT
IEC     1     003   4       FAIL     -----
IEC     1     003   5       FAIL     -----
IEC     C     C     C       CGPA     cg01
```

If a gateway screening stop action set is to be assigned to the blocked DPC screen being added to the database, go to step 4.

Step 4 verifies the gateway screening stop action set names in the database. The gateway screening stop action set names are assigned only if the NSF1 of the screen being added in this procedure is STOP. If the NSF1 of the new screen will be STOP, but a gateway screening stop action set name will not be assigned to the new screen, skip steps 4 and 5 and go to step 6. If the NSF1 of the new screen is not STOP, skip step 4 and go to step 5.

- 
4. Display the gateway screening stop action sets in the database with the `rtrv-gws-actset` command. This is an example of the possible output.

```
rlghncxa03w 05-09-25 15:27:30 GMT EAGLE5 34.0.0
ACT ACT  ACT  ACT  ACT  ACT  ACT  ACT  ACT  ACT  ACT  ACT
ID  NAME  1   2   3   4   5   6   7   8   9   10
--  -----
1   copy  copy
2   rdct  rdct
3   cr    copy rdct
4   cnf   cnf
5   cpcnf copy cnf
6   cnf   rdct
7   cpcnf copy cnf rdct
```

GWS action set table is (7 of 16) 44% full

If the required gateway screening stop action set is not in the database, go to the "Configuring Gateway Screening Stop Action Sets" procedure on page 2-54 and configure the required gateway screening stop action set.

---

**NOTE:** If the NSF1 of the screen being added in this procedure is STOP or FAIL, skip step 5 and go to step 6.

5. Enter the commands on page 8-8 to verify that the screen that will be specified by the NSF1/NSR parameter combination in step 7 is in the database.

If the desired screen is not in the database, go to one of the procedures shown on pages 8-8 and 8-9 and either add the desired screen to the database or change an existing screen in the database.

---



## Blocked Destination Point Code (BLKDPC) Screen Configuration

**NOTE:** If the point code being added in this procedure is not an ITU-I or 14-bit ITU-N spare point code, skip this step and to to step 7.

**NOTE:** If the point code being added in this procedure is an ITU-I or 14-bit ITU-N spare point code and the screening reference contains ITU-I or 14-bit ITU-N spare point codes, skip this step and go to step 7.

6. Display the status of the ITU National and International Spare Point Code Support feature by entering the `rtrv-ctrl-feat` command with the ITU National and International Spare Point Code Support feature part number. Enter this command.

```
rtrv-ctrl-feat:partnum=893013601
```

This is an example of the possible output.

```
rlghncxa03w 05-09-25 15:25:30 GMT EAGLE5 34.0.0
```

The following features have been permanently enabled:

Feature Name	Partnum	Status	Quantity
Spare Point Code Support	893013601	on	----

The following features have been temporarily enabled:

Feature Name	Partnum	Status	Quantity	Trial Period Left
Zero entries found.				

The following features have expired temporary keys:

Feature Name	Partnum
Zero entries found.	

If the ITU National and International Spare Point Code Support feature is enabled, go to step 7.

If the ITU National and International Spare Point Code Support feature is not enabled, perform the “Activating the ITU National and International Spare Point Code Support Feature” procedure in the *Database Administration Manual - SS7* to enable the ITU National and International Spare Point Code Support feature as required. After the feature has been enabled, go to step 7.

---

7. Add a new blocked DPC screen to the database using the `ent-scr-blkdpc` command.

If a gateway screening stop action is to be assigned to the blocked DPC screen being added, enter the `ent-scr-blkdpc` command with the `nsfi=stop` parameter and the `actname` parameter with the name of a gateway screening stop action set shown in the output of the `rtrv-gws-actset` command executed in step 4.

The following list contains the values for `ni`, `nc`, `ncm`, `zone`, `area`, `id`, `npc`, `msa`, `ssa`, and `sp` parameters:

- `ni` – 0 - 255, c, or an asterisk (\*)
- `nc` – 0 - 255, c, or an asterisk (\*)
- `ncm` – 0 - 255, c, or an asterisk (\*)
- `zone` – 0 - 7, c, or an asterisk (\*)
- `area` – 0 - 255, c, or an asterisk (\*)
- `id` – 0 - 7, c, or an asterisk (\*)
- `npc` – 1 - 16383, c, or an asterisk (\*)
- `msa` – 0 - 255, c, or an asterisk (\*)
- `ssa` – 0 - 255, c, or an asterisk (\*)
- `sp` – 0 - 255, c, or an asterisk (\*)

A range of values can be specified for the `ni`, `nc`, and `ncm` parameters. See the “Specifying a Range of Values” section on page 8-9 for more information on how the asterisk and a range of values are used for the `ni`, `nc`, and `ncm` parameters.

To add a spare point code to the blocked DPC screen, the `pcst=s` parameter must be specified. To add a non-spare point code to the blocked DPC screen, the `pcst` parameter does not have to be specified. If the `pcst` parameter is specified for a screen containing an ITU-I or 14-bit ITU-N non-spare point code, the value must be `none`. The `pcst` parameter cannot be used with the `zone=c` or `npc=c` parameters.

For this example, enter these commands.

```
ent-scr-blkdpc:sr=gws9:ni=c:nc=c:ncm=c:nsfi=cgpa:nsr=gw13
```

A message similar to the following should appear.

```
rlghncxa03w 05-09-25 15:28:30 GMT EAGLE5 34.0.0
ENT-SCR-BLKDPC: SCREEN SET AFFECTED - GWS9 1% FULL
ENT-SCR-BLKDPC: MASP A - COMPLTD
```

## Blocked Destination Point Code (BLKDPC) Screen Configuration

```
ent-scr-blkdpc:sr=gws9:ni=005:nc=005:ncm=005:nsfi=fail
```

A message similar to the following should appear.

```
rlghncxa03w 05-09-25 15:29:30 GMT EAGLE5 34.0.0
ENT-SCR-BLKDPC: SCREEN SET AFFECTED - GWS9 1% FULL
ENT-SCR-BLKDPC: MASP A - COMPLTD
```

```
ent-scr-blkdpc:sr=gw12:ni=c:nc=c:ncm=c:nsfi=cgpa:nsr=gw14
```

A message similar to the following should appear.

```
rlghncxa03w 05-09-25 15:30:30 GMT EAGLE5 34.0.0
ENT-SCR-BLKDPC: SCREEN SET AFFECTED - GW12 1% FULL
ENT-SCR-BLKDPC: MASP A - COMPLTD
```

```
ent-scr-blkdpc:sr=gw12:ni=004:nc=004:ncm=004:nsfi=fail
```

A message similar to the following should appear.

```
rlghncxa03w 05-09-25 15:31:30 GMT EAGLE5 34.0.0
ENT-SCR-BLKDPC: SCREEN SET AFFECTED - GW12 1% FULL
ENT-SCR-BLKDPC: MASP A - COMPLTD
```

- 
8. Verify the changes using the `rtrv-scr-blkdpc` command with the screening reference name used in step 7. For this example, enter these commands.

```
rtrv-scr-blkdpc:sr=gws9
```

The following is an example of the possible output.

```
rlghncxa03w 05-09-25 15:32:30 GMT EAGLE5 34.0.0
SCREEN = BLOCKED DPC
SR  NI      NC      NCM      NSFI     NSR/ACT
GWS9 C        C        C        CGPA     GW13
GWS9 005      005      005      FAIL     -----
```

```
rtrv-scr-blkdpc:sr=gw12
```

The following is an example of the possible output.

```
rlghncxa03w 05-09-25 15:33:30 GMT EAGLE5 34.0.0
SCREEN = BLOCKED DPC
SR  NI      NC      NCM      NSFI     NSR/ACT
GW12 C        C        C        CGPA     GW14
GW12 004      004      004      FAIL     -----
```

- 
9. Backup the new changes using the `chg-db:action=backup:dest=fixed` command. The following messages should appear, the active Maintenance and Administration Subsystem Processor (MASP) appears first.

```
BACKUP (FIXED) : MASP A - Backup starts on active MASP.
BACKUP (FIXED) : MASP A - Backup on active MASP to fixed disk complete.
BACKUP (FIXED) : MASP A - Backup starts on standby MASP.
BACKUP (FIXED) : MASP A - Backup on standby MASP to fixed disk complete.
```

---

## Blocked Destination Point Code (BLKDPC) Screen Configuration

**Flowchart 8-2.** Adding a Blocked DPC Screen (Sheet 1 of 5)

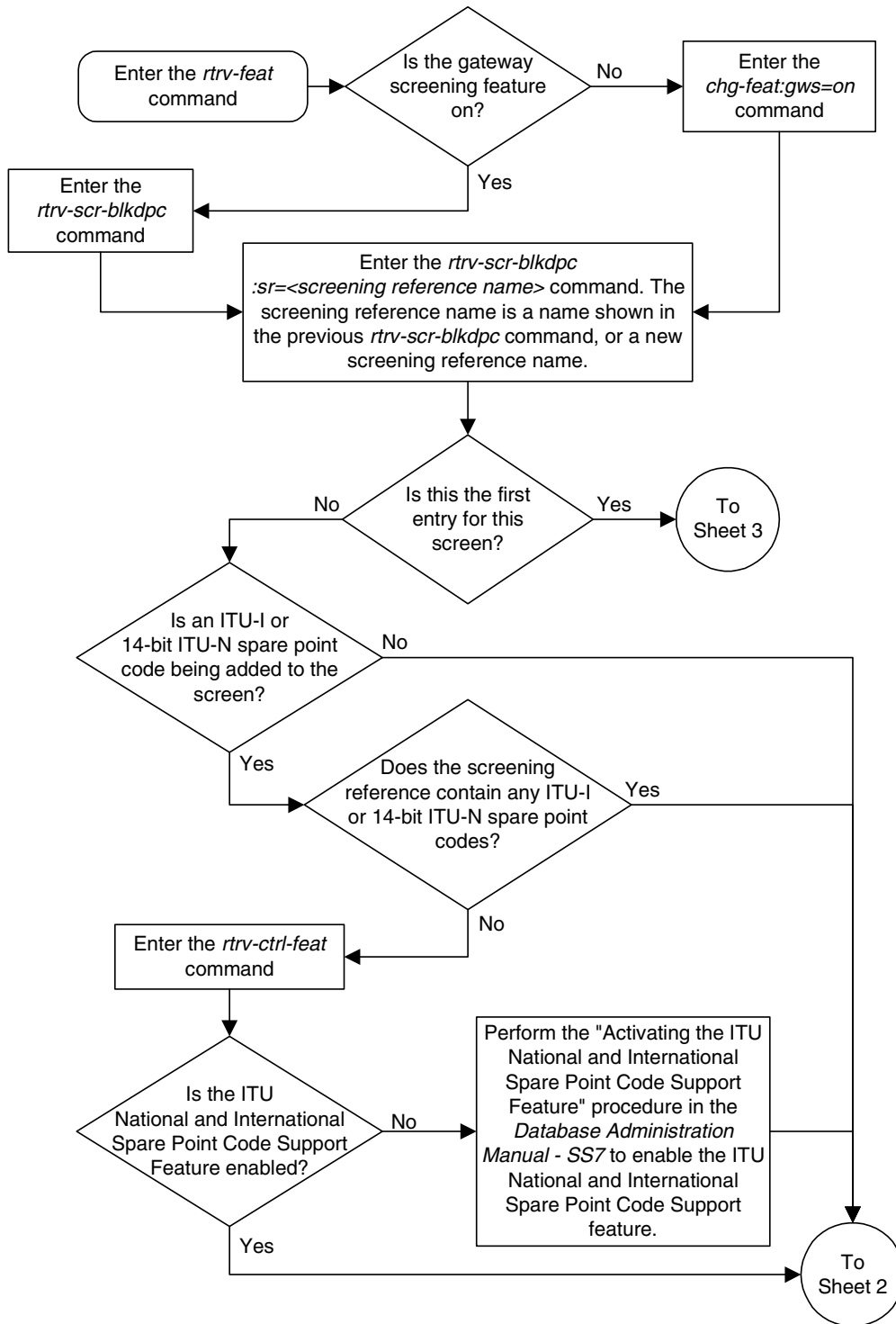

## Blocked Destination Point Code (BLKDPC) Screen Configuration

Flowchart 8-2. Adding a Blocked DPC Screen (Sheet 2 of 5)

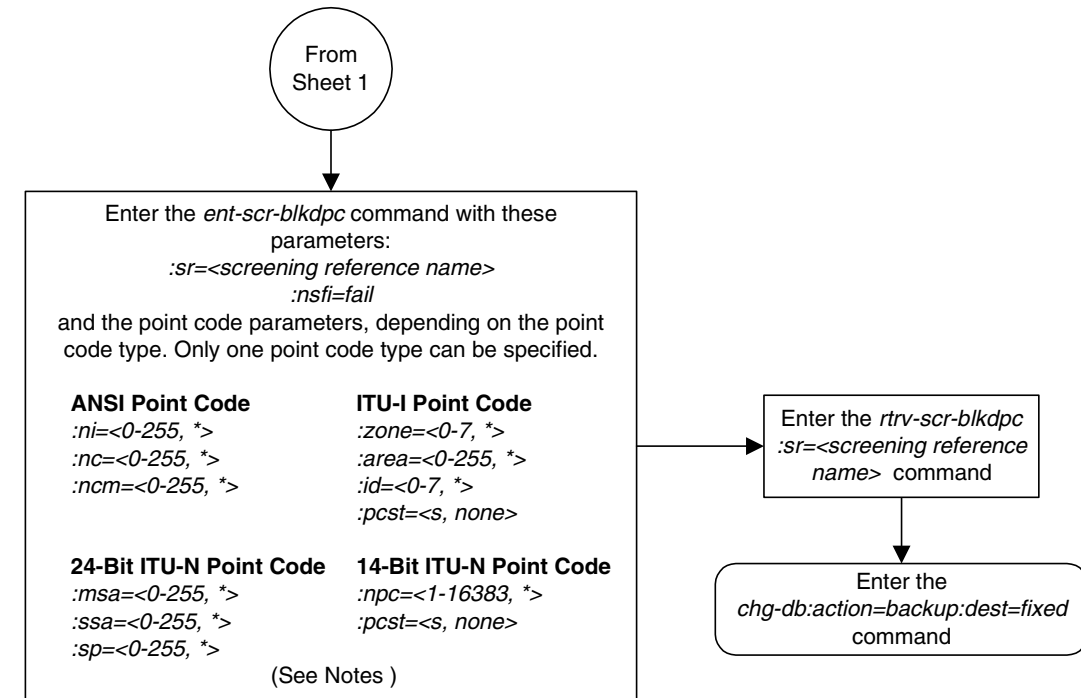

### Notes:

1. A range of values can be specified for the *ni*, *nc*, or *ncm* parameters by inserting double ampersands (&&) between the parameter values defining the range. For example, to specify the range 025 to 200 for the *ni* parameter, enter 025&&200 for the *ni* parameter value.
  2. The asterisk (\*) specifies the entire range of values for that parameter.
- For more information about specifying a range of values and about using the asterisk, see the "Gateway Screening Attributes" section in Chapter 2 and the "Specifying a Range of Values" section in this procedure.
3. To add a non-spare point code, the *pcst* parameter does not have to be specified. If the *pcst* parameter is specified for a screen containing an ITU-I or 14-bit ITU-N non-spare point code, the value must be *none*.
  4. To add a spare point code, the *pcst=s* parameter must be specified.

## Blocked Destination Point Code (BLKDPC) Screen Configuration

Flowchart 8-2. Adding a Blocked DPC Screen (Sheet 3 of 5)

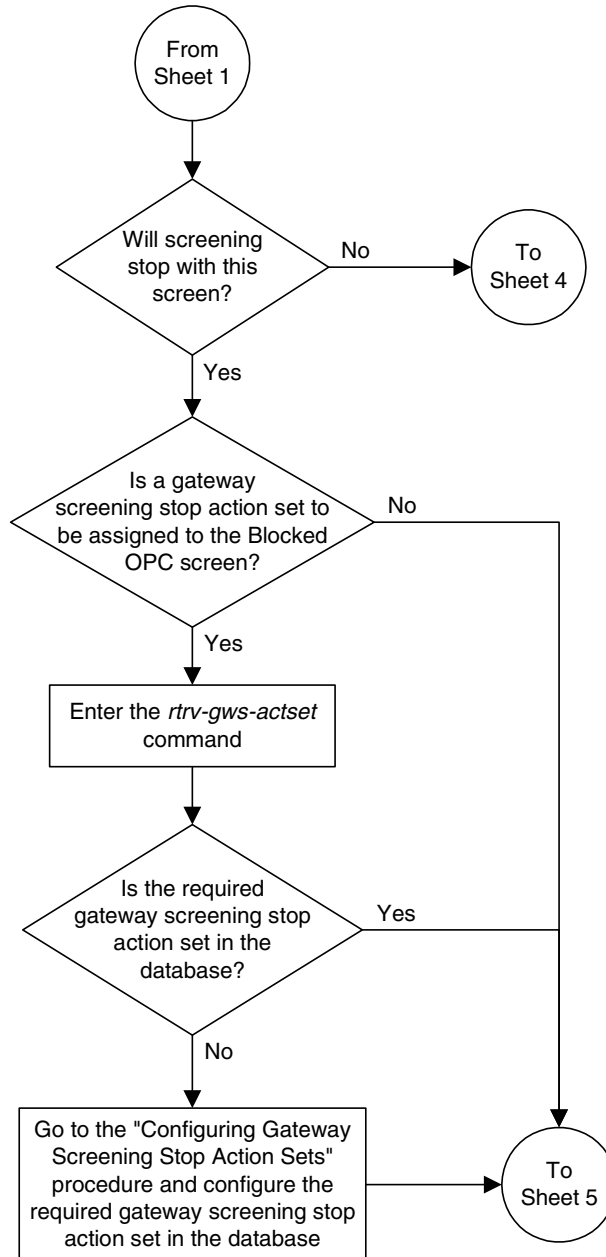

## Blocked Destination Point Code (BLKDPC) Screen Configuration

Flowchart 8-2. Adding a Blocked DPC Screen (Sheet 4 of 5)

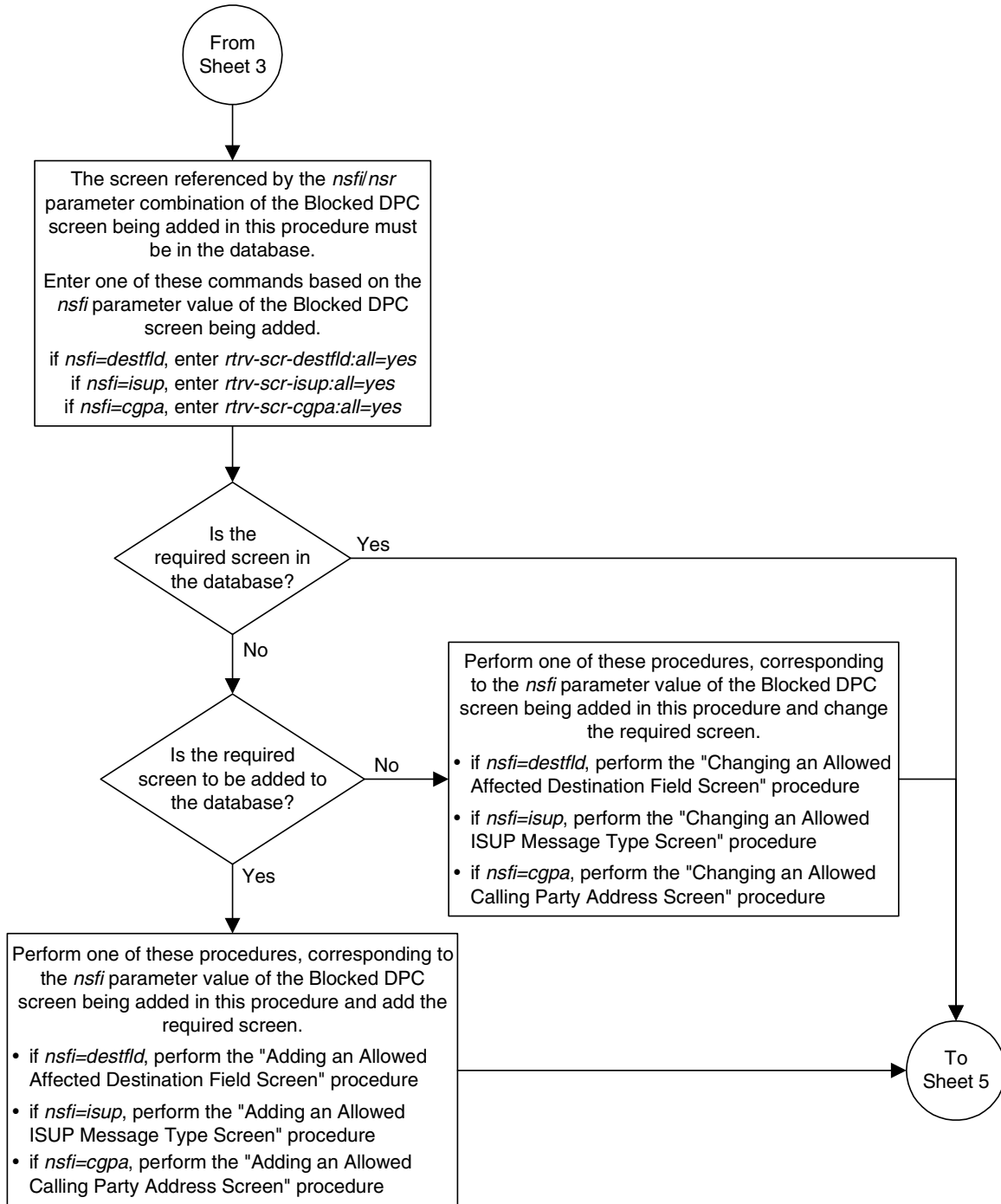

## Blocked Destination Point Code (BLKDPC) Screen Configuration

Flowchart 8-2. Adding a Blocked DPC Screen (Sheet 5 of 5)

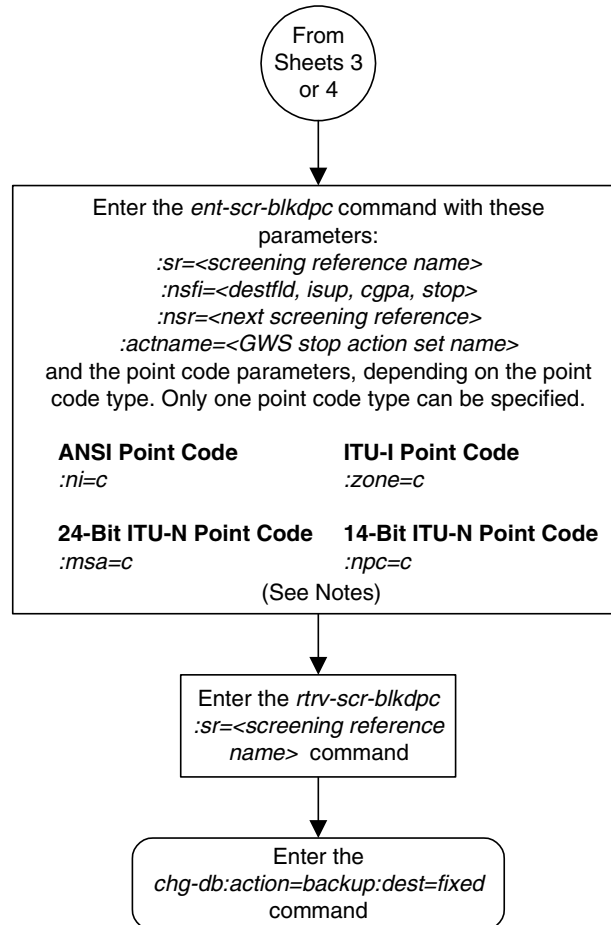

### Notes:

1. The *nsr* parameter can be specified only, and must be specified, if the *nsfi* parameter value is either *destfld*, *isup*, or *cgpa*.
2. The *actname* parameter is optional and can be specified only with the *nsfi=stop* parameter. If the *actname* parameter is specified, the *actname* parameter value is one of the gateway screening stop action set names shown in the *rtrv-gws-actset* output on Sheet 3.



### Removing a Blocked DPC Screen

This procedure is used to remove a blocked destination point code (DPC) screen from the database using the `dlt-scr-blkdpc` command. The parameters used by the `dlt-scr-blkdpc` command are shown in the “Gateway Screening Attributes” section on page 2-7. The general rules that apply to configuring gateway screening entities are shown in the “Gateway Screening Configuration” section on page 2-28.

The example in this procedure removes the blocked DPC screen `iec` with the point code 240-001-010 from the database.

**NOTE:** If you using multiple-part ITU national point codes with gateway screening, see “14-Bit ITU National Point Code Formats” on page 2-24.

The `c-c-c` entry cannot be removed from the blocked DPC screen unless all other entries in the blocked DPC screen have been removed. The `c-c-c` entry cannot be removed from the blocked DPC screen if other screens reference the blocked DPC screen. If the last entry (`c-c-c`) in the blocked DPC screen is removed, the blocked DPC screen is removed. The blocked DPC screen can be referenced by one of the following screens.

- Screen Set
- Allowed OPC
- Blocked OPC
- Allowed SIO
- Allowed DPC

Enter the following commands to verify that none of these screens reference the blocked DPC screen being removed from the database.

- `rtrv-scrset:nsfi=blkdpc`
- `rtrv-scr-opc:nsfi=blkdpc`
- `rtrv-scr-blkopc:nsfi=blkdpc`
- `rtrv-scr-sio:nsfi=blkdpc`
- `rtrv-scr-dpc:nsfi=blkdpc`

To change the NSFI of any of these screens, go to one of the following procedures.

- “Changing a Screen Set” procedure on page 13-15
- “Changing an Allowed OPC Screen” procedure on page 12-25
- “Changing a Blocked OPC Screen” procedure on page 11-26
- “Changing an Allowed SIO Screen” procedure on page 10-23
- “Changing an Allowed DPC Screen” procedure on page 9-26

## Procedure

---

1. Display the blocked DPC screens in the database using the **rtrv-scr-blkdpc** command. The following is an example of the possible output.

```
rlghncxa03w 05-09-25 15:25:30 GMT EAGLE5 34.0.0
SCREEN = BLOCKED DPC
SR   REF  RULES
IEC  YES   6
WRD2 YES   1
WRD3 NO    4
WRD4 YES   9
```

From the **rtrv-scr-blkdpc** output, display the blocked DPC screen you wish to remove using the **rtrv-scr-blkdpc** command with the screening reference name. For this example, enter this command.

```
rtrv-scr-blkdpc:sr=iec
```

The following is an example of the possible output.

```
rlghncxa03w 05-09-25 15:25:30 GMT EAGLE5 34.0.0
SCREEN = BLOCKED DPC
SR   NI      NC      NCM      NSFI      NSR/ACT
IEC  240     001     010     FAIL     -----
IEC  241     010     *       FAIL     -----

SR      NPC
IEC     00235
           NSFI      NSR/ACT
           FAIL     -----

SR      ZONE  AREA  ID      NSFI      NSR/ACT
IEC     1     003   4       FAIL     -----
IEC     1     003   5       FAIL     -----
IEC     C     C     C       CGPA     cg01
```

---

2. Enter the commands on page 8-21 to verify that the screen being removed is not referenced by other screens in the database. If the screen being removed is referenced by other screens, go to the procedures shown on page 8-21 and change the NSFI of those screens to reference other screens or change the NSFI of these screens to STOP.
- 

3. Remove the blocked DPC screen from the database using the **dlt-scr-blkdpc** command with the screening reference name shown in the **rtrv-scr-blkdpc** output in step 1 and with the point code parameter values (**ni**, **nc**, **ncm**, or **zone**, **area**, **id**, **npc**, **msa**, **ssa**, or **sp**) of the screen being removed from the database. The values for these parameters must be entered exactly as shown in the **rtrv-scr-blkdpc** output.

To remove an entry containing either an ITU-I or a 14-bit ITU-N spare point code, the **pcst=s** parameter must be specified with the **dlt-scr-blkdpc** command.

## Blocked Destination Point Code (BLKDPC) Screen Configuration

To remove an entry containing either an ITU-I or a 14-bit ITU-N non-spare point code, the **pcst** parameter does not have to be specified with the **dlt-scr-blkdpc** command. If the **pcst** parameter is specified, the value must be **none**.

The **pcst** parameter cannot be used with the **zone=c** or the **npc=c** parameters.

For this example, enter this command.

```
dlt-scr-blkdpc:sr=iec:ni=240:nc=001:ncm=010
```

A message similar to the following should appear.

```
rlghncxa03w 05-09-25 15:26:30 GMT EAGLE5 34.0.0
DLT-SCR-BLKDPC: SCREEN SET AFFECTED - IEC 25% FULL
DLT-SCR-BLKDPC: MASP A - COMPLTD
```

---

4. Verify the changes using the **rtrv-scr-blkdpc** command with the screening reference name used in step 3. For this example, enter this command.

```
rtrv-scr-blkdpc:sr=iec
```

The following is an example of the possible output.

```
rlghncxa03w 05-09-25 15:27:30 GMT EAGLE5 34.0.0
SCREEN = BLOCKED DPC
SR      NI      NC      NCM      NSFI      NSR/ACT
IEC     241      010      *        FAIL      -----

SR      NPC
IEC     00235
NSFI    NSR/ACT
FAIL    -----

SR      ZONE  AREA  ID      NSFI      NSR/ACT
IEC     1     003   4       FAIL      -----
IEC     1     003   5       FAIL      -----
IEC     C     C     C       CGPA     cg01
```

If the screen removed in step 3 was the last screen contained in the specified screening reference, the screening reference is removed from the database. The following message is displayed.

```
E2573 Cmd Rej: SR or NSR does not reference an existing SR
```

---

5. Backup the new changes using the **chg-db:action=backup:dest=fixed** command. The following messages should appear, the active Maintenance and Administration Subsystem Processor (MASP) appears first.

```
BACKUP (FIXED) : MASP A - Backup starts on active MASP.
BACKUP (FIXED) : MASP A - Backup on active MASP to fixed disk complete.
BACKUP (FIXED) : MASP A - Backup starts on standby MASP.
BACKUP (FIXED) : MASP A - Backup on standby MASP to fixed disk complete.
```

---

Flowchart 8-3. Removing a Blocked DPC Screen (Sheet 1 of 2)

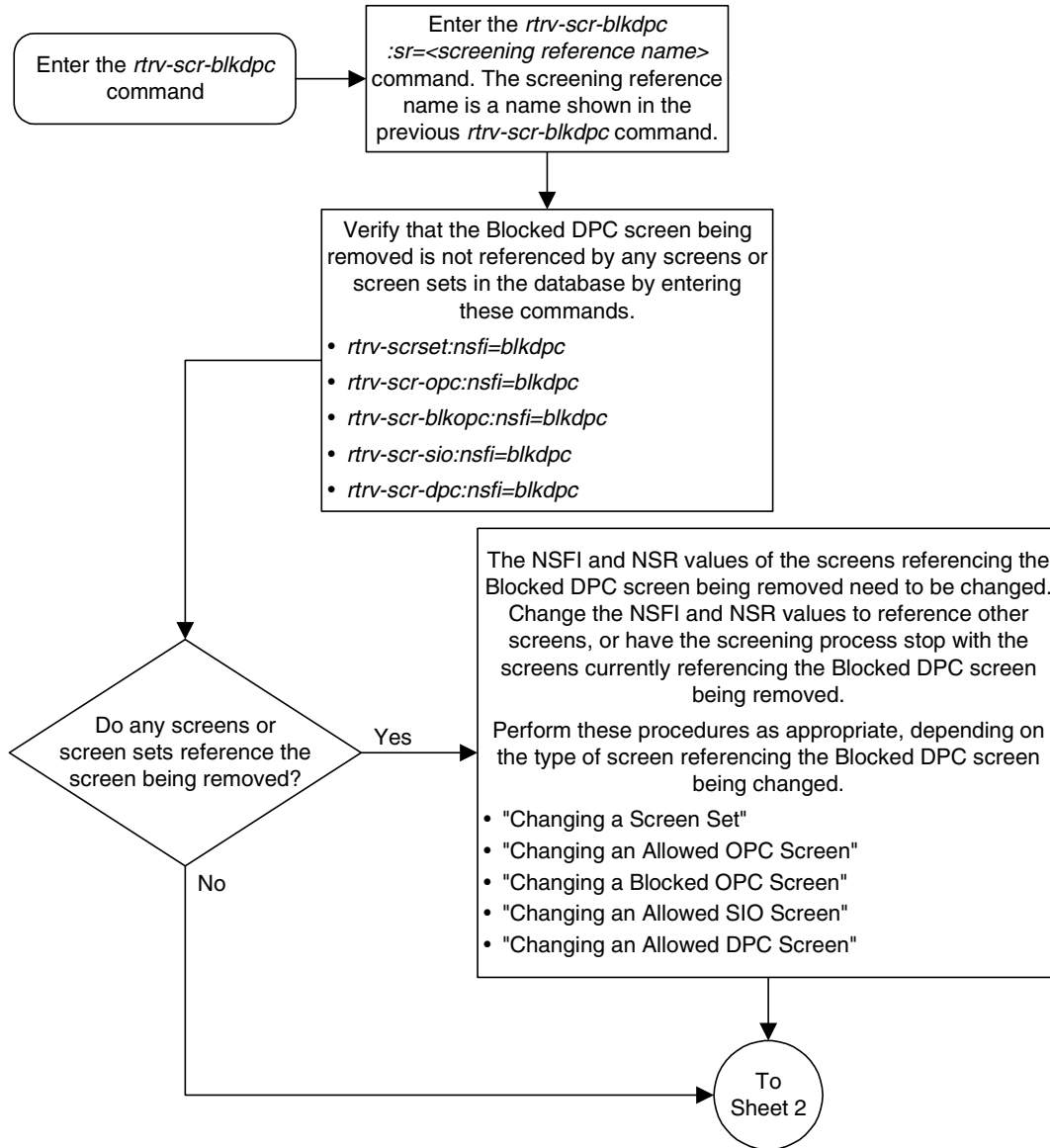

## Blocked Destination Point Code (BLKDPC) Screen Configuration

Flowchart 8-3. Removing a Blocked DPC Screen (Sheet 2 of 2)

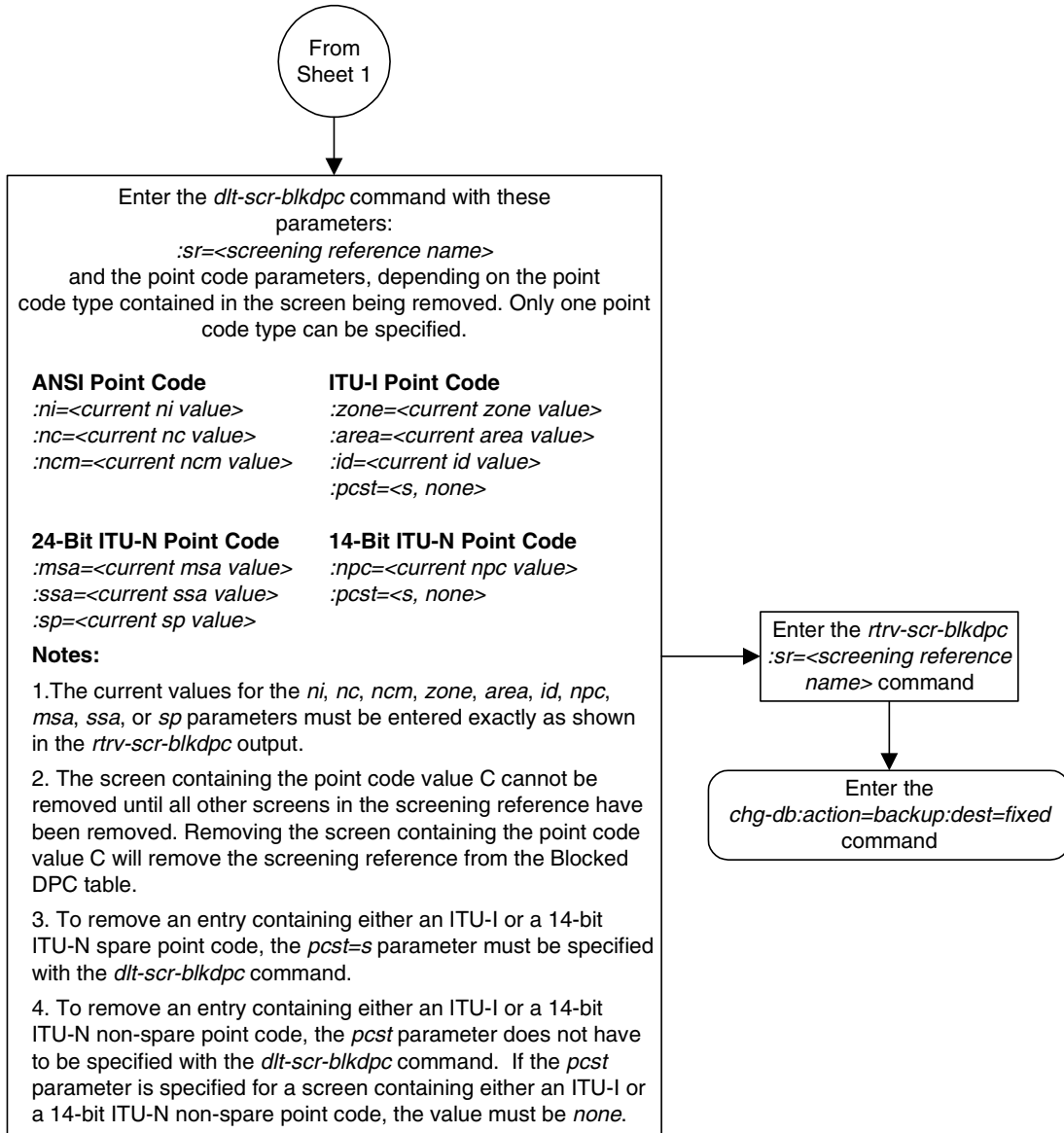

## Changing a Blocked DPC Screen

This procedure is used to change the attributes of a blocked destination point code (DPC) screen in the database using the `chg-scr-blkdpc` command. The parameters used by the `chg-scr-blkdpc` command are shown in the “Gateway Screening Attributes” section on page 2-7. The general rules that apply to configuring gateway screening entities are shown in the “Gateway Screening Configuration” section on page 2-28.

The example in this procedure is used to change the point code 003-003-003 for the blocked DPC screen `gw12` to 230-230-230.

**NOTE:** If you using multiple-part ITU national point codes with gateway screening, see “14-Bit ITU National Point Code Formats” on page 2-24.

If the current `ni`, `nc`, and `ncm` are equal to the character “`c`”, only the next screening function identifier and next screening reference can be changed. The next screening function identifier cannot be equal to `fail`. If the next screening function identifier is not equal to `stop`, the next screening reference must be specified. Otherwise, only the blocked DPC can be changed.

The blocked DPC screen can reference one of the following screens.

- Allowed Affected Destination Field
- Allowed CGPA
- Allowed ISUP

Enter the following commands to verify that these screens are in the database.

- `rtrv-scr-destfld:all=yes`
- `rtrv-scr-cgpa:all=yes`
- `rtrv-scr-isup:all=yes`

If the desired screen is not in the database, go to one of the following procedures and add the desired screen to the database or change an existing screen in the database.

- “Adding an Allowed Affected Destination Field Screen” procedure on page 7-7
- “Adding an Allowed Calling Party Address Screen” procedure on page 6-6
- “Adding an Allowed ISUP Message Type Screen” procedure on page 15-9
- “Changing an Allowed Affected Destination Field Screen” procedure on page 7-21
- “Changing an Allowed Calling Party Address Screen” procedure on page 6-23
- “Changing an Allowed ISUP Message Type Screen” procedure on page 15-20

## Blocked Destination Point Code (BLKDPC) Screen Configuration

If the NSFI is **stop**, the screening of the message will stop at the specified blocked DPC screen. If the NSFI is either **cgpa**, **destfld**, or **isup**, then any message containing a point code that is not listed in the blocked DPC screen with a NSFI equal to **fail**, will continue to be screened with either the allowed CGPA, allowed DESTFLD, or allowed ISUP screen. All subsequent entries for that screening reference must contain a numeric point code value, the NSFI must be equal to **fail**, and the **nsr** parameter cannot be specified. Any message that contains a DPC in the blocked DPC screen with the NSFI equal to **fail** will be rejected from the network and the screening process is stopped.

The **pcst** or **npcst** parameters, specifying whether or not the ITU-I or 14-bit ITU-N point code is a spare point code, cannot be used with the **zone=c** or **npc=c** parameters.

### Specifying a Range of Values

A range of values can be specified for the point code parameters **ni**, **nc**, or **ncm**.

If a range of values is specified for any of these parameters, and the value of the other parameters match existing values for the screening reference name, the range of values for the point code parameter cannot include any values for that parameter that are currently provisioned for the screening reference name.

For example, screening reference name **scr1** contains these entries:

SR	NI	NC	NCM	NSFI	NSR/ACT
SCR1	C	C	C	CGPA	cg01
SCR1	240	001	010	FAIL	-----
SCR1	241	010	020	FAIL	-----

Another entry for screening reference **scr1** with the **ni** value of 240 and the **nc** value of 001 cannot be specified if the range of values for the **ncm** parameter includes the value 010.

The ANSI point code parameter values can be specified as a single value, a range of values, or with an asterisk (\*). The asterisk specifies all possible values for the **ni**, **nc**, and **ncm** parameters. Table 8-5 shows the valid combinations of these parameter values.

**Table 8-5.** Valid Value Combinations for ANSI Point Code Parameters

NI	NC	NCM
Single Value	Single Value	Single Value
Single Value	Single Value	Range of Values
Single Value	Single Value	Asterisk
Single Value	Range of Values	Asterisk
Single Value	Asterisk	Asterisk
Range of Values	Asterisk	Asterisk
Asterisk	Asterisk	Asterisk

A range of values can also be specified for an ITU-I or 24-bit ITU-N point code parameter using a combination of asterisks (\*) and single values for the point code parameters. Table 8-3 shows the valid combinations of the ITU-I parameter values. Table 8-4 shows the valid combinations of the 24-bit ITU-N parameter values.

**Table 8-6.** Valid Value Combinations for ITU-I Point Code Parameters

ZONE	AREA	ID
Single Value	Single Value	Single Value
Single Value	Single Value	Asterisk
Single Value	Asterisk	Asterisk
Asterisk	Asterisk	Asterisk

**Table 8-7.** Valid Value Combinations for 24-Bit ITU-N Point Code Parameters

MSA	SSA	SP
Single Value	Single Value	Single Value
Single Value	Single Value	Asterisk
Single Value	Asterisk	Asterisk
Asterisk	Asterisk	Asterisk

## Procedure

---

1. Display the blocked DPC screens in the database using the `rtrv-scr-blkdpc` command. The following is an example of the possible output.

```
r1ghncxa03w 05-09-25 15:25:30 GMT EAGLE5 34.0.0
SCREEN = BLOCKED DPC
SR   REF  RULES
GW12 YES   2
IEC  YES   6
WRD2 YES   1
WRD3 NO    4
WRD4 YES   9
```

From the `rtrv-scr-blkdpc` output, display the blocked DPC screen you wish to change using the `rtrv-scr-blkdpc` command with the screening reference name. For this example, enter this command.

```
rtrv-scr-blkdpc:sr=gw12
```



## Blocked Destination Point Code (BLKDPC) Screen Configuration

The following is an example of the possible output.

```
rlghncxa03w 05-09-25 15:25:30 GMT EAGLE5 34.0.0
SCREEN = BLOCKED DPC
SR   NI      NC      NCM      NSFI      NSR/ACT
GW12 C        C        C        CGPA      GW14
GW12 003      003      003      FAIL      -----
```

If a gateway screening stop action set is to be assigned to the blocked DPC screen being changed in the database, go to step 2.

Step 2 verifies the gateway screening stop action set names in the database. The gateway screening stop action set names are assigned only if the NSFI of the screen being changed in this procedure is STOP. If the NSFI of the screen will be changed to STOP, but a gateway screening stop action set name will not be assigned to the screen, skip steps 2 and 3 and go to step 4. If the NSFI of the screen will not be STOP, skip step 2 and go to step 3.

- 
2. Display the gateway screening stop action sets in the database with the **rtrv-gws-actset** command. This is an example of the possible output.

```
rlghncxa03w 05-09-25 15:26:30 GMT EAGLE5 34.0.0
ACT  ACT    ACT  ACT  ACT  ACT  ACT  ACT  ACT  ACT  ACT  ACT
ID   NAME   1    2    3    4    5    6    7    8    9    10
--   -
1    copy   copy
2    rdct   rdct
3    cr     copy rdct
4    cnf    cnf
5    cpcnf  copy cnf
6    cnfrd  cnf rdct
7    cpcfrd copy cnf rdct
```

GWS action set table is (7 of 16) 44% full

If the required gateway screening stop action set is not in the database, go to the "Configuring Gateway Screening Stop Action Sets" procedure on page 2-54 and configure the required gateway screening stop action set.

---

**NOTE:** If the NSFI of the screen being changed in this procedure will be STOP or FAIL, or if the NSFI of the screen is not being changed, skip step 3 and go to step 4.

3. Enter the commands on page 8-26 to verify that the screen that will be specified by the NSFI/NSR parameter combination in step 5 is in the database.

If the desired screen is not in the database, go to one of the procedures shown on page 8-26 and either add the desired screen to the database or change an existing screen in the database.

---

**NOTE:** If any of these conditions apply to this procedure, skip this step and go to step 5:

- The point code in the screen is not being changed.
  - The screen being changed contains either an ANSI or 24-bit ITU-N point code.
  - The ITU-I or 14-bit ITU-N non-spare point code in the screen is not being changed to an ITU-I or 14-bit ITU-N spare point code.
  - The point code in the screen is an ITU-I or 14-bit ITU-N spare point code or the screening reference contains other screens with ITU-I or 14-bit ITU-N spare point codes.
4. Display the status of the ITU National and International Spare Point Code Support feature by entering the **rtrv-ctrl-feat** command with the ITU National and International Spare Point Code Support feature part number. Enter this command.

```
rtrv-ctrl-feat:partnum=893013601
```

This is an example of the possible output.

```
rlghncxa03w 05-09-25 15:25:30 GMT EAGLE5 34.0.0
The following features have been permanently enabled:
```

Feature Name	Partnum	Status	Quantity
Spare Point Code Support	893013601	on	----

The following features have been temporarily enabled:

Feature Name	Partnum	Status	Quantity	Trial Period Left
Zero entries found.				

The following features have expired temporary keys:

Feature Name	Partnum
Zero entries found.	

If the ITU National and International Spare Point Code Support feature is enabled, go to step 5.

If the ITU National and International Spare Point Code Support feature is not enabled, perform the “Activating the ITU National and International Spare Point Code Support Feature” procedure in the *Database Administration Manual - SS7* to enable the ITU National and International Spare Point Code Support feature as required. After the feature has been enabled, go to step 5.

5. Change the attributes of a blocked DPC screen using the **chg-scr-blkdpc** command.

If a gateway screening stop action is to be assigned to the blocked DPC screen being changed, enter the **chg-scr-blkdpc** command with the **nsfi=stop** parameter and the **actname** parameter with the name of a gateway screening stop action set shown in the output of the **rtrv-gws-actset** command executed in step 2.

## Blocked Destination Point Code (BLKDPC) Screen Configuration

The current values for the **ni**, **nc**, **ncm**, **zone**, **area**, **id**, **npc**, **msa**, **ssa**, and **sp** parameters must be entered exactly as shown in the **rtrv-scr-blkdpc** output in step 1.

The following list contains the values for the **nni**, **nnc**, **nncm**, **nzone**, **narea**, **nid**, **nnpc**, **nmsa**, **nssa**, and **nsp** parameters:

- **nni** – 0 - 255, c, or an asterisk (\*)
- **nnc** – 0 - 255, c, or an asterisk (\*)
- **nncm** – 0 - 255, c, or an asterisk (\*)
- **nzone** – 0 - 7, c, or an asterisk (\*)
- **narea** – 0 - 255, c, or an asterisk (\*)
- **nid** – 0 - 7, c, or an asterisk (\*)
- **nnpc** – 1 - 16383, c, or an asterisk (\*)
- **nmsa** – 0 - 255, c, or an asterisk (\*)
- **nssa** – 0 - 255, c, or an asterisk (\*)
- **nsp** – 0 - 255, c, or an asterisk (\*)

A range of values can be specified for the **nni**, **nnc**, and **nncm** parameters. See the “Specifying a Range of Values” section on page 8-27 for more information on how the asterisk and a range of values are used for the **nni**, **nnc**, and **nncm** parameters.

To change an ITU-I or 14-bit ITU-N spare point code to a non-spare point code, both the **pcst=s** and **npcst=none** parameters must be specified with the **chg-scr-blkdpc** command.

To change an ITU-I or 14-bit ITU-N non-spare point code to a spare point code, the **npcst=s** parameter must be specified with the **chg-scr-blkdpc** command. The **pcst** parameter does not have to be specified.

If the current point code in the screen being changed is either an ITU-I or 14-bit ITU-N spare point code, the **pcst=s** parameter must be specified with the **chg-scr-blkdpc** command.

If the current point code in the screen being changed is either an ITU-I or 14-bit ITU-N non-spare point code, the **pcst** parameter does not have to be specified with the **chg-scr-blkdpc** command. If the **pcst** parameter is specified for a screen containing either an ITU-I or 14-bit ITU-N non-spare point code, the **pcst** parameter value must be **none**.

The **pcst** or **npcst** parameters cannot be used with the **zone=c** or **npc=c** parameters.

For this example, enter this command.

```
chg-scr-blkdpc:sr=gw12:ni=003:nc=003:ncm=003:nni=230:nnc=230:nncm=230
```

The following messages appear.

```
rlghncxa03w 05-09-25 15:27:30 GMT EAGLE5 34.0.0
CHG-SCR-BLKDPC: SCREEN SET AFFECTED - GW12 1% FULL
CHG-SCR-BLKDPC: MASP A - COMPLTD
```

---

## Blocked Destination Point Code (BLKDPC) Screen Configuration

6. Verify the changes using the **rtrv-scr-blkdpc** command with the screening reference name used in step 5. For this example, enter this command.

```
rtrv-scr-blkdpc:sr=gw12
```

The following is an example of the possible output.

```
rlghncxa03w 05-09-25 15:28:30 GMT EAGLE5 34.0.0
SCREEN = BLOCKED DPC
SR      NI      NC      NCM      NSFI      NSR/ACT
GW12   C        C        C        CGPA      GW14
GW12   230      230      230      FAIL      -----
```

---

7. Backup the new changes using the **chg-db:action=backup:dest=fixed** command. The following messages should appear, the active Maintenance and Administration Subsystem Processor (MASP) appears first.

```
BACKUP (FIXED) : MASP A - Backup starts on active MASP.
BACKUP (FIXED) : MASP A - Backup on active MASP to fixed disk complete.
BACKUP (FIXED) : MASP A - Backup starts on standby MASP.
BACKUP (FIXED) : MASP A - Backup on standby MASP to fixed disk complete.
```

---

## Blocked Destination Point Code (BLKDPC) Screen Configuration

Flowchart 8-4. Changing a Blocked DPC Screen (Sheet 1 of 5)

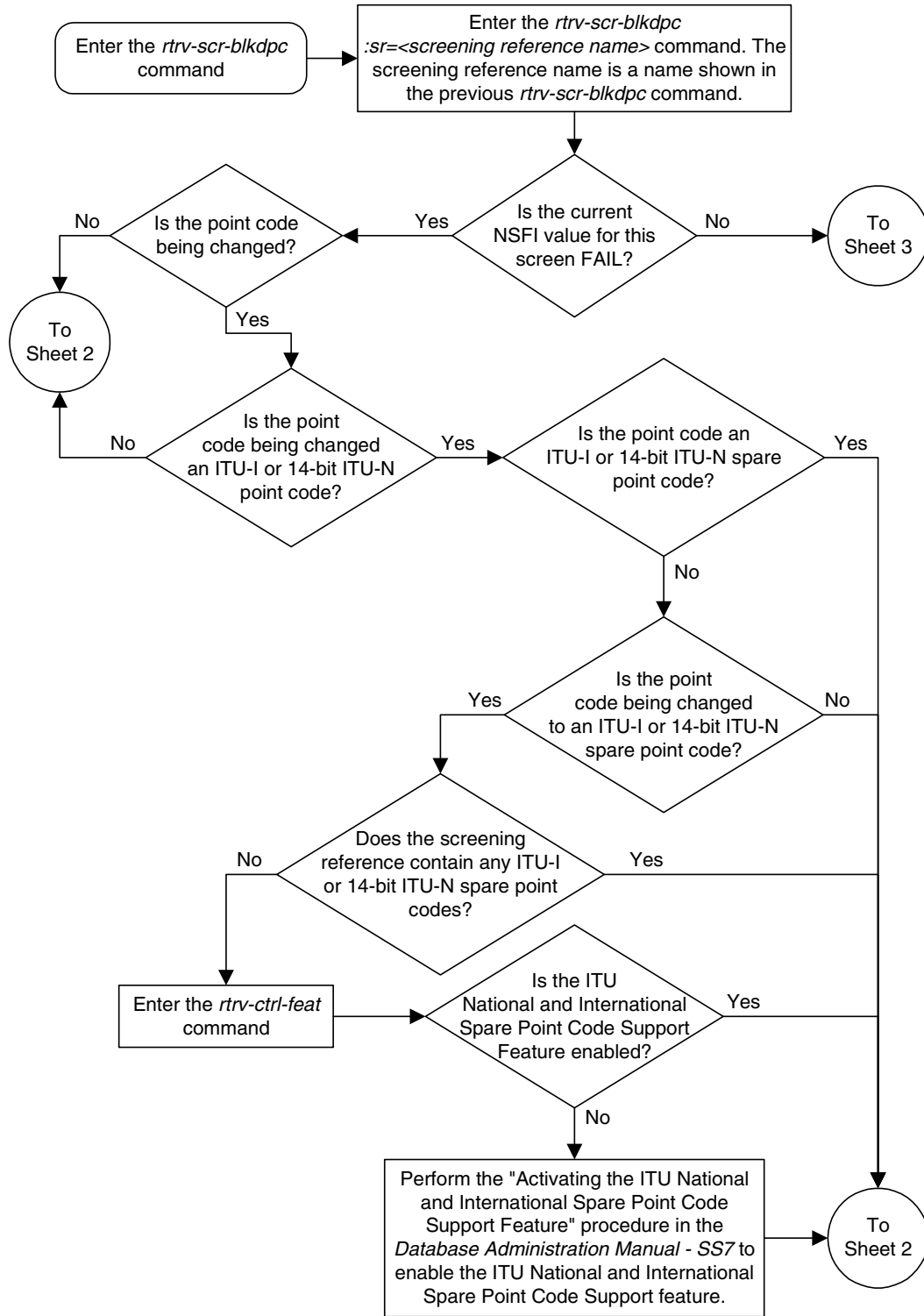

Flowchart 8-4. Changing a Blocked DPC Screen (Sheet 2 of 5)

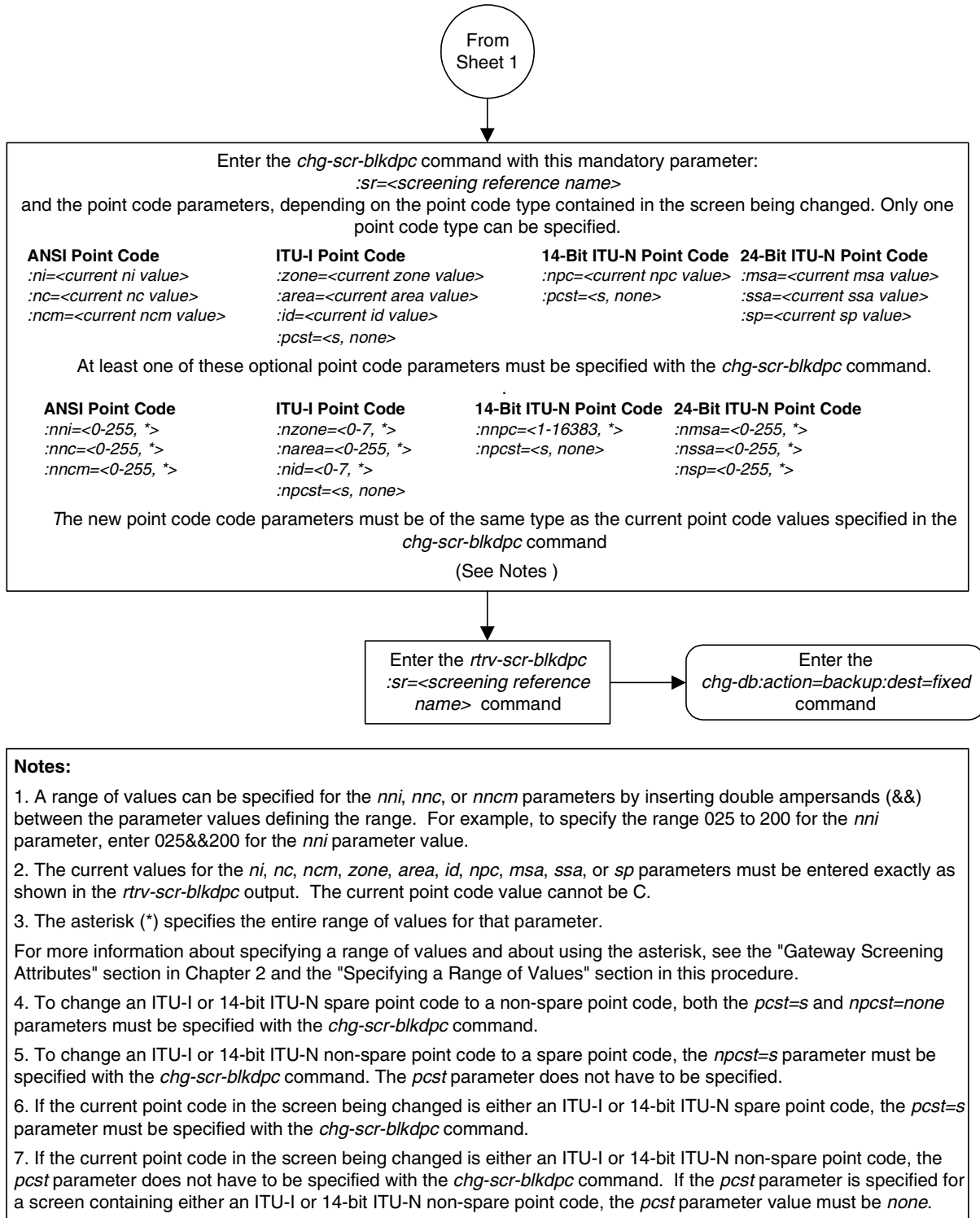

# Blocked Destination Point Code (BLKDPC) Screen Configuration

Flowchart 8-4. Changing a Blocked DPC Screen (Sheet 3 of 5)

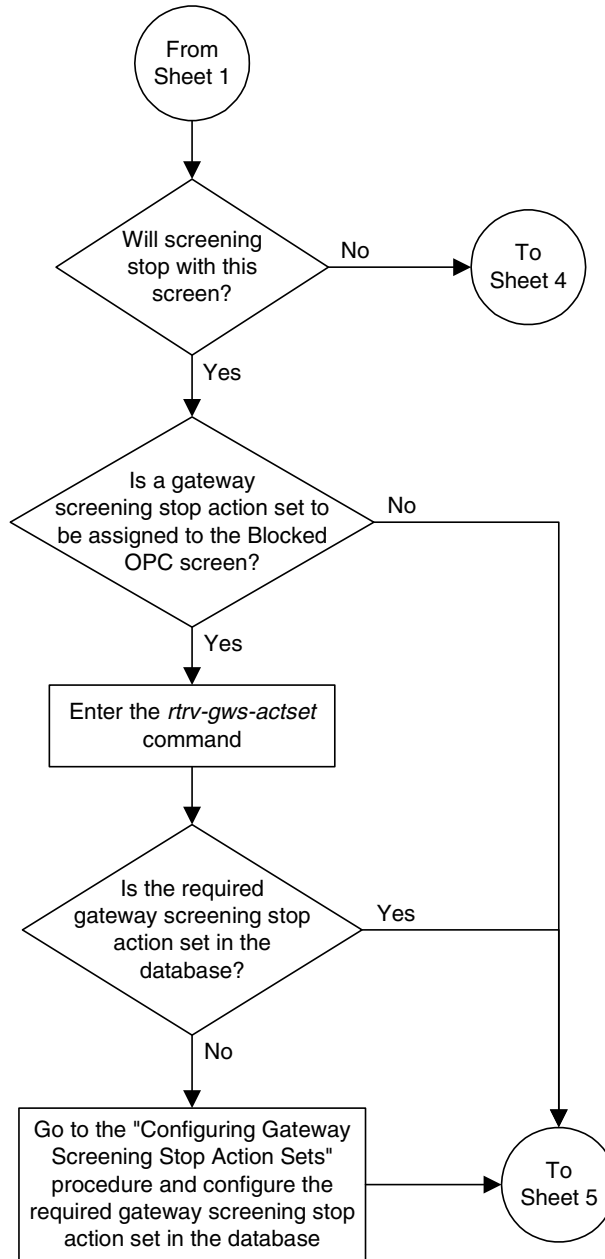

Flowchart 8-4. Changing a Blocked DPC Screen (Sheet 4 of 5)

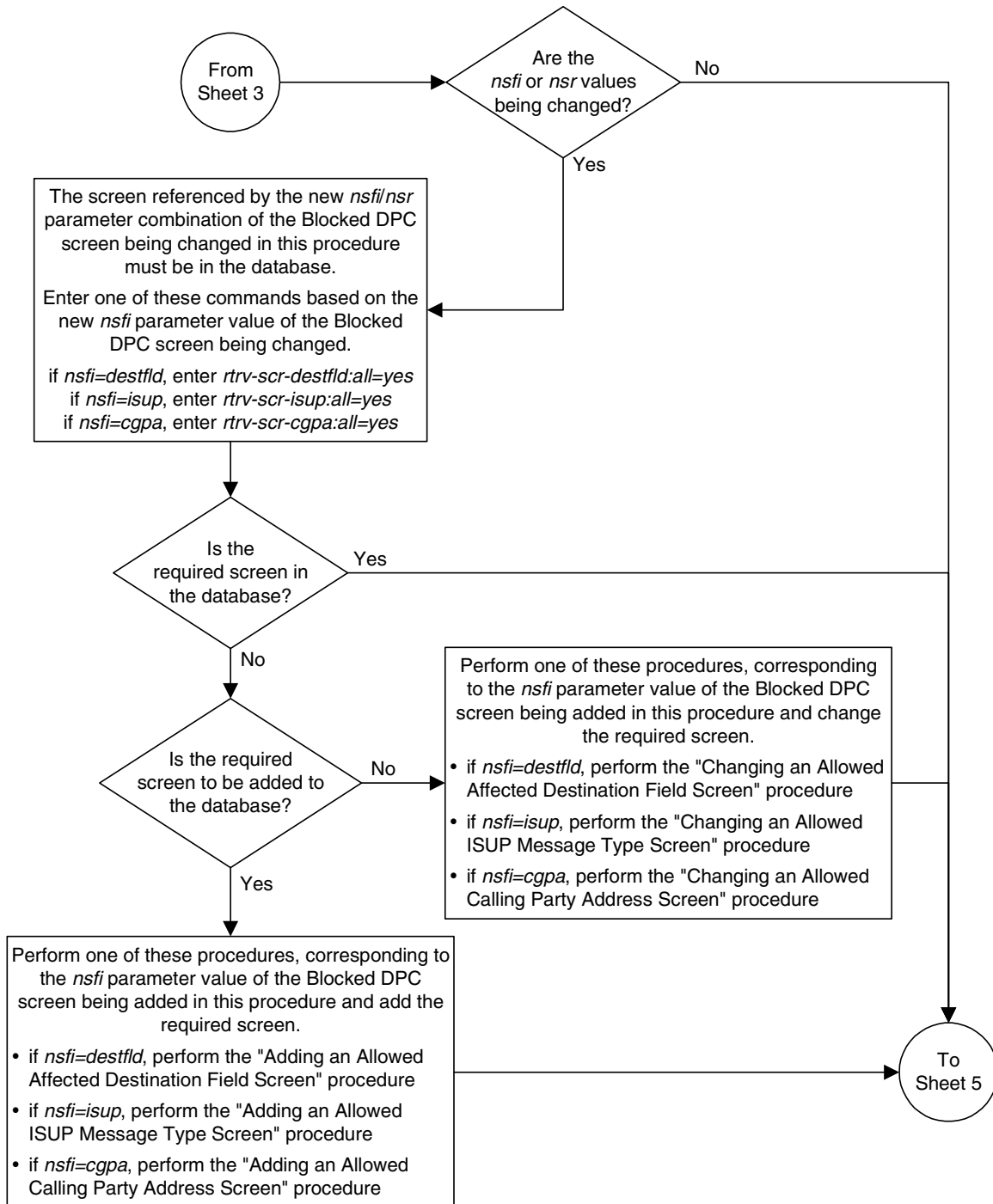



## Blocked Destination Point Code (BLKDPC) Screen Configuration

Flowchart 8-4. Changing a Blocked DPC Screen (Sheet 5 of 5)

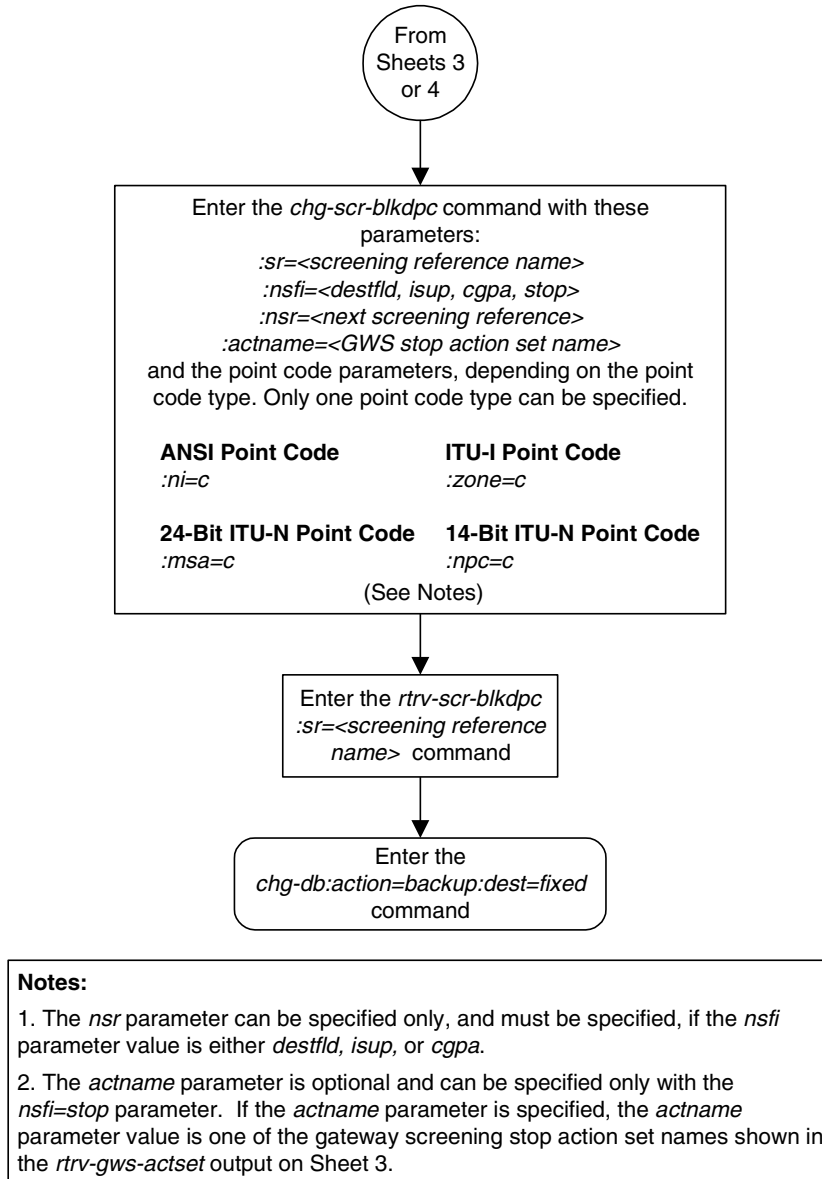

## Blocked Destination Point Code (BLKDPC) Screen Configuration

# 9

## Allowed Destination Point Code (DPC) Screen Configuration

Introduction.....	9-2
Adding an Allowed DPC Screen.....	9-8
Removing an Allowed DPC Screen .....	9-22
Changing an Allowed DPC Screen .....	9-26

## Introduction

The allowed destination point code (DPC) screen identifies a set of DPC's that are allowed to receive SS7 messages from another network. The gray shaded areas in Figure 9-1 shows the fields of the SS7 message that are checked by the allowed DPC screening function. If a match is found, the **nsfi** is examined to determine the next step in the screening process. If the **nsfi** is equal to **stop**, the message is processed and no further screening takes place.

If the **nsfi** is equal to **stop**, and the **copy** gateway screening stop action is specified, the message is processed and a copy of the message is sent by the STP LAN feature to an external application through an ACM running the **stplan** application or a DCM running the **vxwslan** application.

If the **nsfi** is equal to **stop**, and the **rdct** (redirect) gateway screening stop action is specified, the message is diverted from the original destination and sent to another destination with the Database Transport Access feature, specified by global title translation, for further processing.

If the Calling Name Conversion Facility (CNCF) feature is on, the **nsfi** is equal to **stop**, and the **cncf** gateway screening stop action is specified, the PIP parameter in the incoming ISUP IAM message is converted to the GN parameter. The GN parameter in the incoming ISUP IAM message is converted to the PIP parameter. The message is then sent to the node specified by the DPC in the routing label in the message. For more information on the Calling Name Conversion Facility feature, see Chapter 14, "Calling Name Conversion Facility (CNCF) Configuration."

If the Triggerless LNP (TLNP) feature is on, the **nsfi** is equal to **stop**, and the **tlnp** gateway screening stop action is specified, ISUP IAMs that pass gateway screening are processed either by the ISUP NP with EPAP feature (if the ISUP NP with EPAP feature is enabled and turned on) or by the Triggerless LNP feature (if the Triggerless LNP feature is turned on). The ISUP NP with EPAP feature is discussed in more detail in the *Feature Manual - G-Port*. The Triggerless LNP feature is discussed in more detail in the *LNP Feature Activation Guide*.

If the **nsfi** is equal to anything else, the next screening reference (**nsr**) is identified and the screening process continues to the next screen identified by the **nsfi** and **nsr** parameters. If no match is found, the message is discarded.

Flowchart 9-1 shows the screening action of the allowed DPC screen.

# Allowed Destination Point Code (DPC) Screen Configuration

Flowchart 9-1. Allowed DPC Screening Action (Sheet 1 of 4)

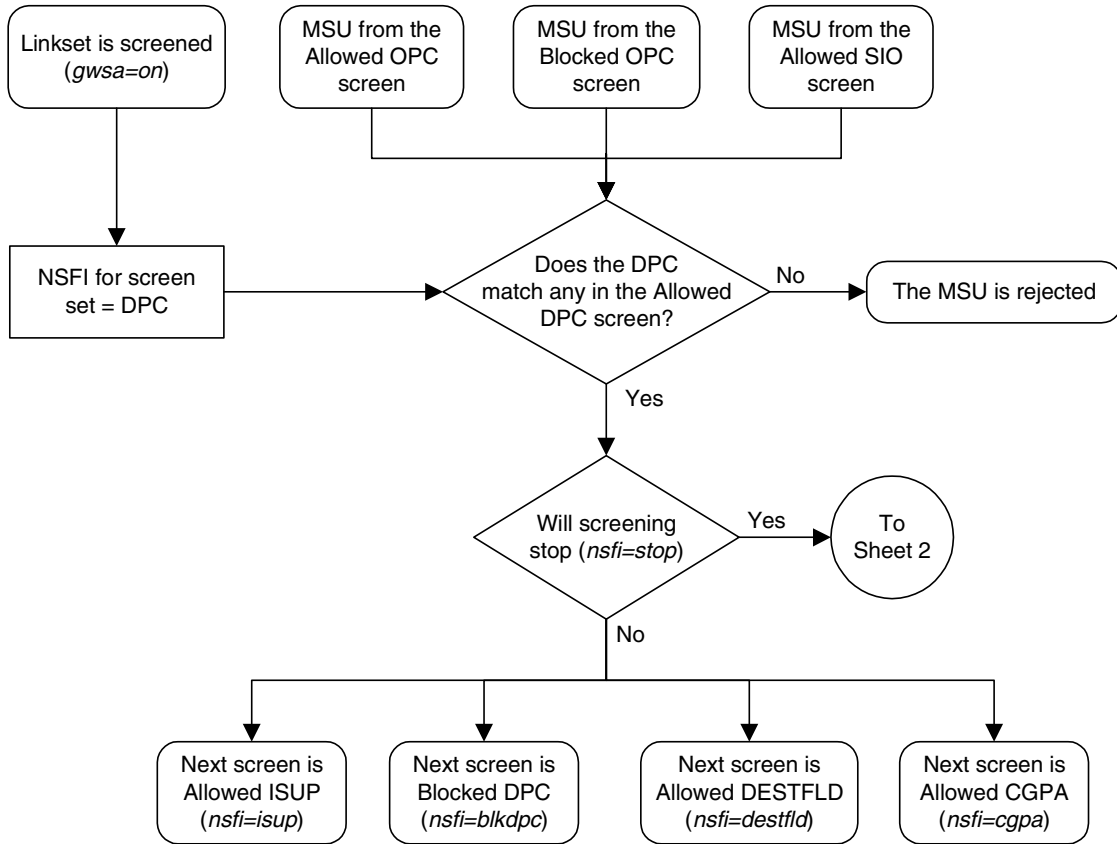

Flowchart 9-1. Allowed DPC Screening Action (Sheet 2 of 4)

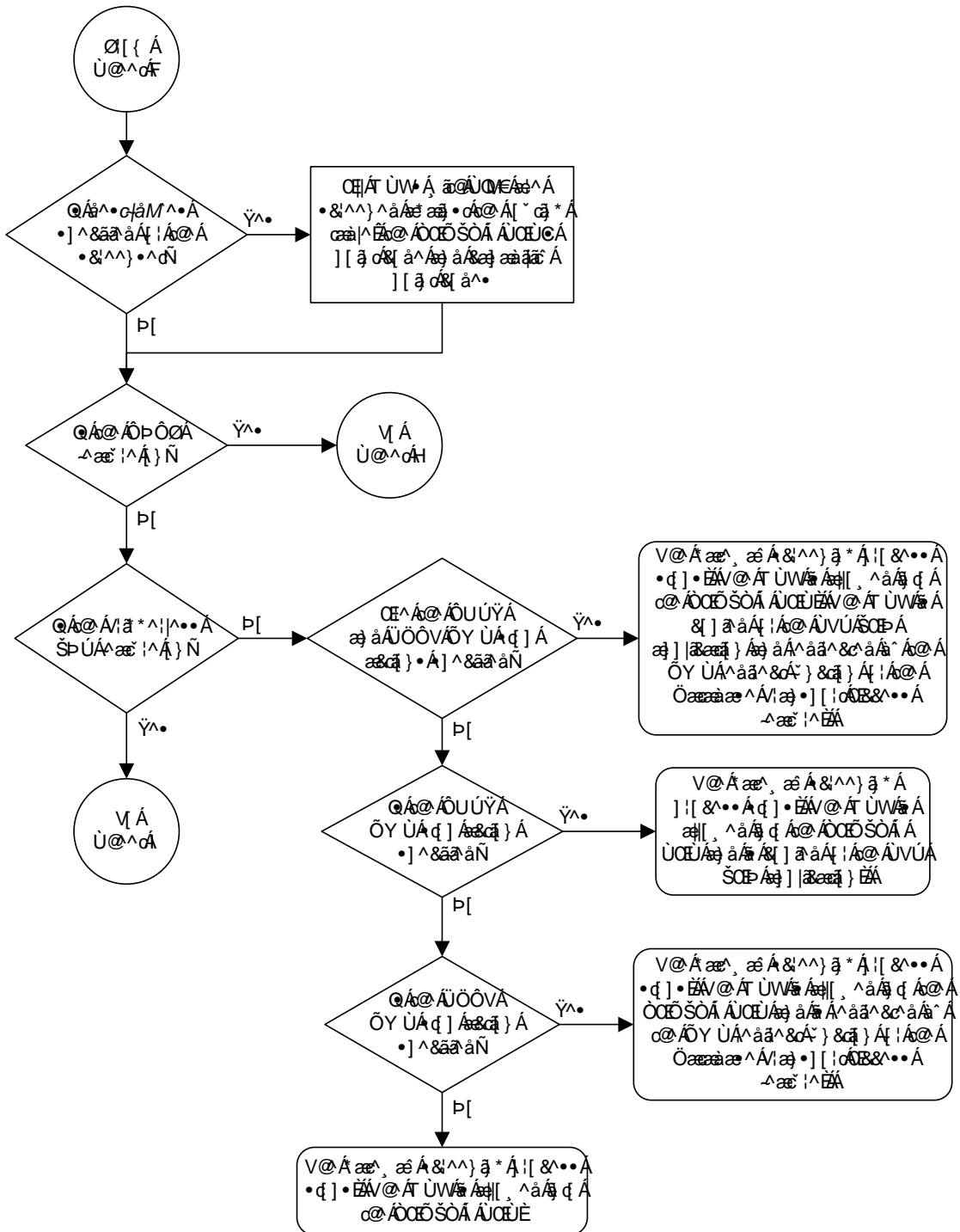

Allowed Destination Point Code (DPC) Screen Configuration

Flowchart 9-1. Allowed DPC Screening Action (Sheet 3 of 4)

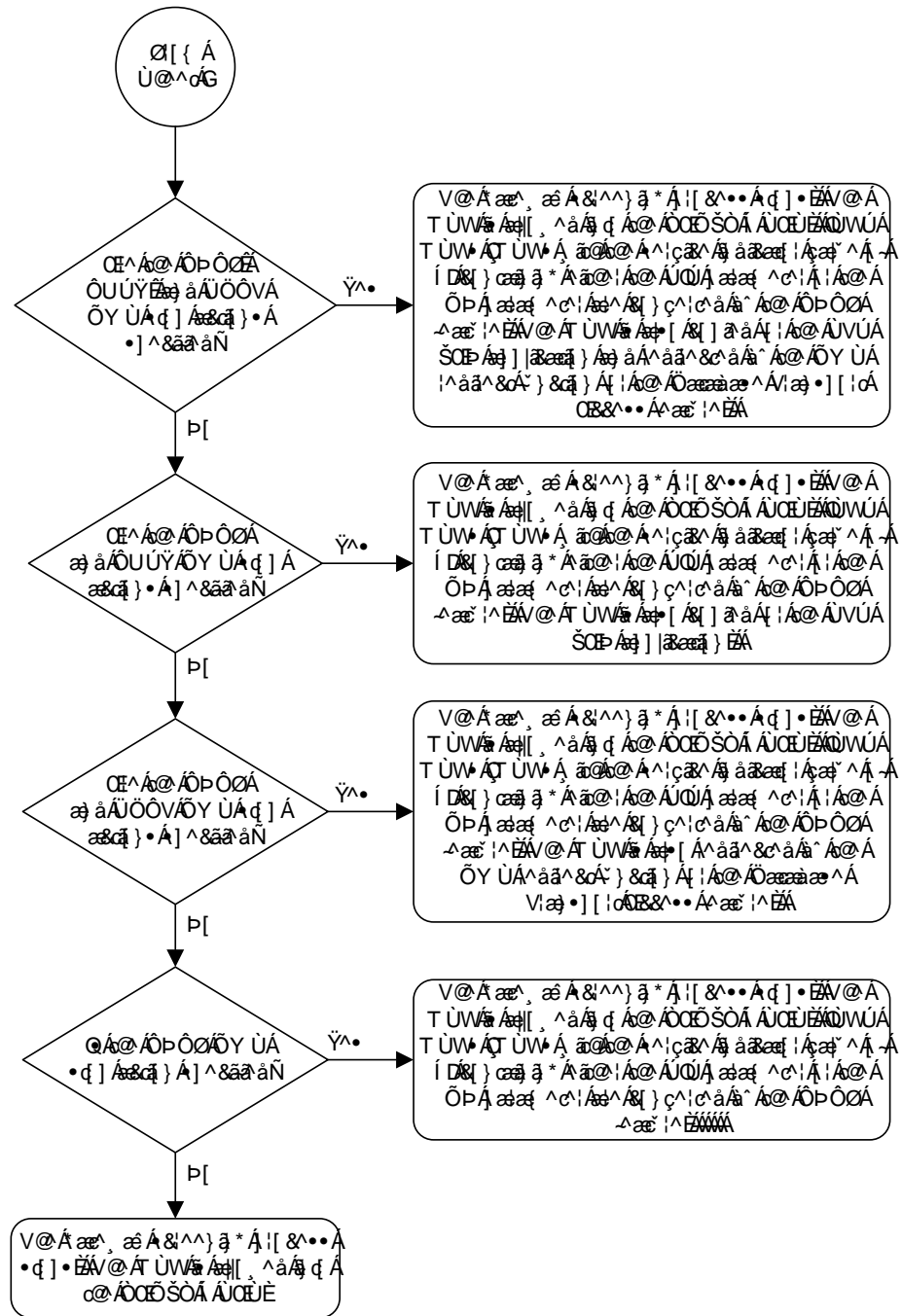

Flowchart 9-1. Allowed DPC Screening Action (Sheet 4 of 4)

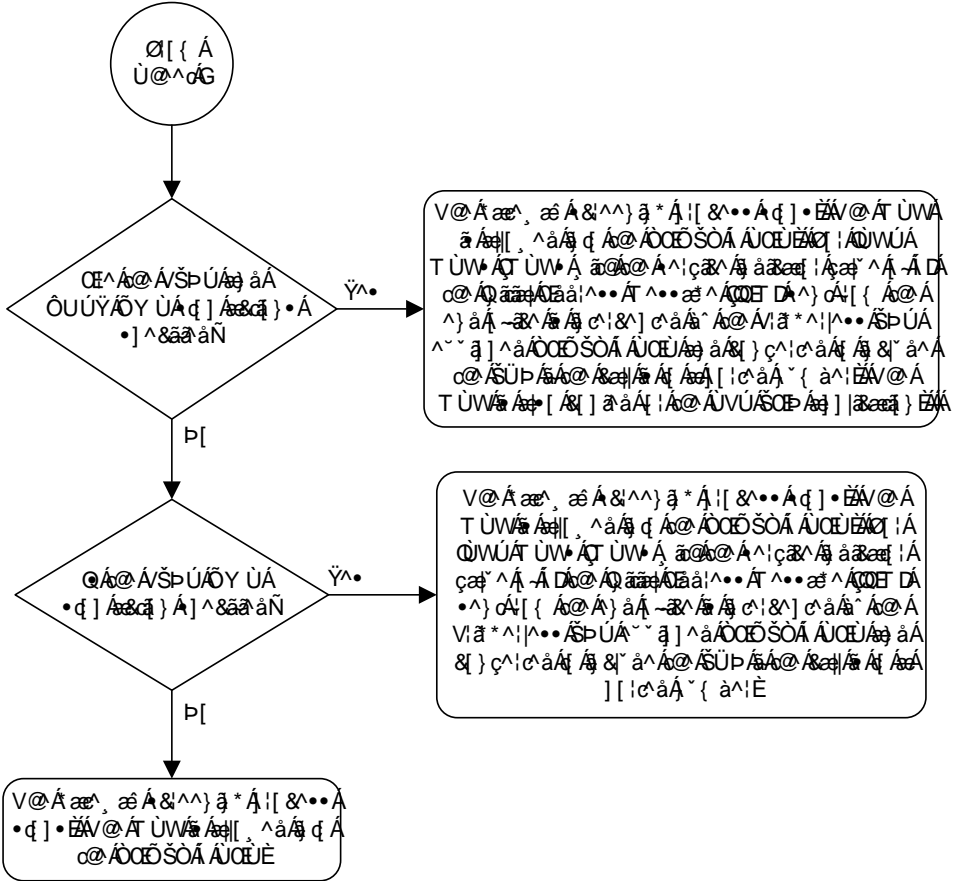



# Allowed Destination Point Code (DPC) Screen Configuration

Figure 9-1. Allowed DPC Screening Functions

ANSI MSU (ANSI Message Signal Unit)

BSN FSN LI	SIO xx xx xxxx NIC PRI SI	SIF		
		Routing Label		SLS
		DPC NCM NC NI	OPC NCM NC NI	xx

ITU-I MSU (ITU International Message Signal Unit)

BSN FSN LI	SIO xx xx xxxx NIC PRI SI	SIF		
		Routing Label		SLS
		DPC ID AREA ZONE	OPC ID AREA ZONE	xx

14-Bit ITU-N MSU (14-Bit ITU National Message Signal Unit)

BSN FSN LI	SIO xx xx xxxx NIC PRI SI	SIF		
		Routing Label		SLS
		DPC NPC	OPC NPC	xx

24-Bit ITU-N MSU (24-Bit ITU National Message Signal Unit)

BSN FSN LI	SIO xx xx xxxx NIC PRI SI	SIF		
		Routing Label		SLS
		DPC SP SSA MSA	OPC SP SSA MSA	xx

## Adding an Allowed DPC Screen

This procedure is used to add an allowed destination point code (DPC) screen to the database using the `ent-scr-dpc` command. The parameters used by the `ent-scr-dpc` command are shown in the “Gateway Screening Attributes” section on page 2-7. The general rules that apply to configuring gateway screening entities are shown in the “Gateway Screening Configuration” section on page 2-28.

The examples in this procedure are used to add the allowed DPC screen data shown in Table 9-1 and based on the example configurations shown in Figure 2-3 on page 2-33, Figure 2-5 on page 2-37, and Figure 2-9 on page 2-45.

**Table 9-1.** Example Gateway Screening Allowed DPC Configuration Table

Screening Reference	NI	NC	NCM	NSFI	NSR
gws9	003	003	003	blkdpc	gw12
iec	070	070	025&&135	blkdpc	gws9
isp2	073	200	059	isup	isp2
tup1	050	034	049	isup	tup1

**NOTE:** If you using multiple-part ITU national point codes with gateway screening, see “14-Bit ITU National Point Code Formats” on page 2-24.

The allowed DPC screen can reference one of the following screens.

- Blocked DPC
- Allowed Affected Destination Field
- Allowed CGPA
- Allowed ISUP

Enter the following commands to verify that these screens are in the database.

- `rtrv-scr-blkdpc:all=yes`
- `rtrv-scr-destfld:all=yes`
- `rtrv-scr-cgpa:all=yes`
- `rtrv-scr-isup:all=yes`

If the desired screen is not in the database, go to one of the following procedures and add the desired screen to the database or change an existing screen in the database.

- “Adding a Blocked DPC Screen” procedure on page 8-8
- “Adding an Allowed Affected Destination Field Screen” procedure on page 7-7

## Allowed Destination Point Code (DPC) Screen Configuration

- “Adding an Allowed Calling Party Address Screen” procedure on page 6-6
- “Adding an Allowed ISUP Message Type Screen” procedure on page 15-9
- “Changing a Blocked DPC Screen” procedure on page 8-26
- “Changing an Allowed Affected Destination Field Screen” procedure on page 7-21
- “Changing an Allowed Calling Party Address Screen” procedure on page 6-23
- “Changing an Allowed ISUP Message Type Screen” procedure on page 15-20

### Specifying a Range of Values

A range of values can be specified for the point code parameters **ni**, **nc**, or **ncm**.

If a range of values is specified for any of these parameters, and the value of the other parameters match existing values for the screening reference name, the range of values for the point code parameter cannot include any values for that parameter that are currently provisioned for the screening reference name.

For example, screening reference name **scr1** contains these entries:

SR	NI	NC	NCM	NSFI	NSR/ACT
SCR1	240	001	010	CGPA	-----
SCR1	241	010	020	STOP	-----

Another entry for screening reference **scr1** with the **ni** value of 240 and the **nc** value of 001 cannot be specified if the range of values for the **ncm** parameter includes the value 010.

The ANSI point code parameter values can be specified as a single value, a range of values, or with an asterisk (\*). The asterisk specifies all possible values for the **ni**, **nc**, and **ncm** parameters. Table 9-2 shows the valid combinations of these parameter values.

**Table 9-2.** Valid Value Combinations for ANSI Point Code Parameters

NI	NC	NCM
Single Value	Single Value	Single Value
Single Value	Single Value	Range of Values
Single Value	Single Value	Asterisk
Single Value	Range of Values	Asterisk
Single Value	Asterisk	Asterisk
Range of Values	Asterisk	Asterisk
Asterisk	Asterisk	Asterisk

A range of values can also be specified for an ITU-I or 24-bit ITU-N point code parameter using a combination of asterisks (\*) and single values for the point code parameters. Table 9-3 shows the valid combinations of the ITU-I parameter values. Table 9-4 shows the valid combinations of the 24-bit ITU-N parameter values.

**Table 9-3.** Valid Value Combinations for ITU-I Point Code Parameters

ZONE	AREA	ID
Single Value	Single Value	Single Value
Single Value	Single Value	Asterisk
Single Value	Asterisk	Asterisk
Asterisk	Asterisk	Asterisk

**Table 9-4.** Valid Value Combinations for 24-Bit ITU-N Point Code Parameters

MSA	SSA	SP
Single Value	Single Value	Single Value
Single Value	Single Value	Asterisk
Single Value	Asterisk	Asterisk
Asterisk	Asterisk	Asterisk

### Procedure

---

1. Verify that the gateway screening feature is on, by entering the `rtrv-feat` command. If the gateway screening feature is on, the `GWS` field is set to `on`.

**NOTE:** The `rtrv-feat` command output contains other fields that are not used by this procedure. If you wish to see all the fields displayed by the `rtrv-feat` command, see the `rtrv-feat` command description in the *Commands Manual*.

If the gateway screening feature is on, shown by the entry `GWS = on` in the `rtrv-feat` command output, skip step 2, and go to step 3.

---

2. Turn the gateway screening feature on by entering this command.

`chg-feat:gws=on`

**NOTE:** Once the gateway screening feature is turned on with the `chg-feat` command, it cannot be turned off.

## Allowed Destination Point Code (DPC) Screen Configuration

**NOTE:** The gateway screening feature must be purchased before you turn this feature on with the `chg-feat` command. If you are not sure if you have purchased the gateway screening feature, contact your Tekelec Sales Representative or Account Representative.

When the `chg-feat` has successfully completed, this message should appear.

```
rlghncxa03w 05-09-28 11:43:04 GMT EAGLE5 34.0.0
CHG-FEAT: MASP A - COMPLTD
```

---

3. Display all allowed DPC screens in the database using the `rtrv-scr-dpc` command. The following is an example of the possible output.

```
rlghncxa03w 05-09-25 15:25:30 GMT EAGLE5 34.0.0
SCREEN = ALLOWED DPC
SR   REF  RULES
IEC  YES   6
WRD2 YES   1
WRD4 YES   9
```

If the screening reference names that you wish to add with this procedure are not shown in the `rtrv-scr-dpc` command output, go to step 2. For this example, the screening reference names are not shown. If these screening reference names are shown in the `rtrv-scr-dpc` command output, make sure the screening data you wish to enter is not already in the database by entering the `rtrv-scr-dpc` command with the screening reference name. For example, enter the `rtrv-scr-dpc:sr=iec` command.

The following is an example of the possible output.

```
rlghncxa03w 05-09-25 15:26:30 GMT EAGLE5 34.0.0
SCREEN = ALLOWED DPC
SR   NI      NC      NCM      NSFI      NSR/ACT
IEC  240      001      010      STOP      -----
IEC  241      010      *        CGPA      cg04

SR   NPC
IEC  00235
IEC  00240

SR   ZONE  AREA  ID      NSFI      NSR/ACT
IEC  1      003   4      BLKDPC   blk1
IEC  1      003   5      STOP     -----
```

If a gateway screening stop action set is to be assigned to the allowed DPC screen being added to the database, go to step 4.

Step 4 verifies the gateway screening stop action set names in the database. The gateway screening stop action set names are assigned only if the NSFI of the screen being added in this procedure is STOP. If the NSFI of the new screen will be STOP, but a gateway screening stop action set name will not be assigned to the new screen, skip steps 4, 5, and 6 and go to step 7. If the NSFI of the new screen is not STOP, skip step 4 and 5, and go to step 6.

---

- Display the gateway screening stop action sets in the database with the `rtrv-gws-actset` command. This is an example of the possible output.

```
rlghncxa03w 05-09-25 15:27:30 GMT EAGLE5 34.0.0
ACT ACT ACT ACT ACT ACT ACT ACT ACT ACT ACT
ID NAME 1 2 3 4 5 6 7 8 9 10
-----
1 copy copy
2 rdct rdct
3 cr copy rdct
4 cncf cncf
5 cpcncf copy cncf
6 cncfrd cncf rdct
7 cpcfrd copy cncf rdct
```

GWS action set table is (7 of 16) 44% full

If the required gateway screening stop action set is not in the database, go to the “Configuring Gateway Screening Stop Action Sets” procedure on page 2-54 and configure the required gateway screening stop action set.

---

**NOTE:** If the gateway screening stop action set being assigned to the Allowed DPC screen does not contain the redirect stop action, skip step 5 and go to step 6.

- Verify the EAGLE 5 SAS’s point code by entering the `rtrv-sid` command. The following is an example of the possible output.

```
rlghncxa03w 05-09-10 11:43:04 GMT EAGLE5 34.0.0
PCA PCI PCN CLLI PCTYPE
100-100-100 3-75-7 7-9-8-1 rlghncxa03w OTHER

CPCA
002-002-002 002-002-003 002-002-004 002-002-005
002-002-006 002-002-007 002-002-008 002-002-009
004-002-001 004-003-003 050-060-070

CPCA (LNP)
005-005-002 005-005-004 005-005-005 006-006-006

CPCI
1-002-1 1-002-2 1-002-3 1-002-4
2-001-1 7-222-7

CPCN
2-0-10-3 2-0-11-0 2-0-11-2 2-0-12-1
2-2-3-3 2-2-4-0 10-14-10-1
```



**CAUTION:** Redirecting SLTA/SLTM messages prevents SLTA/SLTM messages from being returned to the EAGLE 5 SAS. The signaling link carrying these messages will fail if these messages are not returned to the EAGLE 5 SAS. To prevent SLTA/SLTM messages from being redirected, gateway screening stop action sets containing the redirect stop action should not be assigned to Allowed DPC screens containing the EAGLE 5 SAS’s point code.

---

## Allowed Destination Point Code (DPC) Screen Configuration

**NOTE:** If the NSFI of the screen being added in this procedure is STOP, skip step 6 and go to step 7.

6. Enter the commands on page 9-8 to verify that the screen that will be specified by the NSFI/NSR parameter combination in step 8 is in the database.

If the desired screen is not in the database, go to one of the procedures shown on page 9-8 and either add the desired screen to the database or change an existing screen in the database.

---

**NOTE:** If the point code being added in this procedure is not an ITU-I or 14-bit ITU-N spare point code, skip this step and to to step 8.

**NOTE:** If the point code being added in this procedure is an ITU-I or 14-bit ITU-N spare point code and the screening reference contains ITU-I or 14-bit ITU-N spare point codes, skip this step and go to step 8.

7. Display the status of the ITU National and International Spare Point Code Support feature by entering the `rtrv-ctrl-feat` command with the ITU National and International Spare Point Code Support feature part number. Enter this command.

`rtrv-ctrl-feat:partnum=893013601`

This is an example of the possible output.

```
rlghncxa03w 05-09-25 15:25:30 GMT EAGLE5 34.0.0
The following features have been permanently enabled:
```

Feature Name	Partnum	Status	Quantity
Spare Point Code Support	893013601	on	----

The following features have been temporarily enabled:

Feature Name	Partnum	Status	Quantity	Trial Period Left
Zero entries found.				

The following features have expired temporary keys:

Feature Name	Partnum
Zero entries found.	

If the ITU National and International Spare Point Code Support feature is enabled, go to step 8.

If the ITU National and International Spare Point Code Support feature is not enabled, perform the "Activating the ITU National and International Spare Point Code Support Feature" procedure in the *Database Administration Manual - SS7* to enable the ITU National and International Spare Point Code Support feature as required. After the feature has been enabled, go to step 8.

---

8. Add a new allowed DPC screen to the database using the `ent-scr-dpc` command.

If a gateway screening stop action is to be assigned to the allowed DPC screen being added, enter the `ent-scr-dpc` command with the `nsfi=stop` parameter and the `actname` parameter with the name of a gateway screening stop action set shown in the output of the `rtrv-gws-actset` command executed in step 4.



**CAUTION:** Redirecting SLTA/SLTM messages prevents SLTA/SLTM messages from being returned to the EAGLE 5 SAS. The signaling link carrying these messages will fail if these messages are not returned to the EAGLE 5 SAS. To prevent SLTA/SLTM messages from being redirected, gateway screening stop action sets containing the redirect stop action should not be assigned to Allowed DPC screens containing the EAGLE 5 SAS's point code, shown in step 5.

The following list contains the values for `ni`, `nc`, `ncm`, `zone`, `area`, `id`, `npc`, `msa`, `ssa`, and `sp` parameters:

- `ni` – 0 - 255 or an asterisk (\*)
- `nc` – 0 - 255 or an asterisk (\*)
- `ncm` – 0 - 255 or an asterisk (\*)
- `zone` – 0 - 7 or an asterisk (\*)
- `area` – 0 - 255 or an asterisk (\*)
- `id` – 0 - 7 or an asterisk (\*)
- `npc` – 1 - 16383 or an asterisk (\*)
- `msa` – 0 - 255 or an asterisk (\*)
- `ssa` – 0 - 255 or an asterisk (\*)
- `sp` – 0 - 255 or an asterisk (\*)

A range of values can be specified for the `ni`, `nc`, and `ncm` parameters. See the "Specifying a Range of Values" section on page 9-9 for more information on how the asterisk and a range of values are used for the `ni`, `nc`, and `ncm` parameters.

To add a spare point code to the allowed DPC screen, the `pcst=s` parameter must be specified. To add a non-spare point code to the allowed DPC screen, the `pcst` parameter does not have to be specified. If the `pcst` parameter is specified for a screen containing an ITU-I or 14-bit ITU-N non-spare point code, the value must be `none`.



## Allowed Destination Point Code (DPC) Screen Configuration

For this example, enter these commands.

```
ent-scr-dpc:sr=gws9:ni=003:nc=003:ncm=003:nsfi=blkdpc:nsr=gw12
```

A message similar to the following should appear.

```
rlghncxa03w 05-09-25 15:28:30 GMT EAGLE5 34.0.0
ENT-SCR-DPC: SCREEN SET AFFECTED - GWS9 1% FULL
ENT-SCR-DPC: MASP A - COMPLTD
```

```
ent-scr-dpc:sr=isp2:ni=073:nc=200:ncm=059:nsfi=isup:nsr=isp2
```

A message similar to the following should appear.

```
rlghncxa03w 05-09-25 15:29:30 GMT EAGLE5 34.0.0
ENT-SCR-DPC: SCREEN SET AFFECTED - ISP2 1% FULL
ENT-SCR-DPC: MASP A - COMPLTD
```

```
ent-scr-dpc:sr=tup1:ni=050:nc=034:ncm=059:nsfi=isup:nsr=tup1
```

A message similar to the following should appear.

```
rlghncxa03w 05-09-25 15:29:30 GMT EAGLE5 34.0.0
ENT-SCR-DPC: SCREEN SET AFFECTED - TUP1 1% FULL
ENT-SCR-DPC: MASP A - COMPLTD
```

```
ent-scr-dpc:sr=iec:ni=070:nc=070:ncm=025&&135:nsfi=blkdpc
:nsr=gws9
```

A message similar to the following should appear.

```
rlghncxa03w 05-09-25 15:29:30 GMT EAGLE5 34.0.0
ENT-SCR-DPC: SCREEN SET AFFECTED - IEC 1% FULL
ENT-SCR-DPC: MASP A - COMPLTD
```

- 
9. Verify the changes using the **rtrv-scr-dpc** command with the screening reference name used in step 8. For this example, enter these commands.

```
rtrv-scr-dpc:sr=gws9
```

The following is an example of the possible output.

```
rlghncxa03w 05-09-25 15:30:30 GMT EAGLE5 34.0.0
SCREEN = ALLOWED DPC
SR   NI      NC      NCM      NSFI     NSR/ACT
GWS9 003      003      003      BLKDPC   GW12
```

```
rtrv-scr-dpc:sr=iec
```

The following is an example of the possible output.

```
rlghncxa03w 05-09-25 15:31:30 GMT EAGLE5 34.0.0
SCREEN = ALLOWED DPC
SR   NI      NC      NCM      NSFI     NSR/ACT
IEC  070      070      025&&135 BLKDPC   GWS9
```

```
rtrv-scr-dpc:sr=isp2
```

The following is an example of the possible output.

```
rlghncxa03w 05-09-25 15:31:30 GMT EAGLE5 34.0.0
SCREEN = ALLOWED DPC
SR   NI      NC      NCM      NSFI     NSR/ACT
ISP2 073      200      059      ISUP     ISP2
```

## Allowed Destination Point Code (DPC) Screen Configuration

```
rtrv-scr-dpc:sr=tup1
```

The following is an example of the possible output.

```
rlghncxa03w 05-09-25 15:31:30 GMT EAGLE5 34.0.0
SCREEN = ALLOWED DPC
SR      NI      NC      NCM      NSFI      NSR/ACT
TUP1   050      034      049      ISUP      TUP1
```

---

10. Backup the new changes using the **chg-db:action=backup:dest=fixed** command. The following messages should appear, the active Maintenance and Administration Subsystem Processor (MASP) appears first.

```
BACKUP (FIXED) : MASP A - Backup starts on active MASP.
BACKUP (FIXED) : MASP A - Backup on active MASP to fixed disk complete.
BACKUP (FIXED) : MASP A - Backup starts on standby MASP.
BACKUP (FIXED) : MASP A - Backup on standby MASP to fixed disk complete.
```

---

# Allowed Destination Point Code (DPC) Screen Configuration

Flowchart 9-2. Adding an Allowed DPC Screen (Sheet 1 of 5)

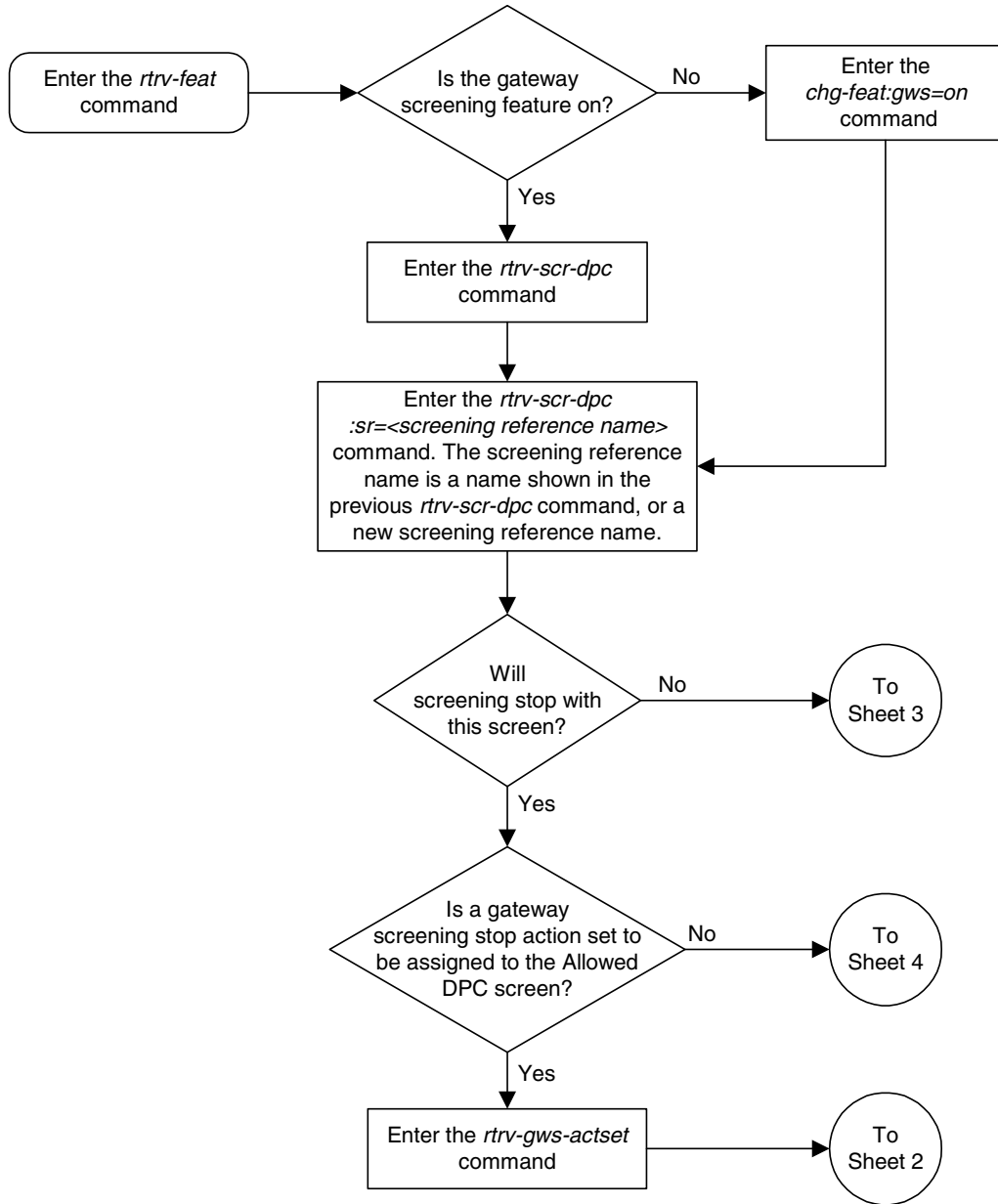



## Allowed Destination Point Code (DPC) Screen Configuration

Flowchart 9-2. Adding an Allowed DPC Screen (Sheet 3 of 5)

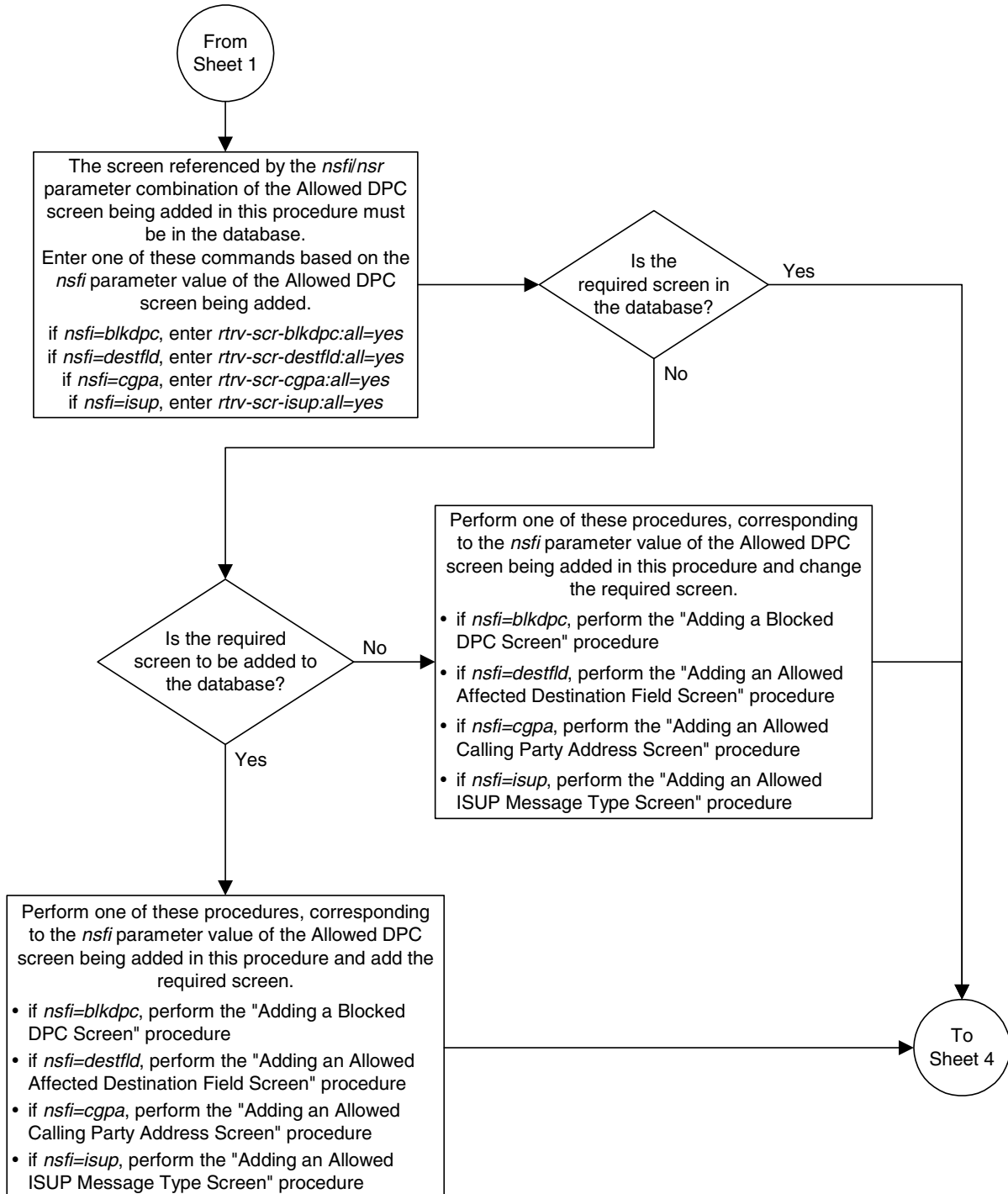

Flowchart 9-2. Adding an Allowed DPC Screen (Sheet 4 of 5)

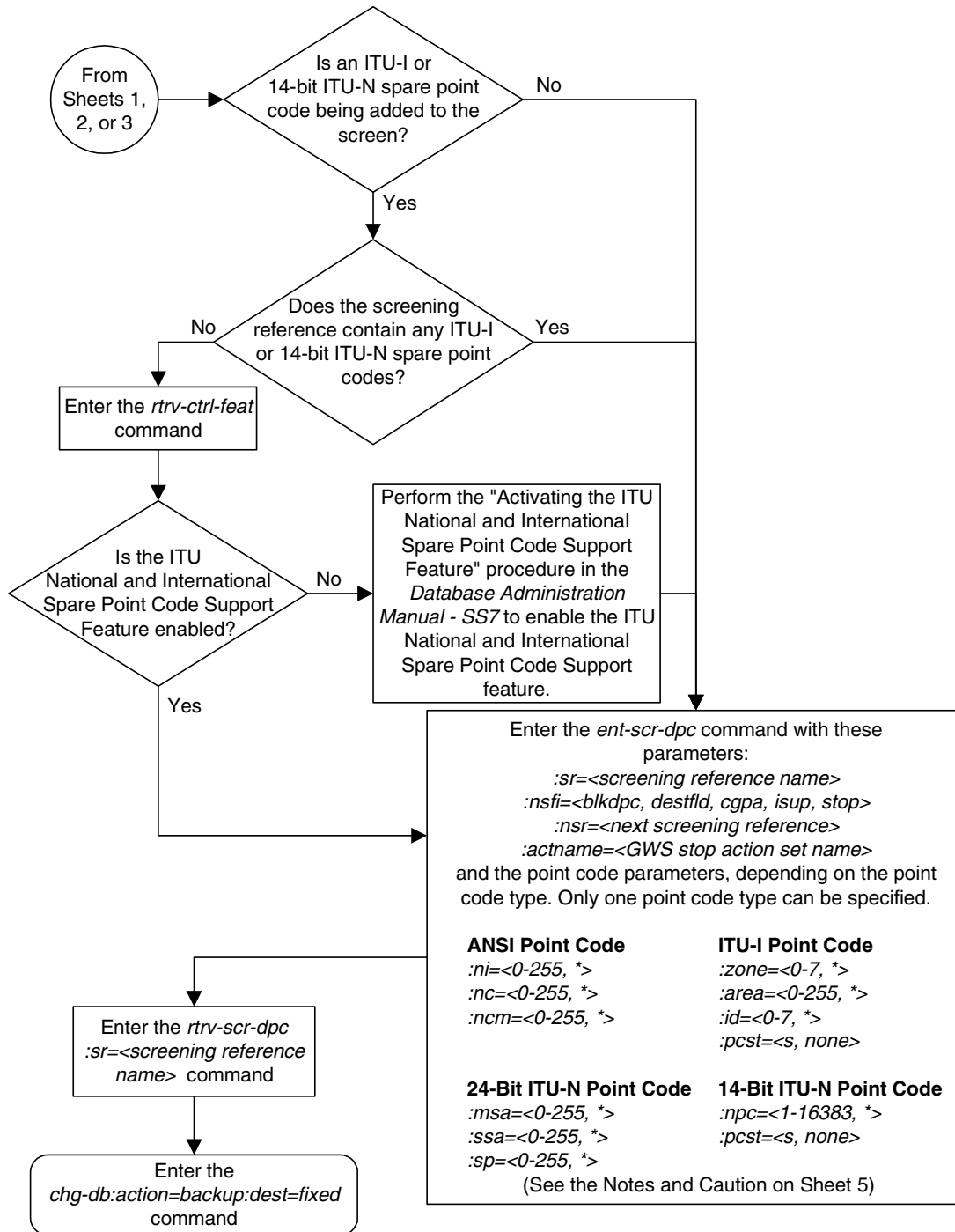

Allowed Destination Point Code (DPC) Screen Configuration

Flowchart 9-2. Adding an Allowed DPC Screen (Sheet 5 of 5)

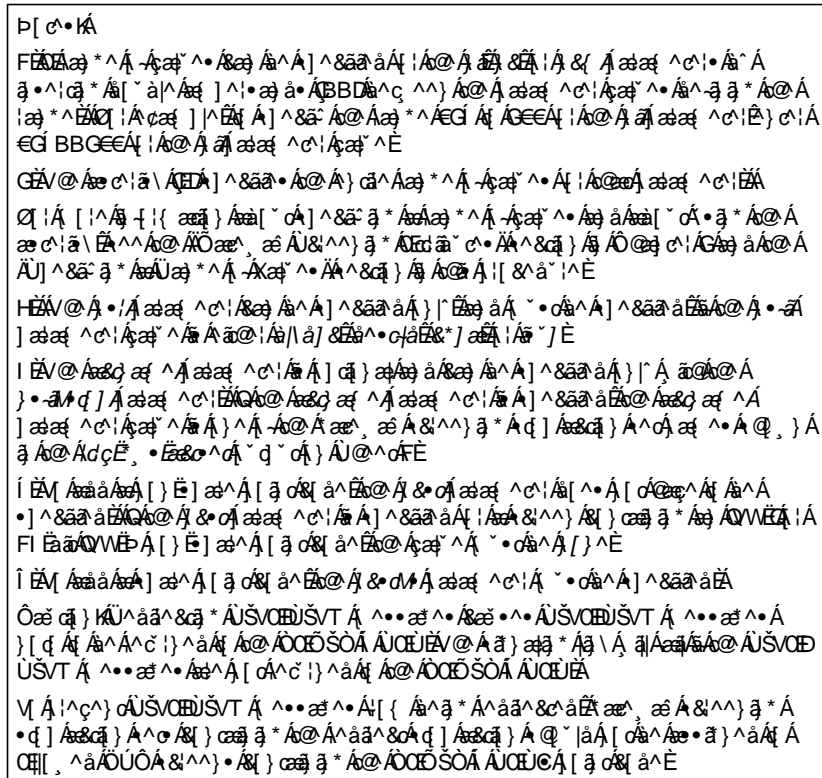

## Removing an Allowed DPC Screen

This procedure is used to remove an allowed destination point code (DPC) screen from the database using the `dlt-scr-dpc` command. The parameters used by the `dlt-scr-dpc` command are shown in the "Gateway Screening Attributes" section on page 2-7. The general rules that apply to configuring gateway screening entities are shown in the "Gateway Screening Configuration" section on page 2-28.

The example in this procedure removes the allowed DPC screen `gws9` from the database.

**NOTE:** If you using multiple-part ITU national point codes with gateway screening, see "14-Bit ITU National Point Code Formats" on page 2-24.

The allowed DPC screen can be referenced by one of the following screens.

- Screen Set
- Allowed OPC
- Blocked OPC
- Allowed SIO

Enter the following commands to verify that none of these screens reference the allowed DPC screen being removed from the database.

- `rtrv-scrset:nsfi=dpc`
- `rtrv-scr-opc:nsfi=dpc`
- `rtrv-scr-blkopc:nsfi=dpc`
- `rtrv-scr-sio:nsfi=dpc`

To change the NSFI of any of these screens, go to one of the following procedures.

- "Changing a Screen Set" procedure on page 13-15
- "Changing an Allowed OPC Screen" procedure on page 12-25
- "Changing a Blocked OPC Screen" procedure on page 11-26
- "Changing an Allowed SIO Screen" procedure on page 10-23



### Procedure

---

1. Display the allowed DPC screens in the database using the **rtrv-scr-dpc** command. The following is an example of the possible output.

```
rlghncxa03w 05-09-25 15:25:30 GMT EAGLE5 34.0.0
SCREEN = ALLOWED DPC
SR   REF  RULES
GWS9 YES   1
IEC  YES   6
ISP2 YES   1
TUP1 YES   1
WRD2 YES   1
WRD4 YES   9
```

From the **rtrv-scr-dpc** output, display the allowed DPC screen you wish to remove using the **rtrv-scr-dpc** command with the screening reference name. For this example, enter this command.

```
rtrv-scr-dpc:sr=gws9
```

The following is an example of the possible output.

```
rlghncxa03w 05-09-25 15:25:30 GMT EAGLE5 34.0.0
SCREEN = ALLOWED DPC
SR  NI      NC      NCM      NSF1      NSR/ACT
GWS9 003     003     003     BLKDPC    GW12
```

2. Enter the commands on page 9-22 to verify that the screen being removed is not referenced by other screens in the database. If the screen being removed is referenced by other screens, go to the procedures shown on page 9-22 and change the NSF1 of those screens to reference other screens or change the NSF1 of these screens to STOP.

3. Remove the allowed DPC screen from the database using the **dlt-scr-dpc** command with the screening reference name shown in the **rtrv-scr-dpc** output in step 1 and with the point code parameter values (**ni**, **nc**, **ncm**, or **zone**, **area**, **id**, or **npc**, or **msa**, **ssa**, **sp**) of the screen being removed from the database. The values for these parameters must be entered exactly as shown in the **rtrv-scr-dpc** output.

To remove an entry containing either an ITU-I or a 14-bit ITU-N spare point code, the **pcst=s** parameter must be specified with the **dlt-scr-dpc** command.

To remove an entry containing either an ITU-I or a 14-bit ITU-N non-spare point code, the **pcst** parameter does not have to be specified with the **dlt-scr-dpc** command. If the **pcst** parameter is specified, the value must be **none**.

## Allowed Destination Point Code (DPC) Screen Configuration

For this example, enter this command.

```
dlt-scr-dpc:sr=gws9:ni=003:nc=003:ncm=003
```

A message similar to the following should appear.

```
rlghncxa03w 05-09-25 15:26:30 GMT EAGLE5 34.0.0  
DLT-SCR-DPC: SCREEN SET AFFECTED - GWS9 0% FULL  
DLT-SCR-DPC: MASP A - COMPLTD
```

---

4. Verify the changes using the **rtrv-scr-dpc** command with the screening reference name used in step 3. For this example, enter this command.

```
rtrv-scr-dpc:sr=gws9
```

The following is an example of the possible output.

```
E2573 Cmd Rej: SR or NSR does not reference an existing SR
```

This message shows that the specified screening reference name is not in the database and the action of the **dlt-scr-dpc** command in step 3 was successful. If the specified screening reference name contained more than one entry when the **dlt-scr-dpc** command was executed in step 3, the **rtrv-scr-dpc:sr=** command output would show the remaining entries in the screening reference instead of error message E2573.

---

5. Backup the new changes using the **chg-db:action=backup:dest=fixed** command. The following messages should appear, the active Maintenance and Administration Subsystem Processor (MASP) appears first.

```
BACKUP (FIXED) : MASP A - Backup starts on active MASP.  
BACKUP (FIXED) : MASP A - Backup on active MASP to fixed disk complete.  
BACKUP (FIXED) : MASP A - Backup starts on standby MASP.  
BACKUP (FIXED) : MASP A - Backup on standby MASP to fixed disk complete.
```

---

## Allowed Destination Point Code (DPC) Screen Configuration

Flowchart 9-3. Removing an Allowed DPC Screen

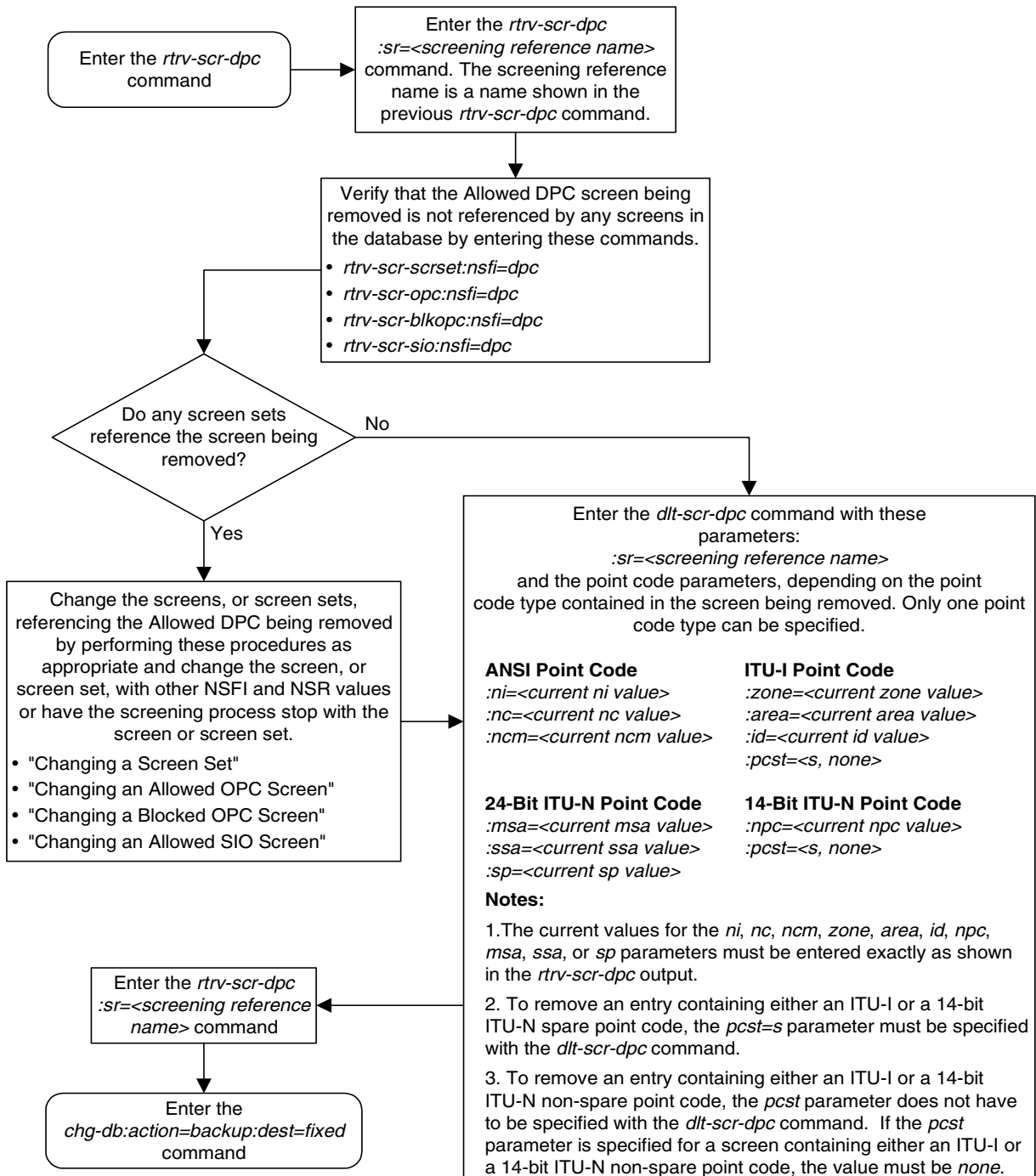

## Changing an Allowed DPC Screen

This procedure is used to change the attributes of an allowed destination point code (DPC) screen in the database using the `chg-scr-dpc` command. The parameters used by the `chg-scr-dpc` command are shown in the “Gateway Screening Attributes” section on page 2-7. The general rules that apply to configuring gateway screening entities are shown in the “Gateway Screening Configuration” section on page 2-28.

The example in this procedure change point code in the allowed DPC screen `gws9` to 009-009-009 and change the `nsfi` to `stop`.

**NOTE:** If you using multiple-part ITU national point codes with gateway screening, see “14-Bit ITU National Point Code Formats” on page 2-24.

The allowed DPC screen can reference one of the following screens.

- Blocked DPC
- Allowed Affected Destination Field
- Allowed CGPA
- Allowed ISUP Message Type

Enter the following commands to verify that these screens are in the database.

- `rtrv-scr-blkdpc:all=yes`
- `rtrv-scr-destfld:all=yes`
- `rtrv-scr-cgpa:all=yes`
- `rtrv-scr-isup:all=yes`

If the desired screen is not in the database, go to one of the following procedures and add the desired screen to the database or change an existing screen in the database.

- “Adding a Blocked DPC Screen” procedure on page 8-8
- “Adding an Allowed Affected Destination Field Screen” procedure on page 7-7
- “Adding an Allowed Calling Party Address Screen” procedure on page 6-6
- “Adding an Allowed ISUP Message Type Screen” procedure on page 15-9
- “Changing a Blocked DPC Screen” procedure on page 8-26
- “Changing an Allowed Affected Destination Field Screen” procedure on page 7-21
- “Changing an Allowed Calling Party Address Screen” procedure on page 6-23
- “Changing an Allowed ISUP Message Type Screen” procedure on page 15-20

**Specifying a Range of Values**

A range of values can be specified for the point code parameters **ni**, **nc**, or **ncm**.

If a range of values is specified for any of these parameters, and the value of the other parameters match existing values for the screening reference name, the range of values for the point code parameter cannot include any values for that parameter that are currently provisioned for the screening reference name.

For example, screening reference name **scr1** contains these entries:

SR	NI	NC	NCM	NSFI	NSR/ACT
SCR1	240	001	010	CGPA	-----
SCR1	241	010	020	STOP	-----

Another entry for screening reference **scr1** with the **ni** value of 240 and the **nc** value of 001 cannot be specified if the range of values for the **ncm** parameter includes the value 010.

The ANSI point code parameter values can be specified as a single value, a range of values, or with an asterisk (\*). The asterisk specifies all possible values for the **ni**, **nc**, and **ncm** parameters. Table 9-5 shows the valid combinations of these parameter values.

**Table 9-5.** Valid Value Combinations for ANSI Point Code Parameters

NI	NC	NCM
Single Value	Single Value	Single Value
Single Value	Single Value	Range of Values
Single Value	Single Value	Asterisk
Single Value	Range of Values	Asterisk
Single Value	Asterisk	Asterisk
Range of Values	Asterisk	Asterisk
Asterisk	Asterisk	Asterisk

A range of values can also be specified for an ITU-I or 24-bit ITU-N point code parameter using a combination of asterisks (\*) and single values for the point code parameters. Table 9-6 on page 9-28 shows the valid combinations of the ITU-I parameter values. Table 9-7 on page 9-28 shows the valid combinations of the 24-bit ITU-N parameter values.

**Table 9-6.** Valid Value Combinations for ITU-I Point Code Parameters

ZONE	AREA	ID
Single Value	Single Value	Single Value
Single Value	Single Value	Asterisk
Single Value	Asterisk	Asterisk
Asterisk	Asterisk	Asterisk

**Table 9-7.** Valid Value Combinations for 24-Bit ITU-N Point Code Parameters

MSA	SSA	SP
Single Value	Single Value	Single Value
Single Value	Single Value	Asterisk
Single Value	Asterisk	Asterisk
Asterisk	Asterisk	Asterisk

## Procedure

---

1. Display the allowed DPC screens in the database using the `rtrv-scr-dpc` command. The following is an example of the possible output.

```
rlghncxa03w 05-09-25 15:25:30 GMT EAGLE5 34.0.0
SCREEN = ALLOWED DPC
SR    REF  RULES
GWS9  YES   1
IEC   YES   6
ISP2  YES   1
TUP1  YES   1
WRD2  YES   1
WRD4  YES   9
```

From the `rtrv-scr-dpc` output, display the allowed DPC screen you wish to remove using the `rtrv-scr-dpc` command with the screening reference name. For this example, enter this command.

```
rtrv-scr-dpc:sr=gws9
```

The following is an example of the possible output.

```
rlghncxa03w 05-09-25 15:25:30 GMT EAGLE5 34.0.0
SCREEN = ALLOWED DPC
SR  NI      NC      NCM      NSF1     NSR/ACT
GWS9 003     003     003     BLKDPC  GW12
```

If a gateway screening stop action set is to be assigned to the allowed DPC screen being changed in the database, go to step 2.

## Allowed Destination Point Code (DPC) Screen Configuration

Step 2 verifies the gateway screening stop action set names in the database. The gateway screening stop action set names are assigned only if the NSFI of the screen being changed in this procedure is STOP. If the NSFI of the screen will be changed to STOP, but a gateway screening stop action set name will not be assigned to the screen, skip steps 2, 3, and 4, and go to step 5. If the NSFI of the screen will not be STOP, skip step 2 and 3, and go to step 4.

2. Display the gateway screening stop action sets in the database with the **rtrv-gws-actset** command. This is an example of the possible output.

```
rlghncxa03w 05-09-25 15:26:30 GMT EAGLE5 34.0.0
ACT ACT ACT ACT ACT ACT ACT ACT ACT ACT ACT ACT
ID NAME 1 2 3 4 5 6 7 8 9 10
--
1 copy copy
2 rdct rdct
3 cr copy rdct
4 cncf cncf
5 cpncf copy cncf
6 cncfrd cncf rdct
7 pcfrd copy cncf rdct
```

GWS action set table is (7 of 16) 44% full

If the required gateway screening stop action set is not in the database, go to the "Configuring Gateway Screening Stop Action Sets" procedure on page 2-54 and configure the required gateway screening stop action set.

**NOTE: If the gateway screening stop action set being assigned to the Allowed DPC screen does not contain the redirect stop action, skip step 3 and go to step 4.**

3. Verify the EAGLE 5 SAS's point code by entering the **rtrv-sid** command. The following is an example of the possible output.

```
rlghncxa03w 05-09-10 11:43:04 GMT EAGLE5 34.0.0
PCA PCI PCN CLLI PCTYPE
100-100-100 3-75-7 7-9-8-1 rlghncxa03w OTHER

CPCA
002-002-002 002-002-003 002-002-004 002-002-005
002-002-006 002-002-007 002-002-008 002-002-009
004-002-001 004-003-003 050-060-070

CPCA (LNP)
005-005-002 005-005-004 005-005-005 006-006-006

CPCI
1-002-1 1-002-2 1-002-3 1-002-4
2-001-1 7-222-7

CPCN
2-0-10-3 2-0-11-0 2-0-11-2 2-0-12-1
2-2-3-3 2-2-4-0 10-14-10-1
```



**CAUTION:** Redirecting SLTA/SLTM messages prevents SLTA/SLTM messages from being returned to the EAGLE 5 SAS. The signaling link carrying these messages will fail if these messages are not returned to the EAGLE 5 SAS. To prevent SLTA/SLTM messages from being redirected, gateway screening stop action sets containing the redirect stop action should not be assigned to Allowed DPC screens containing the EAGLE 5 SAS's point code.

---

**NOTE:** If the NSFI of the screen being changed in this procedure will be STOP, or if the NSFI of the screen is not being changed, skip step 4 and go to step 5.

4. Enter the commands on page 9-26 to verify that the screen that will be specified by the NSFI/NSR parameter combination in step 6 is in the database.

If the desired screen is not in the database, go to one of the procedures shown on page 9-26 and either add the desired screen to the database or change an existing screen in the database.

---

**NOTE:** If any of these conditions apply to this procedure, skip this step and go to step 6:

- The point code in the screen is not being changed.
  - The screen being changed contains either an ANSI or 24-bit ITU-N point code.
  - The ITU-I or 14-bit ITU-N non-spare point code in the screen is not being changed to an ITU-I or 14-bit ITU-N spare point code.
  - The point code in the screen is an ITU-I or 14-bit ITU-N spare point code or the screening reference contains other screens with ITU-I or 14-bit ITU-N spare point codes.
5. Display the status of the ITU National and International Spare Point Code Support feature by entering the `rtrv-ctrl-feat` command with the ITU National and International Spare Point Code Support feature part number. Enter this command.

`rtrv-ctrl-feat:partnum=893013601`

This is an example of the possible output.

```
rlghncxa03w 05-09-25 15:25:30 GMT EAGLE5 34.0.0
The following features have been permanently enabled:
```

Feature Name	Partnum	Status	Quantity
Spare Point Code Support	893013601	on	----

The following features have been temporarily enabled:



## Allowed Destination Point Code (DPC) Screen Configuration

Feature Name	Partnum	Status	Quantity	Trial	Period	Left
Zero entries found.						

The following features have expired temporary keys:

Feature Name	Partnum
Zero entries found.	

If the ITU National and International Spare Point Code Support feature is enabled, go to step 6.

If the ITU National and International Spare Point Code Support feature is not enabled, perform the “Activating the ITU National and International Spare Point Code Support Feature” procedure in the *Database Administration Manual - SS7* to enable the ITU National and International Spare Point Code Support feature as required. After the feature has been enabled, go to step 6.

- 
6. Change the attributes of an allowed DPC screen using the `chg-scr-dpc` command.

If a gateway screening stop action is to be assigned to the allowed DPC screen being changed, enter the `chg-scr-dpc` command with the `nsfi=stop` parameter and the `actname` parameter with the name of a gateway screening stop action set shown in the output of the `rtrv-gws-actset` command executed in step 2.



**CAUTION:** Redirecting SLTA/SLTM messages prevents SLTA/SLTM messages from being returned to the EAGLE 5 SAS. The signaling link carrying these messages will fail if these messages are not returned to the EAGLE 5 SAS. To prevent SLTA/SLTM messages from being redirected, gateway screening stop action sets containing the redirect stop action should not be assigned to Allowed DPC screens containing the EAGLE 5 SAS's point code, shown in step 3.

The current values for the `ni`, `nc`, `ncm`, `zone`, `area`, `id`, `npc`, `msa`, `ssa`, and `sp` parameters must be entered exactly as shown in the `rtrv-scr-dpc` output in step 1.

The following list contains the values for the `nni`, `nnc`, `nncm`, `nzone`, `narea`, `nid`, `nnpc`, `nmsa`, `nssa`, and `nsp` parameters:

- `nni` – 0 - 255 or an asterisk (\*)
- `nnc` – 0 - 255 or an asterisk (\*)
- `nncm` – 0 - 255 or an asterisk (\*)
- `nzone` – 0 - 7 or an asterisk (\*)
- `narea` – 0 - 255 or an asterisk (\*)
- `nid` – 0 - 7 or an asterisk (\*)
- `nnpc` – 1 - 16383 or an asterisk (\*)
- `nmsa` – 0 - 255 or an asterisk (\*)

- **nssa** - 0 - 255 or an asterisk (\*)
- **nsp** - 0 - 255 or an asterisk (\*)

A range of values can be specified for the **nni**, **nnc**, and **nncm** parameters. See the "Specifying a Range of Values" section on page 9-27 for more information on how the asterisk and a range of values are used for the **nni**, **nnc**, and **nncm** parameters.

To change an ITU-I or 14-bit ITU-N spare point code to a non-spare point code, both the **pcst=s** and **npcst=none** parameters must be specified with the **chg-scr-dpc** command.

To change an ITU-I or 14-bit ITU-N non-spare point code to a spare point code, the **npcst=s** parameter must be specified with the **chg-scr-dpc** command. The **pcst** parameter does not have to be specified.

If the current point code in the screen being changed is either an ITU-I or 14-bit ITU-N spare point code, the **pcst=s** parameter must be specified with the **chg-scr-dpc** command.

If the current point code in the screen being changed is either an ITU-I or 14-bit ITU-N non-spare point code, the **pcst** parameter does not have to be specified with the **chg-scr-dpc** command. If the **pcst** parameter is specified for a screen containing either an ITU-I or 14-bit ITU-N non-spare point code, the **pcst** parameter value must be **none**.

For this example, enter this command.

```
chg-scr-dpc:sr=gws9:ni=003:nc=003:nncm=003:nni=009:nnc=009
:nncm=009:nsfi=stop
```

A message similar to the following should appear.

```
rlghncxa03w 05-09-25 15:27:30 GMT EAGLE5 34.0.0
CHG-SCR-DPC: SCREEN SET AFFECTED - GWS9 1% FULL
CHG-SCR-DPC: MASP A - COMPLTD
```

7. Verify the changes using the **rtrv-scr-dpc** command with the screening reference name used in step 6. For this example, enter this command.

```
rtrv-scr-dpc:sr=gws9
```

The following is an example of the possible output.

```
rlghncxa03w 05-09-25 15:28:30 GMT EAGLE5 34.0.0
SCREEN = ALLOWED DPC
SR   NI      NC      NCM      NSFI     NSR/ACT
GWS9 009      009      009      STOP     -----
```

8. Backup the new changes using the **chg-db:action=backup:dest=fixed** command. The following messages should appear, the active Maintenance and Administration Subsystem Processor (MASP) appears first.

```
BACKUP (FIXED) : MASP A - Backup starts on active MASP.
BACKUP (FIXED) : MASP A - Backup on active MASP to fixed disk complete.
BACKUP (FIXED) : MASP A - Backup starts on standby MASP.
BACKUP (FIXED) : MASP A - Backup on standby MASP to fixed disk complete.
```

## Allowed Destination Point Code (DPC) Screen Configuration

Flowchart 9-4. Changing an Allowed DPC Screen (Sheet 1 of 6)

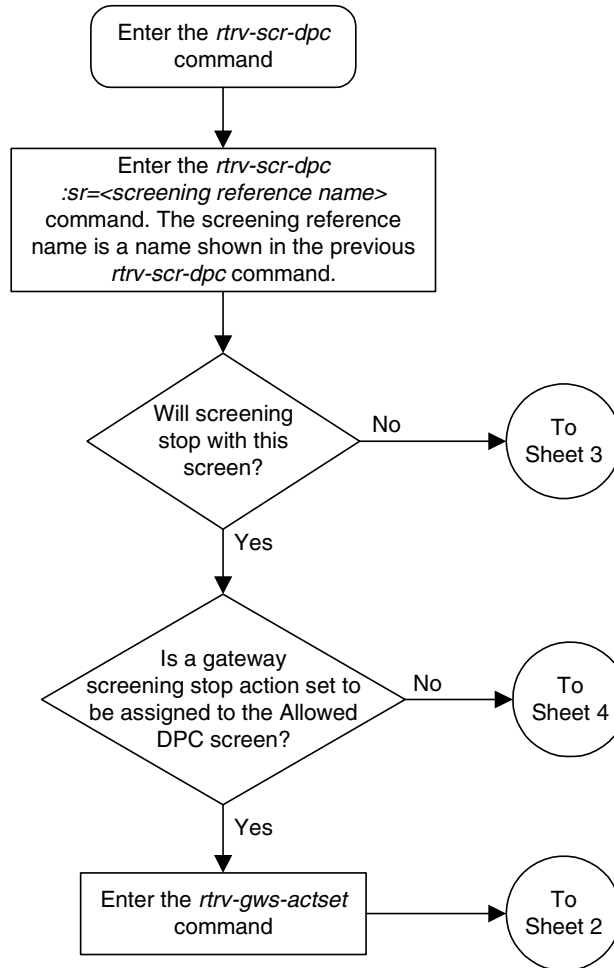

Flowchart 9-4. Changing an Allowed DPC Screen (Sheet 2 of 6)

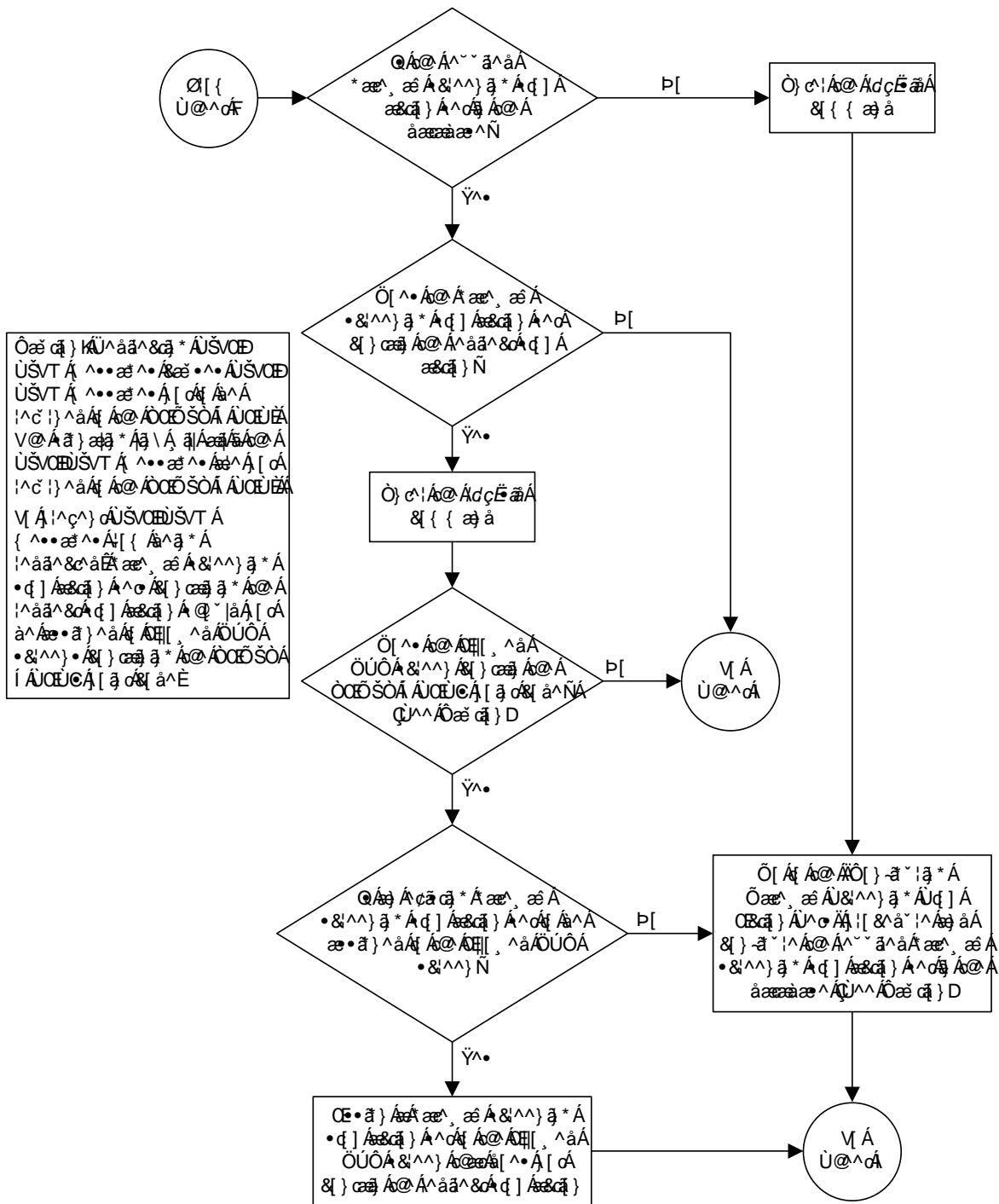

# Allowed Destination Point Code (DPC) Screen Configuration

**Flowchart 9-4.** Changing an Allowed DPC Screen (Sheet 3 of 6)

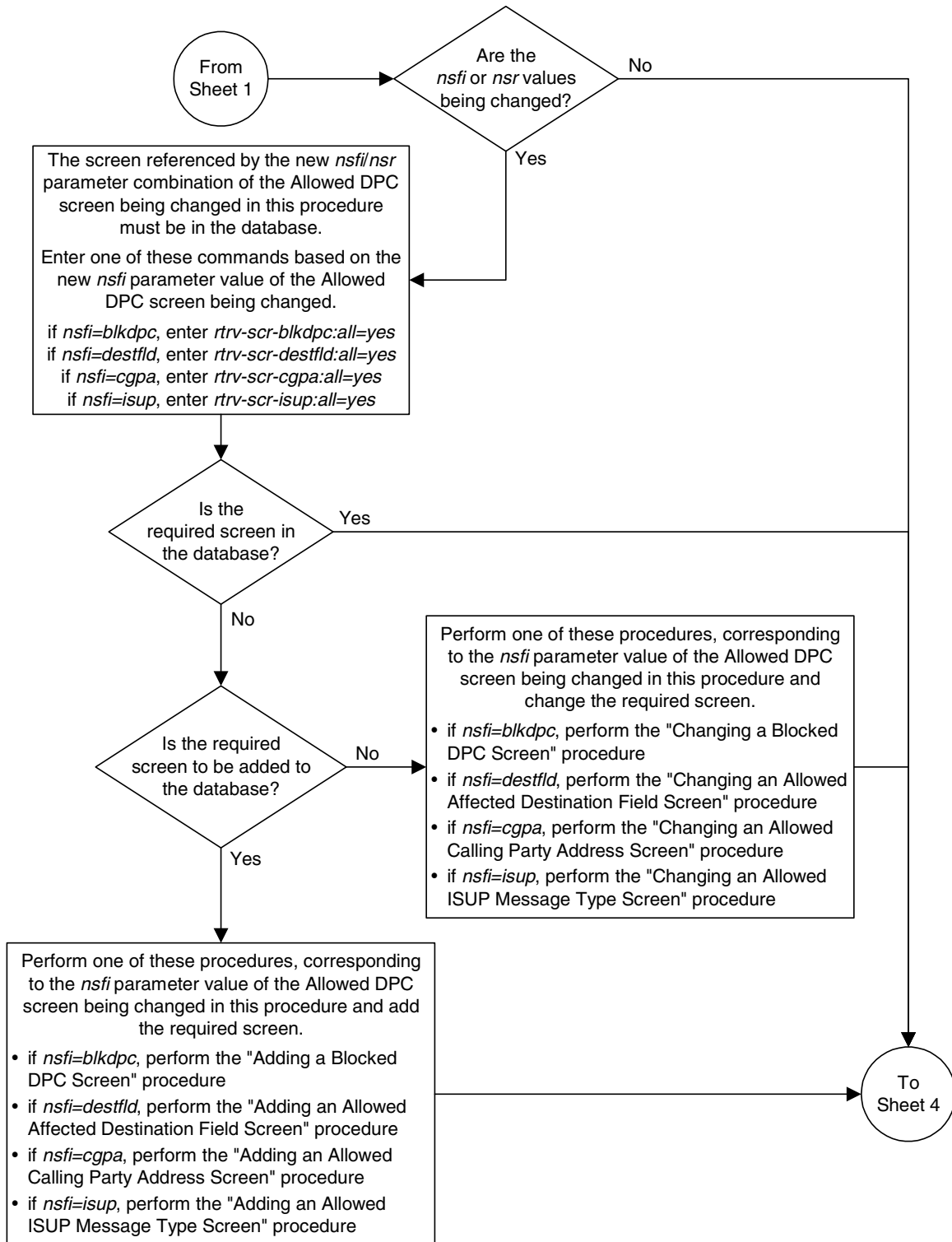

Flowchart 9-4. Changing an Allowed DPC Screen (Sheet 4 of 6)

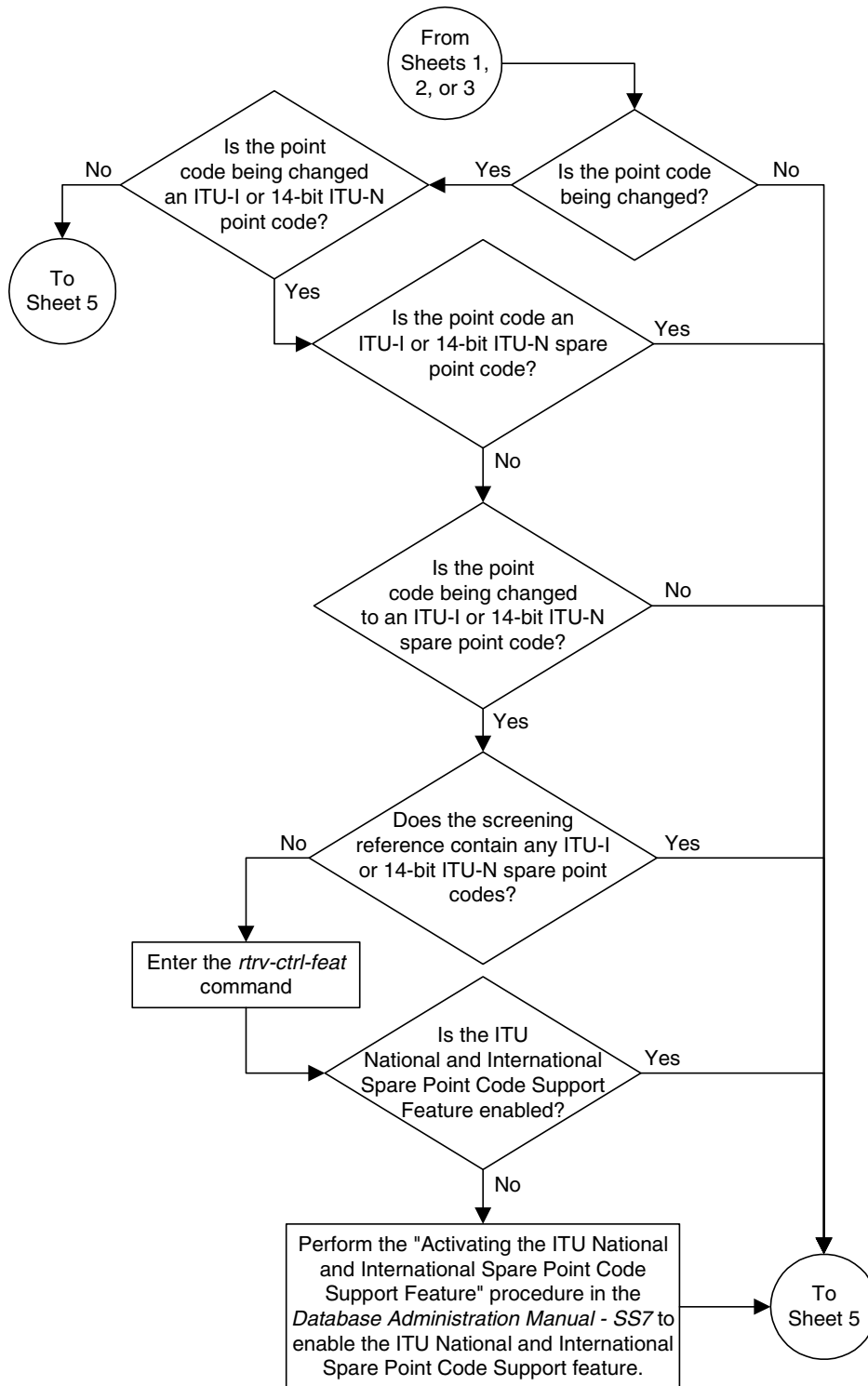

# Allowed Destination Point Code (DPC) Screen Configuration

Flowchart 9-4. Changing an Allowed DPC Screen (Sheet 5 of 6)

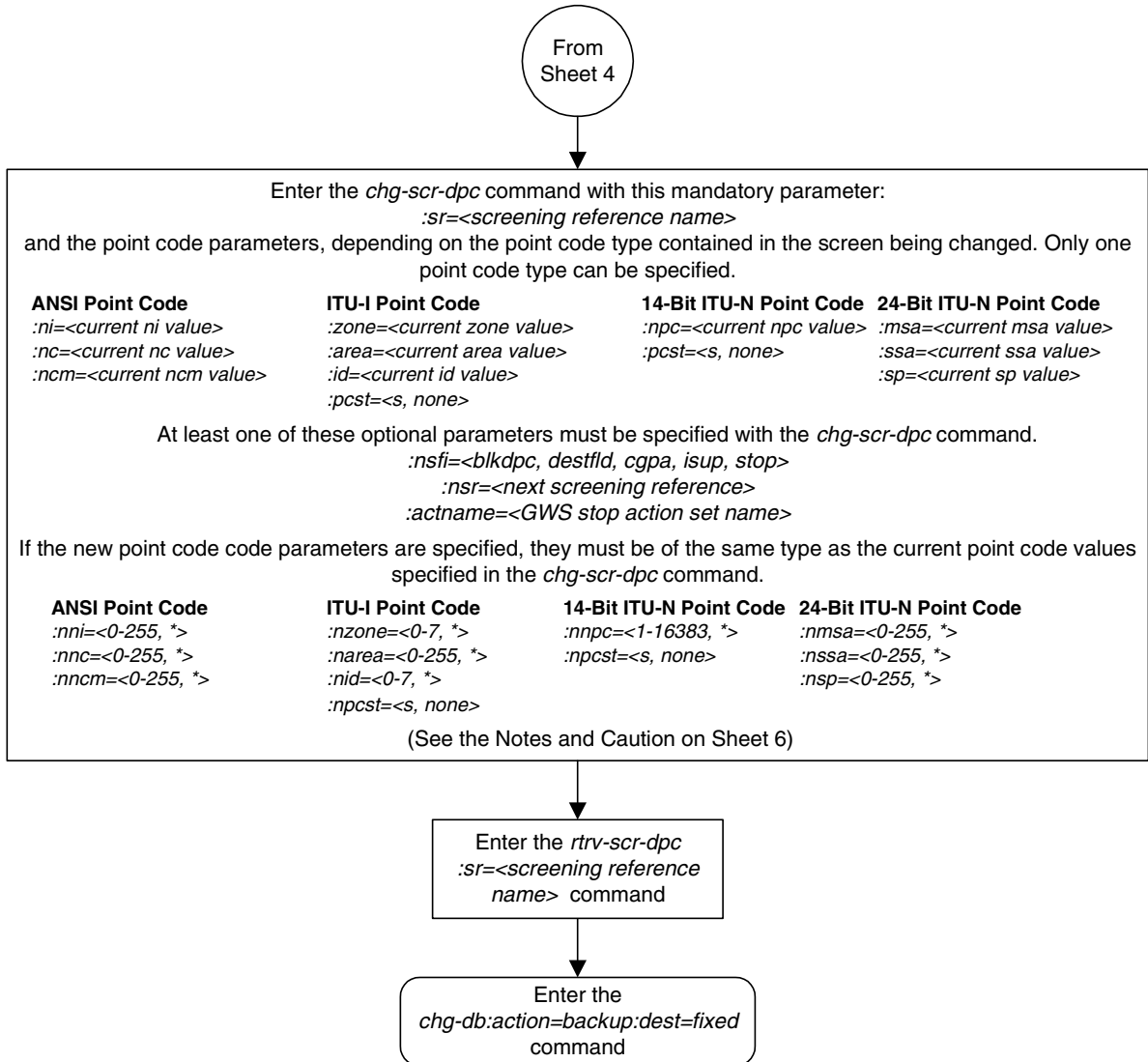

Flowchart 9-4. Changing an Allowed DPC Screen (Sheet 6 of 6)





# 10

## Allowed Signaling Information Octet (SIO) Screen Configuration

Introduction.....	10-2
Adding an Allowed SIO Screen.....	10-9
Removing an Allowed SIO Screen.....	10-20
Changing an Allowed SIO Screen.....	10-23

## Introduction

The allowed signaling information octet (SIO) screen identifies the type of MSUs (ISUP, TCAP, etc.) that are allowed into the network. The gray shaded areas in Figure 10-1 shows the fields of the SS7 message that are checked by the allowed SIO screening function. If a match is found, the **nsfi** is examined to determine the next step in the screening process. If the **nsfi** is equal to **stop**, the message is processed and no further screening takes place.

If the **nsfi** is equal to **stop**, and the **copy** gateway screening stop action is specified, the message is processed and a copy of the message is sent by the STP LAN feature to an external application through an ACM running the **stplan** application or a DCM running the **vxwslan** application.

If the **nsfi** is equal to **stop**, and the **rdct** (redirect) gateway screening stop action is specified, the message is diverted from the original destination and sent to another destination with the Database Transport Access feature, specified by global title translation, for further processing.

If the Calling Name Conversion Facility (CNCF) feature is on, the **nsfi** is equal to **stop**, and the **cncf** gateway screening stop action is specified, the PIP parameter in the incoming ISUP IAM message is converted to the GN parameter. The GN parameter in the incoming ISUP IAM message is converted to the PIP parameter. The message is then sent to the node specified by the DPC in the routing label in the message. For more information on the Calling Name Conversion Facility feature, see Chapter 14, "Calling Name Conversion Facility (CNCF) Configuration."

If the Triggerless LNP (TLNP) feature is on, the **nsfi** is equal to **stop**, and the **tlnp** gateway screening stop action is specified, ISUP IAMs that pass gateway screening are processed either by the ISUP NP with EPAP feature (if the ISUP NP with EPAP feature is enabled and turned on) or by the Triggerless LNP feature (if the Triggerless LNP feature is turned on). The ISUP NP with EPAP feature is discussed in more detail in the *Feature Manual - G-Port*. The Triggerless LNP feature is discussed in more detail in the *LNP Feature Activation Guide*.

If the **nsfi** is equal to anything else, the next screening reference (**nsr**) is identified and the screening process continues to the next screen identified by the **nsfi** and **nsr** parameters. If no match is found, the message is discarded.

The value of the **nsfi** parameter is based on the value of the service indicator (**si**) parameter. Table 10-1 shows the valid combinations of **nsfi** values and service indicator values.

## Allowed Signaling Information Octet (SIO) Screen Configuration

**Table 10-1.** Valid Parameter Combinations for the Allowed SIO Screening Function

Service Indicator (SI) Values	Nest Screening Function Identifier (NSFI) Values
0	DPC, BLKDPC, DESTFLD
3	DPC, BLKDPC, CGPA, CDPA
4, 5	DPC, BLKDPC, ISUP
All other values (1, 2, 6-15)	DPC, BLKDPC

Messages containing the service indicator value 4 are TUP messages, and messages containing the service indicator value 5 are ISUP messages. Both types of messages are screened using the allowed ISUP screen. TUP messages can be screened for point codes, after the SIO screen, with the allowed and blocked DPC screens. However, if the screen set does not contain an allowed SIO screen that screens for TUP messages (messages with the service indicator value of 4), the message will be treated by the allowed ISUP message type screen as an ISUP message, even if the message contains the service indicator value of 4.

Flowchart 10-1 shows the screening action of the allowed SIO screen.

Allowed Signaling Information Octet (SIO) Screen Configuration

Flowchart 10-1. Allowed SIO Screening Action (Sheet 1 of 4)

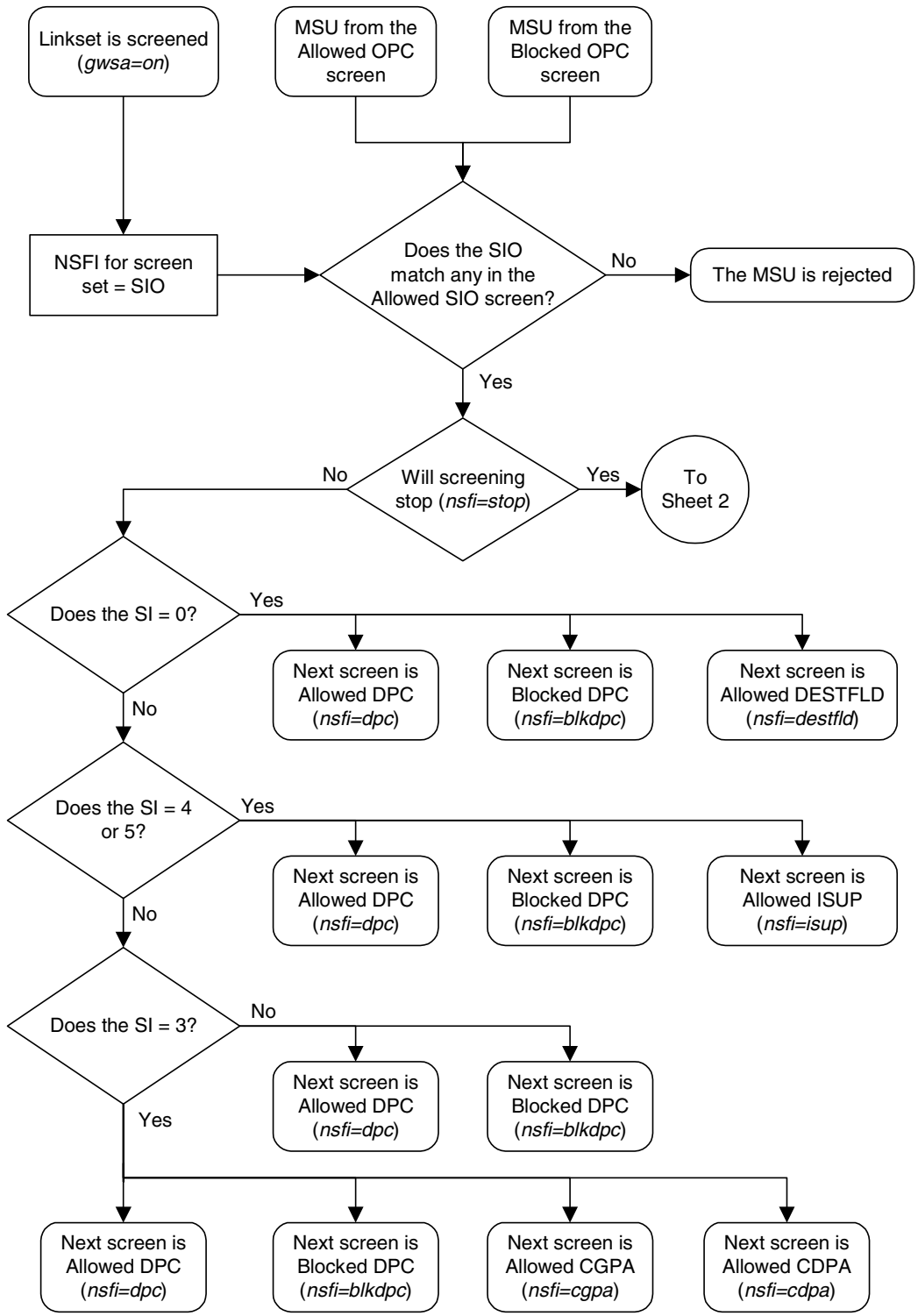

Allowed Signaling Information Octet (SIO) Screen Configuration

Flowchart 10-1. Allowed SIO Screening Action (Sheet 2 of 4)

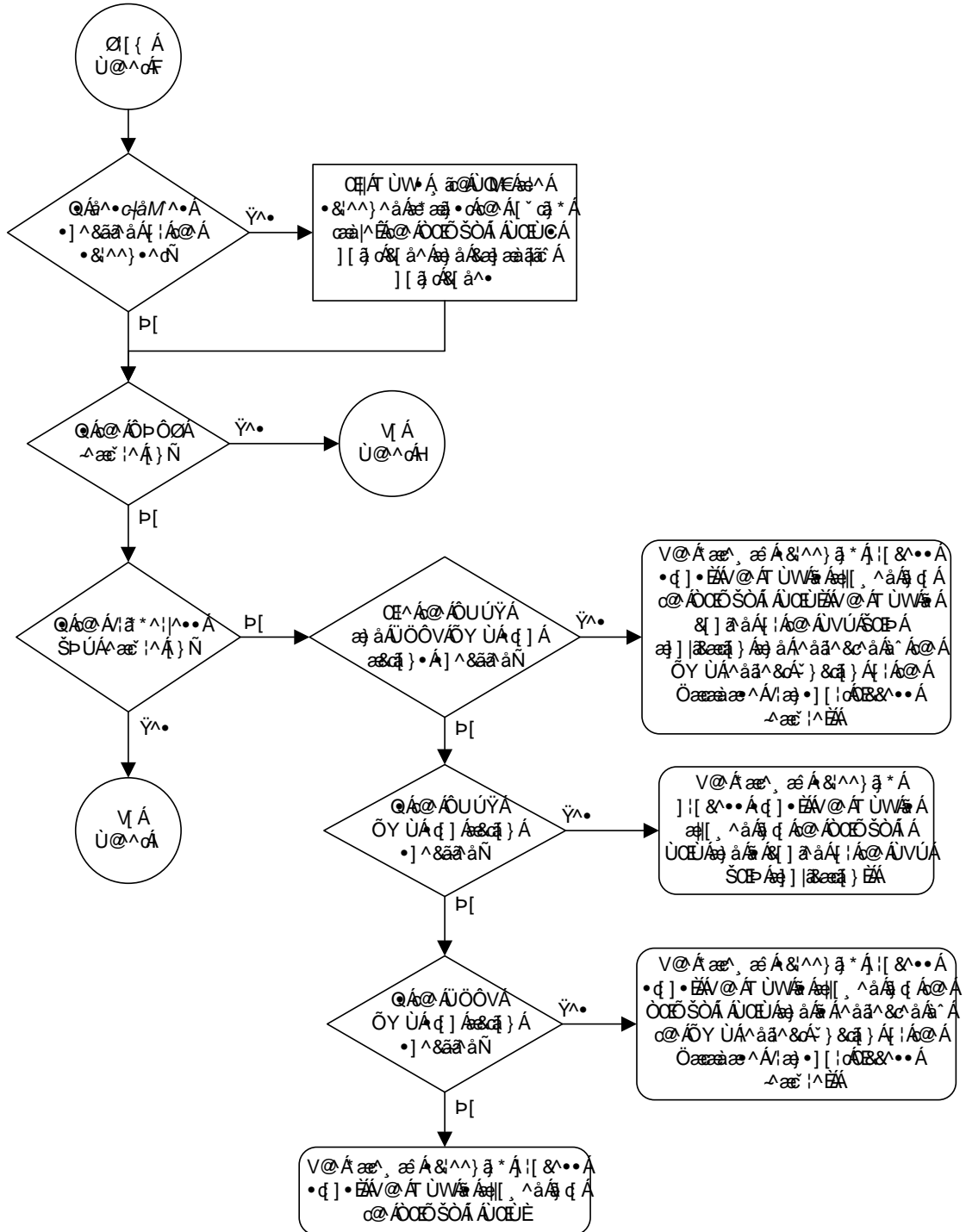



Allowed Signaling Information Octet (SIO) Screen Configuration

Flowchart 10-1. Allowed SIO Screening Action (Sheet 4 of 4)

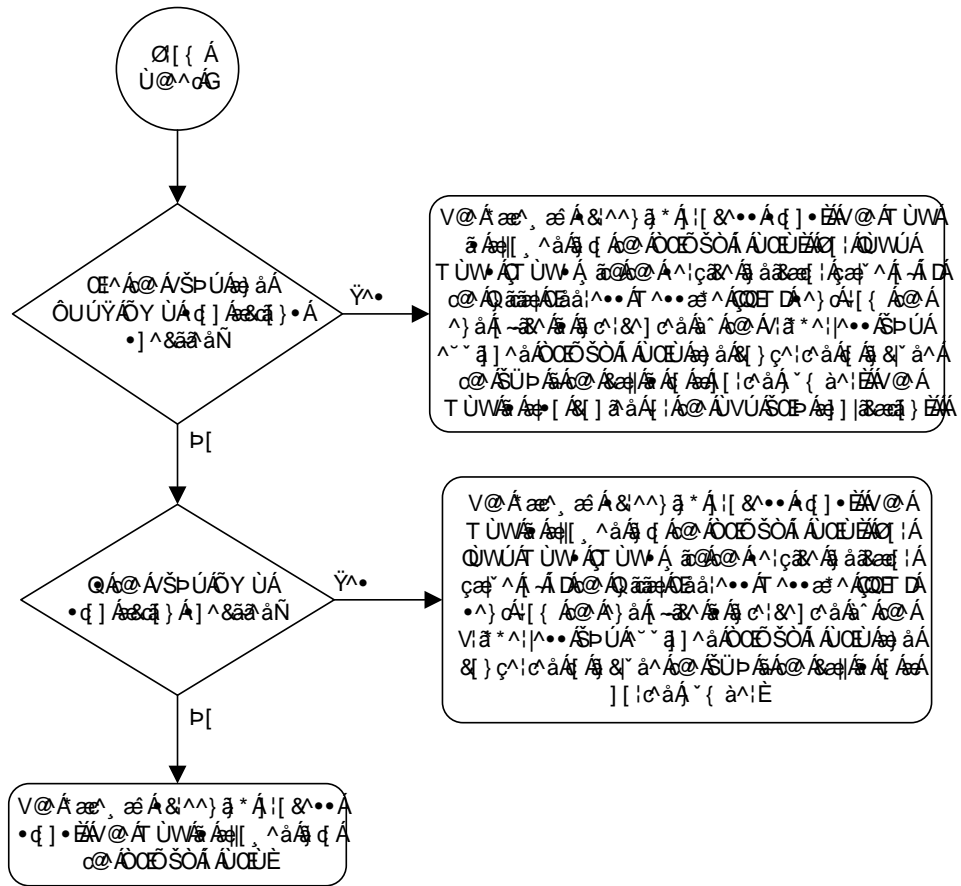

## Allowed Signaling Information Octet (SIO) Screen Configuration

**Figure 10-1.** Allowed SIO Screening Function

**ANSI MSU (ANSI Message Signal Unit)**

BSN FSN LI	SIO xx xx xxxx	SIF		
	NIC PRI SI	Routing Label DPC OPC SLS NCM NC NI NCM NC NI xx	H1	H0

**ITU-I MSU (ITU International Message Signal Unit)**

BSN FSN LI	SIO xx xx xxxx	SIF		
	NIC PRI SI	Routing Label DPC OPC SLS ID AREA ZONE ID AREA ZONE xx	H1	H0

**14-Bit ITU-N MSU (14-Bit ITU National Message Signal Unit)**

BSN FSN LI	SIO xx xx xxxx	SIF		
	NIC PRI SI	Routing Label DPC OPC SLS NPC NPC xx	H1	H0

**24-Bit ITU-N MSU (24-Bit ITU National Message Signal Unit)**

BSN FSN LI	SIO xx xx xxxx	SIF		
	NIC PRI SI	Routing Label DPC OPC SLS SP SSA MSA SP SSA MSA xx	H1	H0



## Adding an Allowed SIO Screen

This procedure is used to add an allowed signaling information octet (SIO) screen to the database using the `ent-scr-sio` command. The parameters used by the `ent-scr-sio` command are shown in the “Gateway Screening Attributes” section on page 2-7. The general rules that apply to configuring gateway screening entities are shown in the “Gateway Screening Configuration” section on page 2-28.

The examples in this procedure are used to add the allowed SIO screen data shown in Table 10-2 and based on the example configurations shown in Figure 2-4 on page 2-35, Figure 2-6 on page 2-39, Figure 2-7 on page 2-41, Figure 2-8 on page 2-43, and Figure 2-9 on page 2-45.

**Table 10-2.** Example Gateway Screening Allowed SIO Configuration Table

Screening Reference	NIC	SI	H0	H1	PRI	NSFI	NSR
fld4	2	0	4	5	3	destfld	fld5
iec	2	3	--	--	1&&3	cgpa	gw11
ls02	2	3	--	--	3	cdpa	ls03
isp1	2	5	--	--	3	isup	isp1
tup1	2	4	--	--	3	dpc	tup1
tup1	2	5	--	--	3	dpc	isp2

The allowed SIO screen can reference one of the following screens.

- Allowed DPC
- Blocked DPC
- Allowed Affected Destination Field
- Allowed ISUP Message Type
- Allowed CGPA
- Allowed CDPA

## Allowed Signaling Information Octet (SIO) Screen Configuration

Enter the following commands to verify that these screens are in the database.

- `rtrv-scr-dpc:all=yes`
- `rtrv-scr-blkdpc:all=yes`
- `rtrv-scr-destfld:all=yes`
- `rtrv-scr-isup:all=yes`
- `rtrv-scr-cgpa:all=yes`
- `rtrv-scr-cdpa:all=yes`

If the desired screen is not in the database, go to one of the following procedures and add the desired screen to the database or change an existing screen in the database.

- “Adding an Allowed DPC Screen” procedure on page 9-8
- “Adding a Blocked DPC Screen” procedure on page 8-8
- “Adding an Allowed Affected Destination Field Screen” procedure on page 7-7
- “Adding an Allowed ISUP Message Type Screen” procedure on page 15-9
- “Adding an Allowed Calling Party Address Screen” procedure on page 6-6
- “Adding an Allowed Called Party Address Screen” procedure on page 4-5
- “Changing an Allowed DPC Screen” procedure on page 9-26
- “Changing a Blocked DPC Screen” procedure on page 8-26
- “Changing an Allowed Affected Destination Field Screen” procedure on page 7-21
- “Changing an Allowed ISUP Message Type Screen” procedure on page 15-20
- “Changing an Allowed Calling Party Address Screen” procedure on page 6-23
- “Changing an Allowed Called Party Address Screen” procedure on page 4-22

### Specifying a Range of Values

A range of values can be specified for the `pri`, `h0`, and `h1` parameters. If a range of values is specified for any of these parameters and the `nic` and `si` values in the screening reference name are not changed, the range of values for the `pri`, `h0`, or `h1` parameters cannot include any values that are currently provisioned for the screening reference name.

For example, screening reference name `scr1` contains these entries:

SR	NIC	PRI	SI	H0	H1	NSFI	NSR/ACT
SCR1	2	3	1	4	5	DPC	LS03
SCR1	2	2	1	2	7	BLKDPC	LS04

## Allowed Signaling Information Octet (SIO) Screen Configuration

Another entry for screening reference `scr1` with the same `nic` and `si` values cannot be specified if:

- The range of values for the `pri` parameter includes the values 2 or 3
- The range of values for the `h0` parameter includes the values 2 or 4
- The range of values for the `h1` parameter includes the values 5 or 7.

### Specifying H0 and H1 Values

The `h0` and `h1` values must be specified if the `si` value is 0, 1, or 2. If the `si` value is 3 through 15, the `h0` and `h1` parameters cannot be specified.

The `h0` and `h1` parameters must be specified if either parameter is specified.

The H0 and H1 heading code values can be a single value, a range of values with the beginning and end of the range separated by double ampersands (for example, a range of values from 2 to 9, `2&&9`), or with an asterisk (\*). The asterisk specifies all possible values for the `h0` and `h1` parameters. Table 10-4 shows the valid combinations of these parameter values.

**Table 10-3.** Valid Value Combinations for H0 and H1 Parameters

H0	H1
Single Value	Single Value
Single Value	Range of Values
Single Value	Asterisk
Range of Values	Asterisk
Asterisk	Asterisk

### Procedure

---

1. Verify that the gateway screening feature is on, by entering the `rtrv-feat` command. If the gateway screening feature is on, the `GWS` field is set to `on`.

**NOTE:** The `rtrv-feat` command output contains other fields that are not used by this procedure. If you wish to see all the fields displayed by the `rtrv-feat` command, see the `rtrv-feat` command description in the *Commands Manual*.

If the gateway screening feature is on, shown by the entry `GWS = on` in the `rtrv-feat` command output, skip step 2, and go to step 3.

---

- Turn the gateway screening feature on by entering this command.

```
chg-feat:gws=on
```

**NOTE:** Once the gateway screening feature is turned on with the `chg-feat` command, it cannot be turned off.

The gateway screening feature must be purchased before you turn this feature on with the `chg-feat` command. If you are not sure if you have purchased the gateway screening feature, contact your Tekelec Sales Representative or Account Representative.

When the `chg-feat` has successfully completed, this message should appear.

```
rlghncxa03w 05-09-28 11:43:04 GMT EAGLE5 34.0.0
CHG-FEAT: MASP A - COMPLTD
```

---

- Display all allowed SIO screens in the database using the `rtrv-scr-sio` command. The following is an example of the possible output.

```
rlghncxa03w 05-09-25 15:25:30 GMT EAGLE5 34.0.0
SCREEN = ALLOWED SIO
SR    REF  RULES
IEC   YES   5
WRD2  YES   1
WRD4  YES   9
```

If the screening reference names that you wish to add with this procedure are not shown in the `rtrv-scr-sio` command output, go to either steps 4 or 5.

Step 4 verifies the gateway screening stop action set names in the database. The gateway screening stop action set names are assigned only if the NSFI of the screen being added in this procedure is STOP. If the NSFI of the new screen will be STOP, but a gateway screening stop action set name will not be assigned to the new screen, skip steps 4 and 5 and go to step 6. If the NSFI of the new screen is not STOP, skip step 4 and go to step 5.

If these screening reference names are shown in the `rtrv-scr-sio` command output, make sure the screening data you wish to enter is not already in the database by entering the `rtrv-scr-sio` command with the screening reference name. In this example, screen `iec` will have new data added to it. For this example, enter the `rtrv-scr-sio:sr=iec` command. The following is an example of the possible output.

```
rlghncxa03w 05-09-25 15:26:30 GMT EAGLE5 34.0.0
SCREEN = ALLOWED SIO
SR  NIC  PRI  SI  H0  H1  NSFI  NSR/ACT
IEC  2    0&&3  0  0    0    BLKDPC  WDB2
IEC  2    0&&2  0  1    1    DPC     WDB3
IEC  2    0&&1  0  2    2    STOP    -----
IEC  2    0&&3  4  --   --   STOP    -----
IEC  2    0&&2  1  *    *    DPC     WDB3
```

---

## Allowed Signaling Information Octet (SIO) Screen Configuration

4. Display the gateway screening stop action sets in the database with the `rtrv-gws-actset` command. This is an example of the possible output.

```
rlghncxa03w 05-09-25 15:27:30 GMT EAGLE5 34.0.0
ACT ACT ACT ACT ACT ACT ACT ACT ACT ACT ACT ACT
ID NAME 1 2 3 4 5 6 7 8 9 10
-----
1 copy copy
2 rdct rdct
3 cr copy rdct
4 cncf cncf
5 cpcncf copy cncf
6 cncfrd cncf rdct
7 cpcfrd copy cncf rdct
```

GWS action set table is (7 of 16) 44% full

If the required gateway screening stop action set is not in the database, go to the "Configuring Gateway Screening Stop Action Sets" procedure on page 2-54 and configure the required gateway screening stop action set.

---

**NOTE:** If the NSFI of the screen being added in this procedure is STOP, skip step 5 and go to step 6.

5. Enter the commands on page 10-10 to verify that the screen that will be specified by the NSFI/NSR parameter combination in step 6 is in the database.

If the desired screen is not in the database, go to one of the procedures shown on page 10-10 and either add the desired screen to the database or change an existing screen in the database.

---

6. Add a new allowed SIO screen to the database using the `ent-scr-sio` command.

If a gateway screening stop action set is to be assigned to the new allowed SIO screen, enter the `ent-scr-sio` command with the `nsfi=stop` parameter and the `actname` parameter with the name of a gateway screening stop action set shown in the output of the `rtrv-gws-actset` command executed in step 4.



**CAUTION:** Redirecting SLTA/SLTM messages prevents SLTA/SLTM messages from being returned to the EAGLE 5 SAS. The signaling link carrying these messages will fail if these messages are not returned to the EAGLE 5 SAS. To prevent SLTA/SLTM messages from being redirected, gateway screening stop action sets containing the redirect stop action should not be assigned to Allowed SIO screens containing the service indicator values 1 (SI=1) or 2 (SI=2).

The following list contains the values for `nic`, `si`, `pri`, `h0` and `h1` parameters:

- `nic` – 0 - 3, or an asterisk (\*)
- `si` – 0 - 15
- `pri` – 0 - 3, or an asterisk (\*)
- `h0` – 0 - 15, or an asterisk (\*)
- `h1` – 0 - 15, or an asterisk (\*)

A range of values can be specified for the `pri`, `h0`, and `h1` parameters. See the “Specifying a Range of Values” section on page 10-10 for more information. See the “Specifying H0 and H1 Values” section on page 10-11 for information on how the asterisk and a range of values are used for the `h0` and `h1` parameters.

The value of the `nsfi` parameter is based on the value of the service indicator (`si`) parameter. Table 10-1 on page 10-3 shows the valid combinations of `nsfi` values and service indicator values.

For this example, enter these commands.

```
ent-scr-sio:sr=fld4:nic=2:si=0:h0=4:h1=5:pri=3:nsfi=destfld
:nsr=fld5
```

A message similar to the following should appear.

```
rlghncxa03w 05-09-25 15:28:30 GMT EAGLE5 34.0.0
ENT-SCR-SIO: MASP A - COMPLTD
```

```
ent-scr-sio:sr=iec:nic=2:si=3:pri=1&&3:nsfi=cgpa:nsr=gw11
```

A message similar to the following should appear.

```
rlghncxa03w 05-09-25 15:29:30 GMT EAGLE5 34.0.0
ENT-SCR-SIO: MASP A - COMPLTD
```

## Allowed Signaling Information Octet (SIO) Screen Configuration

```
ent-scr-sio:sr=ls02:nic=2:si=3:pri=3:nsfi=cdpa:nsr=ls03
```

A message similar to the following should appear.

```
rlghncxa03w 05-09-25 15:30:30 GMT EAGLE5 34.0.0
ENT-SCR-SIO: MASP A - COMPLTD
```

```
ent-scr-sio:sr=isp1:nic=2:si=5:pri=3:nsfi=isup:nsr=isp1
```

A message similar to the following should appear.

```
rlghncxa03w 05-09-25 15:30:30 GMT EAGLE5 34.0.0
ENT-SCR-SIO: MASP A - COMPLTD
```

```
ent-scr-sio:sr=tup1:nic=2:si=4:pri=3:nsfi=dpc:nsr=tup1
```

A message similar to the following should appear.

```
rlghncxa03w 05-09-25 15:30:30 GMT EAGLE5 34.0.0
ENT-SCR-SIO: MASP A - COMPLTD
```

```
ent-scr-sio:sr=tup1:nic=2:si=5:pri=3:nsfi=dpc:nsr=isp2
```

A message similar to the following should appear.

```
rlghncxa03w 05-09-25 15:30:30 GMT EAGLE5 34.0.0
ENT-SCR-SIO: MASP A - COMPLTD
```

- 
7. Verify the changes using the `rtrv-scr-sio` command with the screening reference name used in step 6. For this example, enter these commands.

```
rtrv-scr-sio:sr=iec
```

The following is an example of the possible output.

```
rlghncxa03w 05-09-25 15:31:30 GMT EAGLE5 34.0.0
SCREEN = ALLOWED SIO
SR   NIC  PRI  SI  H0    H1    NSFI   NSR/ACT
IEC  2    0&&3 0   0     0     BLKDPC WDB2
IEC  2    0&&2 0   1     1     DPC    WDB3
IEC  2    0&&1 0   2     2     STOP   -----
IEC  2    0&&3 4   --    --    STOP   -----
IEC  2    0&&2 1   *     *     DPC    WDB3
IEC  2    1&&3 3   --    --    CGPA   GW11
```

```
rtrv-scr-sio:sr=ls02
```

The following is an example of the possible output.

```
rlghncxa03w 05-09-25 15:32:30 GMT EAGLE5 34.0.0
SCREEN = ALLOWED SIO
SR   NIC  PRI  SI  H0    H1    NSFI   NSR/ACT
LS02 2    3    3   --    --    CDPA   LS03
```

```
rtrv-scr-sio:sr=fld4
```

The following is an example of the possible output.

```
rlghncxa03w 05-09-25 15:33:30 GMT EAGLE5 34.0.0
SCREEN = ALLOWED SIO
SR   NIC  PRI  SI  H0    H1    NSFI   NSR/ACT
FLD4 2    3    0   4     5     DESTFLD FDL5
```

## Allowed Signaling Information Octet (SIO) Screen Configuration

**rtrv-scr-sio:sr=isp1**

The following is an example of the possible output.

```
rlghncxa03w 05-09-25 15:33:30 GMT EAGLE5 34.0.0
SCREEN = ALLOWED SIO
SR   NIC  PRI  SI  H0   H1   NSFI  NSR/ACT
isp1 2    3    5   --   --   ISUP  isp1
```

**rtrv-scr-sio:sr=tup1**

The following is an example of the possible output.

```
rlghncxa03w 05-09-25 15:33:30 GMT EAGLE5 34.0.0
SCREEN = ALLOWED SIO
SR   NIC  PRI  SI  H0   H1   NSFI  NSR/ACT
tup1 2    3    4   --   --   DPC   tup1
tup1 2    3    5   --   --   ISUP  isp2
```

---

8. Backup the new changes using the **chg-db:action=backup:dest=fixed** command. The following messages should appear, the active Maintenance and Administration Subsystem Processor (MASP) appears first.

```
BACKUP (FIXED) : MASP A - Backup starts on active MASP.
BACKUP (FIXED) : MASP A - Backup on active MASP to fixed disk complete.
BACKUP (FIXED) : MASP A - Backup starts on standby MASP.
BACKUP (FIXED) : MASP A - Backup on standby MASP to fixed disk complete.
```

---



Allowed Signaling Information Octet (SIO) Screen Configuration

Flowchart 10-2. Adding an Allowed SIO Screen (Sheet 1 of 3)

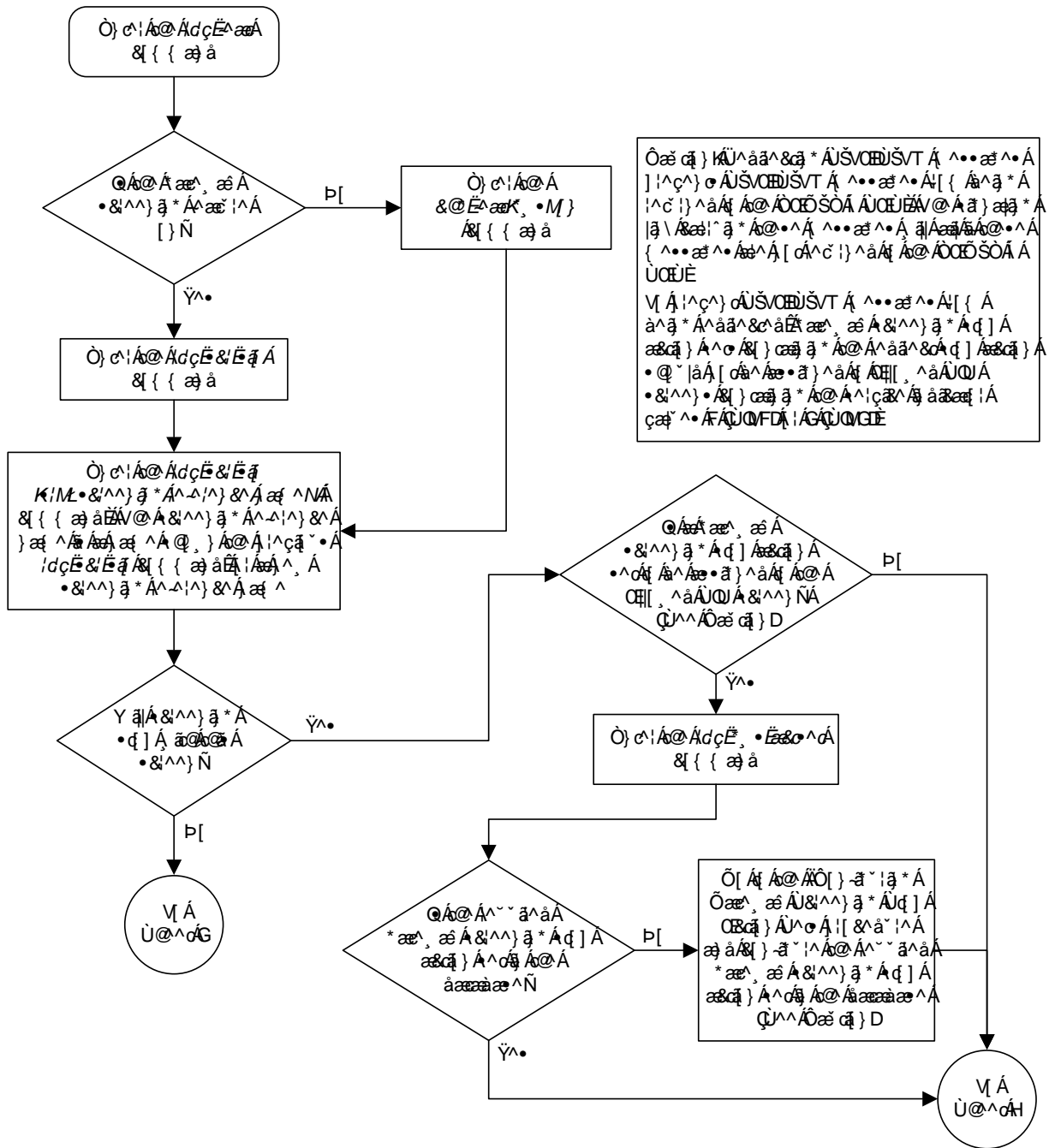

Flowchart 10-3. Adding an Allowed SIO Screen (Sheet 2 of 3)

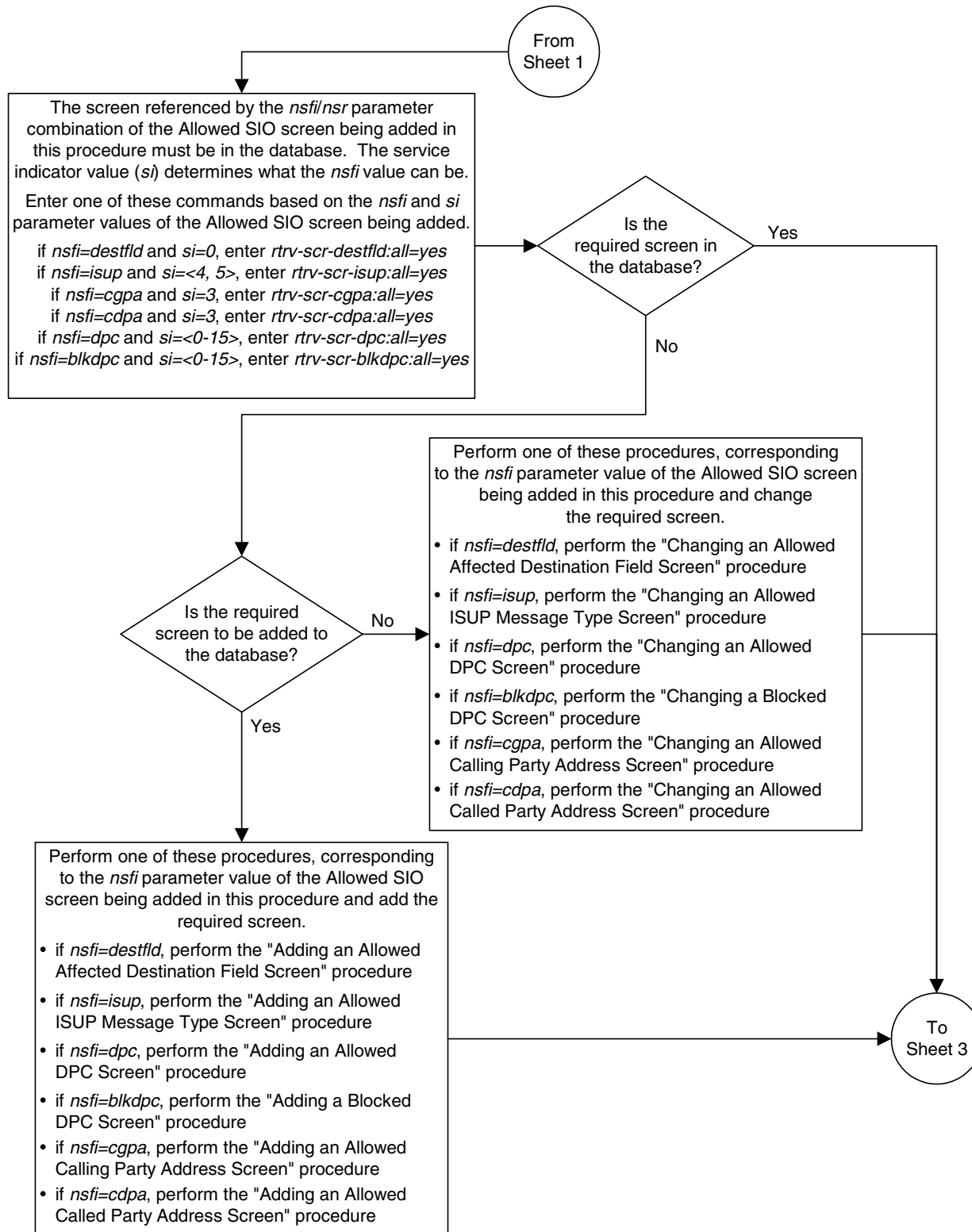



## Removing an Allowed SIO Screen

This procedure is used to remove an allowed signaling information octet (SIO) screen from the database using the `dlc-scr-sio` command. The parameters used by the `dlc-scr-sio` command are shown in the “Gateway Screening Attributes” section on page 2-7. The general rules that apply to configuring gateway screening entities are shown in the “Gateway Screening Configuration” section on page 2-28.

The example in this procedure removes the allowed SIO screen `ls02` from the database.

The allowed SIO screen can be referenced by one of the following screens.

- Screen Set
- Allowed OPC
- Blocked OPC

Enter the following commands to verify that none of these screens reference the allowed SIO screen being removed from the database.

- `rtrv-scrset:nsfi=sio`
- `rtrv-scr-opc:nsfi=sio`
- `rtrv-scr-blkopc:nsfi=sio`

To change the NSFI of any of these screens, go to one of the following procedures.

- “Changing a Screen Set” procedure on page 13-15
- “Changing an Allowed OPC Screen” procedure on page 12-25
- “Changing a Blocked OPC Screen” procedure on page 11-26

### Procedure

---

1. Display the allowed SIO screens in the database using the `rtrv-scr-sio` command. The following is an example of the possible output.

```
rlghncxa03w 05-09-25 15:25:30 GMT EAGLE5 34.0.0
SCREEN = ALLOWED SIO
SR   REF  RULES
IEC  YES   6
ISP1 YES   1
WRD2 YES   1
WRD4 YES   9
LS02 YES   1
TUP1 YES   2
```

From the `rtrv-scr-sio` output, display the allowed SIO screen you wish to remove using the `rtrv-scr-sio` command with the screening reference name. For this example, enter this command.

## Allowed Signaling Information Octet (SIO) Screen Configuration

```
rtrv-scr-sio:sr=ls02
```

The following is an example of the possible output.

```
rlghncxa03w 05-09-25 15:25:30 GMT EAGLE5 34.0.0
SCREEN = ALLOWED SIO
SR      NIC  PRI  SI  H0      H1      NSF1      NSR/ACT
LS02   2    3    3    --      --      CDPA     LS03
```

---

2. Enter the commands on page 10-20 to verify that the screen being removed is not referenced by other screens in the database. If the screen being removed is referenced by other screens, go to the procedures shown on page 10-20 and change the NSF1 of those screens to reference other screens or change the NSF1 of these screens to STOP.
- 

3. Remove the allowed SIO to the database using the **dlt-scr-sio** command.

The **dlt-scr-sio** command must be entered with these parameters: **sr**, **nic**, **si**, **pri**. The values for these parameters must be entered exactly as shown in the **rtrv-scr-sio** output in step 1. If the screen being removed has values for the **h0** and **h1** parameters, these values must be entered with the other parameter values. If the screen being removed contains dashes for the **h0** and **h1** parameters, the **h0** and **h1** parameters cannot be specified with the **dlt-scr-sio** command. For this example, enter this command.

```
dlt-scr-sio:sr=ls02:nic=2:si=3:pri=3
```

A message similar to the following should appear.

```
rlghncxa03w 05-09-25 15:26:30 GMT EAGLE5 34.0.0
DLT-SCR-SIO: SCREEN SET AFFECTED - LS02 0% FULL
DLT-SCR-SIO: MASP A - COMPLTD
```

---

4. Verify the changes using the **rtrv-scr-sio** command with the screening reference name used in step 3. For this example, enter this command.

```
rtrv-scr-sio:sr=ls02
```

The following is an example of the possible output.

```
E2573 Cmd Rej: SR or NSR does not reference an existing SR
```

This message shows that the specified screening reference name is not in the database and the action of the **dlt-scr-sio** command in step 3 was successful. If the specified screening reference name contained more than one entry when the **dlt-scr-sio** command was executed in step 3, the **rtrv-scr-sio:sr=** command output would show the remaining entries in the screening reference instead of error message E2573.

---

5. Backup the new changes using the **chg-db:action=backup:dest=fixed** command. The following messages should appear, the active Maintenance and Administration Subsystem Processor (MASP) appears first.

```
BACKUP (FIXED) : MASP A - Backup starts on active MASP.
BACKUP (FIXED) : MASP A - Backup on active MASP to fixed disk complete.
BACKUP (FIXED) : MASP A - Backup starts on standby MASP.
BACKUP (FIXED) : MASP A - Backup on standby MASP to fixed disk complete.
```

---

Flowchart 10-4. Removing an Allowed SIO Screen

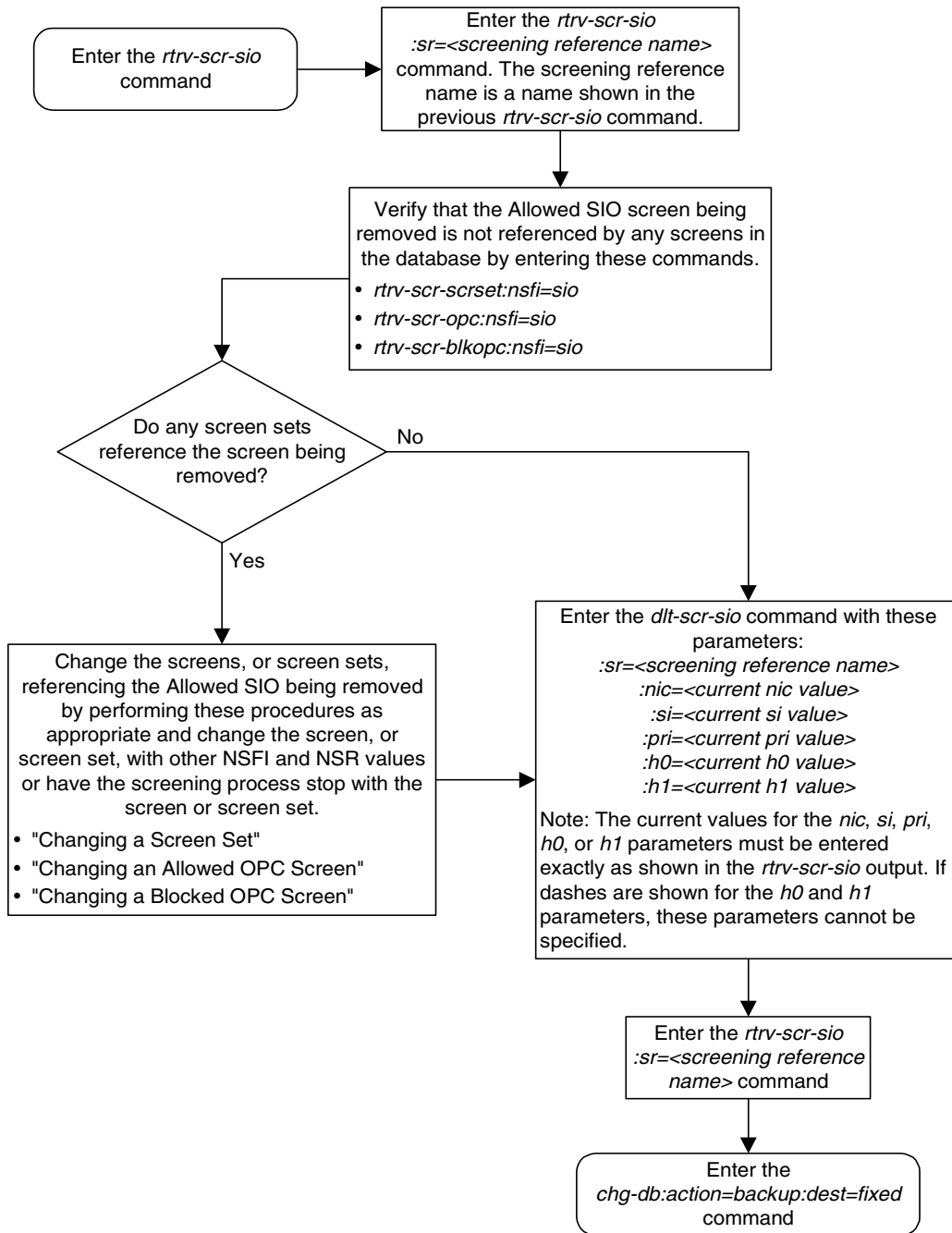

### Changing an Allowed SIO Screen

This procedure is used to change the attributes of an allowed signaling information octet (SIO) screen in the database using the **chg-scr-sio** command. The parameters used by the **chg-scr-sio** command are shown in the "Gateway Screening Attributes" section on page 2-7. The general rules that apply to configuring gateway screening entities are shown in the "Gateway Screening Configuration" section on page 2-28.

The example in this procedure change the allowed SIO screen **1s02** to an **nic** of 2, an **si** of 14, and an **nsfi** is stop.

The allowed SIO screen can reference one of the following screens.

- Allowed DPC
- Blocked DPC
- Allowed Affected Destination Field
- Allowed ISUP
- Allowed CGPA
- Allowed CDPA

Enter the following commands to verify that these screens are in the database.

- **rtrv-scr-dpc:all=yes**
- **rtrv-scr-blkdpc:all=yes**
- **rtrv-scr-destfld:all=yes**
- **rtrv-scr-isup:all=yes**
- **rtrv-scr-cgpa:all=yes**
- **rtrv-scr-cdpa:all=yes**

If the desired screen is not in the database, go to one of the following procedures and add the desired screen to the database or change an existing screen in the database.

- "Adding an Allowed DPC Screen" procedure on page 9-8
- "Adding a Blocked DPC Screen" procedure on page 8-8
- "Adding an Allowed Affected Destination Field Screen" procedure on page 7-7
- "Adding an Allowed ISUP Message Type Screen" procedure on page 15-9
- "Adding an Allowed Calling Party Address Screen" procedure on page 6-6
- "Adding an Allowed Called Party Address Screen" procedure on page 4-5
- "Changing an Allowed DPC Screen" procedure on page 9-26

- “Changing a Blocked DPC Screen” procedure on page 8-26
- “Changing an Allowed Affected Destination Field Screen” procedure on page 7-21
- “Changing an Allowed ISUP Message Type Screen” procedure on page 15-20
- “Changing an Allowed Calling Party Address Screen” procedure on page 6-23
- “Changing an Allowed Called Party Address Screen” procedure on page 4-22

The new values for the network indicator code, service indicator, priority, and heading codes being changed in the allowed SIO screen cannot be in that screen.

### Specifying a Range of Values

A range of values can be specified for the **pri**, **h0**, and **h1** parameters. If a range of values is specified for any of these parameters and the **nic** and **si** values in the screening reference name are not changed, the range of values for the **pri**, **h0**, or **h1** parameters cannot include any values that are currently provisioned for the screening reference name.

For example, screening reference name **scr1** contains these entries:

SR	NIC	PRI	SI	H0	H1	NSFI	NSR/ACT
SCR1	2	3	1	4	5	DPC	LS03
SCR1	2	2	1	2	7	BLKDPC	LS04

Another entry for screening reference **scr1** with the same **nic** and **si** values cannot be specified if:

- The range of values for the **pri** parameter includes the values 2 or 3
- The range of values for the **h0** parameter includes the values 2 or 4
- The range of values for the **h1** parameter includes the values 5 or 7.

### Changing H0 and H1 Values

The **h0** and **h1** values must be specified if the **si** value is 0, 1, or 2. If the **si** value is 3 through 15, the **h0** and **h1** parameters cannot be specified.

The **nh0** and **nh1** values must be specified if the **nsi** value is 0, 1, or 2. If the **nsi** value is 3 through 15, the **nh0** and **nh1** parameters cannot be specified.

The **h0** and **h1** parameters must be specified if either parameter is specified.

The **nh0** and **nh1** parameters must be specified if either parameter is specified.

The H0 and H1 heading code values can be a single value, a range of values with the beginning and end of the range separated by double ampersands (for example, a range of values from 2 to 9, 2&&9), or with an asterisk (\*). The asterisk specifies all possible values for the h0 and h1 parameters. Table 10-4 shows the valid combinations of these parameter values.



## Allowed Signaling Information Octet (SIO) Screen Configuration

**Table 10-4.** Valid Value Combinations for H0 and H1 Parameters

H0	H1
Single Value	Single Value
Single Value	Range of Values
Single Value	Asterisk
Range of Values	Asterisk
Asterisk	Asterisk

### Procedure

---

1. Display the allowed SIO screens in the database using the `rtrv-scr-sio` command. The following is an example of the possible output.

```
rlghncxa03w 05-09-25 15:25:30 GMT EAGLE5 34.0.0
SCREEN = ALLOWED SIO
SR   REF  RULES
IEC  YES   6
ISP1 YES   1
WRD2 YES   1
WRD4 YES   9
LS02 YES   1
TUP1 YES   2
```

From the `rtrv-scr-sio` output, display the allowed SIO screen you wish to change using the `rtrv-scr-sio` command with the screening reference name. For this example, enter this command.

```
rtrv-scr-sio:sr=ls02
```

The following is an example of the possible output.

```
rlghncxa03w 05-09-25 15:25:30 GMT EAGLE5 34.0.0
SCREEN = ALLOWED SIO
SR   NIC  PRI  SI  H0    H1    NSF1  NSR/ACT
LS02 2     3    3   --    --    CDPA  LS03
```

If a gateway screening stop action set is to be assigned to the allowed SIO screen being changed in the database, go to step 2.

Step 2 verifies the gateway screening stop action set names in the database. The gateway screening stop action set names are assigned only if the NSF1 of the screen being changed in this procedure is STOP. If the NSF1 of the screen will be changed to STOP, but a gateway screening stop action set name will not be assigned to the screen, skip steps 2 and 3 and go to step 4. If the NSF1 of the screen will not be STOP, skip step 2 and go to step 3.

---

2. Display the gateway screening stop action sets in the database with the `rtrv-gws-actset` command. This is an example of the possible output.

```
rlghncxa03w 05-09-25 15:26:30 GMT EAGLE5 34.0.0
ACT ACT ACT ACT ACT ACT ACT ACT ACT ACT ACT
ID NAME 1 2 3 4 5 6 7 8 9 10
-----
1 copy copy
2 rdct rdct
3 cr copy rdct
4 cncf cncf
5 cpncf copy cncf
6 cncfrd cncf rdct
7 cpcf rd copy cncf rdct
```

GWS action set table is (7 of 16) 44% full

If the required gateway screening stop action set is not in the database, go to the “Configuring Gateway Screening Stop Action Sets” procedure on page 2-54 and configure the required gateway screening stop action set.

---

**NOTE:** If the NSFI of the screen being changed in this procedure will be **STOP**, or if the NSFI of the screen is not being changed, skip step 3 and go to step 4.

3. Enter the commands on page 10-23 to verify that the screen that will be specified by the NSFI/NSR parameter combination in step 4 is in the database.

If the desired screen is not in the database, go to one of the procedures shown on pages 10-23 and 10-24 and either add the desired screen to the database or change an existing screen in the database.

4. Change the attributes of an allowed SIO screen using the `chg-scr-sio` command.

If a gateway screening stop action is to be assigned to the allowed SIO screen being changed, enter the `chg-scr-sio` command with the `nsfi=stop` parameter and the `actname` parameter with the name of a gateway screening stop action set shown in the output of the `rtrv-gws-actset` command executed in step 2.



**CAUTION:** Redirecting SLTA/SLTM messages prevents SLTA/SLTM messages from being returned to the EAGLE 5 SAS. The signaling link carrying these messages will fail if these messages are not returned to the EAGLE 5 SAS. To prevent SLTA/SLTM messages from being redirected, gateway screening stop action sets containing the redirect stop action should not be assigned to Allowed SIO screens containing the service indicator values 1 (SI=1) or 2 (SI=2).

The current values for the `nic`, `si`, `pri`, `h0` and `h1` parameters must be entered in the `chg-scr-sio` command exactly as shown in the `rtrv-scr-sio` output in step 1.

## Allowed Signaling Information Octet (SIO) Screen Configuration

The following list contains the values for **nnic**, **nsi**, **npri**, **nh0** and **nh1** parameters:

- **nnic** – 0 - 3, or an asterisk (\*)
- **nsi** – 0 - 15
- **npri** – 0 - 3, or an asterisk (\*)
- **nh0** – 0 - 15, or an asterisk (\*)
- **nh1** – 0 - 15, or an asterisk (\*)

A range of values can be specified for the **npri**, **nh0**, and **nh1** parameters. See the “Specifying a Range of Values” section on page 10-24 for more information. See the “Changing H0 and H1 Values” section on page 10-24 for information on how the asterisk and a range of values are used for the **nh0** and **nh1** parameters.

The value of the **nsfi** parameter is based on the value of the service indicator (**si**) parameter. Table 10-1 on page 10-3 shows the valid combinations of **nsfi** values and service indicator values.

For this example, enter this command.

```
chg-scr-sio:sr=ls02:nic=2:si=3:pri=3:nsi=14:nsfi=stop
```

A message similar to the following should appear.

```
rlghncxa03w 05-09-25 15:27:30 GMT EAGLE5 34.0.0
CHG-SCR-SIO: SCREEN SET AFFECTED - LS02 1% FULL
CHG-SCR-SIO: MASP A - COMPLTD
```

---

5. Verify the changes using the **rtrv-scr-sio** command with the screening reference name used in step 4. For this example, enter this command.

```
rtrv-scr-sio:sr=ls02
```

The following is an example of the possible output.

```
rlghncxa03w 05-09-25 15:28:30 GMT EAGLE5 34.0.0
SCREEN = ALLOWED SIO
SR    NIC  PRI  SI  H0    H1    NSFI  NSR/ACT
LS02  2     3   14  --    --    STOP  -----
```

---

6. Backup the new changes using the **chg-db:action=backup:dest=fixed** command. The following messages should appear, the active Maintenance and Administration Subsystem Processor (MASP) appears first.

```
BACKUP (FIXED) : MASP A - Backup starts on active MASP.
BACKUP (FIXED) : MASP A - Backup on active MASP to fixed disk complete.
BACKUP (FIXED) : MASP A - Backup starts on standby MASP.
BACKUP (FIXED) : MASP A - Backup on standby MASP to fixed disk complete.
```

---

Flowchart 10-5. Changing an Allowed SIO Screen (Sheet 1 of 3)

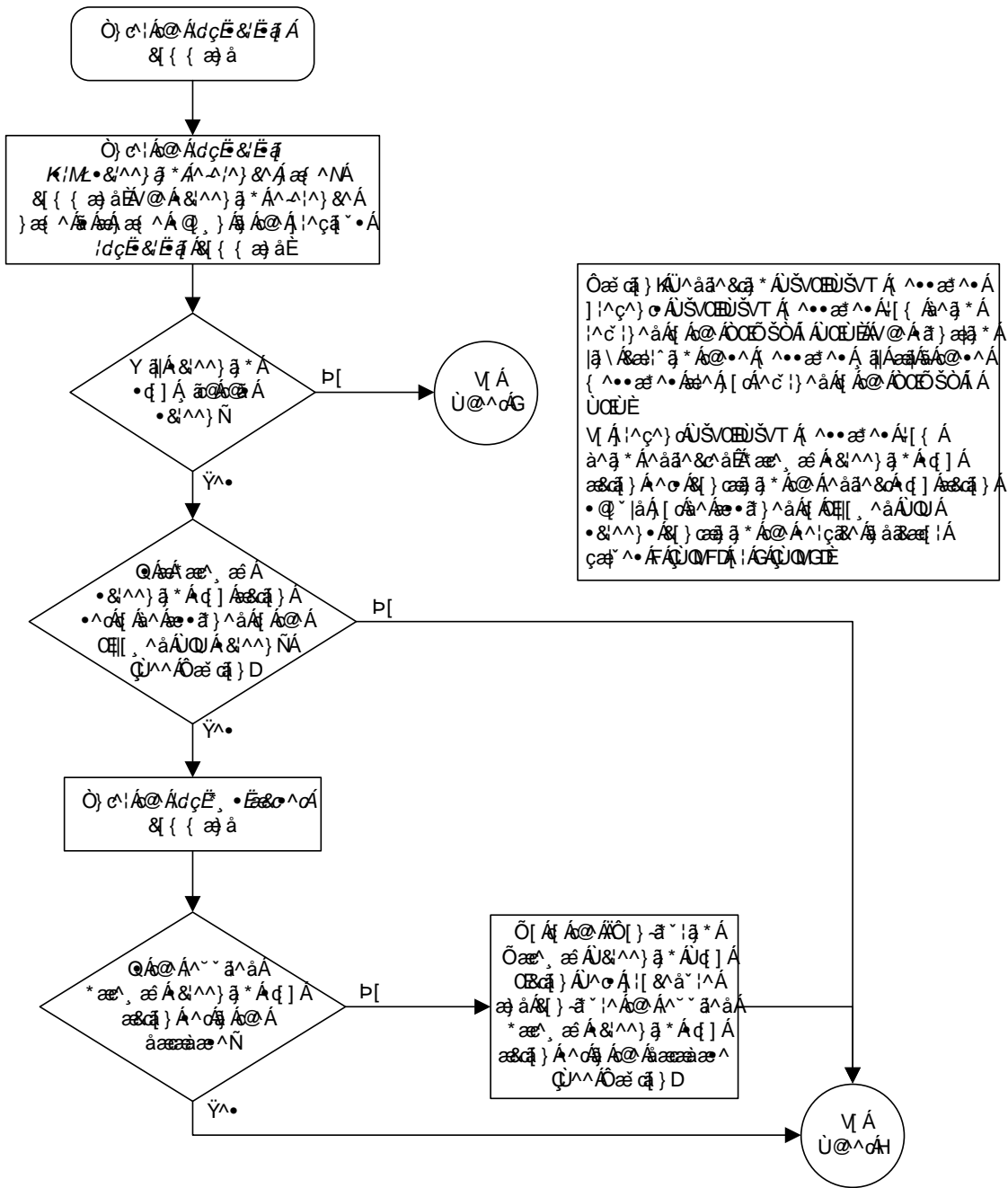

# Allowed Signaling Information Octet (SIO) Screen Configuration

Flowchart 10-5. Changing an Allowed SIO Screen (Sheet 2 of 3)

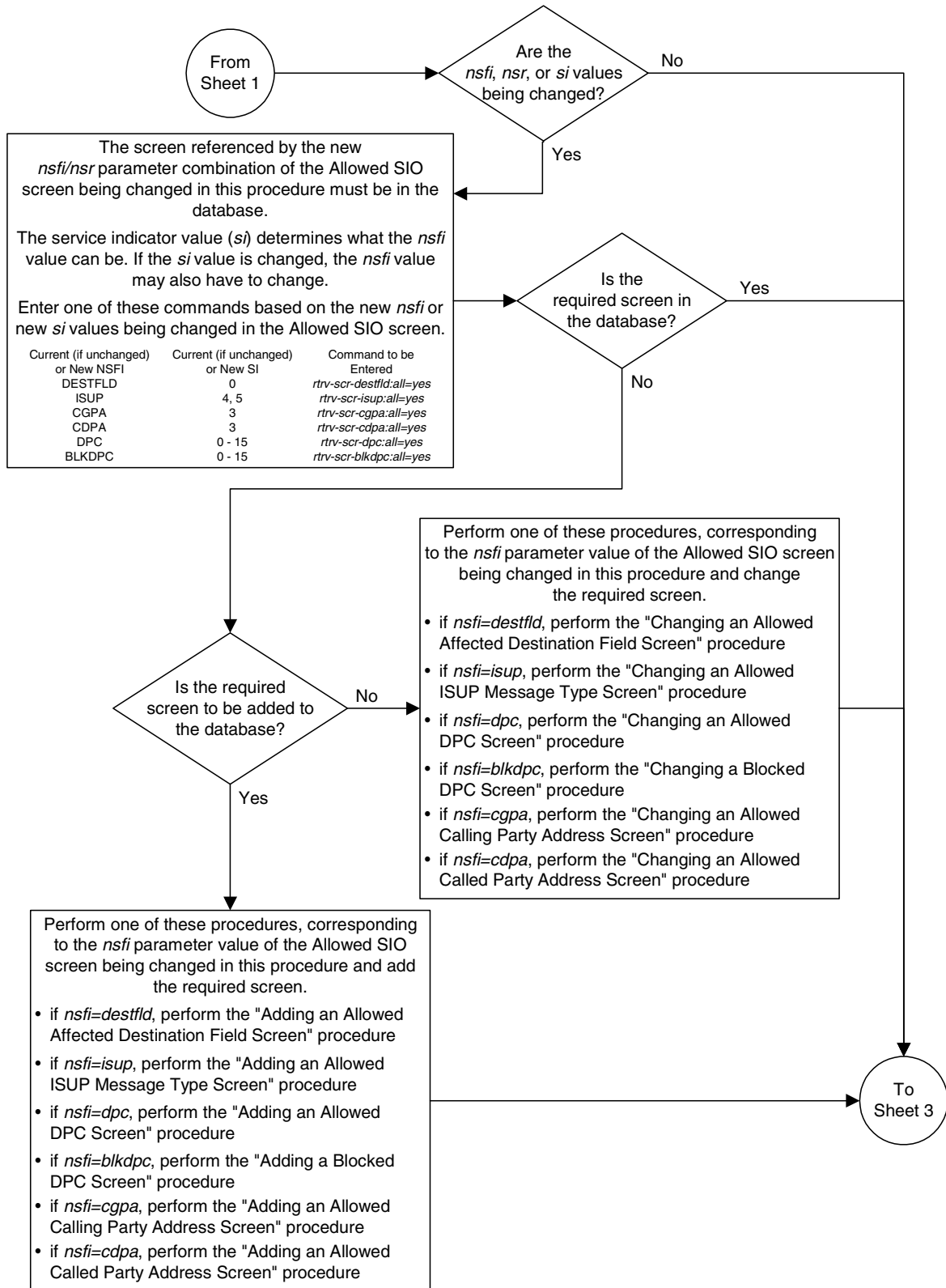



# 11

## Blocked Originating Point Code (BLKOPC) Screen Configuration

Introduction.....	11-2
Adding a Blocked OPC Screen .....	11-8
Removing a Blocked OPC Screen.....	11-22
Changing a Blocked OPC Screen.....	11-26

## Introduction

The blocked OPC screen identifies OPC's that are not allowed to send SS7 messages into the network. The gray shaded areas in Figure 11-1 shows the fields of the SS7 message that are checked by the blocked OPC screening function. If a match is found, the **nsfi** is equal to **fail**, the message is discarded and no further screening takes place. If no match is found, the **nsfi** is examined to determine the next step in the screening process. If the **nsfi** is equal to **stop**, the message is processed and no further screening takes place.

If the **nsfi** is equal to **stop**, and the **copy** gateway screening stop action is specified, the message is processed and a copy of the message is sent by the STP LAN feature to an external application through an ACM running the **stplan** application or a DCM running the **vxwslan** application.

If the **nsfi** is equal to **stop**, and the **rdct** (redirect) gateway screening stop action is specified, the message is diverted from the original destination and sent to another destination with the Database Transport Access feature, specified by global title translation, for further processing.

If the Calling Name Conversion Facility (CNCF) feature is on, the **nsfi** is equal to **stop**, and the **cncf** gateway screening stop action is specified, the PIP parameter in the incoming ISUP IAM message is converted to the GN parameter. The GN parameter in the incoming ISUP IAM message is converted to the PIP parameter. The message is then sent to the node specified by the DPC in the routing label in the message. For more information on the Calling Name Conversion Facility feature, see Chapter 14, "Calling Name Conversion Facility (CNCF) Configuration."

If the Triggerless LNP (TLNP) feature is on, the **nsfi** is equal to **stop**, and the **tlnp** gateway screening stop action is specified, ISUP IAMs that pass gateway screening are processed either by the ISUP NP with EPAP feature (if the ISUP NP with EPAP feature is enabled and turned on) or by the Triggerless LNP feature (if the Triggerless LNP feature is turned on). The ISUP NP with EPAP feature is discussed in more detail in the *Feature Manual - G-Port*. The Triggerless LNP feature is discussed in more detail in the *LNP Feature Activation Guide*.

If the **nsfi** is equal to anything else, the next screening reference (**nsr**) is identified and the screening process continues to the next screen identified by the **nsfi** and **nsr** parameters.

Flowchart 11-1 shows the screening action of the blocked OPC screen.



# Blocked Originating Point Code (BLKOPC) Screen Configuration

Flowchart 11-1. Blocked OPC Screening Action (Sheet 1 of 4)

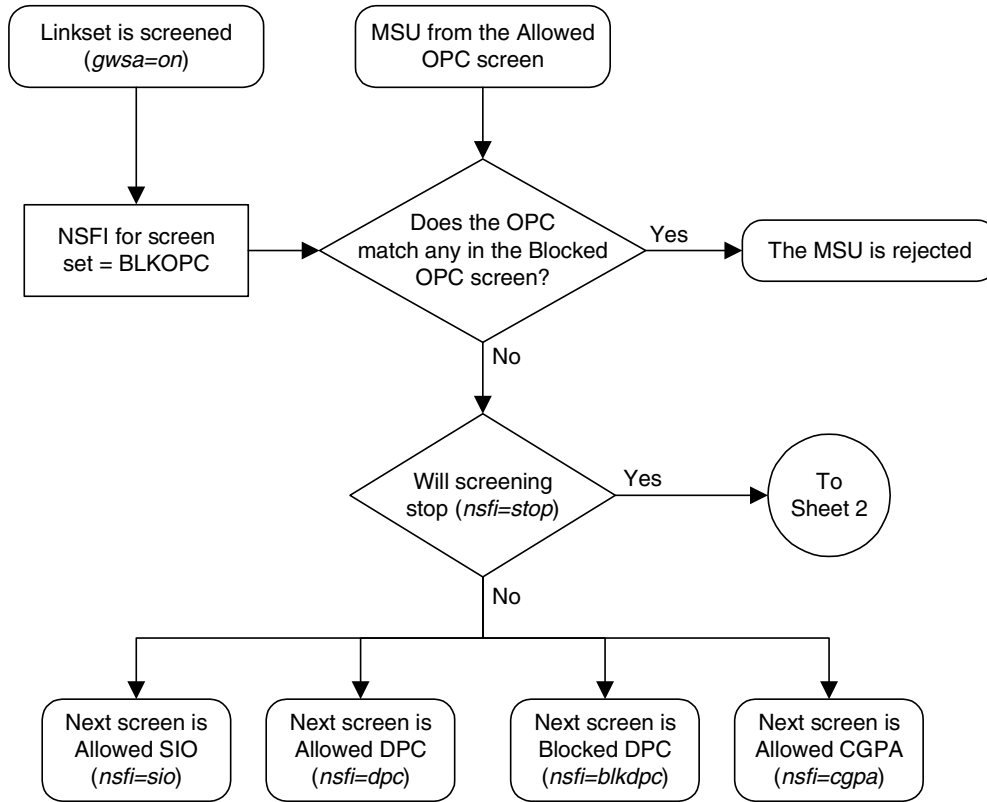

Flowchart 11-1. Blocked OPC Screening Action (Sheet 2 of 4)

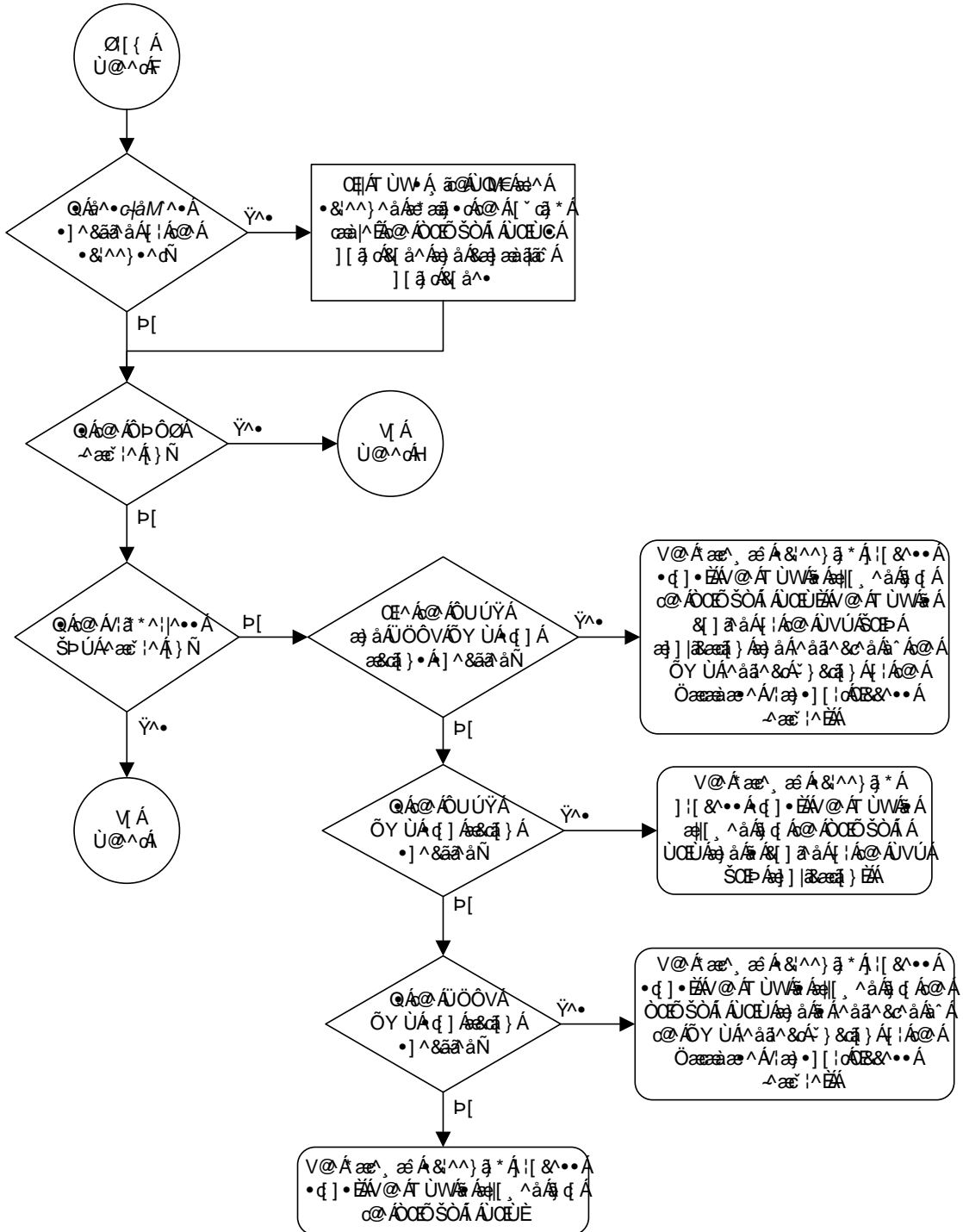

Blocked Originating Point Code (BLKOPC) Screen Configuration

Flowchart 11-1. Blocked OPC Screening Action (Sheet 3 of 4)

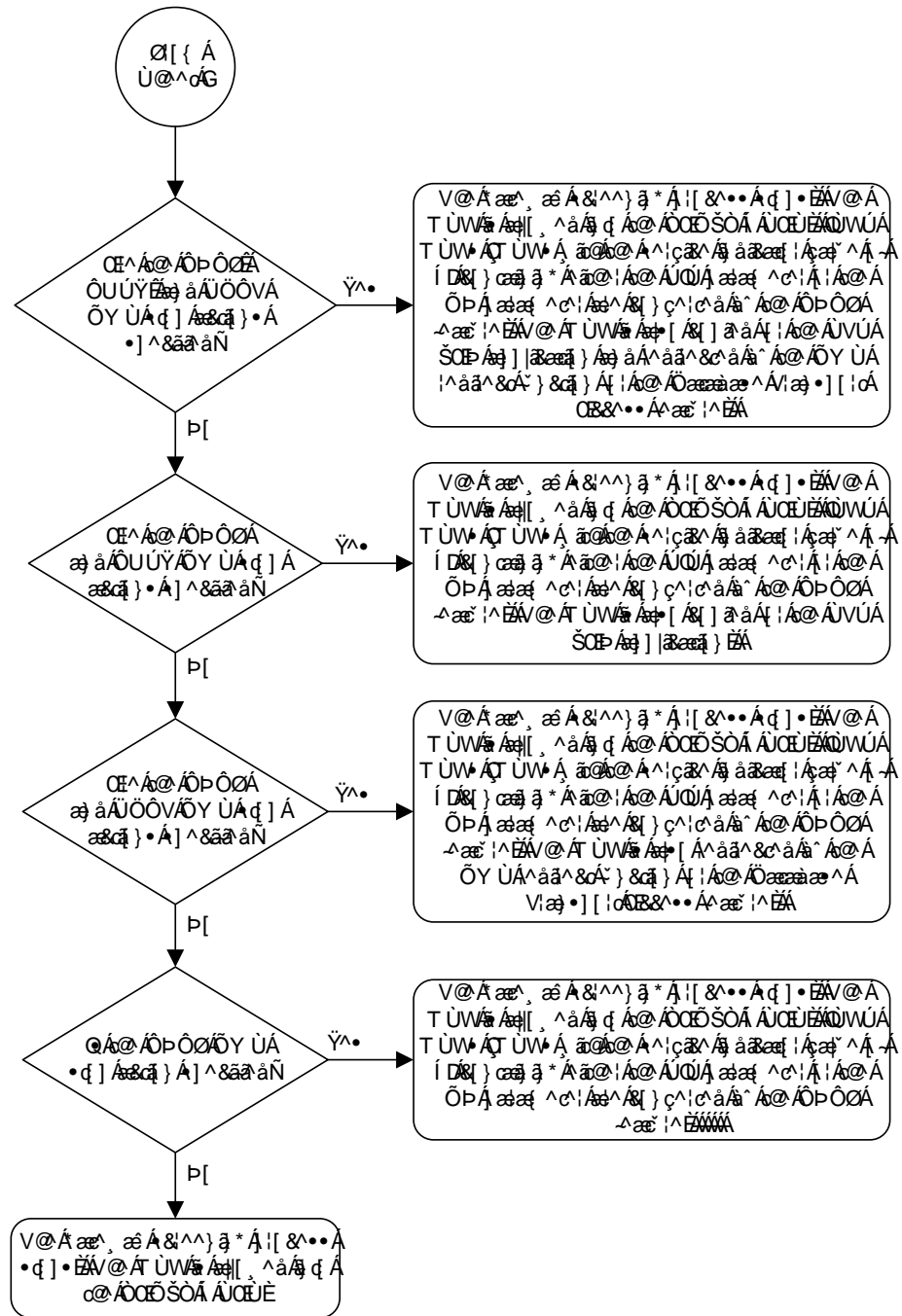

Blocked Originating Point Code (BLKOPC) Screen Configuration

Flowchart 11-1. Blocked OPC Screening Action (Sheet 4 of 4)

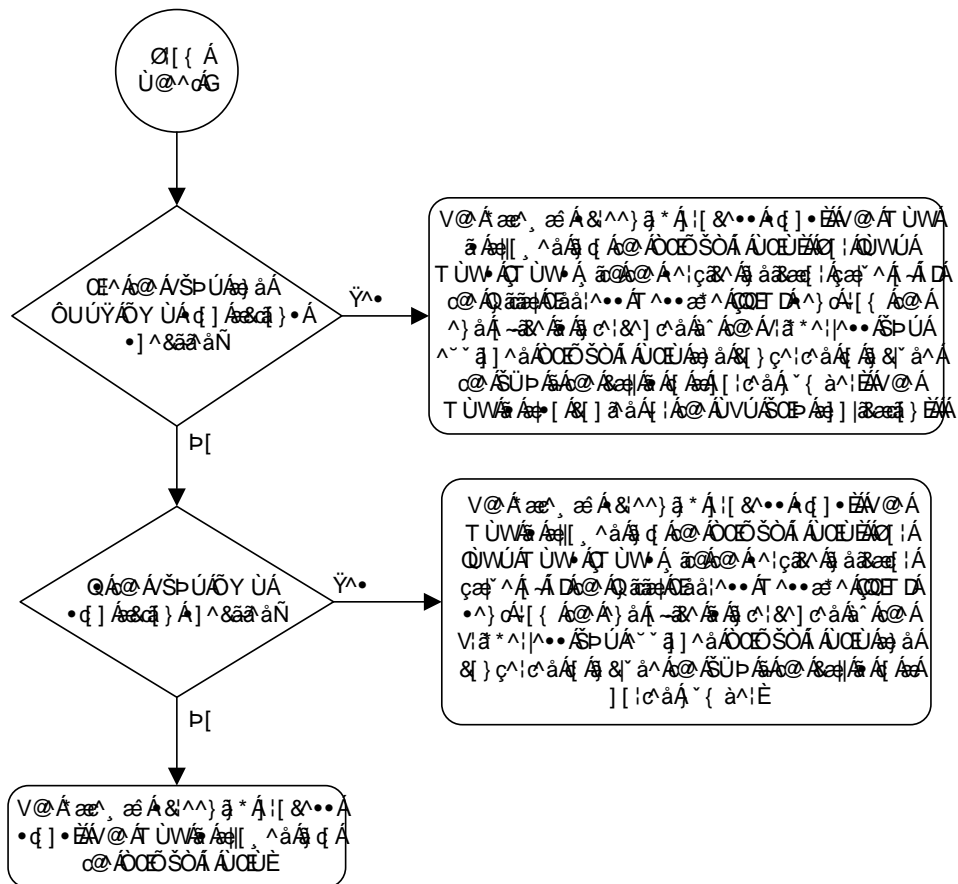

# Blocked Originating Point Code (BLKOPC) Screen Configuration

Figure 11-1. Blocked OPC Screening Functions

ANSI MSU (ANSI Message Signal Unit)

BSN FSN LI	SIO xx xx xxxx NIC PRI SI	SIF		
		DPC NCM NC NI	Routing Label OPC NCM NC NI	SLS xx

ITU-I MSU (ITU International Message Signal Unit)

BSN FSN LI	SIO xx xx xxxx NIC PRI SI	SIF		
		DPC ID AREA ZONE	Routing Label OPC ID AREA ZONE	SLS xx

14-Bit ITU-N MSU (14-Bit ITU National Message Signal Unit)

BSN FSN LI	SIO xx xx xxxx NIC PRI SI	SIF		
		DPC NPC	Routing Label OPC NPC	SLS xx

24-Bit ITU-N MSU (24-Bit ITU National Message Signal Unit)

BSN FSN LI	SIO xx xx xxxx NIC PRI SI	SIF		
		DPC SP SSA MSA	Routing Label OPC SP SSA MSA	SLS xx

## Adding a Blocked OPC Screen

This procedure is used to add a blocked originating point code (OPC) screen to the database using the `ent-scr-blkopc` command. The parameters used by the `ent-scr-blkopc` command are shown in the “Gateway Screening Attributes” section on page 2-7. The general rules that apply to configuring gateway screening entities are shown in the “Gateway Screening Configuration” section on page 2-28.

The examples in this procedure are used to add the blocked OPC screen data shown in Table 11-1 and based on the example configurations shown in Figure 2-3 on page 2-33, Figure 2-4 on page 2-35, and Figure 2-7 on page 2-41.

**Table 11-1.** Example Gateway Screening Blocked OPC Configuration Table

Screening Reference	ZONE	AREA	ID	NSFI	NSR
gws5	C	C	C	sio	iec
gws5	4	250	3	fail	----
Screening Reference	NI	NC	NCM	NSFI	NSR
fld3	C	C	C	sio	fld4
fld3	020	020	020	fail	----
gws3	C	C	C	dpc	gws9
gws3	001	002	002	fail	----
isp1	C	C	C	sio	isp1
isp1	025	025	025	fail	----

**NOTE:** If you using multiple-part ITU national point codes with gateway screening, see “14-Bit ITU National Point Code Formats” on page 2-24.

The blocked OPC screen can reference one of the following screens.

- Allowed SIO
- Allowed DPC
- Blocked DPC
- Allowed CGPA

Enter the following commands to verify that these screens are in the database.

- `rtrv-scr-sio:all=yes`
- `rtrv-scr-dpc:all=yes`

## Blocked Originating Point Code (BLKOPC) Screen Configuration

- `rtrv-scr-blkdpc:all=yes`
- `rtrv-scr-cgpa:all=yes`

If the desired screen is not in the database, go to one of the following procedures and add the desired screen to the database or change an existing screen in the database.

- “Adding an Allowed SIO Screen” procedure on page 10-9
- “Adding an Allowed DPC Screen” procedure on page 9-8
- “Adding a Blocked DPC Screen” procedure on page 8-8
- “Adding an Allowed Calling Party Address Screen” procedure on page 6-6
- “Changing an Allowed SIO Screen” procedure on page 10-23
- “Changing an Allowed DPC Screen” procedure on page 9-26
- “Changing a Blocked DPC Screen” procedure on page 8-26
- “Changing an Allowed Calling Party Address Screen” procedure on page 6-23

For the first entry for a specific screening reference, the value for the point code must be `c`, and the NSFI must be either `stop`, `sio`, `dpc`, `blkdpc`, or `cgpa`. If the NSFI is `stop`, the screening of the message will stop at the specified blocked OPC screen. If the NSFI is either `sio`, `dpc`, `blkdpc`, or `cgpa`, then any message containing a point code that is not listed in the blocked OPC screen with a NSFI equal to `fail`, will continue to be screened with either the allowed SIO, allowed DPC, blocked DPC, or the allowed CGPA screen.

All subsequent entries for that screening reference must contain a numeric point code value, the NSFI must be equal to `fail`, and the `nsr` parameter cannot be specified. Any message that contains an OPC in the blocked OPC screen with the NSFI equal to `fail` will be rejected from the network and the screening process is stopped.

The `pcst` parameter, specifying whether or not the ITU-I or 14-bit ITU-N point code is a spare point code, cannot be used with the `zone=c` or `npc=c` parameters.

### Specifying a Range of Values

A range of values can be specified for the point code parameters `ni`, `nc`, or `ncm`.

If a range of values is specified for any of these parameters, and the value of the other parameters match existing values for the screening reference name, the range of values for the point code parameter cannot include any values for that parameter that are currently provisioned for the screening reference name.

For example, screening reference name `scr1` contains these entries:

SR	NI	NC	NCM	NSFI	NSR/ACT
SCR1	240	001	010	FAIL	-----
SCR1	241	010	020	FAIL	-----

## Blocked Originating Point Code (BLKOPC) Screen Configuration

Another entry for screening reference **scr1** with the **ni** value of 240 and the **nc** value of 001 cannot be specified if the range of values for the **ncm** parameter includes the value 010.

The ANSI point code parameter values can be specified as a single value, a range of values, or with an asterisk (\*). The asterisk specifies all possible values for the **ni**, **nc**, and **ncm** parameters. Table 11-2 shows the valid combinations of these parameter values.

**Table 11-2.** Valid Value Combinations for ANSI Point Code Parameters

NI	NC	NCM
Single Value	Single Value	Single Value
Single Value	Single Value	Range of Values
Single Value	Single Value	Asterisk
Single Value	Range of Values	Asterisk
Single Value	Asterisk	Asterisk
Range of Values	Asterisk	Asterisk
Asterisk	Asterisk	Asterisk

A range of values can also be specified for an ITU-I or 24-bit ITU-N point code parameter using a combination of asterisks (\*) and single values for the point code parameters. Table 11-3 shows the valid combinations of the ITU-I parameter values. Table 11-4 shows the valid combinations of the 24-bit ITU-N parameter values.

**Table 11-3.** Valid Value Combinations for ITU-I Point Code Parameters

ZONE	AREA	ID
Single Value	Single Value	Single Value
Single Value	Single Value	Asterisk
Single Value	Asterisk	Asterisk
Asterisk	Asterisk	Asterisk



## Blocked Originating Point Code (BLKOPC) Screen Configuration

**Table 11-4.** Valid Value Combinations for 24-Bit ITU-N Point Code Parameters

MSA	SSA	SP
Single Value	Single Value	Single Value
Single Value	Single Value	Asterisk
Single Value	Asterisk	Asterisk
Asterisk	Asterisk	Asterisk

### Procedure

---

1. Verify that the gateway screening feature is on, by entering the `rtrv-feat` command. If the gateway screening feature is on, the `GWS` field is set to `on`.

**NOTE:** The `rtrv-feat` command output contains other fields that are not used by this procedure. If you wish to see all the fields displayed by the `rtrv-feat` command, see the `rtrv-feat` command description in the *Commands Manual*.

If the gateway screening feature is on, shown by the entry `GWS = on` in the `rtrv-feat` command output, skip step 2, and go to step 3.

---

2. Turn the gateway screening feature on by entering this command.

```
chg-feat:gws=on
```

**NOTE:** Once the gateway screening feature is turned on with the `chg-feat` command, it cannot be turned off.

The gateway screening feature must be purchased before you turn this feature on with the `chg-feat` command. If you are not sure if you have purchased the gateway screening feature, contact your Tekelec Sales Representative or Account Representative.

When the `chg-feat` has successfully completed, this message should appear.

```
rlghncxa03w 05-09-28 11:43:04 GMT EAGLE5 34.0.0  
CHG-FEAT: MASP A - COMPLTD
```

---

## Blocked Originating Point Code (BLKOPC) Screen Configuration

3. Display all blocked OPC screens in the database using the `rtrv-scr-blkopc` command. The following is an example of the possible output.

```
rlghncxa03w 05-09-25 15:25:30 GMT EAGLE5 34.0.0
SCREEN = BLOCKED OPC
SR    REF  RULES
IEC   YES   2
WRD2  YES   1
WRD4  YES   9
```

If the screening reference names that you wish to add with this procedure are not shown in the `rtrv-scr-blkopc` command output, go to step 4. For this example, the screening reference names are not shown. If these screening reference names are shown in the `rtrv-scr-blkopc` command output, make sure the screening data you wish to enter is not already in the database by entering the `rtrv-scr-blkopc` command with the screening reference name. For example, enter the `rtrv-scr-blkopc:sr=iec` command. The following is an example of the possible output.

```
rlghncxa03w 05-09-25 15:26:30 GMT EAGLE5 34.0.0
SCREEN = BLOCKED OPC
SR    NI      NC      NCM      NSFI      NSR/ACT
IEC   240     001     010     FAIL     -----
IEC   241     010     *       FAIL     -----

SR    ZONE   AREA   ID      NSFI      NSR/ACT
IEC   1      003   4       FAIL     -----
IEC   1      003   5       FAIL     -----

SR    NI      NC      NCM      NSFI      NSR/ACT
IEC   C      C      C       STOP     CR

SR    NPC
IEC   00235
      NSFI      NSR
      FAIL     -----

SR    NI      NC      NCM      NSFI      NSR/ACT
WRD2  243     015     001     STOP     -----
WRD2  243     105     002     FAIL     -----
WRD2  C      C      C       STOP     -----
```

If a gateway screening stop action set is to be assigned to the blocked OPC screen being added to the database, go to step 4.

Step 4 verifies the gateway screening stop action set names in the database. The gateway screening stop action set names are assigned only if the NSFI of the screen being added in this procedure is STOP. If the NSFI of the new screen will be STOP, but a gateway screening stop action set name will not be assigned to the new screen, skip steps 4 and 5 and go to step 6. If the NSFI of the new screen is not STOP, skip step 4 and go to step 5.

---

## Blocked Originating Point Code (BLKOPC) Screen Configuration

4. Display the gateway screening stop action sets in the database with the **rtrv-gws-actset** command. This is an example of the possible output.

```
rlghncxa03w 05-09-25 15:28:30 GMT EAGLE5 34.0.0
ACT  ACT  ACT  ACT  ACT  ACT  ACT  ACT  ACT  ACT  ACT  ACT
ID  NAME  1    2    3    4    5    6    7    8    9    10
--  -----
1   copy  copy
2   rdct  rdct
3   cr    copy rdct
4   cnf   cnf
5   cpnf  copy cnf
6   cnfrd cnf  rdct
7   cpfrd copy cnf rdct

GWS action set table is (7 of 16) 44% full
```

If the required gateway screening stop action set is not in the database, go to the "Configuring Gateway Screening Stop Action Sets" procedure on page 2-54 and configure the required gateway screening stop action set.

---

**NOTE:** If the NSFI of the screen being added in this procedure is STOP or FAIL, skip step 5 and go to step 6.

5. Enter the commands on page 11-8 to verify that the screen that will be specified by the NSFI/NSR parameter combination in step 7 is in the database.

If the desired screen is not in the database, go to one of the procedures shown on page 11-9 and either add the desired screen to the database or change an existing screen in the database.

---

**NOTE:** If the point code being added in this procedure is not an ITU-I or 14-bit ITU-N spare point code, skip this step and to to step 7.

**NOTE:** If the point code being added in this procedure is an ITU-I or 14-bit ITU-N spare point code and the screening reference contains ITU-I or 14-bit ITU-N spare point codes, skip this step and go to step 7.

6. Display the status of the ITU National and International Spare Point Code Support feature by entering the **rtrv-ctrl-feat** command with the ITU National and International Spare Point Code Support feature part number. Enter this command.

```
rtrv-ctrl-feat:partnum=893013601
```

This is an example of the possible output.

```
rlghncxa03w 05-09-25 15:25:30 GMT EAGLE5 34.0.0
The following features have been permanently enabled:

Feature Name                Partnum  Status  Quantity
Spare Point Code Support    893013601 on      ----
```

The following features have been temporarily enabled:

## Blocked Originating Point Code (BLKOPC) Screen Configuration

Feature Name	Partnum	Status	Quantity	Trial	Period	Left
Zero entries found.						

The following features have expired temporary keys:

Feature Name	Partnum
Zero entries found.	

If the ITU National and International Spare Point Code Support feature is enabled, go to step 7.

If the ITU National and International Spare Point Code Support feature is not enabled, perform the “Activating the ITU National and International Spare Point Code Support Feature” procedure in the *Database Administration Manual - SS7* to enable the ITU National and International Spare Point Code Support feature as required. After the feature has been enabled, go to step 7.

- 
7. Add a new blocked OPC screen to the database using the `ent-scr-blkopc` command.

If a gateway screening stop action is to be assigned to the blocked OPC screen being changed, enter the `ent-scr-blkopc` command with the `nsfi=stop` parameter and the `actname` parameter with the name of a gateway screening stop action set shown in the output of the `rtrv-gws-actset` command executed in step 4.

The following list contains the values for `ni`, `nc`, `ncm`, `zone`, `area`, `id`, `npc`, `msa`, `ssa`, and `sp` parameters:

- `ni` – 0 - 255, c, or an asterisk (\*)
- `nc` – 0 - 255, c, or an asterisk (\*)
- `ncm` – 0 - 255, c, or an asterisk (\*)
- `zone` – 0 - 7, c, or an asterisk (\*)
- `area` – 0 - 255, c, or an asterisk (\*)
- `id` – 0 - 7, c, or an asterisk (\*)
- `npc` – 1 - 16383, c, or an asterisk (\*)
- `msa` – 0 - 255, c, or an asterisk (\*)
- `ssa` – 0 - 255, c, or an asterisk (\*)
- `sp` – 0 - 255, c, or an asterisk (\*)

A range of values can be specified for the `ni`, `nc`, and `ncm` parameters. See the “Specifying a Range of Values” section on page 11-9 for more information on how the asterisk and a range of values are used for the `ni`, `nc`, and `ncm` parameters.

To add a spare point code to the blocked OPC screen, the `pcst=s` parameter must be specified. To add a non-spare point code to the blocked OPC screen, the `pcst` parameter does not have to be specified. If the `pcst` parameter is

## Blocked Originating Point Code (BLKOPC) Screen Configuration

specified for a screen containing an ITU-I or 14-bit ITU-N non-spare point code, the value must be **none**. The **pcst** parameter cannot be used with the **zone=c** or **npc=c** parameters.

For this example, enter these commands.

```
ent-scr-blkopc:sr=gws5:zone=c:area=c:id=c:nsfi=sio:nsr=iec
```

A message similar to the following should appear.

```
rlghncxa03w 05-09-25 15:29:30 GMT EAGLE5 34.0.0  
ENT-SCR-BLKOPC: SCREEN SET AFFECTED - GWS5 1% FULL  
ENT-SCR-BLKOPC: MASP A - COMPLTD
```

```
ent-scr-blkopc:sr=gws5:zone=4:area=250:id=3:nsfi=fail
```

A message similar to the following should appear.

```
rlghncxa03w 05-09-25 15:30:30 GMT EAGLE5 34.0.0  
ENT-SCR-BLKOPC: SCREEN SET AFFECTED - GWS5 1% FULL  
ENT-SCR-BLKOPC: MASP A - COMPLTD
```

```
ent-scr-blkopc:sr=gws3:ni=c:nc=c:ncm=c:nsfi=dpc:nsr=gws9
```

A message similar to the following should appear.

```
rlghncxa03w 05-09-25 15:31:30 GMT EAGLE5 34.0.0  
ENT-SCR-BLKOPC: SCREEN SET AFFECTED - GWS7 1% FULL  
ENT-SCR-BLKOPC: MASP A - COMPLTD
```

```
ent-scr-blkopc:sr=gws3:ni=001:nc=002:ncm=002:nsfi=fail
```

A message similar to the following should appear.

```
rlghncxa03w 05-09-25 15:32:30 GMT EAGLE5 34.0.0  
ENT-SCR-BLKOPC: SCREEN SET AFFECTED - GWS7 1% FULL  
ENT-SCR-BLKOPC: MASP A - COMPLTD
```

```
ent-scr-blkopc:sr=fld3:ni=c:nc=c:ncm=c:nsfi=sio:nsr=fld4
```

A message similar to the following should appear.

```
rlghncxa03w 05-09-25 15:33:30 GMT EAGLE5 34.0.0  
ENT-SCR-BLKOPC: SCREEN SET AFFECTED - FLD3 1% FULL  
ENT-SCR-BLKOPC: MASP A - COMPLTD
```

```
ent-scr-blkopc:sr=fld3:ni=020:nc=020:ncm=020:nsfi=fail
```

A message similar to the following should appear.

```
rlghncxa03w 05-09-25 15:34:30 GMT EAGLE5 34.0.0  
ENT-SCR-BLKOPC: SCREEN SET AFFECTED - FLD3 1% FULL  
ENT-SCR-BLKOPC: MASP A - COMPLTD
```

```
ent-scr-blkopc:sr=isp1:ni=c:nc=c:ncm=c:nsfi=sio:nsr=isp1
```

A message similar to the following should appear.

```
rlghncxa03w 05-09-25 15:33:30 GMT EAGLE5 34.0.0  
ENT-SCR-BLKOPC: SCREEN SET AFFECTED - ISP1 1% FULL  
ENT-SCR-BLKOPC: MASP A - COMPLTD
```

```
ent-scr-blkopc:sr=isp1:ni=025:nc=025:ncm=025:nsfi=fail
```

A message similar to the following should appear.

```
rlghncxa03w 05-09-25 15:34:30 GMT EAGLE5 34.0.0  
ENT-SCR-BLKOPC: SCREEN SET AFFECTED - ISP1 1% FULL  
ENT-SCR-BLKOPC: MASP A - COMPLTD
```

---

8. Verify the changes using the **rtrv-scr-blkopc** command with the screening reference name used in step 7. For this example, enter these commands.

```
rtrv-scr-blkopc:sr=gws5
```

The following is an example of the possible output.

```
rlghncxa03w 05-09-25 15:35:30 GMT EAGLE5 34.0.0
SCREEN = BLOCKED OPC
SR      ZONE  AREA  ID      NSFI    NSR/ACT
GWS5   4     250  3      FAIL    -----
GWS5   C     C     C      SIO     IEC
```

```
rtrv-scr-blkopc:sr=gws3
```

The following is an example of the possible output.

```
rlghncxa03w 05-09-25 15:25:30 GMT EAGLE5 34.0.0
SCREEN = BLOCKED OPC
SR      NI     NC     NCM     NSFI    NSR/ACT
GWS3   002    002    002    FAIL    -----
GWS3   C     C     C      DPC     GWS9
```

```
rtrv-scr-blkopc:sr=fld3
```

The following is an example of the possible output.

```
rlghncxa03w 05-09-25 15:36:30 GMT EAGLE5 34.0.0
SCREEN = BLOCKED OPC
SR      NI     NC     NCM     NSFI    NSR/ACT
FLD3   020    020    020    FAIL    -----
FLD3   C     C     C      DPC     FLD4
```

```
rtrv-scr-blkopc:sr=isp1
```

The following is an example of the possible output.

```
rlghncxa03w 05-09-25 15:36:30 GMT EAGLE5 34.0.0
SCREEN = BLOCKED OPC
SR      NI     NC     NCM     NSFI    NSR/ACT
ISP1   025    025    025    FAIL    -----
ISP1   C     C     C      SIO     ISP1
```

9. Backup the new changes using the **chg-db:action=backup:dest=fixed** command. The following messages should appear, the active Maintenance and Administration Subsystem Processor (MASP) appears first.

```
BACKUP (FIXED) : MASP A - Backup starts on active MASP.
BACKUP (FIXED) : MASP A - Backup on active MASP to fixed disk complete.
BACKUP (FIXED) : MASP A - Backup starts on standby MASP.
BACKUP (FIXED) : MASP A - Backup on standby MASP to fixed disk complete.
```

# Blocked Originating Point Code (BLKOPC) Screen Configuration

Flowchart 11-2. Adding a Blocked OPC Screen (Sheet 1 of 5)

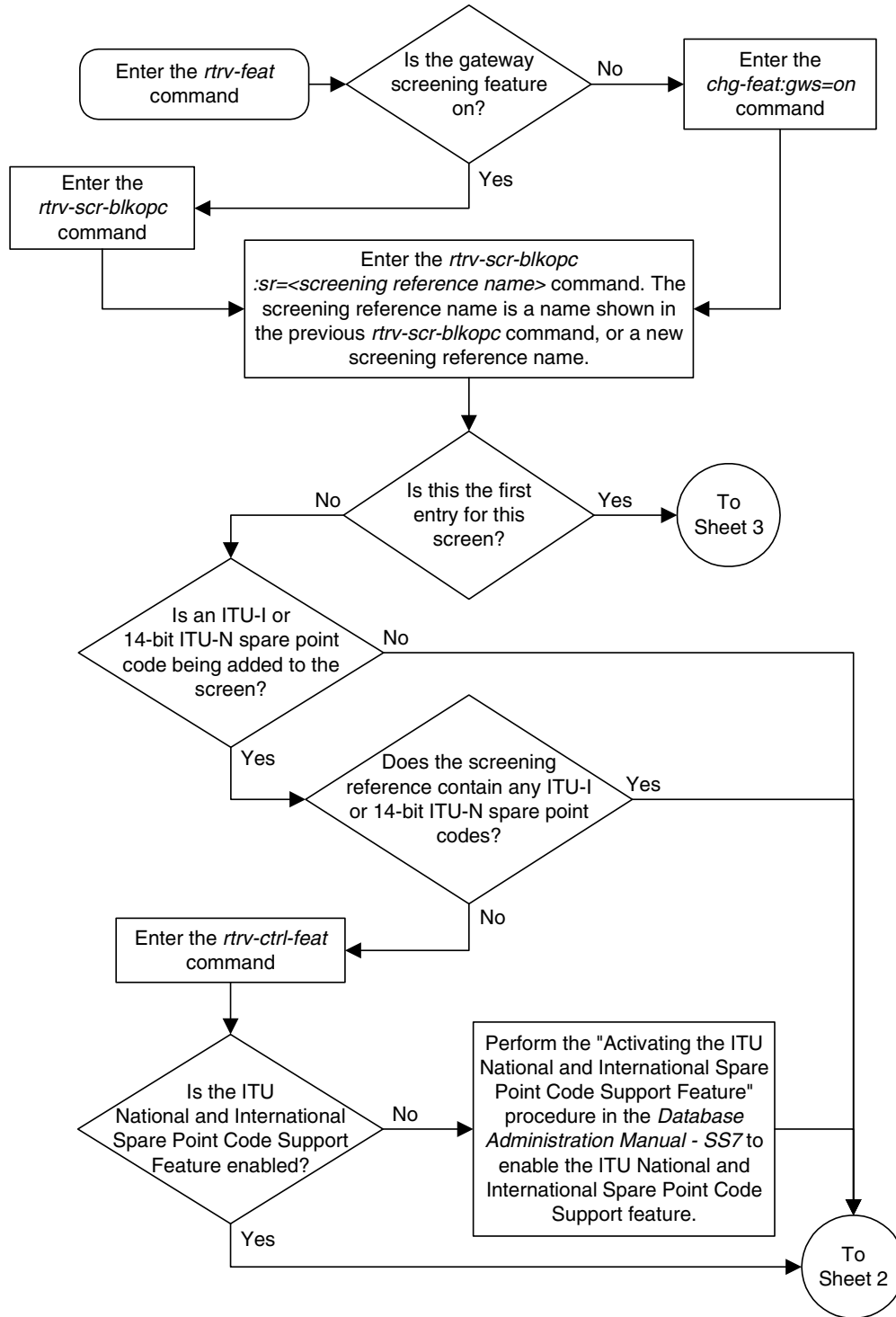

Flowchart 11-2. Adding a Blocked OPC Screen (Sheet 2 of 5)

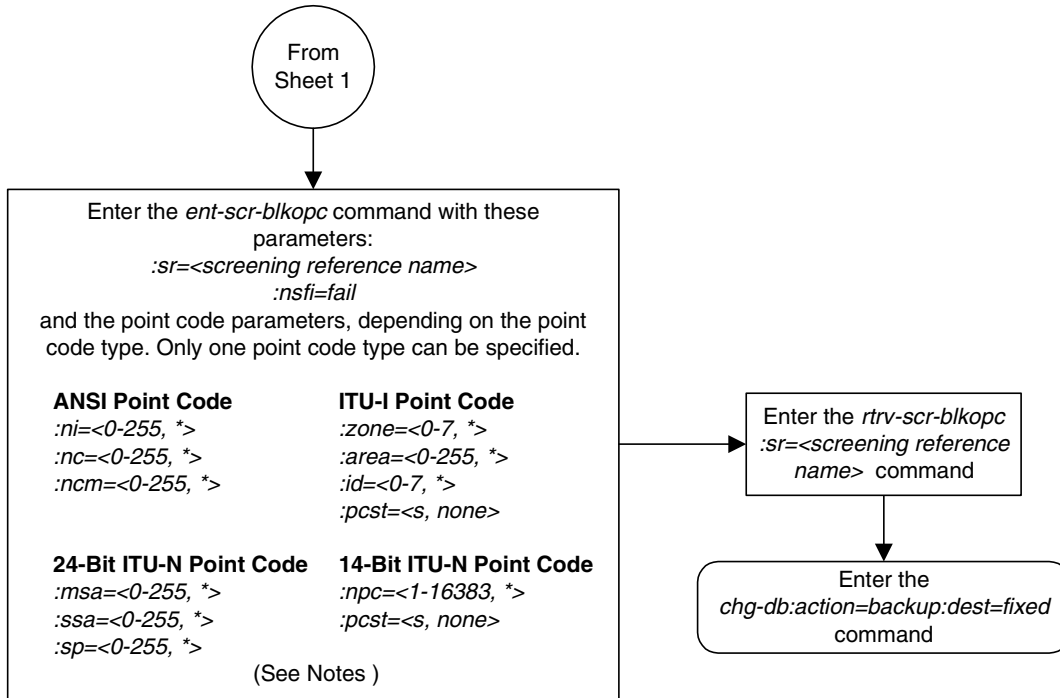

**Notes:**

1. A range of values can be specified for the *ni*, *nc*, or *ncm* parameters by inserting double ampersands (&&) between the parameter values defining the range. For example, to specify the range 025 to 200 for the *ni* parameter, enter 025&&200 for the *ni* parameter value.
  2. The asterisk (\*) specifies the entire range of values for that parameter.
- For more information about specifying a range of values and about using the asterisk, see the "Gateway Screening Attributes" section in Chapter 2 and the "Specifying a Range of Values" section in this procedure.
3. To add a non-spare point code, the *pcst* parameter does not have to be specified. If the *pcst* parameter is specified for a screen containing an ITU-I or 14-bit ITU-N non-spare point code, the value must be *none*.
  4. To add a spare point code, the *pcst=s* parameter must be specified.



# Blocked Originating Point Code (BLKOPC) Screen Configuration

Flowchart 11-2. Adding a Blocked OPC Screen (Sheet 3 of 5)

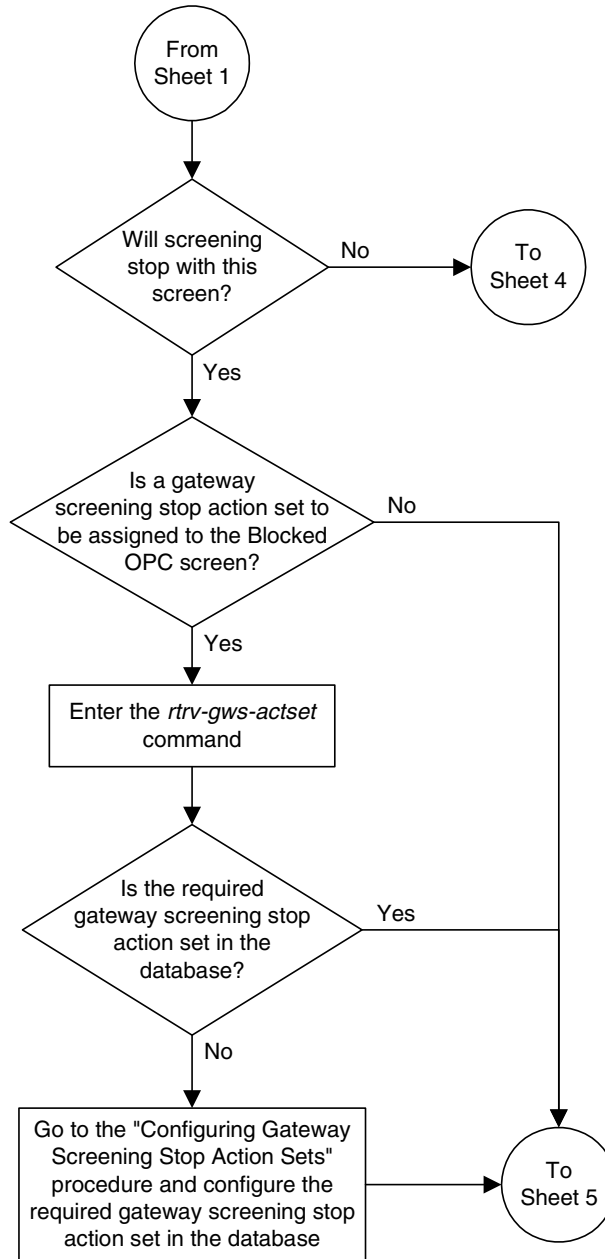

Flowchart 11-2. Adding a Blocked OPC Screen (Sheet 4 of 5)

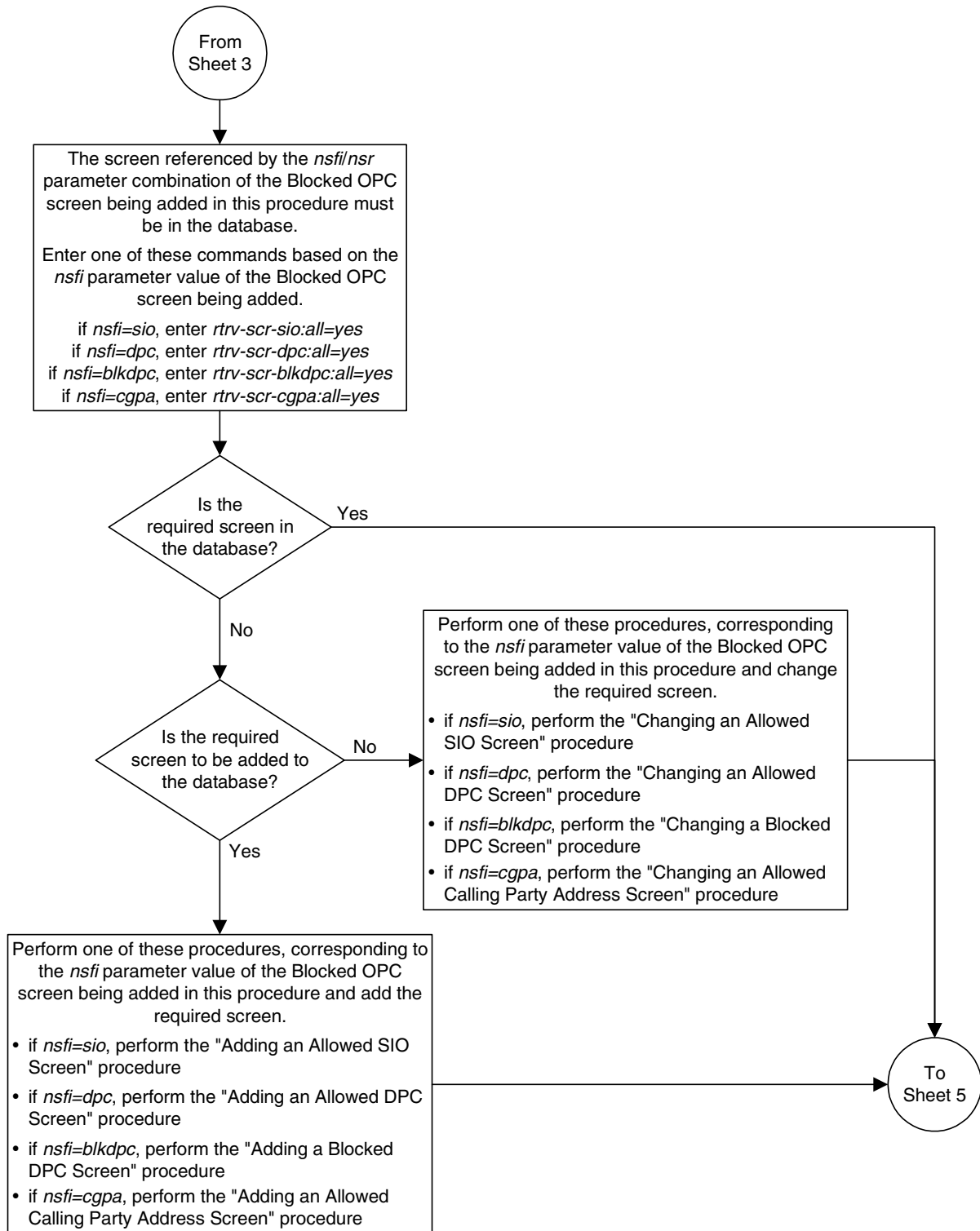

## Blocked Originating Point Code (BLKOPC) Screen Configuration

Flowchart 11-2. Adding a Blocked OPC Screen (Sheet 5 of 5)

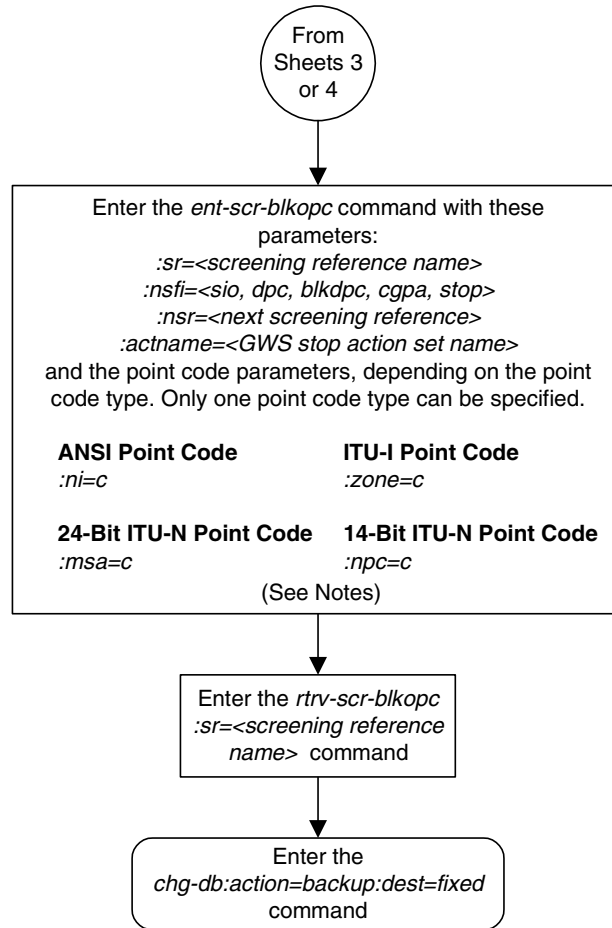

### Notes:

1. The *nsr* parameter can be specified only, and must be specified, if the *nsfi* parameter value is either *sio*, *dpc*, *blkdpc*, *cgpa*, or *isup*.
2. The *actname* parameter is optional and can be specified only with the *nsfi=stop* parameter. If the *actname* parameter is specified, the *actname* parameter value is one of the gateway screening stop action set names shown in the *rtrv-gws-actset* output on Sheet 3.

## Removing a Blocked OPC Screen

This procedure is used to remove a blocked originating point code (OPC) screen from the database using the `dlt-scr-blkopc` command. The parameters used by the `dlt-scr-blkopc` command are shown in the “Gateway Screening Attributes” section on page 2-7. The general rules that apply to configuring gateway screening entities are shown in the “Gateway Screening Configuration” section on page 2-28.

The example in this procedure removes the blocked OPC screen `iec` with the point code 240-001-010 from the database.

**NOTE:** If you using multiple-part ITU national point codes with gateway screening, see “14-Bit ITU National Point Code Formats” on page 2-24.

The `c-c-c` entry cannot be removed from the blocked OPC screen unless all other entries in the blocked OPC screen have been removed. The `c-c-c` entry cannot be removed from the blocked OPC screen if other screens reference the blocked OPC screen. If the last entry (`c-c-c`) in the blocked OPC screen is removed, the blocked OPC screen is removed. The blocked OPC screen can be referenced by one of the following screens.

- Screen Set
- Allowed OPC

Enter the following commands to verify that none of these screens reference the blocked OPC screen being removed from the database.

- `rtrv-scrset:nsfi=blkopc`
- `rtrv-scr-opc:nsfi=blkopc`

To change the NSFI of any of these screens, go to one of the following procedures.

- “Changing a Screen Set” procedure on page 13-15
- “Changing an Allowed OPC Screen” procedure on page 12-25

### Procedure

---

1. Display the blocked OPC screens in the database using the `rtrv-scr-blkopc` command. The following is an example of the possible output.

```
rlghncxa03w 05-09-25 15:25:30 GMT EAGLE5 34.0.0
SCREEN = BLOCKED DPC
SR    REF  RULES
IEC   YES   6
ISP1  YES   2
WRD2  YES   2
WRD3  NO    4
WRD4  YES   9
```

## Blocked Originating Point Code (BLKOPC) Screen Configuration

From the `rtrv-scr-blkopc` output, display the blocked OPC screen you wish to remove using the `rtrv-scr-blkopc` command with the screening reference name. For this example, enter this command.

```
rtrv-scr-blkopc:sr=iec
```

The following is an example of the possible output.

```
rlghncxa03w 05-09-25 15:25:30 GMT EAGLE5 34.0.0
SCREEN = BLOCKED OPC
SR   NI      NC      NCM      NSFI      NSR/ACT
IEC  240     001     010     FAIL     -----
IEC  241     010     *       FAIL     -----

SR   ZONE    AREA    ID      NSFI      NSR/ACT
IEC  1       003     4       FAIL     -----
IEC  1       003     5       FAIL     -----

SR   NI      NC      NCM      NSFI      NSR/ACT
IEC  C       C       C       CGPA     cg01

SR   NPC
IEC  00235
NSFI      NSR
FAIL     -----
```

---

2. Enter the commands on page 11-22 to verify that the screen being removed is not referenced by other screens in the database. If the screen being removed is referenced by other screens, go to the procedures shown on page 11-22 and change the NSFI of those screens to reference other screens or change the NSFI of these screens to STOP.
- 

3. Remove the blocked OPC screen from the database using the `dlt-scr-blkopc` command with the screening reference name shown in the `rtrv-scr-blkopc` output in step 1 and with the point code parameter values (`ni`, `nc`, `ncm`, or `zone`, `area`, `id`, or `npc`, `msa`, `ssa`, `sp`) of the screen being removed from the database. The values for these parameters must be entered exactly as shown in the `rtrv-scr-blkopc` output. For this example, enter this command.

To remove an entry containing either an ITU-I or a 14-bit ITU-N spare point code, the `pcst=s` parameter must be specified with the `dlt-scr-blkopc` command.

To remove an entry containing either an ITU-I or a 14-bit ITU-N non-spare point code, the `pcst` parameter does not have to be specified with the `dlt-scr-blkopc` command. If the `pcst` parameter is specified, the value must be `none`.

The `pcst` parameter cannot be used with the `zone=c` or the `npc=c` parameters. For this example, enter this command.

```
dlt-scr-blkopc:sr=iec:ni=240:nc=001:ncm=010
```

## Blocked Originating Point Code (BLKOPC) Screen Configuration

A message similar to the following should appear.

```
rlghncxa03w 05-09-25 15:26:30 GMT EAGLE5 34.0.0
DLT-SCR-BLKOPC: SCREEN SET AFFECTED - IEC 2% FULL
DLT-SCR-BLKOPC: MASP A - COMPLTD
```

---

4. Verify the changes using the **rtrv-scr-blkopc** command with the screening reference name used in step 3. For this example, enter this command.

```
rtrv-scr-blkopc:sr=iec
```

The following is an example of the possible output.

```
rlghncxa03w 05-09-25 15:27:30 GMT EAGLE5 34.0.0
SCREEN = BLOCKED OPC
SR      NI      NC      NCM      NSF1      NSR/ACT
IEC     241     010     *        FAIL     -----

SR      ZONE    AREA    ID      NSF1      NSR/ACT
IEC     1       003     4       FAIL     -----
IEC     1       003     5       FAIL     -----

SR      NI      NC      NCM      NSF1      NSR/ACT
IEC     C       C       C       CGPA     cg01

SR      NPC
IEC     00235      NSF1      NSR
                   FAIL     -----
```

If the screen removed in step 3 was the last screen contained in the specified screening reference, the screening reference is removed from the database. The following message is displayed.

```
E2573 Cmd Rej: SR or NSR does not reference an existing SR
```

---

5. Backup the new changes using the **chg-db:action=backup:dest=fixed** command. The following messages should appear, the active Maintenance and Administration Subsystem Processor (MASP) appears first.

```
BACKUP (FIXED) : MASP A - Backup starts on active MASP.
BACKUP (FIXED) : MASP A - Backup on active MASP to fixed disk complete.
BACKUP (FIXED) : MASP A - Backup starts on standby MASP.
BACKUP (FIXED) : MASP A - Backup on standby MASP to fixed disk complete.
```

---

## Blocked Originating Point Code (BLKOPC) Screen Configuration

Flowchart 11-3. Removing a Blocked OPC Screen

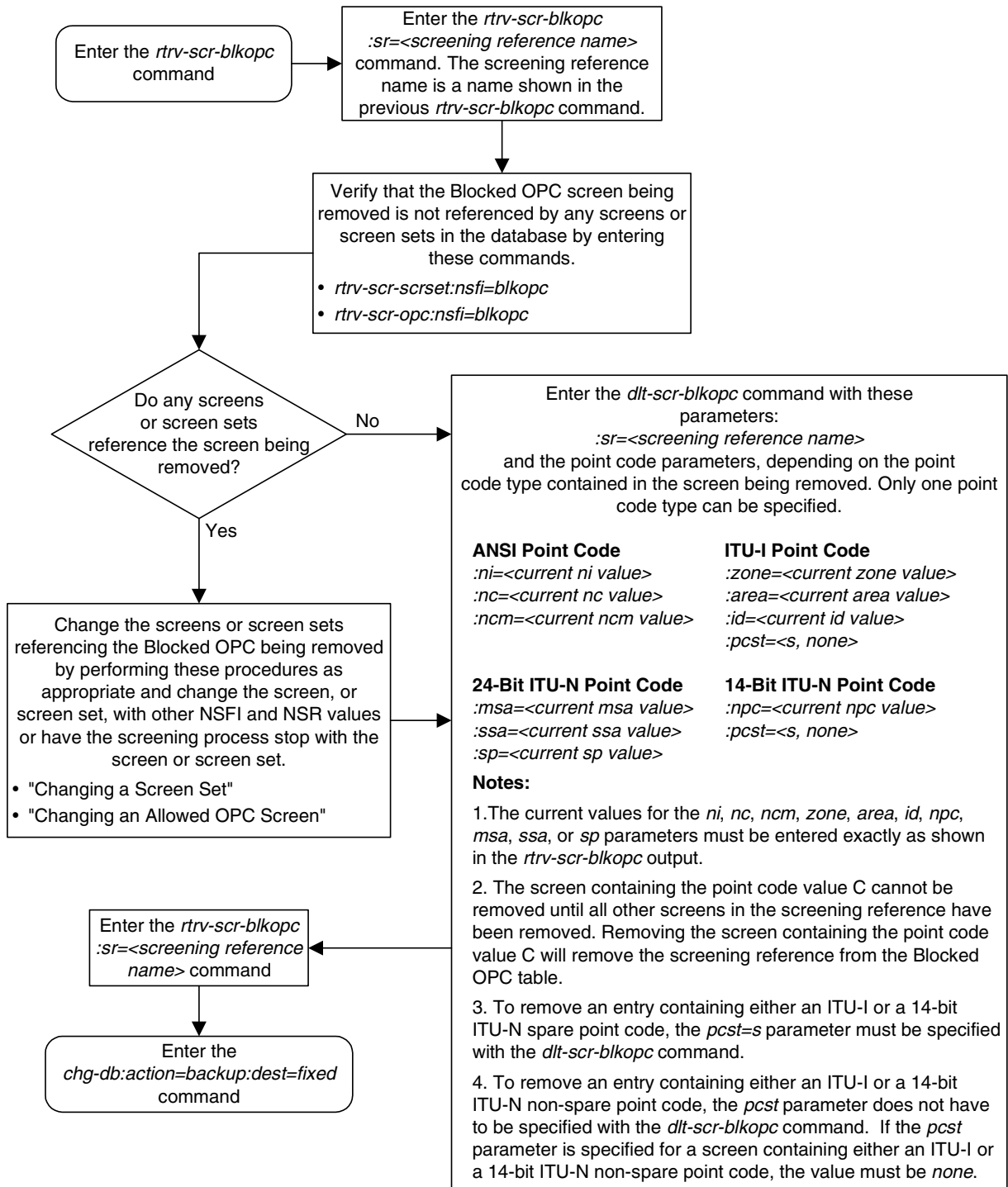

## Changing a Blocked OPC Screen

This procedure is used to change the attributes of a blocked originating point code (OPC) screen in the database using the `chg-scr-blkopc` command. The parameters used by the `chg-scr-blkopc` command are shown in the “Gateway Screening Attributes” section on page 2-7. The general rules that apply to configuring gateway screening entities are shown in the “Gateway Screening Configuration” section on page 2-28.

The example in this procedure is used to change the point code 002-002-002 for the blocked OPC screen `gws7` to 230-230-230.

**NOTE:** If you using multiple-part ITU national point codes with gateway screening, see “14-Bit ITU National Point Code Formats” on page 2-24.

If the current `ni`, `nc`, and `ncm` are equal to the character “`c`”, only the next screening function identifier and next screening reference can be changed. The next screening function identifier cannot be equal to `fail`. If the next screening function identifier is not equal to `stop`, the next screening reference must be specified. Otherwise, only the point code can be changed.

The blocked OPC screen can reference one of the following screens.

- Allowed SIO
- Allowed DPC
- Blocked DPC
- Allowed CGPA

Enter the following commands to verify that these screens are in the database.

- `rtrv-scr-sio:all=yes`
- `rtrv-scr-dpc:all=yes`
- `rtrv-scr-blkdpc:all=yes`
- `rtrv-scr-cgpa:all=yes`

If the desired screen is not in the database, go to one of the following procedures and add the desired screen to the database.

- “Adding an Allowed SIO Screen” procedure on page 10-9
- “Adding an Allowed DPC Screen” procedure on page 9-8
- “Adding a Blocked DPC Screen” procedure on page 8-8
- “Adding an Allowed Calling Party Address Screen” procedure on page 6-6
- “Changing an Allowed SIO Screen” procedure on page 10-23
- “Changing an Allowed DPC Screen” procedure on page 9-26
- “Changing a Blocked DPC Screen” procedure on page 8-26
- “Changing an Allowed Calling Party Address Screen” procedure on page 6-23



## Blocked Originating Point Code (BLKOPC) Screen Configuration

For the first entry for a specific screening reference, the value for the point code must be **c**, and the NSFI must be either **stop**, **sio**, **dpc**, **blkdpc**, or **cgpa**. If the NSFI is **stop**, the screening of the message will stop at the specified blocked OPC screen. If the NSFI is either **sio**, **dpc**, **blkdpc**, or **cgpa**, then any message containing a point code that is not listed in the blocked OPC screen with a NSFI equal to **fail**, will continue to be screened with either the allowed SIO, allowed DPC, blocked DPC, or the allowed CGPA screen.

All subsequent entries for that screening reference must contain a numeric point code value, the NSFI must be equal to **fail**, and the **nsr** parameter cannot be specified. Any message that contains an OPC in the blocked OPC screen with the NSFI equal to **fail** will be rejected from the network and the screening process is stopped.

The **pcst** or **npcst** parameters, specifying whether or not the ITU-I or 14-bit ITU-N point code is a spare point code, cannot be used with the **zone=c** or **npc=c** parameters.

### Specifying a Range of Values

A range of values can be specified for the point code parameters **ni**, **nc**, or **ncm**.

If a range of values is specified for any of these parameters, and the value of the other parameters match existing values for the screening reference name, the range of values for the point code parameter cannot include any values for that parameter that are currently provisioned for the screening reference name.

For example, screening reference name **scr1** contains these entries:

SR	NI	NC	NCM	NSFI	NSR/ACT
SCR1	240	001	010	FAIL	-----
SCR1	241	010	020	FAIL	-----

Another entry for screening reference **scr1** with the **ni** value of 240 and the **nc** value of 001 cannot be specified if the range of values for the **ncm** parameter includes the value 010.

The ANSI point code parameter values can be specified as a single value, a range of values, or with an asterisk (\*). The asterisk specifies all possible values for the **ni**, **nc**, and **ncm** parameters. Table 11-5 shows the valid combinations of these parameter values.

**Table 11-5.** Valid Value Combinations for ANSI Point Code Parameters

NI	NC	NCM
Single Value	Single Value	Single Value
Single Value	Single Value	Range of Values
Single Value	Single Value	Asterisk
Single Value	Range of Values	Asterisk

**Table 11-5.** Valid Value Combinations for ANSI Point Code Parameters

NI	NC	NCM
Single Value	Asterisk	Asterisk
Range of Values	Asterisk	Asterisk
Asterisk	Asterisk	Asterisk

A range of values can also be specified for an ITU-I or 24-bit ITU-N point code parameter using a combination of asterisks (\*) and single values for the point code parameters. Table 11-6 shows the valid combinations of the ITU-I parameter values. Table 11-7 shows the valid combinations of the 24-bit ITU-N parameter values.

**Table 11-6.** Valid Value Combinations for ITU-I Point Code Parameters

ZONE	AREA	ID
Single Value	Single Value	Single Value
Single Value	Single Value	Asterisk
Single Value	Asterisk	Asterisk
Asterisk	Asterisk	Asterisk

**Table 11-7.** Valid Value Combinations for 24-Bit ITU-N Point Code Parameters

MSA	SSA	SP
Single Value	Single Value	Single Value
Single Value	Single Value	Asterisk
Single Value	Asterisk	Asterisk
Asterisk	Asterisk	Asterisk

**Procedure**

---

1. Display the blocked OPC screens in the database using the **rtrv-scr-blkopc** command. The following is an example of the possible output.

```
rlghncxa03w 05-09-25 15:25:30 GMT EAGLE5 34.0.0
SCREEN = BLOCKED OPC
SR    REF  RULES
GWS7  YES   2
IEC   YES   6
ISP1  YES   2
WRD2  YES   2
WRD3  NO    4
WRD4  YES   10
```

From the **rtrv-scr-blkopc** output, display the blocked OPC screen you wish to change using the **rtrv-scr-blkopc** command with the screening reference name. For this example, enter this command.

**rtrv-scr-blkopc:sr=gws7**

The following is an example of the possible output.

```
rlghncxa03w 05-09-25 15:25:30 GMT EAGLE5 34.0.0
SCREEN = BLOCKED OPC
SR  NI      NC      NCM      NSF1     NSR/ACT
GWS7 002     002     002     FAIL     -----
GWS7 C       C       C       DPC     GWS9
```

If a gateway screening stop action set is to be assigned to the blocked OPC screen being changed in the database, go to step 2.

Step 2 verifies the gateway screening stop action set names in the database. The gateway screening stop action set names are assigned only if the NSF1 of the screen being changed in this procedure is STOP. If the NSF1 of the screen will be changed to STOP, but a gateway screening stop action set name will not be assigned to the screen, skip steps 2 and 3 and go to step 4. If the NSF1 of the screen will not be STOP, skip step 2 and go to step 3.

2. Display the gateway screening stop action sets in the database with the **rtrv-gws-actset** command. This is an example of the possible output.

```
rlghncxa03w 05-09-25 15:26:30 GMT EAGLE5 34.0.0
ACT  ACT    ACT  ACT  ACT  ACT  ACT  ACT  ACT  ACT  ACT  ACT
ID  NAME  1    2    3    4    5    6    7    8    9    10
--  ----  ---  ---  ---  ---  ---  ---  ---  ---  ---  ---
1   copy  copy
2   rdct  rdct
3   cr    copy rdct
4   cnf   cnf
5   cpcnf copy cnf
6   cnfrd cnf  rdct
7   cpcfrd copy cnf rdct
```

GWS action set table is (7 of 16) 44% full

If the required gateway screening stop action set is not in the database, go to the "Configuring Gateway Screening Stop Action Sets" procedure on page 2-54 and configure the required gateway screening stop action set.

---

**NOTE:** If the NSFI of the screen being changed in this procedure will be STOP or FAIL, or if the NSFI of the screen is not being changed, skip step 3 and go to step 4.

3. Enter the commands on page 11-26 to verify that the screen that will be specified by the NSFI/NSR parameter combination in step 5 is in the database.

If the desired screen is not in the database, go to one of the procedures shown on page 11-26 and either add the desired screen to the database or change an existing screen in the database.

**NOTE:** If any of these conditions apply to this procedure, skip this step and go to step 5:

- The point code in the screen is not being changed.
- The screen being changed contains either an ANSI or 24-bit ITU-N point code.
- The ITU-I or 14-bit ITU-N non-spare point code in the screen is not being changed to an ITU-I or 14-bit ITU-N spare point code.
- The point code in the screen is an ITU-I or 14-bit ITU-N spare point code or the screening reference contains other screens with ITU-I or 14-bit ITU-N spare point codes.

4. Display the status of the ITU National and International Spare Point Code Support feature by entering the `rtrv-ctrl-feat` command with the ITU National and International Spare Point Code Support feature part number. Enter this command.

`rtrv-ctrl-feat:partnum=893013601`

This is an example of the possible output.

```
rlghncxa03w 05-09-25 15:25:30 GMT EAGLE5 34.0.0
The following features have been permanently enabled:
```

Feature Name	Partnum	Status	Quantity
Spare Point Code Support	893013601	on	----

The following features have been temporarily enabled:

Feature Name	Partnum	Status	Quantity	Trial Period Left
Zero entries found.				

The following features have expired temporary keys:

Feature Name	Partnum
Zero entries found.	

If the ITU National and International Spare Point Code Support feature is enabled, go to step 5.

## Blocked Originating Point Code (BLKOPC) Screen Configuration

If the ITU National and International Spare Point Code Support feature is not enabled, perform the “Activating the ITU National and International Spare Point Code Support Feature” procedure in the *Database Administration Manual - SS7* to enable the ITU National and International Spare Point Code Support feature as required. After the feature has been enabled, go to step 5.

---

5. Change the attributes of the blocked OPC screen using the `chg-scr-blkopc` command.

If a gateway screening stop action is to be assigned to the blocked OPC screen being changed, enter the `chg-scr-blkopc` command with the `nsfi=stop` parameter and the `actname` parameter with the name of a gateway screening stop action set shown in the output of the `rtrv-gws-actset` command executed in step 2.

The current values for the `ni`, `nc`, `ncm`, `zone`, `area`, `id`, `npc`, `msa`, `ssa`, and `sp` parameters must be entered exactly as shown in the `rtrv-scr-blkopc` output in step 1.

The following list contains the values for the `nni`, `nnc`, `nncm`, `nzone`, `narea`, `nid`, `npc`, `nmsa`, `nssa`, and `nsp` parameters:

- `nni` – 0 - 255, c, or an asterisk (\*)
- `nnc` – 0 - 255, c, or an asterisk (\*)
- `nncm` – 0 - 255, c, or an asterisk (\*)
- `nzone` – 0 - 7, c, or an asterisk (\*)
- `narea` – 0 - 255, c, or an asterisk (\*)
- `nid` – 0 - 7, c, or an asterisk (\*)
- `npc` – 1 - 16383, c, or an asterisk (\*)
- `nmsa` – 0 - 255, c, or an asterisk (\*)
- `nssa` – 0 - 255, c, or an asterisk (\*)
- `nsp` – 0 - 255, c, or an asterisk (\*)

A range of values can be specified for the `nni`, `nnc`, and `nncm` parameters. See the “Specifying a Range of Values” section on page 11-27 for more information on how the asterisk and a range of values are used for the `nni`, `nnc`, and `nncm` parameters.

To change an ITU-I or 14-bit ITU-N spare point code to a non-spare point code, both the `pcst=s` and `npcst=none` parameters must be specified with the `chg-scr-blkopc` command.

To change an ITU-I or 14-bit ITU-N non-spare point code to a spare point code, the `npcst=s` parameter must be specified with the `chg-scr-blkopc` command. The `pcst` parameter does not have to be specified.

## Blocked Originating Point Code (BLKOPC) Screen Configuration

If the current point code in the screen being changed is either an ITU-I or 14-bit ITU-N spare point code, the **pcst=s** parameter must be specified with the **chg-scr-blkopc** command.

If the current point code in the screen being changed is either an ITU-I or 14-bit ITU-N non-spare point code, the **pcst** parameter does not have to be specified with the **chg-scr-blkopc** command. If the **pcst** parameter is specified for a screen containing either an ITU-I or 14-bit ITU-N non-spare point code, the **pcst** parameter value must be **none**.

The **pcst** or **npcst** parameters cannot be used with the **zone=c** or **npc=c** parameters.

For this example, enter this command.

```
chg-scr-blkopc:sr=gws7:ni=002:nc=002:ncm=002:nni=230:nnc=230
:nncm=230
```

The following messages appear.

```
rlghncxa03w 05-09-25 15:27:30 GMT EAGLE5 34.0.0
CHG-SCR-BLKOPC: SCREEN SET AFFECTED - GWS7 1% FULL
CHG-SCR-BLKOPC: MASP A - COMPLTD
```

---

**NOTE: Verify the changes using the **rtrv-scr-blkopc** command with the screening reference name used in step 5. For this example, enter this command.**

```
rtrv-scr-blkopc:sr=gws7
```

The following is an example of the possible output.

```
rlghncxa03w 05-09-25 15:28:30 GMT EAGLE5 34.0.0
SCREEN = BLOCKED OPC
SR   NI       NC       NCM       NSF1     NSR/ACT
GWS7 230       230       230       FAIL     -----
GWS7 C         C         C         DPC      GWS9
```

---

6. Backup the new changes using the **chg-db:action=backup:dest=fixed** command. The following messages should appear, the active Maintenance and Administration Subsystem Processor (MASP) appears first.

```
BACKUP (FIXED) : MASP A - Backup starts on active MASP.
BACKUP (FIXED) : MASP A - Backup on active MASP to fixed disk complete.
BACKUP (FIXED) : MASP A - Backup starts on standby MASP.
BACKUP (FIXED) : MASP A - Backup on standby MASP to fixed disk complete.
```

---

# Blocked Originating Point Code (BLKOPC) Screen Configuration

Flowchart 11-4. Changing a Blocked OPC Screen (Sheet 1 of 5)

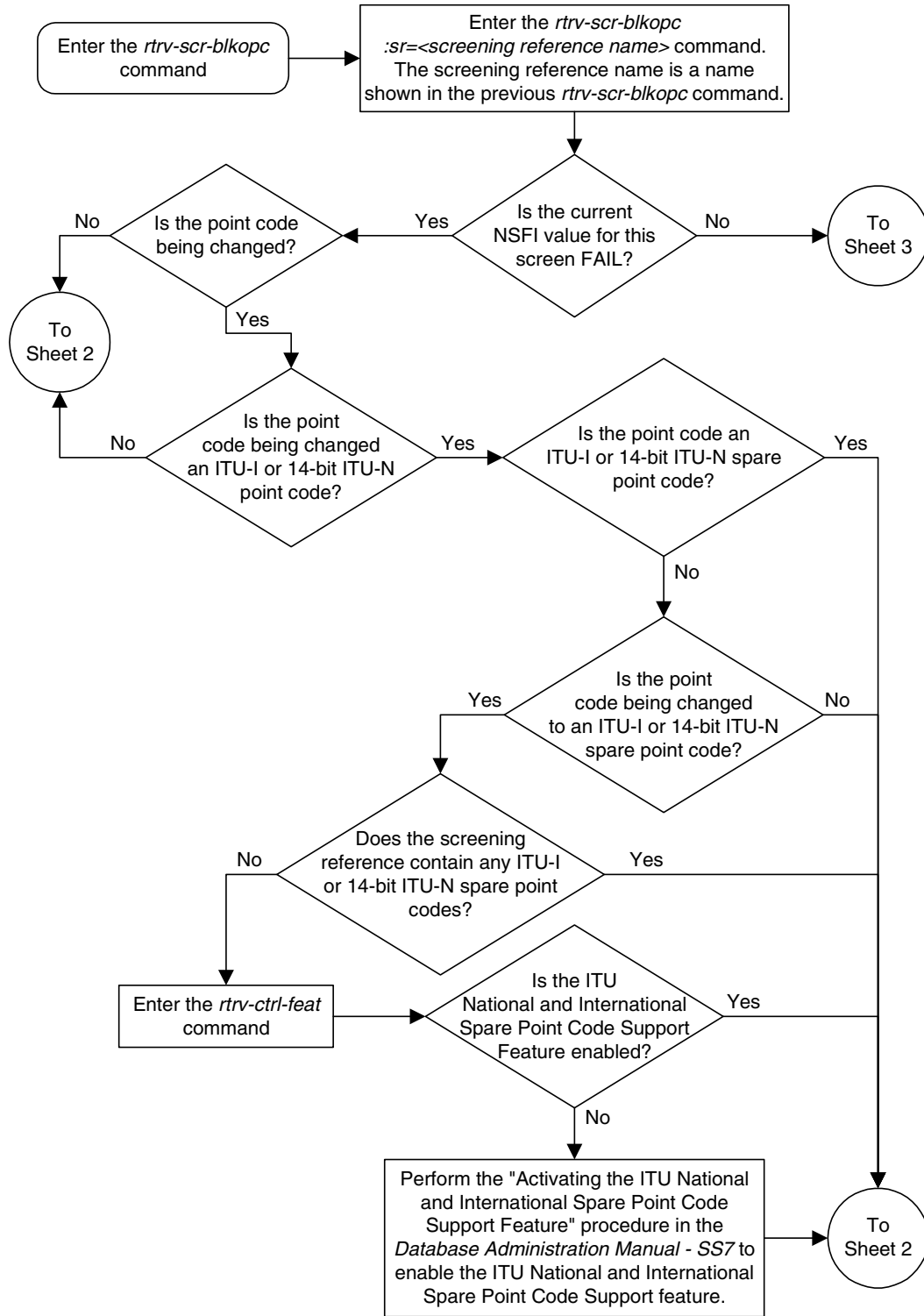

## Blocked Originating Point Code (BLKOPC) Screen Configuration

**Flowchart 11-4.** Changing a Blocked OPC Screen (Sheet 2 of 5)

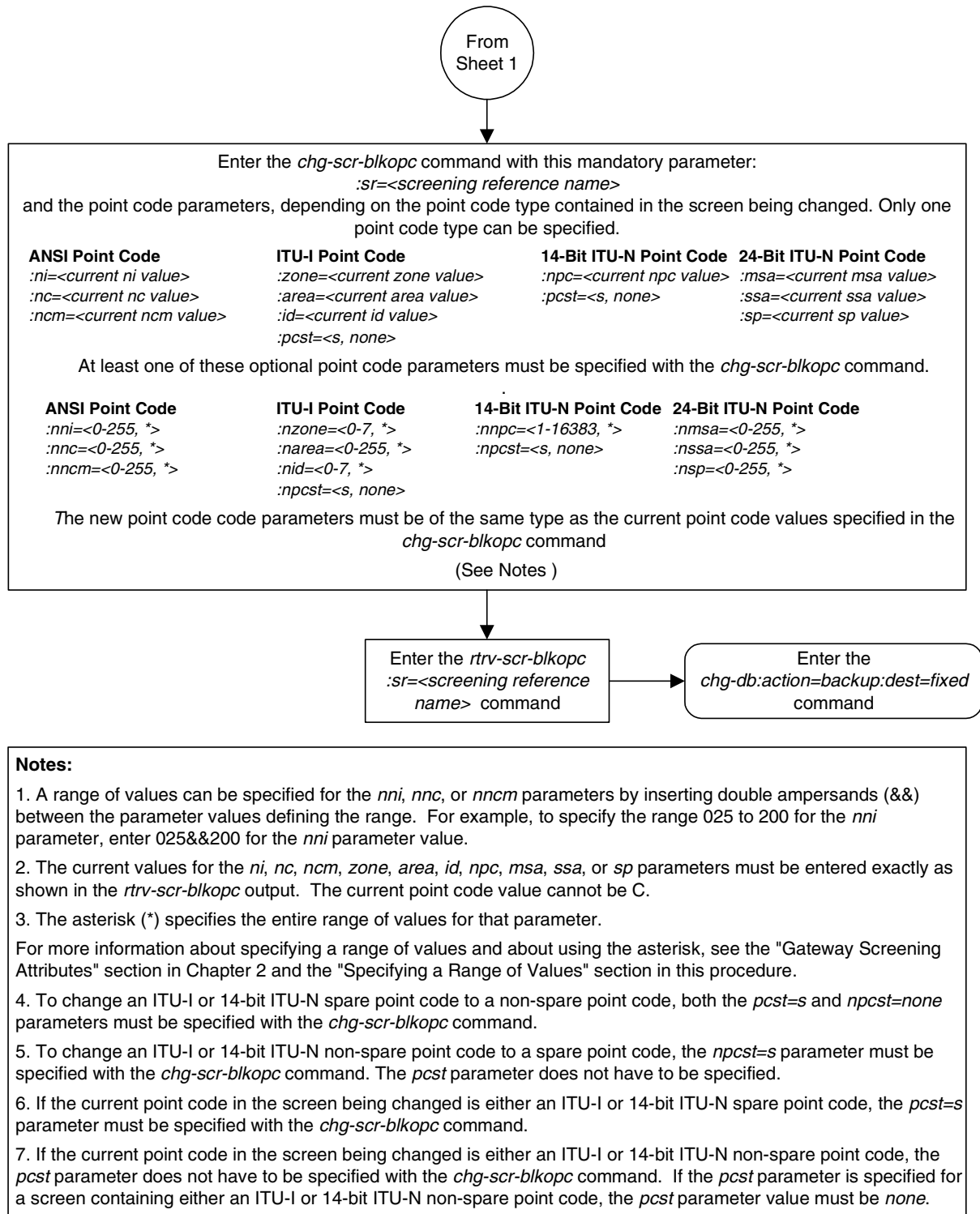



# Blocked Originating Point Code (BLKOPC) Screen Configuration

Flowchart 11-4. Changing a Blocked OPC Screen (Sheet 3 of 5)

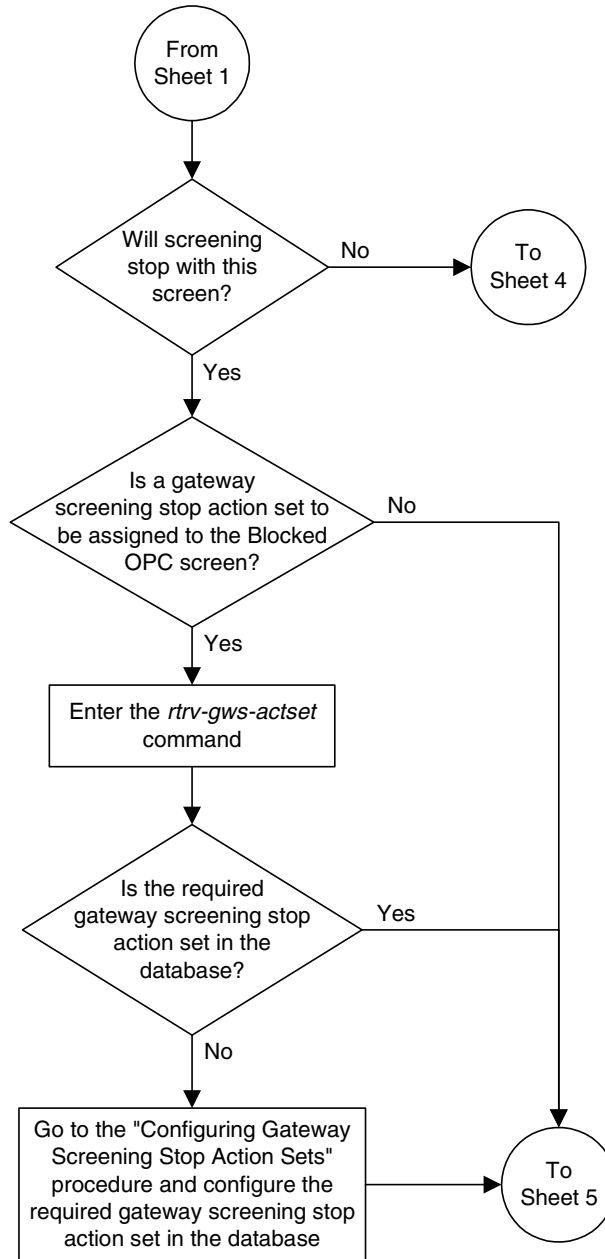

Flowchart 11-4. Changing a Blocked OPC Screen (Sheet 4 of 5)

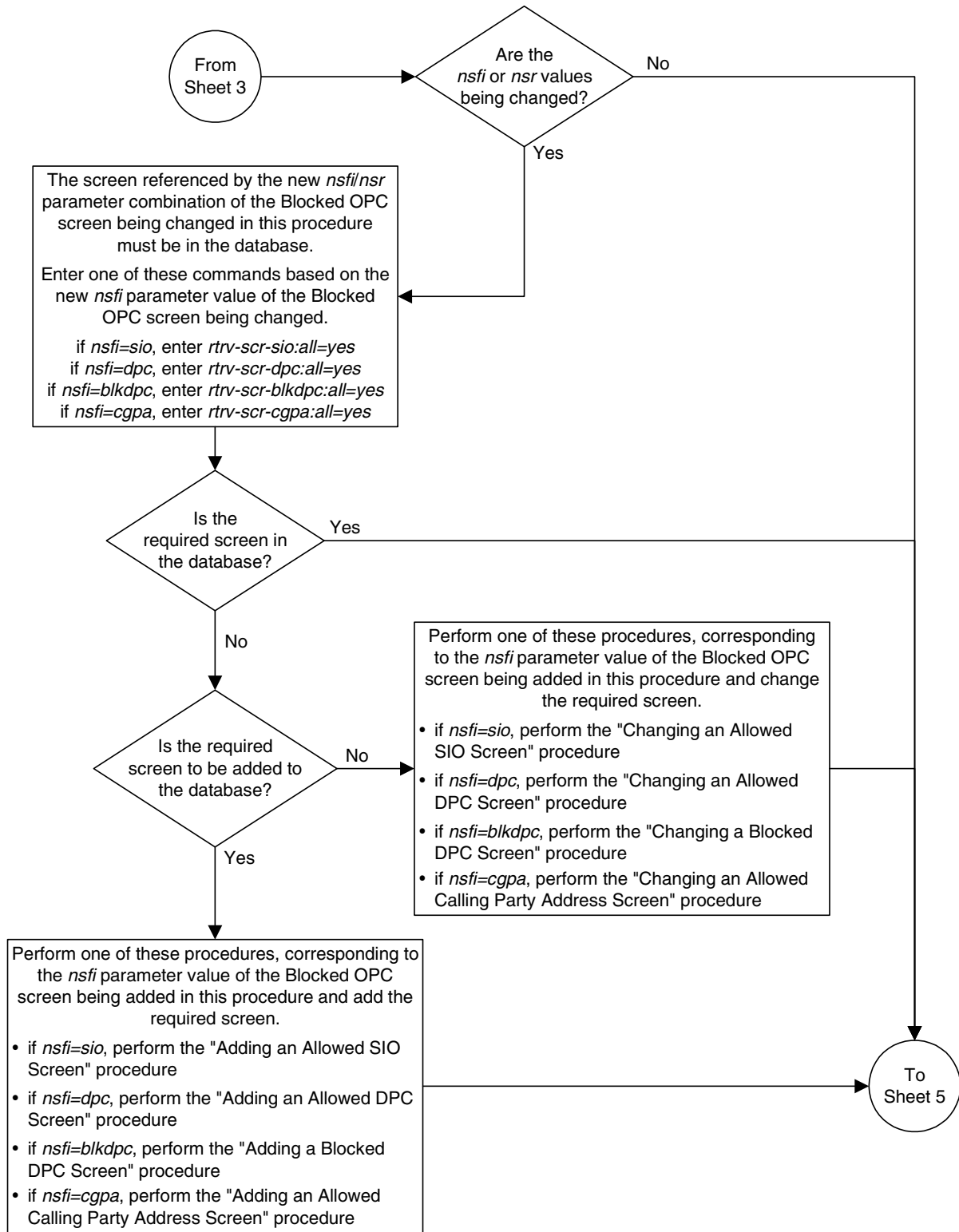

## Blocked Originating Point Code (BLKOPC) Screen Configuration

Flowchart 11-4. Changing a Blocked OPC Screen (Sheet 5 of 5)

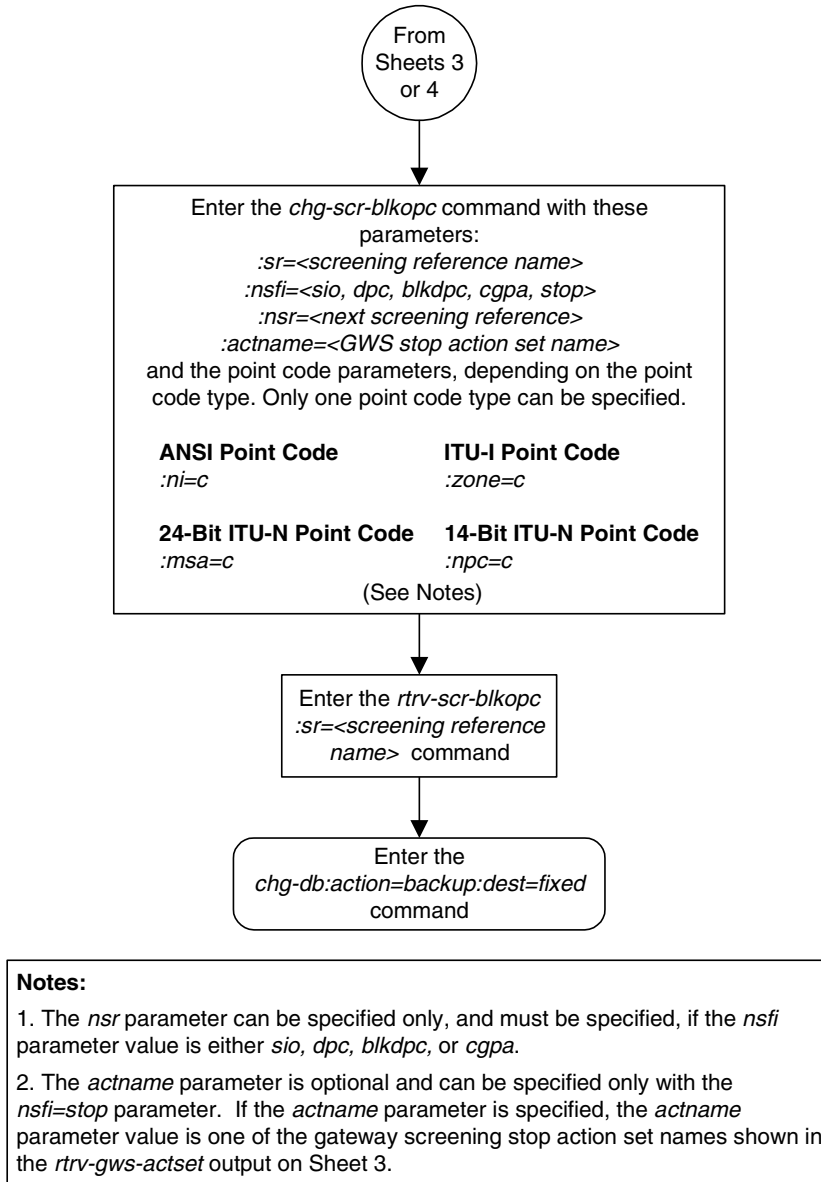

## Blocked Originating Point Code (BLKOPC) Screen Configuration

# 12

## Allowed Originating Point Code (OPC) Screen Configuration

Introduction.....	12-2
Adding an Allowed OPC Screen.....	12-8
Removing an Allowed OPC Screen .....	12-22
Changing an Allowed OPC Screen.....	12-25

## Introduction

The allowed originating point code (OPC) screen identifies a set of OPC's that are allowed to send SS7 messages into the network. The gray shaded areas in Figure 12-1 shows the fields of the SS7 message that are checked by the allowed OPC screening function. If a match is found, the **nsfi** is examined to determine the next step in the screening process. If the **nsfi** is equal to **stop**, the message is processed and no further screening takes place.

If the **nsfi** is equal to **stop**, and the **copy** gateway screening stop action is specified, the message is processed and a copy of the message is sent by the STP LAN feature to an external application through an ACM running the **stplan** application or a DCM running the **vxwslan** application.

If the **nsfi** is equal to **stop**, and the **rdct** (redirect) gateway screening stop action is specified, the message is diverted from the original destination and sent to another destination with the Database Transport Access feature, specified by global title translation, for further processing.

If the Calling Name Conversion Facility (CNCF) feature is on, the **nsfi** is equal to **stop**, and the **cncf** gateway screening stop action is specified, the PIP parameter in the incoming ISUP IAM message is converted to the GN parameter. The GN parameter in the incoming ISUP IAM message is converted to the PIP parameter. The message is then sent to the node specified by the DPC in the routing label in the message. For more information on the Calling Name Conversion Facility feature, see Chapter 14, "Calling Name Conversion Facility (CNCF) Configuration."

If the Triggerless LNP (TLNP) feature is on, the **nsfi** is equal to **stop**, and the **tlnp** gateway screening stop action is specified, ISUP IAMs that pass gateway screening are processed either by the ISUP NP with EPAP feature (if the ISUP NP with EPAP feature is enabled and turned on) or by the Triggerless LNP feature (if the Triggerless LNP feature is turned on). The ISUP NP with EPAP feature is discussed in more detail in the *Feature Manual - G-Port*. The Triggerless LNP feature is discussed in more detail in the *LNP Feature Activation Guide*.

If the **nsfi** is equal to anything else, the next screening reference (**nsr**) is identified and the screening process continues to the next screen identified by the **nsfi** and **nsr** parameters. If no match is found, the message is discarded.

Flowchart 12-1 shows the screening action of the allowed OPC screen.

# Allowed Originating Point Code (OPC) Screen Configuration

Flowchart 12-1. Allowed OPC Screening Action (Sheet 1 of 4)

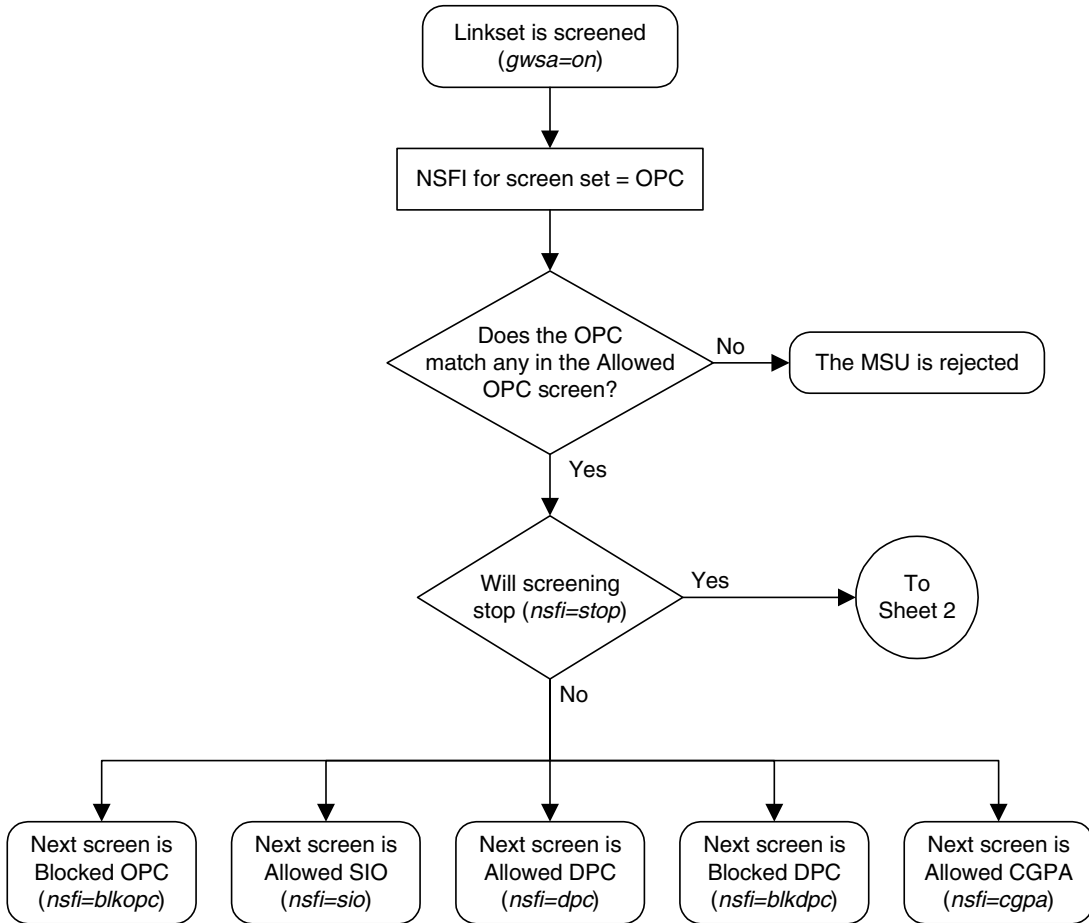

Flowchart 12-1. Allowed OPC Screening Action (Sheet 2 of 4)

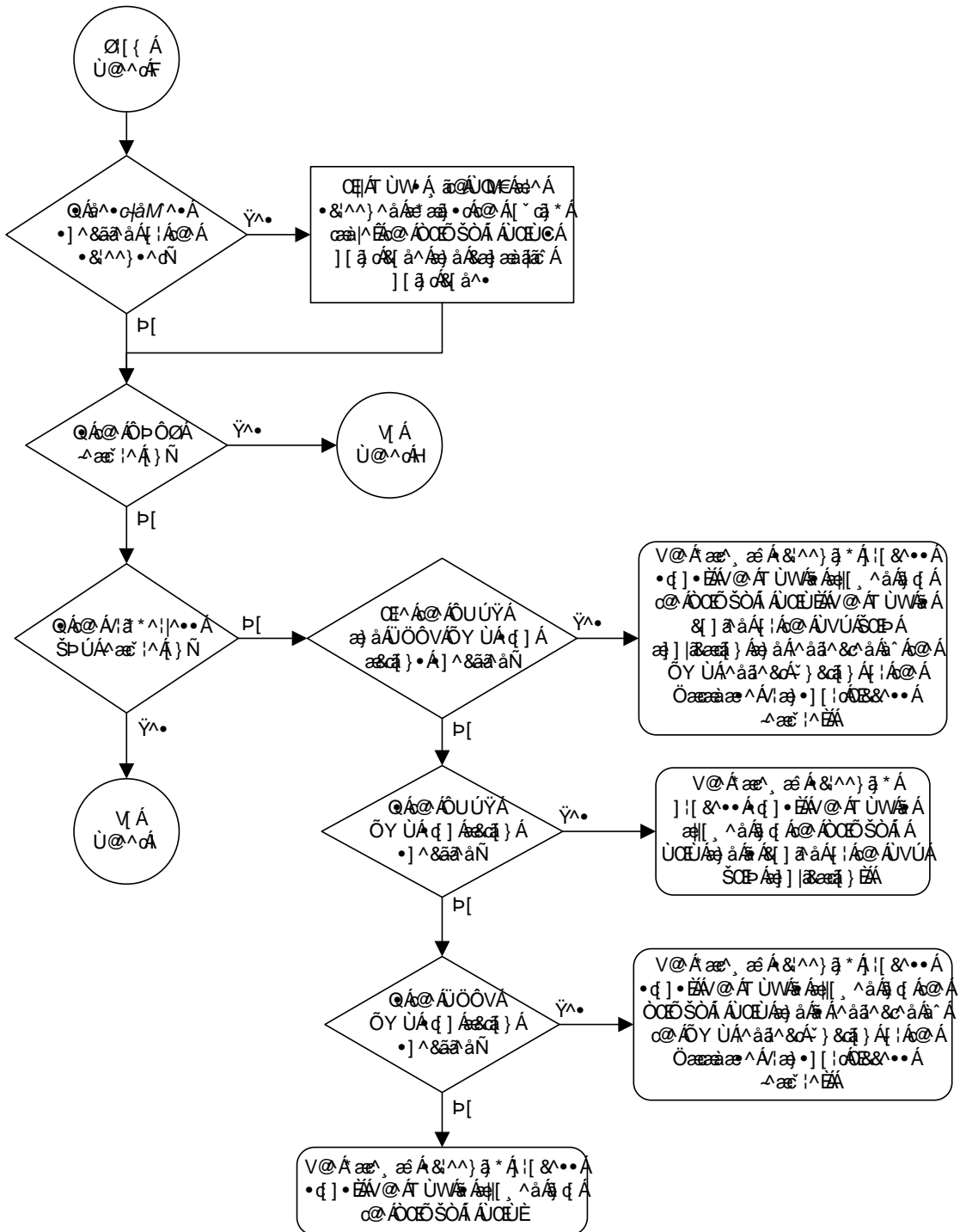



Allowed Originating Point Code (OPC) Screen Configuration

Flowchart 12-1. Allowed OPC Screening Action (Sheet 3 of 4)

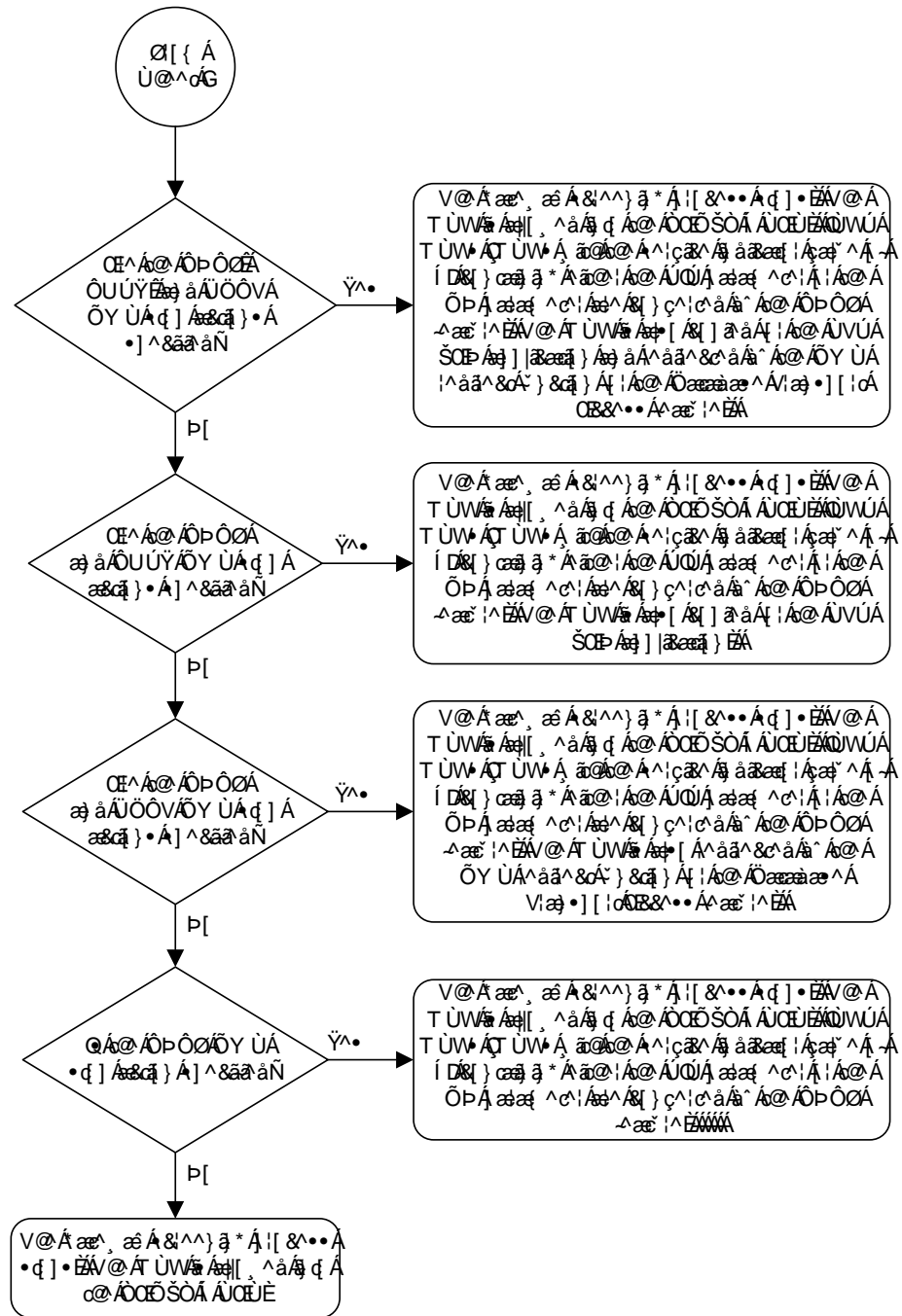

Allowed Originating Point Code (OPC) Screen Configuration

Flowchart 12-1. Allowed OPC Screening Action (Sheet 4 of 4)

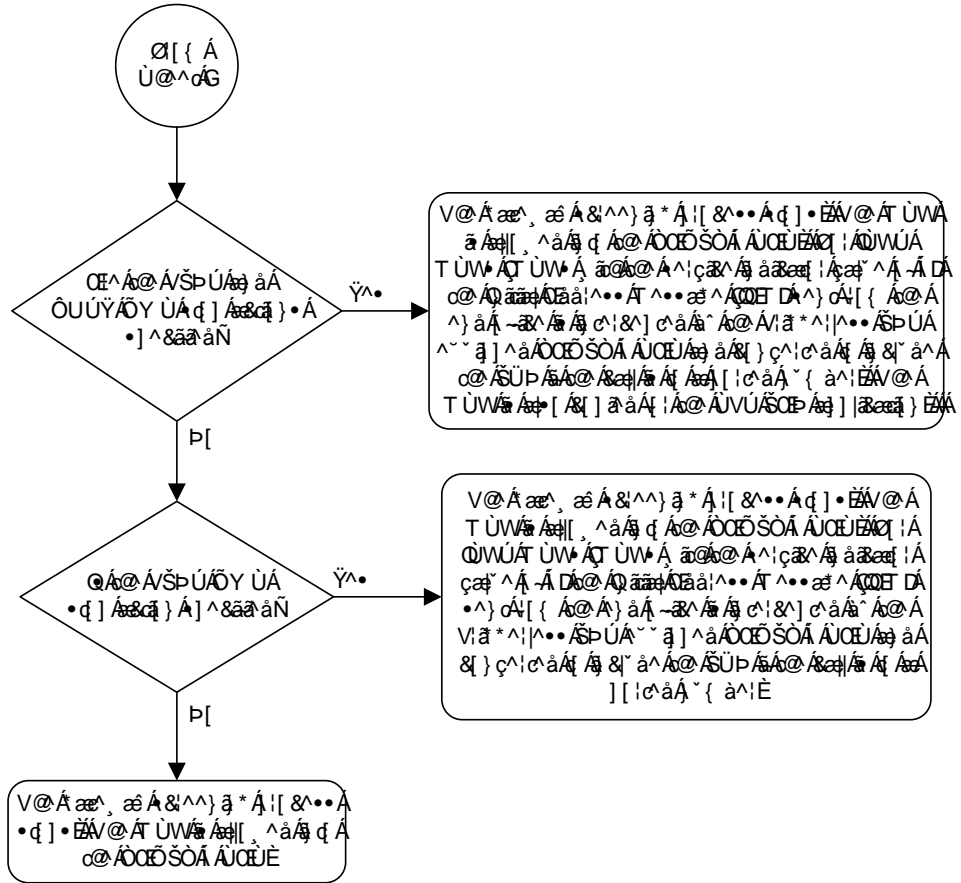

# Allowed Originating Point Code (OPC) Screen Configuration

**Figure 12-1.** Allowed OPC Screening Functions

**ANSI MSU (ANSI Message Signal Unit)**

BSN FSN LI	SIO xx xx xxxx NIC PRI SI	SIF		
		DPC NCM NC NI	Routing Label OPC NCM NC NI	SLS xx

**ITU-I MSU (ITU International Message Signal Unit)**

BSN FSN LI	SIO xx xx xxxx NIC PRI SI	SIF		
		DPC ID AREA ZONE	Routing Label OPC ID AREA ZONE	SLS xx

**14-Bit ITU-N MSU (14-Bit ITU National Message Signal Unit)**

BSN FSN LI	SIO xx xx xxxx NIC PRI SI	SIF		
		DPC NPC	Routing Label OPC NPC	SLS xx

**24-Bit ITU-N MSU (24-Bit ITU National Message Signal Unit)**

BSN FSN LI	SIO xx xx xxxx NIC PRI SI	SIF		
		DPC SP SSA MSA	Routing Label OPC SP SSA MSA	SLS xx

## Adding an Allowed OPC Screen

This procedure is used to add an allowed originating point code (OPC) screen to the database using the `ent-scr-opc` command. The parameters used by the `ent-scr-opc` command are shown in the “Gateway Screening Attributes” section on page 2-7. The general rules that apply to configuring gateway screening entities are shown in the “Gateway Screening Configuration” section on page 2-28.

The examples in this procedure are used to add the allowed OPC screen data shown in Table 12-1 and based on the example configurations shown in Figure 2-3 on page 2-33, Figure 2-7 on page 2-41, and Figure 2-9 on page 2-45.

**Table 12-1.** Example Gateway Screening Allowed OPC Configuration Table

Screening Reference	NI	NC	NCM	NSFI	NSR
gws4	001	001	001	blkopc	gws3
fld2	010	010	010	blkopc	fld3
isp1	015	015	015	blkopc	isp1
tup1	017	017	017	sio	tup1

**NOTE:** If you using multiple-part ITU national point codes with gateway screening, see “14-Bit ITU National Point Code Formats” on page 2-24.

The allowed OPC screen can reference one of the following screens.

- Blocked OPC
- Allowed SIO
- Allowed DPC
- Blocked DPC
- Allowed CGPA

Enter the following commands to verify that these screens are in the database.

- `rtrv-scr-blkopc:all=yes`
- `rtrv-scr-sio:all=yes`
- `rtrv-scr-dpc:all=yes`
- `rtrv-scr-blkdpc:all=yes`
- `rtrv-scr-cgpa:all=yes`

If the desired screen is not in the database, go to one of the following procedures and add the desired screen to the database or change an existing screen in the database.

- “Adding a Blocked OPC Screen” procedure on page 11-8
- “Adding an Allowed SIO Screen” procedure on page 10-9

## Allowed Originating Point Code (OPC) Screen Configuration

- “Adding an Allowed DPC Screen” procedure on page 9-8
- “Adding a Blocked DPC Screen” procedure on page 8-8
- “Adding an Allowed Calling Party Address Screen” procedure on page 6-6
- “Changing a Blocked OPC Screen” procedure on page 11-26
- “Changing an Allowed SIO Screen” procedure on page 10-23
- “Changing an Allowed DPC Screen” procedure on page 9-26
- “Changing a Blocked DPC Screen” procedure on page 8-26
- “Changing an Allowed Calling Party Address Screen” procedure on page 6-23

### Specifying a Range of Values

A range of values can be specified for the point code parameters **ni**, **nc**, or **ncm**.

If a range of values is specified for any of these parameters, and the value of the other parameters match existing values for the screening reference name, the range of values for the point code parameter cannot include any values for that parameter that are currently provisioned for the screening reference name.

For example, screening reference name **scr1** contains these entries:

SR	NI	NC	NCM	NSFI	NSR/ACT
SCR1	240	001	010	CGPA	-----
SCR1	241	010	020	STOP	-----

Another entry for screening reference **scr1** with the **ni** value of 240 and the **nc** value of 001 cannot be specified if the range of values for the **ncm** parameter includes the value 010.

The ANSI point code parameter values can be specified as a single value, a range of values, or with an asterisk (\*). The asterisk specifies all possible values for the **ni**, **nc**, and **ncm** parameters. Table 12-2 shows the valid combinations of these parameter values.

**Table 12-2.** Valid Value Combinations for ANSI Point Code Parameters

NI	NC	NCM
Single Value	Single Value	Single Value
Single Value	Single Value	Range of Values
Single Value	Single Value	Asterisk
Single Value	Range of Values	Asterisk
Single Value	Asterisk	Asterisk
Range of Values	Asterisk	Asterisk
Asterisk	Asterisk	Asterisk

A range of values can also be specified for an ITU-I or 24-bit ITU-N point code parameter using a combination of asterisks (\*) and single values for the point code parameters. Table 12-3 shows the valid combinations of the ITU-I parameter values. Table 12-4 shows the valid combinations of the 24-bit ITU-N parameter values.

**Table 12-3.** Valid Value Combinations for ITU-I Point Code Parameters

ZONE	AREA	ID
Single Value	Single Value	Single Value
Single Value	Single Value	Asterisk
Single Value	Asterisk	Asterisk
Asterisk	Asterisk	Asterisk

**Table 12-4.** Valid Value Combinations for 24-Bit ITU-N Point Code Parameters

MSA	SSA	SP
Single Value	Single Value	Single Value
Single Value	Single Value	Asterisk
Single Value	Asterisk	Asterisk
Asterisk	Asterisk	Asterisk

### Procedure

---

1. Verify that the gateway screening feature is on, by entering the `rtrv-feat` command. If the gateway screening feature is on, the `GWS` field is set to `on`.

**NOTE:** The `rtrv-feat` command output contains other fields that are not used by this procedure. If you wish to see all the fields displayed by the `rtrv-feat` command, see the `rtrv-feat` command description in the *Commands Manual*.

If the gateway screening feature is on, shown by the entry `GWS = on` in the `rtrv-feat` command output, skip step 2, and go to step 3.

---

2. Turn the gateway screening feature on by entering this command.

`chg-feat:gws=on`

**NOTE:** Once the gateway screening feature is turned on with the `chg-feat` command, it cannot be turned off.

## Allowed Originating Point Code (OPC) Screen Configuration

**NOTE:** The gateway screening feature must be purchased before you turn this feature on with the `chg-feat` command. If you are not sure if you have purchased the gateway screening feature, contact your Tekelec Sales Representative or Account Representative.

When the `chg-feat` has successfully completed, this message should appear.

```
rlghncxa03w 05-09-28 11:43:04 GMT EAGLE5 34.0.0
CHG-FEAT: MASP A - COMPLTD
```

---

3. Display all allowed OPC screens in the database using the `rtrv-scr-opc` command. The following is an example of the possible output.

```
rlghncxa03w 05-09-25 15:25:30 GMT EAGLE5 34.0.0
SCREEN = ALLOWED OPC
SR   REF  RULES
IEC  YES   2
WRD2 YES   1
WRD4 YES   9
```

If the screening reference names that you wish to add with this procedure are not shown in the `rtrv-scr-opc` command output, go to step 4. For this example, the screening reference names are not shown. If these screening reference names are shown in the `rtrv-scr-opc` command output, make sure the screening data you wish to enter is not already in the database by entering the `rtrv-scr-opc` command with the screening reference name. For example, enter the `rtrv-scr-opc:sr=iec` command. The following is an example of the possible output.

```
rlghncxa03w 05-09-25 15:26:30 GMT EAGLE5 34.0.0
SCREEN = ALLOWED OPC
SR   NI      NC      NCM      NSFI      NSR/ACT
IEC  240     001     010     STOP     -----
IEC  241     010     *       CGPA     cg04

SR      NPC      NSFI      NSR/ACT
IEC    00235     CGPA     cg04
IEC    00240     CGPA     cg01

SR      ZONE  AREA  ID      NSFI      NSR/ACT
IEC    1     003   4      BLKOPC   blk1
IEC    1     003   5      STOP     -----
```

If a gateway screening stop action set is to be assigned to the allowed OPC screen being added to the database, go to step 4.

Step 4 verifies the gateway screening stop action set names in the database. The gateway screening stop action set names are assigned only if the NSFI of the screen being added in this procedure is STOP. If the NSFI of the new screen will be STOP, but a gateway screening stop action set name will not be assigned to the new screen, skip steps 4, 5, and 6, and go to step 7. If the NSFI of the new screen is not STOP, skip steps 4 and 5, and go to step 6.

---

## Allowed Originating Point Code (OPC) Screen Configuration

4. Display the gateway screening stop action sets in the database with the **rtrv-gws-actset** command. This is an example of the possible output.

```
rlghncxa03w 05-09-25 15:27:30 GMT EAGLE5 34.0.0
ACT ACT ACT ACT ACT ACT ACT ACT ACT ACT ACT
ID NAME 1 2 3 4 5 6 7 8 9 10
-----
1 copy copy
2 rdct rdct
3 cr copy rdct
4 cncf cncf
5 cpcncf copy cncf
6 cncfrd cncf rdct
7 cpcfrd copy cncf rdct
```

GWS action set table is (7 of 16) 44% full

If the required gateway screening stop action set is not in the database, go to the "Configuring Gateway Screening Stop Action Sets" procedure on page 2-54 and configure the required gateway screening stop action set.

---

**NOTE:** If the gateway screening stop action set being assigned to the Allowed OPC screen does not contain the redirect stop action, skip step 5 and go to step 6.

5. Verify the point codes of adjacent nodes by entering the **rtrv-ls** command. The following is an example of the possible output.

```
rlghncxa03w 05-09-10 11:43:04 GMT EAGLE5 34.0.0

LSN          APCA      (SS7)  SCRNL3T SLT          GWS GWS GWS
e1e2         001-207-000 none 1 1 no B 6 off off off no off
ls1305       000-005-000 none 1 1 no A 1 off off off no off
ls1307       000-007-000 none 1 1 no A 1 off off off no off
e1m1s1       001-001-001 none 1 1 no A 7 off off off no off
e1m1s2       001-001-002 none 1 1 no A 7 off off off no off

LSN          APCA      (X25)  SCRNL3T SLT          GWS GWS GWS

LSN          APCI      (SS7)  SCRNL3T SLT          GWS GWS GWS
e1e2i        1-207-0 none 1 1 no B 4 off off off --- on
ls1315       0-015-0 none 1 1 no A 1 off off off --- off
ls1317       0-017-0 none 1 1 no A 1 off off off --- on
e1m2s1       1-011-1 none 1 1 no A 7 off off off --- off
e1m2s2       1-011-2 none 1 1 no A 7 off off off --- off

LSN          APCN      (SS7)  SCRNL3T SLT          GWS GWS GWS

LSN          APCN24   (SS7)  SCRNL3T SLT          GWS GWS GWS

LSN (CHINA)  APCN      (SS7)  SCRNL3T SLT          GWS GWS GWS

LSN (CHINA)  APCN24   (SS7)  SCRNL3T SLT          GWS GWS GWS

Link set table is (10 of 1024) 1% full.
```





**CAUTION:** Redirecting SLTA/SLTM messages prevents SLTA/SLTM messages from being returned to the EAGLE 5 SAS. The signaling link carrying these messages will fail if these messages are not returned to the EAGLE 5 SAS. To prevent SLTA/SLTM messages from being redirected, gateway screening stop action sets containing the redirect stop action should not be assigned to Allowed OPC screens containing the adjacent point code of a linkset.

---

**NOTE:** If the NSFI of the screen being added in this procedure is STOP, skip step 6 and go to step 7.

6. Enter the commands on page 12-8 to verify that the screen that will be specified by the NSFI/NSR parameter combination in step 8 is in the database.

If the desired screen is not in the database, go to one of the procedures shown on pages 12-8 and 12-9 and either add the desired screen to the database or change an existing screen in the database.

---

**NOTE:** If the point code being added in this procedure is not an ITU-I or 14-bit ITU-N spare point code, skip this step and to to step 8.

**NOTE:** If the point code being added in this procedure is an ITU-I or 14-bit ITU-N spare point code and the screening reference contains ITU-I or 14-bit ITU-N spare point codes, skip this step and go to step 8.

7. Display the status of the ITU National and International Spare Point Code Support feature by entering the `rtrv-ctrl-feat` command with the ITU National and International Spare Point Code Support feature part number. Enter this command.

```
rtrv-ctrl-feat:partnum=893013601
```

This is an example of the possible output.

```
rlghncxa03w 05-09-25 15:25:30 GMT EAGLE5 34.0.0
The following features have been permanently enabled:
```

Feature Name	Partnum	Status	Quantity
Spare Point Code Support	893013601	on	----

The following features have been temporarily enabled:

Feature Name	Partnum	Status	Quantity	Trial Period Left
Zero entries found.				

The following features have expired temporary keys:

Feature Name	Partnum
Zero entries found.	

If the ITU National and International Spare Point Code Support feature is enabled, go to step 8.

If the ITU National and International Spare Point Code Support feature is not enabled, perform the “Activating the ITU National and International Spare Point Code Support Feature” procedure in the *Database Administration Manual - SS7* to enable the ITU National and International Spare Point Code Support feature as required. After the feature has been enabled, go to step 8.

- 
8. Add a new allowed OPC screen to the database using the `ent-scr-opc` command.

If a gateway screening stop action is to be assigned to the allowed OPC screen being changed, enter the `ent-scr-opc` command with the `nsfi=stop` parameter and the `actname` parameter with the name of a gateway screening stop action set shown in the output of the `rtrv-gws-actset` command executed in step 4.



**CAUTION:** Redirecting SLTA/SLTM messages prevents SLTA/SLTM messages from being returned to the EAGLE 5 SAS. The signaling link carrying these messages will fail if these messages are not returned to the EAGLE 5 SAS. To prevent SLTA/SLTM messages from being redirected, gateway screening stop action sets containing the redirect stop action should not be assigned to Allowed OPC screens containing the adjacent point code of a linkset, shown in step 5.

The following list contains the values for `ni`, `nc`, `ncm`, `zone`, `area`, `id`, `npc`, `msa`, `ssa`, and `sp` parameters:

- `ni` – 0 - 255 or an asterisk (\*)
- `nc` – 0 - 255 or an asterisk (\*)
- `ncm` – 0 - 255 or an asterisk (\*)
- `zone` – 0 - 7 or an asterisk (\*)
- `area` – 0 - 255 or an asterisk (\*)
- `id` – 0 - 7 or an asterisk (\*)
- `npc` – 1 - 16383 or an asterisk (\*)
- `msa` – 0 - 255 or an asterisk (\*)
- `ssa` – 0 - 255 or an asterisk (\*)
- `sp` – 0 - 255 or an asterisk (\*)

A range of values can be specified for the `ni`, `nc`, and `ncm` parameters. See the “Specifying a Range of Values” section on page 12-9 for more information on how the asterisk and a range of values are used for the `ni`, `nc`, and `ncm` parameters.

To add a spare point code to the allowed OPC screen, the `pcst=s` parameter must be specified. To add a non-spare point code to the allowed OPC screen, the `pcst` parameter does not have to be specified. If the `pcst` parameter is specified for a screen containing an ITU-I or 14-bit ITU-N non-spare point code, the value must be `none`.

## Allowed Originating Point Code (OPC) Screen Configuration

For this example, enter these commands.

```
ent-scr-opc:sr=gws4:ni=001:nc=001:ncm=001:nsfi=blkopc:nsr=gws3
```

A message similar to the following should appear.

```
rlghncxa03w 05-09-25 15:28:30 GMT EAGLE5 34.0.0
ENT-SCR-OPC: SCREEN SET AFFECTED - GWS4 1% FULL
ENT-SCR-OPC: MASP A - COMPLTD
```

```
ent-scr-opc:sr=fld2:ni=010:nc=010:ncm=010:nsfi=blkopc:nsr=fld3
```

A message similar to the following should appear.

```
rlghncxa03w 05-09-25 15:29:30 GMT EAGLE5 34.0.0
ENT-SCR-OPC: SCREEN SET AFFECTED - FLD2 1% FULL
ENT-SCR-OPC: MASP A - COMPLTD
```

```
ent-scr-opc:sr=isp1:ni=015:nc=015:ncm=015:nsfi=blkopc:nsr=isp1
```

A message similar to the following should appear.

```
rlghncxa03w 05-09-25 15:29:30 GMT EAGLE5 34.0.0
ENT-SCR-OPC: SCREEN SET AFFECTED - ISP1 1% FULL
ENT-SCR-OPC: MASP A - COMPLTD
```

```
ent-scr-opc:sr=tup1:ni=017:nc=017:ncm=017:nsfi=sio:nsr=tup1
```

A message similar to the following should appear.

```
rlghncxa03w 05-09-25 15:29:30 GMT EAGLE5 34.0.0
ENT-SCR-OPC: SCREEN SET AFFECTED - TUP1 1% FULL
ENT-SCR-OPC: MASP A - COMPLTD
```

---

9. Verify the changes using the **rtrv-scr-opc** command with the screening reference name used in step 8. For this example, enter these commands.

```
rtrv-scr-opc:sr=gws4
```

The following is an example of the possible output.

```
rlghncxa03w 05-09-25 15:30:30 GMT EAGLE5 34.0.0
SCREEN = ALLOWED OPC
SR   NI      NC      NCM      NSFI      NSR/ACT
GWS4 001      001      001      BLKOPC    GWS3
```

```
rtrv-scr-opc:sr=fld2
```

The following is an example of the possible output.

```
rlghncxa03w 05-09-25 15:31:30 GMT EAGLE5 34.0.0
SCREEN = ALLOWED OPC
SR   NI      NC      NCM      NSFI      NSR/ACT
FLD2 010      010      010      BLKOPC    FLD3
```

```
rtrv-scr-opc:sr=isp1
```

The following is an example of the possible output.

```
rlghncxa03w 05-09-25 15:31:30 GMT EAGLE5 34.0.0
SCREEN = ALLOWED OPC
SR   NI      NC      NCM      NSFI      NSR/ACT
ISP1 015      015      015      BLKOPC    ISP1
```

## Allowed Originating Point Code (OPC) Screen Configuration

```
rtrv-scr-opc:sr=tup1
```

The following is an example of the possible output.

```
rlghncxa03w 05-09-25 15:31:30 GMT EAGLE5 34.0.0
SCREEN = ALLOWED OPC
SR      NI      NC      NCM      NSF1     NSR/ACT
TUP1   017     017     017     SIO      TUP1
```

---

10. Backup the new changes using the `chg-db:action=backup:dest=fixed` command. The following messages should appear, the active Maintenance and Administration Subsystem Processor (MASP) appears first.

```
BACKUP (FIXED) : MASP A - Backup starts on active MASP.
BACKUP (FIXED) : MASP A - Backup on active MASP to fixed disk complete.
BACKUP (FIXED) : MASP A - Backup starts on standby MASP.
BACKUP (FIXED) : MASP A - Backup on standby MASP to fixed disk complete.
```

---

## Allowed Originating Point Code (OPC) Screen Configuration

Flowchart 12-2. Adding an Allowed OPC Screen (Sheet 1 of 5)

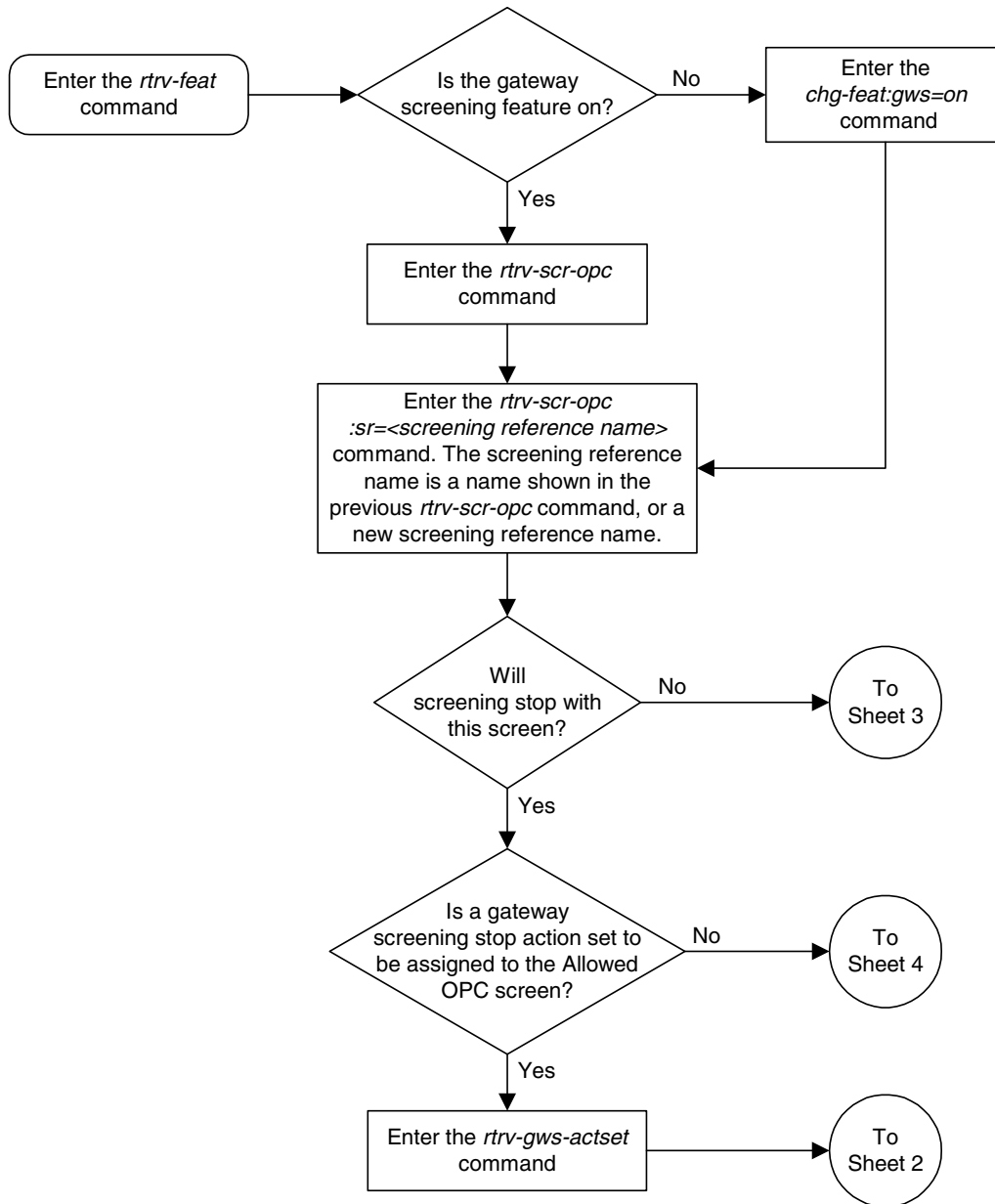

Flowchart 12-2. Adding an Allowed OPC Screen (Sheet 2 of 5)

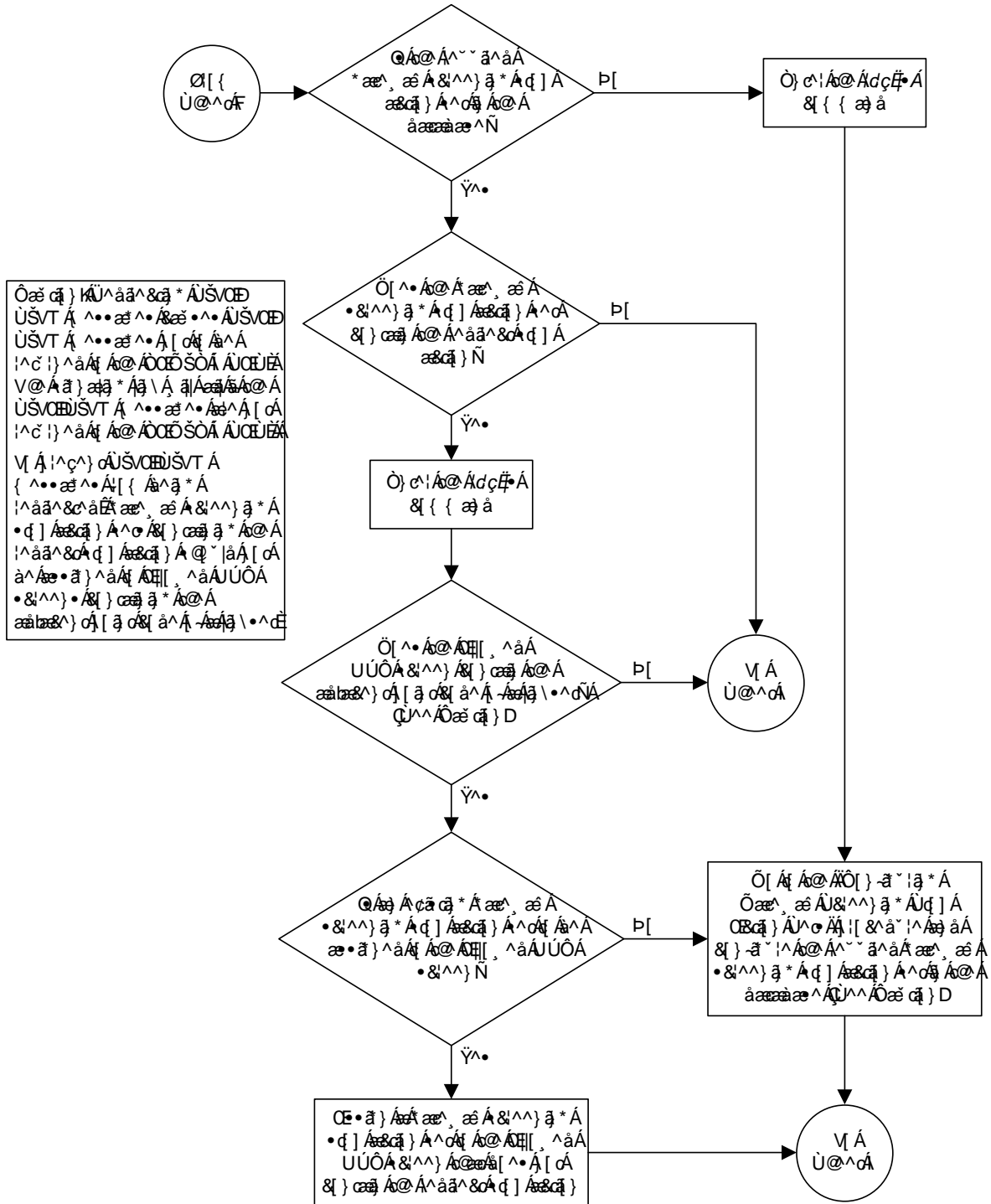

# Allowed Originating Point Code (OPC) Screen Configuration

## Flowchart 12-2. Adding an Allowed OPC Screen (Sheet 3 of 5)

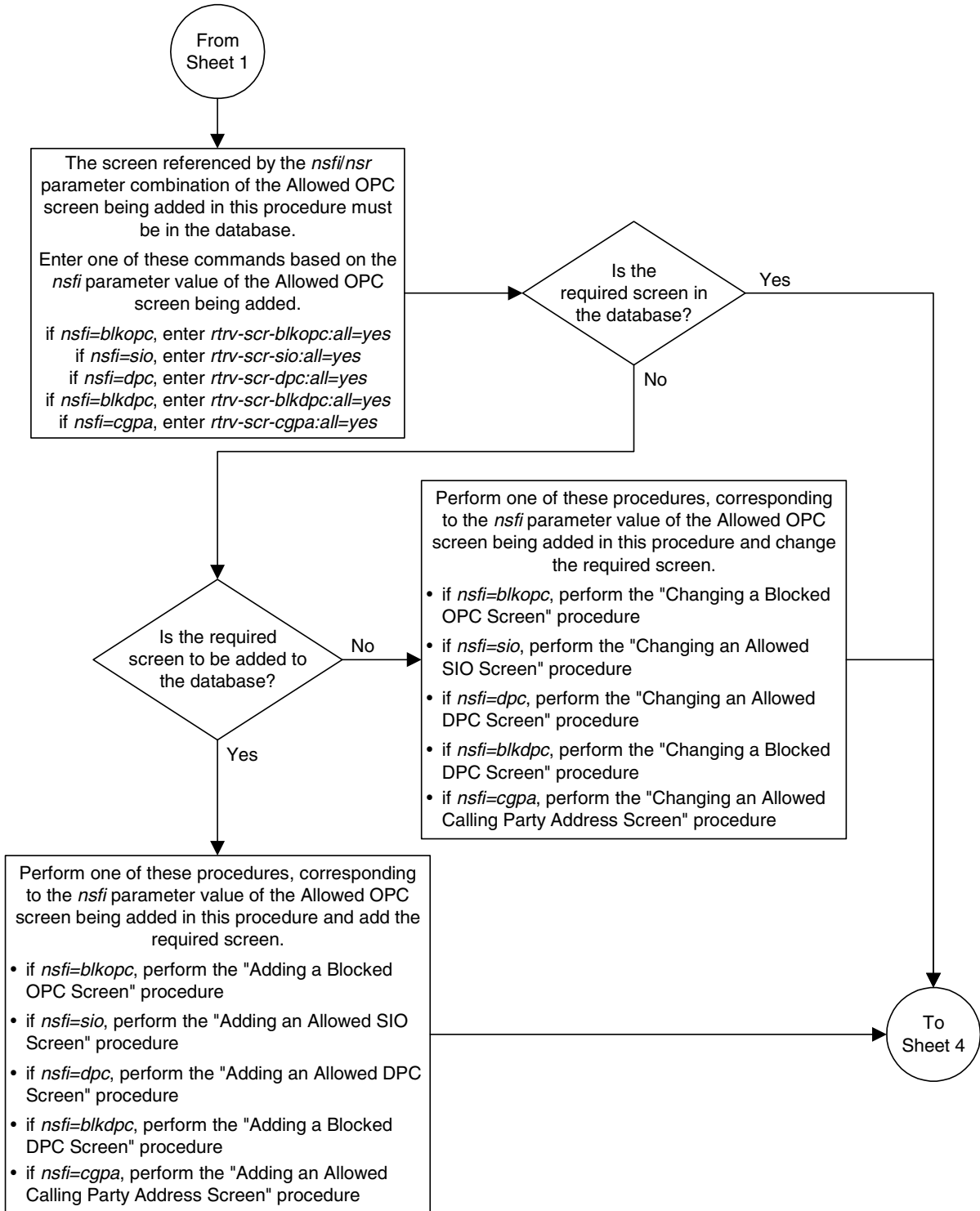

Flowchart 12-2. Adding an Allowed OPC Screen (Sheet 4 of 5)

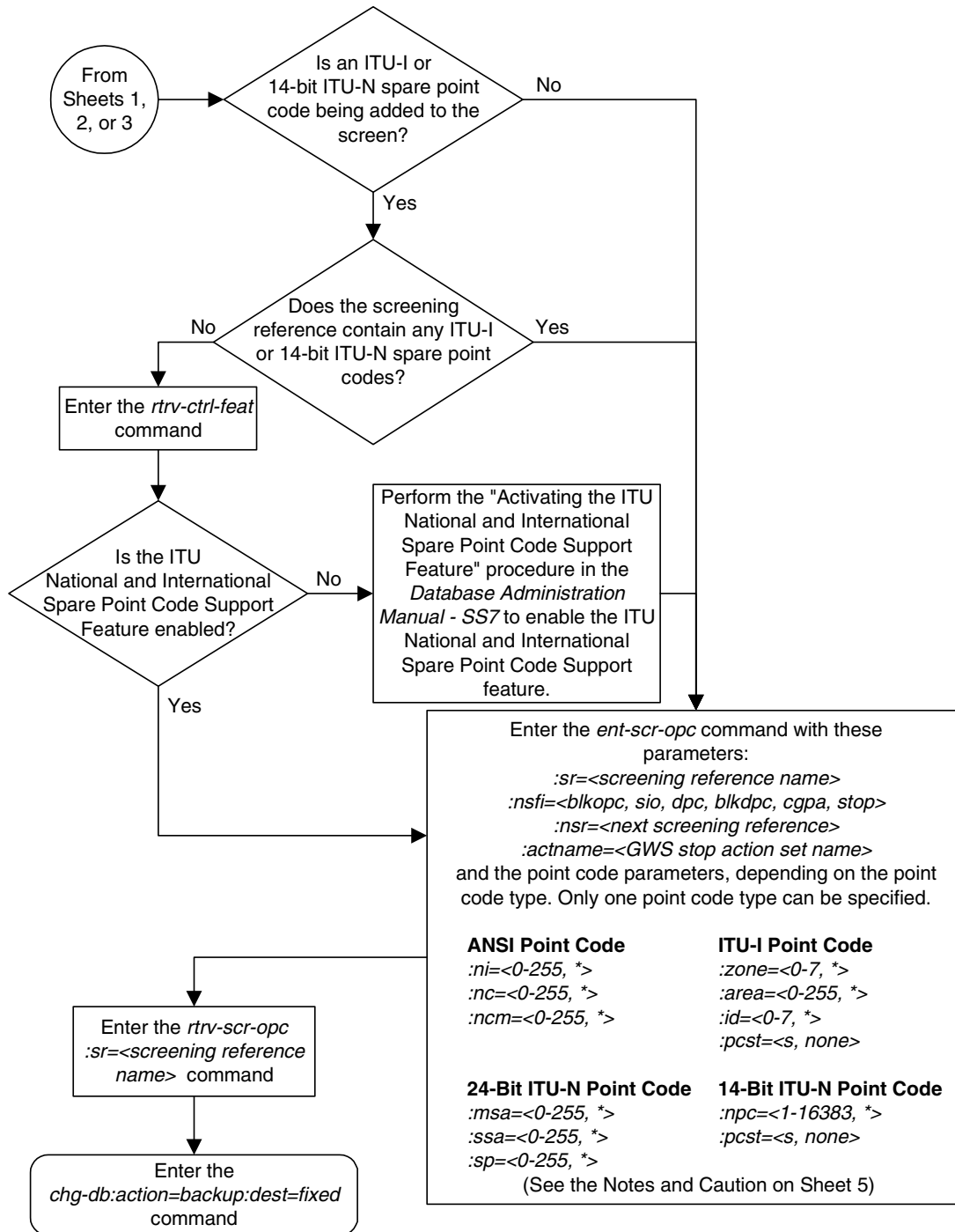



Allowed Originating Point Code (OPC) Screen Configuration

Flowchart 12-2. Adding an Allowed OPC Screen (Sheet 5 of 5)

```

P[ c•kÁ
FÉVÁæ *^Á -Áæ^• Áæ Á^Á] ^8áá áÁ; Á@Á æ Á; Á & Á ææ ^c! Á^Á
á •Á ç * Á [ ~ á | Áæ ] | Á •æ á • Á BBDÁ^ç ^Á) Á@Á ææ ^c! Áæ^• Á^á á * Á@Á
|æ * Á ÉVÁ | Áæ ] | Á Á] ^8á Á@Áæ * ÁÉÁ Á ÁÉÁ; Á@Á ææ ^c! Á; c! Á
ÉÁ BBÉÁ; Á@Á ææ ^c! Áæ^• Á
GÉV@ Áæ c! á | ÁÉÁ] ^8áá • Á@Á) c! Áæ * ^Á -Áæ^• Á; Á@Á ææ ^c! ÉÁ
Q! Á | | Á | { ææ } Áæ [ ~ c! ] ^8á á * Áæ * ^Á -Áæ^• Á; Áæ á Áæ [ ~ c! á * Á@Á
æ c! á | Á ^ Á@Áæ, æ Á Á^Á) á * ÁÁæ c! Á^Á & á; Á Á@Á c! Á Á; á Á@Á
Á] ^8á á * Á Áæ * ^Á -Áæ^• Á^Á & á; Á Á@Á | | & Á^• | ^É
HÉV@ Á • Áææ ^c! Áæ Á^Á] ^8áá áÁ; | Éá áÁ ~ • c! Á] ^8áá á Á@Á • á
] ææ ^c! Áæ^• Á Á@Á | | | Éá á Á; | Éá | Á; Áæ } æ
| ÉV@ Áæ ç æ Áææ ^c! Á Á] ç } æá á Áæ Á^Á] ^8áá áÁ; | Á á@Á
} • Á | Áææ ^c! ÉV@ Áæ ç æ Áææ ^c! Á Á] ^8áá á Á@Á ææ Á
] ææ ^c! Áæ^• Á Á) ^Á -Á@Áæ, æ Á & ^Á) á * Á | Áæ ç } Á^c! æ ^Á @, } Á
á Á@Á ç É, • Éá ^c! ~ c! } Á @Á É
| ÉV Áæ á Á [ ] É] æ Á [ á c! á Á@Á & c! ææ ^c! Á [ ^Á [ c! Á Á Á^Á
• ] ^8áá á Á@Á & c! ææ ^c! Á Á] ^8áá á Á; Á & ^Á) Á; } æá á * Á ÁVÉÁ; Á
F | Éá ÁVÉÁ [ ] É] æ Á [ á c! á Á@Áæ^• Á ~ • c! Á | ) ^É
| ÉV Áæ á Á] æ Á [ á c! á Á@Á & c! Áææ ^c! Á ~ • c! Á] ^8áá á Á
Óæ ç; kÁ^áá & á * Á ÚSVÉÚSVT Á • • æ ^Á Áæ • • Á ÚSVÉÚSVT Á • • æ ^Á
} [ c! Á Á^Á c! ) ^á Á Á@Á ÁÁÁ Á ÚÉV@ Á á } æá * Á; Á | Áæ Á@Á ÚSVÉ
ÚSVT Á • • æ ^Á Á [ c! ) ^á Á Á@Á ÁÁÁ Á ÚÉV@
V | Á; ^ç) c! ÚSVÉÚSVT Á • • æ ^Á { | Á á * Á^áá & c! á Áæ, æ Á & ^Á) á * Á
• c! Áæ ç } Á^c! Á; } æá á * Á@Á^áá & c! | Áæ ç } Á @ | á Á [ c! Áæ • á } ^á Á
c! [ , ^á Á ÚÁ & ^Á) • Á; } æá á * Á@Á Áæ c! } [ á c! á Á Áæ | • ^É
    
```

## Removing an Allowed OPC Screen

This procedure is used to remove an allowed originating point code (OPC) screen from the database using the `dlt-scr-opc` command. The parameters used by the `dlt-scr-opc` command are shown in the “Gateway Screening Attributes” section on page 2-7. The general rules that apply to configuring gateway screening entities are shown in the “Gateway Screening Configuration” section on page 2-28.

The example in this procedure removes the allowed OPC screen `gws4` from the database.

**NOTE:** If you using multiple-part ITU national point codes with gateway screening, see “14-Bit ITU National Point Code Formats” on page 2-24.

The allowed OPC screen can only be referenced by a screen set.

Enter the `rtrv-scrset:nsfi=opc` command to verify that none of the screen sets reference the allowed OPC screen being removed from the database.

To change the NSFIs of any of the screen sets, go to the “Changing a Screen Set” procedure on page 13-15.

### Procedure

---

1. Display the allowed OPC screens in the database using the `rtrv-scr-opc` command. The following is an example of the possible output.

```
rlghncxa03w 05-09-25 15:25:30 GMT EAGLE5 34.0.0
SCREEN = ALLOWED OPC
SR   REF  RULES
GWS4 YES   1
IEC  YES   6
ISP1 YES   1
TUP1 YES   1
WRD2 YES   1
WRD4 YES   9
```

From the `rtrv-scr-opc` output, display the allowed OPC screen you wish to remove using the `rtrv-scr-opc` command with the screening reference name. For this example, enter this command.

```
rtrv-scr-opc:sr=gws4
```

The following is an example of the possible output.

```
rlghncxa03w 05-09-25 15:25:30 GMT EAGLE5 34.0.0
SCREEN = ALLOWED OPC
SR   NI      NC      NCM      NSFI      NSR/ACT
GWS4 001      001      001      BLKOPC    GWS7
```

---

2. Enter the `rtrv-scrset:nsfi=opc` command to verify that none of the screen sets reference the allowed OPC screen being removed from the database.

## Allowed Originating Point Code (OPC) Screen Configuration

To change the NSFI of any of the screen sets, go to the “Changing a Screen Set” procedure on page 13-15.

---

3. Remove the allowed OPC screen from the database using the **dlt-scr-opc** command with the screening reference name shown in the **rtrv-scr-opc** output in step 1 and with the point code parameter values (**ni**, **nc**, **ncm**, or **zone**, **area**, **id**, or **npc**, or **msa**, **ssa**, **sp**) of the screen being removed from the database. The values for these parameters must be entered exactly as shown in the **rtrv-scr-opc** output.

To remove an entry containing either an ITU-I or a 14-bit ITU-N spare point code, the **pcst=s** parameter must be specified with the **dlt-scr-opc** command.

To remove an entry containing either an ITU-I or a 14-bit ITU-N non-spare point code, the **pcst** parameter does not have to be specified with the **dlt-scr-opc** command. If the **pcst** parameter is specified, the value must be **none**.

For this example, enter this command.

```
dlt-scr-opc:sr=gws4:ni=001:nc=001:ncm=001
```

A message similar to the following should appear.

```
rlghncxa03w 05-09-25 15:26:30 GMT EAGLE5 34.0.0
DLT-SCR-OPC: SCREEN SET AFFECTED - GWS4 0% FULL
DLT-SCR-OPC: MASP A - COMPLTD
```

---

4. Verify the changes using the **rtrv-scr-opc** command with the screening reference name used in step 3. For this example, enter this command.

```
rtrv-scr-opc:sr=gws4
```

The following is an example of the possible output.

```
E2573 Cmd Rej: SR or NSR does not reference an existing SR
```

This message shows that the specified screening reference name is not in the database and the action of the **dlt-scr-opc** command in step 3 was successful. If the specified screening reference name contained more than one entry when the **dlt-scr-opc** command was executed in step 3, the **rtrv-scr-opc:sr=** command output would show the remaining entries in the screening reference instead of error message E2573.

---

5. Backup the new changes using the **chg-db:action=backup:dest=fixed** command. The following messages should appear, the active Maintenance and Administration Subsystem Processor (MASP) appears first.

```
BACKUP (FIXED) : MASP A - Backup starts on active MASP.
BACKUP (FIXED) : MASP A - Backup on active MASP to fixed disk complete.
BACKUP (FIXED) : MASP A - Backup starts on standby MASP.
BACKUP (FIXED) : MASP A - Backup on standby MASP to fixed disk complete.
```

---

Flowchart 12-3. Removing an Allowed OPC Screen

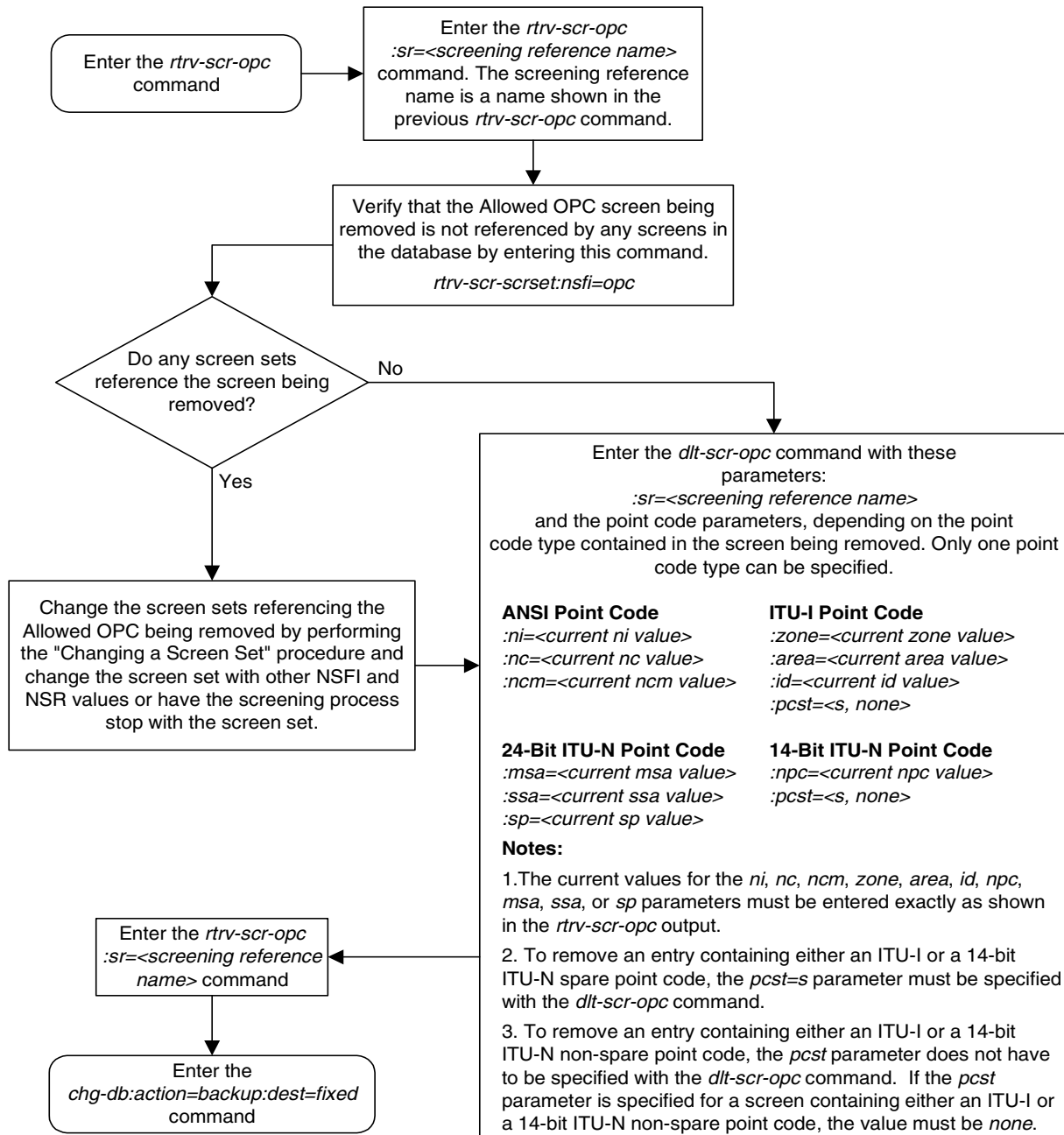

## Changing an Allowed OPC Screen

This procedure is used to change the attributes of an allowed originating point code (OPC) screen in the database using the **chg-scr-opc** command. The parameters used by the **chg-scr-opc** command are shown in the "Gateway Screening Attributes" section on page 2-7. The general rules that apply to configuring gateway screening entities are shown in the "Gateway Screening Configuration" section on page 2-28.

The example in this procedure is used to change the point code for the allowed OPC screen **wrd2** to 230-230-230, the NSFI to **blkopc**, and the NSR to **wrd6**.

**NOTE: If you using multiple-part ITU national point codes with gateway screening, see "14-Bit ITU National Point Code Formats" on page 2-24.**

The allowed OPC screen can reference one of the following screens.

- Blocked OPC
- Allowed SIO
- Allowed DPC
- Blocked DPC
- Allowed CGPA

Enter the following commands to verify that these screens are in the database.

- **rtrv-scr-blkopc:all=yes**
- **rtrv-scr-sio:all=yes**
- **rtrv-scr-dpc:all=yes**
- **rtrv-scr-blkdpc:all=yes**
- **rtrv-scr-cgpa:all=yes**

If the desired screen is not in the database, go to one of the following procedures and add the desired screen to the database or change an existing screen in the database.

- "Adding a Blocked OPC Screen" procedure on page 11-8
- "Adding an Allowed SIO Screen" procedure on page 10-9
- "Adding an Allowed DPC Screen" procedure on page 9-8
- "Adding a Blocked DPC Screen" procedure on page 8-8
- "Adding an Allowed Calling Party Address Screen" procedure on page 6-6
- "Changing a Blocked OPC Screen" procedure on page 11-26
- "Changing an Allowed SIO Screen" procedure on page 10-23
- "Changing an Allowed DPC Screen" procedure on page 9-26

- “Changing a Blocked DPC Screen” procedure on page 8-26
- “Changing an Allowed Calling Party Address Screen” procedure on page 6-23

### Specifying a Range of Values

A range of values can be specified for the point code parameters **ni**, **nc**, or **ncm**.

If a range of values is specified for any of these parameters, and the value of the other parameters match existing values for the screening reference name, the range of values for the point code parameter cannot include any values for that parameter that are currently provisioned for the screening reference name.

For example, screening reference name **scr1** contains these entries:

SR	NI	NC	NCM	NSFI	NSR/ACT
SCR1	240	001	010	CGPA	-----
SCR1	241	010	020	STOP	-----

Another entry for screening reference **scr1** with the **ni** value of 240 and the **nc** value of 001 cannot be specified if the range of values for the **ncm** parameter includes the value 010.

The ANSI point code parameter values can be specified as a single value, a range of values, or with an asterisk (\*). The asterisk specifies all possible values for the **ni**, **nc**, and **ncm** parameters. Table 12-5 shows the valid combinations of these parameter values.

**Table 12-5.** Valid Value Combinations for ANSI Point Code Parameters

NI	NC	NCM
Single Value	Single Value	Single Value
Single Value	Single Value	Range of Values
Single Value	Single Value	Asterisk
Single Value	Range of Values	Asterisk
Single Value	Asterisk	Asterisk
Range of Values	Asterisk	Asterisk
Asterisk	Asterisk	Asterisk

A range of values can also be specified for an ITU-I or 24-bit ITU-N point code parameter using a combination of asterisks (\*) and single values for the point code parameters. Table 12-6 shows the valid combinations of the ITU-I parameter values. Table 12-7 shows the valid combinations of the 24-bit ITU-N parameter values.

## Allowed Originating Point Code (OPC) Screen Configuration

**Table 12-6.** Valid Value Combinations for ITU-I Point Code Parameters

ZONE	AREA	ID
Single Value	Single Value	Single Value
Single Value	Single Value	Asterisk
Single Value	Asterisk	Asterisk
Asterisk	Asterisk	Asterisk

**Table 12-7.** Valid Value Combinations for 24-Bit ITU-N Point Code Parameters

MSA	SSA	SP
Single Value	Single Value	Single Value
Single Value	Single Value	Asterisk
Single Value	Asterisk	Asterisk
Asterisk	Asterisk	Asterisk

### Procedure

---

1. Display the allowed OPC screens in the database using the **rtrv-scr-opc** command. The following is an example of the possible output.

```
rlghncxa03w 05-09-25 15:25:30 GMT EAGLE5 34.0.0
SCREEN = ALLOWED DPC
SR   REF  RULES
GWS4 YES   1
IEC  YES   6
ISP1 YES   1
TUP1 YES   1
WRD2 YES   1
WRD4 YES   9
```

From the **rtrv-scr-opc** output, display the allowed OPC screen you wish to remove using the **rtrv-scr-opc** command with the screening reference name. For this example, enter this command.

```
rtrv-scr-opc:sr=wrд2
```

The following is an example of the possible output.

```
rlghncxa03w 05-09-25 15:25:30 GMT EAGLE5 34.0.0
SCREEN = ALLOWED OPC
SR   NI      NC      NCM      NSF1     NSR/ACT
WRD2 243     015     001     STOP     -----
```

If a gateway screening stop action set is to be assigned to the allowed OPC screen being changed in the database, go to step 2.

## Allowed Originating Point Code (OPC) Screen Configuration

Step 2 verifies the gateway screening stop action set names in the database. The gateway screening stop action set names are assigned only if the NSFI of the screen being changed in this procedure is STOP. If the NSFI of the screen will be changed to STOP, but a gateway screening stop action set name will not be assigned to the screen, skip steps 2, 3, and 4 and go to step 5. If the NSFI of the screen will not be STOP, skip step 2 and 3, and go to step 4.

2. Display the gateway screening stop action sets in the database with the **rtrv-gws-actset** command. This is an example of the possible output.

```
rlghncxa03w 05-09-25 15:26:30 GMT EAGLE5 34.0.0
ACT ACT ACT ACT ACT ACT ACT ACT ACT ACT ACT
ID NAME 1 2 3 4 5 6 7 8 9 10
--
1 copy copy
2 rdct rdct
3 cr copy rdct
4 cncf cncf
5 cpncf copy cncf
6 cncfrd cncf rdct
7 cpcfrd copy cncf rdct
```

GWS action set table is (7 of 16) 44% full

If the required gateway screening stop action set is not in the database, go to the "Configuring Gateway Screening Stop Action Sets" procedure on page 2-54 and configure the required gateway screening stop action set.

**NOTE:** If the gateway screening stop action set being assigned to the Allowed OPC screen does not contain the redirect stop action, skip step 3 and go to step 4.

3. Verify the point codes of adjacent nodes by entering the **rtrv-ls** command. The following is an example of the possible output.

```
rlghncxa03w 05-09-10 11:43:04 GMT EAGLE5 34.0.0
LSN          APCA  (SS7)  SCRN  SET SET BEI LST LNKS  ACT MES DIS SLSCI NIS
e1e2         001-207-000  none  1  1  no  B  6  off off off no  off
ls1305       000-005-000  none  1  1  no  A  1  off off off no  off
ls1307       000-007-000  none  1  1  no  A  1  off off off no  off
e1m1s1      001-001-001  none  1  1  no  A  7  off off off no  off
e1m1s2      001-001-002  none  1  1  no  A  7  off off off no  off

LSN          APCA  (X25)  SCRN  SET SET BEI LST LNKS  ACT MES DIS SLSCI NIS

LSN          APCI  (SS7)  SCRN  SET SET BEI LST LNKS  ACT MES DIS SLSCI NIS
e1e2i        1-207-0      none  1  1  no  B  4  off off off ---  on
ls1315       0-015-0      none  1  1  no  A  1  off off off ---  off
ls1317       0-017-0      none  1  1  no  A  1  off off off ---  on
e1m2s1      1-011-1      none  1  1  no  A  7  off off off ---  off
e1m2s2      1-011-2      none  1  1  no  A  7  off off off ---  off
```



## Allowed Originating Point Code (OPC) Screen Configuration

```
LSN          APCN   (SS7)  SCRN  L3T SLT          GWS GWS GWS
          SET SET BEI LST LNKS ACT MES DIS SLSCI NIS

LSN          APCN24 (SS7)  SCRN  L3T SLT          GWS GWS GWS
          SET SET BEI LST LNKS ACT MES DIS SLSCI NIS

LSN (CHINA)  APCN   (SS7)  SCRN  L3T SLT          GWS GWS GWS
          SET SET BEI LST LNKS ACT MES DIS SLSCI NIS

LSN (CHINA)  APCN24 (SS7)  SCRN  L3T SLT          GWS GWS GWS
          SET SET BEI LST LNKS ACT MES DIS SLSCI NIS
```

Link set table is (10 of 1024) 1% full.



**CAUTION:** Redirecting SLTA/SLTM messages prevents SLTA/SLTM messages from being returned to the EAGLE 5 SAS. The signaling link carrying these messages will fail if these messages are not returned to the EAGLE 5 SAS. To prevent SLTA/SLTM messages from being redirected, gateway screening stop action sets containing the redirect stop action should not be assigned to Allowed OPC screens containing the adjacent point code of a linkset.

---

**NOTE:** If the NSFI of the screen being changed in this procedure will be STOP, or if the NSFI of the screen is not being changed, skip step 4 and go to step 5.

4. Enter the commands on page 12-25 to verify that the screen that will be specified by the NSFI/NSR parameter combination in step 6 is in the database.

If the desired screen is not in the database, go to one of the procedures shown on pages 12-25 and 12-26 and either add the desired screen to the database or change an existing screen in the database.

---

**NOTE:** If any of these conditions apply to this procedure, skip this step and go to step 6:

- The point code in the screen is not being changed.
- The screen being changed contains either an ANSI or 24-bit ITU-N point code.
- The ITU-I or 14-bit ITU-N non-spare point code in the screen is not being changed to an ITU-I or 14-bit ITU-N spare point code.
- The point code in the screen is an ITU-I or 14-bit ITU-N spare point code or the screening reference contains other screens with ITU-I or 14-bit ITU-N spare point codes.

5. Display the status of the ITU National and International Spare Point Code Support feature by entering the `rtrv-ctrl-feat` command with the ITU National and International Spare Point Code Support feature part number. Enter this command.

`rtrv-ctrl-feat:partnum=893013601`

This is an example of the possible output.

```
rlghncxa03w 05-09-25 15:25:30 GMT EAGLE5 34.0.0
The following features have been permanently enabled:
```

Feature Name	Partnum	Status	Quantity
Spare Point Code Support	893013601	on	----

The following features have been temporarily enabled:

Feature Name	Partnum	Status	Quantity	Trial Period Left
Zero entries found.				

The following features have expired temporary keys:

Feature Name	Partnum
Zero entries found.	

If the ITU National and International Spare Point Code Support feature is enabled, go to step 6.

If the ITU National and International Spare Point Code Support feature is not enabled, perform the “Activating the ITU National and International Spare Point Code Support Feature” procedure in the *Database Administration Manual - SS7* to enable the ITU National and International Spare Point Code Support feature as required. After the feature has been enabled, go to step 6.

6. Change the attributes for the allowed OPC using the `chg-scr-opc` command.

If a gateway screening stop action is to be assigned to the allowed OPC screen being changed, enter the `chg-scr-opc` command with the `nsfi=stop` parameter and the `actname` parameter with the name of a gateway screening stop action set shown in the output of the `rtrv-gws-actset` command executed in step 2.



**CAUTION:** Redirecting SLTA/SLTM messages prevents SLTA/SLTM messages from being returned to the EAGLE 5 SAS. The signaling link carrying these messages will fail if these messages are not returned to the EAGLE 5 SAS. To prevent SLTA/SLTM messages from being redirected, gateway screening stop action sets containing the redirect stop action should not be assigned to Allowed OPC screens containing the adjacent point code of a linkset, shown in step 3.

The current values for the `ni`, `nc`, `ncm`, `zone`, `area`, `id`, `npc`, `msa`, `ssa`, and `sp` parameters must be entered exactly as shown in the `rtrv-scr-opc` output in step 1.

## Allowed Originating Point Code (OPC) Screen Configuration

The following list contains the values for the **nni**, **nnc**, **nncm**, **nzone**, **narea**, **nid**, and **nnpc** parameters:

- **nni** – 0 - 255 or an asterisk (\*)
- **nnc** – 0 - 255 or an asterisk (\*)
- **nncm** – 0 - 255 or an asterisk (\*)
- **nzone** – 0 - 7 or an asterisk (\*)
- **narea** – 0 - 255 or an asterisk (\*)
- **nid** – 0 - 7 or an asterisk (\*)
- **nnpc** – 1 - 16383 or an asterisk (\*)
- **nmsa** – 0 - 255 or an asterisk (\*)
- **nssa** – 0 - 255 or an asterisk (\*)
- **nsp** – 0 - 255 or an asterisk (\*)

A range of values can be specified for the **nni**, **nnc**, and **nncm** parameters. See the “Specifying a Range of Values” section on page 12-26 for more information on how the asterisk and a range of values are used for the **nni**, **nnc**, and **nncm** parameters.

To change an ITU-I or 14-bit ITU-N spare point code to a non-spare point code, both the **pcst=s** and **npcst=none** parameters must be specified with the **chg-scr-opc** command.

To change an ITU-I or 14-bit ITU-N non-spare point code to a spare point code, the **npcst=s** parameter must be specified with the **chg-scr-opc** command. The **pcst** parameter does not have to be specified.

If the current point code in the screen being changed is either an ITU-I or 14-bit ITU-N spare point code, the **pcst=s** parameter must be specified with the **chg-scr-opc** command.

If the current point code in the screen being changed is either an ITU-I or 14-bit ITU-N non-spare point code, the **pcst** parameter does not have to be specified with the **chg-scr-opc** command. If the **pcst** parameter is specified for a screen containing either an ITU-I or 14-bit ITU-N non-spare point code, the **pcst** parameter value must be **none**.

For this example, enter this command.

```
chg-scr-opc:sr=wrld2:ni=243:nc=015:nncm=001:nni=230:nc=230  
:nncm=230:nsfi=blkopc:nsr=wrld6
```

A message similar to the following should appear.

```
rlghncxa03w 05-09-25 15:27:30 GMT EAGLE5 34.0.0  
CHG-SCR-OPC: SCREEN SET AFFECTED - WRD2 1% FULL  
CHG-SCR-OPC: MASP A - COMPLTD
```

---

## Allowed Originating Point Code (OPC) Screen Configuration

- Verify the changes using the `rtrv-scr-opc` command with the screening reference name used in step 6. For this example, enter this command.

```
rtrv-scr-opc:sr=wrd2
```

The following is an example of the possible output.

```
rlghncxa03w 05-09-25 15:28:30 GMT EAGLE5 34.0.0  
SCREEN = ALLOWED OPC  
SR   NI       NC       NCM       NSFI      NSR/ACT  
WRD2 230      230      230      BLKOPC   WRD6
```

---

- Backup the new changes using the `chg-db:action=backup:dest=fixed` command. The following messages should appear, the active Maintenance and Administration Subsystem Processor (MASP) appears first.

```
BACKUP (FIXED) : MASP A - Backup starts on active MASP.  
BACKUP (FIXED) : MASP A - Backup on active MASP to fixed disk complete.  
BACKUP (FIXED) : MASP A - Backup starts on standby MASP.  
BACKUP (FIXED) : MASP A - Backup on standby MASP to fixed disk complete.
```

---

**Flowchart 12-4.** Changing an Allowed OPC Screen (Sheet 1 of 6)

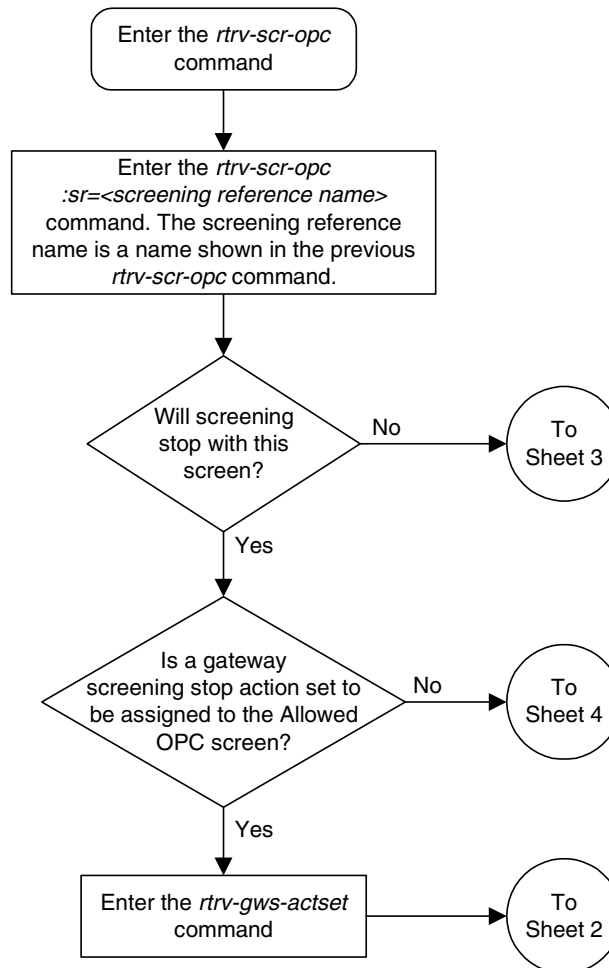

Allowed Originating Point Code (OPC) Screen Configuration

Flowchart 12-4. Changing an Allowed OPC Screen (Sheet 2 of 6)

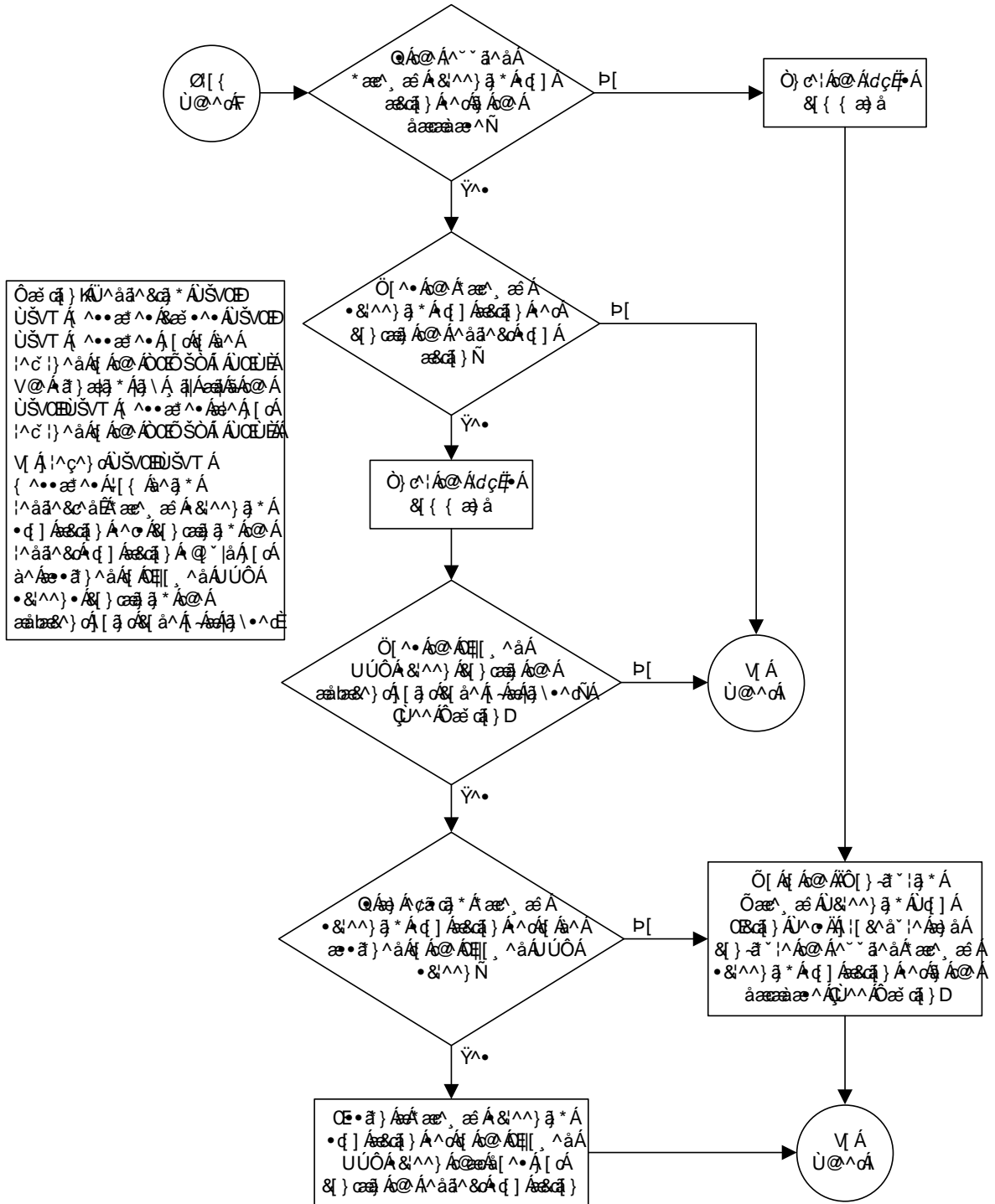

Flowchart 12-4. Changing an Allowed OPC Screen (Sheet 3 of 6)

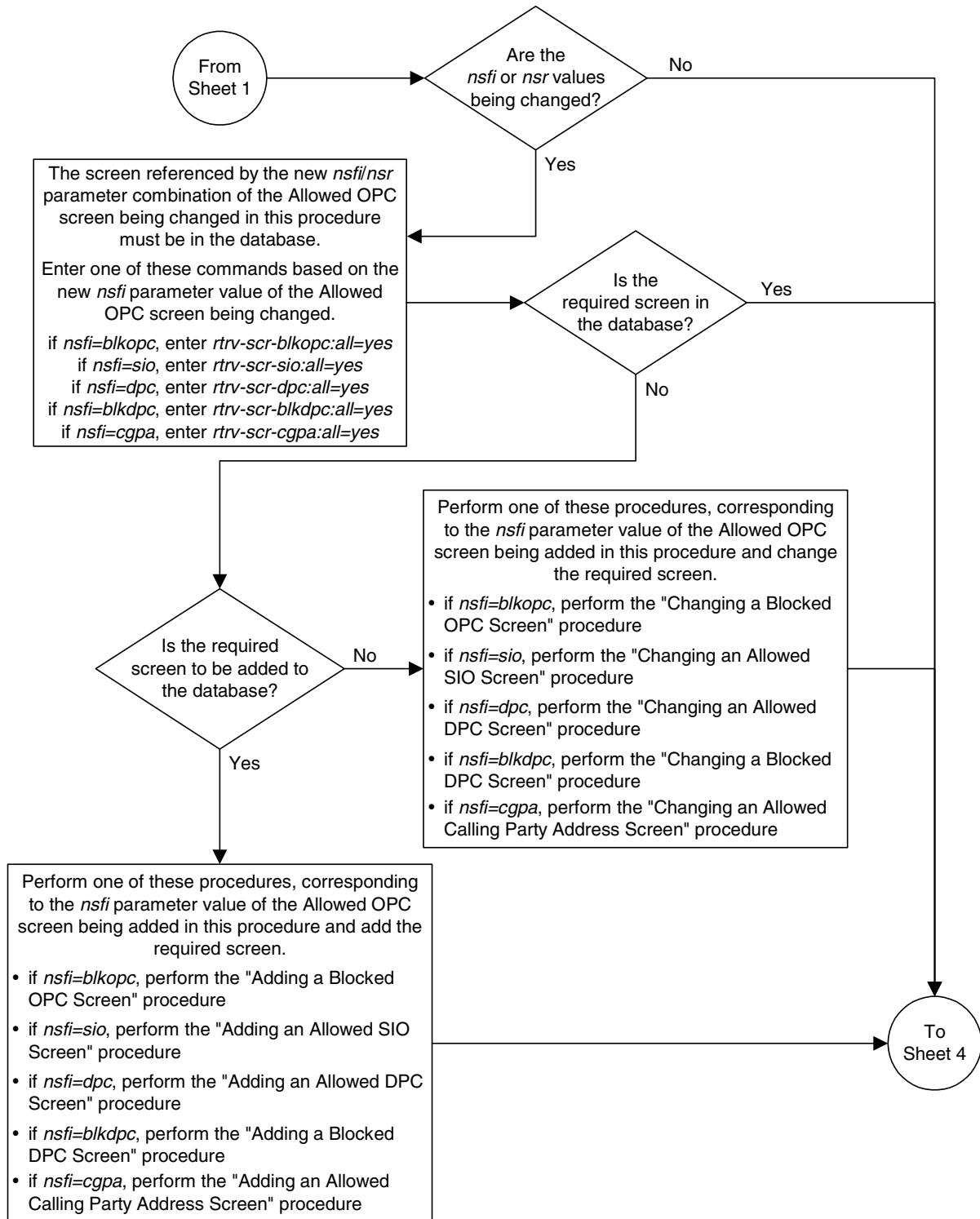

Allowed Originating Point Code (OPC) Screen Configuration

Flowchart 12-4. Changing an Allowed OPC Screen (Sheet 4 of 6)

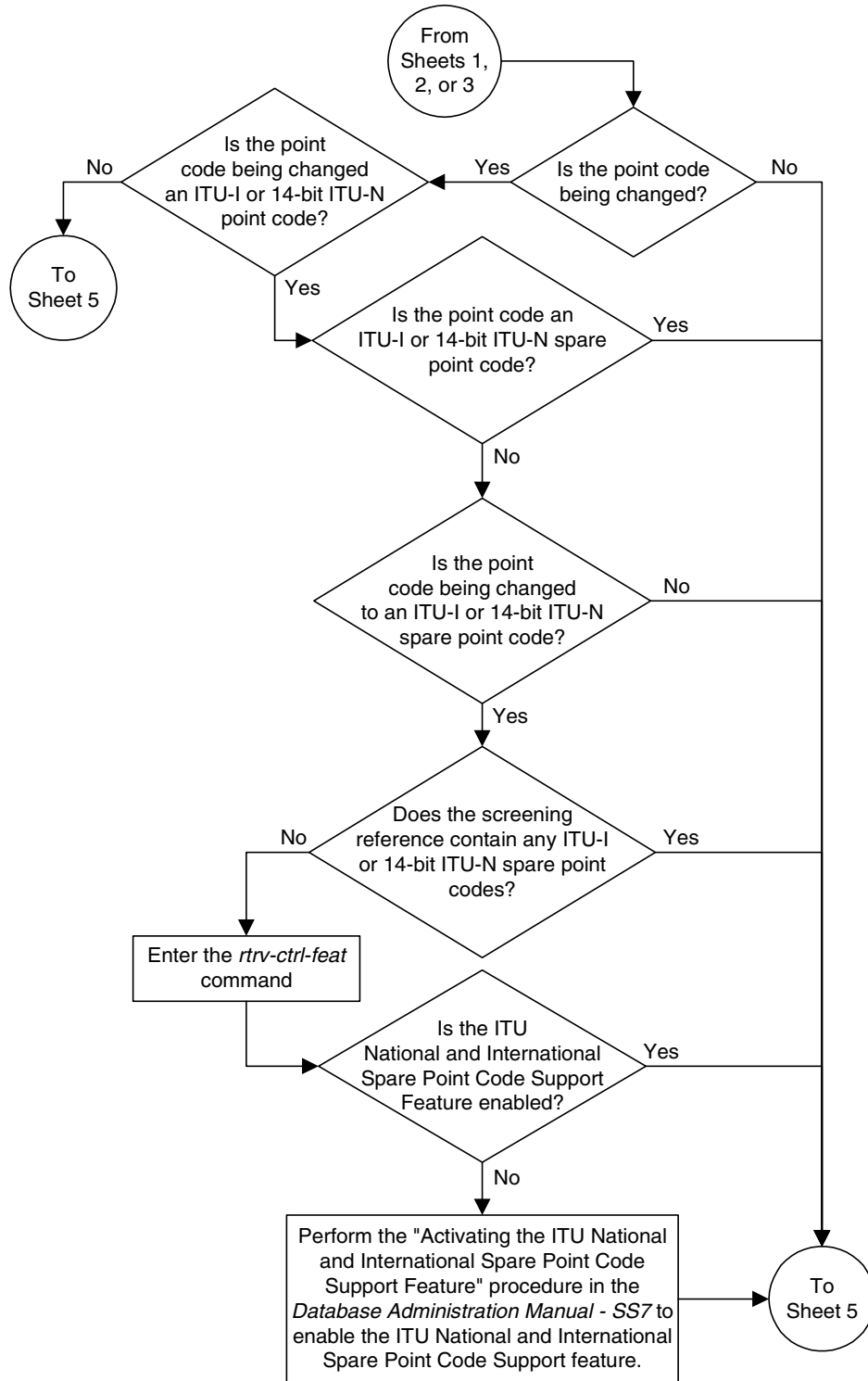

## Allowed Originating Point Code (OPC) Screen Configuration

**Flowchart 12-4.** Changing an Allowed OPC Screen (Sheet 5 of 6)

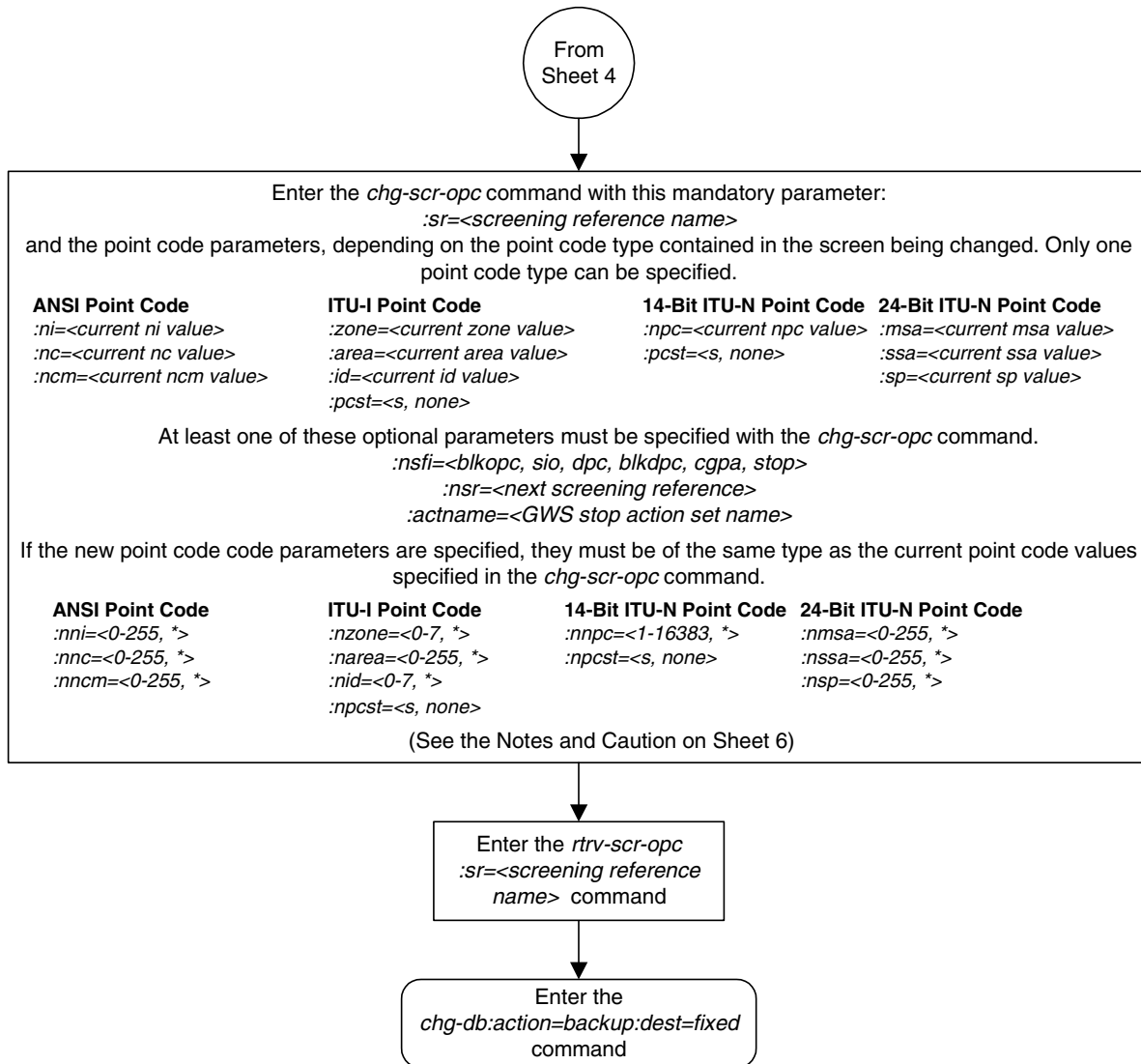



Flowchart 12-4. Changing an Allowed OPC Screen (Sheet 6 of 6)



## Allowed Originating Point Code (OPC) Screen Configuration

# 13

## Screen Set Configuration

Introduction.....	13-2
Automatic Destination Field Screening.....	13-2
Adding a Screen Set .....	13-3
Removing a Screen Set .....	13-12
Changing a Screen Set.....	13-15

## Introduction

A screen set is a gateway screening table containing a list of rules, or screening references. The screening references indicate the screening action that is to be performed on a message in a specific linkset. These screening references are configured in Chapters 3 through 12. The screen set is assigned to a linkset. When the **gwsa=on** linkset parameter is specified for a specific linkset, all the messages on that linkset will be screened by the gateway screening feature based on the screening references contained in the screen set. For more information of the linkset parameters used for the gateway screening feature, go to the “Gateway Screening States” section on page 2-5, or to the **ent-1s** or **chg-1s** command descriptions in the *Commands Manual*.

## Automatic Destination Field Screening

Network management messages can be screened automatically by gateway screening without configuring an Allowed Affected Destination Field screen. The **destfld=yes** parameter specified with the **ent-scrset** or **chg-scrset** commands turns on automatic screening of the affected destination point code (see Figure 7-1 on page 7-6) in the network management messages. Network management messages contain the value 0 in the service indicator field of the SIO. The network management messages are screened against the routing table, the EAGLE 5 SAS’s point code, and capability point codes. If the affected destination point code matches the EAGLE 5 SAS’s point code, capability point codes, or point codes in the routing table, the message is allowed into the EAGLE 5 SAS. The automatic screening is applied after the last screen in the screening process, containing the **nsfi=stop** parameter, for that screen set.

These network management messages are automatically screened by gateway screening: TFP, TFA, TFR, TFC, UPU, SRST (RSP, RSR). All other network management messages are allowed into the EAGLE 5 SAS.

## Adding a Screen Set

This procedure is used to add a screen set to the database using the `ent-scrset` command. The parameters used by the `ent-scrset` command are shown in the “Gateway Screening Attributes” section on page 2-7. The general rules that apply to configuring gateway screening entities are shown in the “Gateway Screening Configuration” section on page 2-28.

A maximum of 255 screen sets can be configured in the database. If the database contains 255 screen sets, any attempt to add another screen set with the `ent-scrset` command will be rejected. If the database contains 255 screen sets, and you wish to add another screen set, a current screen set must be removed or changed. To remove a screen set, go to the “Removing a Screen Set” procedure on page 13-12. To change an existing screen set, go to the “Changing a Screen Set” procedure on page 13-15.

The examples in this procedure are used to add the screen set data shown in Table 13-1 and based on the example configurations shown in Figure 2-3 on page 2-33 through Figure 2-9 on page 2-45.

**Table 13-1.** Example Gateway Screening Screen Set Configuration Table

Screen Set Name	Next Screening Function Identifier	Next Screening Reference	DESTFLD
gws1	opc	gws4	No
gws2	blkopc	gws5	No
ls01	sio	ls02	Yes
wrd1	dpc	iec	Yes
fld1	opc	fld2	No
isp1	opc	isp1	No
tup1	opc	tup1	No

The screen set can reference one of the following screens.

- Allowed OPC
- Blocked OPC
- Allowed SIO
- Allowed DPC
- Blocked DPC

Enter the following commands to verify that these screens are in the database.

- `rtrv-scr-opc:all=yes`
- `rtrv-scr-blkopc:all=yes`
- `rtrv-scr-sio:all=yes`
- `rtrv-scr-dpc:all=yes`
- `rtrv-scr-blkdpc:all=yes`

If the desired screen is not in the database, go to one of the following procedures and add the desired screen to the database or change an existing screen in the database.

- “Adding an Allowed OPC Screen” procedure on page 12-8
- “Adding a Blocked OPC Screen” procedure on page 11-8
- “Adding an Allowed SIO Screen” procedure on page 10-9
- “Adding an Allowed DPC Screen” procedure on page 9-8
- “Adding a Blocked DPC Screen” procedure on page 8-8
- “Changing an Allowed OPC Screen” procedure on page 12-25
- “Changing a Blocked OPC Screen” procedure on page 11-26
- “Changing an Allowed SIO Screen” procedure on page 10-23
- “Changing an Allowed DPC Screen” procedure on page 9-26
- “Changing a Blocked DPC Screen” procedure on page 8-26

### Procedure

---

1. Verify that the gateway screening feature is on, by entering the `rtrv-feat` command. If the gateway screening feature is on, the `GWS` field is set to `on`.

**NOTE:** The `rtrv-feat` command output contains other fields that are not used by this procedure. If you wish to see all the fields displayed by the `rtrv-feat` command, see the `rtrv-feat` command description in the *Commands Manual*.

If the gateway screening feature is on, shown by the entry `GWS = on` in the `rtrv-feat` command output, skip step 2, and go to step 3.

---

## Screen Set Configuration

- Turn the gateway screening feature on by entering this command.

```
chg-feat:gws=on
```

**NOTE:** Once the gateway screening feature is turned on with the `chg-feat` command, it cannot be turned off.

The gateway screening feature must be purchased before you turn this feature on with the `chg-feat` command. If you are not sure if you have purchased the gateway screening feature, contact your Tekelec Sales Representative or Account Representative.

When the `chg-feat` has successfully completed, this message should appear.

```
rlghncxa03w 05-09-28 11:43:04 GMT EAGLE5 34.0.0
CHG-FEAT: MASP A - COMPLTD
```

---

- Display all the screen sets in the database using the `rtrv-scrset` command. The following is an example of the possible output.

```
rlghncxa03w 05-09-25 15:25:30 GMT EAGLE5 34.0.0
ENTIRE GWS DATABASE IS 1% FULL
CDPA + AFTPC TABLES ARE 1% FULL
THERE ARE 248 SCREEN SETS AVAILABLE
```

THE FOLLOWING ARE OVER 80% FULL:

SCRN	NSFI	NSR/ACT	FULL	RULES	TABLES	DESTFLD
ss01	OPC	opc1	51%	2075	22	YES
ss02	OPC	opc2	2%	75	22	YES
ss03	OPC	opc3	2%	75	22	YES
ss04	OPC	opc1	51%	2075	22	NO
ss07	OPC	opc1	51%	2075	22	YES
ss09	OPC	opc1	51%	2075	22	NO
ss28	OPC	opc1	51%	2075	22	YES

If a gateway screening stop action set is to be assigned to the screen set being added to the database, go to step 4.

Step 4 verifies the gateway screening stop action set names in the database. The gateway screening stop action set names are assigned only if the NSFI of the screen set being added in this procedure is STOP. If the NSFI of the new screen set will be STOP, but a gateway screening stop action set name will not be assigned to the new screen set, skip steps 4 and 5 and go to step 6. If the NSFI of the new screen set is not STOP, skip step 4 and go to step 5.

---

4. Display the gateway screening stop action sets in the database with the **rtrv-gws-actset** command. This is an example of the possible output.

```
rlghncxa03w 05-09-25 15:26:30 GMT EAGLE5 34.0.0
ACT ACT ACT ACT ACT ACT ACT ACT ACT ACT ACT
ID NAME 1 2 3 4 5 6 7 8 9 10
-----
1 copy copy
2 rdct rdct
3 cr copy rdct
4 cncf cncf
5 cpcncf copy cncf
6 cncfrd cncf rdct
7 cpcfird copy cncf rdct
```

GWS action set table is (7 of 16) 44% full

If the required gateway screening stop action set is not in the database, go to the “Configuring Gateway Screening Stop Action Sets” procedure on page 2-54 and configure the required gateway screening stop action set.

---

**NOTE:** If the NSFI of the screen set being added in this procedure is **STOP**, skip step 5 and go to step 6.

5. Enter the commands on page 13-4 to verify that the screen that will be specified by the NSFI/NSR parameter combination in step 6 is in the database.

If the desired screen is not in the database, go to one of the procedures shown on page 13-4 and either add the desired screen to the database or change an existing screen in the database.

- 
6. Add a new screen set to the database using the **ent-scrset** command.

If a gateway screening stop action is to be assigned to the screen set being added, enter the **ent-scrset** command with the **nsfi=stop** parameter and the **actname** parameter with the name of a gateway screening stop action set shown in the output of the **rtrv-gws-actset** command executed in step 4.

For this example, enter these commands.

```
ent-scrset:scrn=gws1:nsfi=opc:nsr=gws4:destfld=no
```

A message similar to the following should appear.

```
rlghncxa03w 05-09-25 15:27:30 GMT EAGLE5 34.0.0
ENT-SCRSET: SCREEN SET AFFECTED - GWS1 1% FULL
ENT-SCRSET: MASP A - COMPLTD
```

```
ent-scrset:scrn=gws2:nsfi=blkopc:nsr=gws5:destfld=no
```

A message similar to the following should appear.

```
rlghncxa03w 05-09-25 15:28:30 GMT EAGLE5 34.0.0
ENT-SCRSET: SCREEN SET AFFECTED - GWS2 1% FULL
ENT-SCRSET: MASP A - COMPLTD
```



## Screen Set Configuration

**ent-scrset:scrn=ls01:nsfi=sio:nsr=ls02:destfld=yes**

A message similar to the following should appear.

```
rlghncxa03w 05-09-25 15:29:30 GMT EAGLE5 34.0.0
ENT-SCRSET: SCREEN SET AFFECTED - LS01 1% FULL
ENT-SCRSET: MASP A - COMPLTD
```

**ent-scrset:scrn=wrđ1:nsfi=dpc:nsr=iec:destfld=yes**

A message similar to the following should appear.

```
rlghncxa03w 05-09-25 15:30:30 GMT EAGLE5 34.0.0
ENT-SCRSET: SCREEN SET AFFECTED - WRD1 1% FULL
ENT-SCRSET: MASP A - COMPLTD
```

**ent-scrset:scrn=fld1:nsfi=opc:nsr=fld2:destfld=no**

A message similar to the following should appear.

```
rlghncxa03w 05-09-25 15:31:30 GMT EAGLE5 34.0.0
ENT-SCRSET: SCREEN SET AFFECTED - FLD1 1% FULL
ENT-SCRSET: MASP A - COMPLTD
```

**ent-scrset:scrn=isp1:nsfi=opc:nsr=isp1:destfld=no**

A message similar to the following should appear.

```
rlghncxa03w 05-09-25 15:31:30 GMT EAGLE5 34.0.0
ENT-SCRSET: SCREEN SET AFFECTED - ISP1 1% FULL
ENT-SCRSET: MASP A - COMPLTD
```

**ent-scrset:scrn=tup1:nsfi=opc:nsr=tup1:destfld=no**

A message similar to the following should appear.

```
rlghncxa03w 05-09-25 15:31:30 GMT EAGLE5 34.0.0
ENT-SCRSET: SCREEN SET AFFECTED - TUP1 1% FULL
ENT-SCRSET: MASP A - COMPLTD
```

- 
7. Verify the changes using the **rtrv-scrset** command. The following is an example of the possible output.

```
rlghncxa03w 05-09-25 15:32:30 GMT EAGLE5 34.0.0
ENTIRE GWS DATABASE IS 1% FULL
CDPA + AFTPC TABLES ARE 1% FULL
THERE ARE 242 SCREEN SETS AVAILABLE
```

THE FOLLOWING ARE OVER 80% FULL:

SCRN	NSFI	NSR/ACT	FULL	RULES	TABLES	DESTFLD
fld1	OPC	fld2	1%	5	4	NO
gws1	OPC	gws4	1%	9	7	NO
gws2	BLKOPC	gws5	1%	5	4	NO
isp1	OPC	isp1	1%	6	4	NO
ls01	SIO	ls02	1%	3	3	YES
ss01	OPC	opc1	51%	2075	22	YES
ss02	OPC	opc2	2%	75	22	YES
ss03	OPC	opc3	2%	75	22	YES
ss04	OPC	opc1	51%	2075	22	NO
ss07	OPC	opc1	51%	2075	22	YES
ss09	OPC	opc1	51%	2075	22	NO
ss28	OPC	opc1	51%	2075	22	YES
tup1	OPC	tup1	1%	8	5	NO
wrđ1	DPC	iec	1%	6	5	YES

---

8. Backup the new changes using the `chg-db:action=backup:dest=fixed` command. The following messages should appear, the active Maintenance and Administration Subsystem Processor (MASP) appears first.

```
BACKUP (FIXED) : MASP A - Backup starts on active MASP.  
BACKUP (FIXED) : MASP A - Backup on active MASP to fixed disk complete.  
BACKUP (FIXED) : MASP A - Backup starts on standby MASP.  
BACKUP (FIXED) : MASP A - Backup on standby MASP to fixed disk complete.
```

---

Flowchart 13-1. Adding a Screen Set (Sheet 1 of 3)

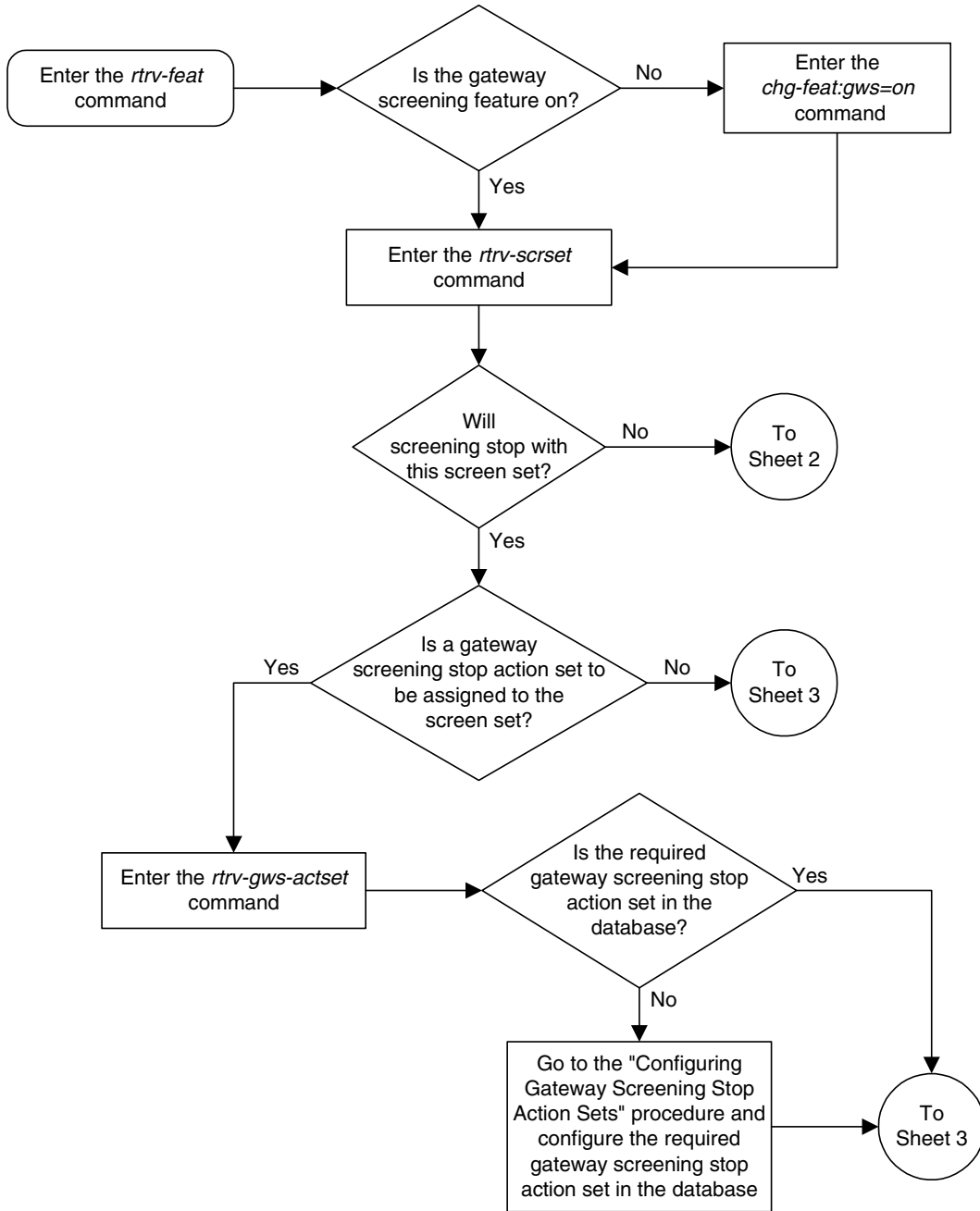

Flowchart 13-1. Adding a Screen Set (Sheet 2 of 3)

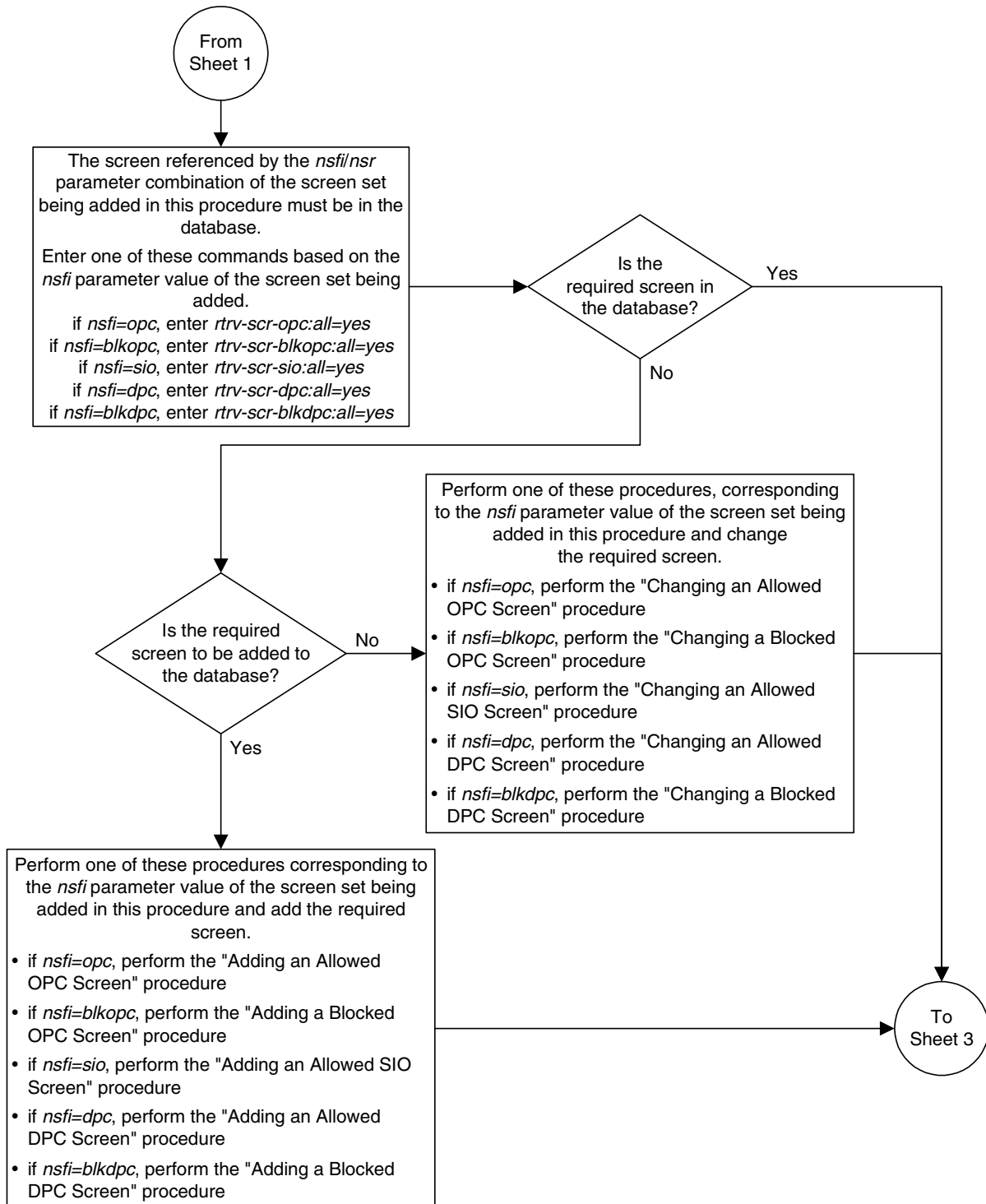

Flowchart 13-1. Adding a Screen Set (Sheet 3 of 3)

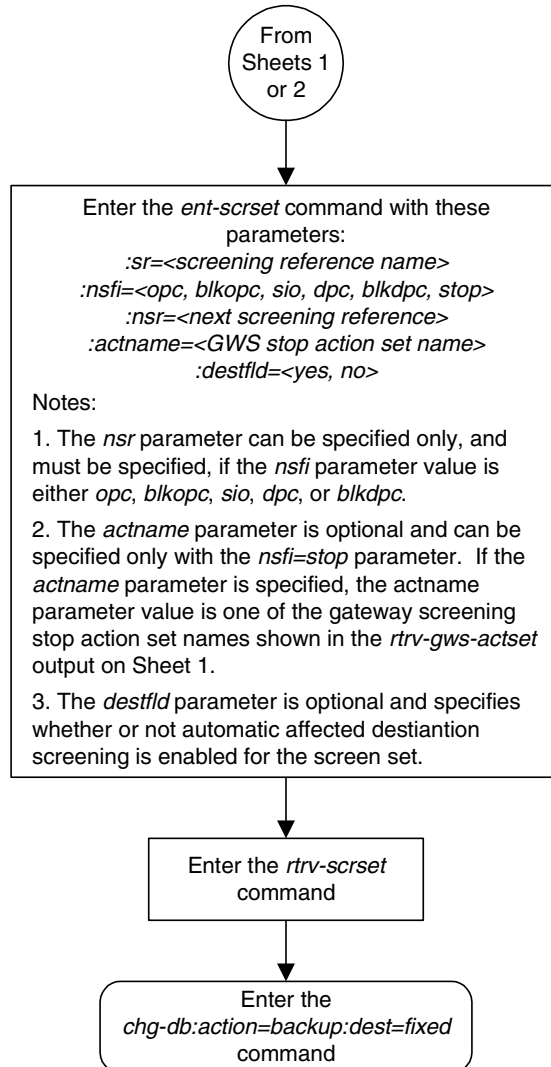

## Removing a Screen Set

This procedure is used to remove a screen set from the database using the `dlt-scrset` command. The parameters used by the `dlt-scrset` command are shown in the “Gateway Screening Attributes” section on page 2-7. The general rules that apply to configuring gateway screening entities are shown in the “Gateway Screening Configuration” section on page 2-28.

The example in this procedure removes the screen set `gws1` from the database.

### Procedure

---

1. Display all screen sets in the database using the `rtrv-scrset` command. The following is an example of the possible output.

```
rlghncxa03w 05-09-25 15:25:30 GMT EAGLE5 34.0.0
ENTIRE GWS DATABASE IS 1% FULL
CDPA + AFTPC TABLES ARE 1% FULL
THERE ARE 242 SCREEN SETS AVAILABLE

THE FOLLOWING ARE OVER 80% FULL:
SCRN  NSFI      NSR/ACT  FULL  RULES  TABLES  DESTFLD

SCRN  NSFI      NSR/ACT  FULL  RULES  TABLES  DESTFLD
fld1  OPC       fld2     1%    5      4        NO
gws1  OPC       gws4     1%    9      7        NO
gws2  BLKOPC    gws5     1%    5      4        NO
isp1  OPC       isp1     1%    6      4        NO
ls01  SIO       ls02     1%    3      3        YES
ss01  OPC       opc1     51%   2075   22       YES
ss02  OPC       opc2     2%    75     22       YES
ss03  OPC       opc3     2%    75     22       YES
ss04  OPC       opc1     51%   2075   22       NO
ss07  OPC       opc1     51%   2075   22       YES
ss09  OPC       opc1     51%   2075   22       NO
ss28  OPC       opc1     51%   2075   22       YES
tup1  OPC       tup1     1%    8      5        NO
wrđ1  DPC       iec      1%    6      5        YES
```

---

2. The screen set to be removed cannot be referenced by a linkset. To verify this, enter the `rtrv-ls` command. If the output shows a reference to the screen set to be removed, go to the “Changing an SS7 Linkset” procedure in the *Database Administration Manual – SS7* or the “Changing an X.25 Linkset” procedure in the *Database Administration Manual – Features* and change the `scrn` parameter to reference another screen set, or to `none` to remove the reference to the screen set.
-

## Screen Set Configuration

3. Remove the screen set from the database using the **dlt-scrset** command. For this example, enter this command.

```
dlt-scrset:scrn=gws1
```

A message similar to the following should appear.

```
rlghncxa03w 05-09-25 15:26:30 GMT EAGLE5 34.0.0  
DLT-SCRSET: SCREEN SET AFFECTED - GWS1 0% FULL  
DLT-SCRSET: MASP A - COMPLTD
```

---

4. Verify the changes using the **rtrv-scrset** command with the screen set name used in step 3. For this example, enter this command.

```
rtrv-scrset:scrn=gws1
```

The following is an example of the possible output.

```
E2573 Cmd Rej: SR or NSR does not reference an existing SR
```

This message shows that the specified screen set name is not in the database and the action of the **dlt-scrset** command in step 3 was successful.

---

5. Backup the new changes using the **chg-db:action=backup:dest=fixed** command. The following messages should appear, the active Maintenance and Administration Subsystem Processor (MASP) appears first.

```
BACKUP (FIXED) : MASP A - Backup starts on active MASP.  
BACKUP (FIXED) : MASP A - Backup on active MASP to fixed disk complete.  
BACKUP (FIXED) : MASP A - Backup starts on standby MASP.  
BACKUP (FIXED) : MASP A - Backup on standby MASP to fixed disk complete.
```

---

Flowchart 13-2. Removing a Screen Set

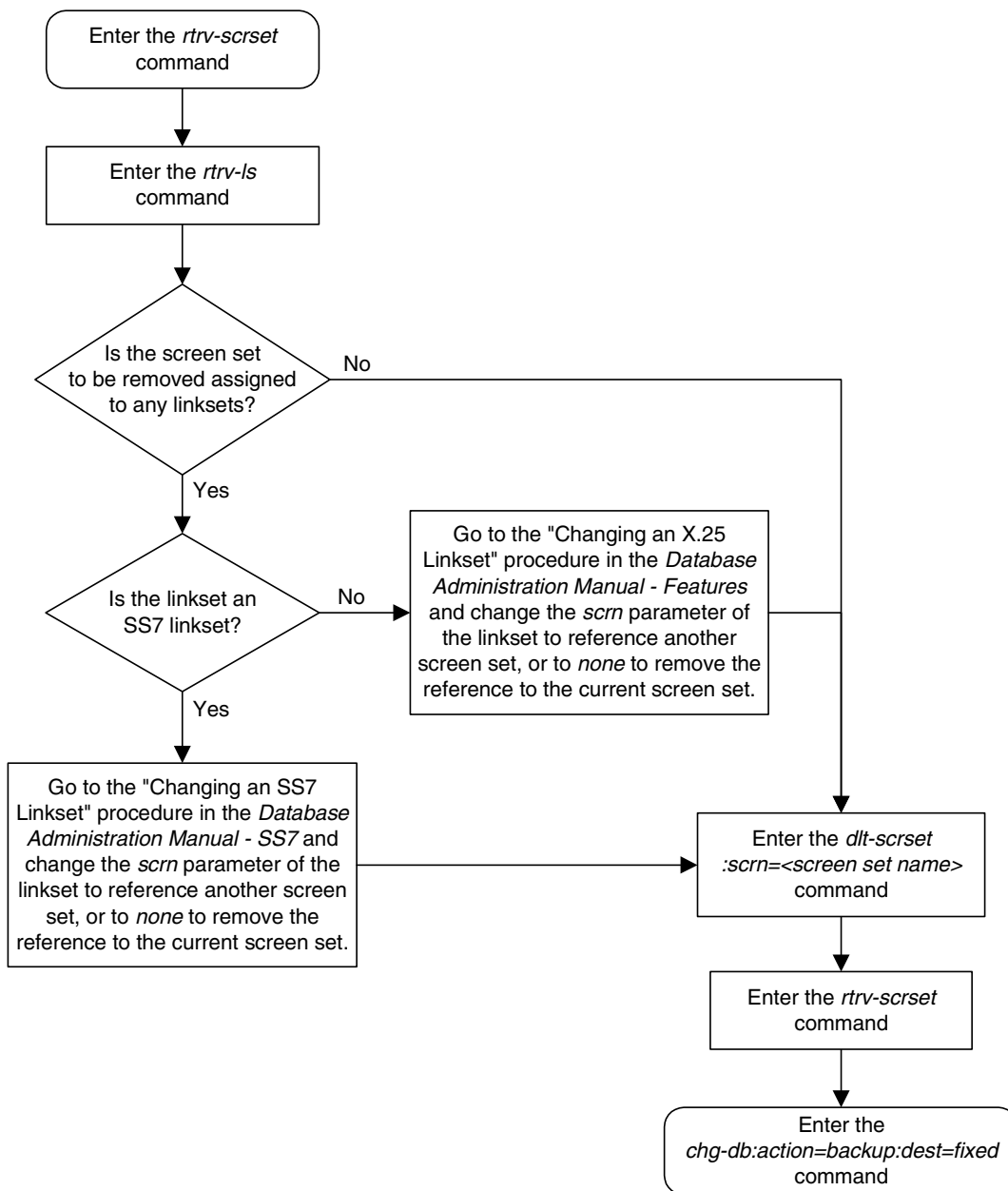



## Changing a Screen Set

This procedure is used to change the attributes of a screen set in the database using the **chg-scrset** command. The parameters used by the **chg-scrset** command are shown in the "Gateway Screening Attributes" section on page 2-7. The general rules that apply to configuring gateway screening entities are shown in the "Gateway Screening Configuration" section on page 2-28.

The example in this procedure is used to change screen set **1s01** to screen set **1s05** with the **nsfi=blkopc** and **nsr=1s08**.

If the screen set name is being changed, the new screen set name cannot already exist in the database.

The screen set can reference one of the following screens.

- Allowed OPC
- Blocked OPC
- Allowed SIO
- Allowed DPC
- Blocked DPC

Enter the following commands to verify that these screens are in the database.

- **rtrv-scr-opc:all=yes**
- **rtrv-scr-blkopc:all=yes**
- **rtrv-scr-sio:all=yes**
- **rtrv-scr-dpc:all=yes**
- **rtrv-scr-blkdpc:all=yes**

If the desired screen is not in the database, go to one of the following procedures and add the desired screen to the database or change an existing screen in the database.

- "Adding an Allowed OPC Screen" procedure on page 12-8
- "Adding a Blocked OPC Screen" procedure on page 11-8
- "Adding an Allowed SIO Screen" procedure on page 10-9
- "Adding an Allowed DPC Screen" procedure on page 9-8
- "Adding a Blocked DPC Screen" procedure on page 8-8
- "Changing an Allowed OPC Screen" procedure on page 12-25
- "Changing a Blocked OPC Screen" procedure on page 11-26
- "Changing an Allowed SIO Screen" procedure on page 10-23
- "Changing an Allowed DPC Screen" procedure on page 9-26
- "Changing a Blocked DPC Screen" procedure on page 8-26

## Procedure

---

1. Display all screen sets in the database using the `rtrv-scrset` command. The following is an example of the possible output.

```
rlghncxa03w 05-09-25 15:25:30 GMT EAGLE5 34.0.0
ENTIRE GWS DATABASE IS 1% FULL
CDPA + AFTPC TABLES ARE 1% FULL
THERE ARE 242 SCREEN SETS AVAILABLE
```

```
THE FOLLOWING ARE OVER 80% FULL:
```

SCRN	NSFI	NSR/ACT	FULL	RULES	TABLES	DESTFLD
SCRN	NSFI	NSR/ACT	FULL	RULES	TABLES	DESTFLD
f1d1	OPC	f1d2	1%	5	4	NO
gws1	OPC	gws4	1%	9	7	NO
gws2	BLKOPC	gws5	1%	5	4	NO
isp1	OPC	isp1	1%	6	4	NO
ls01	SIO	ls02	1%	3	3	YES
ss01	OPC	opc1	51%	2075	22	YES
ss02	OPC	opc2	2%	75	22	YES
ss03	OPC	opc3	2%	75	22	YES
ss04	OPC	opc1	51%	2075	22	NO
ss07	OPC	opc1	51%	2075	22	YES
ss09	OPC	opc1	51%	2075	22	NO
ss28	OPC	opc1	51%	2075	22	YES
tup1	OPC	tup1	1%	8	5	NO
wrd1	DPC	iec	1%	6	5	YES

---

2. The screen set being changed cannot be referenced by a linkset. To verify this, enter the `rtrv-ls` command. If the output shows a reference to the screen set to be removed, go to the “Changing an SS7 Linkset” procedure in the *Database Administration Manual – SS7* or the “Changing an X.25 Linkset” procedure in the *Database Administration Manual – Features* and change the `scrn` parameter to reference another screen set, or to `none` to remove the reference to the screen set.
-

## Screen Set Configuration

**NOTE: If a new gateway screening stop action set will not be assigned to the screen set being changed, skip step 3 and go to step 4.**

3. Display the gateway screening stop action sets in the database with the **rtrv-gws-actset** command. This is an example of the possible output.

```
rlghncxa03w 05-09-25 15:26:30 GMT EAGLE5 34.0.0
ACT ACT ACT ACT ACT ACT ACT ACT ACT ACT ACT ACT
ID NAME 1 2 3 4 5 6 7 8 9 10
-----
1 copy copy
2 rdct rdct
3 cr copy rdct
4 cncf cncf
5 cpcncf copy cncf
6 cncfrd cncf rdct
7 cpcfrd copy cncf rdct
```

GWS action set table is (7 of 16) 44% full

If the required gateway screening stop action set is not in the database, go to the "Configuring Gateway Screening Stop Action Sets" procedure on page 2-54 and configure the required gateway screening stop action set.

---

**NOTE: If the NSFI of the screen set being changed in this procedure will be STOP, or if the NSFI of the screen set is not being changed, skip step 4 and go to step 5.**

4. Enter the commands on page 13-15 to verify that the screen that will be specified by the NSFI/NSR parameter combination in step 5 is in the database.

If the desired screen is not in the database, go to one of the procedures shown on page 13-15 and either add the desired screen to the database or change an existing screen in the database.

- 
5. Change the attributes of a screen set using the **chg-scrset** command.

If a gateway screening stop action is to be assigned to the screen set being changed, enter the **chg-scrset** command with the **nsfi=stop** parameter and the **actname** parameter with the name of a gateway screening stop action set shown in the output of the **rtrv-gws-actset** command executed in step 2.

For this example, enter this command.

```
chg-scrset:scrn=ls01:nscrn=ls05:nsfi=blkopc:nsr=ls08
```

A message similar to the following should appear.

```
rlghncxa03w 05-09-25 15:27:30 GMT EAGLE5 34.0.0
CHG-SCRSET: SCREEN SET AFFECTED - LS01 1% FULL
CHG-SCRSET: MASP A - COMPLTD
```

---

6. Verify the changes using the **rtrv-scrset** command. The following is an example of the possible output.

```
rlghncxa03w 05-09-25 15:28:30 GMT EAGLE5 34.0.0
ENTIRE GWS DATABASE IS 1% FULL
CDPA + AFTPC TABLES ARE 1% FULL
THERE ARE 242 SCREEN SETS AVAILABLE

THE FOLLOWING ARE OVER 80% FULL:
SCRN  NSFI      NSR/ACT  FULL  RULES  TABLES  DESTFLD

SCRN  NSFI      NSR/ACT  FULL  RULES  TABLES  DESTFLD
fld1  OPC       fld2     1%    5      4        NO
gws1  OPC       gws4     1%    9      7        NO
gws2  BLKOPC   gws5     1%    5      4        NO
isp1  OPC       isp1     1%    6      4        NO
ls05  BLKOPC   ls08     3%    45     14       YES
ss01  OPC       opc1     51%   2075   22       YES
ss02  OPC       opc2     2%    75     22       YES
ss03  OPC       opc3     2%    75     22       YES
ss04  OPC       opc1     51%   2075   22       NO
ss07  OPC       opc1     51%   2075   22       YES
ss09  OPC       opc1     51%   2075   22       NO
ss28  OPC       opc1     51%   2075   22       YES
tup1  OPC       tup1     1%    8      5        NO
wrđ1  DPC       iec      1%    6      5        YES
```

---

7. Backup the new changes using the **chg-db:action=backup:dest=fixed** command. The following messages should appear, the active Maintenance and Administration Subsystem Processor (MASP) appears first.

```
BACKUP (FIXED) : MASP A - Backup starts on active MASP.
BACKUP (FIXED) : MASP A - Backup on active MASP to fixed disk complete.
BACKUP (FIXED) : MASP A - Backup starts on standby MASP.
BACKUP (FIXED) : MASP A - Backup on standby MASP to fixed disk complete.
```

---

# Screen Set Configuration

## Flowchart 13-3. Changing a Screen Set (Sheet 1 of 3)

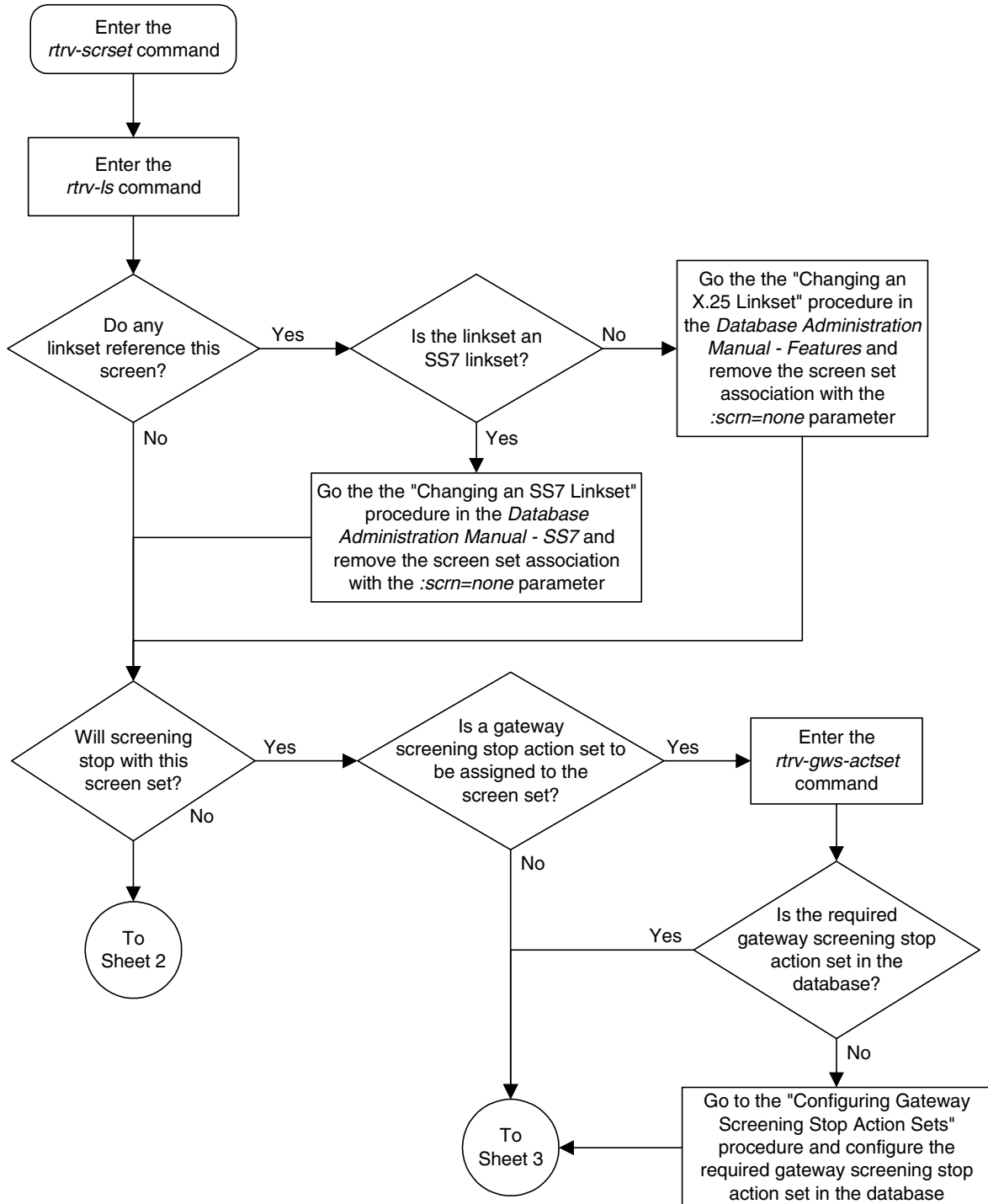

Flowchart 13-3. Changing a Screen Set (Sheet 2 of 3)

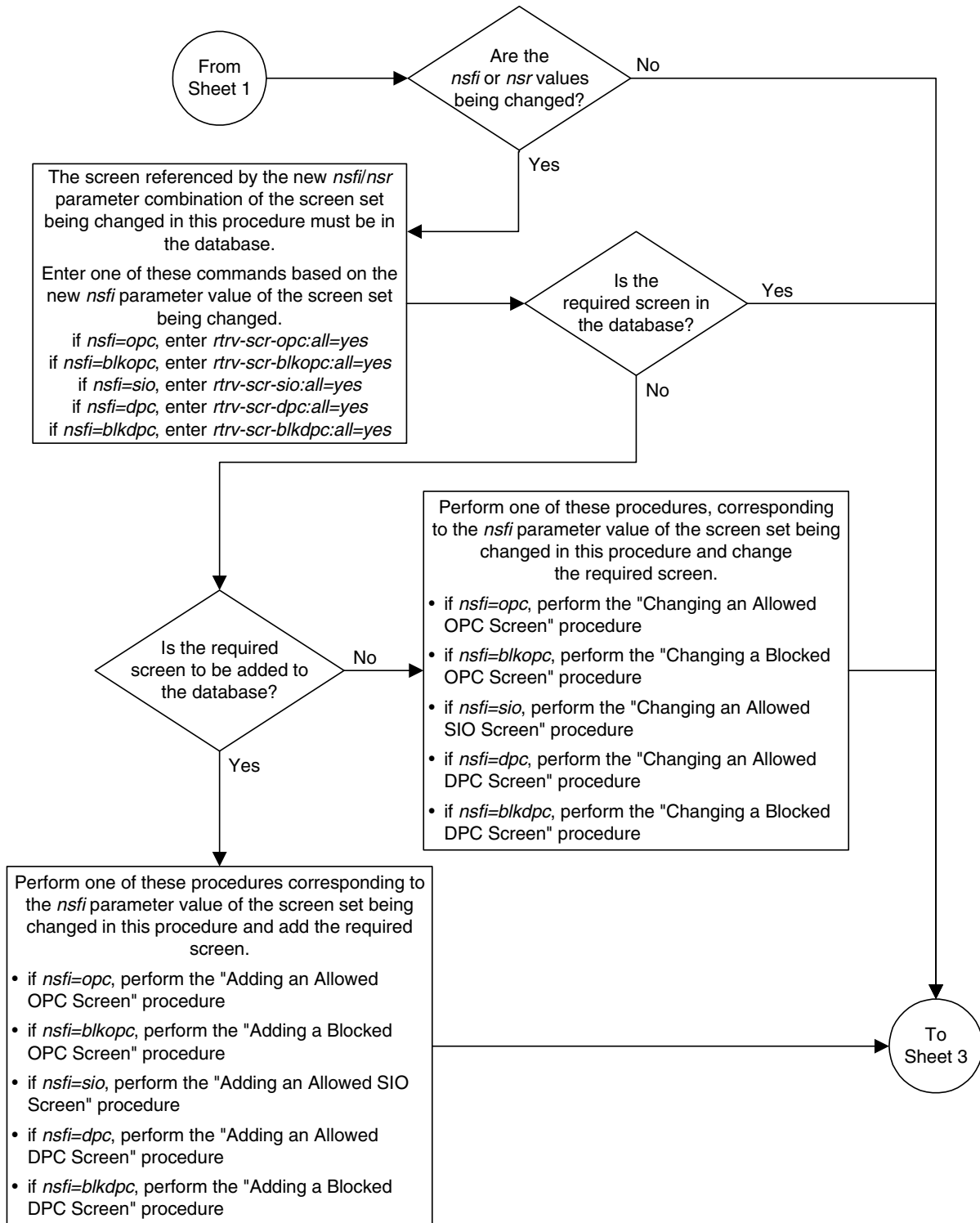

# Screen Set Configuration

Flowchart 13-3. Changing a Screen Set (Sheet 3 of 3)

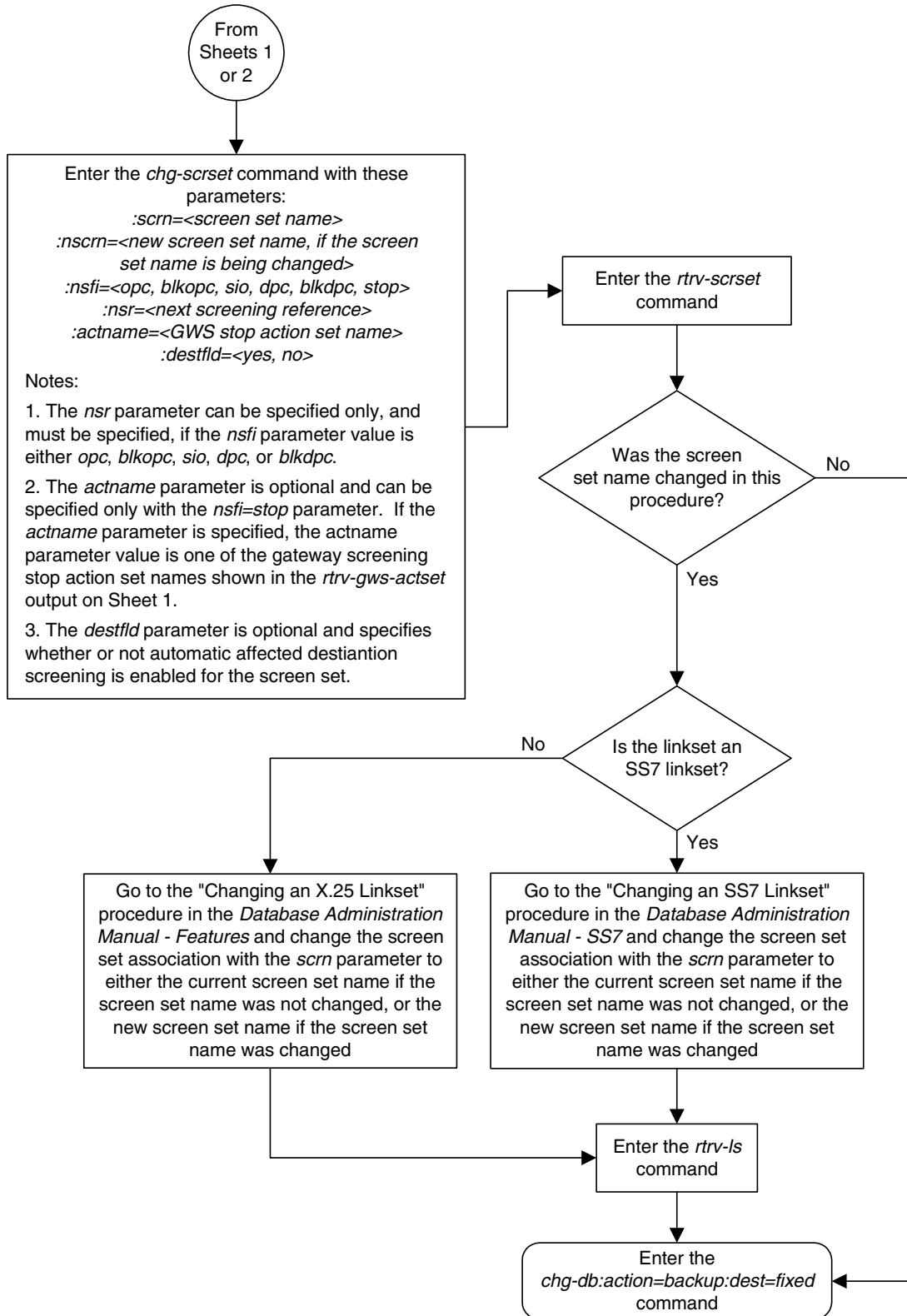





## Calling Name Conversion Facility (CNCF) Configuration

Introduction.....	14-2
Configuring the EAGLE 5 SAS for the CNCF Feature.....	14-4

## Introduction

This feature provides a conversion of ISUP IAM messages using two versions of calling name identification presentation (CNIP) for calling name information delivery. One version of the CNIP uses the non-standard proprietary ISUP party information (PIP) parameter. The other version uses the ANSI standard ISUP generic name (GN) parameter. The conversion will either replace the PIP parameter with the GN parameter or the GN parameter with the PIP parameter in the ISUP IAM message.

The gateway screening feature is used to select the ISUP messages that are converted. The incoming messages are selected based on the OPC and DPC in the routing label of the message, and the message type in the service information octet. The message type is defined by the value of the service indicator (SI) field of the SIO. ISUP messages contain the value 5 in the service indicator field of the SIO. Screening rules for Allowed OPC, Allowed DPC, and the Allowed SIO entities must be configured in the database for this feature.

This feature is an optional feature and must be turned on with the `chg-feat` command and the `cncf=on` parameter. The `rtrv-feat` command can be used to verify if this feature is on or not. This feature applies to only ANSI networks.

Figure 14-1 shows an example network which contains these two separate ISUP versions. Based on this example, Table 14-1 shows when the ISUP IAM message conversion by the CNCF feature occurs.

**Figure 14-1.** PIP/GN Parameter Conversion

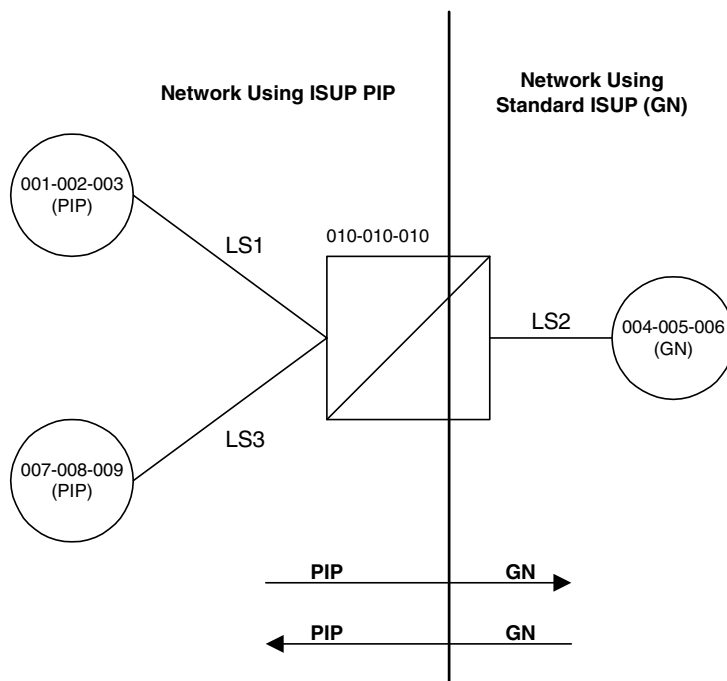

## Calling Name Conversion Facility (CNCF) Configuration

**Table 14-1.** ISUP IAM Message Conversion Examples

Origination Point Code	Destination Point Code	ISUP IAM Message Conversion
001-002-003	004-005-006	Yes
001-002-003	007-008-009	No
004-005-006	001-002-003	Yes
004-005-006	007-008-009	Yes
007-008-009	001-002-003	No
007-008-009	004-005-006	Yes

Great care must be taken when configuring the gateway screening rules for this feature. The CNCF feature has no way to validate the gateway screening rules to detect errors in converting messages between compatible networks. For example, using the example network in Figure 14-1, the ISUP IAM message traffic from node 001-002-003 to node 007-008-009 does not need to be converted because they are using the same calling name delivery parameter, PIP. If the gateway screening rules are not carefully configured, these messages could be converted when they do not need to be.

No measurements are collected showing the number of MSUs converted by this feature.

If both the **COPY** and **CNCF** gateway screening stop actions are specified as the stop actions for the gateway screening process, the MSU is converted by the CNCF feature, then copied for the STP LAN feature.

If both the **RDCT** and **CNCF** gateway screening stop actions are specified as the stop actions for the gateway screening process, the MSU is converted by the CNCF feature, then redirected for the DTA feature.

If there are multiple PIP parameters or GN parameters with calling name information within a single ISUP IAM, only the first occurrence of the parameter in the ISUP IAM message is converted.

Messages on X.25 linksets cannot be converted with the CNCF feature.

Only GN IAM messages containing calling name information (Type of Name = Calling Name, Presentation = Allowed, Parameter Length >1) are converted to PIP IAM messages.

Only PIP IAM messages containing Calling Name Information (Sub-Parameter Code = Name Information, Name Element Indicator = Calling Party) are converted to GN IAM messages.

If the received IAM message contains both a GN and a PIP parameter with calling name information, the GN parameter is retransmitted and the PIP parameter is deleted.

Any MSU that is not converted is simply retransmitted. These MSUs include non-ISUP MSUs, non-IAM MSUs, and any IAM MSU received that doesn't contain either a GN or PIP parameter.

If the PIP parameter contains other information in addition to the calling party name information, only a GN parameter containing calling party name information is generated.

The linkset being screened for this feature should not contain C links (**lst=c** parameter of the **ent-1s** and **chg-1s** commands). This would result in the double conversion of the ISUP IAM messages.

### Configuring the EAGLE 5 SAS for the CNCF Feature

To configure the EAGLE 5 SAS for the CNCF feature, gateway screening rules for Allowed OPC, Allowed DPC, and the Allowed SIO entities must be configured in the database for this feature. The last entity in the screening process (**nsfi=stop**) must have a gateway screening stop action set containing the **CNCF** gateway screening stop action.

The allowed OPC screening rules must contain the OPCs that the ISUP IAM messages are being sent from.

The allowed DPC screening rules must contain the DPCs that the ISUP IAM messages are being sent to.

The allowed SIO screening rules must contain the ISUP message type, defined by the **si=5** parameter.

The CNCF feature must be turned on. Before the CNCF feature can be turned on, the gateway screening feature must be on. This can be verified with the **rtrv-feat** command.

The examples in this procedure are based on Figures 14-1, 14-2, 14-3, 14-4, 14-5 and Tables 14-1, 14-2, 14-3, 14-4, 14-5, and 14-6.

## Calling Name Conversion Facility (CNCF) Configuration

Figure 14-2. CNCF Gateway Screening Configuration - Example 1

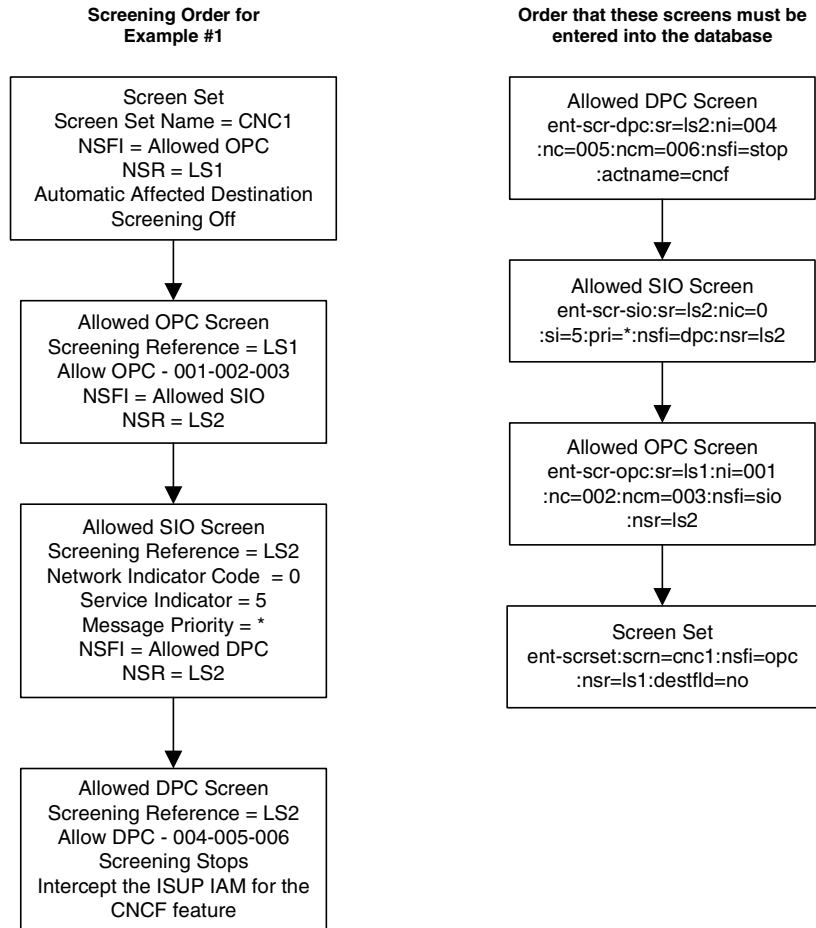
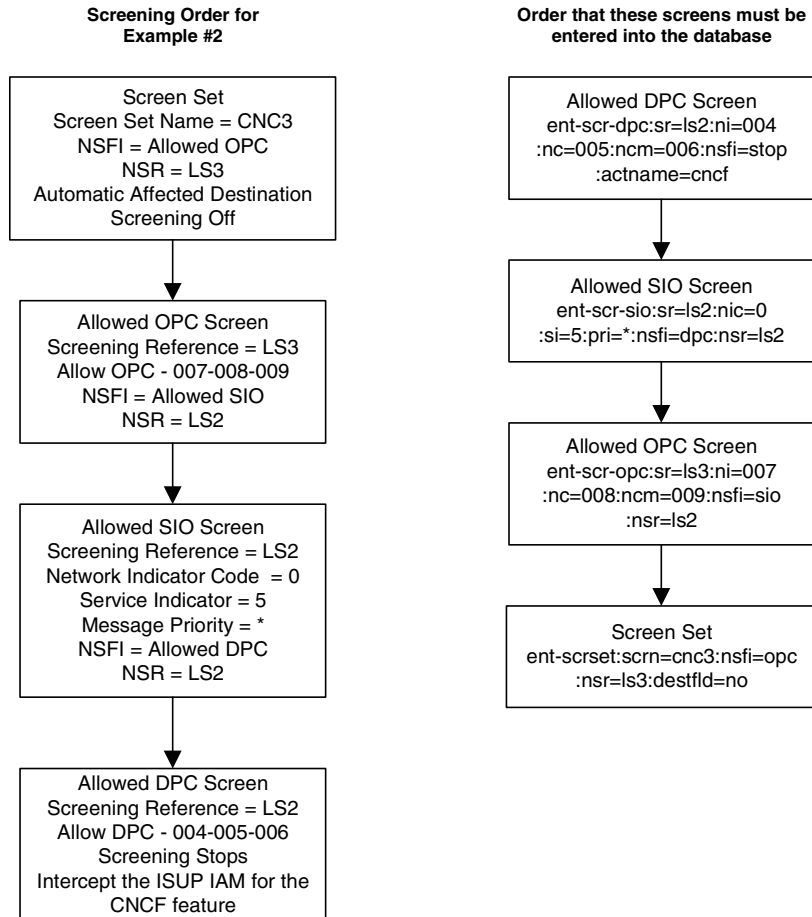

Figure 14-3. CNCF Gateway Screening Configuration - Example 2



# Calling Name Conversion Facility (CNCF) Configuration

**Figure 14-4.** CNCF Gateway Screening Configuration - Example 3

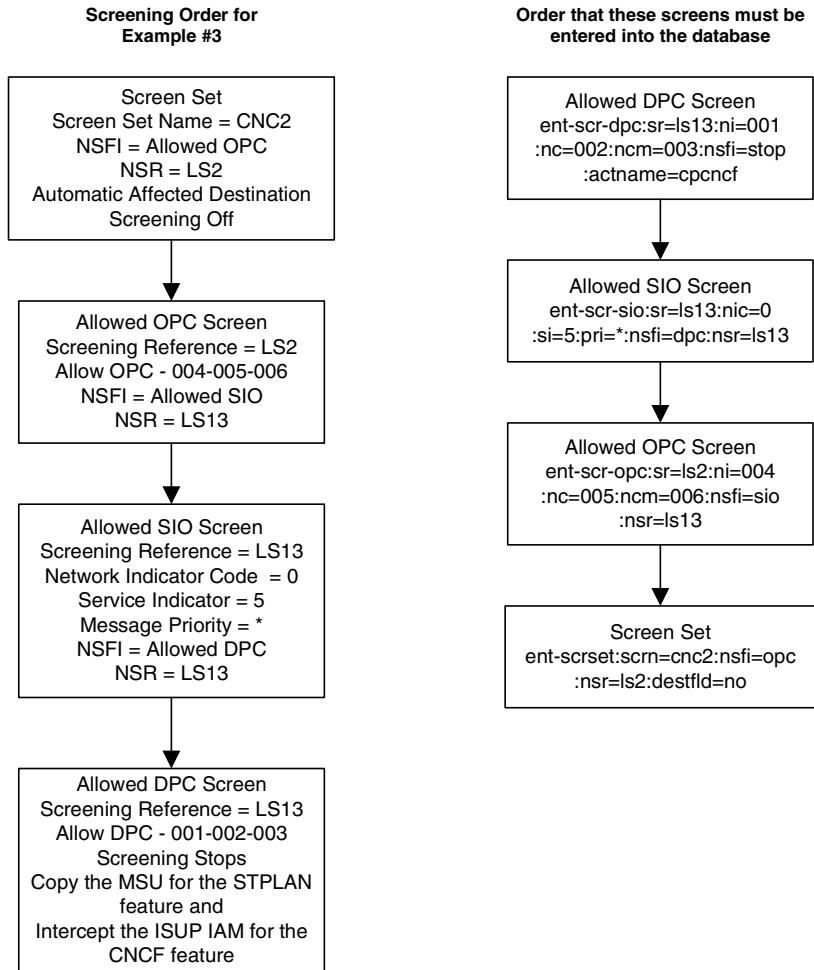
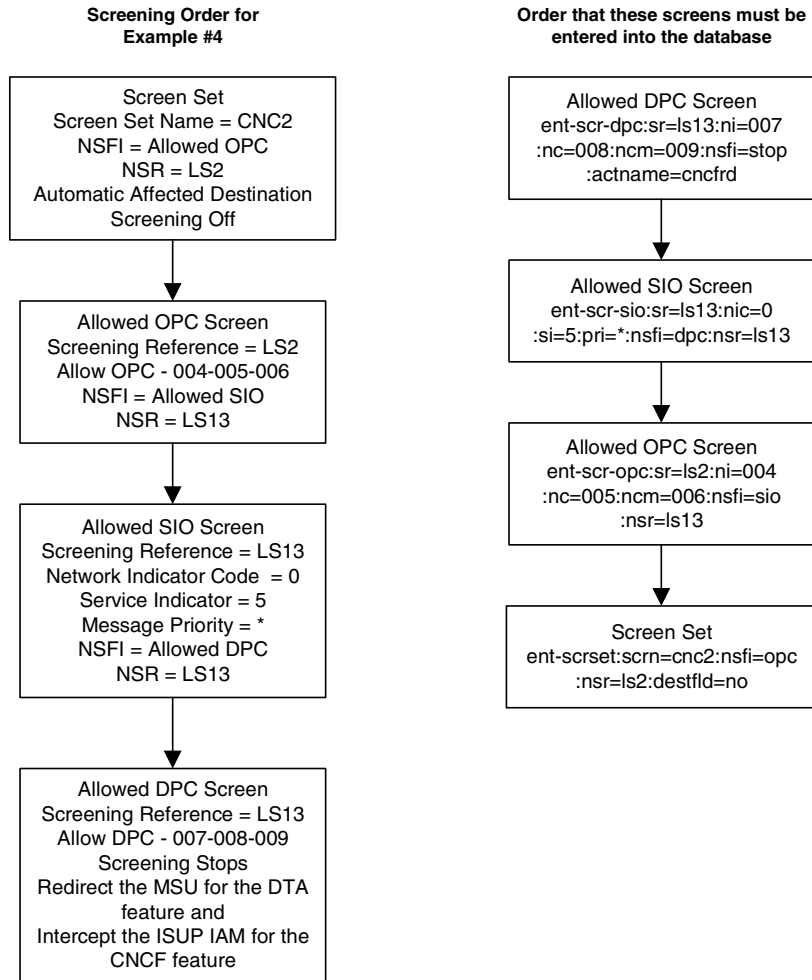

Figure 14-5. CNCF Gateway Screening Configuration - Example 4





### Canceling the RTRV-LS Command

Because the `rtrv-ls` command used in this procedure can output information for a long period of time, the `rtrv-ls` command can be canceled and the output to the terminal stopped. There are three ways that the `rtrv-ls` command can be canceled.

- Press the **F9** function key on the keyboard at the terminal where the `rtrv-ls` command was entered.
- Enter the `canc-cmd` without the `trm` parameter at the terminal where the `rtrv-ls` command was entered.
- Enter the `canc-cmd:trm=<xx>`, where `<xx>` is the terminal where the `rtrv-ls` command was entered, from another terminal other than the terminal where the `rtrv-ls` command was entered. To enter the `canc-cmd:trm=<xx>` command, the terminal must allow Security Administration commands to be entered from it and the user must be allowed to enter Security Administration commands. The terminal's permissions can be verified with the `rtrv-secu-trm` command. The user's permissions can be verified with the `rtrv-user` or `rtrv-secu-user` commands.

For more information about the `canc-cmd` command, go to the *Commands Manual*.

### Procedure

---

1. Verify that the gateway screening and the calling name conversion facility features are on, by entering the `rtrv-feat` command. If the gateway screening feature is on, the `GWS` field should be set to `on`. If the calling name conversion facility feature is on, the `CNCF` field should be set to `on`. For this example, the gateway screening and the calling name conversion facility features are off.

**NOTE:** The `rtrv-feat` command output contains other fields that are not used by this procedure. If you wish to see all the fields displayed by the `rtrv-feat` command, see the `rtrv-feat` command description in the *Commands Manual*.

If both features are on, go to step 4. If the gateway screening feature is on, but the calling name conversion facility feature is off, go to step 3. If the gateway screening feature is off, go to step 2.

---

- If the gateway screening feature is not on, shown by the `GWS = off` entry in the `rtrv-feat` command output in step 1, turn the gateway screening feature on by entering this command.

```
chg-feat:gws=on
```

**NOTE:** Once the gateway screening feature is turned on with the `chg-feat` command, it cannot be turned off.

When the `chg-feat` has successfully completed, this message should appear.

```
rlghncxa03w 05-09-25 15:26:30 GMT EAGLE5 34.0.0
CHG-FEAT: MASP A - COMPLTD
```

---

- If the calling name conversion facility feature is not on, shown by the `CNCF = off` entry in the `rtrv-feat` command output in step 1, turn the calling name conversion facility feature on by entering this command.

```
chg-feat:cncf=on
```

**NOTE:** Once the calling name conversion facility feature is turned on with the `chg-feat` command, it cannot be turned off.

When the `chg-feat` has successfully completed, this message should appear.

```
rlghncxa03w 05-09-25 15:27:30 GMT EAGLE5 34.0.0
CHG-FEAT: MASP A - COMPLTD
```

---

- Display the gateway screening stop action sets in the database with the `rtrv-gws-actset` command. This is an example of the possible output.

```
rlghncxa03w 05-09-25 15:28:30 GMT EAGLE5 34.0.0
ACT  ACT  ACT  ACT  ACT  ACT  ACT  ACT  ACT  ACT  ACT  ACT
ID   NAME  1    2    3    4    5    6    7    8    9    10
--   ----  -    -    -    -    -    -    -    -    -    -
1    copy  copy
2    rdct  rdct
3    cr    copy rdct
4    cncf  cncf
5    cpcncf copy cncf
6    cncfrd cncf rdct
7    cpcfird copy cncf rdct
```

GWS action set table is (7 of 16) 44% full

If the `cncf` gateway screening stop action is not shown in the `rtrv-gws-actset` command output, go to the “Configuring Gateway Screening Stop Action Sets” procedure on page 2-54 and either create a new gateway screening stop action set containing the `cncf` gateway screening stop action, or change an existing gateway screening stop action set to contain the `cncf` gateway screening stop action.

---

## Calling Name Conversion Facility (CNCF) Configuration

5. Display all allowed DPC screens in the database using the `rtrv-scr-dpc` command. The following is an example of the possible output.

```
rlghncxa03w 05-09-25 15:29:30 GMT EAGLE5 34.0.0
SCREEN = ALLOWED DPC
SR   REF  RULES
IEC  YES   2
WRD2 YES   1
WRD4 YES   9
```

If the necessary screening reference name is shown in the `rtrv-scr-dpc` command output, make sure the screening data you wish to enter is not already in the database by entering the `rtrv-scr-dpc` command with the screening reference name. For example, enter the `rtrv-scr-dpc:sr=iec` command.

The following is an example of the possible output.

```
rlghncxa03w 05-09-25 15:30:30 GMT EAGLE5 34.0.0
SCREEN = ALLOWED DPC
SR   NI      NC      NCM      NSFI      NSR/ACT
IEC  240      001      010      STOP      -----
IEC  241      010      *        CGPA      cg04

SR   NPC
IEC  00235
IEC  00240

SR   NPC      NSFI      NSR/ACT
IEC  00235      CGPA      cg04
IEC  00240      CGPA      cg01

SR   ZONE  AREA  ID      NSFI      NSR/ACT
IEC  1      003   4      BLKDPC  blk1
IEC  1      003   5      STOP    -----
```

6. If the required screen is not in the database, go to the “Adding an Allowed DPC Screen” procedure on page 9-8 and add the required allowed DPC screen. For this example, enter the screening information in Table 14-2.

**Table 14-2.** Example Gateway Screening Allowed DPC Configuration Table for the CNCF Feature

Screening Reference	NI	NC	NCM	NSFI	ACTNAME*
ls2	004	005	006	Stop	CNCF
ls13	001	002	003	Stop	CPCNCF
ls13	007	008	009	Stop	CNCFRD

\* The value of the `actname` parameter is shown in the `rtrv-gws-actset` command output example shown in step 4.

If you wish to change an existing allowed DPC screen, instead of adding a new allowed DPC screen, go to “Changing an Allowed DPC Screen” procedure on page 9-26 and change an existing allowed DPC screen. For this example, change the screens with the screening information in Table 14-2.

7. Display all allowed SIO screens in the database using the `rtrv-scr-sio` command. The following is an example of the possible output.

```
rlghncxa03w 05-09-25 15:31:30 GMT EAGLE5 34.0.0
SCREEN = ALLOWED SIO
SR    REF  RULES
IEC   YES   2
WRD2  YES   1
WRD4  YES   9
```

If the necessary screening reference name is shown in the `rtrv-scr-sio` command output, make sure the screening data you wish to enter is not already in the database by entering the `rtrv-scr-sio` command with the screening reference name. For example, enter the `rtrv-scr-sio:sr=iec` command.

The following is an example of the possible output.

```
rlghncxa03w 05-09-25 15:32:30 GMT EAGLE5 34.0.0
SCREEN = ALLOWED SIO
SR  NIC  PRI  SI  H0    H1    NSFI  NSR/ACT
IEC  2    0&&3  0    0      0     BLKDPC WDB2
IEC  2    0&&2  0    1      1     DPC    WDB3
IEC  2    0&&1  0    2      2     STOP   -----
IEC  2    0&&3  4    --    --     STOP   -----
IEC  2    0&&2  1    *     *     DPC    WDB3
```

8. If the required screen is not in the database, go to the “Adding an Allowed SIO Screen” procedure on page 10-9 and add the required allowed SIO screen. For this example, enter the screening information in Table 14-3.

**Table 14-3.** Example Gateway Screening Allowed SIO Configuration Table for the CNCF Feature

Screening Reference	NIC	SI	H0	H1	PRI	NSFI	NSR
ls2	0	5	--	--	*	dpc	ls2
ls13	0	5	--	--	*	dpc	ls13

If you wish to change an existing allowed SIO screen, instead of adding a new allowed SIO screen, go to “Changing an Allowed SIO Screen” procedure on page 10-23 and change an existing allowed SIO screen. For this example, change the screens with the screening information in Table 14-3.

## Calling Name Conversion Facility (CNCF) Configuration

9. Display all allowed OPC screens in the database using the `rtrv-scr-opc` command. The following is an example of the possible output.

```
rlghncxa03w 05-09-25 15:33:30 GMT EAGLE5 34.0.0
SCREEN = ALLOWED OPC
SR   REF  RULES
IEC  YES   2
WRD2 YES   1
WRD4 YES   9
```

If the necessary screening reference name is shown in the `rtrv-scr-opc` command output, make sure the screening data you wish to enter is not already in the database by entering the `rtrv-scr-opc` command with the screening reference name. For example, enter the `rtrv-scr-opc:sr=iec` command.

The following is an example of the possible output.

```
rlghncxa03w 05-09-25 15:34:30 GMT EAGLE5 34.0.0
SCREEN = ALLOWED OPC
SR   NI      NC      NCM      NSFI      NSR/ACT
IEC  240     001     010     STOP     -----
IEC  241     010     *       CGPA     cg04

SR   NPC
IEC  00235
IEC  00240

SR   NI      NC      NCM      NSFI      NSR/ACT
IEC  1       003     4       BLKOPC   blk1
IEC  1       003     5       STOP     -----
```

10. If the required screen is not in the database, go to the “Adding an Allowed OPC Screen” procedure on page 12-8 and add the required allowed OPC screen. For this example, enter the screening information in Table 14-4.

**Table 14-4.** Example Gateway Screening Allowed OPC Configuration Table for the CNCF Feature

Screening Reference	NI	NC	NCM	NSFI	NSR
ls1	001	002	003	sio	ls2
ls2	004	005	006	sio	ls13
ls3	007	008	009	sio	ls2

If you wish to change an existing allowed OPC screen, instead of adding a new allowed OPC screen, go to “Changing an Allowed OPC Screen” procedure on page 12-25 and change an existing allowed OPC screen. For this example, change the screens with the screening information in Table 14-4.

11. Display all the screen sets in the database using the `rtrv-scrset` command. The following is an example of the possible output.

```
rlghncxa03w 05-09-25 15:35:30 GMT EAGLE5 34.0.0
ENTIRE GWS DATABASE IS 1% FULL
CDPA + AFTPC TABLES ARE 1% FULL
THERE ARE 248 SCREEN SETS AVAILABLE

THE FOLLOWING ARE OVER 80% FULL:
SCRN  NSFI    NSR/ACT  FULL  RULES  TABLES  DESTFLD

SCRN  NSFI    NSR/ACT  FULL  RULES  TABLES  DESTFLD
ss01  OPC     opc1     51%   2075   22       YES
ss02  OPC     opc2      2%    75     22       YES
ss03  OPC     opc3      2%    75     22       YES
ss04  OPC     opc1     51%   2075   22       NO
ss07  OPC     opc1     51%   2075   22       YES
ss09  OPC     opc1     51%   2075   22       NO
ss28  OPC     opc1     51%   2075   22       YES
```

12. If the required screen set is not in the database, go to the “Adding a Screen Set” procedure on page 13-3 and add the required screen set. For this example, enter the screening information in Table 14-5.

**Table 14-5.** Example Gateway Screening Screen Set Configuration Table for the CNCF Feature

Screen Set Name	Next Screening Function Identifier	Next Screening Reference	DESTFLD
cnc1	opc	ls1	No
cnc2	opc	ls2	No
cnc3	opc	ls3	No

If you wish to change an existing screen set, instead of adding a new screen set, go to “Changing a Screen Set” procedure on page 13-15 and change an existing screen set. For this example, change the screen sets with the screening information in Table 14-5.

## Calling Name Conversion Facility (CNCF) Configuration

13. Display the current linkset configuration using the `rtrv-ls` command. This is an example of the possible output.

```

rlghncxa03w 05-09-25 15:36:30 GMT EAGLE5 34.0.0

                L3T SLT                      GWS GWS GWS
LSN            APCA  (SS7)  SCRN  SET SET BEI LST LNKS ACT MES DIS SLSCI NIS
lsa1           240-020-000  scr1  1  1  yes A  1  off off off no  off
lsa2           240-030-000  scr2  1  2  no  C  3  on  on  on yes  off
lsa3           240-040-000  scr3  1  3  yes C  5  off off off yes  off

                L3T SLT                      GWS GWS GWS
LSN            APCA  (X25) SCRN  SET SET BEI LST LNKS ACT MES DIS SLSCI NIS
ls6            244-010-004  scr4  1  4  no  A  6  off off off ---  off
ls7            244-012-005  scr5  1  5  no  C  3  on  on  on ---  off
ls8            244-012-006  scr6  1  6  no  C  8  off off off ---  off

                L3T SLT                      GWS GWS GWS
LSN            APCI  (SS7)  SCRN  SET SET BEI LST LNKS ACT MES DIS SLSCI NIS
lsi1           1-111-1     scr1  1  1  yes A  1  off off off ---  ---
lsi2           1-111-2     scr2  1  2  no  C  3  on  on  on ---  ---
lsi3           1-111-3     scr3  1  3  yes C  5  off off off ---  ---

                L3T SLT                      GWS GWS GWS
LSN            APCN  (SS7)  SCRN  SET SET BEI LST LNKS ACT MES DIS SLSCI NIS
lsn1           11111       scr1  1  1  yes A  1  off off off ---  off
lsn2           11112       scr2  1  2  no  C  3  on  on  on ---  off
lsn3           11113       scr3  1  3  yes C  5  off off off ---  off

                L3T SLT                      GWS GWS GWS
LSN            APCN24 (SS7) SCRN  SET SET BEI LST LNKS ACT MES DIS SLSCI NIS

                L3T SLT                      GWS GWS GWS
LSN (CHINA)    APCN  (SS7)  SCRN  SET SET BEI LST LNKS ACT MES DIS SLSCI NIS

                L3T SLT                      GWS GWS GWS
LSN (CHINA)    APCN24 (SS7) SCRN  SET SET BEI LST LNKS ACT MES DIS SLSCI NIS

Link set table is ( 12 of 1024) 1% full

```

14. If the required linkset is not in the database, go to the “Adding an SS7 Linkset” in the *Database Administration Manual – SS7* and add the required linkset. For this example, enter the linkset information in Table 14-6.

**Table 14-6.** Linkset Configuration Table for the CNCF Feature

Linkset Name	Linkset APC	# LINKS	LST	GWSA	GWSM	SCRN
ls1	001-002-003	2	B	on	off	cnc1
ls2	004-005-006	2	B	on	off	cnc2
ls3	007-008-009	2	B	on	off	cnc3

If you wish to change an existing linkset, instead of adding a new linkset, go to “Changing an SS7 Linkset” procedure in the *Database Administration Manual – SS7* and change an existing linkset. For this example, change the linksets with the information in Table 14-6.

15. Backup the new changes using the `chg-db:action=backup:dest=fixed` command. The following messages should appear, the active Maintenance and Administration Subsystem Processor (MASP) appears first.

```

BACKUP (FIXED) : MASP A - Backup starts on active MASP.
BACKUP (FIXED) : MASP A - Backup on active MASP to fixed disk complete.
BACKUP (FIXED) : MASP A - Backup starts on standby MASP.
BACKUP (FIXED) : MASP A - Backup on standby MASP to fixed disk complete.
    
```

---

**Flowchart 14-1.** Calling Name Conversion Facility Configuration (Sheet 1 of 4)

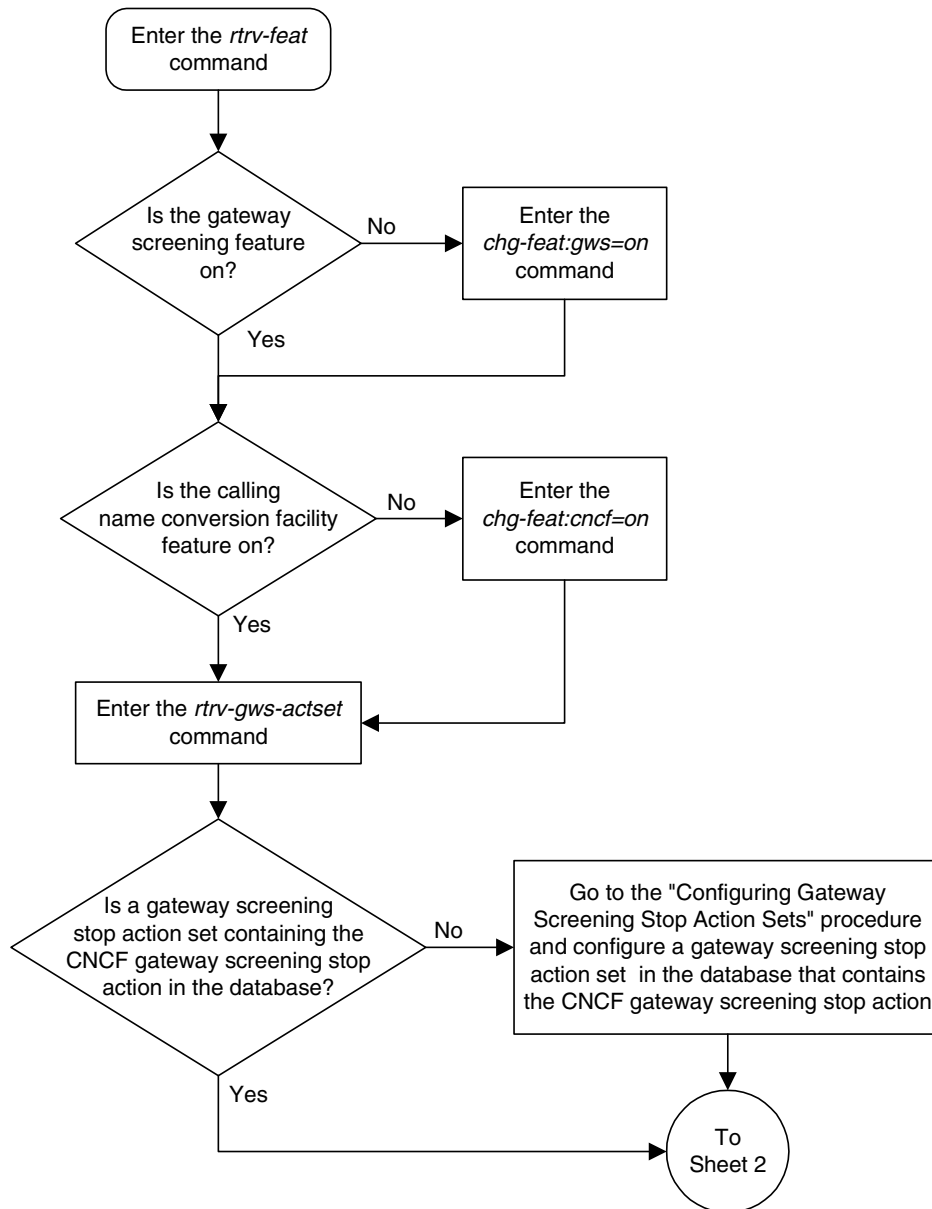



# Calling Name Conversion Facility (CNCF) Configuration

## Flowchart 14-1. Calling Name Conversion Facility Configuration (Sheet 2 of 4)

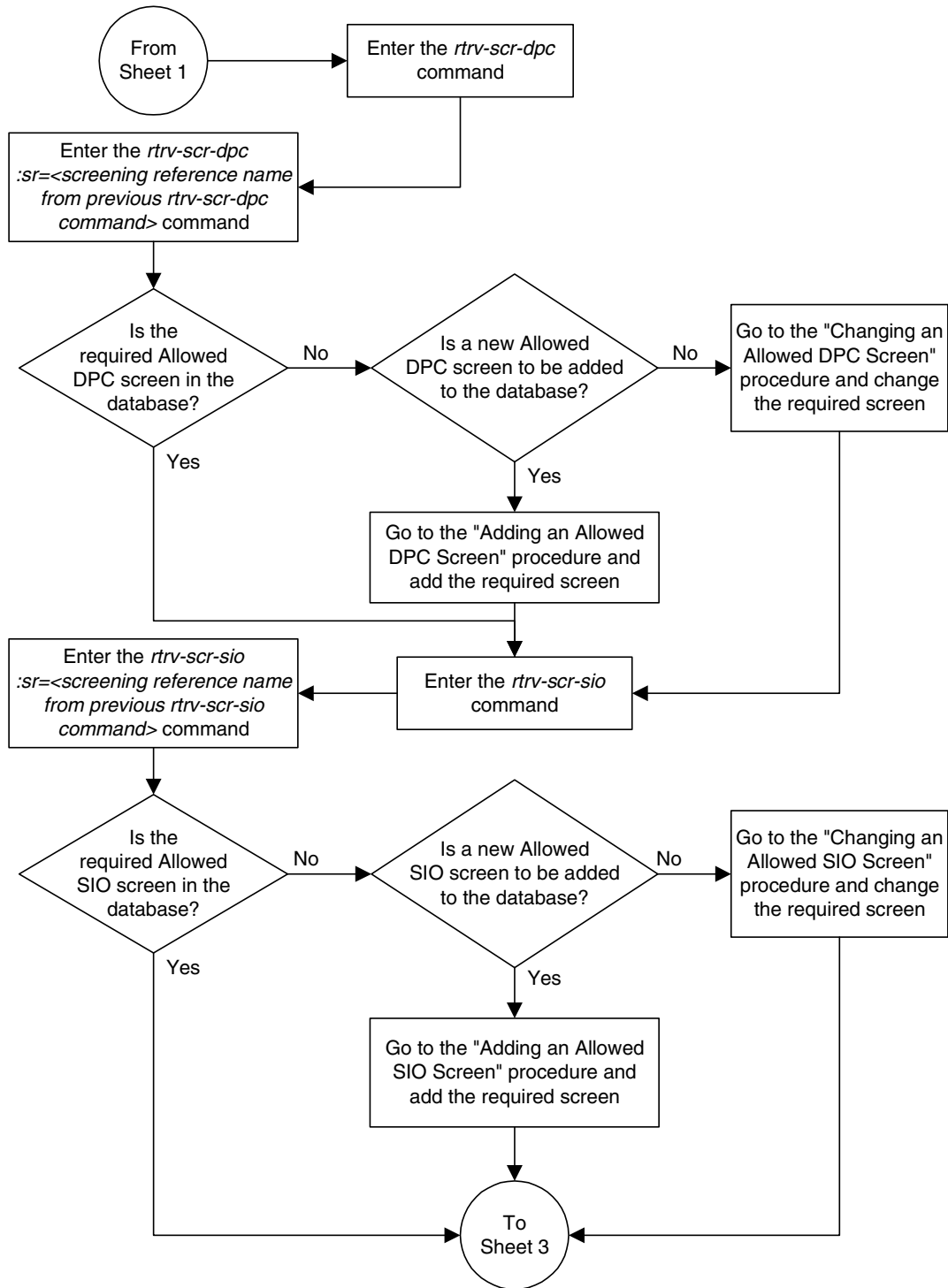

Flowchart 14-1. Calling Name Conversion Facility Configuration (Sheet 3 of 4)

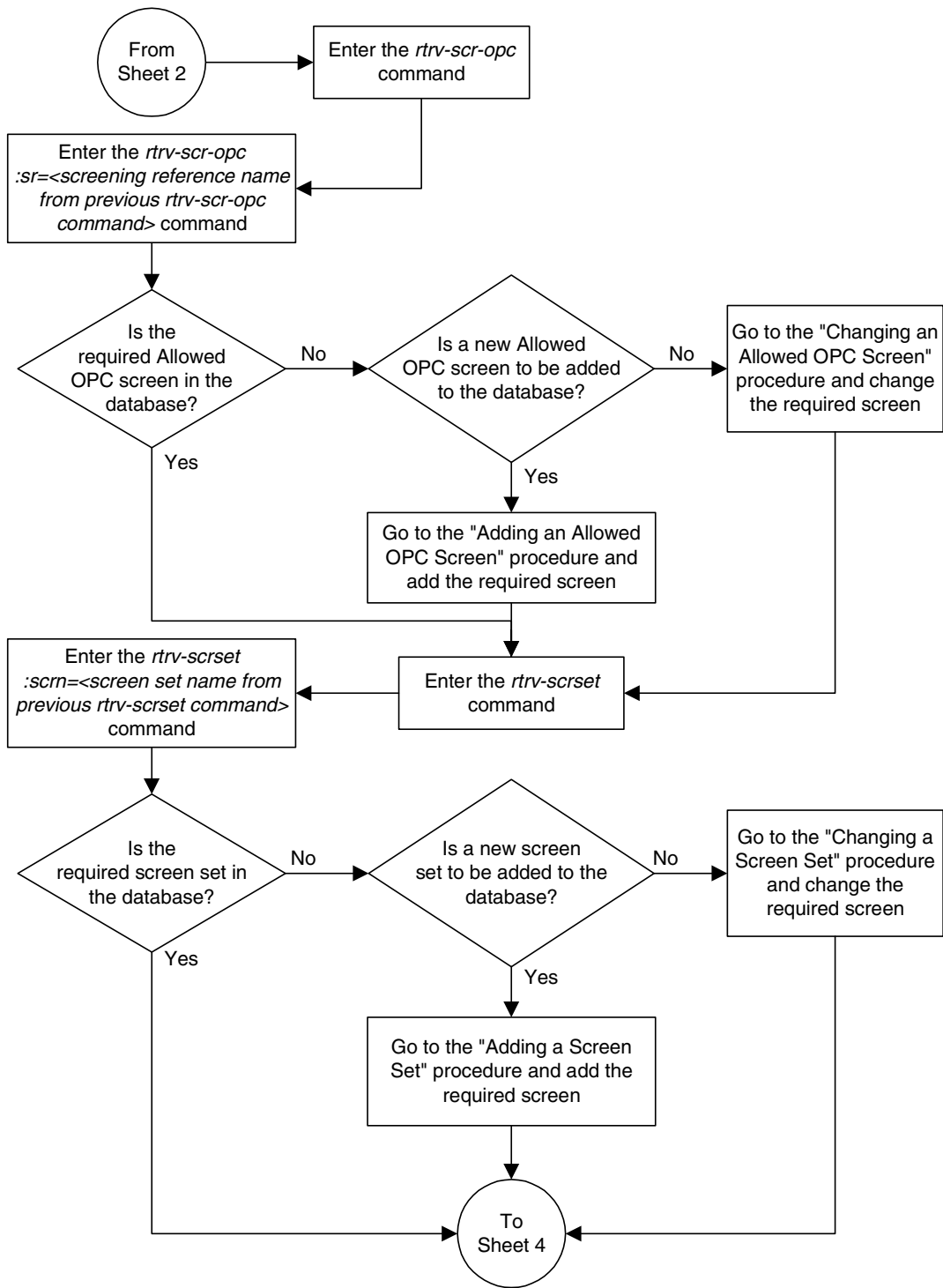

# Calling Name Conversion Facility (CNCF) Configuration

Flowchart 14-1. Calling Name Conversion Facility Configuration (Sheet 4 of 4)

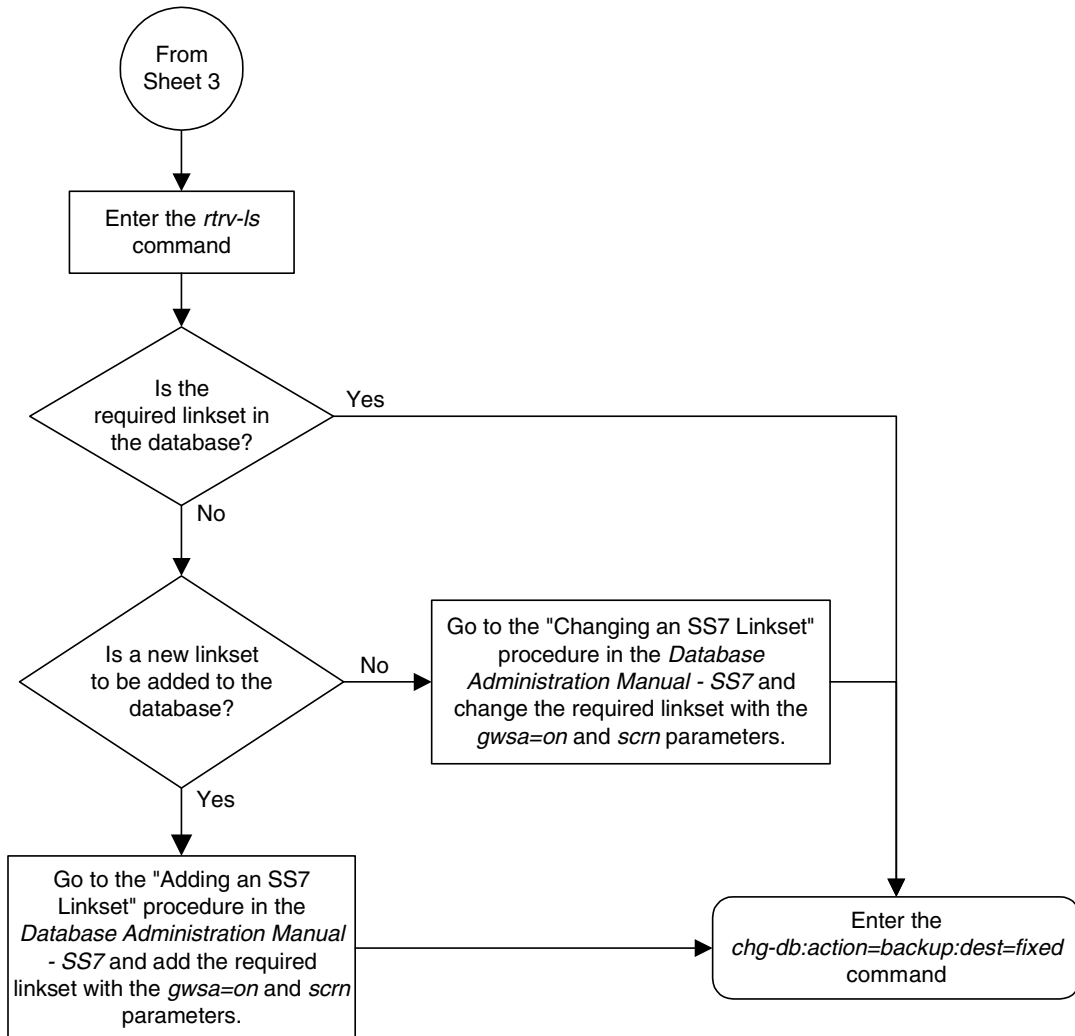

## Calling Name Conversion Facility (CNCF) Configuration

## Allowed ISUP Message Type Screen Configuration

Introduction.....	15-2
Adding an Allowed ISUP Message Type Screen .....	15-9
Removing an Allowed ISUP Message Type Screen.....	15-16
Changing an Allowed ISUP Message Type Screen.....	15-20

## Introduction

The ISUP Message Type screen identifies which ISUP messages, using the ISUP message type, that are allowed into the EAGLE 5 SAS. The gray shaded areas in Figure 15-1 on page 15-8 shows the fields of the SS7 message that are checked by the ISUP Message Type screening function.

If no match is found, the MTP network management message is not allowed into the EAGLE 5 SAS. If a match is found, the message is allowed into the EAGLE 5 SAS for further processing.

If the **copy** gateway screening stop action is specified, the message is processed and a copy of the message is sent by the STP LAN feature to an external application through an ACM running the **stplan** application or a DCM running the **vxwslan** application.

If the **rdct** (redirect) gateway screening stop action is specified, the message is diverted from the original destination and sent to another destination with the Database Transport Access feature, specified by global title translation, for further processing.

If the Calling Name Conversion Facility (CNCF) feature is on and the **cncf** gateway screening stop action is specified, the PIP parameter in the incoming ISUP IAM message is converted to the GN parameter. The GN parameter in the incoming ISUP IAM message is converted to the PIP parameter. The message is then sent to the node specified by the DPC in the routing label in the message. For more information on the Calling Name Conversion Facility feature, see Chapter 14, "Calling Name Conversion Facility (CNCF) Configuration."

If the Triggerless LNP (TLNP) feature is on and the **tlnp** gateway screening stop action is specified, ISUP IAMs that pass gateway screening are processed either by the ISUP NP with EPAP feature (if the ISUP NP with EPAP feature is enabled and turned on) or by the Triggerless LNP feature (if the Triggerless LNP feature is turned on). The ISUP NP with EPAP feature is discussed in more detail in the *Feature Manual - G-Port*. The Triggerless LNP feature is discussed in more detail in the *LNP Feature Activation Guide*.

### TUP Message Screening

TUP messages are screened using the Allowed ISUP Message Type screen. The TUP protocol is an obsolete predecessor to the ISUP protocol that remains in use in some areas. To screen for TUP messages, a screen set must be defined to screen for messages containing the service indicator value of 4. This is accomplished by defining an allowed SIO screen in the screen set containing the **si=4** parameter.

## Allowed ISUP Message Type Screen Configuration

Since both ISUP and TUP messages are screened using the allowed ISUP message type screen, it is recommended that the screen set contain an allowed SIO screen to screen for ISUP messages, messages containing the service indicator value of 5. Each of these entries in the allowed SIO screen should have separate next screening functions. This allows the screening rules after the allowed SIO screen to have two separate streams, one that ends with screening ISUP messages, the other that ends with screening TUP messages.

The TUP messages can be screened for point codes before, with the allowed and blocked OPC screens, and after the SIO screen, with the allowed and blocked DPC screens. However, if the screen set does not contain an allowed SIO screen that screens for TUP messages (messages with the service indicator value of 4), the message will be treated by the allowed ISUP message type screen as an ISUP message.

The following commands show how a screen set can be provisioned to screen for TUP and ISUP messages.

```
ent-scr-isup:sr=is01:isupmt=10:nsfi=stop
ent-scr-isup:sr=tu01:tupmt=1:nsfi=stop
ent-scr-dpc:sr=dpc4:ni=1:nc=2:ncm=3:nsfi=isup:nsr=tu01
ent-scr-dpc:sr=dpc5:ni=7:nc=1:ncm=0:nsfi=isup:nsr=is01
ent-scr-sio:sr=si02:nic=2:pri=0:si=4:nsfi=dpc:nsr=dpc4
ent-scr-sio:sr=si02:nic=2:pri=0:si=5:nsfi=dpc:nsr=dpc5
ent-scrset:scrn=ist2:nsr=si02:nsfi=sio
```

In this example screen set configuration, messages are screened by the allowed SIO screen **si02** for either ISUP or TUP messages. ISUP messages are further screened by the allowed DPC screen **dpc5** and TUP messages are screened by the allowed DPC screen **dpc4**. The ISUP messages containing the ANSI point code 001-002-003 are passed onto the allowed ISUP screen **is01**. The TUP messages containing the ANSI point code 007-001-000 are passed onto the allowed ISUP screen **tu01**.

**NOTE: The gateway screening rules are entered in reverse of the order that the screening process takes place.**

Flowchart 15-1 shows the screening action of the allowed ISUP message type screen.

Flowchart 15-1. Allowed ISUP Message Type Screening  
Action (Sheet 1 of 4)

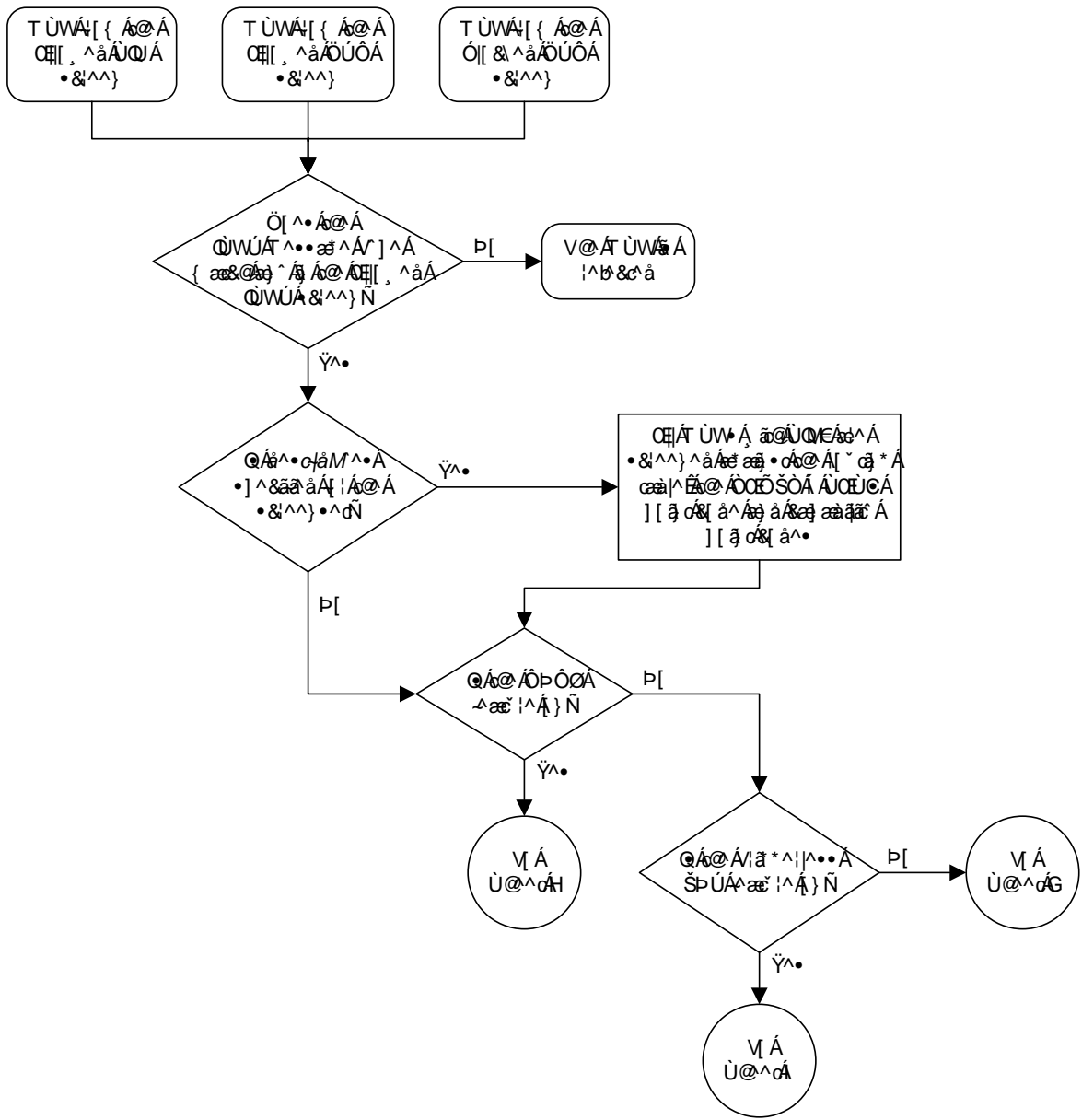



Allowed ISUP Message Type Screen Configuration

Flowchart 15-1. Allowed ISUP Message Type Screening Action (Sheet 2 of 4)

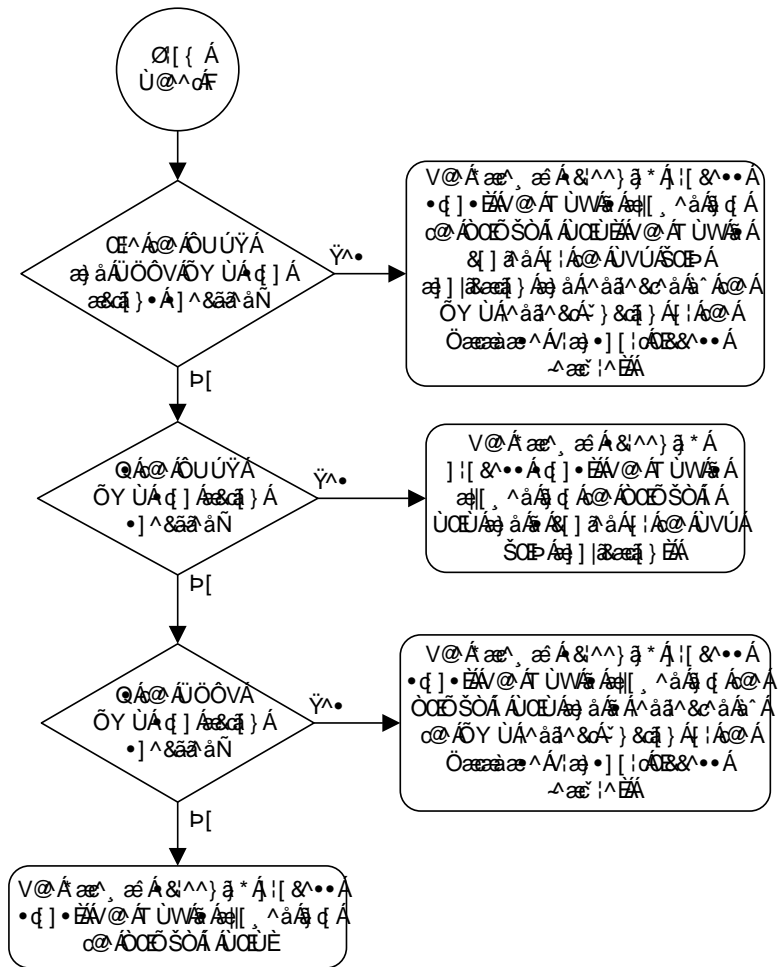

Flowchart 15-1. Allowed ISUP Message Type Screening  
Action (Sheet 3 of 4)

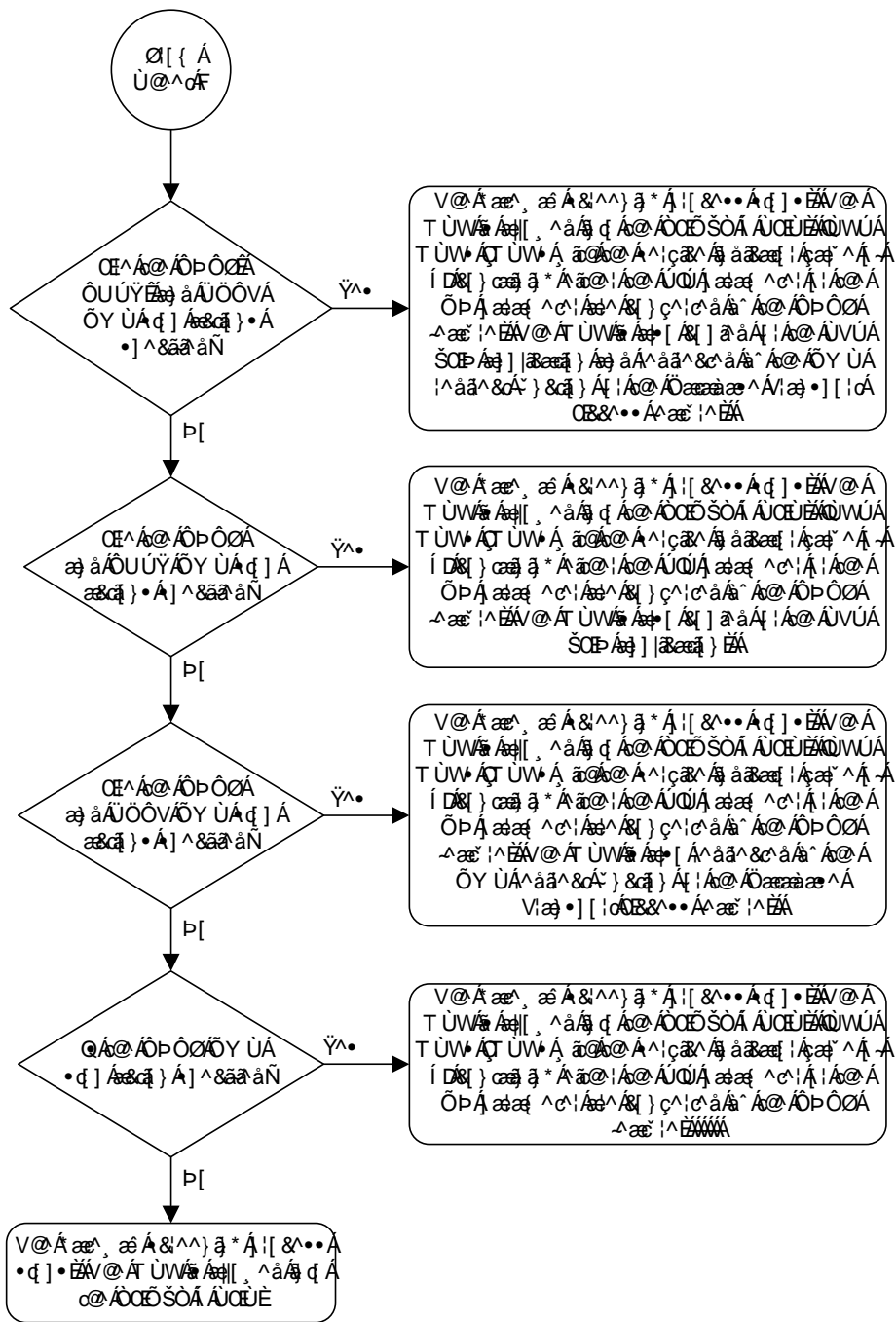

Allowed ISUP Message Type Screen Configuration

Flowchart 15-1. Allowed ISUP Message Type Screening  
Action (Sheet 4 of 4)

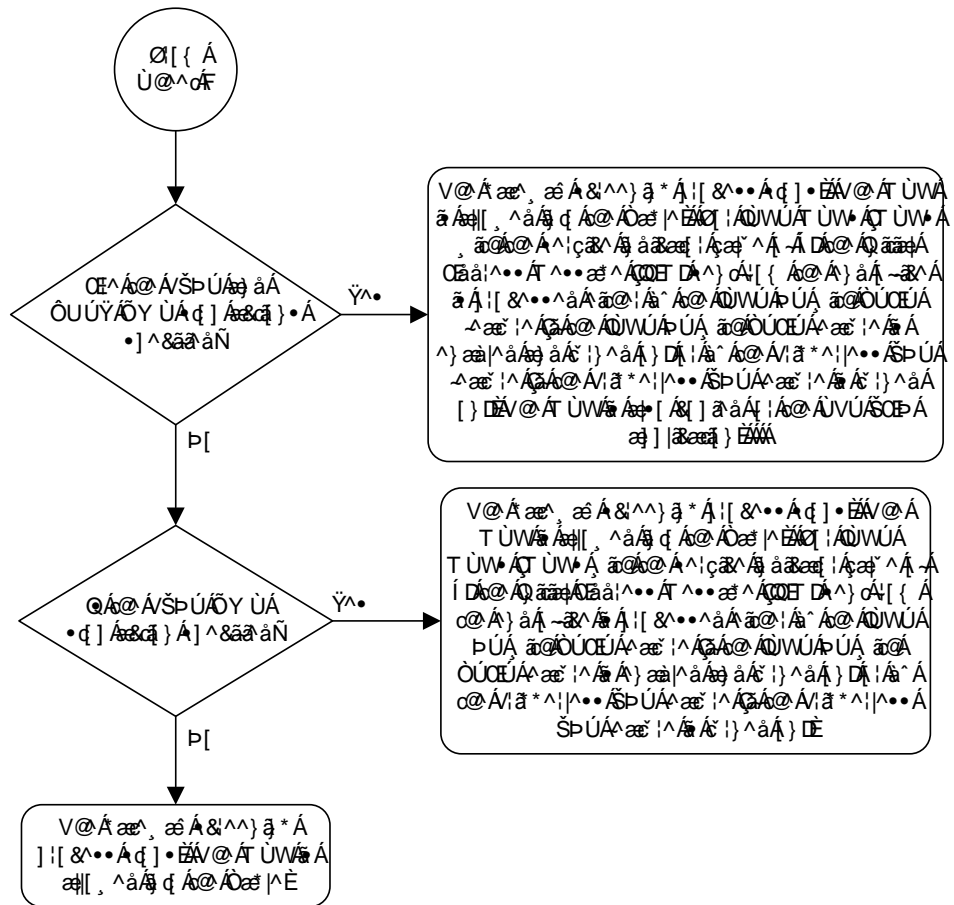

Figure 15-1. Allowed ISUP Message Type Screening Function

ANSI MSU (ANSI Message Signal Unit)

BSN FSN LI	SIO xx xx xxxx NIC PRI SI	SIF					
		Routing Label DPC OPC NCM NC NI NCM NC NI		SLS xx	CIC Code	ISUP Message Type	ISUP Data

ITU-I MSU (ITU International Message Signal Unit)

BSN FSN LI	SIO xx xx xxxx NIC PRI SI	SIF					
		Routing Label DPC OPC ID AREA ZONE ID AREA ZONE		SLS xx	CIC Code	ISUP Message Type	ISUP Data

14-Bit ITU-N MSU (14-Bit ITU National Message Signal Unit)

BSN FSN LI	SIO xx xx xxxx NIC PRI SI	SIF					
		Routing Label DPC OPC NPC NPC		SLS xx	CIC Code	ISUP Message Type	ISUP Data

24-Bit ITU-N MSU (24-Bit ITU National Message Signal Unit)

BSN FSN LI	SIO xx xx xxxx NIC PRI SI	SIF					
		Routing Label DPC OPC SP SSA MSA SP SSA MSA		SLS xx	CIC Code	ISUP Message Type	ISUP Data

## Adding an Allowed ISUP Message Type Screen

This procedure is used to add an allowed ISUP message type (ISUP) screen to the database using the `ent-scr-isup` command. The parameters used by the `ent-scr-isup` command are shown in the “Gateway Screening Attributes” section on page 2-7. The general rules that apply to configuring gateway screening entities are shown in the “Gateway Screening Configuration” section on page 2-28.

Since both ISUP and TUP messages are screened by the allowed ISUP message type screen, the `ent-scr-isup` command contains a parameter for the ISUP message type (`isupmt`) and a parameter for the TUP message type (`tupmt`). Only one of these parameters can be specified for the allowed ISUP screen being entered into the database. The `isupmt` parameter should be specified in screen sets that contain allowed SIO screens that are screening messages for the service indicator value of 5 (SI=5). The `tupmt` parameter should be specified in screen sets that contain allowed SIO screens that are screening messages for the service indicator value of 4 (SI=4). If you wish to screen for TUP messages, make sure that the screen set being configured contains an allowed SIO screen that screens messages for the service indicator value of 4 (SI=4). If you do not do this, the EAGLE 5 SAS will treat the message as an ISUP message, even if the message contains the service indicator value of 4.

The examples in this procedure are used to add the allowed ISUP screen data shown in Table 15-1 and based on the example configuration shown in Figure 2-8 on page 2-43 and Figure 2-9 on page 2-45.

**Table 15-1.** Example Gateway Screening Allowed ISUP Configuration Table

Screening Reference	ISUPMT	NSFI	ACTNAME
isp1	135	stop	CR
isp2	139	stop	CR
Screening Reference	TUPMT	NSFI	ACTNAME
tup1	100	stop	CR

**Procedure**

---

1. Verify that the gateway screening feature is on, by entering the `rtrv-feat` command. If the gateway screening feature is on, the `GWS` field is set to `on`.

**NOTE:** The `rtrv-feat` command output contains other fields that are not used by this procedure. If you wish to see all the fields displayed by the `rtrv-feat` command, see the `rtrv-feat` command description in the *Commands Manual*.

If the gateway screening feature is on, shown by the entry `GWS = on` in the `rtrv-feat` command output, skip step 2, and go to step 3.

---

2. Turn the gateway screening feature on by entering this command.

```
chg-feat:gws=on
```

**NOTE:** Once the gateway screening feature is turned on with the `chg-feat` command, it cannot be turned off.

The gateway screening feature must be purchased before you turn this feature on with the `chg-feat` command. If you are not sure if you have purchased the gateway screening feature, contact your Tekelec Sales Representative or Account Representative.

When the `chg-feat` has successfully completed, this message should appear.

```
rlghncxa03w 05-09-28 11:43:04 GMT EAGLE5 34.0.0
CHG-FEAT: MASP A - COMPLTD
```

---

3. Display all allowed ISUP screens in the database using the `rtrv-scr-isup` command. The following is an example of the possible output.

```
rlghncxa03w 05-09-25 15:25:30 GMT EAGLE5 34.0.0
SCREEN = ALLOWED ISUP
SR   REF  RULES
IEC  YES   2
WRD2 YES   1
WRD4 YES   1
```

If the screening reference names that you wish to add with this procedure are not shown in the `rtrv-scr-isup` command output, go to step 4. For this example, the screening reference names are not shown. If these screening reference names are shown in the `rtrv-scr-isup` command output, make sure the screening data you wish to enter is not already in the database by entering the `rtrv-scr-isup` command with the screening reference name. For example, enter the `rtrv-scr-isup:sr=iec` command. The following is an example of the possible output.

```
rlghncxa03w 05-09-25 15:26:30 GMT EAGLE5 34.0.0
SCREEN = ALLOWED ISUP
SR   ISUPMT/  NSFI   NSR/ACT
      TUPMT
iec  100      STOP   cr
iec  197      STOP   cr
```

## Allowed ISUP Message Type Screen Configuration

If a gateway screening stop action set is to be assigned to the allowed ISUP screen being added to the database, go to step 4. Otherwise, go to step 5.

---

4. Display the gateway screening stop action sets in the database with the **rtrv-gws-actset** command. This is an example of the possible output.

```
rlghncxa03w 05-09-25 15:28:30 GMT EAGLE5 34.0.0
ACT ACT ACT ACT ACT ACT ACT ACT ACT ACT ACT ACT
ID NAME 1 2 3 4 5 6 7 8 9 10
--
1 copy copy
2 rdct rdct
3 cr copy rdct
4 cncf cncf
5 cpcnfc copy cnfc
6 cncfrc cnfc rdct
7 cpcfrd copy cnfc rdct
```

GWS action set table is (7 of 16) 44% full

If the required gateway screening stop action set is not in the database, go to the "Configuring Gateway Screening Stop Action Sets" procedure on page 2-54 and configure the required gateway screening stop action set.

---

5. Add a new allowed ISUP screen to the database using the **ent-scr-isup** command. For this example, enter this command.

```
ent-scr-isup:sr=isp1:isupmt=135:nsfi=stop:actname=cr
```

A message similar to the following should appear.

```
rlghncxa03w 05-09-25 15:29:30 GMT EAGLE5 34.0.0
ENT-SCR-ISUP: SCREEN SET AFFECTED - ISP1 1% FULL
ENT-SCR-ISUP: MASP A - COMPLTD
```

```
ent-scr-isup:sr=isp2:isupmt=139:nsfi=stop:actname=cr
```

A message similar to the following should appear.

```
rlghncxa03w 05-09-25 15:29:30 GMT EAGLE5 34.0.0
ENT-SCR-ISUP: SCREEN SET AFFECTED - ISP2 1% FULL
ENT-SCR-ISUP: MASP A - COMPLTD
```

```
ent-scr-isup:sr=tup1:tupmt=100:nsfi=stop:actname=cr
```

A message similar to the following should appear.

```
rlghncxa03w 05-09-25 15:29:30 GMT EAGLE5 34.0.0
ENT-SCR-ISUP: SCREEN SET AFFECTED - TUP1 1% FULL
ENT-SCR-ISUP: MASP A - COMPLTD
```

If a gateway screening stop action is to be assigned to the allowed ISUP screen being changed, enter the **ent-scr-isup** command with the **nsfi=stop** parameter and the **actname** parameter with the name of a gateway screening stop action set shown in the output of the **rtrv-gws-actset** command executed in step 4.

The **isupmt** or **tupmt** parameters can have these values: 0 - 255, or an asterisk (\*).

A range of ISUP or TUP message types can be specified with the **ent-scr-isup** command. If a range of ISUP message types is specified, the range of ISUP message types cannot include any ISUP message types that are currently provisioned for the screening reference name. If a range of TUP message types is specified, the range of TUP message types cannot include any TUP message types that are currently provisioned for the screening reference name.

For example, screening reference name **scr1** contains these entries:

```
SR   ISUPMT/   NSFI   NSR/ACT
      TUPMT
scr1 115       STOP   cr
scr1 203       STOP   cr
```

Another entry for screening reference **scr1** cannot be specified if the range of ISUP message types includes the values 115 and 203.

- Verify the changes using the **rtrv-scr-isup** command with the screening reference name used in step 5. For this example, enter this command.

**rtrv-scr-isup:sr=isp1**

The following is an example of the possible output.

```
rlghncxa03w 05-09-25 15:30:30 GMT EAGLE5 34.0.0
SCREEN = ALLOWED ISUP
SR   ISUPMT/   NSFI   NSR/ACT
      TUPMT
isp1 135       STOP   cr
```

**rtrv-scr-isup:sr=isp2**

The following is an example of the possible output.

```
rlghncxa03w 05-09-25 15:30:30 GMT EAGLE5 34.0.0
SCREEN = ALLOWED ISUP
SR   ISUPMT/   NSFI   NSR/ACT
      TUPMT
isp2 139       STOP   cr
```

**rtrv-scr-isup:sr=tup1**

The following is an example of the possible output.

```
rlghncxa03w 05-09-25 15:30:30 GMT EAGLE5 34.0.0
SCREEN = ALLOWED ISUP
SR   ISUPMT/   NSFI   NSR/ACT
      TUPMT
tup1 100       STOP   cr
```

- Backup the new changes using the **chg-db:action=backup:dest=fixed** command. The following messages should appear, the active Maintenance and Administration Subsystem Processor (MASP) appears first.

```
BACKUP (FIXED) : MASP A - Backup starts on active MASP.
BACKUP (FIXED) : MASP A - Backup on active MASP to fixed disk complete.
BACKUP (FIXED) : MASP A - Backup starts on standby MASP.
BACKUP (FIXED) : MASP A - Backup on standby MASP to fixed disk complete.
```



# Allowed ISUP Message Type Screen Configuration

Flowchart 15-2. Adding an Allowed ISUP Message Type Screen (Sheet 1 of 3)

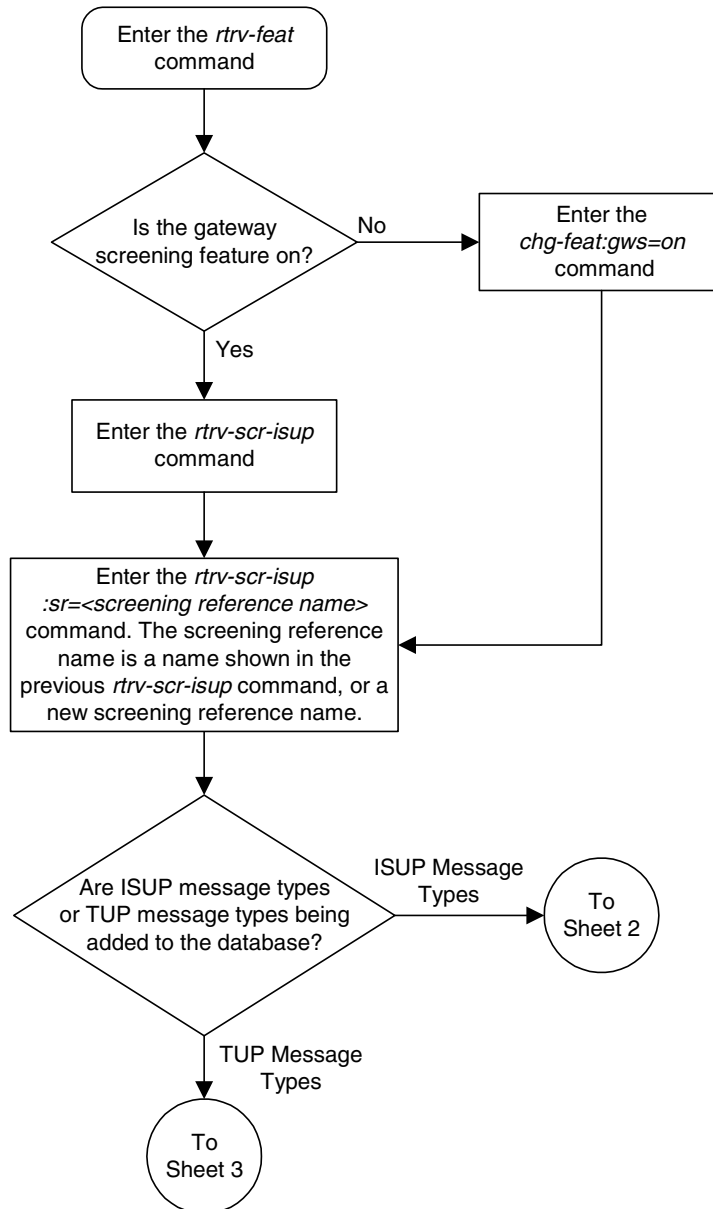

Flowchart 15-2. Adding an Allowed ISUP Message Type Screen (Sheet 2 of 3)

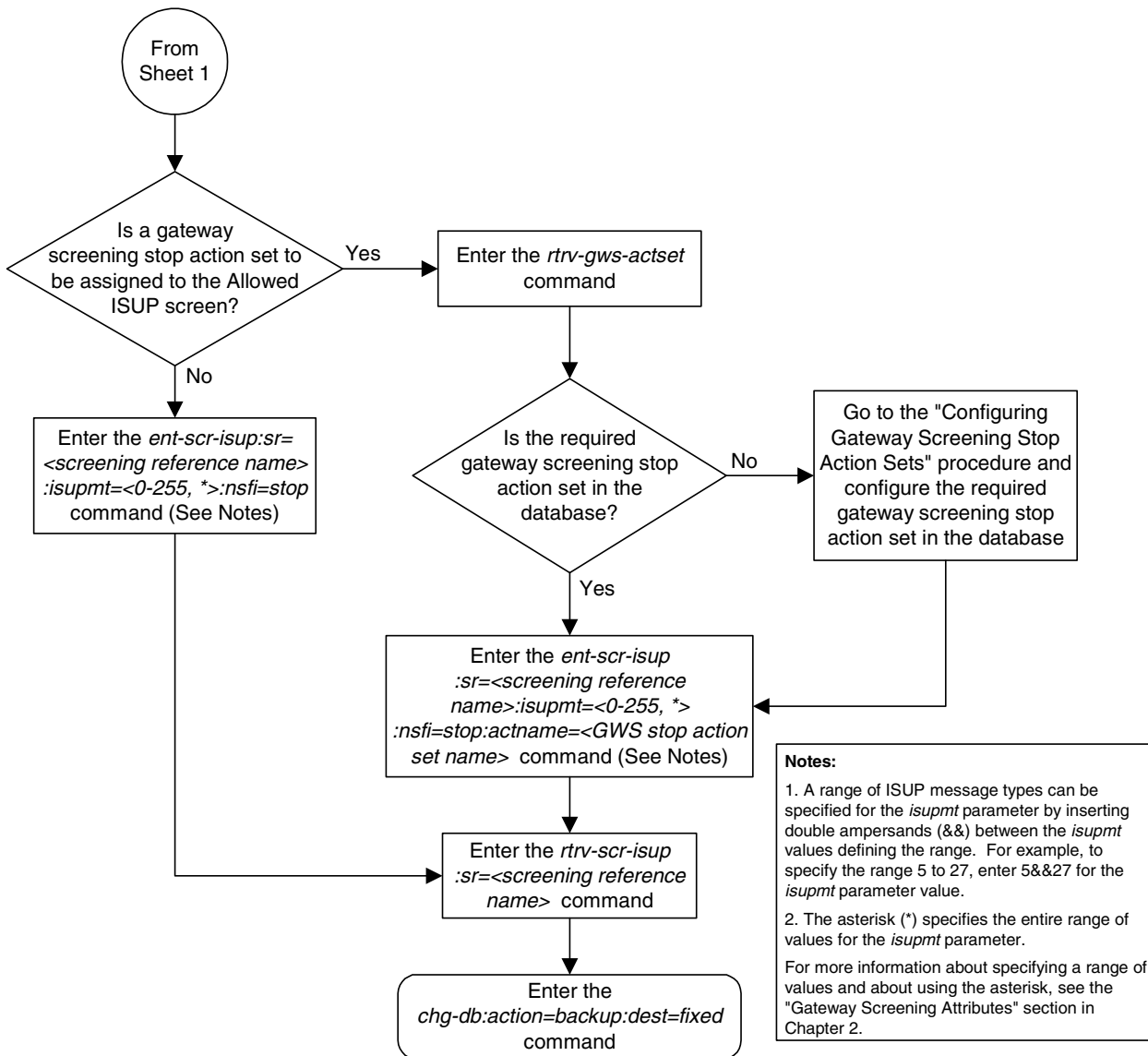

# Allowed ISUP Message Type Screen Configuration

Flowchart 15-2. Adding an Allowed ISUP Message Type Screen (Sheet 3 of 3)

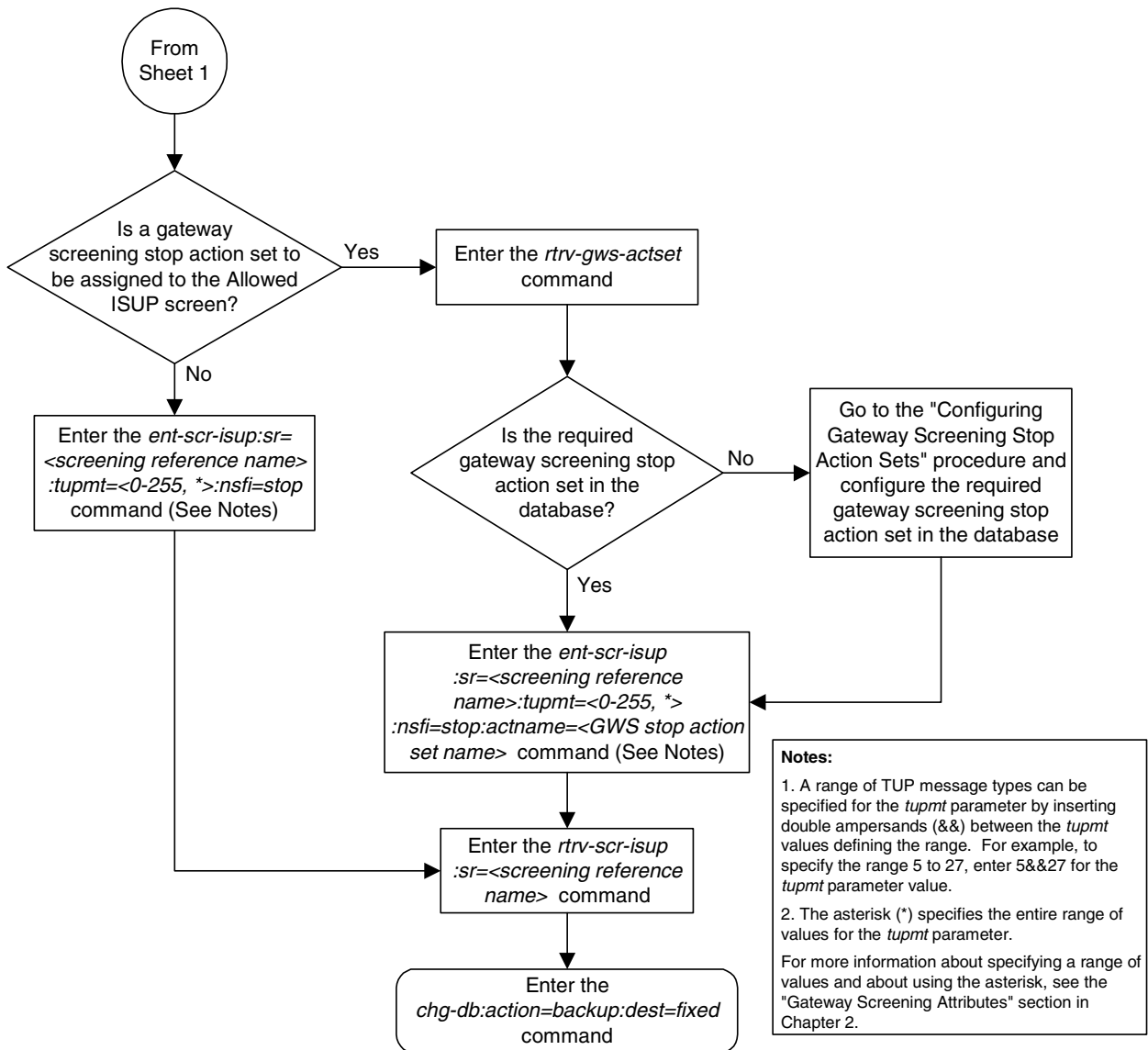

## Removing an Allowed ISUP Message Type Screen

This procedure is used to remove an allowed ISUP message type (ISUP) screen from the database using the `dlt-scr-isup` command. The parameters used by the `dlt-scr-isup` command are shown in the “Gateway Screening Attributes” section on page 2-7. The general rules that apply to configuring gateway screening entities are shown in the “Gateway Screening Configuration” section on page 2-28.

Since both ISUP and TUP messages are screened by the allowed ISUP message type screen, the `dlt-scr-isup` command contains a parameter for the ISUP message type (`isupmt`) and a parameter for the TUP message type (`tupmt`). Only one of these parameters can be specified for the allowed ISUP screen being removed from the database.

The example in this procedure removes the allowed ISUP screen `isp2` from the database.

The allowed ISUP screen can be referenced by one of the following screens.

- Allowed SIO
- Allowed DPC
- Blocked DPC

Enter the following commands to verify that none of these screens reference the allowed CGPA screen being removed from the database.

- `rtrv-scr-sio:nsfi=isup`
- `rtrv-scr-dpc:nsfi=isup`
- `rtrv-scr-blkdpc:nsfi=isup`

To change the NSFI of any of these screens, go to one of the following procedures.

- “Changing an Allowed SIO Screen” procedure on page 10-23
- “Changing an Allowed DPC Screen” procedure on page 9-26
- “Changing a Blocked DPC Screen” procedure on page 8-26

### Procedure

---

1. Display the allowed ISUP screens in the database using the **rtrv-scr-isup** command. The following is an example of the possible output.

```
rlghncxa03w 05-09-25 15:25:30 GMT EAGLE5 34.0.0
SCREEN = ALLOWED ISUP
SR      REF  RULES
IEC     YES   2
ISP1    YES   1
ISP2    YES   2
TUP1    YES   1
WRD2    YES   1
WRD4    YES   1
```

From the **rtrv-scr-isup** output, display the allowed ISUP screen you wish to remove using the **rtrv-scr-isup** command with the screening reference name. For this example, enter this command.

```
rtrv-scr-isup:sr=isp2
```

The following is an example of the possible output.

```
rlghncxa03w 05-09-25 15:30:30 GMT EAGLE5 34.0.0
SCREEN = ALLOWED ISUP
SR  ISUPMT/  NSFI  NSR/ACT
    TUPMT
isp2 055      STOP  cr
```

---

2. Enter the commands on page 15-16 to verify that the screen being removed is not referenced by other screens in the database. If the screen being removed is referenced by other screens, go to the procedures shown on page 15-16 and change the NSFI of those screens to reference other screens or change the NSFI of these screens to STOP.
- 

3. Remove the allowed ISUP screen from the database using the **dlt-scr-isup** command. The current value of the **isupmt** parameter must be entered exactly as shown in the **rtrv-scr-isup** output in step 1. For this example, enter this command.

```
dlt-scr-isup:sr=isp2:isupmt=055
```

A message similar to the following should appear.

```
rlghncxa03w 05-09-25 15:26:30 GMT EAGLE5 34.0.0
DLT-SCR-ISUP: SCREEN SET AFFECTED - FLD5 0% FULL
DLT-SCR-ISUP: MASP A - COMPLTD
```

---

4. Verify the changes using the **rtrv-scr-isup** command with the screening reference name used in step 3. For this example, enter this command.

```
rtrv-scr-isup:sr=isp2
```

The following is an example of the possible output.

```
E2573 Cmd Rej: SR or NSR does not reference an existing SR
```

This message shows that the specified screening reference name is not in the database and the action of the **dlt-scr-isup** command in step 3 was successful. If the specified screening reference name contained more than one entry when the **dlt-scr-isup** command was executed in step 3, the **rtrv-scr-isup:sr=** command output would show the remaining entries in the screening reference instead of error message E2573.

- 
5. Backup the new changes using the **chg-db:action=backup:dest=fixed** command. The following messages should appear, the active Maintenance and Administration Subsystem Processor (MASP) appears first.

```
BACKUP (FIXED) : MASP A - Backup starts on active MASP.  
BACKUP (FIXED) : MASP A - Backup on active MASP to fixed disk complete.  
BACKUP (FIXED) : MASP A - Backup starts on standby MASP.  
BACKUP (FIXED) : MASP A - Backup on standby MASP to fixed disk complete.
```

---

## Allowed ISUP Message Type Screen Configuration

Flowchart 15-3. Removing an Allowed ISUP Message Type Screen

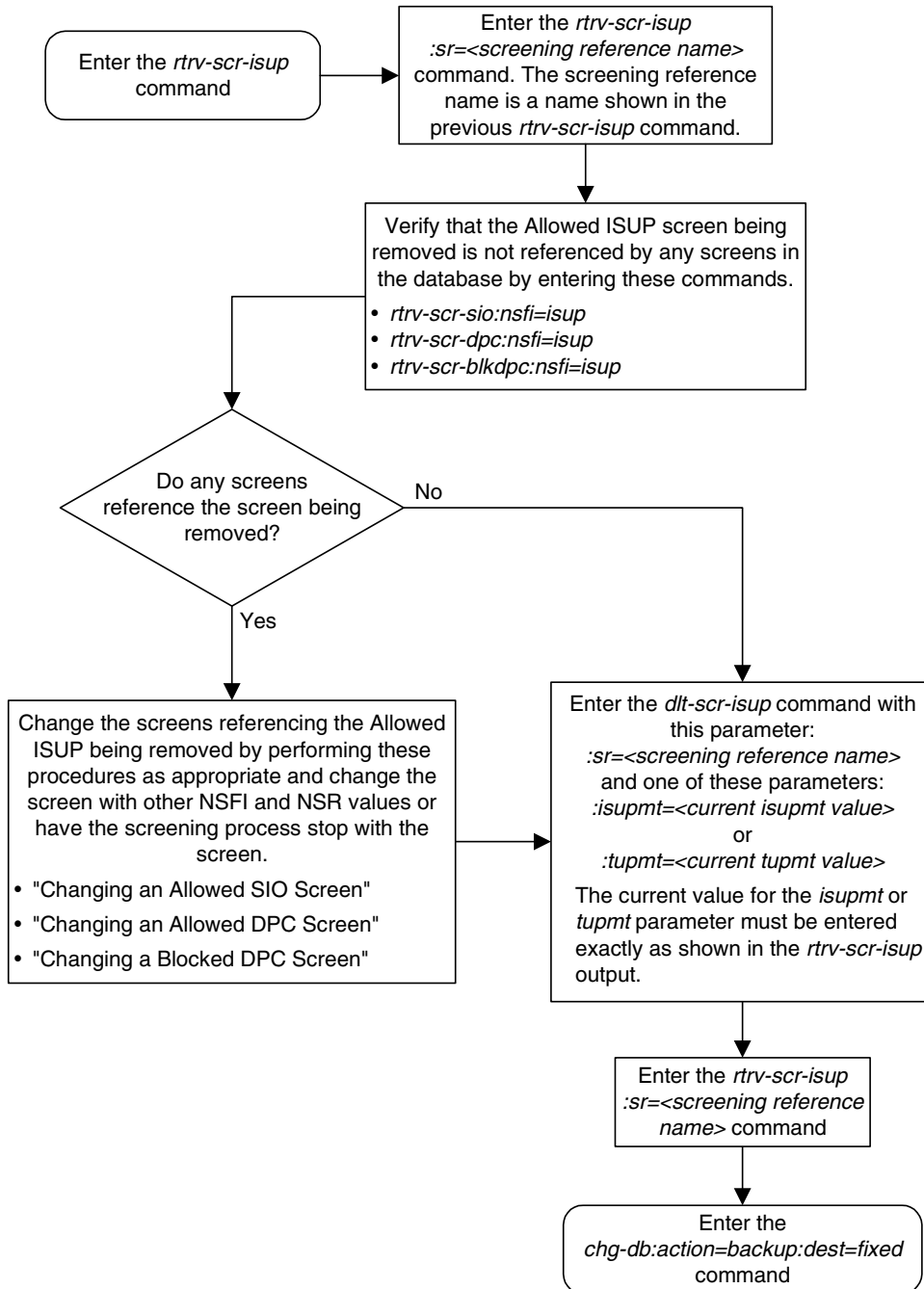

## Changing an Allowed ISUP Message Type Screen

This procedure is used to change the attributes of an allowed ISUP message type (ISUP) screen in the database using the **chg-scr-isup** command. The parameters used by the **chg-scr-isup** command are shown in the “Gateway Screening Attributes” section on page 2-7. The general rules that apply to configuring gateway screening entities are shown in the “Gateway Screening Configuration” section on page 2-28.

The example in this procedure is used to change the ISUP message type 135 for the allowed ISUP screen **isp1** to 075 and to redirect the MSU for the DTA feature.

### Procedure

---

1. Display the allowed ISUP screens in the database using the **rtrv-scr-isup** command. The following is an example of the possible output.

```
rlghncxa03w 05-09-25 15:25:30 GMT EAGLE5 34.0.0
SCREEN = ALLOWED ISUP
SR      REF  RULES
IEC    YES   2
ISP1   YES   3
ISP2   YES   2
TUP1   YES   1
WRD2   YES   1
WRD4   YES   1
```

From the **rtrv-scr-isup** output, display the allowed ISUP screen you wish to remove using the **rtrv-scr-isup** command with the screening reference name. For this example, enter this command.

```
rtrv-scr-isup:sr=isp1
```

The following is an example of the possible output.

```
rlghncxa03w 05-09-25 15:30:30 GMT EAGLE5 34.0.0
SCREEN = ALLOWED ISUP
SR  ISUPMT/  NSFI  NSR/ACT
    TUPMT
isp1 002      STOP  copy
isp1 089      STOP  -----
isp1 135      STOP  cr
```

If a gateway screening stop action set is to be assigned to the allowed ISUP screen being changed in the database, go to step 2.

Step 2 verifies the gateway screening stop action set names in the database. If a gateway screening stop action set name will not be assigned to the screen, skip step 2 and go to step 3.

---



## Allowed ISUP Message Type Screen Configuration

2. Display the gateway screening stop action sets in the database with the **rtrv-gws-actset** command. This is an example of the possible output.

```
rlghncxa03w 05-09-25 15:26:30 GMT EAGLE5 34.0.0
ACT ACT ACT ACT ACT ACT ACT ACT ACT ACT ACT ACT
ID NAME 1 2 3 4 5 6 7 8 9 10
-----
1 copy copy
2 rdct rdct
3 cr copy rdct
4 cncf cncf
5 cpncf copy cncf
6 cncfrd cncf rdct
7 pcfrd copy cncf rdct
```

GWS action set table is (7 of 16) 44% full

If the required gateway screening stop action set is not in the database, go to the "Configuring Gateway Screening Stop Action Sets" procedure on page 2-54 and configure the required gateway screening stop action set.

- 
3. Change the attributes of an allowed ISUP screen using the **chg-scr-isup** command.

If a gateway screening stop action is to be assigned to the allowed ISUP screen being changed, enter the **chg-scr-isup** command with the **nsfi=stop** parameter and the **actname** parameter with the name of a gateway screening stop action set shown in the output of the **rtrv-gws-actset** command executed in step 2.

The value of the **isupmt** or **tupmt** parameter must be entered exactly as shown in the **rtrv-scr-isup** output in step 1.

The **nisupmt** or **ntupmt** parameter can have these values: 0 - 255, or an asterisk (\*).

A range of ISUP or TUP message types can be specified with the **chg-scr-isup** command. If a range of ISUP message types is specified, the range of ISUP message types cannot include any ISUP message types that are currently provisioned for the screening reference name. If a range of TUP message types is specified, the range of TUP message types cannot include any TUP message types that are currently provisioned for the screening reference name.

For example, screening reference name **scr1** contains these entries:

```
SR ISUPMT/ NSFI NSR/ACT
TUPMT
scr1 115 STOP cr
scr1 203 STOP cr
```

Another entry for screening reference **scr1** cannot be specified if the range of ISUP message types includes the values 115 and 203.

## Allowed ISUP Message Type Screen Configuration

For this example, enter this command.

```
chg-scr-isup:sr=isp1:isupmt=135:nisupmt=075:actname=rdct
```

The following messages appear.

```
rlghncxa03w 05-09-25 15:27:30 GMT EAGLE5 34.0.0  
CHG-SCR-ISUP: SCREEN SET AFFECTED - ISP1 1% FULL  
CHG-SCR-ISUP: MASP A - COMPLTD
```

---

4. Verify the changes using the **rtrv-scr-isup** command with screening reference name used in step 3. For this example, enter this command.

```
rtrv-scr-isup:sr=isp1
```

The following is an example of the possible output.

```
rlghncxa03w 05-09-25 15:30:30 GMT EAGLE5 34.0.0  
SCREEN = ALLOWED ISUP  
SR   ISUPMT/   NSFI   NSR/ACT  
      TUPMT  
isp1 002       STOP   copy  
isp1 075       STOP   rdct  
isp1 089       STOP   -----
```

---

5. Backup the new changes using the **chg-db:action=backup:dest=fixed** command. The following messages should appear, the active Maintenance and Administration Subsystem Processor (MASP) appears first.

```
BACKUP (FIXED) : MASP A - Backup starts on active MASP.  
BACKUP (FIXED) : MASP A - Backup on active MASP to fixed disk complete.  
BACKUP (FIXED) : MASP A - Backup starts on standby MASP.  
BACKUP (FIXED) : MASP A - Backup on standby MASP to fixed disk complete.
```

---

## Allowed ISUP Message Type Screen Configuration

**Flowchart 15-4.** Changing an Allowed ISUP Message Type Screen (Sheet 1 of 2)

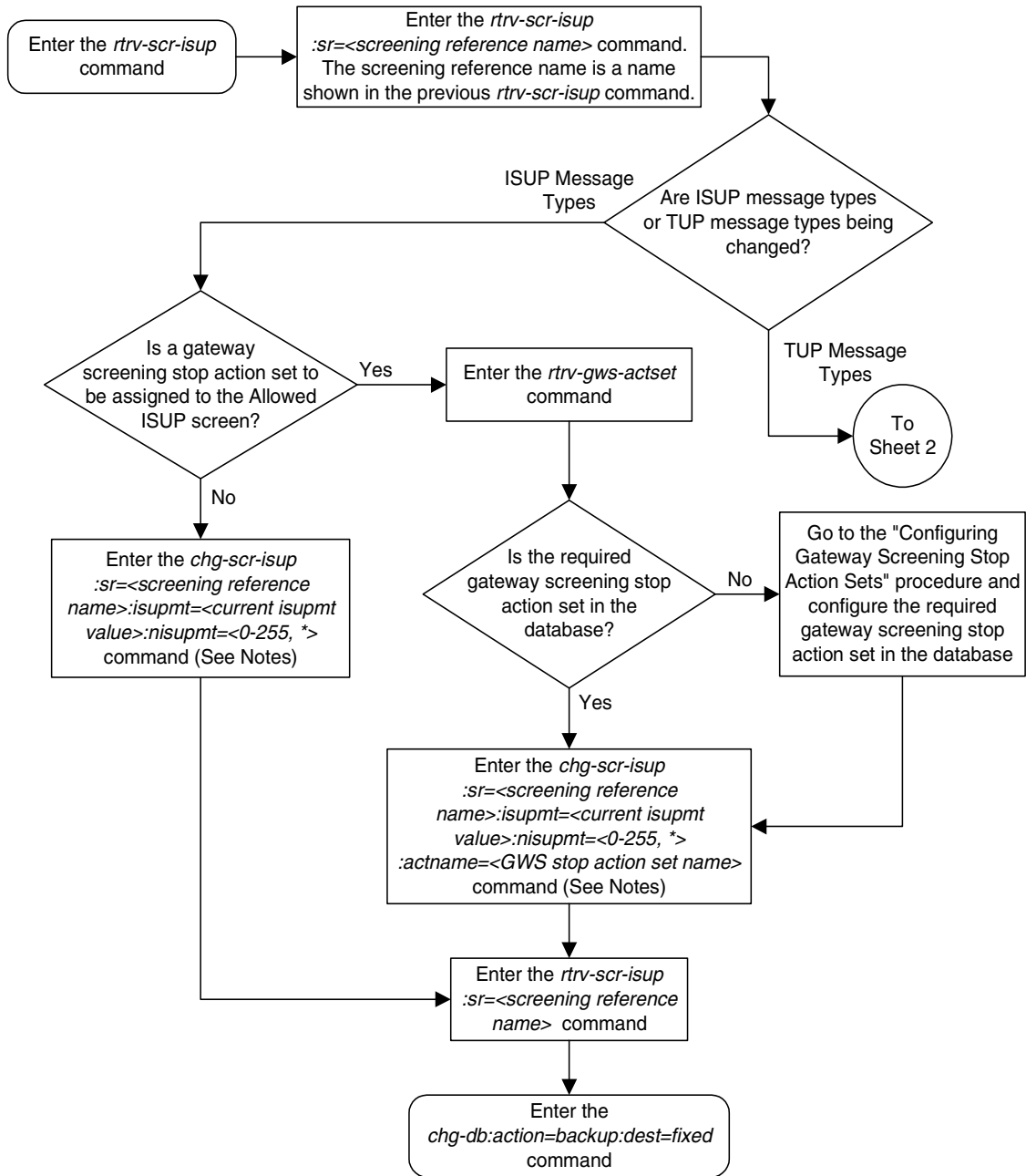

**Notes:**

1. A range of ISUP message types can be specified for the *nisupmt* parameter by inserting double ampersands (&&) between the *isupmt* values defining the range. For example, to specify the range 5 to 27, enter 5&&27 for the *nisupmt* parameter value.
2. The current *isupmt* value must be specified exactly as it is shown in the *rtv-scr-isup* output.
3. The asterisk (\*) specifies the entire range of values for the *nisupmt* parameter.

For more information about specifying a range of values and about using the asterisk, see the "Gateway Screening Attributes" section in Chapter 2.

Flowchart 15-4. Changing an Allowed ISUP Message Type Screen (Sheet 2 of 3)

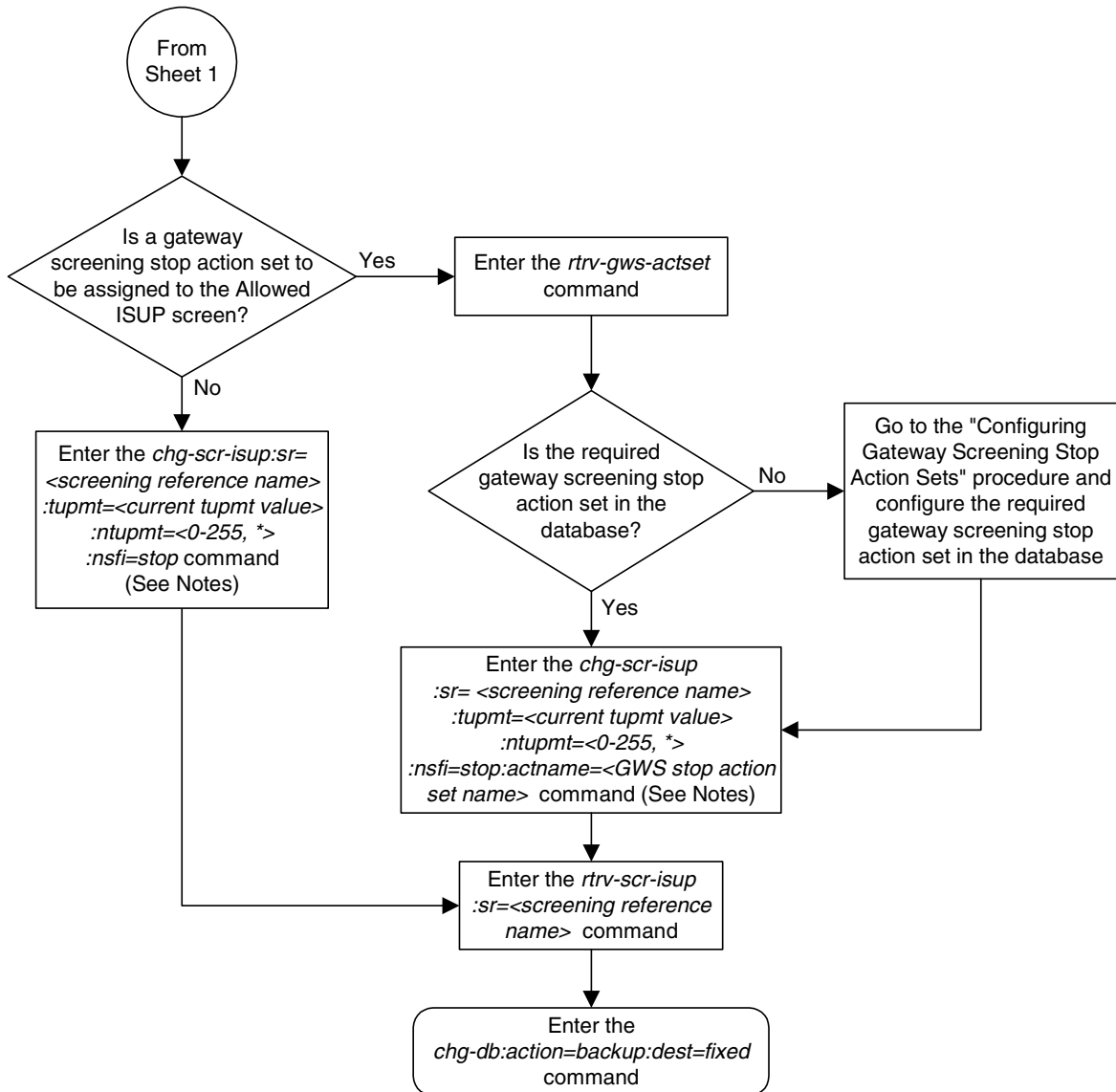

**Notes:**

1. A range of TUP message types can be specified for the *ntupmt* parameter by inserting double ampersands (&&) between the *tupmt* values defining the range. For example, to specify the range 5 to 27, enter 5&&27 for the *ntupmt* parameter value.
2. The current *tupmt* value must be specified exactly as it is shown in the *rtv-scr-isup* output.
3. The asterisk (\*) specifies the entire range of values for the *ntupmt* parameter.

For more information about specifying a range of values and about using the asterisk, see the "Gateway Screening Attributes" section in Chapter 2.

# Index

## Numerics

14-bit ITU national spare point code, 2-8,  
2-11, 2-23, 3-8, 3-10, 3-15, 3-20, 3-21, 4-9,  
4-11, 4-18, 4-25, 4-27, 6-10, 6-12, 6-19, 6-26,  
6-27, 6-28, 6-29, 7-10, 7-11, 7-12, 7-17, 7-24,  
7-25, 8-9, 8-13, 8-14, 8-22, 8-23, 8-27, 8-30,  
8-31, 9-13, 9-14, 9-23, 9-30, 9-31, 9-32,  
11-9, 11-13, 11-14, 11-15, 11-23, 11-27,  
11-30, 11-31, 11-32, 12-13, 12-14, 12-23,  
12-29, 12-30, 12-31

## A

Adding a Blocked DPC Screen, 8-8  
Adding a Blocked OPC Screen, 11-8  
Adding a GLS Card, 2-46  
Adding a Screen Set, 13-3  
Adding an Allowed Affected Point Code  
Screen, 3-4  
Adding an Allowed Called Party Address  
Screen, 4-5  
Adding an Allowed Calling Party Address  
Screen, 6-6  
Adding an Allowed DPC Screen, 9-8  
Adding an Allowed ISUP Message Type  
Screen, 15-9  
Adding an Allowed OPC Screen, 12-8  
Adding an Allowed SIO Screen, 10-9  
Adding an Allowed Translation Type  
Screen, 5-4  
Allowed Affected Destination Field, 2-2  
Allowed Affected Point Code, 2-2  
Allowed Called Party Address, 2-2  
Allowed Calling Party Address, 2-2  
Allowed Destination Point Code, 2-2  
Allowed ISUP Message Type, 2-2  
Allowed ISUP Message Type Screen  
Configuration, 15-1  
Allowed Originating Point Code, 2-2  
Allowed Signaling Information Octet, 2-2  
Allowed Translation Type, 2-2  
Automatic Destination Field  
Screening, 13-2

## B

Blocked Destination Point Code, 2-2  
Blocked Originating Point Code, 2-2

## C

Changing a Blocked DPC Screen, 8-26  
Changing a Blocked OPC Screen, 11-26  
Changing a Screen Set, 13-15  
Changing an Allowed Affected Point Code  
Screen, 3-17  
Changing an Allowed Called Party Address  
Screen, 4-22  
Changing an Allowed Calling Party Address  
Screen, 6-23  
Changing an Allowed DPC Screen, 9-26  
Changing an Allowed ISUP Message Type  
Screen, 15-20  
Changing an Allowed OPC Screen, 12-25  
Changing an Allowed SIO Screen, 10-23  
Changing an Allowed Translation Type  
Screen, 5-14  
Configuring for the CNCF Feature, 14-4  
Customer Care Center, 1-9

## E

Emergency response, 1-10  
Errors - contacting the Customer Care  
Center, 1-9

## G

Gateway Screening (GWS)  
Configuration, 2-1, 3-1, 4-1, 5-1, 6-1, 7-1,  
8-1, 9-1, 10-1, 11-1, 12-1, 13-1, 14-1, 15-1  
Gateway Screening States, 2-5

**I**

ITU international spare point code, 2-8, 2-11, 2-23, 3-8, 3-10, 3-15, 3-20, 3-21, 4-9, 4-11, 4-18, 4-25, 4-27, 6-10, 6-12, 6-19, 6-26, 6-27, 6-28, 6-29, 7-10, 7-11, 7-12, 7-17, 7-24, 7-25, 8-9, 8-13, 8-14, 8-22, 8-23, 8-27, 8-30, 8-31, 9-13, 9-14, 9-23, 9-30, 9-31, 9-32, 11-9, 11-13, 11-14, 11-15, 11-23, 11-27, 11-30, 11-31, 11-32, 12-13, 12-14, 12-23, 12-29, 12-30, 12-31

**M**

MTP Screening, 2-2

**N**

npcst parameter, 2-11, 3-21, 4-27, 6-28, 6-29, 7-25, 8-27, 8-31, 9-32, 11-27, 11-31, 11-32, 12-31

**P**

pcst parameter, 2-8, 2-11, 2-23, 3-10, 3-15, 3-21, 4-11, 4-18, 4-27, 6-12, 6-19, 6-28, 6-29, 7-12, 7-17, 7-25, 8-9, 8-13, 8-14, 8-22, 8-23, 8-27, 8-30, 8-31, 9-14, 9-23, 9-32, 11-9, 11-14, 11-15, 11-23, 11-27, 11-31, 11-32, 12-14, 12-23, 12-31

Problems - contacting the Customer Care Center, 1-9

**R**

Removing a Blocked DPC Screen, 8-21  
 Removing a Blocked OPC Screen, 11-22  
 Removing a GLS Card, 2-50  
 Removing a Screen Set, 13-12  
 Removing an Allowed Affected Point Code Screen, 3-14  
 Removing an Allowed Called Party Address, 4-17  
 Removing an Allowed Calling Party Address Screen, 6-18  
 Removing an Allowed DPC Screen, 9-22  
 Removing an Allowed ISUP Message Type Screen, 15-16  
 Removing an Allowed OPC Screen, 12-22

Removing an Allowed SIO Screen, 10-20  
 Removing an Allowed Translation Type Screen, 5-11

**S**

SCCP Screening, 2-2

Spare point code

14-bit ITU national, 2-8, 2-11, 2-23, 3-8, 3-10, 3-15, 3-20, 3-21, 4-9, 4-11, 4-18, 4-25, 4-27, 6-10, 6-12, 6-19, 6-26, 6-27, 6-28, 6-29, 7-10, 7-11, 7-12, 7-17, 7-24, 7-25, 8-9, 8-13, 8-14, 8-22, 8-23, 8-27, 8-30, 8-31, 9-13, 9-14, 9-23, 9-30, 9-31, 9-32, 11-9, 11-13, 11-14, 11-15, 11-23, 11-27, 11-30, 11-31, 11-32, 12-13, 12-14, 12-23, 12-29, 12-30, 12-31

ITU international, 2-8, 2-11, 2-23, 3-8, 3-10, 3-15, 3-20, 3-21, 4-9, 4-11, 4-18, 4-25, 4-27, 6-10, 6-12, 6-19, 6-26, 6-27, 6-28, 6-29, 7-10, 7-11, 7-12, 7-17, 7-24, 7-25, 8-9, 8-13, 8-14, 8-22, 8-23, 8-27, 8-30, 8-31, 9-13, 9-14, 9-23, 9-30, 9-31, 9-32, 11-9, 11-13, 11-14, 11-15, 11-23, 11-27, 11-30, 11-31, 11-32, 12-13, 12-14, 12-23, 12-29, 12-30, 12-31

Support - contacting the Customer Care Center, 1-9

**T**

Technical Assistance - contacting the Customer Care Center, 1-9